

SPECIALTY PRODUCTS

PRODUCT	PAGE
INDEX	A-1
MTO SPECIALTY PRODUCTS	A-2
IDLER SPROCKETS	
Bronze Bushed	A-3
Ball Bearing	A-4
Ball Bearing - Non-Metallic	A-4
Needle Bearing	A-3
Bronze Bearing	A-3
Chain Tightener	A-5
800 SERIES CONVEYOR SPROCKETS	
QRS® SPLITS	A-7
815	A-8, A-11
820	A-8, A-10
821	A-9
880	A-9
881	A-9
882	A-12
815 Guide Rings	A-12
Semi-Finished Weld-On Hubs	A-13
CUSTOM CAPABILITIES	A-14 – A-16
Forgings	A-14
Castings	A-14
Sintered Metal	A-15
Injection Molding	A-16

Made To Order Specialty Products

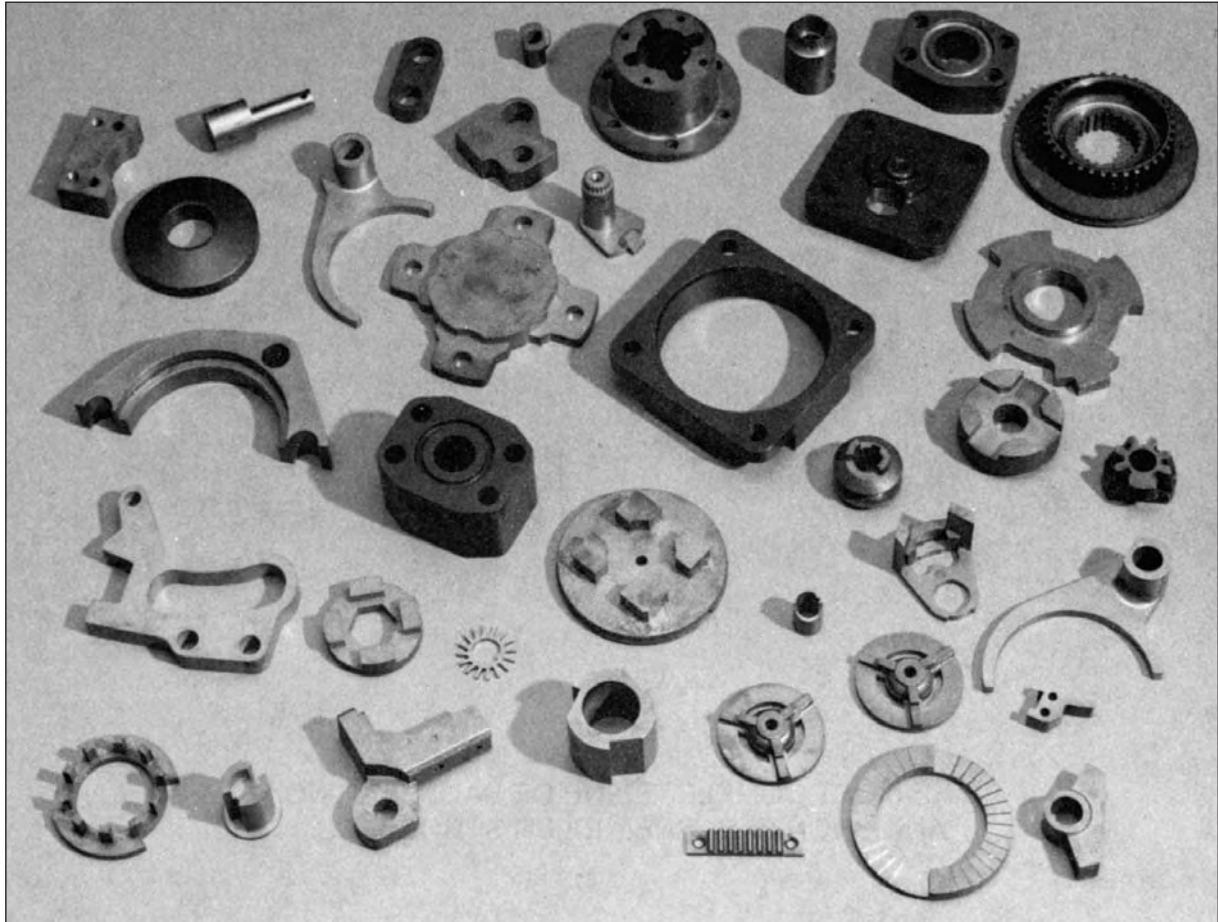

SPLIT S820 SPROCKET



**TAPER BUSHED
ADJUSTABLE HUB**



**SPECIAL BEARING
HOUSING**



Martin Semi-Steel 800 Series Conveyor Sprockets are Available for All your Flat Top Chain Needs.



The Most Complete Line of Idler Sprockets.

Bronze Bushed Type

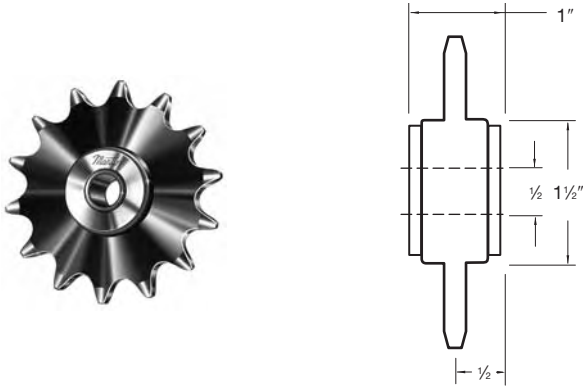

Bronze Bushed Idler Sprockets

No. Teeth	Catalog Number	Chain Size	O.D.	Stock Bore	Wt. Lbs.
20	31E20	35	2.60	1/2"	.46
15	41E15	41-40	2.65	1/2"	.50
15	51E15	50	3.32	1/2"	.70
14	61E14	60-60H	3.74	1/2"	.92

Above idlers have oil impregnated sintered bronze bearings and are mounted on steel journals. Idler RPM to 2500. Radial load rating to 50 pounds.

Bronze Bearing Type

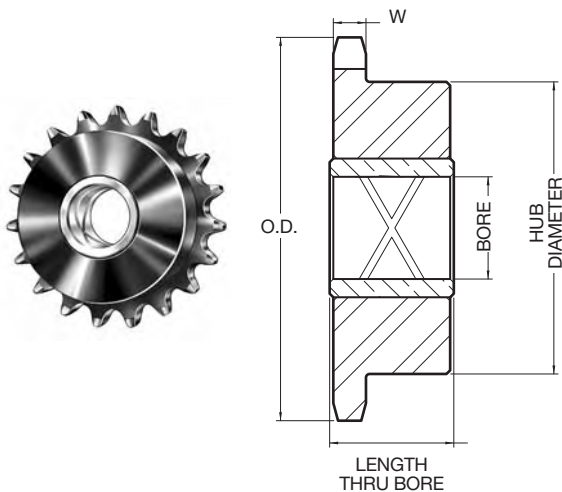

Bronze Bearing Idler Sprocket

No. Teeth	Catalog Number	Bearing Type	Chain Size	O.D.	Stock Bore	Length Thru Bore	W	Hub Diameter	Wt. Lbs.
15	35BR15 1/2	Bronze	35	1.99	1/2"	0.94	0.168	1.35	0.30
21	35BR21 7/8	Bronze	35	2.71	7/8"	1.06	0.168	2.00	0.75
13	41BR13 1/2	Bronze	41	2.33	1/2"	0.94	0.227	1.56	0.50
19	41BR19 7/8	Bronze	41	3.29	7/8"	1.06	0.227	2.50	1.00
13	40BR13 1/2	Bronze	40	2.33	1/2"	0.94	0.284	1.56	0.50
19	40BR19 7/8	Bronze	40	3.29	7/8"	1.06	0.284	2.50	1.25
13	50BR13 1/2	Bronze	50	2.91	1/2"	0.94	0.343	1.87	0.90
17	50BR17 7/8	Bronze	50	3.72	7/8"	1.06	0.343	2.62	1.50
15	60BR15 7/8	Bronze	60	3.98	7/8"	1.06	0.459	2.62	1.75
17	60BR17 1 1/8	Bronze	60	4.46	1 1/8"	1.56	0.459	3.25	2.75
15	80BR15 1 1/8	Bronze	80	5.30	1 1/8"	1.56	0.575	3.50	4.25

7/8" & 1-1/8" bore have double loop grease groove.

Radial Load Capacity in Pounds at Various Speeds Needle Bearings

Idler Size	RPM					
	100	500	1000	1500	2000	2500
1/2" Bore	1021	630	512	453	416	389
1" Bore	2751	1698	1379	1221	1120	1048
1-1/2" Bore	6306	3891	3160	2798	2567	-

Ratings shown above are based on an average bearing life of 2500 hours.

Needle Bearing Type

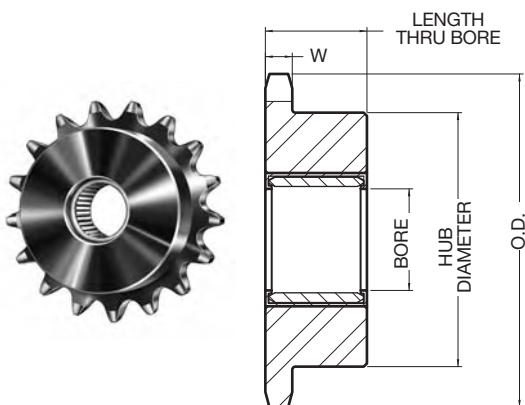

Needle Bearing Idler Sprocket - Hardened Teeth

No. Teeth	Catalog Number	Bearing Type	Chain Size	O.D.	Stock Bore	Length Thru Bore	W	Hub Diameter	Wt. Lbs.
19	25NB19H 1/2	Needle	25	1.65	0.50	0.75	0.110	1.22	0.10
13	35NB13H 1/2	Needle	35	1.75	0.50	0.75	0.168	1.18	0.20
19	35NB19H 1	Needle	35	2.47	1.00	1.00	0.168	1.84	0.50
19	41NB19H 1	Needle	41	3.29	1.00	1.00	0.227	2.50	1.00
19	40NB19H 1	Needle	40	3.29	1.00	1.00	0.284	2.50	1.10
17	50NB17H 1	Needle	50	3.72	1.00	1.00	0.343	2.25	1.30
17	60NB17H 1	Needle	60	4.46	1.00	1.00	0.459	3.00	2.60
13	80NB13H 1	Needle	80	4.66	1.00	1.25	0.575	2.63	2.90
11	100NB11H 1 1/2	Needle	100	5.01	1.50	1.88	0.692	3.56	3.60
11	120NB11H 1 1/2	Needle	120	6.01	1.50	2.13	0.924	3.56	7.00
11	140NB11H 1 1/2	Needle	140	7.01	1.50	2.25	0.924	4.25	10.90
9	160NB9H 1 1/2	Needle	160	6.70	1.50	2.25	1.156	3.63	9.60

Idler Sprockets

Ball Bearing Type

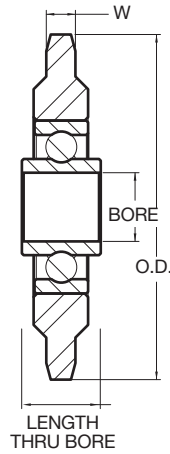

Ball Bearing Idler Sprocket - Hardened Teeth

No. Teeth	Discontinued Part Number	Catalog Number	Bearing Type	Chain Size	O.D.	Stock Bore	Length Thru Bore	W	Wt. Lbs.
20		25BB20 3/8 *	Ball	25	1.73	0.394	0.35	0.110	0.10
19		35BB19H 3/8	Ball	35	2.47	0.394	0.38	0.168	0.35
19		35BB19H 1/2	Ball	35	2.47	0.510	0.72	0.168	0.35
20	35BB20H	35BB20H 5/8	Ball	35	2.59	0.638	0.72	0.168	0.38
18		41BB18H 1/2	Ball	41	3.14	0.510	0.72	0.227	0.51
18		41BB18H 5/8	Ball	41	3.14	0.638	0.72	0.227	0.51
17	40BB17H	40BB17H 5/8	Ball	40	2.97	0.638	0.72	0.284	0.52
18		40BB18H 1/2	Ball	40	3.14	0.510	0.72	0.284	0.53
18	40BB18H	40BB18H 5/8	Ball	40	3.14	0.638	0.72	0.284	0.53
25		40BB25H 5/8	Ball	40	4.26	0.638	0.72	0.284	0.90
35		40BB35H 5/8	Ball	40	5.86	0.638	0.72	0.284	1.77
48		40BB48H 5/8	Ball	40	7.93	0.638	0.72	0.284	3.37
15	50BB15H	50BB15H 5/8	Ball	50	3.32	0.638	0.72	0.343	0.75
17		50BB17H 1/2	Ball	50	3.72	0.510	0.72	0.343	0.78
17	50BB17H	50BB17H 5/8	Ball	50	3.72	0.638	0.72	0.343	0.78
25		50BB25H 3/4	Ball	50	5.32	0.750	0.61	0.343	1.66
39		50BB39H 3/4	Ball	50	8.12	0.750	0.61	0.343	4.09
12		60BB12H 5/8	Ball	60	3.25	0.638	0.72	0.459	0.72
13	60BB13H	60BB13H 5/8	Ball	60	3.49	0.638	0.72	0.459	0.76
15		60BB15H 1/2	Ball	60	3.98	0.510	0.72	0.459	1.06
15	60BB15H	60BB15H 5/8	Ball	60	3.98	0.638	0.72	0.459	1.06
17		60BB17H 5/8	Ball	60	4.46	0.638	0.72	0.459	1.10
12	80BB12H	80BB12H 3/4	Ball	80	4.33	0.750	0.61	0.575	1.50

Note: .394 Stock Bore is +.000 -.0003; .510 Stock Bore is +.005 -.000; .638 Stock Bore is +.005 -.000; .750 Stock Bore is +.005 -.000. Discontinued Part Numbers will be replaced with Catalog Number when existing inventory is exhausted.

* Unhardened Teeth

Non-Metallic Teeth - Ball Bearing Type

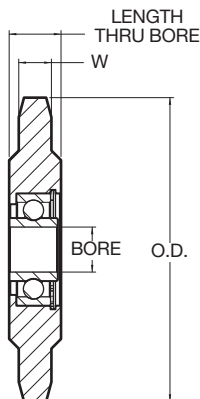

Ball Bearing Idler Sprockets - Non Metallic Teeth

No. Teeth	Catalog Number	Bearing Type	Chain Size	O.D.	Stock Bore	Length Thru Bore	W	Wt. Lbs.
17	40BB17NM 1/2	Ball	40	2.97	0.510	0.72	0.284	0.24
18	40BB18NM 5/8	Ball	40	3.14	0.638	0.72	0.284	0.23
17	50BB17NM 1/2	Ball	50	3.72	0.510	0.72	0.343	0.29
18	50BB18NM 5/8	Ball	50	3.92	0.638	0.72	0.343	0.29
15	60BB15NM 1/2	Ball	60	3.98	0.510	0.72	0.459	0.32
16	60BB16NM 5/8	Ball	60	4.22	0.638	0.72	0.459	0.33
12	80BB12NM 3/4	Ball	80	4.33	0.750	0.61	0.575	0.44

Note: .510 Stock Bore is +.005 -.000; .638 Stock Bore is +.005 -.000; .750 Stock Bore is +.005 -.000

Radial Load Capacity in Pounds at Various Speeds Ball Bearings

Idler Size	RPM					
	100	500	1000	1500	2000	2500
3/8" Bore	620	363	288	252	229	212
1/2" & 5/8" Bore	800	460	360	320	290	270
3/4" Bore	1290	755	600	523	478	440

Ratings shown above are based on an average bearing life of 2500 hours.

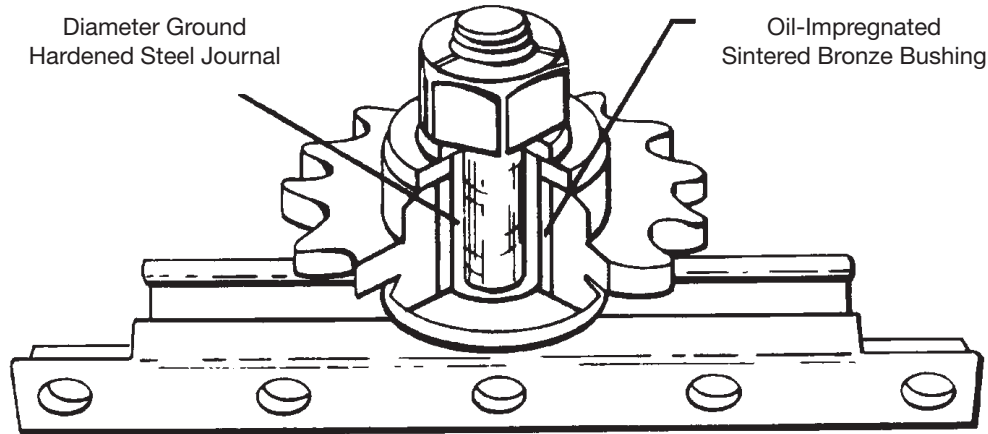

Chain Tightener (Less Idler Sprocket)

NO. E-5006

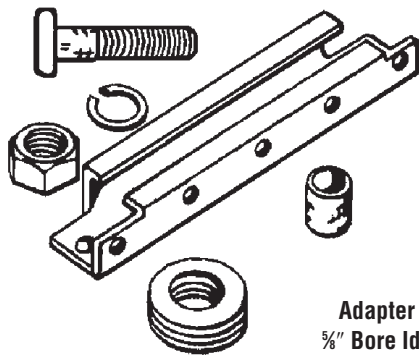

Adapter for
 $\frac{5}{8}$ " Bore Idler

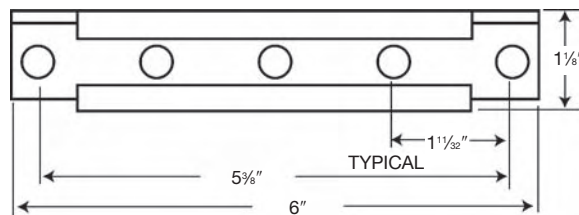

Attachment Bolts Not
Furnished

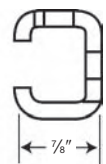

Attachments Holes
for $\frac{5}{16}$ " Bolts

Martin Chain Tighteners are economical to use . . . they provide everything needed for a quick, easy installation . . . they save time and money . . . there is no need to design, procure or custom make and assemble separate parts . . . they accommodate mounting in several different positions . . . parallel or at 90° to the mounting surface . . . as cantilever or attached each end.

Features of *Martin* Idlers

Smooth-running, oil-impregnated, sintered bronze, extra-duty bearing press-fitted in sprocket. Steel journal case hardened . . . for maximum resistance to wear . . . diameter ground surface for free running under load.

Steel sprockets used in *Martin* Idlers . . . are accurately machined (not stamped) the same as sprockets normally supplied for power transmission use.

800 Series Conveyor Sprockets

Martin Series 800 Conveyor Sprockets Manufactured From High Quality Semi-Steel



**815 Solid Face
with Guide Ring Holes
for Straight Running Chains**

THE NEW
"QRS"
SPLIT



**820 Grooved Face for
Straight Running Chain**

PAT. # 4,964,842

**Split
815/820 Solid and Grooved Face
with Guide Ring Holes
Steel and Thermoplastic**



**821 Heavy Duty
for Wide Hinged Chain
Straight Running**



**880 and 882 Single Duty
for Side Flex Chains**



881 for Side Flex Chain

Sprockets for 815, 820, and 881 are all double duty. Sprockets with odd numbers of teeth are recommended for longer wear since a given tooth engages the chain every other revolution. Sprockets with 19, 21, 23, and 25 teeth are preferred. Sprockets with even number of teeth should be advanced one tooth periodically to attain even wear.

Martin “QRS®” Split Sprocket

Series 815/820 Split Sprockets for Flat Top Conveyor Chains

Split Sprockets Manufactured
from Steel and Thermoplastic Material
Stocked in 21, 23, 25, and 27 Tooth Sizes

Martin's **Quick Replacement Split Sprocket** eliminates the time consuming and costly dismounting of shafts and pillow blocks to remove worn sprockets — all that's required is a wrench

“QRS” Split Thermoplastic Sprocket Advantages:
Lightweight — Service Temp. to 300°F — Low Temp. Toughness
— Excellent Resistance to Oils, Grease, Soaps, and Detergents
— Outstanding Abrasion and Impact Resistance

Available with solid and grooved face
and furnished with rust resistant plated steel bolts and nuts

Split (plated carbon steel and stainless) Guide Rings
available, if necessary, for easy assembly



Proudly made in the U.S.A.

PAT. # 4,964,842

Call your *Martin* Distributor

Split Steel and Thermoplastic Stock Bore

Series 815 Sprockets — Split Steel

Catalog Number	No. Teeth		Pitch Diameter†	Outside Diameter†	Bore†		Weight
	Actual	Effective			Stock	Maximum	
QRS815A21	21	10½	5.089 (129.26)	5.12 (130.0)	¾ (19.1)	1½ (38.1)	5.0 (2.27)
QRS815A23	23	11½	5.560 (141.22)	5.59 (142.0)	¾ (19.1)	1½ (38.1)	5.6 (2.54)
QRS815A25	25	12½	6.032 (153.21)	6.07 (154.2)	¾ (19.1)	1½ (38.1)	6.6 (3.0)
QRS815A27	27	13½	6.504 (165.20)	6.56 (166.6)	¾ (19.1)	1½ (38.1)	7.8 (3.54)

★ NOTE: Supplied with ⅜ - 18 standard setscrew @ 90° to split.

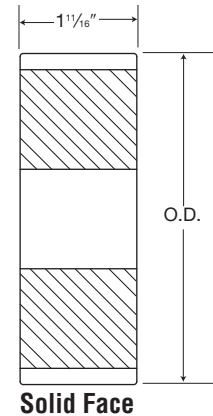

Series 815 Sprockets — Split Thermoplastic

Catalog Number	No. Teeth		Pitch Diameter†	Outside Diameter†	Bore†		Weight
	Actual	Effective			Stock	Maximum	
QRS815A21P	21	10½	5.089 (129.26)	5.12 (130.0)	¾ (19.1)	1½ (38.1)	.94 (.43)
QRS815A23P	23	11½	5.560 (141.22)	5.59 (142.0)	¾ (19.1)	1½ (38.1)	1.00 (.45)
QRS815A25P	25	12½	6.032 (153.21)	6.07 (154.2)	¾ (19.1)	1½ (38.1)	1.10 (.50)
QRS815A27P	27	13½	6.504 (165.20)	6.56 (166.6)	¾ (19.1)	1½ (38.1)	1.25 (.57)

Thermoplastic temperature operating range -20°F to +300°F

★ NOTE: Supplied with ⅜ - 18 plated setscrew @ 90° to split.



PAT. #4,964,842

Series 820 Sprockets — Split Steel

Catalog Number	No. Teeth		Pitch Diameter†	Outside Diameter†	Bore†		Weight
	Actual	Effective			Stock	Maximum	
QRS820A21	21	10½	5.089 (129.26)	5.12 (130.0)	¾ (19.1)	1½ (38.1)	5.0 (2.27)
QRS820A23	23	11½	5.560 (141.22)	5.59 (142.0)	¾ (19.1)	1½ (38.1)	5.6 (2.54)
QRS820A25	25	12½	6.032 (153.21)	6.07 (154.2)	¾ (19.1)	1½ (38.1)	6.6 (3.0)
QRS820A27	27	13½	6.504 (165.20)	6.56 (166.6)	¾ (19.1)	1½ (38.1)	7.8 (3.54)

★ NOTE: Supplied with ⅜ - 18 standard setscrew @ 90° to split.



Series 820 Sprockets — Split Thermoplastic

Catalog Number	No. Teeth		Pitch Diameter†	Outside Diameter†	Bore†		Weight
	Actual	Effective			Stock	Maximum	
QRS820A21P	21	10½	5.089 (129.26)	5.12 (130.0)	¾ (19.1)	1½ (38.1)	.94 (.43)
QRS820A23P	23	11½	5.560 (141.22)	5.59 (142.0)	¾ (19.1)	1½ (38.1)	1.00 (.45)
QRS820A25P	25	12½	6.032 (153.21)	6.07 (154.2)	¾ (19.1)	1½ (38.1)	1.10 (.50)
QRS820A27P	27	13½	6.504 (165.20)	6.56 (166.6)	¾ (19.1)	1½ (38.1)	1.25 (.57)

★ NOTE: Supplied with ⅜ - 18 plated setscrew @ 90° to split.

† Inches/mm

For Guide Ring Specifications See page A-12

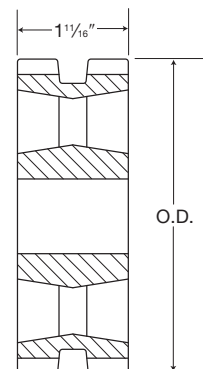

Series 821 Sprockets — Semi-Steel — Stock Bore

Catalog Number	No. Teeth		Pitch Diameter†	Outside Diameter†	Bore†		Weight
	Actual	Effective			Stock	Maximum	
821A21	21	10½	5.089 (129.26)	5.12 (130.1)	1 (25.4)	1¼ (44.5)	6.7 (3.0)
821A23	23	11½	5.560 (141.22)	5.59 (142.0)	1 (25.4)	1¼ (44.5)	7 (3.2)
821A25	25	12½	6.032 (153.21)	5.07 (154.2)	1 (25.4)	1¼ (44.5)	7.3 (3.3)
821A27	27	13½	6.504 (165.20)	6.56 (166.6)	1 (25.4)	1¼ (44.5)	7.6 (3.4)
821A29	29	14½	6.978 (177.24)	7.05 (179.1)	1 (25.4)	1¼ (44.5)	8.0 (3.6)

NOTE: † Inches/mm
821 Series also runs with 815 H chain.

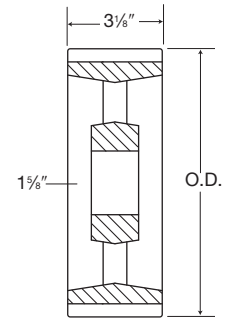

Series 880 Sprockets — Semi-Steel — Stock Bore

Catalog Number	No. Teeth		Pitch Diameter†	Outside Diameter†	Bore†		Weight
	Actual	Effective			Stock	Maximum	
880C9•	9	9	4.386 (111.40)	4.33 (110.0)	¾ (19.1)	1¼ (44.5)	2.8 (1.3)
880C10	10	10	4.854 (123.29)	4.82 (122.4)	¾ (19.1)	1¼ (44.5)	3.2 (1.4)
880C11	11	11	5.324 (135.22)	5.31 (134.9)	¾ (19.1)	1¼ (44.5)	3.4 (1.5)
880C12	12	12	5.796 (147.22)	5.80 (147.3)	¾ (19.1)	1¼ (44.5)	3.6 (1.6)
880C15	15	15	7.215 (182.26)	7.26 (184.4)	¾ (19.1)	1¼ (44.5)	4.2 (1.9)

NOTE: • Block Body – Other sizes are arm body
† Inches/mm

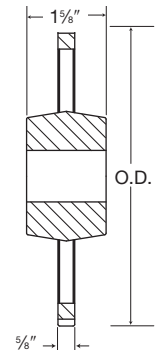

Series 881 Sprockets — Semi-Steel — Stock Bore

Catalog Number	No. Teeth		Pitch Diameter†	Outside Diameter†	Bore†		Weight
	Actual	Effective			Stock	Maximum	
881C21	21	10½	5.089 (129.26)	5.120 (130.05)	¾ (19.1)	1¼ (44.5)	4.2 (1.9)
881C23	23	11½	5.560 (141.22)	5.590 (141.99)	¾ (19.1)	1¼ (44.5)	4.6 (2.1)
881C25	25	12½	6.032 (153.21)	6.070 (154.18)	¾ (19.1)	1¼ (44.5)	5.0 (2.3)

NOTE: † Inches/mm

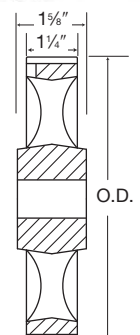

800 Series Conveyor Sprockets



Series 820 Sprockets — Semi-Steel — Stock Bore

Catalog Number	No. Teeth		Pitch Diameter†	Outside Diameter†	Bore†		Weight
	Actual	Effective			Stock	Maximum	
820A13B•	13	6½	3.228 (81.99)	3.11 (79.0)	¾ (19.1)	1¼ (31.8)	2.4 (1.1)
820A15B•	15	7½	3.688 (93.68)	3.63 (92.2)	¾ (19.1)	1¼ (31.8)	3.6 (1.6)
820A17B•	17	8½	4.153 (105.49)	4.12 (104.7)	¾ (19.1)	1⅞ (42.9)	4.7 (2.1)
820A19	19	9½	4.620 (117.35)	4.61 (117.1)	¾ (19.1)	1¼ (31.8)	3.1 (1.5)
820A20	20	10	4.854 (123.29)	4.86 (123.4)	¾ (19.1)	1¼ (31.8)	3.8 (1.7)
820A21	21	10½	5.089 (129.26)	5.12 (130.0)	¾ (19.1)	1¼ (44.5)	4.6 (2.1)
820A21B•	21	10½	5.089 (129.26)	5.12 (130.0)	¾ (19.1)	2½ (63.5)	7.1 (3.3)
820A22	22	11	5.324 (135.23)	5.35 (135.9)	¾ (19.1)	1¼ (44.5)	4.2 (1.9)
820A23	23	11½	5.560 (141.22)	5.59 (142.0)	¾ (19.1)	1¼ (44.5)	5.3 (2.4)
820A24	24	12	5.796 (147.22)	5.83 (148.1)	¾ (19.1)	1¼ (44.5)	4.4 (2.0)
820A25	25	12½	6.032 (153.21)	6.07 (154.2)	¾ (19.1)	2 (50.8)	5.6 (2.4)
820A25B•	25	12½	6.032 (153.21)	6.07 (154.2)	¾ (19.1)	3⅞ (81.0)	9.6 (4.4)
820A27	27	13½	6.504 (165.20)	6.56 (166.6)	¾ (19.1)	2 (50.8)	6.5 (2.8)
820A29	29	14½	6.978 (177.24)	7.05 (179.1)	¾ (19.1)	2 (50.8)	6.8 (3.1)
820A31	31	15½	7.452 (189.28)	7.53 (191.3)	¾ (19.1)	2 (50.8)	6.9 (3.1)
820A41	41	20½	9.826 (249.58)	9.93 (252.2)	¾ (19.1)	2½ (64)	16.00 (7.1)

NOTE: • Block Body — Other sizes are arm body

† Inches/mm

Max. bore shown is with Standard Keyway and Setscrew.

820 Series stocked grooved. (Guide ring holes in 21, 23, 25, and 27 tooth sizes can be provided upon request).

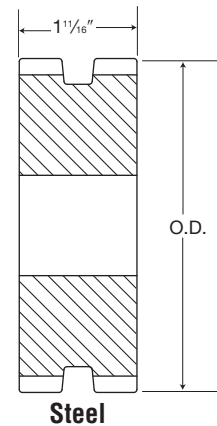

Series 820 Sprockets — Semi-Steel — Bored to Size

Catalog Number	Inch/Metric Stock Finished Bores With Standard Keyway and Setscrew				
	820BS19	1" (25.4)			
820BS21	1" (25.4)				
820BS23	⅞" (22.2)	1" (25.4)	1⅛" (28.6)	1⅜" (30.2)	1½" (31.8)
820BS25	1" (25.4)				
820BS27	1" (25.4)				

Stock grooved without guide ring holes. All arm body.

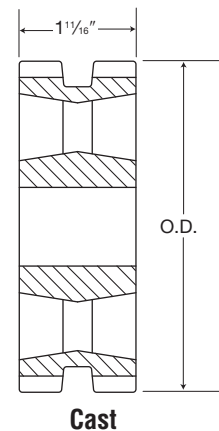

Series 815 Sprockets — Semi-Steel — Stock Bore

Catalog Number	No. Teeth		Pitch Diameter†	Outside Diameter†	Bore†		Weight
	Actual	Effective			Stock	Maximum	
815A13B•	13	6½	3.228 (81.99)	3.11 (79.0)	¾ (19.1)	1¼ (31.8)	2.4 (1.1)
815A15B•	15	7½	3.688 (93.68)	3.63 (92.2)	¾ (19.1)	1¼ (31.8)	3.6 (1.6)
815A17B•	17	8½	4.153 (105.49)	4.12 (104.7)	¾ (19.1)	1½/₁₆ (42.9)	4.7 (2.1)
815A19	19	9½	4.620 (117.35)	4.61 (117.1)	¾ (19.1)	1¼ (31.8)	3.1 (1.5)
815A20	20	10	4.854 (123.29)	4.86 (123.4)	¾ (19.1)	1¼ (31.8)	3.8 (1.7)
815A21	21	10½	5.089 (129.26)	5.12 (130.0)	¾ (19.1)	1¼ (44.5)	4.6 (2.1)
815A21B•	21	10½	5.089 (129.26)	5.12 (130.0)	¾ (19.1)	2½ (63.5)	7.1 (3.3)
815A22	22	11	5.324 (135.23)	5.35 (135.9)	¾ (19.1)	1¼ (44.5)	4.2 (1.9)
815A23	23	11½	5.560 (141.22)	5.59 (142.0)	¾ (19.1)	1¼ (44.5)	5.3 (2.4)
815A24	24	12	5.796 (147.22)	5.83 (148.1)	¾ (19.1)	1¼ (44.5)	4.4 (2.0)
815A25	25	12½	6.032 (153.21)	6.07 (154.2)	¾ (19.1)	2 (50.8)	5.6 (2.4)
815A25B•	25	12½	6.032 (153.21)	6.07 (154.2)	¾ (19.1)	3½ (81.0)	9.6 (4.4)
815A27	27	13½	6.504 (165.20)	6.56 (166.6)	¾ (19.1)	2 (50.8)	6.5 (2.8)
815A29	29	14½	6.978 (177.24)	7.05 (179.1)	¾ (19.1)	2 (50.8)	6.8 (3.1)
815A31	31	15½	7.452 (189.28)	7.53 (191.3)	¾ (19.1)	2 (50.8)	6.9 (3.1)
815A41	41	20½	9.826 (249.58)	9.93 (252.2)	¾ (19.1)	2½ (64)	16.00 (7.1)

NOTE: • Block Body — Other sizes are arm body
 † Inches/mm
 Max. bore shown is with Standard Keyway and Setscrew.
 815 Series stocked not grooved, with guide ring holes.

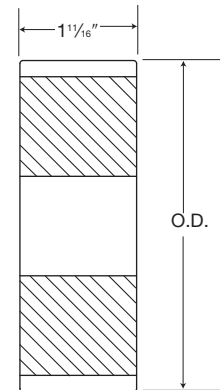

Series 815 Sprockets — Semi-Steel — Bored to Size

Catalog Number	Inch/Metric Stock Finished Bores With Standard Keyway and Setscrew				
	815BS19	1" (25.4)			
815BS21	1" (25.4)				
815BS23	¾" (22.2)	1" (25.4)	1½" (28.6)	1¾" (30.2)	1½" (31.8)
815BS25	1" (25.4)		1¾" (30.2)		1½" (31.8)
815BS27	1" (25.4)				

Stock not grooved but with guide ring holes. All arm body.

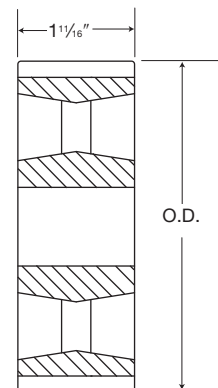

Series 800 Conveyor Sprockets

Series 882 Sprockets — Semi-Steel — Stock Bore

Catalog Number	No. Teeth		Pitch Diameter†	Outside Diameter†	Bore†		Weight
	Actual	Effective			Stock	Maximum	
882C9	9	9	4.386 (111.40)	4.430 (112.5)	$\frac{3}{8}$ (19.1)	$1\frac{1}{4}$ (44.5)	3.8 (1.8)
882C10	10	10	4.854 (123.29)	4.920 (125.0)	$\frac{3}{8}$ (19.1)	$1\frac{1}{4}$ (44.5)	4.2 (1.9)
882C11	11	11	5.325 (135.25)	5.410 (137.40)	$\frac{3}{8}$ (19.1)	$1\frac{1}{4}$ (44.5)	4.4 (2.1)
882C12•	12	12	5.796 (147.21)	5.90 (149.90)	$\frac{3}{8}$ (19.1)	$1\frac{1}{4}$ (44.5)	4.6 (2.2)

NOTE: • Arm Body — Other sizes are block body
† Inches/mm

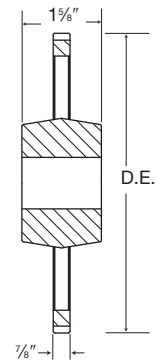

815 Guide Rings — Steel and Stainless Steel

Catalog Number★	O.D. Inches (mm)	Thick Inches (mm)	Weight Per Set
GR15-16 GR15-16SS	3.62 (91.9)	$\frac{1}{16}$ (1.6)	.23 (.10)
GR17-18 GR17-18SS	4.11 (104.4)	$\frac{1}{16}$ (1.6)	.26 (.120)
GR19-20 GR19-20SS	4.58 (116.3)	$\frac{1}{8}$ (3.2)	.37 (.17)
GR21-22 GR21-22SS	5.09 (129.3)	$\frac{1}{8}$ (3.2)	.44 (.20)
GR23-24 GR23-24SS	5.56 (141.2)	$\frac{1}{8}$ (3.2)	.46 (.21)
GR25-26 GR25-26SS	6.04 (153.4)	$\frac{1}{8}$ (3.2)	.47 (.21)
GR27-28 GR27-28SS	6.53 (165.9)	$\frac{1}{8}$ (3.2)	.53 (.24)
GR29-30 GR29-30SS	7.02 (178.3)	$\frac{1}{8}$ (3.2)	.56 (.25)
GR31-32 GR31-32SS	7.50 (190.5)	$\frac{1}{8}$ (3.2)	.67 (.30)
GR41-42 GR41-42SS	9.89 (251.2)	$\frac{1}{8}$ (3.2)	.92 (.42)

★ Carbon Steel
Stainless Steel

Stock Semi-Finished Weld-On Hubs

Catalog No.	Dimensions			Approx. Wt. Lbs.	Catalog No.	Dimensions			Approx. Wt. Lbs.	Catalog No.	Dimensions			Approx. Wt. Lbs.
	Outside Diameter	Length	Inside Diameter			Outside Diameter	Length	Inside Diameter			Outside Diameter	Length	Inside Diameter	
225-28-19	2 1/4	3/8	1 1/2	.9	550-48-40	5 1/2	1 1/2	1 1/2	9.3	750-70-48	7 1/2	2 1/8	1 1/2	26.3
225-28-23	2 1/4	3/8	1 3/4	.9	550-48-48	5 1/2	1 1/2	1 1/2	9.3	750-72-48	7 1/2	2 1/4	1 1/2	27.0
225-32-00	2 1/4	1	—	1.1	550-58-40	5 1/2	1 3/8	1 1/4	11.6	750-74-48	7 1/2	2 1/8	1 1/2	18.5
250-30-00	2 1/2	1 1/8	—	1.3	550-58-48	5 1/2	1 3/8	1 1/2	11.6	750-84-48	7 1/2	2 1/8	1 1/2	31.5
250-40-00	2 1/2	1 1/4	—	1.7	550-64-48	5 1/2	2	1 1/2	12.5	750-94-48	7 1/2	2 1/8	1 1/2	35.0
300-25-19	3	2 3/8	1 1/2	1.2	575-24-32	5 3/4	3/4	1	5.4	775-36-48	7 3/4	1 1/8	1 1/2	23.0
300-30-23	3	1 1/8	1 3/4	1.6	575-32-00	5 3/4	1	—	7.4	775-58-48	7 3/4	1 1/8	1 1/2	25.0
300-30-30	3	1 1/8	1 1/2	1.6	575-42-00	5 3/4	1 1/8	—	9.7	775-66-48	7 3/4	2 1/8	1 1/2	26.0
300-32-00	3	1	—	2.0	575-42-48	5 3/4	1 1/8	1 1/2	9.7	775-74-48	7 3/4	2 1/8	1 1/2	31.0
300-38-00	3	1 1/8	—	2.4	575-44-36	5 3/4	1 1/8	1 1/8	10.9	775-94-48	7 3/4	2 1/8	1 1/2	36.0
300-40-30	3	1 1/4	1 1/8	2.3	575-52-00	5 3/4	1 1/8	—	12.0	800-54-48	8	1 1/8	1 1/2	23.2
325-25-19	3 1/4	2 3/8	1 1/2	1.8	575-52-48	5 3/4	1 1/8	1 1/2	12.0	800-62-48	8	1 1/8	1 1/2	26.6
325-30-23	3 1/4	1 1/8	1 3/4	2.1	575-72-32	5 3/4	2 1/4	1	16.1	800-72-48	8	2 1/4	1 1/2	30.9
350-30-00	3 1/2	1 1/8	—	2.6	600-41-48	6	1 1/2	1 1/2	9.6	800-78-48	8	2 1/8	1 1/2	33.5
350-34-00	3 1/2	1 1/8	—	2.9	600-46-48	6	1 1/8	1 1/2	10.8	800-112-48	8	3 1/2	1 1/2	48.1
350-38-00	3 1/2	1 1/8	—	3.2	600-52-48	6	1 1/8	1 1/2	12.2	850-50-48	8 1/2	1 1/8	1 1/2	24.3
356-28-23	3 3/8	3/8	1 3/4	2.4	600-58-48	6	1 1/8	1 1/2	13.6	850-52-48	8 1/2	1 1/8	1 1/2	24.3
356-28-30	3 3/8	3/8	1 1/2	2.3	600-62-00	6	1 1/8	—	15.5	850-72-48	8 1/2	2 1/4	1 1/2	35.0
356-31-23	3 3/8	3/8	1 3/4	2.6	600-62-40	6	1 1/8	1 1/4	15.5	850-84-48	8 1/2	2 3/8	1 1/2	40.8
375-30-00	3 3/4	1 1/8	—	2.9	600-62-48	6	1 1/8	1 1/2	15.5	850-124-48	8 1/2	3 3/8	1 1/2	50.0
375-30-30	3 3/4	1 1/8	1 1/8	2.8	600-68-48	6	2 1/4	1 1/2	16.0	900-58-48	9	1 1/8	1 1/2	32.0
375-45-30	3 3/4	1 1/2	1 1/8	4.1	600-80-48	6	2 1/2	1 1/2	18.8	900-60-48	9	1 1/8	1 1/2	32.9
400-26-00	4	1 1/8	—	2.9	625-16-40	6 1/4	1/2	1 1/4	4.4	900-72-48	9	2 1/4	1 1/2	39.4
400-26-23	4	1 1/8	1 3/4	2.8	625-16-48	6 1/4	1/2	1 1/4	4.4	900-112-48	9	3 1/2	1 1/2	61.3
400-26-30	4	1 1/8	1 1/2	2.7	625-24-32	6 1/4	3/4	1	6.4	950-52-188	9 1/2	1 1/8	5 1/2	20.2
400-31-30	4	3/8	1 1/2	3.3	625-24-40	6 1/4	3/4	1 1/4	6.4	950-54-48	9 1/2	1 1/8	1 1/2	33.1
400-32-23	4	1	1 3/4	3.5	625-24-48	6 1/4	3/4	1 1/2	6.4	950-60-188	9 1/2	1 1/8	5 1/2	23.3
400-36-00	4	1 1/8	—	3.5	625-28-48	6 1/4	7/8	1 1/2	7.2	950-60-48	9 1/2	1 1/8	1 1/2	36.8
400-48-30	4	1 1/2	1 1/8	5.1	625-30-48	6 1/4	1 1/8	1 1/2	8.1	950-66-48	9 1/2	2 1/8	1 1/2	40.4
425-26-00	4 1/4	1 1/8	—	3.3	625-32-40	6 1/4	1	1 1/4	8.3	950-70-188	9 1/2	2 1/2	5 1/2	27.5
425-26-30	4 1/4	1 1/8	1 1/8	3.1	625-34-48	6 1/4	1 1/8	1 1/2	9.3	950-70-48	9 1/2	2 1/8	1 1/2	44.0
425-30-30	4 1/4	1 1/8	1 1/2	3.6	625-38-40	6 1/4	1 1/8	1 1/4	10.0	950-74-188	9 1/2	2 1/8	5 1/2	28.7
425-38-30	4 1/4	1 1/8	1 1/2	4.5	625-38-48	6 1/4	1 1/8	1 1/2	9.7	950-74-48	9 1/2	2 1/8	1 1/2	45.3
425-42-40	4 1/4	1 1/8	1 1/4	4.8	625-48-48	6 1/4	1 1/2	1 1/2	12.3	950-78-188	9 1/2	2 1/8	5 1/2	30.3
425-45-30	4 1/4	1 1/2	1 1/8	5.4	625-52-48	6 1/4	1 1/8	1 1/2	13.3	950-78-48	9 1/2	2 1/8	1 1/2	49.0
425-50-40	4 1/4	1 1/8	1 1/4	5.7	625-68-48	6 1/4	2 1/4	1 1/2	17.4	950-80-48	9 1/2	2 1/4	1 1/2	49.0
450-34-00	4 1/2	1 1/8	—	4.8	625-80-32	6 1/4	2 1/2	1	21.1	950-82-188	9 1/2	2 1/8	5 1/2	31.8
450-36-40	4 1/2	1 1/8	1 1/4	4.7	650-44-00	6 1/2	1 1/8	—	12.9	950-82-48	9 1/2	2 1/8	1 1/2	50.2
450-44-40	4 1/2	1 1/8	1 1/4	5.7	650-44-48	6 1/2	1 1/8	1 1/2	12.9	950-86-188	9 1/2	2 1/8	5 1/2	33.4
450-44-48	4 1/2	1 1/8	1 1/2	5.7	650-52-48	6 1/2	1 1/8	1 1/2	14.5	950-86-48	9 1/2	2 1/8	1 1/2	54.0
450-48-48	4 1/2	1 1/8	1 1/2	6.0	650-72-48	6 1/2	2 1/4	1 1/2	20.0	950-88-48	9 1/2	2 1/4	1 1/2	53.9
475-12-40	4 3/4	3/8	1 1/4	1.8	650-96-48	6 1/2	3	1 1/2	26.7	950-96-48	9 1/2	3	1 1/2	58.7
475-22-30	4 3/4	1 1/8	1 1/2	3.3	675-36-40	6 3/4	1 1/8	1 1/4	11.0	100-80-48	10	2 1/2	1 1/2	54.4
475-22-40	4 3/4	1 1/8	1 1/4	3.3	675-38-48	6 3/4	1 1/8	1 1/2	11.4	100-100-48	10	3 1/2	1 1/2	68.0
475-26-40	4 3/4	1 1/8	1 1/4	4.0	675-44-48	6 3/4	1 1/8	1 1/2	13.3	100-116-48	10	3 1/2	1 1/2	78.8
475-30-30	4 3/4	1 1/8	1 1/2	4.5	675-61-48	6 3/4	1 3/8	1 1/2	19.4	100-124-48	10	3 1/2	1 1/2	84.3
475-36-00	4 3/4	1 1/8	—	5.7	675-72-48	6 3/4	2 1/4	1 1/2	21.7	105-56-200	10 1/2	1 1/8	6 1/4	27.8
475-36-30	4 3/4	1 1/8	1 1/2	5.5	675-94-40	6 3/4	2 1/8	1 1/4	28.3	105-58-200	10 1/2	1 1/8	6 1/4	28.7
475-44-48	4 3/4	1 1/8	1 1/2	6.2	700-24-48	7	3/4	1 1/2	8.2	105-100-200	10 1/2	3 1/8	6 1/4	49.6
475-48-38	4 3/4	1 1/2	1 1/8	7.0	700-26-48	7	1 1/8	1 1/2	8.9	105-106-200	10 1/2	3 3/8	6 1/4	52.5
475-48-40	4 3/4	1 1/2	1 1/4	7.0	700-28-48	7	7/8	1 1/2	8.9	110-128-48	11	4	1 1/2	105.7
475-50-00	4 3/4	1 1/8	—	7.8	700-30-48	7	1 1/8	1 1/2	9.2					
475-50-40	4 3/4	1 1/8	1 1/4	7.8	700-32-48	7	1	1 1/2	9.8					
475-54-00	4 3/4	1 1/8	—	8.5	700-36-48	7	1 1/8	1 1/2	12.3					
500-42-40	5	1 1/8	1 1/4	6.8	700-38-48	7	1 1/8	1 1/2	13.0					
500-50-00	5	1 1/8	—	8.7	700-44-48	7	1 1/8	1 1/2	14.3					
500-50-40	5	1 1/8	1 1/4	8.7	700-52-48	7	1 1/8	1 1/2	16.9					
500-58-40	5	1 1/8	1 1/4	9.5	700-58-48	7	1 1/8	1 1/2	18.9					
500-58-48	5	1 1/8	1 1/2	9.4	700-61-48	7	1 3/8	1 1/2	19.8					
525-24-32	5 1/4	3/4	1	4.4	700-62-48	7	1 1/8	1 1/2	21.1					
525-34-00	5 1/4	1 1/8	—	6.5	700-68-48	7	2 1/8	1 1/2	22.1					
525-36-40	5 1/4	1 1/8	1 1/4	6.5	700-112-48	7	3 1/2	1 1/2	36.4					
525-42-00	5 1/4	1 1/8	—	8.1	725-36-40	7 1/4	1 1/8	1 1/4	12.8					
525-48-40	5 1/4	1 1/2	1 1/4	8.7	725-94-40	7 1/4	2 1/8	1 1/4	33.3					
525-48-48	5 1/4	1 1/2	1 1/2	8.7	750-24-48	7 1/2	3/4	1 1/2	9.0					
525-62-32	5 1/4	1 1/8	1	11.5	750-44-48	7 1/2	1 1/8	1 1/2	16.5					
525-72-32	5 1/4	2 1/4	1	13.3	750-50-48	7 1/2	1 1/8	1 1/2	18.8					
550-34-00	5 1/2	1 1/8	—	7.2	750-58-48	7 1/2	1 1/8	1 1/2	21.8					
550-44-40	5 1/2	1 1/8	1 1/4	8.6	750-66-48	7 1/2	2 1/8	1 1/2	24.8					
550-44-48	5 1/2	1 1/8	1 1/2	8.6	750-68-48	7 1/2	2 1/8	1 1/2	25.5					

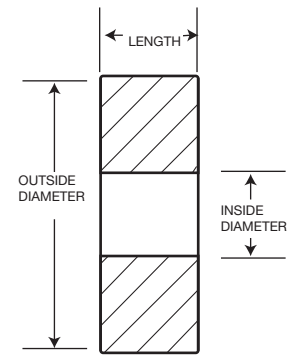

Custom Capabilities Forgings & Castings



Forgings

Know how garnered through decades provides unsurpassed benefit for the industrial user of custom forgings. This includes all phases in the forging process - die design and engineering, forging, coining, heat treating, and polishing.

Hammers ranging in size from 1,000 to 5,000 pounds produce finished parts from a few ounces to 50 pounds. Various alloys, the use of multi-cavity dies, expansive capacity, and secondary machining capability enable *Martin* to deliver near 100% density requirements in a cost effective manner.

Application: Counter weight on unit handling equipment.

Problem: Parts were being milled in-house from purchased burned plate. Process was expensive, but low volumes had prevented consideration of alternate methods of manufacture.

Solution: Instead of utilizing their expensive CNC milling equipment on relatively low-tech part, *Martin* designed a simple die for a forged part, which worked well for medium quantity production runs. When compared to sourcing costs, production time, and scrap, the forged part was less expensive than the milled part. The real savings has resulted from the enhanced utilization of the CNC milling equipment for other, more profitable work.



One of the many hammers capable of producing forgings up to 50 lbs.



Castings

Operating its own foundry enables *Martin* to provide its customers with quality assurance, quick lead times, and application engineering assistance on cast and ductile iron parts.

With an upper range of 96" in diameter and 10,000 pounds, our own pattern shop, and streamlined access to secondary machining, *Martin's* comprehensive capabilities serve a broad spectrum of industrial uses.

Application: Conveyor.

Problem: Redesign of equipment required flywheel and synchronous drive to be used in more compact area. The two separate components had clearance problems.

Solution: *Martin* designed a one piece casting which allowed machining of a duplex drive to fit in tight area. Equipment is more compact, one final part rather than two saves costs, and installation time is reduced.



Sintered Metal

Commonly associated with large quantity runs of fairly simple products, the sintered metal process also effectively addresses small quantities for many complex and multi-level parts where intricate machining or milling was required. Smooth surface finishes, self-lubrication, and tolerance repeatability are just a few of the attributes resulting from this technology. Using a wide range of alloys, *Martin* produces custom sintered parts for many industries and applications.

Application: Timing plate on an agricultural implement.

Problem: Production of parts required several steps. Purchase of disc blanks . . . Initial rough machining . . . Drilling holes . . . Milling slots and teeth . . . Application of rust inhibitor . . . Use of several outside sources.

All these factors led to inconsistent tolerances, difficulty in coordination of lead times, scrapped parts and production interruptions.

Solution: *Martin* reviewed sample parts and prints. *Martin* met with OEM engineering and service personnel to better understand the application. The *Martin* sintered component reduced the total cost of each part by an average of 54%, slashed acquisition costs and allowed for deliveries using staged release dates.



Sintered metal is an excellent choice for a wide variety of products especially those with irregular shapes that would be difficult to manufacture using conventional methods.



Presses delivering more than 880 tons of pressure form parts from bronze, iron, copper, manganese, etc.

Custom Capabilities Injection Molding



One of the many injection molding machines used to manufacture a variety of products.



Martin manufactures plastic products for both power transmission and non-power transmission applications.

Injection Molding

Since the inception of our line of injection molded plastic components, *Martin* has emerged as a leading supplier of cost effective non-metallic products.

A combination of polymers are used to achieve desired wear, corrosion resistance, and color characteristics. Injection molded plastic is also advantageous in non-sparking and sanitary applications.

While the final form of most components is achieved directly from the press, *Martin* is able to perform secondary machining on molded parts if necessary.

Application: Packaging equipment.

Problem: A sticky product required cleaning with a caustic solution which led to corrosion based fatigue of a threaded collar. In addition, high maintenance costs in the field were encountered due to difficulty of replacing the seized collar.

Solution: A *Martin* manufactured part made of glass filled nylon was produced. The *Martin* part withstood constant exposure to the caustic solution and prevented the seizing of threads which provided a longer part life. Unit price was reduced by approximately 34%, warranty claims dropped significantly and the user logo stamped on the part aided in capturing replacement part sales.

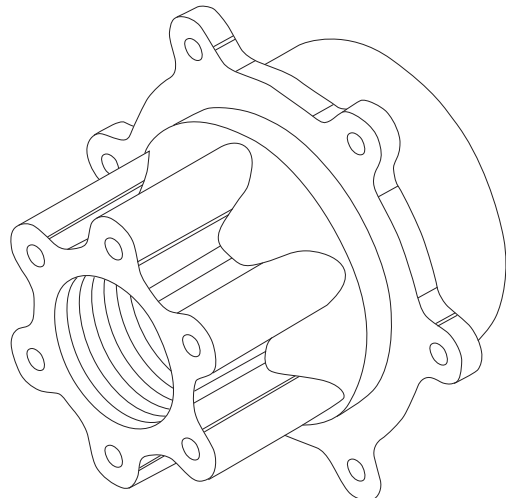

INTERCHANGEABLE BUSHINGS

PRODUCT	PAGE
INDEX	B-1
QD	
Installation/Removal	B-2
Steel Bushings	B-3
Standard Bushings	B-4
Weld-On Hubs	B-5
QD Short Bushings	B-6
TAPER BUSHINGS	
Installation/Removal	B-7
1008 — 3030	B-8
3535 — 5050	B-9
6050 — 120100	B-10
Weld-On Hubs	B-11
Reborable Bushings	B-12
MST® BUSHINGS	
Bushing Specifications	B-13
Installation & Removal	B-14
Weld-On Hubs	B-15
IDLER BUSHINGS; QD, MST®	B-16

Stock QD Bushings



Martin MOUNTING PROCEDURE – QD BUSHINGS

IMPORTANT – BE SURE TAPERED CONE SURFACES OF QD BUSHING AND INSIDE OF SHEAVE OR SPROCKET HUB ARE DRY AND FREE OF ALL FOREIGN SUBSTANCES SUCH AS PAINT, GREASE, OR DIRT.

STANDARD Mounting Assembly FOR QD SHEAVES AND SPROCKETS

MOUNTING

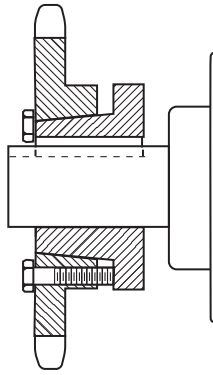

1. Be sure the tapered cone surfaces of the bushing and the inside of the driven product are clean and free of anti-seize lubricants.
 2. Slide QD bushing on shaft, flange end first. Assemble key.
 3. Position QD bushing on shaft. Tighten set screw over key "hand tight" with standard Allen wrench only. Do not use excessive force.
 4. Slide large end of sheave or sprocket taper bore into position over cone aligning drilled bolt holes in sheave or sprocket with tapped holes in flange of bushing. Assemble pull-up bolts and lock washers.
- NOTE:** Install M thru S bushings in the hub so that the two extra holes in the hub are located as far as possible from the bushing's saw cut.
5. Tighten pull-up bolts alternately and evenly to tightness indicated in torque table on back. Do not use extensions on wrench handles. There should be a gap between the face of the sheave or sprocket hub and the flange of the QD bushing to insure a satisfactory cone grip and press fit.

CAUTION: THIS GAP MUST NOT BE CLOSED.

DISMOUNTING

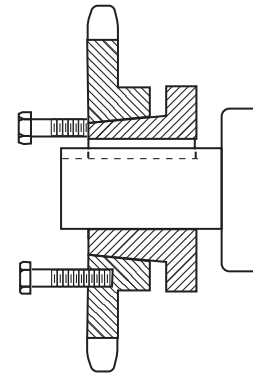

1. Remove pull-up bolts and screw them into TAPPED holes in sheave or sprocket and against flange of QD bushing to break cone grip.
2. Loosen set screw and slide QD bushing from shaft.

WARNING: Because of the possible danger to person(s) or property from accidents which may result from the improper use of products, it is important that correct procedures be followed: Products must be used in accordance with the engineering information specified in the catalog. Proper installation, maintenance and operation procedures must be observed. The instructions given above must be followed. Inspections should be made as necessary to assure safe operation under prevailing conditions. All rotating power transmission products when used in a drive are potentially dangerous and must be guarded by the user as required by applicable laws, regulations, standards, and good safety practice. (Refer to ANSI Standard B15.1.)

REVERSE Mounting Assembly

FOR QD SHEAVES AND SPROCKETS USING JA, SH, SD, SDS, SK, SF, E, F, & J BUSHINGS

These bushings, as well as the sprockets and sheaves for them, are each drilled with six holes (three drilled and three tapped) to allow pull-up bolts to be inserted from either side. This enables variations of mounting characteristics to suit a particular installation.

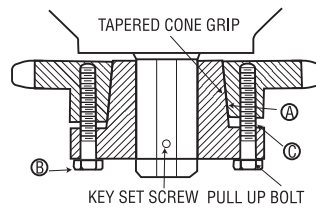
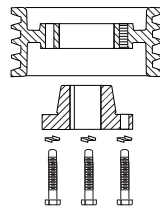
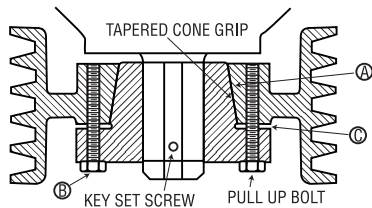

1. Be sure the tapered cone surfaces of the bushing and the inside of the driven product are clean and free of anti-seize lubricants.
2. Assemble sheave or sprocket with bolts inserted (But not tightened) through DRILLED holes in bushing flange into TAPPED holes in sheave, sprocket, or other *Martin* QD part.
3. With key in shaft keyseat, slide assembly into approximate position on shaft with flange end of bushing away from bearing.
4. Position QD bushing on shaft by tightening set screw over key "hand tight" with standard Allen wrench only. Do not use excessive force.
5. Tighten pull-up bolts alternately and evenly to tightness indicated in torque table below. Do not use extensions on wrench handles. There should be a gap between the face of the sheave or sprocket hub and the flange of the QD bushing to insure a satisfactory cone grip and press fit. CAUTION: THIS GAP MUST NOT BE CLOSED.

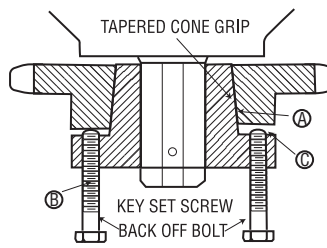
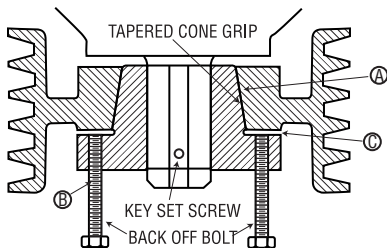

1. Remove pull-up bolts and screw them into TAPPED holes in bushing flange and against hub of sheave or sprocket to break cone grip.
2. Loosen set screw in bushing flange and slide QD bushing from shaft.



WARNING: USE OF ANTI-SEIZE LUBRICANT ON TAPERED CONE SURFACES OR ON BOLT THREADS WHEN MOUNTING MAY RESULT IN DAMAGE TO SHEAVES AND SPROCKETS. THIS VOIDS ALL MANUFACTURER'S WARRANTIES.

BOLT TORQUE TABLE		
QD Bushing Size	Size of Cap Screw	Wrench Torque in. / lbs.
JA	10 - 24	60
SH, SDS, SD	1/4 - 20	108
SK	5/16 - 18	180
SF	3/8 - 16	360
E	1/2 - 13	720
F	9/16 - 12	900
J	5/8 - 11	1620
M	3/4 - 10	2700
N	7/8 - 9	3600
P	1 - 8	5400
W	1-1/8 - 7	7200
S	1-1/4 - 7	9000

★F = Length of Mating Bore

★★G = Gap Between QD Bushing and Mating Hub

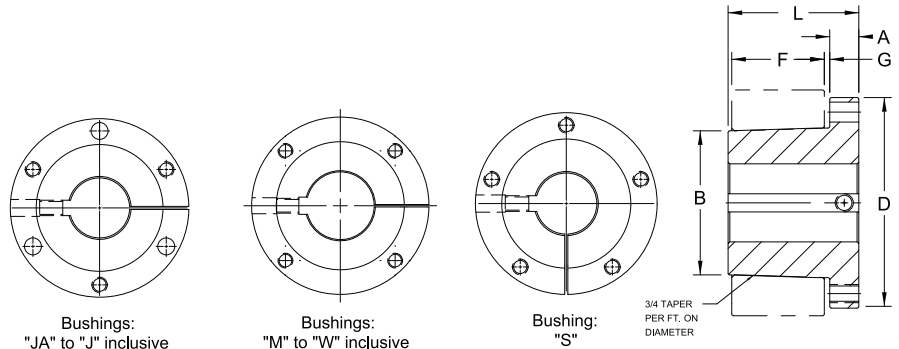

QD Bushings — Steel

Bushing	Dimensions (Inches)								Screws Required	Stock Bore Range			Average Weight (Approx.)
	A	B	D	E	F	G	L	Cap Bolt Circle		Maximum			
										Minimum	Standard Keyway	Shallow Keyway	
SF-STL	5/16	3.125	4 1/2	1 1/2	1 1/4	1/8	2 1/16	3	3 1/2 x 2	1/2	2 1/8	2 1/8	3.0
E-STL	3/8	3.834	6	1 1/2	1 1/8	1/8	2 1/2	5	3 1/2 x 2 1/4	3/4	2 1/8	3 1/2	10.0
F-STL	1/2	4.437	6 1/2	2 1/16	2 1/2	3/16	3	5	3 3/8 x 3 3/8	1	3 3/8	4	11.5
J-STL	1	5.148	7 1/2	3 1/2	3 3/8	3/8	4 1/2	6 1/4	3 3/4 x 4 1/2	1 1/8	3 3/4	4 1/2	18.0
M-STL	1 1/4	6.500	9	5 1/2	5 3/8	1/2	6 1/2	7 1/2	4 1/2 x 6 1/2	2	4 1/2	5 1/2	37.0
N-STL	1 1/2	7.000	10	6 1/2	6 3/4	7/8	8 1/2	8 1/2	4 1/2 x 8 1/2	2 1/2	5 1/2	5 1/2	57.0

Bushing	Bores	Keyway
SF-STL	2 1/8 - 2 1/16	5/8 x 3/16
	2 1/8 - 2 1/8	5/8 x 1/8
	2 1/8 - 2 1/8	5/8 x 1/8
	2 1/8	5/8 x 1/8
E-STL	3/8 - 2 1/8	STD.
	2 1/16 - 3 1/4	5/8 x 1/8
	3 1/8 - 3 1/2	5/8 x 1/8
F-STL	1 - 3 1/8	STD.
	3 3/8 - 3 3/4	5/8 x 3/16
	3 3/8 - 3 1/16	1 x 1/8
	4	NONE
J-STL	3 1/8 - 3 3/4	STD.
	3 3/8 - 4 1/2	1 x 1/8
M-STL	2 - 4 1/4	STD.
	4 1/8 - 5 1/2	1 1/4 x 1/4
N-STL	2 1/2 - 5 1/8	STD.
	5 3/8 - 5 1/2	1 1/4 x 1/4
	5 3/8 - 5 1/8	1 1/2 x 1/4

Shallow Key Dimension — Standard			
Key Seat	Key	Keyway	Key
1/4 x 1/32	1/4 x 3/32	3/4 x 1/8	3/4 x 1/8
1/4 x 1/16	1/4 x 3/16	7/8 x 1/8	7/8 x 1/8
3/8 x 1/32	3/8 x 1/32	1 1/8 x 3/16	1 1/8 x 3/16
3/8 x 1/16	3/8 x 1/4	1 x 1/8	1 x 3/8
3/8 x 1/8	3/8 x 3/16	1 1/4 x 1/4	1 1/4 x 3/8
1/2 x 1/32	1/2 x 1/32	1 1/2 x 1/8	1 1/2 x 1/8
1/2 x 1/16	1/2 x 3/16	1 1/2 x 1/4	1 1/2 x 1
1/2 x 1/8	1/2 x 3/8	1 3/4 x 1/8	1 3/4 x 3/8
5/8 x 1/16	5/8 x 3/8	1 3/4 x 1/4	1 3/4 x 1/8
3/4 x 1/8	3/4 x 7/8	2 x 1/4	2 x 1

Standard Keyway and Key Dimension		
Bores	Keyway	Key
1/8	3/16 x 3/32	3/16 x 3/16
1/8 - 1 1/4	1/4 x 1/8	1/4 x 1/4
1 1/8 - 1 1/8	5/16 x 5/32	5/16 x 5/16
1 1/8 - 1 1/8	3/8 x 3/8	3/8 x 3/8
1 1/8 - 2 1/4	1/2 x 1/4	1/2 x 1/2
2 1/8 - 2 1/4	5/8 x 5/8	5/8 x 5/8
2 1/8 - 3 3/4	3/4 x 3/8	3/4 x 3/4
3 3/8 - 3 3/4	7/8 x 7/8	7/8 x 7/8
3 3/8 - 4 1/2	1 x 1/2	1 x 1
4 1/8 - 5 1/2	1 1/4 x 3/8	1 1/4 x 1 1/4
5 1/8 - 6 1/2	1 1/2 x 3/4	1 1/2 x 1 1/2
6 1/8 - 7 1/2	1 3/4 x 3/4	1 3/4 x 1 1/2
7 1/8 - 9	2 x 3/4	2 1/2 x 1 1/2
9 1/8 - 11	2 1/2 x 7/8	--
11 1/8 - 13	3 x 1	--

Shallow Key Dimension — Steel			
Key Seat	Key	Keyway	Key
1/4 x 1/32	1/4 x 3/32	3/4 x 1/16	3/4 x 7/16
1/4 x 1/16	1/4 x 3/16	3/4 x 1/8	3/4 x 1/2
3/8 x 1/32	3/8 x 1/32	7/8 x 1/16	7/8 x 1/2
3/8 x 1/16	3/8 x 1/4	7/8 x 3/16	7/8 x 3/8
3/8 x 1/8	3/8 x 3/16	1 x 1/8	1 x 3/8
1/2 x 1/32	1/2 x 1/32	1 1/4 x 1/4	1 1/4 x 1/8
1/2 x 1/16	1/2 x 3/16	1 1/2 x 1/4	1 1/2 x 1
1/2 x 1/8	1/2 x 3/8	1 3/4 x 1/8	1 3/4 x 3/4
5/8 x 1/16	5/8 x 3/8	1 3/4 x 3/8	1 3/4 x 1
3/4 x 3/16	3/4 x 1/2	2 x 1/4	2 x 1

Bushing	Plain Bores Not Split
SH-STL	1/2
SD-STL	1/2
SK-STL	1/2
SF-STL	1 1/8
E-STL	7/8 - 1 1/8
F-STL	1 - 2 1/8 - 2 1/16
J-STL	1 1/8 - 2 1/8
M-STL	2 - 2 1/8
N-STL	2 1/8 - 4 1/8

Reborable QD bushings made of Stainless Steel are available in many sizes. Non stock sizes are available on MTO basis.

Standard QD Bushings



Bushing	Dimensions (Inches)								Cap Screws Required	Stock Bore Range			Set Screw Size	Average Weight (Approx.)
	A	B	D	E	F	G	L	Bolt Circle		Maximum				
										Minimum	Standard Keyway	Shallow Keyway		
JA	3/8	1.375	2	1/16	3/16	1/8	1 1/16	1.665	3-10 x 1	3/8	1	1 1/4	10-24	.9
SH	7/16	1.871	2 1/16	7/16	1/8	1/8	1 1/8	2 1/4	3-1/4 x 1 1/2	1/2	1 1/8	1 11/16	1/4	1
SDS	1/2	2.187	3 3/16	7/8	3/4	1/8	1 1/2	2 1/16	3-3/4 x 1 3/4	1/2	1 1/16	2	1/4	1
SD	1/2	2.187	3 3/16	1 1/16	1 1/4	1/8	1 3/16	2 1/16	3-1/4 x 1 1/2	1/2	1 1/16	1 5/16	1/4	1.5
SK	3/8	2.812	3 3/8	1 1/4	1 1/4	1/8	1 5/16	3 3/8	3-3/8 x 2	1/2	2 1/8	2 1/2	5/16	2
SF	3/8	3.125	4 1/8	1 1/2	1 1/4	1/8	2 1/16	3 1/8	3-3/8 x 2	1/2	2 3/16	2 3/16	5/16	3
E	3/4	3.834	6	1 1/2	1 1/2	1/8	2 3/8	5	3-1/2 x 2 3/4	3/4	2 1/8	3 1/2	3/8	10
F	1/2	4.437	6 3/8	2 1/16	2 1/2	3/16	3 3/8	5 3/8	3-3/8 x 3 3/8	1	3 3/16	3 5/16	1/2	11.5
J	1	5.148	7 1/4	3 1/2	3 3/8	3/16	4 1/2	6 1/4	3-5/8 x 4 1/2	1 1/16	3 3/4	4 1/2	3/8	18
M	1 1/4	6.500	9	5 1/2	5 3/8	3/16	6 3/4	7 3/8	4-3/4 x 6 3/4	1 5/16	4 3/4	5 1/2	3/4	37
N	1 1/2	7.000	10 1/4	6 3/8	6 1/4	1/4	8 1/8	8 3/8	4-7/8 x 8 1/2	2 1/16	5 3/8	6	3/4	57
P	1 3/4	8.250	11 3/4	7 3/8	7 1/4	1/4	9 3/8	10	4-1 x 9 1/2	2 5/16	5 5/16	7	3/8	120
W	2	10.437	15	9 3/8	9	1/4	11 3/8	12 3/4	4-1 1/8 x 11 1/2	4	7 1/2	8 1/2	1	250
S	3 3/4	12.125	17 3/4	12 1/2	12	3/8	15 3/4	15	5-1 1/4 x 15 1/2	6	8 3/4	10	1 1/4	400

Inch Bore

Bushing	Bores	Keyway
JA	3/8 - 7/16 1/2 - 1 1 1/16 - 1 1/8 1 3/16 1 1/4	NO K.W. STD. 1/4 x 1/16 1/4 x 1/16 NO K.W.
SH	1/2 - 1 1/8 1 1/16 - 1 1/2 1 1/16 - 1 1/8 1 1/16	STD 3/8 x 1/16 3/8 x 1/16 NO K.W.
SDS	1/2 - 1 1/16 1 1/4 1 1/16 1 1/8 - 1 3/16 2	STD. 3/8 x 1/8 1/2 x 1/8 1/2 x 1/16 NO K.W.
SD	1/2 - 1 1/16 1 1/4 1 1/16 1 1/8 1 3/16 2	STD. 3/8 x 1/8 1/2 x 1/8 1/2 x 1/16 1/2 x 1/16 NO K.W.
SK	1/2 - 2 1/8 2 3/16 - 2 1/4 2 1/16 - 2 1/2 2 3/16 - 2 3/8	STD. 1/2 x 1/8 3/8 x 1/16 NO K.W.
SF	1/2 - 2 1/4 2 3/16 - 2 1/2 2 3/16 - 2 3/4 2 3/16 - 2 3/8 2 3/16	STD. 3/8 x 3/16 3/8 x 1/16 3/4 x 1/16 3/4 x 1/16
E	3/8 - 2 3/8 2 1/16 - 3 1/4 3 3/8 - 3 1/2 3 3/16	STD. 3/8 x 1/8 1/2 x 1/16 1/2 x 1/8
F	1 - 3 3/16 3 3/8 - 3 3/4 3 3/8 - 3 13/16 4	STD. 1/2 x 3/16 1 x 1/8 NONE
J	1 1/4 - 3 3/4 3 3/16 - 4 1/2	STD. 1 x 1/8
M	2 - 4 3/4 4 3/16 - 5 1/2	STD. 1 1/4 x 1/4
N	2 1/16 - 5 5 3/8 - 5 1/2 5 3/16 - 6	STD. 1 1/4 x 1/4 1 1/2 x 1/4
P	2 15/16 - 5 15/16 6 - 6 1/2 6 3/16 - 7	STD. 1 1/2 x 1/4 1 3/4 x 1/4
W	4 - 7 1/2 7 3/16 - 8 1/2	STD. 2 x 1/4

Millimeter Bore

Bushing	Bore MM	Key* WXT
SH	24, 25 28, 30 32, 35	8x7 10x8
SDS	24, 25 28, 30 32, 35 38 40, 42	8x7 10x8 12x8
SD	24, 25 28, 30 32, 35 38 40, 42	8x7 10x8 12x8
SK	24, 25 28, 30 32, 35 38 40, 42 48, 50 55	8x7 10x8 12x8 14x9 16x10
SF	28, 30 32, 35 38 40, 42 48, 50 55 60	8x7 10x8 12x8 14x9 16x10 18x11
E	35, 38 40, 42 48, 50 55 60, 65 70, 75	10x8 12x8 14x9 16x10 18x11 20x12
F	48, 50 55 60, 65 70, 75 80, 85 90	14x9 16x10 18x11 20x12 22x14 25x14
J	50 55 60, 65 70, 75 80, 85 90, 95 100	14x9 16x10 18x11 20x12 22x14 25x14 28x16

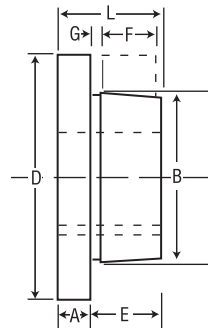

★Important — The metric system does not refer to keyseat or keyway dimensions as does the English system; instead dimensions are given for the key itself which is rectangular in shape, not square as in the English system.

NOTE: .03937"=1mm
Ex—24 mm = 0.94488"

TO ORDER:
SH 24 mm

Keystock provided for nonstandard keyways.

QD Weld-On Hubs

Martin QD Weld-On Hubs are suitable for use in many applications, such as welding to plate steel sprockets.

QD Weld-On Hubs are made of steel, drilled, tapped and taper bored for QD bushings

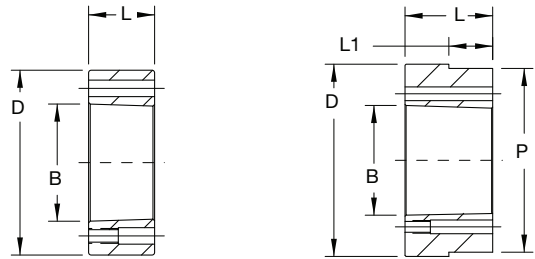
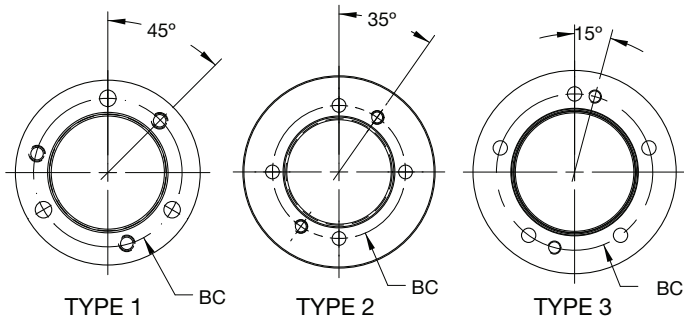

Catalog Number	Dimensions — Inches						Type Drilling	Weight Pounds	Mounting
	D*	L	B (nom)	P	L1	BC			
JA-A	2.250	5/16	1.37	2.125	3/16	1 1/2	1	.4	STD or Reverse Mount
SH-A	3.000	19/16	1.87	—	—	2 1/4	1	1	
SDS-A	3.500	3/4	2.18	—	—	2 1/16	1	1.2	
SK-A	4.375	1 1/4	2.81	—	—	3 3/8	1	3	
SF-A	5.000	1 1/4	3.12	—	—	3 3/4	1	4	
E-A	6.250	1 1/2	3.83	—	—	5	1	9	STD Mount Only
F-A	7.000	2 1/2	4.44	—	—	5 5/8	1	16	
J-A	7.750	3 3/8	5.14	—	—	6 1/4	1	22.5	
M-A	9.500	5 3/8	6.49	9.250	3 3/8	7 7/8	2	50	
N-A	10.500	6 1/4	6.99	10.250	4 1/2	8 7/8	2	75	
P-A	13.000	7 3/4	8.24	—	—	10	2	155	STD Mount Only
W-A	15.500	9	10.43	—	—	12 1/2	2	300	
S-A	19.500	12	12.12	18.750	7 1/2	15	3	558	

★Tolerance of D Dimension (or P dimension where applicable)

JA-A Thru J-A = (+.000-.002)

M-A Thru S-A = (+.000-.003)

QD Short Weld-On Hubs

Martin QD Short Weld-On Hubs are designed for use in conveyor pulleys.

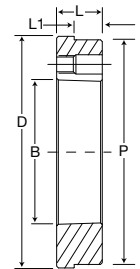
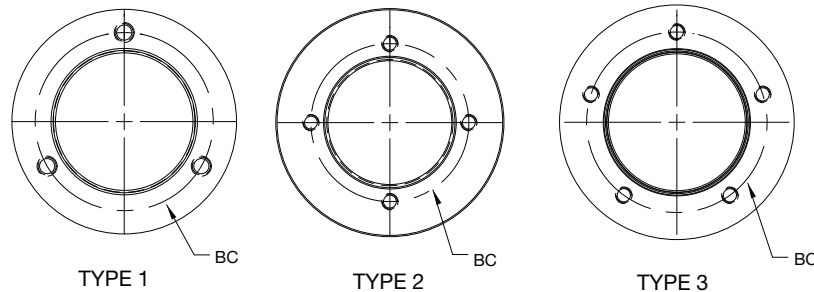

Catalog Number	Dimensions — Inches						Type Drilling	Weight Pounds	Mounting
	D	L	B (nom)	P*	L1	BC			
SFS-A	5.000	1	3.12	4.750	3/16	3 3/8	1	3.0	Reverse Mount Only
ES-A	6.250	1 1/2	3.83	6.000	5/8	5	1	5.5	
FS-A	7.000	1 1/4	4.44	6.750	1 1/16	5 5/8	1	7.4	
JS-A	8.250	1 1/2	5.14	8.000	1	6 1/4	1	13.8	
MS-A	9.500	2 1/2	6.49	9.250	1 1/8	7 7/8	2	22.9	
NS-A	10.250	2 3/4	6.99	10.000	1 1/16	8 1/2	2	26.8	
PS-A	12.250	2 3/4	8.24	12.000	2	10	2	47.9	
WS-A	15.250	3 3/4	10.43	14.875	2 7/16	12 1/4	2	84.2	
SS-A	17.500	3 3/4	12.12	17.000	2 3/4	15	3	121.8	

★Tolerance of P Dimension

SFS-A Thru MS-A = (+.000-.004)

NS-A Thru PS-A = (+.000-.005)

WS-A Thru SS-A = (+.000-.006)

QD Short Bushings

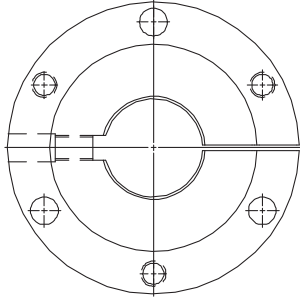

Bushings:
JS

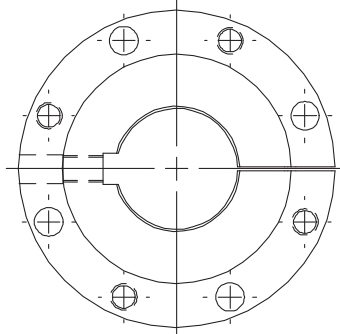

Bushings:
MS TO WS inclusive

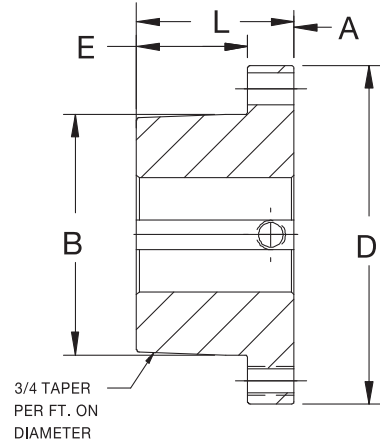

Inch Bore

Bushing	Bores	Keyway	Weight
JS	2 ⁷ / ₁₆	5/8 x 5/16	19
	2 ¹⁵ / ₁₆	3/4 x 3/8	17
	3 ¹ / ₁₆		15
	3 ¹ / ₂	7/8 x 7/16	15
	3 ¹⁵ / ₁₆	1 x 1/2	13
MS	4 ¹ / ₁₆		10
	3 ⁷ / ₁₆	7/8 x 7/16	38
	3 ¹ / ₂		37
	3 ¹⁵ / ₁₆	1 x 1/2	34
	4 ¹ / ₁₆		30
	4 ¹⁵ / ₁₆	1 1/4 x 1/4	26
NS	5 ¹ / ₁₆		21
	5 ¹ / ₂	1 1/2 x 1/4	20
	3 ¹⁵ / ₁₆	1 x 1/2	54
	4 ¹ / ₁₆		49
	4 ¹⁵ / ₁₆	1 1/4 x 3/8	43
	5 ⁷ / ₁₆	1 1/4 x 1/4	38
PS	5 ¹ / ₂		37
	5 ¹⁵ / ₁₆	1 1/2 x 1/4	31
	6		30
	4 ¹⁵ / ₁₆	1 1/4 x 3/8	76
	5 ¹ / ₁₆	1 1/4 x 3/8	70
	5 ¹⁵ / ₁₆	1 1/2 x 3/4	62
WS	6		62
	6 ¹ / ₁₆	1 1/2 x 1/4	55
	6 ¹ / ₂		54
	6 ¹⁵ / ₁₆	1 1/4 x 1/8	47
	7	1 1/4 x 1/8	45
	7 ¹ / ₁₆	1 1/4 x 5/8	154
WS	5 ¹⁵ / ₁₆		145
	6	1 1/2 x 3/4	144
	6 ¹ / ₁₆		136
	6 ¹ / ₂		135
	6 ¹⁵ / ₁₆		126
	7	1 3/4 x 3/4	125
	7 ¹ / ₂		114
	7 ¹⁵ / ₁₆		106
	8	2 x 1/4	105
	8 ¹ / ₁₆		94
8 ¹ / ₂		93	



Martin QD Short Bushings are suitable for use in belt conveyor applications wherever the short hubs of a conveyor pulley require the QD Short Bushing style.

Dimensions

Bushing	Dimensions (Inches)						Cap Screws Required	Set Screw Size
	A	B	D	E	L	Bolt Circle		
JS	1.00	5.1484	7.25	2.38	3.38	6.25	5/8 x 2 1/2 (3)	5/8
MS	1.19	6.5000	9.00	3.62	4.81	7.88	3/4 x 3 (4)	3/4
NS	1.50	7.0000	10.00	4.50	6.00	8.50	7/8 x 3 1/2 (4)	7/8
PS	1.50	8.2500	11.75	5.00	6.50	10.00	1 x 4 (4)	7/8
WS	1.75	10.4370	15.00	5.50	7.25	12.75	1 1/2 x 5 (4)	1

All dimensions are in inches, weight in pounds.

IMPORTANT NOTE: Please follow the instructions on this sheet in order for the *Martin* bushing to perform satisfactorily.

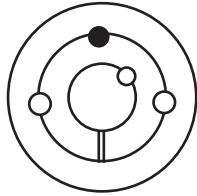

1008 to 3030

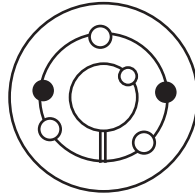

3535 to 6050

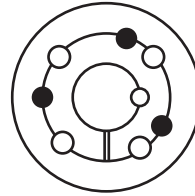

7060 to 10085

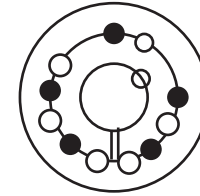

102100

INSTALLATION

1. Clean all oil, dirt, and paint from shaft, bushing bore, outside of bushing and component (sprocket, sheave...etc.) bore.
2. Insert bushing into component. Match the hole pattern, not the threaded holes (each hole will be threaded on one side only.)
3. Thread set or cap screws into those half threaded holes indicated by ○ on above diagram. Mount assembly on shaft.
4. Alternately torque set or cap screws* to recommended torque setting in chart below.
5. On 3535 and larger bushings use a block, sleeve or drift and hammer large end of bushing (do not hammer bushing directly).
6. Repeat steps 4 and 5 until torque wrench reading, after hammering, is the same as before hammering.
7. Fill all unoccupied holes with grease.

REMOVAL

1. Remove all set or cap screws.
2. Insert set or cap screws in holes indicated by ● on drawing. Loosen bushing by alternately tightening set or cap screws.
3. To reinstall, complete all seven (7) installation instructions.

RECOMMENDED TORQUE TABLE

Bushing No.	Set or Cap Screw	Wrench Torque in. / lbs.
1008, 1108	1/4 - 20 Socket Set Screw	55
1210, 1215, 1310	3/8 - 16 Socket Set Screw	175
1610, 1615	3/8 - 16 Socket Set Screw	175
2012	7/16 - 14 Socket Set Screw	280
2517, 2525	1/2 - 13 Socket Set Screw	430
3020, 3030	5/8 - 11 Socket Set Screw	800
3535	1/2 - 13 Socket Head Cap Screw	1,000
4040	5/8 - 11 Socket Head Cap Screw	1,700
4545	3/4 - 10 Socket Head Cap Screw	2,450
5050	7/8 - 9 Socket Head Cap Screw	3,100
6050, 7060, 8065	1-1/4 - 7 Socket Head Cap Screw	7,820
10085, 120100	1 - 1/2 - 6 Socket Head Cap Screw	13,700

* If two bushings are used on same component and shaft, fully tighten one bushing before working on the other.

CAUTION

WARNING: USE OF ANTI-SEIZE LUBRICANT ON TAPERED CONE SURFACES OR ON BOLT THREADS WHEN MOUNTING MAY RESULT IN DAMAGE TO SHEAVES AND SPROCKETS. THIS VOIDS ALL MANUFACTURER'S WARRANTIES.

WARNING: Because of the possible danger to person(s) or property from accidents which may result from the improper use of products, it is important that correct procedures be followed: Products must be used in accordance with the engineering information specified in the catalog. Proper installation, maintenance and operation procedures must be observed. The instructions given above must be followed. Inspections should be made as necessary to assure safe operation under prevailing conditions. All rotating power transmission products when used in a drive are potentially dangerous and must be guarded by the user as required by applicable laws, regulations, standards, and good safety practice. (Refer to ANSI Standard B15.1.)

Taper Bushings Dimensions

BUSHINGS

No. 1008 to 3030 Taper Bushings

Bushing Number	Bore	Wt.	Bushing Keyseat	Shaft Keyseat
1008	1/2 to 5/16	.27	1/8 x 1/16	1/8 x 1/16
	5/16 to 1/2	.21	3/16 x 3/32	3/16 x 3/32
	1/2 to 1	.16	1/4 x 1/8	1/4 x 1/8
1108	1/2 to 5/16	.33	1/8 x 1/16	1/8 x 1/16
	5/16 to 1/2	.27	3/16 x 3/32	3/16 x 3/32
	1/2 to 1	.22	1/4 x 1/8	1/4 x 1/8
1210	1/2 to 5/16	.61	1/8 x 1/16	1/8 x 1/16
	5/16 to 1/2	.55	3/16 x 3/32	3/16 x 3/32
	1/2 to 1	.49	1/4 x 1/8	1/4 x 1/8
1215	1/2 to 5/16	.8	1/8 x 1/16	1/8 x 1/16
	5/16 to 1/2	.7	3/16 x 3/32	3/16 x 3/32
	1/2 to 1	.6	1/4 x 1/8	1/4 x 1/8
1310	1/2 to 5/16	.7	1/8 x 1/16	1/8 x 1/16
	5/16 to 1/2	.7	3/16 x 3/32	3/16 x 3/32
	1/2 to 1	.6	1/4 x 1/8	1/4 x 1/8
1610	1/2 to 5/16	.9	1/8 x 1/16	1/8 x 1/16
	5/16 to 1/2	.8	3/16 x 3/32	3/16 x 3/32
	1/2 to 1	.7	1/4 x 1/8	1/4 x 1/8
1615	1/2 to 5/16	.9	1/8 x 1/16	1/8 x 1/16
	5/16 to 1/2	.8	3/16 x 3/32	3/16 x 3/32
	1/2 to 1	.7	1/4 x 1/8	1/4 x 1/8
2012	1/2 to 5/16	1.2	1/8 x 1/16	1/8 x 1/16
	5/16 to 1/2	1.1	3/16 x 3/32	3/16 x 3/32
	1/2 to 1	1.0	1/4 x 1/8	1/4 x 1/8
2517	1/2 to 5/16	3.5	1/8 x 1/16	1/8 x 1/16
	5/16 to 1/2	3.4	3/16 x 3/32	3/16 x 3/32
	1/2 to 1	3.3	1/4 x 1/8	1/4 x 1/8
2525	1/2 to 5/16	4.9	3/16 x 3/32	3/16 x 3/32
	5/16 to 1/2	4.7	1/4 x 1/8	1/4 x 1/8
	1/2 to 1	4.5	3/16 x 5/32	3/16 x 5/32
3020	1/2 to 5/16	6.5	1/4 x 1/8	1/4 x 1/8
	5/16 to 1/2	6.3	3/16 x 5/32	3/16 x 5/32
	1/2 to 1	6.0	3/16 x 3/8	3/16 x 3/8
3030	1/2 to 5/16	9.2	1/4 x 1/8	1/4 x 1/8
	5/16 to 1/2	8.9	3/16 x 5/32	3/16 x 5/32
	1/2 to 1	8.6	3/16 x 3/8	3/16 x 3/8

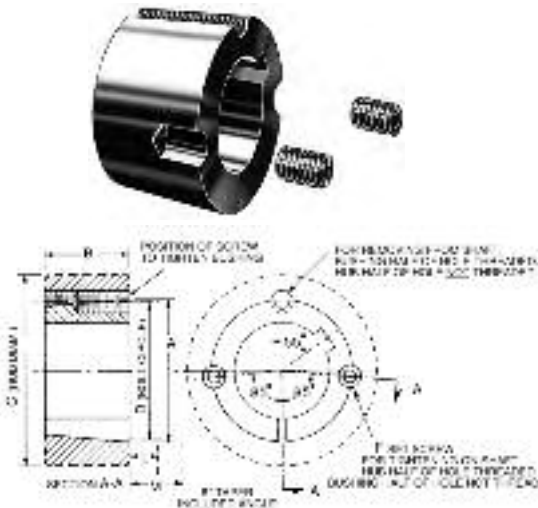

Dimensions

Bushing Number	A	B	CØ			D	F†	L★		M★★	
			Class 20 Gray Iron	Class 30 Gray Iron	Steel			Standard Hex. Key	Short Key‡	Standard Hex. Key	Short Key‡
1008	1.386	7/8	2 3/8	2 3/8	1 1/8	1 3/4	1 1/8	1 1/8	1 1/8	1 1/8	
1108	1.511	7/8	2 1/2	2 3/8	2 1/8	1 3/4	1 1/8	1 1/8	1 1/8	1 1/8	
1210	1 1/8	1	3 3/8	3 3/8	2 3/8	2 1/4	1 1/8	1 1/8	1 1/8	1 1/8	
1215	1 1/8	1 1/2	3 3/8	2 3/8	2 3/8	2 1/4	1 1/8	1 1/8	1 1/8	1 1/8	
1310	2	1	3 3/8	3 3/8	3	2 1/4	1 1/8	1 1/8	1 1/8	1 1/8	
1610	2 1/4	1	4	3 3/8	3 3/8	2 3/4	1 1/8	1 1/8	1 1/8	1 1/8	
1615	2 1/4	1 1/2	3 3/8	3 3/8	3	2 3/4	1 1/8	1 1/8	1 1/8	1 1/8	
2012	2 3/4	1 1/4	4 3/8	4 3/8	3 3/8	3 1/4	1 1/8	1 1/8	2	1 3/8	
2517	3 3/8	1 1/4	5 1/2	4 3/8	4 3/8	3 3/4	1 1/8	1	2 1/4	1 3/8	
2525	3 3/8	2 1/8	4 3/8	4 3/8	4 3/8	3 3/4	1 1/8	1	2 1/4	1 3/8	
3020	4 3/8	2	7	6 3/8	5 3/8	4	1 1/8	1 1/8	2 1/4	2 1/8	
3030	4 3/8	3	6 3/8	5 3/8	5 3/8	4	1 1/8	1 1/8	2 1/4	2 1/8	

Bushings cannot be bored larger than largest bore listed.

For detail dimensions required for machining hubs, consult factory.

Ø Key furnished for these sizes only.

Ø For general reference. Severe conditions may require larger hub. Heavy well-located web may permit smaller hub. Hub diameter required depends on the particular application. Consult *Martin* giving full information on the proposed design. Hub diameters shown are based on 20,000, 30,000, and 50,000 P.S.I. minimum ultimate tensile strength respectively for Class 20 gray iron, Class 30 gray iron, and steel hubs.

† 2 screws required. Use in positions shown for tightening bushing on shaft. In removing bushing from shaft, remove screws and use one of them in the other hole. Bushing price includes screws.

★ Space required to tighten bushing. Also space required to loosen screws to permit removal of hub by puller.

★★ Space required to loosen bushing using one screw as jackscrew — no puller required.

‡ Standard hex key cut to minimum usable length.

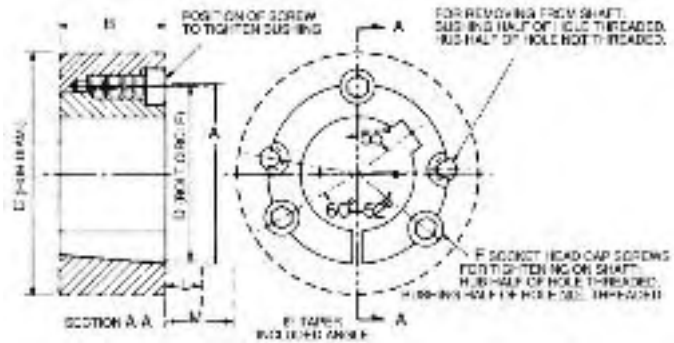

No. 3535 to 5050 Bushings

Bushing Number	Bore	Weight	Bushing Keyseat	Shaft Keyseat	A	B	Ø			D	F†	G	R
							Class 20 Gray Iron	Class 30 Gray Iron	Steel				
3535	1 ¹ / ₁₆ to 1 ¹ / ₄	14	¼ x ¼	¼ x ¼	5	3 ¹ / ₂	7%	7	6%	4.83	½ x 1 ¹ / ₂	39°	▲
	1 ¹ / ₈ to 1 ¹ / ₂	14	5 ¹⁶ / ₁₆ x 5 ¹⁶ / ₁₆	5 ¹⁶ / ₁₆ x 5 ¹⁶ / ₁₆									
	1 ¹ / ₄ to 1 ³ / ₄	13	¾ x ¾	¾ x ¾									
	1 ¹ / ₂ to 2 ¹ / ₄	12	½ x ¼	½ x ¼									
	2 ¹ / ₈ to 2 ¹ / ₂	11	5 ¹⁶ / ₁₆ x 5 ¹⁶ / ₁₆	5 ¹⁶ / ₁₆ x 5 ¹⁶ / ₁₆									
	2 ³ / ₁₆ to 3 ¹ / ₄	9	¾ x ¾	¾ x ¾									
3 ¹ / ₈ to 3 ¹ / ₂	8	Ø1 ¹ / ₁₆ x ¼	¾ x ¾										
4040	1 ¹ / ₈ to 1 ¹ / ₄	22	¾ x ¾	¾ x ¾	5%	4	9%	8%	7%	5.54	¾ x 1 ¹ / ₄	40°	▲
	1 ¹ / ₄ to 2 ¹ / ₄	21	½ x ¼	½ x ¼									
	2 ¹ / ₈ to 2 ¹ / ₂	19	5 ¹⁶ / ₁₆ x 5 ¹⁶ / ₁₆	5 ¹⁶ / ₁₆ x 5 ¹⁶ / ₁₆									
	2 ³ / ₁₆ to 3 ¹ / ₄	17	¾ x ¾	¾ x ¾									
	3 ¹ / ₈ to 3 ³ / ₈	15	¾ x ¾	¾ x ¾									
	3 ¹ / ₄ to 3 ¹ / ₂	14	¾ x ¾	¾ x ¾									
3 ³ / ₈ to 4	13	Ø1 x ¼	1 x ½										
4545	1 ¹ / ₈ to 2 ¹ / ₄	30	½ x ¼	½ x ¼	6%	4 ¹ / ₂	10%	9%	8%	6.13	¾ x 2	40°	▲
	2 ¹ / ₈ to 2 ¹ / ₂	28	5 ¹⁶ / ₁₆ x 5 ¹⁶ / ₁₆	5 ¹⁶ / ₁₆ x 5 ¹⁶ / ₁₆									
	2 ³ / ₁₆ to 3 ¹ / ₄	26	¾ x ¾	¾ x ¾									
	3 ¹ / ₈ to 3 ³ / ₈	23	¾ x ¾	¾ x ¾									
	3 ³ / ₈ to 4 ¹ / ₂	20	1 x ½	1 x ½									
4 ¹ / ₈ to 4 ¹ / ₂	18	Ø1 x ¼	1 x ½										
5050	2 ¹ / ₈ to 2 ¹ / ₂	38	5 ¹⁶ / ₁₆ x 5 ¹⁶ / ₁₆	5 ¹⁶ / ₁₆ x 5 ¹⁶ / ₁₆	7	5	11%	10%	9%	6.72	¾ x 2 ¹ / ₄	37°	▲
	2 ³ / ₁₆ to 3 ¹ / ₄	35	¾ x ¾	¾ x ¾									
	3 ¹ / ₈ to 3 ³ / ₈	32	¾ x ¾	¾ x ¾									
	3 ³ / ₈ to 4 ¹ / ₂	27	1 x ½	1 x ½									
	4 ¹ / ₈ to 5	24	Ø1 ¹ / ₄ x ¾	1 ¹ / ₄ x ¾									

Bushings cannot be bored larger than largest bore listed.

For detail dimensions required for machining hubs, consult factory.

Ø Key furnished for these sizes only.

Ø For general reference. Severe conditions may require larger hub. Heavy well-located web may permit smaller hub. Hub diameter required depends on the particular application. Consult factory giving full information on the proposed design. Hub diameters shown are based on 20,000, 30,000, and 50,000 P.S.I. minimum ultimate tensile strength respectively for Class 20 gray iron, Class 30 gray iron, and steel hubs.

† 3 screws required. Use in positions shown for tightening bushing on shaft. In removing bushing from shaft, remove screws and use two of them in the other two holes. Bushing price includes screws. See following footnote.

▲ Provide sufficient space to tighten and loosen bushing. Width across flats of screw head is same as screw diameter which is shown in column F.

Taper Bushings Dimensions

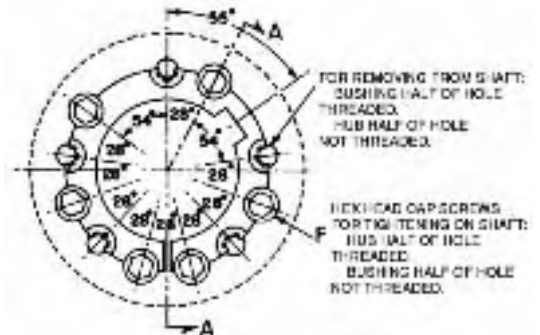

NO. 120100

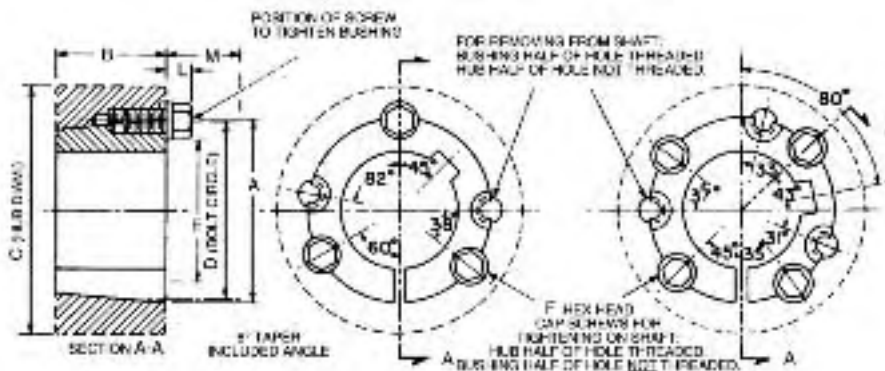

6050

7060 to 10085

No 6050 to 120100 Taper Bushings

Bush Number	Bore	Weight	Bushing Keyseat	Shaft Keyseat	A	B	CØ			D	E	F†	L★	M★★
							Class 20 Gray Iron	Class 30 Gray Iron	Steel					
6050	3 5/8 to 4 1/2	60	1 x 1/2	1 x 1/2	9%	5	17	15 1/2	13 1/2	9	6%	1 1/2 x 3/8	1%	4%
	4 5/8 to 5 1/2	55	1 1/4 x 5/8	1 1/4 x 5/8										
	5 5/8 to 6	50	1 1/2 x 3/4	1 1/2 x 3/4										
7060	4 3/8 to 5 1/2	85	1 1/4 x 5/8	1 1/4 x 5/8	10%	6	18 1/2	17	14%	10	7%	1 1/2 x 3/8	1%	4%
	5 3/8 to 6 1/2	75	1 1/2 x 3/4	1 1/2 x 3/4										
	6 3/8 to 7	65	1 3/4 x 3/4	1 3/4 x 3/4										
Ø8065	5 1/8 to 5 1/2	120	1 1/4 x 5/8	1 1/4 x 5/8	11%	6 1/2	19	17 1/2	15 1/2	11	8%	1 1/2 x 3/8	1%	4%
	5 5/8 to 6 1/2	105	1 1/2 x 3/4	1 1/2 x 3/4										
	6 1/8 to 7 1/2	90	1 3/4 x 3/4	1 3/4 x 3/4										
	7 1/8 to 8	75	2 x 3/4	2 x 3/4										
Ø10085	6 3/8 to 7 1/2	260	1 1/4 x 5/8	1 1/4 x 5/8	14%	8 1/2	23%	22	19 1/2	14%	11%	1 1/2 x 4/8	2	5%
	7 3/8 to 9	230	2 x 3/4	2 x 3/4										
	9 3/8 to 10	190	2 1/2 x 3/4	2 1/2 x 3/4										
Ø120100	7 3/8 to 9	410	2 x 3/4	2 x 3/4	17%	10	28	26	23	17	14%	1 1/2 x 4/8	2	5%
	9 3/8 to 11	360	2 1/2 x 3/4	2 1/2 x 3/4										
	11 3/8 to 12	290	3 x 1	3 x 1										

Bushings cannot be bored larger than largest bore listed.

screws and use all except one in the other holes. Bushing price includes screws.

For detail dimensions required for machining hubs, consult *Martin*.

Ø For general reference. Severe conditions may require larger hub. Heavy well-located web may permit smaller hub. Hub diameter required depends on the particular application. Consult *Martin* giving full information on the proposed design. Hub diameters shown are based on 20,000, 30,000, and 50,000 P.S.I. minimum ultimate tensile strength respectively for Class 20 gray iron, Class 30 gray iron, and steel hubs.

★ Space required to tighten bushing. Also space required to loosen screws to permit removal of hub by puller.

★★ Space required to loosen bushing using screws as jackscrews—no puller required.

Φ Not currently stocked — Available on order.

† 3 screws for 6050; four for 7060 to 10085; six for 120100. Use in positions shown for tightening bushing on shaft. In loosening bushing, remove



Taper Bushed Type S-Type W Weld-On Hubs Dimensions

Martin Taper Bushed Type S Weld-On Hubs are suitable for use in many applications such as for welding to plate steel sprockets. The outside diameters of these hubs have been reduced to a minimum. This is permissible because of the reinforcing strength of the items to which they are to be welded. Cases where the attached item is of small dimensions should be referred to *Martin*.

Type S Weld-On Hubs are made of steel, drilled, tapped, and taper bored for Tapered Bushings. Their small size and the convenience and advantages of Taper Bushed construction make them of great value on many devices for use on shafts.

Taper Bushed Type S Weld-On Hubs

Hub Number	For Use with Bushing Number	Max. Bore of Bushing	Weight	A	B Φ	C★★	D \emptyset	G	J
S16-4	1610	1 $\frac{1}{8}$.9	3	1	.275	.725	2 $\frac{1}{2}$ †	2 $\frac{1}{2}$
S16-6	1610	1 $\frac{1}{8}$.9	3	1	.450	.550	2 $\frac{1}{2}$ †	2 $\frac{1}{2}$
S20-6	2012	2	1.8	3 $\frac{3}{8}$	1 $\frac{1}{2}$.450	.800	3 $\frac{3}{8}$ †	2 $\frac{1}{2}$
S20-8	2012	2	1.4	3 $\frac{3}{8}$	1 $\frac{1}{2}$.570	.680	3 $\frac{3}{8}$ †	2 $\frac{1}{2}$
S25-6	2517	2 $\frac{1}{2}$	2.6	4 $\frac{1}{4}$	1 $\frac{1}{2}$.450	1.300	4 $\frac{1}{4}$ †	3 $\frac{3}{8}$
S25-8	2517	2 $\frac{1}{2}$	2.6	4 $\frac{1}{4}$	1 $\frac{1}{2}$.565	1.185	4 $\frac{1}{4}$ †	3 $\frac{3}{8}$
S25-10	2517	2 $\frac{1}{2}$	2.5	4 $\frac{1}{4}$	1 $\frac{1}{2}$.685	1.065	4 $\frac{1}{4}$ †	3 $\frac{3}{8}$
S25-16	2517	2 $\frac{1}{2}$	2.4	4 $\frac{1}{4}$	1 $\frac{1}{2}$	1.090	.660	4 $\frac{1}{4}$ †	3 $\frac{3}{8}$
S30-10	3020	3	4.3	5 $\frac{1}{4}$	2	.675	1.325	5 $\frac{1}{4}$ †	4 $\frac{1}{4}$
S30-16	3020	3	4.2	5 $\frac{1}{4}$	2	1.090	.910	5 $\frac{1}{4}$ †	4 $\frac{1}{4}$
S35	3535	3 $\frac{1}{2}$	12.8	6 $\frac{1}{2}$	3 $\frac{1}{2}$	1.160	2.340	6 $\frac{1}{2}$ \emptyset	5

See dimension tables on preceding page for bushing data and wrench space required.

- † + .000-.002
- Φ + .005-.010
- \emptyset + .001-.003
- \emptyset + .000-.005
- ★★ + .010-.010

Type W Weld-On Hubs are made of steel, drilled, tapped, and taper bored to receive Tapered Bushings. They are very useful for welding into fan rotors, pulleys, plate sprockets, impellers, agitators, and many other devices which must be firmly fastened to the shaft.

Taper Bushed Type WA Weld-On Hubs

Hub Number	For Use with Bushing Number	Max. Bore of Bushing	Weight	A	B	C	D	F	G	H	J	K
WA12	1215	1 $\frac{1}{4}$	1.3	2 $\frac{1}{2}$	1 $\frac{1}{2}$	$\frac{3}{8}$	$\frac{3}{8}$	$\frac{3}{8}$	2 $\frac{1}{2}$ †	2 $\frac{1}{2}$	1 $\frac{1}{2}$	2 $\frac{1}{2}$
WA16	1615	1 $\frac{1}{2}$	1.5	3 $\frac{1}{4}$	1 $\frac{1}{2}$	$\frac{3}{8}$	$\frac{3}{8}$	$\frac{3}{8}$	2 $\frac{1}{2}$ †	2 $\frac{1}{2}$	2 $\frac{1}{4}$	3
WA25	2517	2 $\frac{1}{2}$	4.0	4 $\frac{1}{4}$	1 $\frac{3}{4}$	$\frac{1}{2}$	$\frac{3}{4}$	$\frac{3}{4}$	4 $\frac{3}{4}$ †	4 $\frac{1}{4}$	3 $\frac{3}{8}$	4 $\frac{1}{4}$
WA30	3030	3	8.6	5 $\frac{1}{2}$	3	$\frac{3}{4}$	$\frac{3}{4}$	$\frac{1}{4}$	5 $\frac{1}{4}$ †	4 $\frac{3}{8}$	4 $\frac{1}{4}$	5
WA35	3535	3 $\frac{1}{2}$	15	6 $\frac{3}{4}$	3 $\frac{1}{2}$	1 $\frac{1}{4}$	1	$\frac{3}{8}$	6 $\frac{1}{4}$ †	5 $\frac{1}{8}$	5	6
WA40	4040	4	29	7 $\frac{3}{4}$	4	1 $\frac{1}{2}$	1	$\frac{3}{8}$	7 $\frac{1}{4}$ †	6 $\frac{1}{8}$	5 $\frac{3}{8}$	7
WA45	4545	4 $\frac{1}{2}$	42	8 $\frac{3}{4}$	4 $\frac{1}{2}$	1 $\frac{3}{4}$	1	$\frac{3}{8}$	8 †	7 $\frac{1}{8}$	6 $\frac{3}{8}$	8
WA50	5050	5	57	9 $\frac{1}{2}$	5	1 $\frac{3}{4}$	1	$\frac{3}{8}$	8 $\frac{3}{4}$ ★	8 $\frac{1}{8}$	7	8 $\frac{3}{4}$
WA60	6050	6	115	13 $\frac{3}{4}$	5	1 $\frac{3}{4}$	1 $\frac{1}{4}$		12 $\frac{1}{2}$ ★	11 $\frac{1}{8}$	9 $\frac{1}{4}$	
WA70	7060	7	155	14 $\frac{1}{2}$	6	2 $\frac{1}{4}$	1 $\frac{1}{4}$		13 $\frac{1}{2}$ ★	13 $\frac{1}{8}$	10 $\frac{1}{4}$	
WA80	8065	8	180	15 $\frac{1}{2}$	6 $\frac{3}{4}$	2 $\frac{1}{4}$	1 $\frac{1}{4}$		14 $\frac{1}{2}$ ★	14	11 $\frac{1}{4}$	
WA100	10085	10	340	19 $\frac{1}{2}$	8 $\frac{3}{4}$	3 $\frac{1}{2}$	1 $\frac{1}{2}$		18 $\frac{1}{2}$ ★	18 $\frac{1}{4}$	14 $\frac{1}{4}$	

See dimension tables on preceding page for bushing data and wrench space required.

- † + .000-.002
- + .000-.003
- ★ + .000-.004

Type S

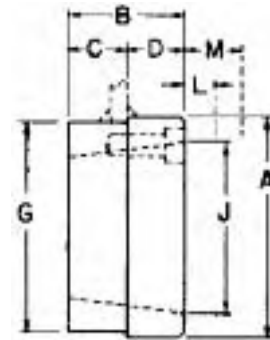

Type WA

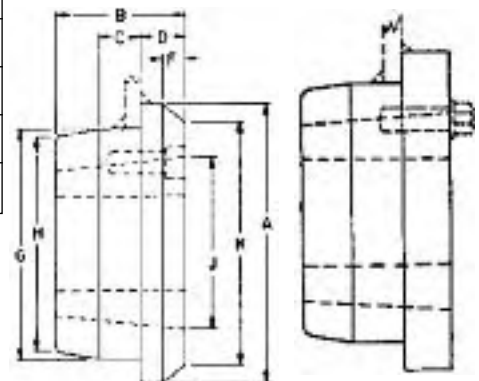

WA12 To WA50

WA60 To WA100

Taper Bushings Metric and Reborable



Stock Taper Bushings With Metric Bores and Keyways

★Metric Bores	★Metric Keyway	Taper Bushing Number			
14, 16	5 x 2.3	1008 1215	1108 1610	1210 1615	
18, 19 20, 22	6 x 2.8	1008 1610	1108 1615	1210 2012	1215 2517
24	8 x 3.3	1108 1610	1210 1615	1215 2012	2517
25	8 x 3.3	1210 1615	1215 2012	1610 2517	
28, 30	8 x 3.3	1210 1615	1215 2012	1610 2517	3020
32	10 x 3.3	1610 2012	1615 2517		3020
35	10 x 3.3	1610 2012	1615 2517		3020
38	10 x 3.3	1610 2012	1615 2517		3020
40, 42	12 x 3.3	2012 2517		3020	
45, 48	14 x 3.8	2012 2517		3020	
50 55	14 x 3.8 16 x 4.3	2517 2517		3020 3020	

★ Millimeter Bores and Keyways from ISO Std. R773. 1" = 25.4 millimeters

NOTE: For other metric bore sizes consult factory.

Stock Reborable Taper Bushings With No Keyways

Sintered Steel		Gray Iron		Steel		Stainless Steel	
1008	$\frac{1}{8}$			1008	$\frac{1}{2}$	1008	$\frac{1}{2}$
1108	$\frac{1}{2}$			1108	$\frac{1}{2}$	1108	
1210	$\frac{1}{8}$			1210	$\frac{1}{2}$	1210	$\frac{1}{2}$
1215	$\frac{1}{2}$			1215	$\frac{1}{2}$	1215	
1310	$\frac{1}{2}$			1310		1310	
1610	$\frac{1}{2}$ $1\frac{1}{8}$			1610	$\frac{1}{2}$	1610	$\frac{1}{2}$
1615	$\frac{1}{2}$ $1\frac{1}{8}$			1615	$\frac{1}{2}$	1615	
2012	$\frac{1}{2}$			2012	$\frac{1}{2}$	2012	$\frac{1}{2}$
2517	$\frac{1}{2}$ $1\frac{1}{8}$			2517	$\frac{1}{2}$	2517	$\frac{1}{2}$
		2525	$2\frac{1}{2}$	2525		2525	
3020	$\frac{1}{8}$ $1\frac{1}{8}$	3020	$\frac{1}{8}$ $1\frac{1}{8}$ $2\frac{1}{8}$	3020	$\frac{1}{8}$	3020	$\frac{1}{8}$
		3030	$\frac{1}{4}$ $2\frac{1}{8}$ $2\frac{1}{8}$	3030		3030	
		3535	$1\frac{1}{8}$ $2\frac{1}{8}$ $2\frac{1}{8}$	3535		3535	
		4040	$1\frac{1}{8}$ $3\frac{1}{8}$ $3\frac{1}{8}$	4040		4040	
		4545	$3\frac{1}{8}$ $4\frac{1}{8}$	4545		4545	
		5050	$2\frac{1}{8}$ $3\frac{1}{8}$				
		6050	$3\frac{1}{8}$ $5\frac{1}{8}$				
		7060	$3\frac{1}{8}$				
		8065	$4\frac{1}{8}$				
		10085	7				
		120100	8				

★ Not currently stocked. Consult factory for availability and pricing.

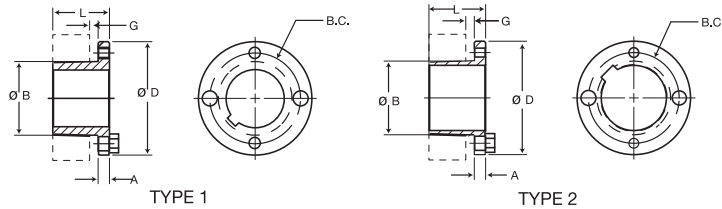

"G" & "H" BUSHINGS

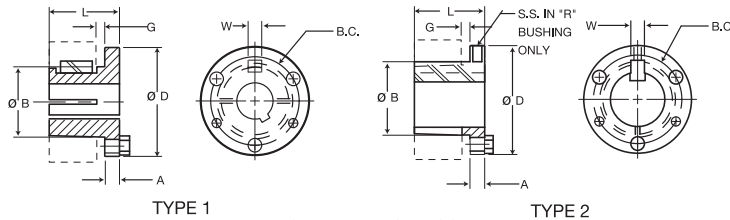

"P", "Q", & "R" BUSHINGS

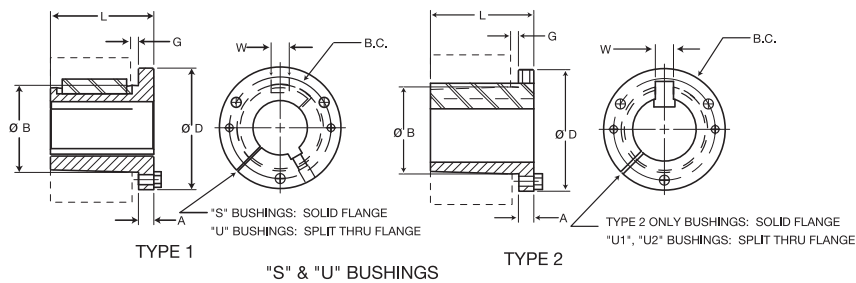

"S" & "U" BUSHINGS

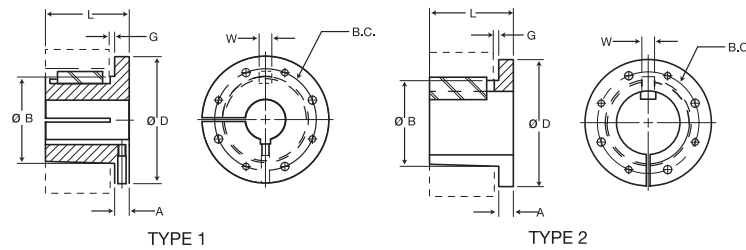

"W" BUSHINGS

Bushing Specifications

Part No.	Dimensions							Stock Bore Range		Cap Screws		Av. Wt. Lbs.	Wrench Torque In. / lbs.
	D	L	A	B Large End	G	B.C.	W	Type 1	Type 2	No.	Size		
G	2.00	1.00	0.25	1.1720	0.19	1.56	—	3/8 - 15/16	1	2	1/4X5/8	0.5	95
H	2.50	1.25	0.25	1.6250	0.19	2.00	—	3/8 - 1-3/8	1-7/16 - 1-1/2	2	1/4X3/4	0.8	95
P1	3.00	1.94	0.41	1.9375	0.22	2.44	0.375	1/2 - 1-7/16	1-1/2 - 1-3/4	3	5/16X1	1.3	192
P2	3.00	2.94	0.41	1.9375	0.22	2.44	0.375	3/4 - 1-7/16	1-1/2 - 1-3/4	3	5/16X1	1.5	192
P3	3.00	4.44	0.41	1.9375	0.22	2.44	0.375	1-1/8 - 1-3/8	1-5/8	3	5/16X1	2	192
Q1	4.12	2.50	0.53	2.8750	0.22	3.38	0.500	3/4 - 2-1/16	2-1/8 - 2-11/16	3	3/8X1-1/4	3.5	348
Q2	4.12	3.50	0.53	2.8750	0.22	3.38	0.500	1 - 2-1/16	2-1/8 - 2-5/8	3	3/8X1-1/4	4.5	348
Q3	4.12	5.00	0.53	2.8750	0.22	3.38	0.500	1-3/8 - 2-1/16	2-1/8 - 2-1/2	3	3/8X1-1/4	5.5	348
R1	5.38	2.88	0.62	4.0000	0.25	4.62	0.750	1-1/8 - 2-13/16	2-7/8 - 3-3/4	3	3/8X1-3/4	7.5	348
R2	5.38	4.88	0.62	4.0000	0.25	4.62	0.750	1-3/8 - 2-13/16	2-7/8 - 3-5/8	3	3/8X1-3/4	11	348
S1	6.38	4.38	0.75	4.6250	0.31	5.38	0.750	1-11/16 - 3-3/16	3-1/4 - 4-1/4	3	1/2X2-1/4	13.5	840
S2	6.38	6.75	0.75	4.6250	0.31	5.38	0.750	1-7/8 - 3-3/16	3-1/4 - 4-3/16	3	1/2X2-1/4	19	840
UO	8.38	5.25	1.06	6.0000	0.44	7.00	1.250	2-3/8 - 3-1/16	—	3	5/8X2-3/4	30	1680
UO	8.38	4.94	0.75	6.0000	0.44	7.00	1.250	3-1/4 - 4-1/4	4-3/8 - 5-1/2	3	5/8X2-3/4	27	1680
U1	8.38	7.12	1.06	6.0000	0.44	7.00	1.250	2-3/8 - 4-1/4	4-3/8 - 5-1/2	3	5/8X2-3/4	40	1680
U2	8.38	10.12	1.06	6.0000	0.44	7.00	1.250	2-7/16 - 4-1/4	4-3/8 - 5	3	5/8X2-3/4	50	1680
W1	12.50	8.25	1.44	8.5000	0.44	10.00	1.250	3-3/8 - 6-3/16	6-1/4 - 7-7/16	4	3/4X3	104	3000
W2	12.50	11.25	1.44	8.5000	0.44	10.00	1.250	3-3/8 - 6-3/16	6-1/4 - 7-7/16	4	3/4X3	133	3000

All tapers are 3/4" per 12" on Dia.

All dimensions are in inches except, as noted.

All bushings are cast iron, ductile iron, sintered steel, or steel. Consult manufacturer for clarification.

Metric bushings also available.

Martin MST BUSHING INSTALLATION & REMOVAL INSTRUCTIONS

The MST bushings are easy to install and remove. They are split through the barrel and have a taper to provide a true clamp on the shaft. They are keyed to both the shaft and the hub to help during "blind" installations.

INSTALLATION

1. Be sure the tapered cone surfaces of the bushing and the inside of the driven product are clean and free of anti-seize lubricants.
2. Place bushing in sprocket or other *Martin* MST part.
3. Place cap screws loosely in pull-up holes. Bushing remains loose to assure sliding fit on shaft.
4. With key on shaft, slide sprocket to desired position on shaft. Be sure heads of capscrews are accessible.
5. Align sprocket. Tighten screws alternately and progressively - until they are pulled up tight (see table below). Do not use extensions on wrench handles. Do not allow sprocket to be drawn in contact with flange of bushing. There should be a gap between bushing flange and sprocket.

CAUTION: THIS GAP MUST NOT BE CLOSED.

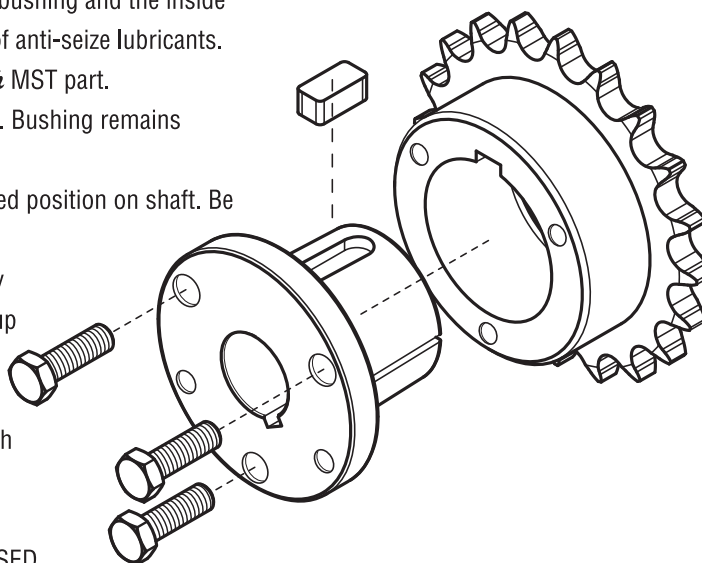

REMOVAL

1. Loosen and remove capscrews.
2. Insert capscrews in tapped removal holes.
3. Tighten inserted screws until sprocket is loose on shaft.
4. Remove sprocket from shaft.

CAUTION

WARNING: USE OF ANTI-SEIZE LUBRICANT ON TAPERED CONE SURFACES OR ON BOLT THREADS WHEN MOUNTING MAY RESULT IN DAMAGE TO SHEAVES AND SPROCKETS. THIS VOIDS ALL MANUFACTURER'S WARRANTIES.

WRENCH TORQUE VALUES FOR TIGHTENING BUSHINGS

MST Bushing Size	Size of Cap Screw	Wrench Torque in. / lbs.
G	1/4 x 5/8	95
H	1/4 x 3/4	95
P	5/16 x 1	192
Q	3/8 x 1-1/4	348
R	3/8 x 1-3/4	348
S	1/2 x 2-1/4	840
U	5/8 x 2-3/4	1680
W	3/4 x 3	3000

WARNING: Because of the possible danger to person(s) or property from accidents which may result from the improper use of products, it is important that correct procedures be followed: Products must be used in accordance with the engineering information specified in the catalog. Proper installation, maintenance and operation procedures must be observed. The instructions given above must be followed. Inspections should be made as necessary to assure safe operation under prevailing conditions. All rotating power transmission products when used in a drive are potentially dangerous and must be guarded by the user as required by applicable laws, regulations, standards, and good safety practice. (Refer to ANSI Standard B15.1.)

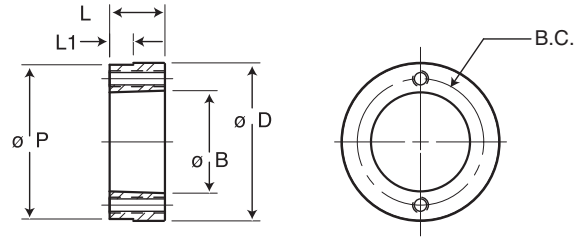

ALL TAPERS 3/4" PER FT.
ON DIAMETER

"H" HUBS

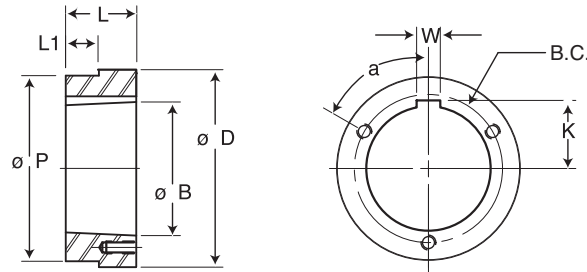

"P", "Q", "R", "S", Y "U" HUBS

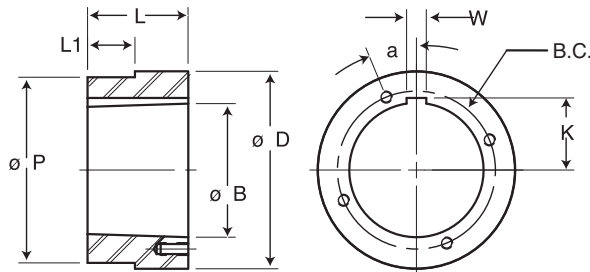

"W" HUBS

Steel Hub Specifications

Part No.	For Bushing	Dimensions									Tapped Holes		Wt. Lbs.
		D	L	P	L1	B	K	B.C.	W	a°	No.	Size	
HH1	H	2.50	0.88	2.375	0.174	1.6210	—	2.000	—	—	2	1/4 - 20	0.6
HCH1	H	2.50	0.88	2.375	0.625	1.6210	—	2.000	—	—	2	1/4 - 20	0.7
HP1	P1	3.00	1.31	2.875	0.292	1.9375	1.094	2.438	0.375	60	3	5/16 - 18	1.4
HCP1	P1	3.00	1.31	2.875	1.000	1.9375	1.094	2.438	0.375	60	3	5/16 - 18	1.1
HP2	P2	3.00	2.31	2.875	1.100	1.9375	1.094	2.438	0.375	60	3	5/16 - 18	2.5
HQ1	Q1	4.50	1.75	4.375	0.709	2.8750	1.562	3.375	0.500	60	3	3/8 - 16	4.4
HCQ1	Q1	4.50	1.75	4.375	1.250	2.8750	1.562	3.375	0.500	60	3	3/8 - 16	4.4
HQ2	Q2	4.50	2.75	4.375	1.606	2.8750	1.562	3.375	0.500	60	3	3/8 - 16	6.9
HR1	R1	5.75	2.00	5.625	0.709	4.0000	2.188	4.625	0.750	60	3	3/8 - 16	7.3
HR2	R2	5.75	4.00	5.625	1.606	4.0000	2.188	4.625	0.750	60	3	3/8 - 16	15.4
HS1	S1	6.75	3.31	6.500	0.946	4.6250	2.562	5.375	0.750	60	3	1/2 - 13	17.3
HS2	S2	6.75	5.69	6.500	2.963	4.6250	2.562	5.375	0.750	60	3	1/2 - 13	30.4
HU0	U0	8.50	3.75	8.250	2.000	6.0000	3.250	7.000	1.250	60	3	5/8 - 11	32.0
HU1	U1	8.50	5.62	8.250	2.963	6.0000	3.250	7.000	1.250	60	3	5/8 - 11	44.6
HU2	U2	8.50	8.62	8.250	6.016	6.0000	3.250	7.000	1.250	60	3	5/8 - 11	69.0
HW1	W1	12.50	6.38	12.250	2.963	8.5000	4.562	10.000	1.250	22.5	4	3/4 - 10	130.0

All tapers are 3/4" per 12" on Dia.

All dimensions are in inches, except as noted.

QD & MST[®] Idler Bushings



Martin Idler Bushings are designed to accommodate stock V-belt drives, sprockets, timing belt pulleys, or other products that use QD or MST type bushings.

They are equipped with two electric motor grade, permanently lubricated ball bearings, mounted on a precision shoulder bolt. Shoulder bolt and two hex jam nuts are zinc plated.

Installation is made by slipping the threaded shaft through a hole bored in support structure, and tightening the locking nut. Sheaves, sprockets, or other products can be removed without dismounting the idler bushing. Available in sizes as shown below. Boxed complete with all mounting hardware and instructions.

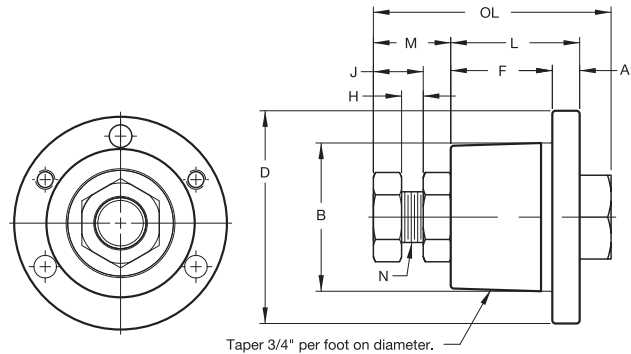
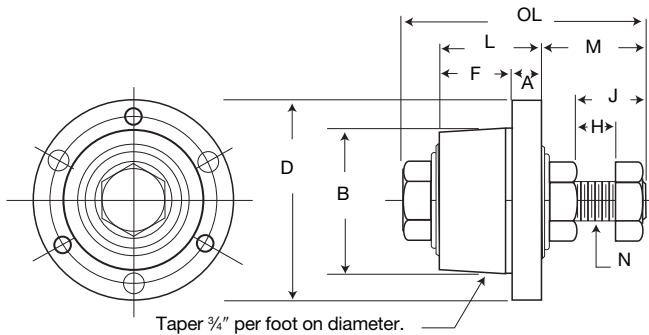

QD Radial Load Ratings (Lbs.) 2500 Hours Service Life

Part Number	RPM				
	100	500	1000	1200	1800
SH-BB	1260	740	580	540	480
SD-BB	1740	1020	800	760	660
SK-BB	2370	1360	1070	1000	880
SF-BB	2550	1500	1180	1100	980
E-BB	4640	2720	2140	2020	1780

Service Temperature Range -40° F Minimum +248° F Maximum

MST Radial Load Ratings (Lbs.) 2500 Hours Service Life

Part Number	RPM				
	100	500	1000	1200	1800
H-BB 1/2	1411	825	655	616	538
P1-BB 5/8	1752	1024	813	765	668
Q1-BB 3/4	2344	1371	1088	1024	894
Q1-BB 1	2555	1494	1186	1116	975

Service Temperature Range -40° F Minimum +248° F Maximum

Part Number	Dimensions									
	A	B	D	F	H	J	L	M	N	OL
SH-BB	7/16	1.871	2 1/16	3/8	5/8	1 1/16	1 1/16	1 1/16	7/16	3 1/16
SD-BB	1/2	2.187	3 3/16	1 1/4	1 1/16	1 1/16	1 1/16	1 1/16	5/8	3 3/8
SK-BB	9/16	2.812	3 3/8	1 1/2	3/4	1 3/16	1 15/16	1 3/8	3/4	4 3/16
SF-BB	9/16	3.125	4 3/8	1 1/2	3/4	1 3/16	2 1/16	2 1/8	7/8	5
E-BB	3/4	3.834	6	1 3/4	1 1/16	2 3/16	2 3/8	3 3/16	1 3/8	6 3/8
H-BB 1/2	1/4	1.625	2 1/2	1	3/8	1 1/16	1 1/4	1	1/2	2 3/16
P1-BB 5/8	13/32	1.937	3	1 17/32	1 7/32	59/64	1 15/16	1 1/16	5/8	3 11/64
Q1-BB 3/4	1 7/32	2.875	4 3/8	1 15/16	5/8	25/32	2 1/2	1 1/4	3/4	4 7/32
Q1-BB 1	1 7/32	2.875	4 3/8	1 15/16	5/8	5 1/4	2 1/2	1 1/2	1	4 39/64

COUPLINGS

PRODUCT	PAGE
INDEXC-1
COUPLING COMPARISONC-2
QUADRA-FLEX®C-4 – C-24
Sleeve SelectionC-7 – C-8
Selection ProcedureC-9
SleevesC-14
FlangesC-15 – C-19
Keyseat DimensionsC-18
Spacer FlangesC-20 – C-23
InstallationC-24
CHAIN COUPLINGC-25 – C-27
Bored-To-SizeC-26
QDC-26
Taper BushedC-26
Coupling SelectionC-27
Plain BoreC-27
CoversC-27
JAW COUPLINGC-28 – C-30
Horsepower RatingsC-29
ML & MS HubsC-30
ML & MS SpidersC-30
<i>Martin</i> -FLEX®C-31 – C-32
Stock SizesC-31
EngineeringC-32

Coupling Comparison



COUPLINGS

Couplings Comparison Chart

Type	Connecting Medium	Max. H. P. Per 100 RPM	Max. RPM	Bore Range	Allowable Misalignment	
					Angle	Parallel
CHAIN	ROLLER CHAIN	700	5000	$\frac{3}{8}$ – 6 $\frac{1}{8}$ "	2°	.015
JAW	ELASTOMERIC SPIDER	3.6	3600	$\frac{1}{8}$ – 2 $\frac{5}{8}$ "	1°	.015
<i>Martin</i> FLEX®	ELASTOMERIC TIRE	14.4	4500	$\frac{3}{8}$ – 3 $\frac{1}{2}$ "	4°	$\frac{1}{8}$
QUADRA FLEX®	ELASTOMERIC SLEEVE	115	9200	$\frac{1}{2}$ – 6"	.330°	.062

Type	Shock Load Capacity	Vibration Dampening	Temperature	
			Range	Fahrenheit
CHAIN	NONE	NONE	-30°	225°
JAW	MODERATE	MODERATE	-60°	250° ★1
<i>Martin</i> FLEX®	EXCELLENT	EXCELLENT	-45°	210° ★2
QUADRA-FLEX®	EXCELLENT	EXCELLENT MODERATE	-50°	275° ★3
			-30°	275° ★4

- ★1 With Hytre® Spider
- ★2 Neoprene Element
- ★3 TPR Sleeve
- ★4 With EPDM Sleeve

Whatever Your Need For Couplings — *Martin* Has Them

Martin Offers Two Complete Lines of Jaw Couplings — One for Greater Horsepower and One for Interchangeability.



ML — Type



MS — Type



Martin-Flex® flexible couplings smoothly transmit power while compensating for shaft misalignment to 4°, parallel misalignment to 1/8" and end float to 5/16". The two piece flange design provides quick and easy installation and the elastomeric element absorbs shock and torsional vibration through a wide temperature range.

For the Most Complete Line of Chain Couplings Available.



S/B



BS



TB



QD



Aluminum



Plastic

Martin QUADRA-FLEX® • A Proven Design Which Offers Long Life, Torsional Flexibility, Ease of Installation, and Withstands Misalignment, Shock, and Vibration.



QUADRA-FLEX®
4-Way Flexing

Martin

COUPLINGS

Quadra-Flex® FLEXIBLE COUPLINGS



Stocked Nationwide
In Sizes 3 Through 16

Styles J, S, B, and
SC Spacers



Martin QUADRA-FLEX® Couplings, Non Lubricated,
Maintenance Free, Easy and Quick Installation

Handles All Combinations of Shock, Vibration, and Misalignment

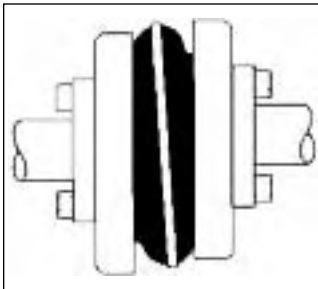

Parallel

QUADRA-FLEX® couplings absorb parallel misalignment without wear and with minimal loss of energy. The amount of parallel offset handled varies by size from .015" on the size 5 up to .062" on the size 16. This minimizes the radial loads on bearings when parallel misalignment occurs.

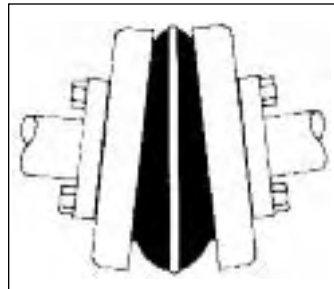

Angular

Due to the flexing characteristics of the sleeve and the locking action of the teeth, QUADRA-FLEX® couplings easily handle angular misalignment up to 1 degree without any appreciable wear.

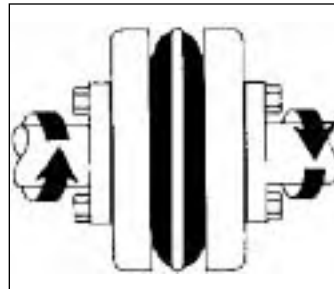

Torsional

QUADRA-FLEX® sleeves are torsionally resilient and are well suited to absorbing shocks and dampening vibrations that would otherwise be transmitted between the equipment.

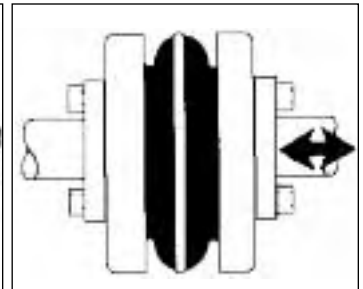

Axial

The axial flexibility of the sleeve allows the QUADRA-FLEX® coupling to accept a limited amount of end float. This serves to reduce thrust loads transferred to bearings. QUADRA-FLEX® units will accept axial movement of approximately 1/8".

Available in Three Styles

Type J and S Flanges

Bored-to-size flanges are manufactured for a slip fit on standard shafting. Available from stock in a wide range of shaft sizes.



Type B Flanges

Manufactured from high strength cast iron to fit standard QD bushings in sizes 6 thru 16.



Fast Coupling Disassembly

Martin offers the first true drop-out spacer assembly for the 4JSC spacer coupling. The center portion of the spacer can be taken out, just as in the 5SC thru 14SC, by simply removing four cap screws in each hub. The couplings center section can then be lifted out and the pump gaskets exposed. Flats on the spacer hubs facilitate turning shafts with a wrench.



Type SC Spacer Flange

QUADRA-FLEX® SC Spacer Couplings feature all standard spacing requirements for the pump industry. Spacer sizes range from sizes 4 thru 14.



QUADRA-FLEX® Nomenclature

Flanges

Type	Description
J★	SINTERED STEEL, BORED-TO-SIZE
S	CAST IRON, BORED-TO-SIZE
B	CAST IRON, QD BUSHED
SC	SPACER COUPLING FLANGES

★ – #6 Currently Supplied in Cast Iron

Hubs – (For SC flanges)

Type	Description
H	REGULAR LENGTH
HS	SHORT LENGTH

Sleeves

Type	Description
JEM	TPR – 1-PIECE SOLID, THERMOPLASTIC
JEMS	TPR – 1-PIECE SPLIT, THERMOPLASTIC
EM	TPR – 2-PIECE W/RETAINING RING
E	EPDM – 2-PIECE W/RETAINING RING
N	NEOPRENE – 2-PIECE W/RETAINING RING
H	HYTREL – 1-PIECE SOLID
HS	HYTREL – 2-PIECE

QUADRA-FLEX® couplings come in a variety of styles and designs to meet specific customer needs. These include flanges and sleeves of various types and materials. The total product line includes 13 sizes varying in torque ratings up to 72,000 in-lbs.

When ordering QUADRA-FLEX® couplings, the following basic procedure should help expedite order processing. For coupling flanges, give the basic coupling size, then the letter for the type flange followed by the bore size required. For coupling sleeves, give the coupling size followed by the letter(s) designating the type and material required. (See above)

The following are various examples for reference:

Example: Type J Flange

	Size	Flange	Bore
5J x 3/4"	5	J	3/4"
7S x 30mm	7	S	30mm

(Note: Bored-to-size flanges are furnished with standard keyway and 2 setscrews unless specified otherwise.)

Example: Type B Flange

	Size	Flange	Bushing
8B – SH	8	B	SH

(Note: The SH bushing with required bore size should be specified separately.)

Example: Sleeves

	Size	Style & Material
8JEM	8	Solid, TPR
13E	13	2 Piece, EPDM

(Note: Unless specified, TPR (3 thru 12) or EPDM (13 thru 16) will be supplied.)

Example: Complete spacer coupling

1	6EM	(6 TPR 2 Piece Sleeve)
2	6SC35	(Flanges for 3 1/2" dropout)
1	6H x 1"	(6 Spacer Hub for 1" Bore)
1	6H x 1 1/8"	(6 Spacer Hub for 1 1/8" Bore)

Sleeve Selection



QUADRA-FLEX® coupling sleeves are available in four different types of compounds. These include TPR (ThermoPlastic Rubber) in types JEM, JEMS, EM; EPDM

Rubber in type E; Neoprene in type N; Hytrel in type H and HS. To determine the sleeve best suited for the application, the material characteristics are given below.

TPR (Sizes 3-12)

QUADRA-FLEX® couplings are usually supplied with TPR sleeves in sizes 3-12. TPR is a general use sleeve which combines the characteristics of both EPDM & Neoprene into one. These sleeves operate within a temperature range from -50° F to +275° F (-46° C to +135° C). Torsional flexibility is 15°.

EPDM (Sizes 13-16)

QUADRA-FLEX® couplings are usually supplied with EPDM rubber sleeves in sizes 13-16. EPDM is a general use sleeve and can operate within a temperature range from -30° F to +275° F (-34° C to +135° C). Torsional flexibility is 15°.

NEOPRENE (Sizes 11-16)

Neoprene flexible sleeves are also available in sizes 11-14. These sleeves offer a higher resistance than EPDM and are self-extinguishing. Operating temperature range for this sleeve is 0° F to +200° F (-18° C to +93° C). Torsional flexibility is 15°.

*HYTREL® (Sizes 6-14)

Hytrel sleeves are molded specifically for high torque applications. The type H will transmit approximately four times as much power as an equivalent TPR, EPDM, or Neoprene sleeve. Hytrel has an operating temperature from -65° F to +250° F (-54° C to +121° C). Torsional flexibility is 7°.

Note: Do not use a Hytrel sleeve as a replacement for a TPR, EPDM, or Neoprene sleeve.

Sleeve Chemical Resistance

Resistance To:	TPR	EPDM	Neoprene★	Hytrel★	Resistance To:	TPR	EPDM	Neoprene★	Hytrel★
Acetone	A	A	B	B	Isopropyl	A	T	A	A
Ammonia, Anhydrous	B	T	A	N	Kerosene	B	X	B	T
Ammonium Hydroxide Solutions	T	A	A(158F)	T	Lacquer Solvents	T	...	C	B
ASTM hydrocarbon test fluid	N	C	X	A	Lubricating Oils	B	X	B(158F)	A
ASTM oil no. 1	B	C	A	A	Methyl Alcohol	A	T	A(158F)	A
ASTM oil no. 3	B	C	B(158F)	A	Mineral Oil	B	X	A	A
ASTM reference fuel A	B	C	A	A	Naphtha	B	C	C	A
ASTM reference fuel B	B	C	C	A	Nitric Acid, 10%	A	T	B	B
ASTM reference fuel C	B	X	C	B	Nitrobenzene	T	A	C	C
Benzene	C	C	C	B	Phenol	T	T	B	C
Butane	B	B	A	A	Phosphoric Acid, 20%	A	T	T	N
Carbon Tetrachloride	X	C	C	C	Phosphate Esters	A	A	C	A
Chlorobenzene	C	X	X	X	Pickling Solution (20% Nitric Acid, 4% HF)	N	X	B-C	X
Chloroform	X	C	C	C	Soap Solutions	A	T	A(158F)	A
Chromic Acid, 10-50%	T	T	C	N	Sodium Hydroxide, 20%	A	A	A	A
Dowtherm A Solvent	X	N	B	N	Stearic Acid	T	T	B(158F)	T
Ethyl Alcohol	A	A	A(158F)	A	Sulfuric Acid, up to 50%	A	T	A(158F)	A
Ethylene Glycol	A	A	A(158F)	A	Sulfuric Acid, up to 80%	A	T	B-C	C
Fuel Oil	B	X	A	A	Tannic Acid, 10%	T	T	A	T
Gasoline	B	B-C	B	A	Toluene	C	C	C	B
Glycerine	A	T	A(158F)	A	Trichloroethylene	C	X	C	C
Hydraulic Oils	B	N	A	A	Turpentine	B	C	C	N
Hydrochloric Acid, 20%	A	T	A	B	Water	A	A(158F)	A(212F)	A(158F)
Hydrogen Peroxide, 88½%	N	T	B	T	Xylene	C	C	X	B

A — Fluid has little or no effect
 B — Fluid has minor to moderate effect
 C — Fluid has severe effect

N — No evaluation has been attempted.
 T — No data; likely to be compatible
 X — No data; not likely to be compatible

*Hytrel is a Registered Trademark of Dupont

Selection Procedure

When the driver is an electric motor with standard speed.

Step 1. Determine Service Factor (SF) Symbol based on equipment listed on page C-10.

Step 2. Determine proper Service Factor from chart at top of page C-10.

Step 3. Refer to page C-12 and C-13 for proper selection of coupling. Based on chemical resistance and operating environment found on page C-8, select from chart the type of sleeve material. Find RPM of motor, then, in the column for service factor determined in Step 2, read down to the corresponding horsepower of motor being used as the driver. The number listed is the correct coupling size.

Example: A coupling is needed to connect a 25 HP standard electric motor to a lumber log haul at 1750 RPM.

1. Service Factor Symbol — H
2. Service Factor — 2.0
3. Coupling Size — 9 with TPR sleeve or 6 with Hytrel Sleeve

Step 4. Select flanges from pages C-15 thru C-19, check coupling bore size range for proper shaft fit.

★ **NOTE: Do not oversize coupling hub — will cause premature wear of element.**

When the driver is other than an electric motor or the speeds are different than those shown in the chart on page C-11.

Step 1. Follow steps 1 & 2 in previous procedure.

Step 2. Calculate Horsepower at 100 RPM as follows:

$$\text{HP at 100 RPM} = \frac{\text{HP} \times \text{Service Factor} \times 100}{\text{coupling RPM}}$$

Step 3. Select coupling size from Tables A or C. Find a HP equal to or greater than the HP/100 RPM

Step 4. Check Maximum bore to be sure that both shaft sizes do not exceed figure listed for size selected in step 4. If maximum is exceeded select the next largest size which will allow for bore size. Do not exceed maximum RPM for new size selected.

Example: A bucket elevator is driven by a motor/reducer and requires a coupling to transmit 14 HP at 1300 RPM.

1. Service Factor Symbol — M
2. Service Factor — 1.5
3. HP at 100 RPM = $\frac{14 \times 1.5 \times 100}{1300} = 1.61$ HP/100 RPM
4. Refer to page C-11; under column for 100 RPM the required 1.61 HP falls between the size 7 (1.2) and the size 8 (1.8). Correct selection is size 8 with TPR sleeve. Check bore sizes for flanges on pages C-15 thru C-19.

Maximum RPM and Allowable Misalignment

Size	Maximum RPM	Types JEM, JEMS, EM, E and N		Types H and HS	
		Parallel	Angular	Parallel	Angular
3	9200	.010	.035	—	—
4	7600	.010	.043	—	—
5	7600	.015	.056	—	—
6	6000	.015	.070	.010	.016
7	5250	.020	.081	.012	.020
8	4500	.020	.094	.015	.025
9	3750	.025	.109	.017	.028
10	3600	.025	.128	.020	.032
11	3600	.032	.151	.022	.037
12	2800	.032	.175	.025	.042
13	2400	.040	.195	.030	.050
14	2200	.045	.242	.035	.060
16	1500	.062	.330	—	—

Note: Values shown above apply if the actual torque transmitted is more than ½ the coupling rating. For lesser torque, reduce the above values by ½.

Service Factors For QUADRA-FLEX® Couplings

Service Factor Symbol	Electric Motor Standard Torque	Electric Motor High Torque	Turbines	Reciprocating Engines
L (LIGHT)	1.25	1.5	1.0	1.5
M (MEDIUM)	1.5	2.0	1.25	2.0
H (HEAVY)	2.0	2.5	1.5	2.5

Table 1

Application	SF Symbols	Application	SF Symbols	Application	SF Symbols
AGITATORS - Paddle, Propeller, Screw	L	DISC FEEDER	L	MILLS	
BAND RESAW	M	DOUGH MIXER	M	Ball, Pebble, Rod, Tube	H
BARGE HAUL PULLER	H	DRAW BENCH CONVEYOR & Main Drive	H	Rubber, Tumbling	H
BARKING (Lumber)	H	DREDGES		Dryer and Cooler	M
BAR SCREEN (sewage)	L	Cable Reel, Pumps	M	MIXER	
BATCHES (textile)	L	Cutter Head Drive, Jig Drive	H	Concrete, Muller	M
BEATER AND PULPER (paper)	M	Screen Drive	H	Banbury	H
BENDING ROLL (metal)	M	Maneuvering and Utility Winch	M	ORE CRUSHER	H
BLEACHER (paper)	L	Stacker	M	OVEN CONVEYOR	L
BLOWERS		DYNAMOMETER	L	PLANER (metal or wood)	M
Centrifugal, Vane	L	DRYERS (rotary)	M	PRESSES	
Lobe	M	EDGER (lumber)	H	Brick, Briquette Machine	H
BOTTLING MACHINERY	L	ELEVATORS		Notching, Paper, Punch, Printing	M
BREW KETTLES (distilling)	L	Bucket	M	PUG MILL	M
BUCKET ELEVATOR OR CONVEYOR	M	Escalator	L	PULP GRINDER (paper)	H
CALENDERS		Freight, Passenger, Service, Man Lift	H	PULVERIZERS	
Calender (paper)	M	ESCALATORS	L	Hammermill — light duty, Roller	M
Calender-super (paper, rubber)	H	EXTRUDER (metal)	H	Hammermill — heavy duty, Hog	H
CANE KNIVES (sugar)	M	FANS		PUMPS	
CARD MACHINE (textile)	H	Centrifugal	L	Centrifugal, Axial	L
CAR DUMPERS	H	Cooling Tower	H	Gear, Lobe, Vane	M
CEMENT KILN	H	Forced Draft, Large Industrial, Mine	M	Reciprocating — sgl. or dbl. acting	*
CENTRIFUGAL BLOWERS		FEEDERS		REEL, REWINDER (paper) CABLE	M
COMPRESSORS, FANS or PUMPS	L	Apron, Belt, Disc	L	ROD MILL	H
CHEMICAL FEEDERS (sewage)	L	Reciprocating	H	SAWDUST CONVEYOR	L
CHILLER (oil)	M	Screw	M	SCREENS	
CHIPPER (paper)	H	FILTER, PRESS-OIL	M	Air Washing, Water	L
CIRCULAR RESAW	M	GENERATORS		Rotary for coal or sand	M
CLARIFIER or CLASSIFIER	L	Uniform load	L	Vibrating	H
CLAY WORKING MACHINERY	M	Varying load, Holst	M	SCREW CONVEYOR	L
COLLECTORS (sewage)	L	Welders	H	SLAB CONVEYOR (lumber)	M
COMPRESSORS		GRIT COLLECTOR (sewage)	L	SLITTERS (metal)	M
Centrifugal	L	GRIZZLY	H	SOAPERS (textile)	L
Reciprocating	*	HAMMERMILL		SORTING TABLE (lumber)	M
Screw, Lobe	L	Light Duty, Intermittent	M	SPINNER (textile)	M
CONCRETE MIXERS	M	Heavy Duty, Continuous	H	STOKER	L
CONVERTING MACHINE (paper)	M	HOISTS		SUCTION ROLL (paper)	M
CONVEYORS		Heavy Duty	H	TENTER FRAMES (textile)	M
Apron, Assembly Belt, Flight	L	Medium Duty	M	TIRE BUILDING MACHINES	H
Oven, Screw	L	JORDAN (paper)	H	TIRE & TUBE PRESS OPENER	L
Bucket	L	KILN, ROTARY	H	TUMBLING BARRELS	H
COOKERS- Brewing, Distilling, Food	M	LAUNDRY WASHER or TUMBLER	H	WASHER and THICKENER (paper)	M
COOLING TOWER FANS	H	LINE SHAFTS	L	WINCHES	M
COUCH (paper)	M	LOG HAUL (lumber)	H	WINDERS, Paper, Textile, Wire	M
CRANES & HOISTS	M	LOOM (textile)	M	WINDLASS	M
Heavy Duty Mine	H	MACHINE TOOLS, MAIN DRIVE	M	WIRE	
CRUSHERS — Cane (sugar), Stone, Ore	H	MANGLE (textile)	L	Drawing	H
CUTTER — Paper	H	MASH TUBS (distilling)	L	Winding	M
CYLINDER (paper)	H	MEAT GRINDER	M	WOODWORKING MACHINERY	L
DEWATERING SCREEN (sewage)	M	METAL FORMING MACHINES	M		

* Consult Factory

Coupling Ratings

Table 2A ThermoPlastic Rubber (TPR), EPDM & Neoprene

Coupling Size	Sleeve Construction	Basic HP Ratings Per Given RPM					Rated Torque (in.-lb.)	Torsional • Stiffness Factor (in.-lb./radians)	Maximum RPM
		100	860	1160	1750	3500			
3	TPR	.10	.8	1.1	1.7	3.3	60	229	9200
4	TPR	.19	1.6	2.2	3.3	6.7	120	458	7600
5	TPR	.38	3.3	4.4	6.7	13.0	240	916	7600
6	TPR	.71	6.1	8.3	12.5	25.0	450	1718	6000
7	TPR	1.20	10.0	13.0	20.0	40.0	725	2769	5250
8	TPR	1.80	16.0	20.0	32.0	63.0	1135	4335	4500
9	TPR	2.80	25.0	33.0	50.0	100.0	1800	6875	3750
10	TPR	4.60	39.0	53.0	80.0	160.0	2875	10980	3600
11	TPR	7.20	62.0	83.0	126.0	252.0	4530	17300	3600
12	TPR	11.40	98.0	132.0	200.0	—	7200	27500	2800
13	EPDM & Neoprene	18.00	155.0	209.0	315.0	—	11350	43350	2400
14	EPDM & Neoprene	28.60	246.0	331.0	500.0	—	18000	68755	2200
16	EPDM	75.00	645.0	870.0	—	—	47250	180480	1500

Table 2C Hytrel

Coupling Size	Sleeve Construction	Basic HP Ratings Per Given RPM					Rated Torque (in.-lb.)	Torsional • Stiffness Factor (in.-lb./radians)	Maximum RPM
		100	860	1160	1750	3500			
3*	HYTREL	—	—	—	—	—	—	—	—
4*	HYTREL	—	—	—	—	—	—	—	—
5*	HYTREL	—	—	—	—	—	—	—	—
6	HYTREL	2.9	25.0	33.0	50.0	100.0	1800	10000	6000
7	HYTREL	4.6	39.0	53.0	80.0	160.0	2875	20000	5250
8	HYTREL	7.2	62.0	84.0	126.0	252.0	4530	30000	4500
9	HYTREL	11.4	98.0	132.0	200.0	400.0	7200	47500	3750
10	HYTREL	18.0	155.0	209.0	315.0	630.0	11350	100000	3600
11	HYTREL	28.6	246.0	331.0	500.0	1000.0	18000	125000	3600
12	HYTREL	50.0	430.0	580.0	875.0	—	31500	225000	2800
13	HYTREL	75.0	645.0	870.0	1312.0	—	47268	368900	2400
14	HYTREL	115.0	986.0	1334.0	2013.0	—	72480	593250	2200

* Hytrel sleeves are available on a made-to-order basis. Consult factory.
 • Values shown are for an ambient temperature of 75° F (24° C).

Sleeve Selection Chart



Selection Chart for TPR¹, EPDM, & Neoprene Sleeves

HP	860 RPM Motor					1160 RPM Motor					1750 RPM Motor					3500 RPM Motor				
	Service Factors					Service Factors					Service Factors					Service Factors				
	1.0	1.25	1.5	2.0	2.5	1.0	1.25	1.5	2.0	2.5	1.0	1.25	1.5	2.0	2.5	1.0	1.25	1.5	2.0	2.5
1/2	3	3	3	4	4	3	3	3	4	4	3	3	3	3	3	—	—	—	—	—
3/4	3	4	4	4	5	3	3	4	4	4	3	3	3	3	4	3	3	3	3	3
1	4	4	4	5	5	3	4	4	4	5	3	3	3	4	4	3	3	3	3	3
1 1/2	4	5	5	5	6	4	4	5	5	5	3	4	4	4	5	3	3	3	3	4
2	5	5	5	6	6	4	5	5	5	6	4	4	4	5	5	3	3	3	4	4
3	5	6	6	6	7	5	5	6	6	6	4	5	5	5	6	3	4	4	4	5
5	6	6	7	7	8	6	6	6	7	7	5	5	6	6	6	4	4	5	5	5
7 1/2	7	7	8	8	9	6	7	7	8	8	6	6	6	7	7	5	5	5	6	6
10	7	8	8	9	9	7	7	8	8	9	6	6	7	7	8	5	5	6	6	6
15	8	9	9	10	10	8	8	9	9	10	7	7	8	8	9	6	6	6	7	7
20	9	9	10	10	11	8	9	9	10	10	7	8	8	9	9	6	6	7	7	8
25	9	10	10	11	11	9	9	10	10	11	8	8	9	9	10	6	7	7	8	8
30	10	10	11	11	12	9	10	10	11	11	8	9	9	10	10	7	7	8	8	9
40	10	11	11	12	12	10	10	11	11	12	9	9	10	10	11	7	8	8	9	9
50	11	11	12	12	13	10	11	11	12	12	9	10	10	11	11	8	8	9	9	10
60	11	12	12	13	13	11	11	12	12	13	10	10	11	11	12	8	9	9	10	10
75	12	12	13	13	14	11	12	12	13	13	10	11	11	12	12	9	9	10	10	11
100	12	13	13	14	14	12	12	13	13	14	11	11	12	12	13	9	10	10	11	11
125	13	13	14	14	—	12	13	13	14	14	11	12	12	13	13	10	10	11	11	—
150	13	14	14	16	16	13	13	14	14	16	12	12	13	13	14	10	11	11	—	—
200	14	14	16	16	16	13	14	14	16	16	12	13	13	14	14	11	11	—	—	—
250	14	16	16	16	16	14	14	16	16	16	13	13	14	14	—	11	—	—	—	—
300	16	16	16	16	—	14	16	16	16	16	13	14	14	—	—	—	—	—	—	—
350	16	16	16	—	—	16	16	16	16	16	14	14	—	—	—	—	—	—	—	—
400	16	16	16	—	—	16	16	16	16	—	14	14	—	—	—	—	—	—	—	—
450	16	16	—	—	—	16	16	16	—	—	14	—	—	—	—	—	—	—	—	—
500	16	16	—	—	—	16	16	16	—	—	14	—	—	—	—	—	—	—	—	—
600	16	—	—	—	—	16	16	—	—	—	—	—	—	—	—	—	—	—	—	—
700	—	—	—	—	—	16	16	—	—	—	—	—	—	—	—	—	—	—	—	—
800	—	—	—	—	—	16	—	—	—	—	—	—	—	—	—	—	—	—	—	—

¹ ThermoPlastic Rubber

Caution: Applications involving reciprocating engines and reciprocating driven devices are subject to critical rotational speeds which may damage the coupling and/or connected equipment. Contact factory with specific requirements.



Hytrell Selection Chart

Selection Chart for Hytrell Sleeves

HP	860 RPM Motor					1160 RPM Motor					1750 RPM Motor					3500 RPM Motor									
	Service Factors					Service Factors					Service Factors					Service Factors									
	1.0	1.25	1.5	2.0	2.5	1.0	1.25	1.5	2.0	2.5	1.0	1.25	1.5	2.0	2.5	1.0	1.25	1.5	2.0	2.5					
1																									
1½																									
2																									
3																									
5																									
7½	6H	6H	6H	6H	6H	—	—	—	—	—	—	—	—	—	—	—	—	—	—	—	—	—	—	—	
10	6H	6H	6H	6H	6H	6H	6H	6H	6H	6H	—	—	—	—	—	—	—	—	—	—	—	—	—	—	
15	6H	6H	6H	7H	7H	6H	6H	6H	7H	7H	6H	6H	6H	6H	6H	6H	—	—	—	—	—	—	—	—	
20	6H	6H	7H	7H	8H	6H	6H	6H	7H	7H	6H	6H	6H	6H	6H	6H	—	—	—	—	—	—	—	—	
25	6H	7H	7H	8H	8H	6H	6H	7H	7H	8H	6H	6H	6H	6H	7H	—	—	—	—	—	—	—	—	—	
30	7H	7H	8H	8H	9H	6H	7H	7H	8H	8H	6H	6H	6H	7H	7H	6H	6H	6H	6H	6H	6H	6H	6H	6H	
40	7H	8H	8H	9H	9H	7H	7H	8H	8H	9H	6H	6H	7H	7H	8H	6H	6H	6H	6H	6H	6H	6H	6H	6H	
50	8H	8H	9H	9H	10H	7H	8H	8H	9H	9H	6H	7H	7H	8H	8H	6H	6H	6H	6H	6H	6H	6H	7H	7H	
60	8H	9H	9H	10H	10H	8H	8H	9H	9H	10H	7H	7H	8H	8H	9H	6H	6H	6H	6H	7H	7H	7H	7H	7H	
75	9H	9H	10H	10H	11H	8H	9H	9H	10H	10H	7H	8H	8H	9H	9H	6H	6H	7H	7H	8H	8H	8H	8H	8H	
100	9H	10H	10H	11H	11H	9H	9H	10H	10H	11H	8H	8H	9H	9H	10H	6H	7H	7H	8H	8H	8H	8H	8H	8H	
125	10H	10H	11H	11H	12H	9H	10H	10H	11H	11H	8H	9H	9H	10H	10H	7H	7H	8H	8H	9H	9H	9H	9H	9H	
150	10H	11H	11H	12H	12H	10H	10H	11H	11H	12H	9H	9H	10H	10H	11H	7H	8H	8H	9H	9H	9H	9H	9H	9H	
200	11H	11H	12H	12H	13H	10H	11H	11H	12H	12H	9H	10H	10H	11H	11H	8H	8H	9H	9H	10H	10H	10H	10H	10H	
250	11H	12H	12H	13H	13H	11H	11H	12H	12H	13H	10H	10H	11H	11H	12H	8H	9H	9H	10H	10H	10H	10H	10H	10H	
300	12H	12H	13H	13H	14H	11H	12H	12H	13H	13H	10H	11H	11H	12H	12H	9H	9H	10H	10H	11H	11H	11H	11H	11H	
350	12H	12H	13H	14H	14H	12H	12H	12H	13H	14H	11H	11H	12H	12H	12H	9H	10H	10H	11H	11H	11H	11H	11H	11H	
400	12H	13H	13H	14H	14H	12H	12H	13H	13H	14H	11H	11H	12H	12H	13H	9H	10H	10H	11H	11H	11H	11H	11H	11H	
500	13H	13H	14H	14H	—	12H	13H	13H	14H	14H	11H	12H	12H	13H	13H	10H	10H	11H	11H	—	—	—	—	—	
600	13H	14H	14H	—	—	13H	13H	13H	14H	—	12H	12H	13H	13H	14H	10H	11H	11H	—	—	—	—	—	—	
700	14H	14H	—	—	—	13H	13H	14H	14H	—	12H	12H	13H	14H	14H	11H	11H	—	—	—	—	—	—	—	
800	14H	14H	—	—	—	13H	14H	14H	—	—	12H	13H	13H	14H	14H	11H	11H	—	—	—	—	—	—	—	
900	14H	—	—	—	—	14H	14H	14H	—	—	13H	13H	14H	14H	—	11H	—	—	—	—	—	—	—	—	
1000	—	—	—	—	—	14H	14H	—	—	—	13H	13H	14H	14H	—	11H	—	—	—	—	—	—	—	—	

QUADRA-FLEX® Sleeves

Martin flexible sleeve elements are offered in four material compounds (ThermoPlastic Rubber (TPR), EPDM, Neoprene, and Hytrel) available in three construction styles. Our EM sleeve offers the combination of EPDM's extended temperature range as well as the higher oil resistance which Neoprene provides.



Type JEM

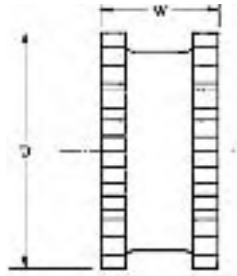

Type JEMS

Types JEM — JEMS

Type J sleeves are molded ThermoPlastic Rubber (TPR). Available in 1 piece solid (JEM), and 1 piece split, construction (JEMS). TPR material will handle higher temperature ranges as well as be oil resistant.



Type EM, E, and N

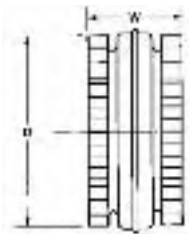

Types EM — E — N

Type EM, E, and N sleeves are of two piece molded construction with Retaining Ring. They are available in ThermoPlastic Rubber (Type TPR), EPDM (Type E), or Neoprene (Type N). These can be used with any type flanges within a given size range.



Type H

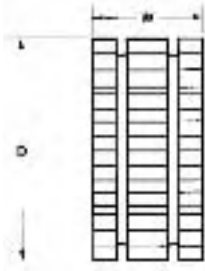

Type HS

Types H & HS

Martin H & HS sleeves are molded Hytrel for higher torque loading than standard EM sleeves. H & HS sleeves cannot be used with style J and B flanges. Hytrel sleeves are not a direct replacement for TPR, EPDM, or Neoprene sleeves.

Dimensions (Inches)

Coupling Size	JEM — JEMS Sleeves			EM - E - N Sleeves			H & HS Sleeves Hytrel•		
	D	W	Wt. (lb.)	D	W	Wt. (lb.)	D	W	Wt. (lb.)
3	1 $\frac{1}{4}$	1	.06	—	—	—	—	—	—
4	2 $\frac{1}{16}$	1 $\frac{1}{4}$.10	2 $\frac{1}{16}$	1 $\frac{1}{4}$.11	—	—	—
5	2 $\frac{1}{8}$	1 $\frac{1}{8}$.20	2 $\frac{1}{8}$	1 $\frac{1}{8}$.25	—	—	—
6	3 $\frac{1}{8}$	1 $\frac{1}{8}$.35	3 $\frac{1}{8}$	1 $\frac{1}{8}$	1.00	3 $\frac{1}{8}$	1 $\frac{1}{8}$.44
7	4 $\frac{1}{2}$	2 $\frac{3}{16}$.50	4 $\frac{1}{2}$	2 $\frac{3}{16}$.77	4 $\frac{1}{2}$	2 $\frac{3}{16}$.69
8	5 $\frac{1}{16}$	2 $\frac{1}{2}$.85	5 $\frac{1}{16}$	2 $\frac{1}{2}$	1.4	5 $\frac{1}{16}$	2 $\frac{1}{2}$	1.4
9	6	3	2.00	6	3	2.0	6	3	1.8
10	7 $\frac{1}{16}$	3 $\frac{1}{16}$	2.20	7 $\frac{1}{16}$	3 $\frac{1}{16}$	2.90	7 $\frac{1}{16}$	3 $\frac{1}{16}$	3.00
11	—	—	—	8 $\frac{3}{16}$	4	4.67	8 $\frac{3}{16}$	4	4.70
12	—	—	—	9 $\frac{1}{16}$	4 $\frac{11}{16}$	8.1	9 $\frac{1}{16}$	4 $\frac{11}{16}$	8.00
13	—	—	—	11 $\frac{1}{16}$	5 $\frac{1}{2}$	13.0	11 $\frac{1}{16}$	5 $\frac{1}{2}$	11.8
14	—	—	—	13 $\frac{3}{32}$	6 $\frac{1}{2}$	21.1	13 $\frac{3}{32}$	6 $\frac{1}{2}$	19.3
16	—	—	—	17 $\frac{29}{32}$	8 $\frac{1}{4}$	53	—	—	—

• 13 & 14 Hytrel available with HS sleeves only.

QUADRA-FLEX® Type J Flanges

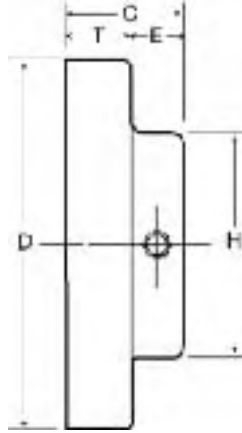

QUADRA-FLEX® Type J Flanges

Martin Type J Flanges are supplied bored to size with standard keyway and two setscrews to slip fit on standard shafting.

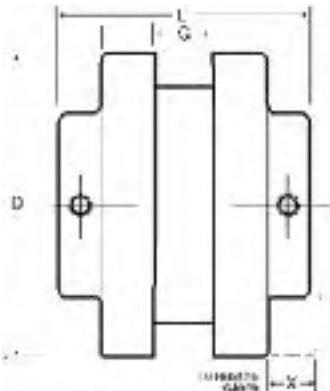

Type J Flanges use the *Martin* JEM 1 Piece, the *Martin* JEMS 1 piece split and the *Martin* EM 2 piece split sleeves.
(Note: Hytrel sleeves are not intended for use with this type of flange.)

Dimensions (Inches)

Coupling Size	Dimensions								Weight (lbs.)★	Finished Bore Sizes• (Inches)	Max. Bore	Millimeters
	C	D	E	G	H	L	T	X				
3J	$\frac{1}{16}$	2.062	$\frac{7}{16}$	$\frac{3}{8}$	$1\frac{1}{4}$	2	$\frac{3}{8}$	$\frac{9}{16}$.26	$\frac{3}{8}$ ** - $\frac{1}{2}$ - $\frac{5}{8}$ - $\frac{3}{4}$	$\frac{3}{4}$	— — —
	$\frac{13}{16}$	2.062	$\frac{7}{16}$	$\frac{3}{8}$	$1\frac{1}{2}$	2	$\frac{3}{8}$	$\frac{9}{16}$.26	$\frac{7}{8}$	$\frac{7}{8}$	— — —
4J	$\frac{7}{8}$	2.460	$\frac{7}{16}$	$\frac{5}{8}$	$1\frac{1}{8}$	$2\frac{1}{8}$	$\frac{7}{16}$	$\frac{3}{4}$.47	$\frac{1}{2}$ - $\frac{5}{8}$ - $\frac{3}{4}$ - $\frac{7}{8}$ - $\frac{15}{16}$ - 1	1	15 20 25
5J	$1\frac{1}{8}$	3.250	$\frac{15}{32}$	$\frac{3}{4}$	$1\frac{1}{8}$	$2\frac{1}{8}$	$\frac{19}{32}$	$\frac{31}{32}$.86	$\frac{1}{2}$ - $\frac{5}{8}$ - $\frac{3}{4}$ - $\frac{7}{8}$ - $\frac{15}{16}$ - 1 - $1\frac{1}{8}$	$1\frac{1}{8}$	— — —
6J	$1\frac{7}{32}$	4.000	$\frac{19}{32}$	$\frac{7}{8}$	$1\frac{1}{8}$	$3\frac{1}{8}$	$\frac{5}{8}$	$1\frac{13}{32}$	1.73	$\frac{5}{8}$ - $\frac{3}{4}$ - $\frac{7}{8}$ - $\frac{15}{16}$ - 1	—	— — —
	$1\frac{1}{2}$	4.000	$\frac{19}{32}$	$\frac{7}{8}$	$2\frac{1}{2}$	$3\frac{1}{8}$	$\frac{5}{8}$	$1\frac{13}{32}$	1.70	$1\frac{1}{8}$ - $1\frac{1}{16}$ - $1\frac{1}{4}$ - $1\frac{3}{8}$	$1\frac{1}{8}$	— — —

* Approximate weight for each flange.
 ** 3/8" Bore has no Keyway
 • J flanges can be rebored if necessary.

Type S Flanges

QUADRA-FLEX® Type S Couplings (Bored to Size)

Type S flexible coupling flanges are bored to size to fit on any standard shaft. They are produced from high strength cast iron. Units are easy to install and remove and are stocked in a wide range of bore sizes as shown on the next page.

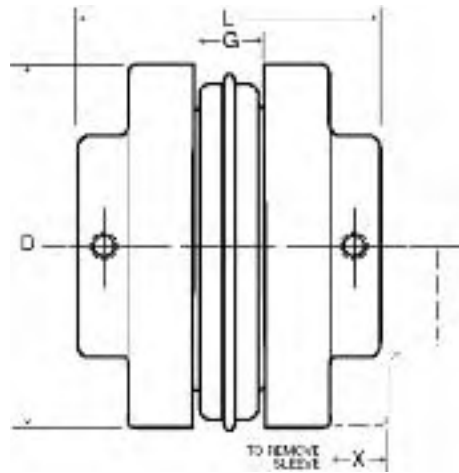

Dimensions

Coupling Size	Flange Diameter (D)	Bore (Inches)			Hub (Inches)			G	L	T	X	Weight (Lbs.)•
		Stock	Rec. Max.★	Rec. Max.★★	Hub Diameter (H)	Length Thru (C)	Hub Proj. (E)					
5S	3.250	½	1⅜	1¼	1½	1⅜	⅝	¾	2⅞	⅞	3⅞	1.0
6S	4.000	⅝	1⅞	1½	2½	1⅝	1⅞	⅞	3½	¾	1⅞	2.1
	4.000	⅝	—	1⅞	2½	1⅞	1⅞	⅞	4	¾	1⅞	2.1
7S	4.625	⅝	1⅞	1⅞	2⅞	1⅞	1⅞	1	3⅞	⅞	1⅞	2.7
8S	5.450	¾	1⅞	2¼	3¼	2⅞	¾	1⅞	4⅞	⅞	1⅞	4.5
	5.450	¾	—	2⅞	3¼	1⅞	1⅞	1⅞	5	⅞	1⅞	4.5
9S	6.350	¾	2⅞	2½	3⅞	2⅞	⅞	1⅞	5⅞	1⅞	1⅞	6.5
	6.350	¾	—	2⅞	4⅞	2⅞	1¼	1⅞	6	1⅞	1⅞	6.5
10S	7.500	1⅞	2⅞	3⅞	4⅞	2⅞	1⅞	1⅞	5⅞	1⅞	2	11.3
	7.500	1⅞	—	3⅞	4⅞	2⅞	1⅞	1⅞	7	1⅞	2	11.3
11S	8.625	1¼	3⅞	3⅞	5¼	3⅞	1⅞	1⅞	7⅞	1⅞	2⅞	17.6
	8.625	1¼	—	3⅞	5¼	3⅞	1⅞	1⅞	8	1⅞	2⅞	17.6
12S	10.000	1⅞	3⅞	3⅞	5¼	4	1⅞	2⅞	8¼	1⅞	2⅞	27.2
13S	11.750	2	4⅞	—	6¼	4⅞	1⅞	2⅞	9¼	1⅞	3⅞	45.6
14S	13.875	2	5	—	7¼	4⅞	1⅞	3¼	9⅞	2¼	3⅞	70.0
16S	18.875	2	5⅞	6	8	6	2	4¼	14¼	2¼	4¼	162.0

★ Recommended max. bore with standard keyway.

★★ Recommended max. bore with shallow keyway. See chart on page C-18 for recommended keyway size.

• Approximate weight for each flange.

Type S QUADRA-FLEX® Couplings Finished Bore Sizes

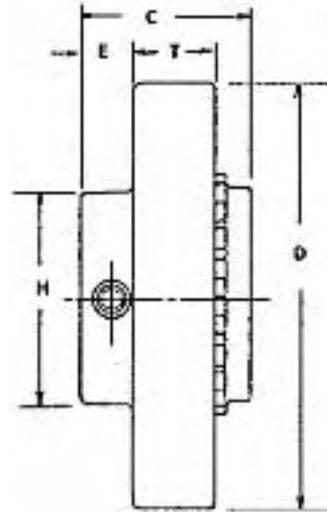

Inches / Millimeters

Coupling Size	Finished Bore Sizes																									
	Inches / mm																									
5S	5/8	3/4	7/8	1	1 1/8	1 1/4	1 1/2	1 3/4	1 7/8	2	15mm	20mm	25mm													
6S	3/4	7/8	1	1 1/8	1 1/4	1 1/2	1 3/4	1 7/8	2	1 1/2	20mm	25mm	28mm	30mm	35mm											
7S	3/4	7/8	1	1 1/8	1 1/4	1 1/2	1 3/4	1 7/8	2	1 1/2	1 3/4	1 1/2	1 3/4	1 1/2	1 3/4	1 1/2	25mm	28mm	30mm	38mm	42mm					
8S	7/8	1	1 1/8	1 1/4	1 1/2	1 3/4	1 7/8	2	1 1/2	1 3/4	1 1/2	1 3/4	1 1/2	1 3/4	1 1/2	1 3/4	2 1/8	2 1/4	28mm	30mm	32mm	38mm	42mm	48mm		
9S	1 1/8	1	1 1/8	1 1/4	1 1/2	1 3/4	1 7/8	2	1 1/2	1 3/4	1 1/2	1 3/4	1 1/2	1 3/4	2	2 1/8	2 1/4	2 1/2	2 3/8	2 1/2	2 3/4	30mm	32mm	38mm	42mm	48mm
10S	1 1/4	1 1/4	1 1/2	1 3/4	1 1/2	1 3/4	1 1/2	1 3/4	1 1/2	1 3/4	2	2 1/8	2 1/4	2 1/2	2 3/8	2 1/2	2 3/4	2 1/2	2 3/4	2 1/2	2 3/4	2 1/2	2 3/4	55mm	60mm	
11S	1 1/4	1 1/2	1 3/4	1 1/2	1 3/4	1 1/2	1 3/4	2 1/8	2 1/4	2 1/2	2 3/8	2 1/2	2 3/4	2 1/2	3											
12S	1 1/2	2 1/8	2 1/4	2 1/2	3	3 1/8	3 1/4	90mm																		
13S	2 1/4	2 1/2	3																							
14S	2 1/2																									
16S	o																									

o Plain bore only.

Keyseat Dimensions



COUPLINGS

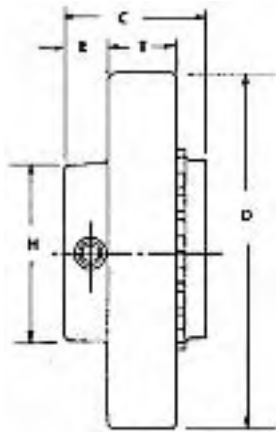

Standard Keyway Dimensions

Shaft Diameter	Width	Depth
1/2-3/8	3/8	1/16
3/8-1/2	1/2	3/32
15/16-1 1/4	1/2	1/8
1 1/16-1 1/8	3/8	5/32
1 1/8-1 1/4	3/8	3/16
1 1/16-2 3/4	1/2	1/4
2 3/16-2 3/8	5/8	5/16
2 3/16-3 1/4	3/4	3/8
3 3/16-3 3/8	7/8	7/16
3 3/16-4 1/2	1	1/2
4 7/16-5 1/2	1 1/4	5/8
5 7/16-6 1/2	1 1/2	3/4

Bore Tolerances for Types J and S Flanges, SC Hubs

Bore (Inch)	Tolerance (Inch)
UP to 1	+0.0000 to +.0010
1 1/16 to 2 1/8	+0.0000 to +.0015
2 3/16 to 2 3/8	+0.0000 to +.0020
2 11/16 to 3 11/16	+0.0000 to +.0025
3 3/8 to 4 3/8	+0.0000 to +.0030
4 11/16 to 6	+0.0000 to +.0035

These bores provide a slip fit.

Shallow Keyseat Dimensions

Coupling Size	Hub Dia. (H)	Length Thru (C)	Shallow Keyseat Dimensions								
			Bore	Keyway	Key	Bore	Keyway	Key	Bore	Keyway	Key
6S	2 1/2	1 5/16	1 5/8	3/8 x 1/8	3/8 x 5/16 x 1 1/4	1 3/4	3/8 x 1/16	3/8 x 1/4 x 1 1/4	1 7/8	1/2 x 1/16	1/2 x 5/16 x 1 1/2
	2 3/16	1 1/16									
7S	2 13/16	1 27/32	1 7/8	1/2 x 1/8	1/2 x 3/8 x 1 13/16	2 3/8	5/8 x 1/8	5/8 x 1/4 x 1 15/16	2 3/8	5/8 x 1/8	5/8 x 1/4 x 1 15/16
	2 3/8	1 15/16									
8S	3 1/4	2 3/16	2 1/8	1/2 x 3/16	1/2 x 7/16 x 2 1/16	2 3/8	5/8 x 1/8	5/8 x 1/4 x 1 15/16	2 3/8	5/8 x 1/8	5/8 x 1/4 x 1 15/16
	3 1/4	1 15/16									
9S	3 3/8	2 13/32	2 1/2	5/8 x 3/16	5/8 x 3/8 x 2 3/8	2 7/8	3/4 x 1/8	3/4 x 1/2 x 2 1/8	2 7/8	3/4 x 1/8	3/4 x 1/2 x 2 1/8
	4 1/8	2 3/32									
10S	4 3/8	2 21/32	2 7/8	3/4 x 1/4	3/4 x 5/8 x 2 11/16	3 3/8	7/8 x 3/16	7/8 x 3/8 x 2 11/16	3 3/8	7/8 x 3/16	7/8 x 3/8 x 2 11/16
	4 3/8	2 11/16									
11S	3 1/4	3 1/16	3 3/8	1 x 1/4	1 x 3/4 x 3	3 3/8	1 x 3/4	1 x 3/4 x 3	3 3/8	1 x 1/4	1 x 3/4 x 3
	4 3/8	3 3/8									
	5 1/8	3 3/8									
	5 3/8	3 1/16									
12S	3 3/8	4	3 15/16	1 x 1/4	1 x 3/4 x 3 15/16	3 3/8	1 x 3/4	1 x 3/4 x 3 15/16	3 3/8	1 x 1/4	1 x 3/4 x 3 15/16
	4 3/8	4									
	5 3/8	4									

Type B Bushed QUADRA-FLEX®

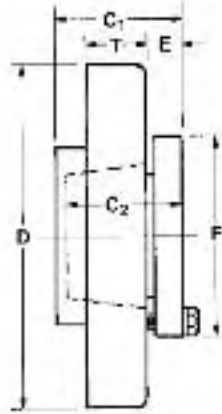

Flanges

Type B flanges are made of high quality cast iron. The same high strength cast iron used in the Type S and SC QUADRA-FLEX flanges. Type B is designed to accommodate *Martin* QD bushings for easy installation and removal. Type B flanges are not intended for use with Hytrel sleeves.

Coupling Size	Bushing Required	Dimensions										Max. Bore★	Weight Lbs.†	
		C ₁	C ₂	D	E	F	G	L	T	X	Flange		Bushing	
6B	JA	1 ¹ / ₂	1	4.000	3	2	3	3	25	1	1	1.7	.9	
7B	JA	1 ⁹ / ₃₂	1	4.625	3	2	1	3	25	1	1	2.0	1.0	
8B	SH	1 ⁷ / ₃₂	1 ¹ / ₄	5.450	1	2	1	3	29	1	3.1	1.0		
9B	SD	2	1	6.350	3	1	4	1	1	4.9	1.5			
10B	SK	1 ⁹ / ₃₂	1 ¹ / ₈	7.500	5	3	1	5	1	2	7.0	2.0		
11B	SF	2	2	8.625	5	4	1	6	1	2	11.8	3.0		
12B	E	2	2	10.000	6	2	7	1	2	17.2	10.0			
13B	F	3	3	11.750	1	6	2	8	1	3	30.5	11.5		
14B	F	3	3	13.875	1	6	3	9	2	3	51.0	11.5		
16B	J	4	4	18.875	1	7	4	12	2	4	120.0	18.0		

★ Maximum bore with keyseat.
 † Approximate weight for each flange.

QD Bushing Keyway Dimensions

Bushing	Bores	Keyseat
JA	1/2 - 1	STANDARD
	1 1/16 - 1 1/8	1/4 x 1/16
	1 3/16	1/4 x 1/16
	1 1/4	NO K.S.
SH	1/2 - 1 3/8	STANDARD
	1 1/16 - 1 1/8	3/8 x 1/16
	1 1/16	NO K.S.
SD	1/2 - 1 1/16	STANDARD
	1 1/8	3/8 x 1/16
	1 3/16	1/2 x 1/16
	1 1/8 - 1 15/16	1/2 x 1/16
2	2	NO K.S.
	2	NO K.S.
	2	NO K.S.
	2	NO K.S.
SK	1/2 - 2 1/8	STANDARD
	2 3/16 - 2 1/4	1/2 x 1/16
	2 5/16 - 2 1/2	3/8 x 1/16
	2 7/16 - 2 5/8	NO K.S.
SF	1/2 - 2 1/4	STANDARD
	2 3/16 - 2 1/2	5/8 x 3/16
	2 5/16 - 2 3/4	3/4 x 1/16
	2 7/16 - 2 5/8	3/4 x 1/16
2 15/16	2 15/16	3/4 x 1/2
	2 15/16	3/4 x 1/2
	2 15/16	3/4 x 1/2
	2 15/16	3/4 x 1/2
E	1/2 - 2 1/4	STANDARD
	2 3/16 - 3 1/4	1/2 x 1/16
	3 3/16 - 3 3/8	3/8 x 1/16
	3 1/2	1/2 x 1/16
F	1 - 3 3/16	STANDARD
	3 3/8 - 3 3/4	1/2 x 3/16
	3 15/16 - 3 5/8	1 x 1/16
	4	NO K.S.
J	1 1/4 - 3 3/4	STANDARD
	3 3/16 - 3 3/8	1 x 1/16
	4 - 4 1/2	1 x 1/16

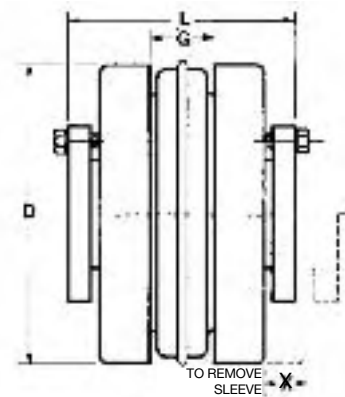

Bushings

Martin QD bushings offer convenient mounting of the flange to the shaft securely without setscrews. They are tapered and are split through both the bushing flange and taper to provide a clamp fit, eliminating wobble, vibration, and fretting corrosion. This is the same bushing used in *Martin* sprockets and sheaves and is readily available.

Type SC Spacer Couplings



COUPLINGS

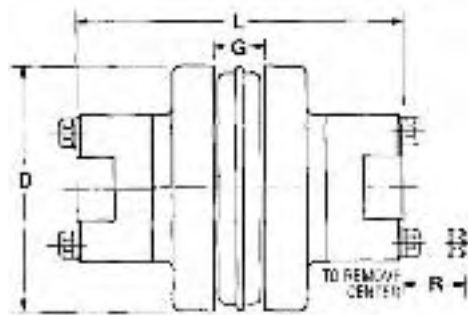

The dimensions for completely assembled QUADRA-FLEX® Type SC Spacer Couplings are shown below. See next page for dimensions of separate components.

Coupling Size	Required Distance Between Shafts	Use Flange Number	Use Hub Number	Max. Bore Standard Keyway	Dimensions				Weight ² (Lbs.) [•]
					D	L ²	G	R	
4JSC	3½	4JSC35	4H	1½	2.460	5%	¾	½	4.7
5SC	3½	5SC35	5H	1½	3.250	5%	¾	⅝	4.1
6SC	3½	6SC35	6H	1½	4.000	5%	¾	¾	7.1
6SC	4%	6SC44	6H	1½	4.000	6%	¾	¾	7.9
6SC	5	6SC50	6H	1½	4.000	7%	¾	¾	8.5
7SC	3½	7SC35	7H	1½	4.625	6%	1	¾	9.1
7SC	4%	7SC44	7H	1½	4.625	7%	1	¾	10.1
7SC	5	7SC50	7H	1½	4.625	7%	1	¾	10.7
8SC	3½	8SC35	8H	1½	5.450	6%	1⅛	⅞	14.7
8SC	3½	8SC35-10	10H★	2%	5.450	8%	1⅛	⅞	22.7
8SC	4%	8SC44	8H	1½	5.450	7%	1⅛	⅞	16.1
8SC	5	8SC50	8H	1½	5.450	8%	1⅛	⅞	15.9
8SC	5	8SC50-10	10H★	2%	5.450	9%	1⅛	⅞	26.5
9SC	3½	9SC35	9H★	2%	6.350	7%	1⅛	1⅞	22.0
9SC	4%	9SC44	9H★	2%	6.350	8%	1⅛	1⅞	23.4
9SC	5	9SC50	9H★	2%	6.350	8%	1⅛	1⅞	24.6
9SC	5	9SC50-11	11H★	2%	6.350	10%	1⅛	1⅞	40.2
9SC	7	9SC70-11	11H★	2%	6.350	12%	1⅛	1⅞	48.2
9SC	7%	9SC78-11	11H★	2%	6.350	13%	1⅛	1⅞	50.8
10SC	4%	10SC48	10H★	2%	7.500	9%	1⅛	1⅞	35.4
10SC	5	10SC50	10H★	2%	7.500	9%	1⅛	1⅞	38.2
10SC	7	10SC70-13	13H★	3%	7.500	13%	1⅛	1⅞	71.8
10SC	7%	10SC78-13	13H★	3%	7.500	14%	1⅛	1⅞	75.6
10SC	10	10SC100-13	13H★	3%	7.500	16%	1⅛	1⅞	89.0
11SC	4%	11 SC48	11H★	2%	8.625	10%	1⅛	1⅞	54.5
11SC	5	11 SC50	11H★	2%	8.625	10%	1⅛	1⅞	54.8
11SC	7	11SC70-14	14H	3%	8.625	14%	1⅛	2	85.7
11SC	7%	11SC78-14	14H	3%	8.625	15%	1⅛	2	90.1
11SC	10	11SC100-14	14H	3%	8.625	17%	1⅛	2	102.5
12SC	7	12SC70	12H★	2%	10.000	12%	2⅞	1½	87.7
12SC	7	12SC70-14	14H	3%	10.000	14%	2⅞	2	98.9
12SC	7%	12SC78	12H★	2%	10.000	13%	2⅞	1½	91.5
12SC	7%	12SC78-14	14H	3%	10.000	15%	2⅞	2	103.3
12SC	10	12SC100-14	14H	3%	10.000	17%	2⅞	2	115.5
13SC	7%	13SC78	13H★	3%	11.750	14%	2⅞	1½	121.8
14SC	7%	14SC78	14H	3%	13.875	15%	3¼	2	179.4

★ Short (HS) hub also available.
 • Approximate weight for completely assembled spacer coupling.
 1 4JSC35 x 1½ has a shallow keyway.
 2 "L" dimension and weight will change if one or two short (HS) hubs are used.
 NOTE: Refer to page C-23 to order — specify components separately.



Type SC Flanges and Hubs

Tables below provide dimensional information for QUADRA-FLEX® Flanges and Hubs used for Spacer Couplings. Assembled dimensions are listed on opposite page. Any of the sleeves shown on page C-14 can be used.

Coupling Size	Flange Number	For Distance Between Shafts★	For Hub	Dimensions					Weight (Lbs.)•
				D	E	H	C	T	
4JSC	4SC35	3½	4H	2.460	⅞	2	⅞	⅞	1.2
5SC	5SC35	3½	5H	3.250	⅝¼	2	1⅞	⅞	1.2
6SC	6SC35	3½	6H	4.000	⅞	2½	1⅞	⅞	2.0
	6SC44	4⅞	6H	4.000	1⅞	2⅞	2⅞	⅞	2.4
	6SC50	5	6H	4.000	1⅞	2⅞	2⅞	⅞	2.7
7SC	7SC35	3½	7H	4.625	⅞	2⅞	1⅞	⅞	2.3
	7SC44	4⅞	7H	4.625	⅞	2⅞	2⅞	⅞	2.8
	7SC50	5	7H	4.625	1⅞	2⅞	2⅞	⅞	3.1
8SC	8SC35	3½	8H	5.450	⅞	3¼	1⅞	⅞	3.5
	8SC35-10	3½	10H-10HS	5.450	⅞	4⅞	1⅞	⅞	3.4
	8SC44	4⅞	8H	5.450	⅞	3¼	2⅞	⅞	4.2
	8SC50	5	8H	5.450	1⅞	3¼	2⅞	⅞	4.6
	8SC50-10	5	10H-10HS	5.450	1⅞	4⅞	2⅞	⅞	5.3
9SC	9SC35	3½	9H-9HS	6.350	⅞	3⅞	1⅞	⅞	5.1
	9SC44	4⅞	9H-9HS	6.350	⅞	3⅞	2⅞	1⅞	5.8
	9SC50	5	9H-9HS	6.350	⅞	3⅞	2⅞	1⅞	6.4
	9SC50-11	5	11H-11HS	6.350	⅞	5¼	2⅞	1⅞	6.9
	9SC70-11	7	11H-11HS	6.350	1¼	5¼	3⅞	1⅞	10.9
9SC78-11	7¼	11H-11HS	6.350	2⅞	5¼	3⅞	1⅞	12.1	
10SC	10SC48	4⅞	10H-10HS	7.500	⅞	4⅞	2¼	1⅞	9.8
	10SC50	5	10H-10HS	7.500	⅞	4⅞	2⅞	1⅞	10.1
	10SC70-13	7	13H-13HS	7.500	1⅞	6⅞	3⅞	1⅞	14.5
	10SC78-13	7¼	13H-13HS	7.500	1⅞	6⅞	3¼	1⅞	16.3
	10SC100-13	10	13H-13HS	7.500	2⅞	6⅞	4⅞	1⅞	22.5
11SC	11SC48	4⅞	11H-11HS	8.625	⅞	5¼	1⅞	1⅞	12.5
	11SC50	5	11H-11HS	8.625	⅞	5¼	1⅞	1⅞	12.7
	11SC70-14	7	14H	8.625	1⅞	6⅞	2⅞	1⅞	16.1
	11SC78-14	7¼	14H	8.625	1⅞	6⅞	2⅞	1⅞	18.3
	11SC100-14	10	14H	8.625	2⅞	6⅞	4⅞	1⅞	24.5
12SC	12SC70	7	12H-12HS	10.000	⅞	5¼	2⅞	1⅞	23.2
	12SC70-14	7	14H	10.000	⅞	6⅞	2⅞	1⅞	21.2
	12SC78	7¼	12H-12HS	10.000	1⅞	5¼	2⅞	1⅞	25.1
	12SC78-14	7¼	14H	10.000	1⅞	6⅞	2⅞	1⅞	23.4
	12SC100-14	10	14H	10.000	2⅞	6⅞	3⅞	1⅞	29.5
13SC	13SC78	7¼	13H-13HS	11.750	⅞	6⅞	3¼	1⅞	38.4
14SC	14SC78	7¼	14H	13.875	⅞	6⅞	2⅞	2¼	55.0

★ Flanges can be mixed to form different Between-Shaft Dimensions. See chart on page 23.
 • Approximate weight for each flange.

SC Spacer Hub Bores



COUPLINGS

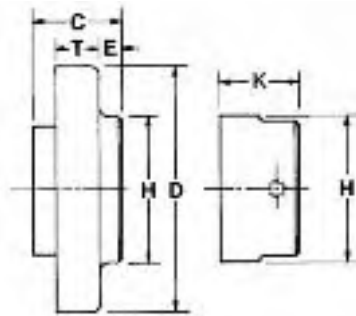
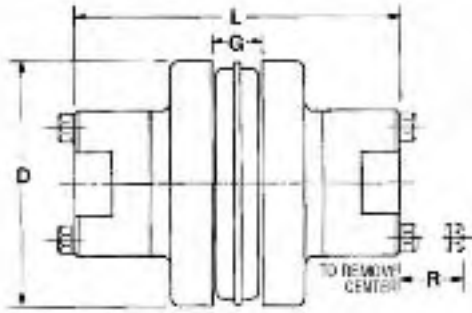

Coupling Size	Hub Number	Max. Bore	Stock Bores		Dimensions			Weight (Lbs.)*
			Plain Bore	Bore with Standard Keyway and Setscrew	K	H	Cap Screws Furnished	
4JSC	4H	1 $\frac{1}{8}$	$\frac{1}{2}$	$\frac{5}{8} - \frac{7}{8} - 1 - 1\frac{1}{8}$ ★	1 $\frac{1}{8}$	2	4 - 10x2	1.1
5SC	5H	1 $\frac{1}{8}$	$\frac{1}{2}$	$\frac{5}{8} - \frac{3}{4} - \frac{1}{2} - 1 - 1\frac{1}{8}$	1 $\frac{3}{32}$	2	4 - 10x1 $\frac{1}{2}$.7
6SC	6H	1 $\frac{1}{8}$	$\frac{5}{8}$	$\frac{3}{4} - \frac{7}{8} - 1 - 1\frac{1}{8} - 1\frac{1}{4} - 1\frac{1}{8}$	1 $\frac{1}{32}$	2 $\frac{1}{2}$	4 - $\frac{1}{4}$ x1 $\frac{1}{4}$	1.3
7SC	7H	1 $\frac{1}{8}$	$\frac{5}{8}$	$\frac{7}{8} - 1 - 1\frac{1}{8} - 1\frac{1}{8} - 1\frac{1}{2} - 1\frac{1}{8}$	1 $\frac{5}{32}$	2 $\frac{3}{16}$	4 - $\frac{1}{4}$ x1 $\frac{1}{4}$	1.9
8SC	8H	1 $\frac{1}{8}$	$\frac{3}{4}$	$\frac{7}{8} - 1 - 1\frac{1}{8} - 1\frac{1}{8} - 1\frac{1}{2} - 1\frac{1}{8} - 1\frac{3}{4} - 1\frac{1}{8}$	1 $\frac{9}{32}$	3 $\frac{1}{4}$	4 - $\frac{7}{8}$ x2 $\frac{1}{4}$	3.2
9SC	9H	2 $\frac{1}{8}$	$\frac{7}{8}$	1 - 1 $\frac{1}{8}$ - 1 $\frac{1}{8}$ - 1 $\frac{1}{2}$ - 1 $\frac{1}{8}$ - 1 $\frac{1}{4}$ - 1 $\frac{1}{8}$ - 2 $\frac{1}{8}$	1 $\frac{3}{32}$	3 $\frac{3}{8}$	4 - $\frac{3}{8}$ x2 $\frac{3}{4}$	4.4
	9HS	1 $\frac{1}{2}$	1 $\frac{1}{8}$	1 $\frac{1}{32}$	3 $\frac{3}{8}$	4 - $\frac{3}{8}$ x2 $\frac{1}{4}$	3.7
10SC	10H	2 $\frac{1}{8}$	1 $\frac{1}{8}$	1 $\frac{1}{8}$ - 1 $\frac{1}{8}$ - 2 $\frac{1}{8}$ - 2 $\frac{1}{8}$	2 $\frac{1}{32}$	4 $\frac{3}{8}$	4 - $\frac{7}{8}$ x3	7.3
	10HS	1 $\frac{1}{8}$	1 $\frac{1}{8}$	1 $\frac{1}{32}$	4 $\frac{3}{8}$	4 - $\frac{7}{8}$ x2 $\frac{1}{2}$	5.5
11SC	11H	2 $\frac{1}{8}$	1 $\frac{1}{8}$	1 $\frac{1}{8}$ - 2 $\frac{1}{8}$ - 2 $\frac{1}{8}$ - 2 $\frac{1}{8}$	2 $\frac{3}{32}$	5 $\frac{1}{4}$	4 - $\frac{1}{2}$ x3 $\frac{1}{2}$	12.2
	11HS	1 $\frac{1}{8}$	1 $\frac{1}{8}$ - 1 $\frac{1}{8}$	1 $\frac{1}{32}$	5 $\frac{1}{4}$	4 - $\frac{1}{2}$ x2 $\frac{3}{4}$	9.3
12SC	12H	2 $\frac{1}{8}$	1 $\frac{1}{8}$	1 $\frac{1}{8}$ - 2 $\frac{1}{8}$ - 2 $\frac{1}{8}$ - 2 $\frac{1}{8}$	2 $\frac{3}{32}$	5 $\frac{1}{4}$	4 - $\frac{5}{8}$ x4	16.6
	12HS	2 $\frac{1}{2}$	2 $\frac{1}{8}$	2 $\frac{1}{32}$	5 $\frac{1}{4}$	4 - $\frac{5}{8}$ x3 $\frac{1}{2}$	14.1
13SC	13H	3 $\frac{1}{8}$	2 $\frac{1}{8}$ - 2 $\frac{1}{8}$ - 3 $\frac{1}{8}$	3 $\frac{1}{32}$	6 $\frac{1}{8}$	4 - $\frac{5}{8}$ x4 $\frac{1}{2}$	19.9
	13HS	2 $\frac{1}{2}$	2 $\frac{1}{8}$ - 2 $\frac{1}{8}$	2 $\frac{1}{32}$	6 $\frac{1}{8}$	4 - $\frac{5}{8}$ x3 $\frac{1}{2}$	16.0
14SC	14H	3 $\frac{1}{8}$	2 $\frac{1}{8}$ - 2 $\frac{1}{8}$ - 3 $\frac{1}{8}$ - 3 $\frac{1}{8}$	3 $\frac{1}{32}$	6 $\frac{1}{2}$	4 - $\frac{5}{8}$ x5	24.2

★ 4JSC x 1 $\frac{1}{8}$ has a shallow keyseat.
 • Approximate weight for each hub.

QUADRA-FLEX® Between-Shaft Spacings

Spacer couplings are available with the most popular between shaft dimensions. Spacings other than standard can be achieved by mixing flanges.

The “Standard” column provides spacings using identical

flanges; the “Combination” column provides spacings with mixed flanges; the column headed “Semi-Spacer” uses one flange that is not made for spacer coupling and therefore does not have a detachable hub.

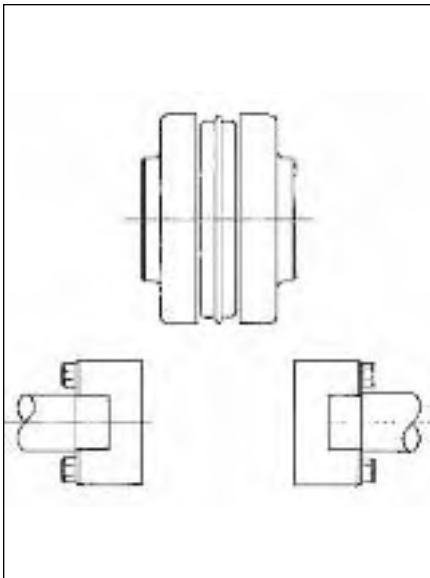

Standard

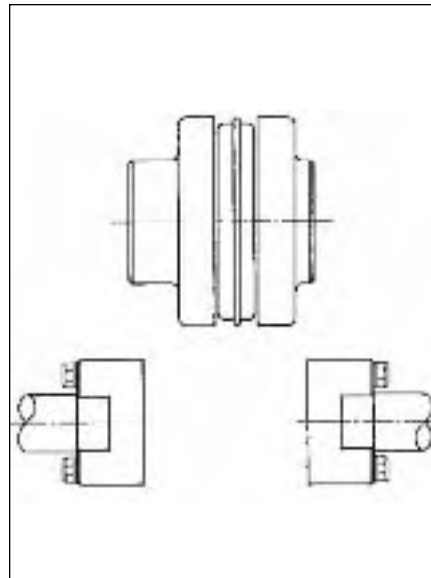

Combination

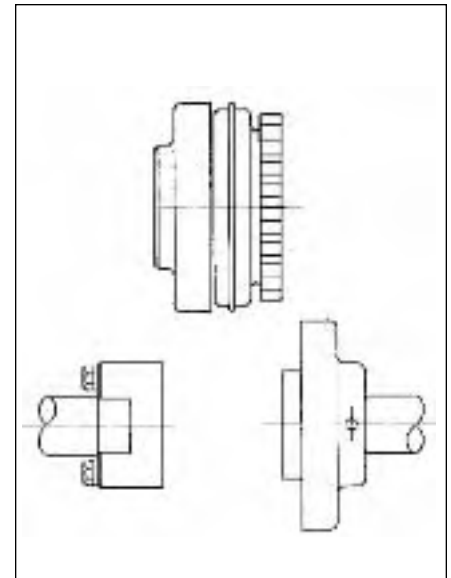

Semi-Spacer

Standard	
Spacing	Use Flanges★
3½	2 - () SC35
4½	2 - () SC44
5	2 - () SC50
7	2 - () SC70
7½	2 - () SC78
10	2 - () SC100

Combination	
Spacing	Use Flanges★
3⅝	SC35 & SC44
4½	SC35 & SC50
4⅞	SC44 & SC50
5¼	SC35 & SC70
5½	SC35 & SC78
5⅞	SC44 & SC70
6	SC50 & SC70
6⅛	SC44 & SC78
6½	SC50 & SC78
6¾	SC35 & SC100★★
7⅛	SC44 & SC100★★
7⅜	SC70 & SC78
7½	SC50 & SC100
8½	SC70 & SC100
8¾	SC78 & SC100

Semi-Spacer	
Spacing	Use Flanges★
1½	S & SC35
2⅝	S & SC44
2½	S & SC50
3½	S & SC70
4	S & SC78
5½	S & SC100

★ Check individual coupling size for flange availability.

★★ Non-Stock

NOTE: Other combinations available — consult factory.

Installation Instructions



Martin QUADRA-FLEX® flanges (hubs) and elastomeric elements (sleeves) come in a wide range of sizes and types. First, determine the size and type of coupling components required. Remove all components from their boxes and loosely assemble the coupling. Do not install the wire ring on the two piece sleeves at this time. Check maximum RPM values in table against operating speeds.

Martin EM sleeves are rated the same as other EPDM and Neoprene sleeves, and may be used interchangeably; however, Hytrel sleeves are rated at different values and may not be interchanged with *Martin* EM sleeves, or the EPDM and Neoprene sleeves. Check horsepower and torque ratings when selecting Hytrel sleeves.



Step 1. Make sure the motor driving the part or components is locked out electrically in such a manner that it cannot be started by anyone, however remote from the area. The same type of lockout procedure applies to any other driving device which may be used. Failure to follow these instructions may result in personal injury or property damage.

Step 2. Prepare shafts for coupling installation. Inspect all coupling components and remove any protective coating or lubricants from bores, mating surfaces, and fasteners.

Step 3. Slide one coupling flange onto each prepared shaft using key stock where required. With the QD Type B flange, it may be necessary to expand the QD bushing bore for ease of installation.

Step 4. Position the flange on the shafts to achieve the approximate “Y” dimension (distance between flanges) shown in table. It is best to have equal shaft length into each flange. Tighten one flange in position, and slide the other flange sufficient distance back to install sleeve. Do not install wire ring on two piece sleeve in its final position at this time, but allow it to hang loosely in groove next to teeth.

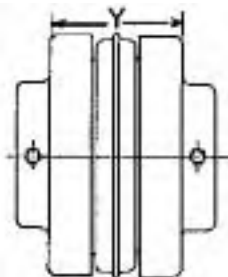

Step 5. Slide loose flange on the shaft until the sleeve has seated completely in teeth of both flanges. Refer to “Y” dimension although not a critical dimension. Secure the flange to shaft and torque set screws and cap screws to correct



Parallel



Angular

Step 6. Check parallel alignment by placing a straight edge across the two coupling flanges and measure the maximum offset at several points around the periphery of coupling. **Do not** rotate coupling when taking these measurements. Refer to table for maximum allowed offset of parallel alignment. Realign the coupling if necessary.

Step 7. Check angular alignment with a micrometer, vernier, or caliper. Take measurement from outside to outside of flanges at several points around the periphery of coupling. **Do not** rotate coupling when taking these measurements. Determine the difference between maximum and minimum dimensions and check to make sure they do not exceed the angular figure on the table. If a correction is necessary, recheck parallel alignment.

Maximum RPM and Allowable Misalignment (Dimensions in Inches)

Sleeve Size	Max. RPM	Types JEM, EM, E and N			★Type H & HS		
		Parallel	Angular	Y	Parallel	Angular	Y
3	9200	.010	.035	1.188	—	—	—
4	7600	.010	.043	1.500	—	—	—
5	7600	.015	.056	1.938	—	—	—
6	6000	.015	.070	2.438†	.010	.016	2.500
7	5250	.020	.081	2.563	.012	.020	2.625
8	4500	.020	.094	2.938	.015	.025	3.000
9	3750	.025	.109	3.500	.017	.028	3.563
10	3600	.025	.128	4.053	.020	.032	4.125
11	3600	.032	.151	4.875	.022	.037	4.938
12	2800	.032	.175	5.688	.025	.042	5.750
13	2400	.040	.195	6.688	.030	.050	6.688
14	2200	.045	.242	7.750	.035	.060	7.813
16	1500	.062	.330	10.250	—	—	—

NOTE: Values shown above may apply if the actual torque transmitted is more than ½ the coupling rating. For lesser torque, reduce the above values by ½.

★ Type H & HS sleeves should not be used as direct replacements for JEM or EM sleeves.

† Value when using 6J flanges is 2.125.

Step 8. If the coupling employs the two-piece sleeve with wire ring, install ring in center groove of sleeve.

Note: Some force may be required to seat the ring in groove.

Step 9. Install protective guards and/or shields per OSHA and any other additional local or state safety codes as required.

WARNING: Coupling sleeves may be forced from coupling when subjected to a severe shock load or abuse.

Stock Flexible Couplings



Type TBH



Type TBF



Bored to Size
and Stock Bore



QD



Covers

Stock Flexible Couplings



All *Martin* chain couplings have hardened teeth

Bored to Size Couplings With Finished Bore, Keyway, and Set Screw

COUPLINGS

Coupling Number	Stock Finishd Bores Include Standard Keyway and Setscrew	A	B	C	L	Coupling O. D.	Weight Lbs.
4012	½, ¾, 1	1 ³ / ₂	1½	¾	2 ⁷ / ₂	2 ⁷ / ₂	.4
4016	¾, 1, 1½, 1¾, 2, 2½, 3	1 ³ / ₂	1½	¾	2 ⁷ / ₂	3 ³ / ₂	.8
5016	1, 1½, 2, 2½, 3	2½	1¾	¾	3¾	3 ³ / ₂	1.6
5018	1, 1½, 2, 2½, 3, 3½, 4	2 ³ / ₂	1 ⁷ / ₁₆	¾	3¾	4 ¹ / ₁₆	2.4
6018	1, 1½, 2, 2½, 3, 3½, 4, 4½, 5	3½	1½	7 ¹ / ₁₆	4 ³ / ₁₆	5	4.8
6020	1½, 2, 2½, 3, 3½, 4, 4½, 5	3¾	2	7 ¹ / ₁₆	4 ¹ / ₁₆	5½	5.2
6022	1½, 2, 2½, 3, 3½, 4, 4½, 5	4½	2½	7 ¹ / ₁₆	4 ¹ / ₁₆	5 ⁵ / ₁₆	7.8
8018	1½, 2, 2½, 3, 3½, 4, 4½, 5	4 ⁹ / ₁₆	2½	3 ⁷ / ₁₆	5 ³ / ₁₆	6 ³ / ₁₆	9.5
8020	1½, 2, 2½, 3, 3½, 4, 4½, 5	5	2½	3 ⁷ / ₁₆	5 ³ / ₁₆	7 ¹ / ₁₆	13.4
10018	1½, 2, 2½, 3, 3½, 4, 4½, 5	5 ¹ / ₁₆	2½	2 ³ / ₂	6 ³ / ₂	8 ⁵ / ₁₆	18.2
10020	2, 3, 3½, 4, 4½, 5	6 ³ / ₂	3½	2 ³ / ₂	6 ³ / ₂	9½	25.0
12018	3, 3½, 4, 4½, 5	6¾	3½	5 ⁵ / ₁₆	7¾	10	28.0
12022	4, 4½, 5, 5½, 6	8	4	5 ⁵ / ₁₆	8¾	11 ⁵ / ₁₆	55.0

CAUTION: All rotating power transmission products are potentially dangerous and must be properly guarded for the speeds and applications for which they were intended.

QD Couplings

Coupling Number	Bushing Used	Max. Bore**	A	B	D	C	L	Coupling O. D.	K†	Weight Lbs.
4016JA	JA	1	2	¾	1½	¾	2 ² / ₂	3 ³ / ₂	1¾	.9
5018SH	SH	1½	2 ³ / ₂	1	1½	¾	3	4 ¹ / ₁₆	1¾	1.3
6020SK	SK	2	3	1¼	1½	7 ¹ / ₁₆	4 ¹ / ₁₆	5½	2¼	2.5
8018SF	SF	2½	4 ¹ / ₁₆	1	2	3 ⁷ / ₁₆	5 ² / ₁₆	6 ³ / ₂	2¼	5.3

** Maximum bore shown is the maximum bore with standard keyway. It is recommended that this maximum not be exceeded in both halves of a coupling.

† Minimum clearance required to remove the coupling half by using the screws as jack screws.

Taper Bushed Couplings Type TBH and TBF

Type TBH Coupling Number	Type TBF Coupling Number	Bushing Data			A	B	C	J*	K†	L	OD	Weight Lbs.
		Bushing Used	Max. Bore	Min. Bore								
4016TBH	4016TBF	1108	1½	½	1 ³ / ₂	¾	¾	¾	¾	2 ⁷ / ₂	3 ³ / ₂	.9
5018TBH	5018TBF	1610	1½	½	2 ³ / ₂	1	¾	1 ¹ / ₁₆	1 ¹ / ₁₆	2	4 ¹ / ₁₆	1.1
6020TBH	6020TBF	2012	2	½	3	1¼	7 ¹ / ₁₆	1 ¹ / ₁₆	1 ¹ / ₁₆	2 ¹⁵ / ₁₆	5½	2.7
8020TBH	8020TBF	3020	3	1 ¹ / ₁₆	5	2	3 ⁷ / ₁₆	1 ¹ / ₁₆	2 ¹ / ₁₆	4 ³ / ₁₆	7 ¹ / ₁₆	6.1
10020TBH	10020TBF	3535	3½	1 ¹ / ₁₆	6 ³ / ₂	3½	2 ³ / ₂	2	2 ⁵ / ₁₆	7 ³ / ₂	9½	19.0

* Space needed for (1) tightening bushing with shortened hex key (2) loosening screws for puller to remove hub.

† Minimum clearance required to remove the coupling half by using the screws as jack screws with shortened hex key.

Our Standard Covers Fit These Couplings

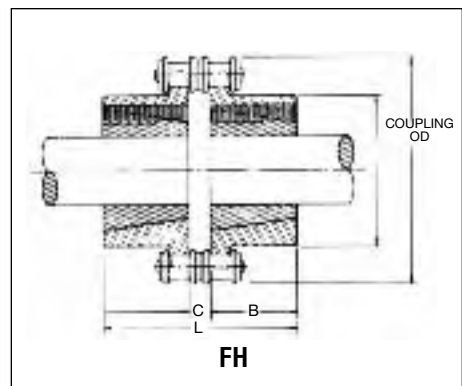
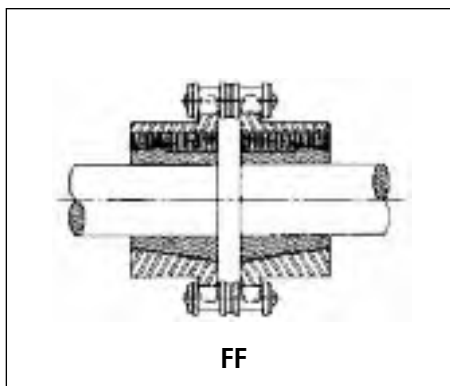
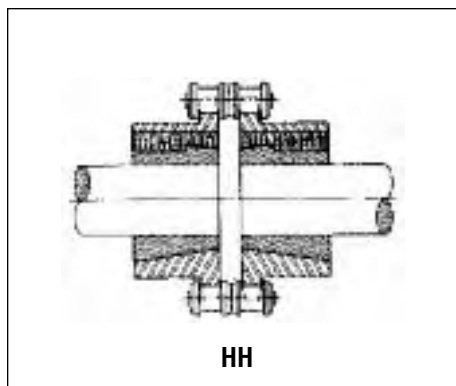

All *Martin* chain couplings have hardened teeth

Coupling Selection

Roller chain couplings have a torque capacity in excess of the torque normally transmitted by shafting which falls within the coupling bore range. Select the smallest coupling which will accommodate both shafts. For a reversing operation, shock or pulsating loads, or other severe operating conditions, select the next larger coupling size.

A cover should be used to assure maximum service life, particularly if the coupling operates at high speeds or under moist conditions. For proper lubrication, fill the space between the cover and the coupling with soft to medium consistency coupling grease.

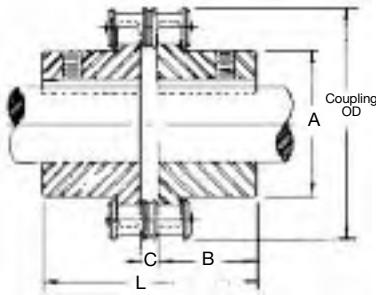

BS Coupling

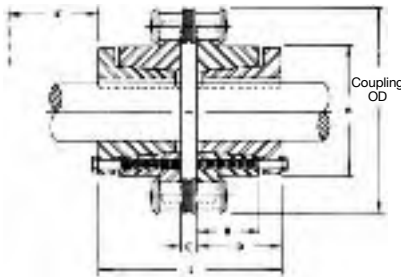

QD Coupling



Type TBF



Type TBH

Coupling With Plain Bores for Reboring

Coupling Number	Maximum Bore Inches	Minimum Plain Bore Inches	Weight (Lbs.)	Recommended Maximum RPM	Coupling Chain Number	Weight Lbs.
4012	7/8	3/8	.5	5000	4012 CHN	.4
4016	1 1/8	3/8	1.0	5000	4016 CHN	.5
5016	1 1/2	3/8	2.2	4000	5016 CHN	1.2
5018	2	3/8	3.5	3600	5018 CHN	1.3
6018	2 1/8	1	5.0	3000	6018 CHN	2.2
6020	2 3/8	1 1/8	6.5	2500	6020 CHN	2.6
6022	3	1 1/8	9.4	2500	6022 CHN	2.7
8018	3 1/8	1 1/8	11.0	2000	8018 CHN	5.3
8020	3 3/8	1 1/2	16.3	2000	8020 CHN	5.9
10018	3 3/8	1 1/8	20.3	1800	10018 CHN	9.8
10020	4 5/8	1 1/2	31.8	1800	10020 CHN	10.9
12018	4 1/8	2	36.8	1500	12018 CHN	17.3
12022	6 1/8	2	70.0	1200	12022 CHN	21.2

Stock Coupling Covers

Covers Fit Taper Bushed, QD and Stock, and Finished Bore Couplings. Covers allow excellent lubrication, and their use is recommended to obtain maximum coupling life. Covers are of aluminum and are made in halves for easy installation. Synthetic rubber oil seals, which contact the coupling hubs, retain the lubricant and prevent the entry of dirt. Covers are fitted with gaskets between the halves.

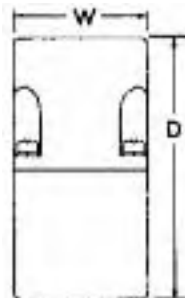

Aluminum
and
Plastic

Cover Cat. No.	Aluminum		Plastic		Wt. Lbs.
	D	W	D	W	
4012COV**	4	2	4	2 5/16	.78
4016COV**	4	2	4	2 5/16	.92
5016COV**	5 1/8	2 3/8	5 1/8	2 3/8	1.30
5018COV**	5 1/8	2 3/8	5 1/8	2 3/8	1.30
6018COV**	6 1/8	2 7/16	6 1/8	3 1/16	2.44
6020COV**	6 1/8	2 7/16	6 1/8	3 1/16	2.44
6022COV**	8 3/8	4	8 3/8	4	4.88
8018COV	8 3/8	4	8 3/8	4	4.88
8020COV	8 3/8	4	8 3/8	4	4.88
10018COV	9 1/8	5 1/16	9 1/8	5 1/16	8.76
10020COV	10 1/8	5 1/4	10 1/8	5 1/4	12.66
12018COV	11 1/8	7 1/8	11 1/8	7 1/8	16.46
12022COV	13 1/4	7 5/16	13 1/4	7 5/16	19.50

* Use 8018 cover — Special Seals Available
 ** Furnished in Plastic unless specified with "AL" Suffix when ordering.

Flexible Jaw Couplings

Martin

COUPLINGS



Martin Universal (ML)



Martin Super (MS)



Now *Martin* Offers Two Styles
The *Martin Super* — Higher Horsepower
The *Martin Universal* — Completely Interchangeable

- No Lubrication
- Easy Installation
- No Metal to Metal Contact
- Resistant to oil, dirt, sand, moisture, grease
- Easy inspection of load carrying Spider
- Flexibility of angular or parallel misalignment of shafts by Buna-N Spider member permits smooth "Power Transmission"

Jaw Coupling Selection Procedure

- A. Determine Service Factor by Matching Driven Unit with Prime Mover in Service Factor Guide.
- B. Multiply Service Factor by Driven Unit or Motor H.P. to Obtain Adjusted H.P.
- C. Select Flexible Coupling with Horsepower Capacity Equal to or Greater than Adjusted H.P.

Service Factor Guide	Prime Mover		
	Electric Motor or Steam Turbine	Gasoline or Diesel Engine, 6 or More Cyl.	Gasoline or Diesel Engine, Less Than 6 Cyl.
Driven Unit (Machinery)			
Light: Uniform or steady load never exceeding horsepower rating, infrequent starting. Agitators, Blowers, Conveyors, Evaporators, Fans, Generators, Centrifugal Pumps, Stokers	1.0	1.5	2.0
Moderate: Heavy inertia, moderate shock, frequent starting; peak loads do not exceed 125 per cent average horsepower. Uneven load. Beaters, Rotary Pumps and Compressors, Cranes, Elevators, Mine and Propeller Fans, Generators, Pulp Grinders, Hoists, Kilns, Machine Tools, Mixers, Gear Pumps, Woodworking Machines	1.5	2.0	2.5
Heavy: Heavy shock conditions or frequent reversing. Peak loads do not exceed 150 per cent average horsepower. Uneven load. Reciprocating Pumps and Compressors, Crushers, Freight and Passenger Elevators, Mills (Hammer, Ball, Rolling, Turf, Flour), Vibrating Screens, Winches, Wire Drawing Machines, Punches, Shears	2.0	2.5	3.0



Bore Tolerances:
 $\frac{1}{2} - 1 \frac{3}{4} + .001 - .000$
 $1 \frac{13}{16} - 2 \frac{5}{8} + .0015 - .0000$

Martin ML (Universal Series) — Torque and Horsepower Ratings

Catalog Number	Torque Rating Lb. — In.		Buna-N Horsepower Capacity at Various RPM					Max. Bore	(Each) Weight
	Buna-N	Hytrel®	100	300	1200	1800	3600		
ML035	3.5	—	.006	.02	.07	.10	.20	$\frac{3}{8}$.07
ML050	31.5	94.5	.05	.15	.60	.9	1.8	$\frac{5}{8}$.13
ML070	42	126	.07	.21	.84	1.2	2.5	$\frac{3}{4}$.25
ML075	81	242	.13	.39	1.56	2.3	4.7	$\frac{7}{8}$.44
ML090	140	420	.22	.66	2.64	4.0	7.9	1 $\frac{1}{8}$.69
ML095	189	567	.30	.90	3.6	5.4	10.8	1 $\frac{1}{4}$.84
ML099	290	870	.46	1.4	5.5	8.3	16.6	1 $\frac{3}{8}$	1.19
ML100	416	1248	.66	2.0	7.9	11.9	23.8	1 $\frac{5}{8}$	1.47
ML110	756	2268	1.2	3.6	14.4	21.6	43.2	1 $\frac{5}{8}$	3.20
ML150	1197	3591	1.9	5.7	22.8	34.2	68.4	1 $\frac{7}{8}$	4.50
ML190	1512	4536	2.4	7.2	28.8	43.2	86.4	2 $\frac{1}{8}$	8.25
ML225	2268	6804	3.6	10.8	43.2	64.8	129.6	2 $\frac{5}{8}$	12.00

NOTE: Above H.P. capacities are for Buna-N rubber spider and service factor of one. When Hytrel spider is used multiply capacities by three.

Martin MS (Super Series) — Torque and Horsepower Ratings

Catalog Number	Torque Rating Lb. — In.		Buna-N Horsepower Capacity at Various RPM					Max. Bore	(Each) Weight
	Buna-N	Hytrel®	100	300	1200	1800	3600		
MS050	37.3	112	.06	.18	.71	1.0	2.1	$\frac{5}{8}$.13
MS070	59.4	178	.09	.28	1.1	1.7	3.4	$\frac{3}{4}$.25
MS075	157	471	.25	.75	3.0	4.5	8.9	$\frac{7}{8}$.44
MS090	241	723	.38	1.1	4.6	6.9	13.7	1 $\frac{1}{8}$.69
MS095	241	723	.38	1.1	4.6	6.9	13.7	1 $\frac{1}{8}$.84
MS099	512	1536	.81	2.4	9.7	14.6	29.2	1 $\frac{1}{4}$	1.19
MS100	512	1536	.81	2.4	9.7	14.6	29.2	1 $\frac{1}{4}$	1.47
MS110	1014	3042	1.6	4.8	19.3	28.9	57.8	1 $\frac{3}{8}$	3.20
MS150	1630	4890	2.6	7.7	31.0	46.5	93.0	1 $\frac{7}{8}$	4.50
MS190	2450	7350	3.9	11.6	46.6	69.9	139.7	2 $\frac{1}{8}$	8.25
MS225	2920	8760	4.6	13.9	55.5	83.2	166.5	2 $\frac{5}{8}$	12.00

NOTE: Above H.P. capacities are for Buna-N rubber spider and service factor of one. When Hytrel spider is used multiply capacities by three.

Misalignment Capacities: Angular up to 1°, Parallel up to .015 inches.

Hytrel is a registered trademark of E.I. DuPont & Co.

Stock Jaw Couplings



COUPLINGS

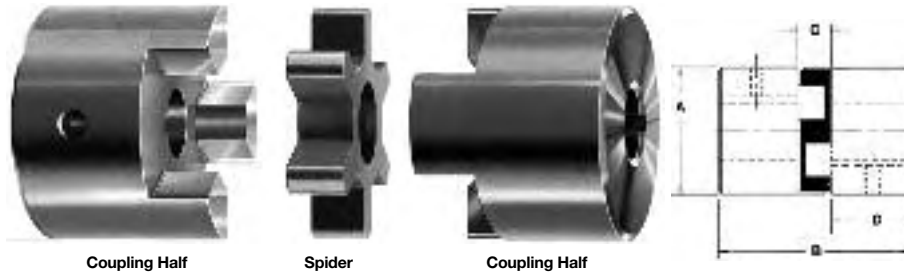

Coupling Half

Spider

Coupling Half

Dimensions

Catalog Number	Hub Dia. A	Overall Length B	Distance Betw. Flanges C	Length Thru Bore D	Bore		Weight Lbs.
					Min.	Max.	
ML035	3/8	1 1/16	3/32	1/64	1/8	3/8	.07
ML or MS050	1 1/16	1 29/32	15/32	3/8	1/4	3/4	.13
ML or MS070	1 1/8	2	1/2	3/4	1/4	3/4	.25
ML or MS075	1 3/8	2 1/8	1/2	13/16	1/4	3/4	.44
ML or MS090	2 1/8	2 1/2	1/2	13/16	1/4	1 1/8	.69
ML or MS095	2 1/8	2 1/2	1/2	1	3/16	1 1/8	.84
ML or MS099	2 1/32	2 1/8	3/4	1 1/16	1/2	1 3/8	1.19
ML or MS100	2 17/32	3 1/2	3/4	1 1/8	1/2	1 3/8	1.47
ML or MS110	3 1/8	4 1/4	7/8	1 13/16	1/2	1 3/8	3.20
ML or MS150	3 3/4	4 1/2	1	1 3/4	3/8	1 1/2	4.50
ML or MS190	4 1/2	4 3/4	1	1 15/16	3/4	2 1/8	8.25
ML or MS225	5	5 3/8	1	2 1/16	3/4	2 3/8	12.00

Bore sizes are standard in 1/16" increments from minimum to maximum bore range and have keyway and set screw except as shown below:

- 1/8 through 3/8 Bore — No KW — No SS
- #050 — 7/16 through 5/8 Bore — No KW — 1-SS
- #070, 075, 090, 095 — 7/16 and 1/2 Bore — No KW — 1-SS
- #099, 100, 110 — 1/2 Bore — No KW — No SS
- #150 — 3/8 Bore — No KW — No SS
- #190, 225 — 3/4 Bore — No KW — No SS

NOTE: In each coupling size a min. plain bore is available that can be used to make special bores such as spline, hex, metric, or other shapes or sizes.

For Standard Keyway sizes see *Martin* Catalog, page E-158 and E-159.

Coupling Selection Chart for 60 Hz Nema Motor Frames Based on Buna-N (Rubber) Spider ★†

Shaft Diameter	Nema Frame	Coupling Size	Max. Horsepower Rating @ RPM					
			1140		1725		3450	
			MS	ML	MS	ML	MS	ML
3/8	42	050	1/2	1/2	1	3/4	2	1 1/2
1/2	48	050	1/2	1/2	1	3/4	2	1 1/2
5/8	56, 56 H	050	1/2	1/2	1	3/4	2	1 1/2
3/4	66	070	1	3/4	1 1/2	1	3	2
7/8	56HZ, 143T, 145T 182, 184	075	2	1	3	2	7 1/2	3
		090	3	2	5	3	10	7 1/2
1 1/8	182T, 184T, 213 215	095	3	3	5	5	10	10
		099	7 1/2	5	10	7 1/2	25	15
1 1/4	213T, 215T, 245U, 256U	100	7 1/2	7 1/2	10	10	25	20
1 1/2	254T, 256T, 248U, 286U	110	15	10	25	20	50	40
1 3/4	284T, 286T, 324U, 326U, 326TS	150	30	20	40	30	75	60
2 1/8	324T, 326T, 364U, 365U	190	40	25	60	40	125	75
2 1/4	364T, 365T	225	50	40	75	60	150	100

NOTE: Coupling Sizes are based on the rated torque, max. bore and a have a service factor of 1.0.

* When Using Hytrel or Bronze spider multiply above horsepower ratings by 3.

† When using Urethane spider multiply above horsepower ratings by 1.5.

C-30

Spiders — Buna-N (Rubber) and Hytrel

Catalog Number		Accommodates Coupling	Net Weight Lbs.	
Buna-N	Hytrel		Buna-N	Hytrel
SRL035	SHL035	ML035	.009	.009
SRL050	SHL050	M 050 — MS 050	.013	.013
SRL070	SHL070	ML070 — MS 070	.017	.017
SRL075	SHL075	ML075 — MS 075	.03	.03
SRL090	SHL090	ML or MS090-095	.04	.04
SRL099	SHL099	ML or MS099-100	.07	.07
SRL110	SHL110	ML110 — MS110	.14	.14
SRL150	SHL150	M150 — MS150	.21	.21
SRL190	SHL190	ML190 — MS190	.27	.27
SRL225	SHL225	ML225 — MS225	.41	.41

Urethane spiders available. Please consult factory.

Spiders — Urethane† and Bronze★

Catalog Number		Accommodates Coupling	Net Weight Lbs.	
Urethane	Bronze★		Urethane	Bronze
SUL035		ML 035	.009	
SUL050		ML050 — MS050	.013	
SUL070		ML070 — MS070	.017	
SUL075		ML075 — MS075	.03	
SUL090		ML or MS 090-095	.04	
SUL099		ML or MS 099-100	.07	
SUL110		ML110 — MS110	.14	
SUL150		ML150 — MS150	.21	
SUL190		ML190 — MS190	.27	
SUL225		ML225 — MS225	.41	

★ Bronze spiders available as Made to Order.



Metric Bore Sizes Available
Consult Factory

Parts List and Engineering Data

Coupling Size	*QD Bushing (2 Required Per Coupling)	Steel Flange Assembly (2 Required Per Coupling)		Rubber Element (1 Required Per Coupling)		Max RPM	Horsepower @ 100 RPM (1.0 Factor)	Torque (1.0 Service Factor)		Average Static Torsional Stiffness Coefficient (K)		Approx. WR2** (LB - Ft ²)
		Flange No.	Weight Each	Element No.	Weight			LB - In	LB - Ft	LB - In/DEG	LB - In/RAD	
5	JA	F5JA	3.0	E5	.6	4500	1.03	649	54.1	244	12,850	.08
6	JA	F6JA	4.0	E6	.9	4000	1.80	1134	94.5	414	23,700	.22
7	SH	F7SH	7.0	E7	1.3	3600	3.12	1966	163.8	544	31,200	.40
8	SDS	F8SDS	8.0	E8	1.7	3100	4.68	2950	245.8	876	50,200	.70
9	SK	F9SK	13.0	E9	2.0	2800	6.90	4349	362.4	1088	62,400	1.33
10	SF	F10SF	17.0	E10	2.0	2600	8.33	5250	437.5	1530	87,700	2.10
11	SF	F11SF	18.0	E11	3.0	2300	9.92	6252	521.0	2420	138,700	2.90
12	E	F12E	31.0	E12	3.8	2100	14.40	9076	756.3	4014	217,000	5.80

* See page B5 for QD bushing bore sizes and dimensions.

** Coupling plus QD bushing.

★ Weight in pounds.

Rubber tire element also available in Neoprene.

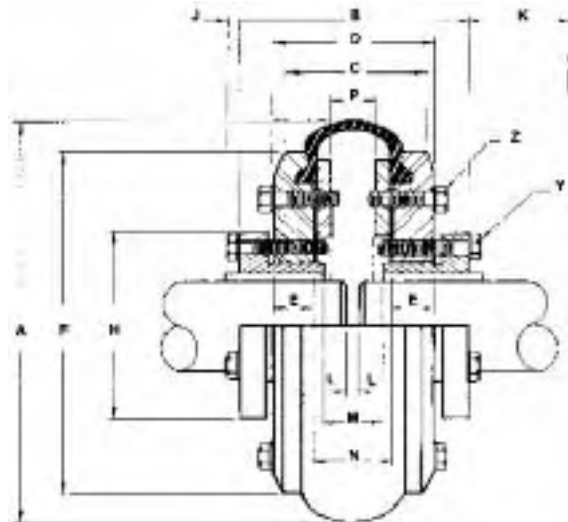

Dimensions

Coupling Size	A	B	C	D	E	F	H	J	K*	L	M	N	P	Z Clamp Ring Bolts			
														Y B.C. Dia.	B.C. Dia.	No. and Size*** Capscrews	Torque In Lbs.
5	5 1/4	3 3/8	2 1/8	2 3/8	5/8	4	2	3/2	1 1/4	..	1 1/8	1 1/8	3/8	1.66	2 3/8	(5) 1/4 - 20x1 1/8	125
6	6 1/2	3 3/8	2 3/8	2 11/8	5/8	4 1/8	2	3/2	1 1/4	..	1 1/8	1 1/8	1/2	1.66	3 3/8	(5) 3/8 - 18x1 1/8	200
7	7 3/4	4 3/8	2 11/8	3 3/8	13/8	5 1/8	2 1/8	7/2	1 1/8	..	1 1/8	1 1/8	3/4	2 1/4	3 3/8	(5) 3/8 - 18x1 1/4	300
8	8 3/4	4 3/8	2 11/8	3 3/8	13/8	6 1/2	3 3/8	7/2	1 1/8	..	1 1/8	1 11/8	7/8	2 11/8	4 3/8	(6) 3/8 - 18x1 1/2	300
9	9 3/4	5 3/8	3 3/8	3 13/8	1 1/8	7 3/8	3 3/8	7/2	2 1/4	..	1 1/8	1 13/8	7/8	3 3/8	5 1/4	(6) 3/8 - 16x1 3/8	400
10	10	5 3/8	3 3/8	4 1/8	1 1/8	8 3/8	4 3/8	3/2	2 3/4	..	1 1/8	1 1/8	1	3 3/8	6	(6) 3/8 - 16x1 3/8	400
11	11	5 3/8	3 3/8	4 1/8	1 1/8	9	4 3/8	3/2	2 3/4	..	1 1/8	1 1/8	1 1/8	3 3/8	6 1/2	(6) 3/8 - 16x1 3/8	400
12	12 3/4	7 3/8	4	4 3/4	1 3/8	10 1/8	6	7/2	3 3/4	..	1 1/4	1 1/4	3/4	5	7 1/4	(6) 1/2 - 13x2 1/4	900

* Clearance required to remove bushing using pull-up capscrews as jackscrews.

** Shaft ends are normally M or N apart; they may project beyond the bushings. In this case allow space for end float and misalignment.

*** Grade 8.

Dimensions in inches.

Other Sizes Available as Made-to-Order

Martin Flex® flexible couplings smoothly transmit power while compensating for shaft misalignment to 4°, parallel misalignment to 1/8" and end float to 5/16". The two piece flange design provides quick and easy installation and the elastomeric element absorbs shock and torsional vibration through a wide temperature range.

Selection Procedure

1. Select the proper service factor from Chart 1.
2. Determine **Design Horsepower** by multiplying the **Service Factor** and the **Drive Horsepower**.
3. Locate the intercept of **Shaft Speed** and **Design Horsepower** from Chart 2.
4. Order per coupling: (2) bushings, (2) flange assemblies, (1) flexible tire element.

Chart 1 Service Factors

Application	Factor	Application	Factor	Application	Factor	Application	Factor
AGITATORS		Pump, Screen Drive, Stackers, Utility Winch	1.5	METAL FORMING MACHINES		Hog	2.0
Paddle or Propeller (Vert. or Horiz.), Screw	1.0	DYNAMOMETER	1.0	Draw Bench Carriage, Main Drive, Extruder, Wire Drawing, Flattening Machine	2.0	Roller	1.5
BREWING AND DISTILLING		ELEVATORS		PUMPS		Water	1.0
Bottling Machinery, Brew Kettle, Cooker (Cont. Duty), Mash Tub	1.0	Bucket, Freight	2.0	Centrifugal	1.0	SEWAGE DISPOSAL	
Scale Hopper —		EXCITER	1.0	Descaling, Gear Type	1.5	EQUIPMENT	1.0
Frequent Starting Peaks	1.5	FANS		Oil Well Pumping (not over 150% peak torque)	2.0	SHOVEL	2.0
CAN FILLING MACHINE	1.0	Centrifugal	1.0	Rotary — other than gear ..	1.5	SHREDDER	1.5
CAR DUMPER	1.5	Cooling Tower	2.0	Reciprocating —		STEEL INDUSTRY	
CAR PULLER	1.5	Large (Mine, etc.)	1.5	1 cyl. — single acting	2.5	Cold Mills	
CLARIFIER	1.0	Light	1.0	1 cyl. — double acting	2.0	Coiler (up or down)	1.5
CLASSIFIER	1.0	Propeller (indoor)	1.5	2 cyl. — single acting	2.0	Strip, Temper	2.0
CLAY-WORKING MACHINES		FOOD INDUSTRY		2 cyl. — double acting	1.5	Hot Mills	
Brick Press, Briquette Machine, Clay Working Machine, Pug Mill	1.5	Beet Slicer	1.5	3 cyl. — or more	1.5	Coiler (up or down), Edger Drive	1.5
COMPRESSORS		Cereal Cooker	1.0	RUBBER INDUSTRY		Feed Roll (Bloom), Roughing Mill Delivery (non-reversing), Sheet, Strip	3.0
Lobe, Rotary	2.0	Dough Mixer, Meat Grinder	1.5	Banbury Mixer	2.5	Rod Mill	2.5
Reciprocating* —		GENERATORS		Calender	2.0	Cracker, Mixing Mill, Plasticator	2.5
1 cyl. — single acting	3.5	Even Load	1.0	Refiner, Sheeter, Tire Building Machine	2.0	Cracker, Mixing Mill, Plasticator	2.5
1 cyl. — double acting	3.0	Hoist or Railway Service ..	1.5	Tire and Tube Press Opener (Based on Peak Torque) ..	1.0	Refiner, Sheeter, Tire Building Machine	2.0
2 cyl. — single acting	3.0	Welder Load	2.0	Paraffin Filter Press	1.5	Tire and Tube Press Opener (Based on Peak Torque) ..	1.0
2 cyl. — double acting	2.5	GRIZZLY	2.0	OIL INDUSTRY		Tuber and Strainer	1.5
3 cyl. or more — single acting	2.5	KILN	2.0	Chiller	1.0	Warming Mill	2.0
3 cyl. or more — double acting	2.0	LAUNDRY MACHINES		Oil Well Pumping (not over 150% peak torque) ..	2.0	Washer	2.5
CONVEYORS		Tumbler, Washer	2.0	Paraffin Filter Press	1.5	SCREENS	
Apron, Assembly, Belt, Chain, Flight, Oven	1.0	LINE SHAFTS		PAPER MILLS		Air Washing	1.0
Reciprocating	2.5	Driving Processing Machinery	1.0	Agitator	1.0	Coal and Sand (Rotary) ..	1.5
Screw	1.0	Light	1.0	Barking Drum	2.5	Vibrating	2.5
CRANES AND HOISTS		LUMBER INDUSTRY		Beater and Pulper	1.5	SCREENS	
Main Hoist —		Band Resaw, Circular Resaw	1.5	Bleacher	1.0	Air Washing	1.0
Medium Duty	1.5	Edger, Head Rig, Planer	2.0	Calender	2.0	Coal and Sand (Rotary) ..	1.5
Main Hoist — Heavy Duty	2.0	Hog, Log Haul	2.0	Chipper	3.0	Vibrating	2.5
Skip Hoist, Travel Motion, Trolley Motion, Slope	1.5	Rolls Non-Reversing	1.5	Couch, Cylinder, Dryer ..	1.5	SCREENS	
CRUSHERS		Rolls Reversing	2.0	Felt Stretcher	1.0	Air Washing	1.0
Cane	2.0	Sawdust Conveyor	1.0	Fourdriner	1.5	Spinner, Tenter Frame ..	1.5
Gyratory	2.5	Slab Conveyor, Sorting Table	1.5	Jordan	2.0	WINDLASS	1.5
DREDGES		MACHINE TOOLS		Press	2.0	WOODWORKING MACHINES ..	1.0
Cable Reel, Conveyor	1.5	Auxiliary	1.0	Pulp Grinder	2.0		
Cutter Head Drive, Jog Drive	2.5	Main Drive, Notching (Reversing), Plate Planer, Punch Press	1.5	Stock Chest	1.5		
		Traverse	1.0	Stock Pump			
				Reciprocating	2.0		
				Rotary	1.5		
				Suction Roll	2.0		
				Winder	1.5		
				PARAFFIN FILTER PRESS ..	1.5		
				PRINTING PRESS	1.5		
				PROPELLER (Marine)	1.5		
				PULVERIZERS			
				Hammermill — Light Duty ..	1.5		
				Hammermill — Heavy Duty ..	2.0		

The service factors listed are intended only as a general guide for smooth power sources such as electric motors and steam turbines. Add 0.5 to factor for somewhat rougher power sources such as internal combustion engines of four or more cylinders, steam engines and water turbines. Where substantial shock occurs or starting or stopping is frequent as on some "inching" drives and on some reversing drives or where the power source is an internal combustion engine with less than four cylinders — consult factory. Where torsional vibrations occur as in, for example, internal combustion engines or reciprocating compressors or pump applications, check the coupling for possible development of damaging large amplitude vibrations.

** Add 0.5 to factor if without flywheel.

Chart 2 Size Selection

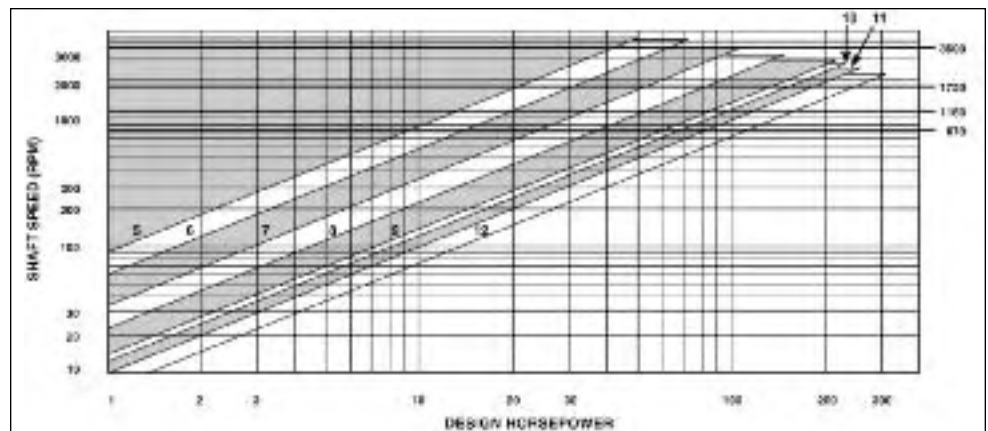

BELT DRIVES

Product	PAGE
INDEX	D-1 – D-2
Made-to-Order Capabilities	D-4
 SECTION I – SHEAVES	
SHEAVE NOMENCLATURE	D-5
STOCK QD HI-CAP® WEDGE	D-6 - D-14
3V Section	D-6 - D-8
5V Section	D-9 - D-12
8V Section	D-13 - D-14
STOCK QD CONVENTIONAL	D-15 - D-23
A-B Combination Groove	D-15 - D-18
C Section	D-19 - D-21
D Section	D-22 - D-23
STOCK TAPER BUSHED HI-CAP® WEDGE	D-24 - D-31
3V Section	D-24 - D-26
5V Section	D-27 - D-29
8V Section	D-30 - D-31
STOCK TAPER BUSHED CONVENTIONAL	D-32 - D-39
A-B Combination Groove	D-32 - D-34
C Section	D-35 - D-37
D Section	D-38 - D-39
GROOVE DIMENSIONS/TOLERANCES	D-40 - D-41
STOCK V-BELT DRIVE SELECTION	D-42 - D-147
STOCK SELECTION PROCEDURE	D-43 - D-47
STOCK DRIVE SELECTION CHARTS	D-48 - D-147
3V Section Selection	D-48 - D-59
5V Section Selection	D-60 - D-79
8V Section Selection	D-80 - D-87
A Section Selection	D-88 - D-107
B Section Selection	D-108 - D-129
C Section Selection	D-130 - D-141
D Section Selection	D-142 - D-147
NON-STOCK V-BELT DRIVE SELECTION	D-148 - D-163
NON-STOCK SELECTION PROCEDURE	D-149 - D-151
BASIC V-BELT HORSEPOWER RATINGS	D-152 - D-175
3V Section HP Ratings	D-152 - D-153
3VX (Cogged) Section HP Ratings	D-154 - D-155
5V Section HP Ratings	D-156 - D-157
5VX (Cogged) Section HP Ratings	D-158 - D-159

BELT DRIVES

PRODUCT	PAGE
SECTION I – SHEAVES (Continued)	
8V Section HP Ratings	D-160 – D-161
A Section HP Ratings	D-162 – D-163
AX (Cogged) Section HP Ratings	D-164 – D-165
B Section HP Ratings	D-166 – D-167
BX (Cogged) Section HP Ratings	D-168 – D-169
C Section HP Ratings	D-170 – D-171
CX (Cogged) Section HP Ratings	D-172 – D-173
D Section HP Ratings	D-174 – D-175
OTHER SPEEDS/SPEED-UP DRIVES	D-176
QUARTER TURN DRIVES	D-177
INSTALLATION/TENSIONING	D-178 – D-179
DYNAMIC BALANCE	D-180
MADE-TO-ORDER SHEAVES	D-181 – D-189
DRIVE SELECTION WORKSHEET	D-190 – D-192
FHP (Fractional Horsepower) SHEAVES	D-193 – D-203
AK / 2AK BORED-TO-SIZE	D-194 – D-195
AK-H / 2AK-H MST® BUSHED	D-196 – D-197
BK / 2BK BORED-TO-SIZE	D-198 – D-199
BK-H / 2BK-H MST® BUSHED	D-200 – D-201
MST® BUSHING SPECIFICATIONS	D-202
MST® BUSHING INSTALLATION INSTRUCTIONS	D-203
VARIABLE PITCH SHEAVES	D-204 – D-208
1VP / 2 VP BORED-TO-SIZE	D-205 – D-206
VARIABLE PITCH SHEAVES INSTALLATION INSTRUCTIONS	D-207 – D-208

Martin V-belt sheaves meet the toughest demands of industry, while continuing the *Martin* tradition of providing the utmost in service and maintaining unsurpassed manufacturing standards.

Totally committed to meeting the individual needs of customers, *Martin* Sprocket & Gear now serves the V-belt industry with extensive stock inventories, the capacity to meet large quantity requirements and the versatility to respond quickly to made-to-order applications.

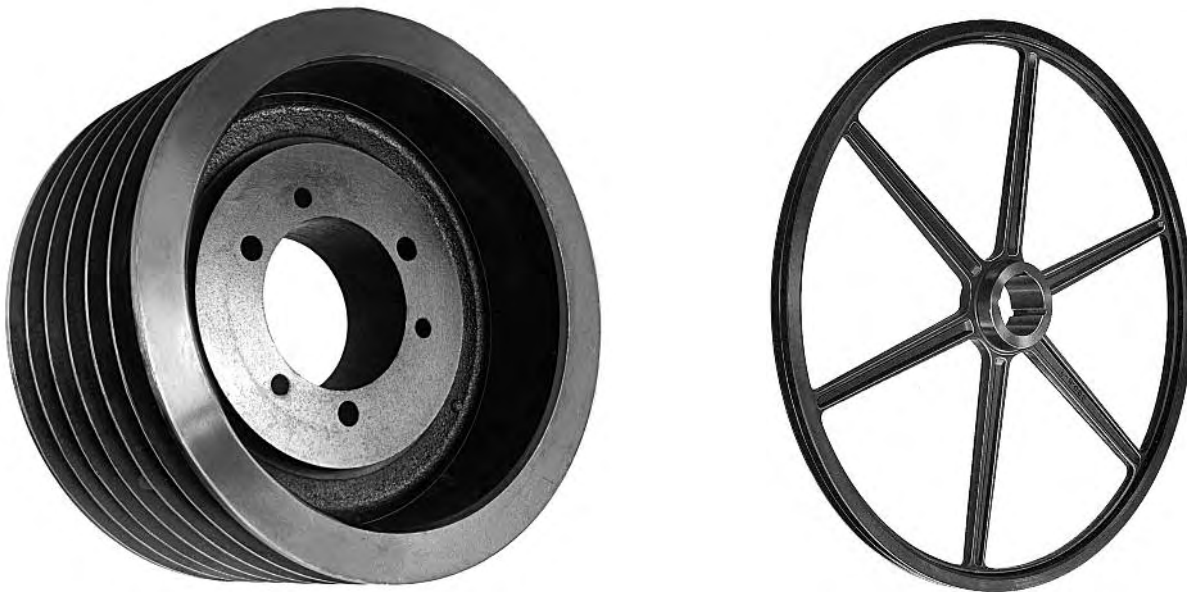

Martin— where dependability is a tradition.

MADE-TO-ORDER CAPABILITIES



WIRE ROPE IDLER



FLAT BELT PULLEY



DUPLEX — SHEAVE AND
FLAT BELT



POLY-V SHEAVE



CROWN FACE PULLEY



IDLER SHEAVE

All *Martin* sheaves and timing pulleys can be manufactured to meet your special requirements: Aluminum, Brass, Ductile, Steel, Stainless Steel. *Martin*, service and quality drive components you can depend on to get the job done.

QD

HI-CAP® WEDGE (Also Referred To As "Narrow")	CONVENTIONAL (Also Referred To As "Classical")
2 3V 220 JA	12 D 580 P
2 — Number of Grooves 3V — Belt Cross Section 220 — 2.2" <i>Outside Diameter</i> JA — Bushing Required	12 — Number of Grooves D — Belt Cross Section 580 — 58.0" <i>Pitch Diameter</i> P — Bushing Required

TAPER BUSHED

HI-CAP® WEDGE (Also Referred To As "Narrow")	CONVENTIONAL (Also Referred To As "Classical")
10 8V 5300 TB	1 B 34 TB
10 — Number of Grooves 8V — Belt Cross Section 5300 — 53.00" <i>Outside Diameter</i> TB — Taper Bushing Required	1 — Number of Grooves B — Belt Cross Section 34 — 3.4" <i>Pitch Diameter</i> (B-Belt) TB — Taper Bushing Required

Call *Martin* for your made-to-order and large quantity requirements.

3V Hi-Cap Wedge Stock QD Sheaves

Martin

V-BELT DRIVES

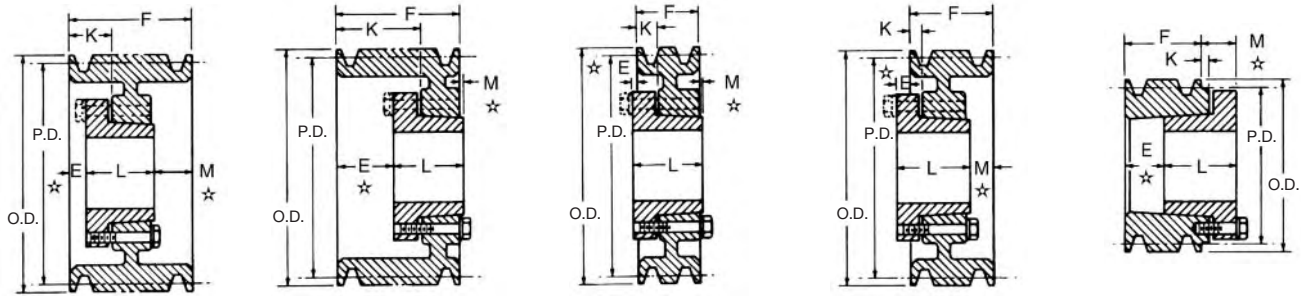

TYPE A

TYPE B

TYPE C

TYPE D

TYPE E

Dimensions for *Martin* sheaves are listed in the following tables with QD bushings in place. The type of sheave shown below is indicated by a letter, and the construction is indicated by a number, as shown on facing page.

Dimensions in inches, weight in pounds

1 Groove*											2 Groove								
F = 1/16											F = 1/32								
Part Number	OD	PD 3V Belt	Type	Bush	Bush Max. Bore	E	K	L Thru Bore	M	Wt. Less Bush	Part Number	Type	Bush	Bush Max. Bore	E	K	L Thru Bore	M	Wt. Less Bush
1 3V 220 JA	2.20	2.15	E-1	JA	1/4	3/16	7/16	1 1/16	15/16	.7	2 3V 220 JA	E-1	JA	1/4	31/32	7/16	1 1/16	15/16	.9
1 3V 235 JA	2.35	2.30	E-1	JA	1/4	3/16	7/16	1 1/16	15/16	.8	2 3V 235 JA	E-1	JA	1/4	31/32	7/16	1 1/16	15/16	1.0
1 3V 250 JA	2.50	2.45	E-1	JA	1/4	3/16	7/16	1 1/16	15/16	.8	2 3V 250 JA	E-1	JA	1/4	31/32	7/16	1 1/16	15/16	1.2
1 3V 265 JA	2.65	2.60	C-1	JA	1/4	3/8	1/2	1 1/16	0	.9	2 3V 265 JA	D-1	JA	1/4	3/8	1/2	1 1/16	13/32	1.3
1 3V 280 JA	2.80	2.75	C-1	JA	1/4	3/8	1/2	1 1/16	0	.9	2 3V 280 JA	D-1	JA	1/4	3/8	1/2	1 1/16	13/32	1.4
1 3V 300 JA	3.00	2.95	C-1	JA	1/4	3/8	1/2	1 1/16	0	1.0	2 3V 300 JA	D-1	JA	1/4	3/8	1/2	1 1/16	13/32	1.6
1 3V 315 JA	3.15	3.10	C-1	JA	1/4	3/8	1/2	1 1/16	0	1.0	2 3V 315 JA	D-1	JA	1/4	3/8	1/2	1 1/16	13/32	1.8
1 3V 335 JA	3.35	3.30	C-1	JA	1/4	3/8	1/2	1 1/16	0	1.1	2 3V 335 SH	D-1	SH	1 1/16	27/64	3/4	1 1/16	13/64	2.0
1 3V 365 SH	3.65	3.60	D-1	SH	1 1/16	3/8	0	1 1/16	1/8	1.3	2 3V 365 SH	D-1	SH	1 1/16	27/64	3/4	1 1/16	13/64	2.4
1 3V 412 SH	4.12	4.07	D-1	SH	1 1/16	3/8	0	1 1/16	1/8	1.7	2 3V 412 SH	D-1	SH	1 1/16	3/32	3/4	1 1/16	1/16	2.7
1 3V 450 SH	4.50	4.45	D-2	SH	1 1/16	3/8	0	1 1/16	1/8	2.1	2 3V 450 SH	D-1	SH	1 1/16	1/4	5/16	1 1/16	1/32	2.9
1 3V 475 SH	4.75	4.70	D-2	SH	1 1/16	3/8	0	1 1/16	1/8	2.5	2 3V 475 SH	D-1	SH	1 1/16	1/4	5/16	1 1/16	1/32	3.1
1 3V 500 SH	5.00	4.95	D-2	SH	1 1/16	3/8	0	1 1/16	1/8	2.8	2 3V 500 SH	D-1	SH	1 1/16	1/4	5/16	1 1/16	1/32	3.6
1 3V 530 SH	5.30	5.25	D-2	SH	1 1/16	3/8	0	1 1/16	1/8	3.2	2 3V 530 SH	D-1	SH	1 1/16	1/4	5/16	1 1/16	1/32	4.5
1 3V 560 SH	5.60	5.55	D-2	SH	1 1/16	3/8	0	1 1/16	1/8	3.2	2 3V 560 SH	D-1	SH	1 1/16	1/4	5/16	1 1/16	1/32	5.0
1 3V 600 SH	6.00	5.95	D-2	SH	1 1/16	3/8	0	1 1/16	1/8	3.5	2 3V 600 SH	D-1	SH	1 1/16	1/4	5/16	1 1/16	1/32	5.5
1 3V 650 SH	6.50	6.45	D-3	SH	1 1/16	3/8	0	1 1/16	1/8	3.9	2 3V 650 SDS	D-3	SDS	2	3/16	5/16	1 1/16	1/32	5.8
1 3V 690 SH	6.90	6.85	D-3	SH	1 1/16	3/8	0	1 1/16	1/8	4.5	2 3V 690 SDS	D-3	SDS	2	3/16	5/16	1 1/16	1/32	6.6
1 3V 800 SDS	8.00	7.95	C-3	SDS	2	5/8	0	1 1/2	0	5.5	2 3V 800 SDS	D-3	SDS	2	5/16	5/16	1 1/16	1/32	7.0
1 3V 1060 SDS	10.60	10.55	C-3	SDS	2	5/8	0	1 1/2	0	8.0	2 3V 1060 SK	C-3	SK	2 3/4	7/16	5/16	1 1/16	13/32	10.0
1 3V 1400 SK	14.00	13.95	C-3	SK	2 3/4	1 1/16	0	1 1/16	0	13.5	2 3V 1400 SK	C-3	SK	2 3/4	7/16	1/4	1 1/16	13/32	16.0
1 3V 1900 SK	19.00	18.95	C-3	SK	2 3/4	1 1/16	0	1 1/16	0	17.0	2 3V 1900 SK	C-3	SK	2 3/4	7/16	1/4	1 1/16	13/32	25.0
	25.00	24.95									2 3V 2500 SF	C-3	SF	2 1/2	7/16	1/4	2 1/16	13/32	28.0

* F = 3/8" for 1 3V 800 SDS and 1 3V 1060 SDS, F = 1/16" for 1 3V 1400 Sk and 1 3V 1900 SK

★ E and M dimensions are nominal and will vary depending on shaft tolerances. Type E sheaves are drilled for reverse mounting only.

Martin

Hi-Cap Wedge Stock 3V QD Sheaves 3V

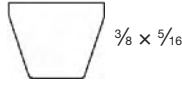

3V

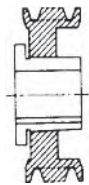

1 = SOLID

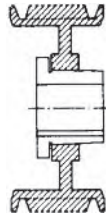

2 = WEB

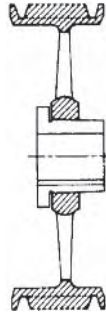

3 = ARM/SPOKE

Let *Martin* quote your made to order and large quantity requirements.

V-BELT DRIVES

Dimensions in inches, weight in pounds

3 Groove F = 1 1/2											4 Groove F = 1 29/32									
Part Number	OD	PD 3V Belt	Type	Bush	Bush Max. Bore	E	K	L Thru Bore	M	Wt. Less Bush	Part Number	Type	Bush	Bush Max. Bore	E	K	L Thru Bore	M	Wt. Less Bush	
3 3V 250 JA	2.50	2.45	E-1	JA	1 1/4	1 3/8	7/16	1 1/16	1 5/16	1.6	4 3V 265 JA	D-1	JA	1 1/4	3/8	1/8	1 1/16	1 1/2	1.3	
3 3V 265 JA	2.65	2.60	D-1	JA	1 1/4	3/8	1/8	1 1/16	1 3/16	1.8	4 3V 280 JA	D-1	JA	1 1/4	3/8	1/8	1 1/16	1 1/2	1.6	
3 3V 280 JA	2.80	2.75	D-1	JA	1 1/4	3/8	1/8	1 1/16	1 3/16	2.0	4 3V 300 SH	E-1	SH	1 1/16	1 1/2	5/16	1 1/16	7/8	1.9	
3 3V 300 SH	3.00	2.95	E-1	SH	1 1/16	1 1/16	0	1 1/16	1 1/16	2.2	4 3V 315 SH	E-1	SH	1 1/16	1 1/2	5/16	1 1/16	7/8	2.2	
3 3V 315 SH	3.15	3.10	E-1	SH	1 1/16	1 1/16	3/16	1 1/16	1 1/16	2.5	4 3V 335 SH	D-1	SH	1 1/16	7/16	1/8	1 1/16	1 1/2	2.5	
3 3V 335 SH	3.35	3.30	D-1	SH	1 1/16	7/16	1/8	1 1/16	1 1/16	2.8	4 3V 365 SH	D-1	SH	1 1/16	7/16	1/8	1 1/16	1 1/2	2.8	
3 3V 365 SH	3.65	3.60	D-1	SH	1 1/16	7/16	1/8	1 1/16	1 1/16	3.0	4 3V 412 SH	A-1	SH	1 1/16	1/4	1 3/16	1 1/16	1 1/2	3.2	
3 3V 412 SH	4.12	4.07	A-1	SH	1 1/16	1/8	1 1/16	1 1/16	1 1/16	3.3	4 3V 450 SDS	A-1	SDS	2	3/16	1 3/16	1 1/16	1 1/2	3.5	
3 3V 450 SDS	4.50	4.45	A-1	SDS	2	1/16	1 1/16	1 1/16	1 1/16	3.5	4 3V 475 SDS	A-1	SDS	2	3/16	1 3/16	1 1/16	1 1/2	4.0	
3 3V 475 SDS	4.75	4.70	A-1	SDS	2	1/16	1 1/16	1 1/16	1 1/16	3.7	4 3V 500 SDS	A-1	SDS	2	3/16	1 3/16	1 1/16	1 1/2	4.5	
3 3V 500 SDS	5.00	4.95	A-1	SDS	2	1/16	1 1/16	1 1/16	1 1/16	4.0	4 3V 530 SDS	A-1	SDS	2	3/16	1 3/16	1 1/16	1 1/2	5.0	
3 3V 530 SDS	5.30	5.25	A-1	SDS	2	1/16	1 1/16	1 1/16	1 1/16	4.3	4 3V 560 SDS	A-1	SDS	2	3/16	1 3/16	1 1/16	1 1/2	5.7	
3 3V 560 SDS	5.60	5.55	A-1	SDS	2	1/16	1 1/16	1 1/16	1 1/16	4.9	4 3V 600 SK	D-1	SK	2 1/2	1/16	5/8	1 1/16	1 1/2	7.5	
3 3V 600 SDS	6.00	5.95	A-1	SDS	2	1/16	1 1/16	1 1/16	1 1/16	5.9	4 3V 650 SK	A-1	SK	2 1/2	1/16	5/8	1 1/16	1 1/2	8.0	
3 3V 650 SDS	6.50	6.45	A-3	SDS	2	1/16	1 1/16	1 1/16	1 1/16	6.3	4 3V 690 SK	A-1	SK	2 1/2	1/16	5/8	1 1/16	1 1/2	10.0	
3 3V 690 SDS	6.90	6.85	A-3	SDS	2	1/16	1 1/16	1 1/16	1 1/16	6.8	4 3V 800 SK	D-2	SK	2 1/2	1/16	5/8	1 1/16	1 1/2	12.0	
3 3V 800 SK	8.00	7.95	C-2	SK	2 1/2	7/16	1/4	1 1/16	0	10.6	4 3V 1060 SK	D-3	SK	2 1/2	1/16	5/8	1 1/16	1 1/2	16.0	
3 3V 1060 SK	10.60	10.55	C-3	SK	2 1/2	7/16	1/4	1 1/16	0	12.0	4 3V 1400 SK	D-3	SK	2 1/2	1/16	5/8	1 1/16	1 1/2	22.0	
3 3V 1400 SK	14.00	13.95	C-3	SK	2 1/2	7/16	1/4	1 1/16	0	20.0	4 3V 1900 SF	C-3	SF	2 1/2	1/16	5/8	2 1/16	3/2	37.0	
3 3V 1900 SF	19.00	18.95	C-3	SF	2 1/2	7/16	1/4	2 1/16	1/8	33.0	4 3V 2500 SF	C-3	SF	2 1/2	1/16	5/8	2 1/16	3/2	53.0	
3 3V 2500 SF	25.00	24.95	C-3	SF	2 1/2	7/16	1/4	2 1/16	1/8	45.0	4 3V 3350 E	C-3	E	3 1/2	3/8	1/2	2 1/2	1 1/2	80.0	
3 3V 3350 SF	33.50	33.45	C-3	SF	2 1/2	7/16	1/4	2 1/16	1/8	75.0										

Weights do not include bushings. See page B-7 for additional bushing dimensions.

3V Hi-Cap Wedge Stock QD Sheaves

V-BELT DRIVES

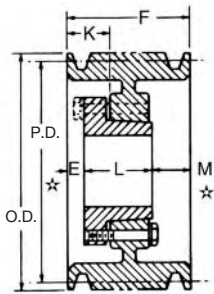

TYPE A

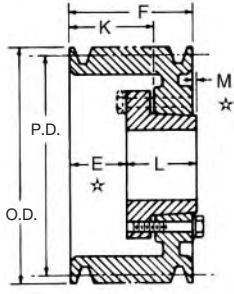

TYPE B

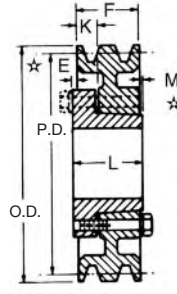

TYPE C

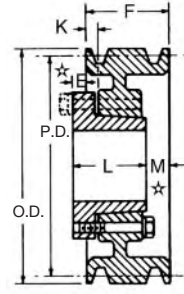

TYPE D

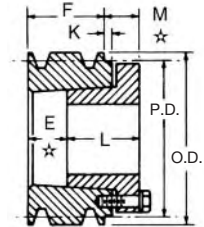

TYPE E

Dimensions in inches, weight in pounds

5 Groove F = 2 ⁵ / ₁₆											6 Groove F = 2 ²³ / ₃₂								
Part Number	OD	PD 3V Belt	Type	Bush	Bush Max. Bore	E	K	L Thru Bore	M	Wt. Less Bush	Part Number	Type	Bush	Bush Max. Bore	E	K	L Thru Bore	M	Wt. Less Bush
5 3V 475 SDS	4.75	4.70	A-2	SDS	2	3/16	1/16	1 1/8	3/4	4.5	6 3V 475 SK	D-1	SK	2 5/8	9/16	1/8	1 15/16	1 11/32	6.0
5 3V 500 SDS	5.00	4.95	A-2	SDS	2	3/16	1/16	1 1/8	3/4	5.3	6 3V 500 SK	D-1	SK	2 5/8	9/16	1/8	1 15/16	1 11/32	6.5
5 3V 530 SK	5.30	5.25	A-1	SK	2 1/2	1/4	1 1/16	1 1/16	1/2	5.8	6 3V 530 SK	A-1	SK	2 1/2	5/8	1 1/16	1 1/16	5/32	6.8
5 3V 560 SK	5.60	5.55	A-1	SK	2 1/2	1/4	1 1/16	1 1/16	1/2	7.0	6 3V 560 SK	A-1	SK	2 1/2	5/8	1 1/16	1 1/16	5/32	8.0
5 3V 600 SK	6.00	5.95	A-1	SK	2 1/2	1/4	1 1/16	1 1/16	1/2	8.3	6 3V 600 SK	A-1	SK	2 1/2	5/8	1 1/16	1 1/16	5/32	9.0
5 3V 650 SK	6.50	6.45	A-1	SK	2 1/2	1/4	1 1/16	1 1/16	1/2	9.0	6 3V 650 SK	A-2	SK	2 1/2	5/8	1 1/16	1 1/16	5/32	10.0
5 3V 690 SK	6.90	6.85	A-1	SK	2 1/2	1/4	1 1/16	1 1/16	1/2	12.0	6 3V 690 SK	A-2	SK	2 1/2	5/8	1 1/16	1 1/16	5/32	11.5
5 3V 800 SK	8.00	7.95	A-2	SK	2 1/2	1/4	1 1/16	1 1/16	1/2	13.0	6 3V 800 SK	A-2	SK	2 1/2	3/4	7/8	1 1/16	1 19/32	17.0
5 3V 1060 SK	10.60	10.55	A-3	SK	2 1/2	1/4	1 1/16	1 1/16	1/2	17.0	6 3V 1060 SF	A-2	SF	2 15/16	3/4	7/8	2 1/16	1 15/32	25.0
5 3V 1400 SF	14.00	13.95	A-3	SK	2 15/16	3/8	7/8	2 1/16	1/2	27.0	6 3V 1400 SF	A-3	SF	2 15/16	3/4	7/8	2 1/16	1 15/32	34.0
5 3V 1900 SF	19.00	18.95	A-3	SK	2 15/16	3/8	7/8	2 1/16	1/2	40.0	6 3V 1900 E	B-3	E	3 1/2	1/2	1	2 1/2	1 1/32	45.0
5 3V 2500 E	25.00	24.95	C-3	E	3 1/2	1/2	1	2 1/2	1/2	69.0	6 3V 2500 E	B-3	E	3 1/2	1/2	1	2 1/2	1 1/32	75.0
5 3V 3350 E	33.50	33.45	C-3	E	3 1/2	1/2	1	2 1/2	1/2	97.0	6 3V 3350 E	B-3	E	3 1/2	1/2	1	2 1/2	1 1/32	98.0

Dimensions in inches, weight in pounds

8 Groove F = 3 ¹⁷ / ₃₂											10 Groove F = 4 ¹¹ / ₃₂								
Part Number	OD	PD 3V Belt	Type	Bush	Bush Max. Bore	E	K	L Thru Bore	M	Wt. Less Bush	Part Number	Type	Bush	Bush Max. Bore	E	K	L Thru Bore	M	Wt. Less Bush
8 3V 475 SK	4.75	4.70	D-1	SK	2 1/2	1/4	1 1/16	2 3/32	6.0	10 3V 475 SK	D-1	SK	2 1/2	3/4	1 1/8	1 15/16	2 31/32	7.0	
8 3V 500 SK	5.00	4.95	D-1	SK	2 1/2	1/4	1 1/16	2 3/32	6.9	10 3V 500 SK	D-1	SK	2 1/2	3/4	1 1/8	1 15/16	2 31/32	8.6	
8 3V 530 SK	5.30	5.25	A-1	SK	2 1/2	1/4	1 1/16	1 1/16	3 1/32	7.8	10 3V 530 SK	A-1	SK	2 1/2	3/4	1 1/8	1 15/16	1 21/32	9.0
8 3V 560 SK	5.60	5.55	A-1	SK	2 1/2	1/4	1 1/16	1 1/16	3 1/32	9.0	10 3V 560 SK	A-1	SK	2 1/2	3/4	1 1/8	1 15/16	1 21/32	10.0
8 3V 600 SK	6.00	5.95	A-1	SK	2 1/2	1/4	1 1/16	1 1/16	3 1/32	10.0	10 3V 600 SK	A-1	SK	2 1/2	3/4	1 1/8	1 15/16	1 21/32	11.0
8 3V 650 SK	6.50	6.45	A-2	SK	2 1/2	1/4	1 1/16	1 1/16	3 1/32	12.9	10 3V 650 SK	A-2	SK	2 1/2	3/4	1 1/8	1 15/16	1 21/32	14.0
8 3V 690 SK	6.90	6.85	A-2	SK	2 1/2	1/4	1 1/16	1 1/16	3 1/32	14.0	10 3V 690 SK	A-2	SK	2 1/2	3/4	1 1/8	1 15/16	1 21/32	16.0
8 3V 800 SF	8.00	7.95	A-1	SF	2 15/16	3/8	1 1/2	2 1/16	1 1/32	20.0	10 3V 800 SF	A-1	SF	2 15/16	3/8	1 1/2	2 1/16	1 15/32	22.0
8 3V 1060 SF	10.60	10.55	A-2	SF	2 15/16	3/8	1 1/2	2 1/16	1 1/32	28.0	10 3V 1060 E	A-2	E	3 1/2	1/2	1 1/4	2 1/2	1 11/32	33.0
8 3V 1400 E	14.00	13.95	A-3	E	3 1/2	1/2	1 1/4	2 1/2	1 1/32	40.0	10 3V 1400 E	A-3	E	3 1/2	1/2	1 1/4	2 1/2	1 11/32	43.0
8 3V 1900 E	19.00	18.95	A-3	E	3 1/2	1/2	1 1/4	2 1/2	1 17/32	62.0	10 3V 1900 E	A-3	E	3 1/2	1/2	1 1/4	2 1/2	1 11/32	66.0
8 3V 2500 E	25.00	24.95	A-3	E	3 1/2	1/2	1 1/4	2 1/2	1 17/32	87.0	10 3V 2500 F	A-3	F	3 15/16	3/8	1 1/4	3 1/2	1 15/32	98.0
8 3V 3350 F	33.50	33.45	B-3	F	3 15/16	3/8	1 1/4	3 1/2	1 15/32	152.0	10 3V 3350 F	A-3	F	3 15/16	3/8	1 1/4	3 1/2	1 15/32	178.0

* E and M dimensions are nominal and will vary depending on shaft tolerances. Type E sheaves are drilled for reverse mounting only.

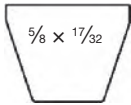

5V

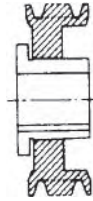

1 = SOLID

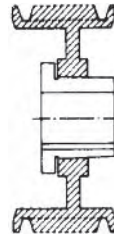

2 = WEB

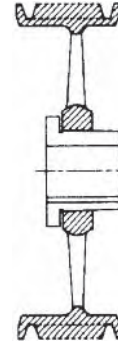

3 = ARM/SPOKE

Dimensions in inches, weight in pounds

2 Groove F = 1 ¹¹ / ₁₆											3 Groove F = 2 ³ / ₈								
Part Number	OD	PD 5V Belt	Type	Bush	Bush Max. Bore	E	K	L Thru Bore	M	Wt. Less Bush	Part Number	Type	Bush	Bush Max. Bore	E	K	L Thru Bore	M	Wt. Less Bush
2 5V 440 SH	4.40	4.30	A-1	SH	1 ¹¹ / ₁₆	⁵ / ₁₆	⁷ / ₁₆	1 ¹ / ₁₆	¹ / ₁₆	4.0	3 5V 440 SDS	E-1	SDS	2	1 ¹ / ₁₆	0	1 ¹ / ₁₆	⁵ / ₁₆	5.5
2 5V 465 SDS	4.65	4.55	E-1	SDS	2	¹⁵ / ₁₆	0	1 ¹ / ₁₆	⁵ / ₁₆	4.5	3 5V 465 SDS	E-1	SDS	2	1 ¹ / ₁₆	0	1 ¹ / ₁₆	⁵ / ₁₆	6.5
2 5V 490 SDS	4.90	4.80	A-1	SDS	2	¹ / ₁₆	1 ¹ / ₁₆	1 ¹ / ₁₆	¹ / ₁₆	5.0	3 5V 490 SDS	A-1	SDS	2	⁷ / ₁₆	1 ¹ / ₁₆	1 ¹ / ₁₆	¹ / ₁₆	7.0
2 5V 520 SDS	5.20	5.10	A-1	SDS	2	¹ / ₁₆	1 ¹ / ₁₆	1 ¹ / ₁₆	¹ / ₁₆	5.5	3 5V 520 SDS	A-1	SDS	2	⁷ / ₁₆	1 ¹ / ₁₆	1 ¹ / ₁₆	¹ / ₁₆	7.5
2 5V 550 SDS	5.50	5.40	A-1	SDS	2	¹ / ₁₆	1 ¹ / ₁₆	1 ¹ / ₁₆	¹ / ₁₆	6.0	3 5V 550 SDS	A-1	SDS	2	⁷ / ₁₆	1 ¹ / ₁₆	1 ¹ / ₁₆	¹ / ₁₆	8.0
2 5V 590 SDS	5.90	5.80	A-1	SDS	2	¹ / ₁₆	1 ¹ / ₁₆	1 ¹ / ₁₆	¹ / ₁₆	7.0	3 5V 590 SDS	A-1	SDS	2	⁷ / ₁₆	1 ¹ / ₁₆	1 ¹ / ₁₆	¹ / ₁₆	8.5
2 5V 630 SK	6.30	6.20	C-1	SK	2 ³ / ₈	¹ / ₄	⁷ / ₁₆	1 ¹ / ₁₆	0	8.0	3 5V 630 SK	A-1	SK	2 ³ / ₈	³ / ₈	1 ¹ / ₁₆	1 ¹ / ₁₆	¹ / ₁₆	11.0
2 5V 670 SK	6.70	6.60	C-1	SK	2 ³ / ₈	¹ / ₄	⁷ / ₁₆	1 ¹ / ₁₆	0	10.0	3 5V 670 SK	A-1	SK	2 ³ / ₈	³ / ₈	1 ¹ / ₁₆	1 ¹ / ₁₆	¹ / ₁₆	11.5
2 5V 710 SK	7.10	7.00	C-1	SK	2 ³ / ₈	¹ / ₄	⁷ / ₁₆	1 ¹ / ₁₆	0	11.0	3 5V 710 SF	A-1	SF	2 ¹ / ₁₆	⁵ / ₁₆	1	2 ¹ / ₁₆	0	13.0
2 5V 750 SK	7.50	7.40	C-1	SK	2 ³ / ₈	¹ / ₄	⁷ / ₁₆	1 ¹ / ₁₆	0	13.0	3 5V 750 SF	A-1	SF	2 ¹ / ₁₆	⁵ / ₁₆	1	2 ¹ / ₁₆	0	14.0
2 5V 800 SK	8.00	7.90	C-1	SK	2 ³ / ₈	¹ / ₄	⁷ / ₁₆	1 ¹ / ₁₆	0	14.0	3 5V 800 SF	A-1	SF	2 ¹ / ₁₆	⁵ / ₁₆	1	2 ¹ / ₁₆	0	15.0
2 5V 850 SK	8.50	8.40	C-1	SK	2 ³ / ₈	¹ / ₄	⁷ / ₁₆	1 ¹ / ₁₆	0	15.0	3 5V 850 SF	A-1	SF	2 ¹ / ₁₆	⁵ / ₁₆	1	2 ¹ / ₁₆	0	16.0
2 5V 900 SK	9.00	8.90	C-2	SK	2 ³ / ₈	¹ / ₄	⁷ / ₁₆	1 ¹ / ₁₆	0	16.0	3 5V 900 SF	A-2	SF	2 ¹ / ₁₆	⁵ / ₁₆	1	2 ¹ / ₁₆	0	17.0
2 5V 925 SK	9.25	9.15	C-2	SK	2 ³ / ₈	¹ / ₄	⁷ / ₁₆	1 ¹ / ₁₆	0	16.5	3 5V 925 SF	A-2	SF	2 ¹ / ₁₆	⁵ / ₁₆	1	2 ¹ / ₁₆	0	18.0
2 5V 975 SK	9.75	9.65	C-3	SK	2 ³ / ₈	¹ / ₄	⁷ / ₁₆	1 ¹ / ₁₆	0	17.0	3 5V 975 SF	A-2	SF	2 ¹ / ₁₆	⁵ / ₁₆	1	2 ¹ / ₁₆	0	19.0
2 5V 1030 SK	10.30	10.20	C-3	SK	2 ³ / ₈	¹ / ₄	⁷ / ₁₆	1 ¹ / ₁₆	0	18.0	3 5V 1030 SF	A-2	SF	2 ¹ / ₁₆	⁵ / ₁₆	1	2 ¹ / ₁₆	0	22.0
2 5V 1090 SK	10.90	10.80	C-3	SK	2 ³ / ₈	¹ / ₄	⁷ / ₁₆	1 ¹ / ₁₆	0	19.0	3 5V 1090 SF	A-2	SF	2 ¹ / ₁₆	⁵ / ₁₆	1	2 ¹ / ₁₆	0	25.0
2 5V 1130 SK	11.30	11.20	C-3	SK	2 ³ / ₈	¹ / ₄	⁷ / ₁₆	1 ¹ / ₁₆	0	19.5	3 5V 1130 SF	A-2	SF	2 ¹ / ₁₆	⁵ / ₁₆	1	2 ¹ / ₁₆	0	25.0
2 5V 1180 SK	11.80	11.70	C-3	SK	2 ³ / ₈	¹ / ₄	⁷ / ₁₆	1 ¹ / ₁₆	0	20.0	3 5V 1180 SF	A-2	SF	2 ¹ / ₁₆	⁵ / ₁₆	1	2 ¹ / ₁₆	0	29.0
2 5V 1250 SF	12.50	12.40	C-3	SF	2 ³ / ₈	¹ / ₄	⁷ / ₁₆	2 ¹ / ₁₆	¹ / ₈	25.0	3 5V 1250 E	C-2	E	3 ¹ / ₂	¹ / ₈	³ / ₈	2 ³ / ₈	¹ / ₈	32.0
2 5V 1320 SF	13.20	13.10	C-3	SF	2 ³ / ₈	¹ / ₄	⁷ / ₁₆	2 ¹ / ₁₆	¹ / ₈	27.0	3 5V 1320 E	C-3	E	3 ¹ / ₂	¹ / ₈	³ / ₈	2 ³ / ₈	¹ / ₈	38.0
2 5V 1400 SF	14.00	13.90	C-3	SF	2 ³ / ₈	¹ / ₄	⁷ / ₁₆	2 ¹ / ₁₆	¹ / ₈	28.0	3 5V 1400 E	C-3	E	3 ¹ / ₂	¹ / ₈	³ / ₈	2 ³ / ₈	¹ / ₈	43.0
2 5V 1500 SF	15.00	14.90	C-3	SF	2 ³ / ₈	¹ / ₄	⁷ / ₁₆	2 ¹ / ₁₆	¹ / ₈	30.0	3 5V 1500 E	C-3	E	3 ¹ / ₂	¹ / ₈	³ / ₈	2 ³ / ₈	¹ / ₈	44.0
2 5V 1600 SF	16.00	15.90	C-3	SF	2 ³ / ₈	¹ / ₄	⁷ / ₁₆	2 ¹ / ₁₆	¹ / ₈	34.0	3 5V 1600 E	C-3	E	3 ¹ / ₂	¹ / ₈	³ / ₈	2 ³ / ₈	¹ / ₈	46.0
2 5V 1870 SF	18.70	18.60	C-3	SF	2 ³ / ₈	¹ / ₄	⁷ / ₁₆	2 ¹ / ₁₆	¹ / ₈	49.0	3 5V 1870 E	C-3	E	3 ¹ / ₂	¹ / ₈	³ / ₈	2 ³ / ₈	¹ / ₈	60.0
2 5V 2120 SF	21.20	21.10	C-3	SF	2 ³ / ₈	¹ / ₄	⁷ / ₁₆	2 ¹ / ₁₆	¹ / ₈	50.0	3 5V 2120 E	C-3	E	3 ¹ / ₂	¹ / ₈	³ / ₈	2 ³ / ₈	¹ / ₈	68.0
2 5V 2360 E	23.60	23.50	C-3	E	3 ¹ / ₂	³ / ₈	¹ / ₄	2 ³ / ₈	³ / ₁₆	72.0	3 5V 2360 E	C-3	E	3 ¹ / ₂	¹ / ₈	³ / ₈	2 ³ / ₈	¹ / ₈	80.0
2 5V 2800 E	28.00	27.90	C-3	E	3 ¹ / ₂	³ / ₈	¹ / ₄	2 ³ / ₈	³ / ₁₆	80.0	3 5V 2800 E	C-3	E	3 ¹ / ₂	¹ / ₈	³ / ₈	2 ³ / ₈	¹ / ₈	92.0
	31.50	31.40									3 5V 3150 F	C-3	F	3 ¹ / ₁₆	⁷ / ₁₆	⁹ / ₁₆	3 ³ / ₈	¹ / ₁₆	136.0
	37.50	37.40									3 5V 3750 F	C-3	F	3 ¹ / ₁₆	⁷ / ₁₆	⁹ / ₁₆	3 ³ / ₈	¹ / ₁₆	156.0
	50.00	49.90									3 5V 5000 F	C-3	F	3 ¹ / ₁₆	⁷ / ₁₆	⁹ / ₁₆	3 ³ / ₈	¹ / ₁₆	210.0

Weights do not include bushings. See page B-7 for additional bushing dimensions.

5V Hi-Cap Wedge Stock QD Sheaves

V-BELT DRIVES

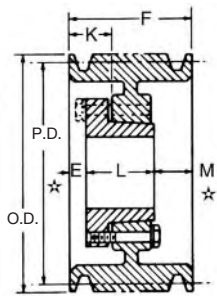

TYPE A

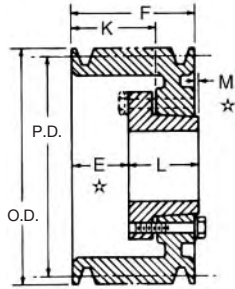

TYPE B

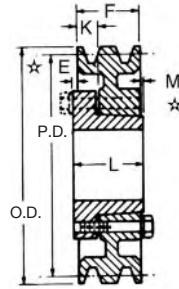

TYPE C

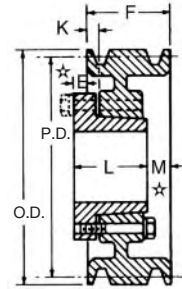

TYPE D

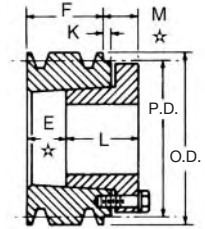

TYPE E

Dimensions in inches, weight in pounds

4 Groove F = 3 ¹ / ₁₆											5 Groove F = 3 ³ / ₁₆								
Part Number	OD	PD 5V Belt	Type	Bush	Bush Max. Bore	E	K	L Thru Bore	M	Wt. Less Bush	Part Number	Type	Bush	Bush Max. Bore	E	K	L Thru Bore	M	Wt. Less Bush
4 5V 440 SD	4.40	4.30	E-1	SD	2	1 ¹ / ₁₆	0	1 ¹ / ₁₆	⁵ / ₁₆	5.0	5 5V 440 SD	E-1	SD	2	2 ³ / ₁₆	0	1 ¹ / ₁₆	⁵ / ₁₆	6.0
4 5V 465 SD	4.65	4.55	E-1	SD	2	1 ¹ / ₁₆	0	1 ¹ / ₁₆	⁵ / ₁₆	6.0	5 5V 465 SD	E-1	SD	2	2 ³ / ₁₆	1 ¹ / ₁₆	1 ¹ / ₁₆	⁵ / ₁₆	7.0
4 5V 490 SD	4.90	4.80	A-1	SD	2	1 ¹ / ₁₆	1 ¹ / ₁₆	1 ¹ / ₁₆	⁵ / ₁₆	7.0	5 5V 490 SD	A-1	SD	2	1 ¹ / ₁₆	1 ¹ / ₁₆	1 ¹ / ₁₆	1 ¹ / ₁₆	8.0
4 5V 520 SD	5.20	5.10	A-1	SD	2	1 ¹ / ₁₆	1 ¹ / ₁₆	1 ¹ / ₁₆	⁵ / ₁₆	8.0	5 5V 520 SD	A-1	SD	2	1 ¹ / ₁₆	1 ¹ / ₁₆	1 ¹ / ₁₆	1 ¹ / ₁₆	9.0
4 5V 550 SD	5.50	5.40	A-1	SD	2	1 ¹ / ₁₆	1 ¹ / ₁₆	1 ¹ / ₁₆	⁵ / ₁₆	9.0	5 5V 550 SD	A-1	SD	2	1 ¹ / ₁₆	1 ¹ / ₁₆	1 ¹ / ₁₆	1 ¹ / ₁₆	10.0
4 5V 590 SD	5.90	5.80	A-1	SD	2	1 ¹ / ₁₆	1 ¹ / ₁₆	1 ¹ / ₁₆	⁵ / ₁₆	10.8	5 5V 590 SK	A-1	SK	2	⁵ / ₁₆	1 ¹ / ₁₆	1 ¹ / ₁₆	1 ¹ / ₁₆	11.0
4 5V 630 SK	6.30	6.20	A-1	SK	2	⁵ / ₁₆	1 ¹ / ₁₆	1 ¹ / ₁₆	⁵ / ₁₆	12.0	5 5V 630 SK	A-1	SK	2	⁵ / ₁₆	1 ¹ / ₁₆	1 ¹ / ₁₆	1 ¹ / ₁₆	12.0
4 5V 670 SK	6.70	6.60	A-1	SK	2	⁵ / ₁₆	1 ¹ / ₁₆	1 ¹ / ₁₆	⁵ / ₁₆	14.0	5 5V 670 SF	A-1	SF	2	⁵ / ₁₆	1 ¹ / ₁₆	1 ¹ / ₁₆	1 ¹ / ₁₆	13.0
4 5V 710 SF	7.10	7.00	A-1	SF	2	⁵ / ₁₆	1 ¹ / ₁₆	2 ¹ / ₁₆	⁵ / ₁₆	15.0	5 5V 710 SF	A-1	SF	2	1 ¹ / ₁₆	1 ¹ / ₁₆	2 ¹ / ₁₆	1	14.0
4 5V 750 SF	7.50	7.40	A-1	SF	2	⁵ / ₁₆	1 ¹ / ₁₆	2 ¹ / ₁₆	⁵ / ₁₆	16.0	5 5V 750 SF	A-1	SF	2	1 ¹ / ₁₆	1 ¹ / ₁₆	2 ¹ / ₁₆	1	16.0
4 5V 800 E	8.00	7.90	B-1	E	3 ¹ / ₂	⁵ / ₁₆	1 ¹ / ₁₆	2 ¹ / ₁₆	¹ / ₁₆	19.0	5 5V 800 E	A-1	E	3 ¹ / ₂	⁷ / ₁₆	1 ¹ / ₁₆	2 ¹ / ₁₆	¹ / ₁₆	19.0
4 5V 850 E	8.50	8.40	B-1	E	3 ¹ / ₂	⁵ / ₁₆	1 ¹ / ₁₆	2 ¹ / ₁₆	¹ / ₁₆	23.0	5 5V 850 E	A-1	E	3 ¹ / ₂	⁷ / ₁₆	1 ¹ / ₁₆	2 ¹ / ₁₆	¹ / ₁₆	22.0
4 5V 900 E	9.00	8.90	B-1	E	3 ¹ / ₂	⁵ / ₁₆	1 ¹ / ₁₆	2 ¹ / ₁₆	¹ / ₁₆	25.0	5 5V 900 E	A-1	E	3 ¹ / ₂	⁷ / ₁₆	1 ¹ / ₁₆	2 ¹ / ₁₆	¹ / ₁₆	26.0
4 5V 925 E	9.25	9.15	B-1	E	3 ¹ / ₂	⁵ / ₁₆	1 ¹ / ₁₆	2 ¹ / ₁₆	¹ / ₁₆	26.0	5 5V 925 E	A-1	E	3 ¹ / ₂	⁷ / ₁₆	1 ¹ / ₁₆	2 ¹ / ₁₆	¹ / ₁₆	28.0
4 5V 975 E	9.75	9.65	B-1	E	3 ¹ / ₂	⁵ / ₁₆	1 ¹ / ₁₆	2 ¹ / ₁₆	¹ / ₁₆	28.0	5 5V 975 E	A-1	E	3 ¹ / ₂	⁷ / ₁₆	1 ¹ / ₁₆	2 ¹ / ₁₆	¹ / ₁₆	30.0
4 5V 1030 E	10.30	10.20	B-1	E	3 ¹ / ₂	⁵ / ₁₆	1 ¹ / ₁₆	2 ¹ / ₁₆	¹ / ₁₆	30.0	5 5V 1030 E	A-1	E	3 ¹ / ₂	⁷ / ₁₆	1 ¹ / ₁₆	2 ¹ / ₁₆	¹ / ₁₆	33.0
4 5V 1090 E	10.90	10.80	B-2	E	3 ¹ / ₂	⁵ / ₁₆	1 ¹ / ₁₆	2 ¹ / ₁₆	¹ / ₁₆	39.0	5 5V 1090 E	A-1	E	3 ¹ / ₂	⁷ / ₁₆	1 ¹ / ₁₆	2 ¹ / ₁₆	¹ / ₁₆	41.0
4 5V 1130 E	11.30	11.20	B-2	E	3 ¹ / ₂	⁵ / ₁₆	1 ¹ / ₁₆	2 ¹ / ₁₆	¹ / ₁₆	40.0	5 5V 1130 E	A-1	E	3 ¹ / ₂	⁷ / ₁₆	1 ¹ / ₁₆	2 ¹ / ₁₆	¹ / ₁₆	42.0
4 5V 1180 E	11.80	11.70	B-2	E	3 ¹ / ₂	⁵ / ₁₆	1 ¹ / ₁₆	2 ¹ / ₁₆	¹ / ₁₆	41.0	5 5V 1180 E	A-1	E	3 ¹ / ₂	⁷ / ₁₆	1 ¹ / ₁₆	2 ¹ / ₁₆	¹ / ₁₆	44.0
4 5V 1250 E	12.50	12.40	B-3	E	3 ¹ / ₂	⁵ / ₁₆	1 ¹ / ₁₆	2 ¹ / ₁₆	¹ / ₁₆	43.0	5 5V 1250 E	A-3	E	3 ¹ / ₂	⁷ / ₁₆	1 ¹ / ₁₆	2 ¹ / ₁₆	¹ / ₁₆	45.0
4 5V 1320 E	13.20	13.10	B-3	E	3 ¹ / ₂	⁵ / ₁₆	1 ¹ / ₁₆	2 ¹ / ₁₆	¹ / ₁₆	45.0	5 5V 1320 E	A-3	E	3 ¹ / ₂	⁷ / ₁₆	1 ¹ / ₁₆	2 ¹ / ₁₆	¹ / ₁₆	46.0
4 5V 1400 E	14.00	13.90	B-3	E	3 ¹ / ₂	⁵ / ₁₆	1 ¹ / ₁₆	2 ¹ / ₁₆	¹ / ₁₆	46.0	5 5V 1400 E	A-3	E	3 ¹ / ₂	⁷ / ₁₆	1 ¹ / ₁₆	2 ¹ / ₁₆	¹ / ₁₆	47.0
4 5V 1500 E	15.00	14.90	B-3	E	3 ¹ / ₂	⁵ / ₁₆	1 ¹ / ₁₆	2 ¹ / ₁₆	¹ / ₁₆	47.0	5 5V 1500 E	A-3	E	3 ¹ / ₂	⁷ / ₁₆	1 ¹ / ₁₆	2 ¹ / ₁₆	¹ / ₁₆	53.0
4 5V 1600 E	16.00	15.90	B-3	E	3 ¹ / ₂	⁵ / ₁₆	1 ¹ / ₁₆	2 ¹ / ₁₆	¹ / ₁₆	49.0	5 5V 1600 E	A-3	E	3 ¹ / ₂	⁷ / ₁₆	1 ¹ / ₁₆	2 ¹ / ₁₆	¹ / ₁₆	56.0
4 5V 1870 E	18.70	18.60	A-3	E	3 ¹ / ₂	⁵ / ₁₆	1 ¹ / ₁₆	2 ¹ / ₁₆	¹ / ₁₆	71.0	5 5V 1870 F	B-3	F	3 ¹⁵ / ₁₆	⁵ / ₁₆	1 ¹ / ₁₆	3 ¹ / ₁₆	³ / ₁₆	96.0
4 5V 2120 E	21.20	21.10	A-3	E	3 ¹ / ₂	⁵ / ₁₆	1 ¹ / ₁₆	2 ¹ / ₁₆	¹ / ₁₆	72.0	5 5V 2120 F	B-3	F	3 ¹⁵ / ₁₆	⁵ / ₁₆	1 ¹ / ₁₆	3 ¹ / ₁₆	³ / ₁₆	98.0
4 5V 2360 F	23.60	23.50	C-3	F	3 ¹⁵ / ₁₆	¹ / ₁₆	⁷ / ₁₆	3 ¹ / ₁₆	³ / ₁₆	111.0	5 5V 2360 F	B-3	F	3 ¹⁵ / ₁₆	⁵ / ₁₆	1 ¹ / ₁₆	3 ¹ / ₁₆	³ / ₁₆	120.0
4 5V 2800 F	28.00	27.90	C-3	F	3 ¹⁵ / ₁₆	¹ / ₁₆	⁷ / ₁₆	3 ¹ / ₁₆	³ / ₁₆	118.0	5 5V 2800 F	B-3	F	3 ¹⁵ / ₁₆	⁵ / ₁₆	1 ¹ / ₁₆	3 ¹ / ₁₆	³ / ₁₆	135.0
4 5V 3150 F	31.50	31.40	C-3	F	3 ¹⁵ / ₁₆	¹ / ₁₆	⁷ / ₁₆	3 ¹ / ₁₆	³ / ₁₆	146.7	5 5V 3150 J	C-3	J	4 ¹ / ₂	³ / ₁₆	1	4 ¹ / ₂	³ / ₁₆	188.0
4 5V 3750 F	37.50	37.40	C-3	F	3 ¹⁵ / ₁₆	¹ / ₁₆	⁷ / ₁₆	3 ¹ / ₁₆	³ / ₁₆	178.0	5 5V 3750 J	C-3	J	4 ¹ / ₂	³ / ₁₆	1	4 ¹ / ₂	³ / ₁₆	224.0
4 5V 5000 J	50.00	49.90	C-3	J	4 ¹ / ₂	¹ / ₂	1 ¹ / ₁₆	4 ¹ / ₂	1 ⁵ / ₁₆	266.0	5 5V 5000 J	C-3	J	4 ¹ / ₂	³ / ₁₆	1	4 ¹ / ₂	³ / ₁₆	308.0

★ E and M dimensions are nominal and will vary depending on shaft tolerances. Type E sheaves are drilled for reverse mounting only.

Dimensions in inches, weight in pounds

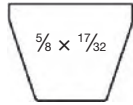

5V

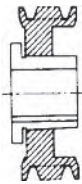

1 = SOLID

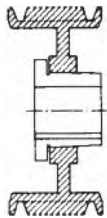

2 = WEB

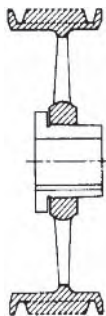

3 = ARM/SPOKE

6 Groove										
F = 4 ⁷ / ₁₆										
Part Number	OD	PD	Type	Bush	Bush Max. Bore	E	K	L Thru Bore	M	Wt. Less Bush
		5V Belt								
6 5V 440 SD	4.40	4.30	E-1	SD	2	3 ³ / ₄	0	1 ¹ / ₁₆	3 ¹ / ₈	7.0
6 5V 465 SD	4.65	4.55	E-1	SD	2	3 ³ / ₄	0	1 ¹ / ₁₆	3 ¹ / ₈	7.8
6 5V 490 SD	4.90	4.80	A-1	SD	2	1 ¹ / ₁₆	1 ¹ / ₁₆	1 ¹ / ₁₆	1 ¹ / ₁₆	9.0
6 5V 520 SD	5.20	5.10	A-1	SD	2	1 ¹ / ₁₆	1 ¹ / ₁₆	1 ¹ / ₁₆	1 ¹ / ₁₆	10.8
6 5V 550 SD	5.50	5.40	A-1	SD	2	1 ¹ / ₁₆	1 ¹ / ₁₆	1 ¹ / ₁₆	1 ¹ / ₁₆	11.3
6 5V 590 SK	5.90	5.80	A-1	SK	2 ¹ / ₁₆	3 ¹ / ₈	1 ¹ / ₁₆	1 ¹ / ₁₆	1 ¹ / ₁₆	12.0
6 5V 630 SK	6.30	6.20	A-1	SK	2 ¹ / ₁₆	3 ¹ / ₈	1 ¹ / ₁₆	1 ¹ / ₁₆	1 ¹ / ₁₆	13.0
6 5V 670 SF	6.70	6.60	A-1	SF	2 ¹ / ₁₆	3 ¹ / ₈	1 ¹ / ₁₆	2 ¹ / ₁₆	1 ¹ / ₁₆	14.0
6 5V 710 SF	7.10	7.00	A-1	SF	2 ¹ / ₁₆	3 ¹ / ₈	1 ¹ / ₁₆	2 ¹ / ₁₆	1 ¹ / ₁₆	15.0
6 5V 750 SF	7.50	7.40	A-1	SF	2 ¹ / ₁₆	3 ¹ / ₈	1 ¹ / ₁₆	2 ¹ / ₁₆	1 ¹ / ₁₆	17.0
6 5V 800 E	8.00	7.90	A-1	E	3 ¹ / ₂	1 ¹ / ₂	2	2 ¹ / ₁₆	1 ¹ / ₁₆	20.0
6 5V 850 E	8.50	8.40	A-1	E	3 ¹ / ₂	1 ¹ / ₂	2	2 ¹ / ₁₆	1 ¹ / ₁₆	25.0
6 5V 900 E	9.00	8.90	A-1	E	3 ¹ / ₂	1 ¹ / ₂	2	2 ¹ / ₁₆	1 ¹ / ₁₆	28.0
6 5V 925 E	9.25	9.15	A-1	E	3 ¹ / ₂	1 ¹ / ₂	2	2 ¹ / ₁₆	1 ¹ / ₁₆	29.0
6 5V 975 E	9.75	9.65	A-1	E	3 ¹ / ₂	1 ¹ / ₂	2	2 ¹ / ₁₆	1 ¹ / ₁₆	31.0
6 5V 1030 E	10.30	10.20	A-1	E	3 ¹ / ₂	1 ¹ / ₂	2	2 ¹ / ₁₆	1 ¹ / ₁₆	33.0
6 5V 1090 E	10.90	10.80	A-1	E	3 ¹ / ₂	1 ¹ / ₂	2	2 ¹ / ₁₆	1 ¹ / ₁₆	38.0
6 5V 1130 E	11.30	11.20	A-1	E	3 ¹ / ₂	1 ¹ / ₂	2	2 ¹ / ₁₆	1 ¹ / ₁₆	41.0
6 5V 1180 E	11.80	11.70	A-1	E	3 ¹ / ₂	1 ¹ / ₂	2	2 ¹ / ₁₆	1 ¹ / ₁₆	43.0
6 5V 1250 F	12.50	12.40	B-3	F	3 ³ / ₁₆	1 ¹ / ₁₆	2 ¹ / ₁₆	3 ¹ / ₈	1 ¹ / ₈	45.0
6 5V 1320 F	13.20	13.10	B-3	F	3 ³ / ₁₆	1 ¹ / ₁₆	2 ¹ / ₁₆	3 ¹ / ₈	1 ¹ / ₈	48.0
6 5V 1400 F	14.00	13.90	B-3	F	3 ³ / ₁₆	1 ¹ / ₁₆	2 ¹ / ₁₆	3 ¹ / ₈	1 ¹ / ₈	59.0
6 5V 1500 F	15.00	14.90	B-3	F	3 ³ / ₁₆	1 ¹ / ₁₆	2 ¹ / ₁₆	3 ¹ / ₈	1 ¹ / ₈	64.0
6 5V 1600 F	16.00	15.90	B-3	F	3 ³ / ₁₆	1 ¹ / ₁₆	2 ¹ / ₁₆	3 ¹ / ₈	1 ¹ / ₈	68.0
6 5V 1870 F	18.70	18.60	A-3	F	3 ³ / ₁₆	3 ¹ / ₈	1 ¹ / ₁₆	3 ¹ / ₈	1 ¹ / ₈	83.8
6 5V 2120 F	21.20	21.10	A-3	F	3 ³ / ₁₆	3 ¹ / ₈	1 ¹ / ₁₆	3 ¹ / ₈	1 ¹ / ₈	110.0
6 5V 2360 J	23.60	23.50	B-3	J	4 ¹ / ₂	1 ¹ / ₈	1 ¹ / ₁₆	4 ¹ / ₂	3 ¹ / ₈	148.0
6 5V 2800 J	28.00	27.90	B-3	J	4 ¹ / ₂	1 ¹ / ₈	1 ¹ / ₁₆	4 ¹ / ₂	3 ¹ / ₈	169.0
6 5V 3150 J	31.50	31.40	B-3	J	4 ¹ / ₂	1 ¹ / ₈	1 ¹ / ₁₆	4 ¹ / ₂	3 ¹ / ₈	206.0
6 5V 3750 J	37.50	37.40	B-3	J	4 ¹ / ₂	1 ¹ / ₈	1 ¹ / ₁₆	4 ¹ / ₂	3 ¹ / ₈	241.0
6 5V 5000 M	50.00	49.90	C-3	M	5 ¹ / ₂	1 ¹ / ₈	1 ¹ / ₂	6 ¹ / ₂	1 ¹ / ₂	388.0

Weights do not include bushings. See page B-7 for additional bushing dimensions.

5V Hi-Cap Wedge Stock QD Sheaves

Martin

V-BELT DRIVES

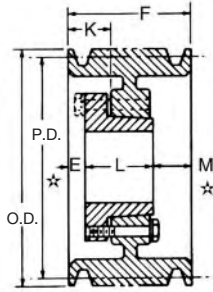

TYPE A

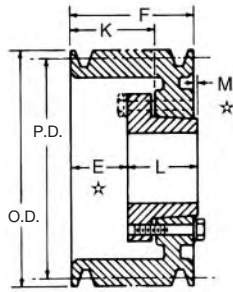

TYPE B

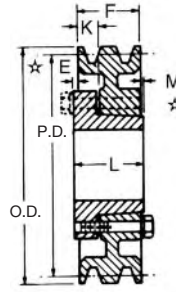

TYPE C

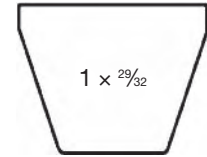

8V

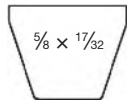

5V

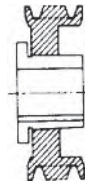

1 = SOLID

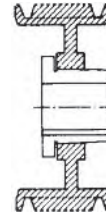

2 = WEB

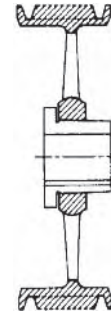

3 = ARM/SPOKE

Dimensions in inches, weight in pounds

8 Groove F = 5 ¹³ / ₁₆											10 Groove F = 7 ⁷ / ₁₆									
Part Number	OD	PD 5V Belt	Type	Bush	Bush Max. Bore	E	K	L Thru Bore	M	Wt. Less Bush	Part Number	Type	Bush	Bush Max. Bore	E	K	L Thru Bore	M	Wt. Less Bush	
8 5V 710 SF	7.10	7.00	A-1	SF	2 ¹ / ₁₆	1 ¹ / ₁₆	2 ¹ / ₂	2 ¹ / ₂	2 ¹ / ₂	19.0	10 5V 800 E	A-1	E	3 ³ / ₁₆	2 ¹ / ₂	3 ³ / ₁₆	2 ¹ / ₂	2 ¹ / ₂	27.0	
8 5V 750 SF	7.50	7.40	A-1	SF	2 ¹ / ₁₆	1 ¹ / ₁₆	2 ¹ / ₂	2 ¹ / ₂	2 ¹ / ₂	20.0	10 5V 850 E	A-1	E	3 ³ / ₁₆	2 ¹ / ₂	3 ³ / ₁₆	2 ¹ / ₂	2 ¹ / ₂	32.0	
8 5V 800 E	8.00	7.90	A-1	E	3 ¹ / ₂	1 ¹ / ₁₆	2 ¹ / ₂	2 ¹ / ₂	1 ¹ / ₁₆	25.0	10 5V 900 F	A-1	F	3 ¹ / ₁₆	2 ¹ / ₂	3 ¹ / ₁₆	3 ¹ / ₂	1 ¹ / ₂	41.0	
8 5V 850 E	8.50	8.40	A-1	E	3 ¹ / ₂	1 ¹ / ₁₆	2 ¹ / ₂	2 ¹ / ₂	1 ¹ / ₁₆	29.0	10 5V 925 F	A-1	F	3 ¹ / ₁₆	2 ¹ / ₂	3 ¹ / ₁₆	3 ¹ / ₂	1 ¹ / ₂	47.0	
8 5V 900 E	9.00	8.90	A-1	E	3 ¹ / ₂	1 ¹ / ₁₆	2 ¹ / ₂	2 ¹ / ₂	1 ¹ / ₁₆	32.0	10 5V 975 F	A-1	F	3 ¹ / ₁₆	2 ¹ / ₂	3 ¹ / ₁₆	3 ¹ / ₂	1 ¹ / ₂	58.0	
8 5V 925 F	9.25	9.15	A-1	F	3 ¹ / ₂	1 ¹ / ₁₆	2 ¹ / ₂	3 ¹ / ₂	3 ¹ / ₂	39.0	10 5V 1030 F	A-1	F	3 ¹ / ₁₆	2 ¹ / ₂	3 ¹ / ₁₆	3 ¹ / ₂	3 ¹ / ₂	1 ¹ / ₂	66.0
8 5V 975 F	9.75	9.65	A-1	F	3 ¹ / ₂	1 ¹ / ₁₆	2 ¹ / ₂	3 ¹ / ₂	3 ¹ / ₂	42.0	10 5V 1090 F	A-1	F	3 ¹ / ₁₆	2 ¹ / ₂	3 ¹ / ₁₆	3 ¹ / ₂	3 ¹ / ₂	1 ¹ / ₂	75.0
8 5V 1030 F	10.30	10.20	A-1	F	3 ¹ / ₂	1 ¹ / ₁₆	2 ¹ / ₂	3 ¹ / ₂	3 ¹ / ₂	52.0	10 5V 1130 F	A-1	F	3 ¹ / ₁₆	2 ¹ / ₂	3 ¹ / ₁₆	3 ¹ / ₂	3 ¹ / ₂	1 ¹ / ₂	79.0
8 5V 1090 F	10.90	10.80	A-1	F	3 ¹ / ₂	1 ¹ / ₁₆	2 ¹ / ₂	3 ¹ / ₂	3 ¹ / ₂	59.0	10 5V 1180 F	A-1	F	3 ¹ / ₁₆	2 ¹ / ₂	3 ¹ / ₁₆	3 ¹ / ₂	3 ¹ / ₂	1 ¹ / ₂	80.0
8 5V 1130 F	11.30	11.20	A-1	F	3 ¹ / ₂	1 ¹ / ₁₆	2 ¹ / ₂	3 ¹ / ₂	3 ¹ / ₂	62.0	10 5V 1250 J	A-1	J	4 ¹ / ₂	2 ¹ / ₂	3 ¹ / ₁₆	4 ¹ / ₂	3 ¹ / ₂	82.0	
8 5V 1180 F	11.80	11.70	A-1	F	3 ¹ / ₂	1 ¹ / ₁₆	2 ¹ / ₂	3 ¹ / ₂	3 ¹ / ₂	64.0	10 5V 1320 J	A-1	J	4 ¹ / ₂	2 ¹ / ₂	3 ¹ / ₁₆	4 ¹ / ₂	3 ¹ / ₂	85.0	
8 5V 1250 F	12.50	12.40	A-3	F	3 ¹ / ₂	1 ¹ / ₁₆	2 ¹ / ₂	3 ¹ / ₂	3 ¹ / ₂	66.0	10 5V 1400 J	A-1	J	4 ¹ / ₂	2 ¹ / ₂	3 ¹ / ₁₆	4 ¹ / ₂	3 ¹ / ₂	90.0	
8 5V 1320 F	13.20	13.10	A-3	F	3 ¹ / ₂	1 ¹ / ₁₆	2 ¹ / ₂	3 ¹ / ₂	3 ¹ / ₂	68.0	10 5V 1500 J	A-2	J	4 ¹ / ₂	2 ¹ / ₂	3 ¹ / ₁₆	4 ¹ / ₂	3 ¹ / ₂	92.0	
8 5V 1400 F	14.00	13.90	A-3	F	3 ¹ / ₂	1 ¹ / ₁₆	2 ¹ / ₂	3 ¹ / ₂	3 ¹ / ₂	70.0	10 5V 1600 J	A-1	J	4 ¹ / ₂	2 ¹ / ₂	3 ¹ / ₁₆	4 ¹ / ₂	3 ¹ / ₂	102.0	
8 5V 1500 F	15.00	14.90	A-3	F	3 ¹ / ₂	1 ¹ / ₁₆	2 ¹ / ₂	3 ¹ / ₂	3 ¹ / ₂	73.0	10 5V 1870 J	A-3	J	4 ¹ / ₂	2 ¹ / ₂	3 ¹ / ₁₆	4 ¹ / ₂	2 ¹ / ₂	150.0	
8 5V 1600 F	16.00	15.90	A-3	F	3 ¹ / ₂	1 ¹ / ₁₆	1 ¹ / ₁₆	3 ¹ / ₂	3 ¹ / ₂	89.0	10 5V 2120 J	A-3	J	4 ¹ / ₂	2 ¹ / ₂	3 ¹ / ₁₆	4 ¹ / ₂	2 ¹ / ₂	164.0	
8 5V 1870 J	18.70	18.60	A-3	J	4 ¹ / ₂	3 ¹ / ₁₆	1 ¹ / ₁₆	4 ¹ / ₂	1 ¹ / ₁₆	132.0	10 5V 2360 M	B-3	M	5 ¹ / ₂	1 ¹ / ₂	1 ¹ / ₁₆	6 ¹ / ₂	1 ¹ / ₁₆	258.0	
8 5V 2120 J	21.20	21.10	A-3	J	4 ¹ / ₂	3 ¹ / ₁₆	1 ¹ / ₁₆	4 ¹ / ₂	1 ¹ / ₁₆	150.0	10 5V 2800 M	B-3	M	5 ¹ / ₂	1 ¹ / ₂	1 ¹ / ₁₆	6 ¹ / ₂	1 ¹ / ₁₆	278.0	
8 5V 2360 J	23.60	23.50	A-3	J	4 ¹ / ₂	3 ¹ / ₁₆	1 ¹ / ₁₆	4 ¹ / ₂	1 ¹ / ₁₆	162.0	10 5V 3150 M	B-3	M	5 ¹ / ₂	1 ¹ / ₂	1 ¹ / ₁₆	6 ¹ / ₂	1 ¹ / ₁₆	318.0	
8 5V 2800 J	28.00	27.90	A-3	J	4 ¹ / ₂	3 ¹ / ₁₆	1 ¹ / ₁₆	4 ¹ / ₂	1 ¹ / ₁₆	191.0	10 5V 3750 M	B-3	M	5 ¹ / ₂	1 ¹ / ₂	1 ¹ / ₁₆	6 ¹ / ₂	1 ¹ / ₁₆	340.0	
8 5V 3150 M	31.50	31.40	B-3	M	5 ¹ / ₂	1 ¹ / ₂	1 ¹ / ₁₆	6 ¹ / ₂	1 ¹ / ₁₆	298.0	10 5V 5000 M	B-3	M	5 ¹ / ₂	1 ¹ / ₂	1 ¹ / ₁₆	6 ¹ / ₂	1 ¹ / ₁₆	538.0	
8 5V 3750 M	37.50	37.40	B-3	M	5 ¹ / ₂	1 ¹ / ₂	1 ¹ / ₁₆	6 ¹ / ₂	1 ¹ / ₁₆	319.0										
8 5V 5000 M	50.00	49.90	B-3	M	5 ¹ / ₂	1 ¹ / ₂	1 ¹ / ₁₆	6 ¹ / ₂	1 ¹ / ₁₆	497.0										

* E and M dimensions are nominal and will vary depending on shaft tolerances.



Hi-Cap Wedge Stock 8V QD Sheaves 8V

Dimensions in inches, weight in pounds

4 Groove											5 Groove								
F = 4 7/8											F = 6								
Part Number	OD	PD 8V Belt	Type	Bush	Bush Max. Bore	E	K	L Thru Bore	M	Wt. Less Bush	Part Number	Type	Bush	Bush Max. Bore	E	K	L Thru Bore	M	Wt. Less Bush
4 8V 1250 F	12.50	12.30	A-1	F	3 3/16	3/16	1 1/8	3 3/8	1 1/8	63.0	5 8V 1250 F	A-1	F	3 3/16	1 1/8	2 3/8	3 3/8	1 1/8	68.0
4 8V 1320 F	13.20	13.00	A-2	F	3 3/16	3/16	1 1/8	3 3/8	1 1/8	66.0	5 8V 1320 F	A-2	F	3 3/16	1 1/8	2 3/8	3 3/8	1 1/8	75.0
4 8V 1400 F	14.00	13.80	A-2	F	3 3/16	3/16	1 1/8	3 3/8	1 1/8	70.0	5 8V 1400 F	A-2	F	3 3/16	1 1/8	2 3/8	3 3/8	1 1/8	78.0
4 8V 1500 F	15.00	14.80	A-2	F	3 3/16	3/16	1 1/8	3 3/8	1 1/8	74.0	5 8V 1500 F	A-2	F	3 3/16	1 1/8	2 3/8	3 3/8	1 1/8	94.0
4 8V 1600 F	16.00	15.80	A-2	F	3 3/16	3/16	1 1/8	3 3/8	1 1/8	82.0	5 8V 1600 F	A-2	F	3 3/16	1 1/8	2 3/8	3 3/8	1 1/8	101.0
4 8V 1700 F	17.00	16.80	A-3	F	3 3/16	3/16	1 1/8	3 3/8	1 1/8	94.0	5 8V 1700 J	A-3	J	4 1/2	1 3/8	2	4 1/2	1 1/8	111.0
4 8V 1800 F	18.00	17.80	A-3	F	3 3/16	3/16	1 1/8	3 3/8	1 1/8	99.0	5 8V 1800 J	A-3	J	4 1/2	1 3/8	2	4 1/2	1 1/8	130.0
4 8V 1900 F	19.00	18.80	A-3	F	3 3/16	3/16	1 1/8	3 3/8	1 1/8	105.0	5 8V 1900 J	A-3	J	4 1/2	1 3/8	2	4 1/2	1 1/8	135.0
4 8V 2000 J	20.00	19.80	A-3	J	4 1/2	1/2	1 1/8	4 1/2	1/2	141.0	5 8V 2000 J	A-3	J	4 1/2	1 3/8	2	4 1/2	1 1/8	152.0
4 8V 2120 J	21.20	21.00	A-3	J	4 1/2	1/2	1 1/8	4 1/2	1/2	150.0	5 8V 2120 J	A-3	J	4 1/2	1 3/8	2	4 1/2	1 1/8	153.0
4 8V 2240 J	22.40	22.20	A-3	J	4 1/2	1/2	1 1/8	4 1/2	1/2	177.0	5 8V 2240 M	B-3	M	5 1/2	1/2	1 1/8	6 3/4	1 1/4	223.0
4 8V 2480 M	24.80	24.60	C-3	M	5 1/2	5/8	1 1/8	6 3/4	1 1/4	223.0	5 8V 2480 M	B-3	M	5 1/2	1/2	1 1/8	6 3/4	1 1/4	234.0
4 8V 3000 M	30.00	29.80	C-3	M	5 1/2	5/8	1 1/8	6 3/4	1 1/4	285.0	5 8V 3000 M	B-3	M	5 1/2	1/2	1 1/8	6 3/4	1 1/4	294.0
4 8V 3550 M	35.50	35.30	C-3	M	5 1/2	5/8	1 1/8	6 3/4	1 1/4	305.0	5 8V 3550 M	B-3	M	5 1/2	1/2	1 1/8	6 3/4	1 1/4	325.0
4 8V 4000 M	40.00	39.80	C-3	M	5 1/2	5/8	1 1/8	6 3/4	1 1/4	355.0	5 8V 4000 M	B-3	M	5 1/2	1/2	1 1/8	6 3/4	1 1/4	430.0
4 8V 4450 M	44.50	44.30	C-3	M	5 1/2	5/8	1 1/8	6 3/4	1 1/4	369.0	5 8V 4450 N	C-3	N	6	1 3/8	1 3/8	8 3/4	1 3/8	485.0
4 8V 5300 M	53.00	52.80	C-3	M	5 1/2	5/8	1 1/8	6 3/4	1 1/4	478.0	5 8V 5300 N	C-3	N	6	1 3/8	1 3/8	8 3/4	1 3/8	672.0

V-BELT DRIVES

Dimensions in inches, weight in pounds

6 Groove											8 Groove								
F = 7 1/8											F = 9 3/8								
Part Number	OD	PD 8V Belt	Type	Bush	Bush Max. Bore	E	K	L Thru Bore	M	Wt. Less Bush	Part Number	Type	Bush	Bush Max. Bore	E	K	L Thru Bore	M	Wt. Less Bush
6 8V 1250 F	12.50	12.30	A-1	F	3 3/16	1 1/8	2 3/8	3 3/8	2 3/8	86.0	8 8V 1250 J	A-1	J	4 1/2	2 3/8	3 3/8	4 1/2	2 1/2	108.0
6 8V 1320 F	13.20	13.00	A-1	F	3 3/16	1 1/8	2 3/8	3 3/8	2 3/8	94.0	8 8V 1320 J	A-1	J	4 1/2	2 3/8	3 3/8	4 1/2	2 1/2	118.0
6 8V 1400 F	14.00	13.80	A-1	F	3 3/16	1 1/8	2 3/8	3 3/8	2 3/8	108.0	8 8V 1400 J	A-1	J	4 1/2	2 3/8	3 3/8	4 1/2	2 1/2	131.0
6 8V 1500 J	15.00	14.80	A-1	J	4 1/2	1 3/8	2 3/8	4 1/2	1 3/8	138.0	8 8V 1500 J	A-1	J	4 1/2	2 3/8	3 3/8	4 1/2	2 1/2	151.0
6 8V 1600 J	16.00	15.80	A-1	J	4 1/2	1 3/8	2 3/8	4 1/2	1 3/8	142.0	8 8V 1600 J	A-1	J	4 1/2	2 3/8	3 3/8	4 1/2	2 1/2	155.0
6 8V 1700 J	17.00	16.80	A-2	J	4 1/2	1 3/8	2 3/8	4 1/2	1 3/8	144.0	8 8V 1700 M	A-2	M	5 1/2	2 1/2	3 3/8	6 3/4	1/2	188.0
6 8V 1800 J	18.00	17.80	A-2	J	4 1/2	1 3/8	2 3/8	4 1/2	1 3/8	160.0	8 8V 1800 M	A-2	M	5 1/2	2 1/2	3 3/8	6 3/4	1/2	202.0
6 8V 1900 J	19.00	18.80	A-2	J	4 1/2	1 3/8	2 3/8	4 1/2	1 3/8	172.0	8 8V 1900 M	A-2	M	5 1/2	2 1/2	3 3/8	6 3/4	1/2	221.0
6 8V 2000 M	20.00	19.80	B-2	M	5 1/2	1 1/2	2 3/8	6 3/4	1 1/2	204.0	8 8V 2000 M	A-2	M	5 1/2	2 1/2	3 3/8	6 3/4	1/2	236.0
6 8V 2120 M	21.20	21.00	B-2	M	5 1/2	1 1/2	2 3/8	6 3/4	1 1/2	226.0	8 8V 2120 M	A-2	M	5 1/2	2 1/2	3 3/8	6 3/4	1/2	267.0
6 8V 2240 M	22.40	22.20	B-3	M	5 1/2	1 1/2	2 3/8	6 3/4	1 1/2	235.0	8 8V 2240 M	A-3	M	5 1/2	2 1/2	3 3/8	6 3/4	1/2	284.0
6 8V 2480 M	24.80	24.60	B-3	M	5 1/2	1 1/2	2 3/8	6 3/4	1 1/2	246.0	8 8V 2480 N	A-2	N	6	1/2	2 1/4	8 3/4	3/4	418.0
6 8V 3000 M	30.00	29.80	B-3	M	6	1/2	1 1/8	6 3/4	1 1/2	306.0	8 8V 3000 N	A-3	N	6	1/2	2 1/4	8 3/4	3/4	447.0
6 8V 3550 N	35.50	35.30	C-3	N	6	5/8	1 1/2	8 3/4	1 1/2	466.0	8 8V 3550 N	A-3	N	6	1/2	2 1/4	8 3/4	3/4	553.0
6 8V 4000 N	40.00	39.80	C-3	N	6	5/8	1 1/2	8 3/4	1 1/2	548.0	8 8V 4000 N	A-3	N	6	1/2	2 1/4	8 3/4	3/4	648.0
6 8V 4450 N	44.50	44.30	C-3	N	6	5/8	1 1/2	8 3/4	1 1/2	590.0	8 8V 4450 P	B-3	P	6 3/4	5/8	2 3/8	9 3/4	5/8	679.0
6 8V 5300 N	53.00	52.80	C-3	N	6	5/8	1 1/2	8 3/4	1 1/2	658.0	8 8V 5300 P	B-3	P	6 3/4	5/8	2 3/8	9 3/4	5/8	946.0
6 8V 6300 P	63.00	62.80	C-3	P	6 3/4	0	2	9 3/4	1 1/2	860.0	8 8V 6300 P	B-3	P	6 3/4	5/8	2 3/8	9 3/4	5/8	1372.0
6 8V 7100 P	71.00	70.80	B-3	P	6 3/4	0	2	9 3/4	1 1/2	1272.0	8 8V 7100 W	C-3	W	8 1/2	3/8	1 1/2	11 3/4	3/4	1680.0

E and M dimensions are nominal and will vary depending on shaft tolerances. See page B-7 for additional bushing dimensions.

8V Hi-Cap Wedge Stock QD Sheaves

V-BELT DRIVES

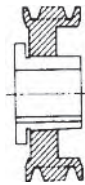
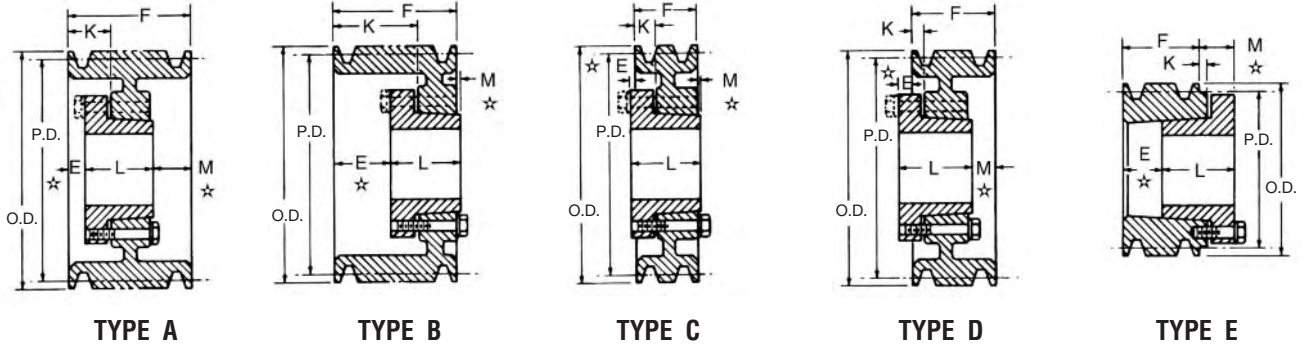

1 = SOLID

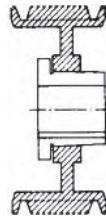

2 = WEB

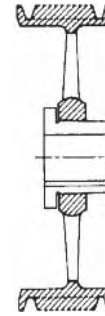

3 = ARM/SPOKE

Dimensions in inches, weight in pounds

10 Groove											12 Groove								
F = 11 5/8											F = 14								
Part Number	OD	PD 8V Belt	Type	Bush	Bush Max. Bore	E	K	L Thru Bore	M	Wt. Less Bush	Part Number	Type	Bush	Bush Max. Bore	E	K	L Thru Bore	M	Wt. Less Bush
10 8V 1250 J	12.50	12.30	A-1	J	4 1/2	2 3/8	3 3/8	4 1/2	4 3/8	122.0	12 8V 1250 M	A-1	M	5 1/2	2 1/2	3 3/8	6 3/8	4 3/8	161.0
10 8V 1320 J	13.20	13.00	A-1	J	4 1/2	2 3/8	3 3/8	4 1/2	4 3/8	140.0	12 8V 1320 M	A-1	M	5 1/2	2 1/2	3 3/8	6 3/8	4 3/8	185.0
10 8V 1400 J	14.00	13.80	A-1	J	4 1/2	2 3/8	3 3/8	4 1/2	4 3/8	152.0	12 8V 1400 M	A-1	M	5 1/2	2 1/2	3 3/8	6 3/8	4 3/8	211.0
10 8V 1500 M	15.00	14.80	A-1	M	5 1/2	2 1/2	3 3/8	6 3/8	2 3/8	212.0	12 8V 1500 M	A-1	M	5 1/2	2 1/2	3 3/8	6 3/8	4 3/8	234.0
10 8V 1600 M	16.00	15.80	A-1	M	5 1/2	2 1/2	3 3/8	6 3/8	2 3/8	219.0	12 8V 1600 M	A-1	M	5 1/2	2 1/2	3 3/8	6 3/8	4 3/8	285.0
10 8V 1700 M	17.00	16.80	A-2	M	5 1/2	2 1/2	3 3/8	6 3/8	2 3/8	228.0	12 8V 1700 M	A-1	M	5 1/2	2 1/2	3 3/8	6 3/8	4 3/8	324.0
10 8V 1800 M	18.00	17.80	A-2	M	5 1/2	2 1/2	3 3/8	6 3/8	2 3/8	236.0	12 8V 1800 M	A-2	M	5 1/2	2 1/2	3 3/8	6 3/8	4 3/8	330.0
10 8V 1900 M	19.00	18.80	A-2	M	5 1/2	2 1/2	3 3/8	6 3/8	2 3/8	260.0	12 8V 1900 N	A-2	N	6	1/2	2 1/2	8 3/8	5 3/8	338.0
10 8V 2000 M	20.00	19.80	A-2	M	5 1/2	2 1/2	3 3/8	6 3/8	2 3/8	280.0	12 8V 2000 N	A-2	N	6	1/2	2 1/2	8 3/8	5 3/8	365.0
10 8V 2120 M	21.20	21.00	A-2	M	5 1/2	2 1/2	3 3/8	6 3/8	2 3/8	298.0	12 8V 2120 N	A-2	N	6	1/2	2 1/2	8 3/8	5 3/8	382.0
10 8V 2240 N	22.40	22.20	A-2	N	6	1/2	2 1/2	8 3/8	3	366.0	12 8V 2240 N	A-2	N	6	1/2	2 1/2	8 3/8	5 3/8	399.0
10 8V 2480 N	24.80	24.60	A-2	N	6	1/2	2 1/2	8 3/8	3	454.0	12 8V 2480 N	A-2	N	6	1/2	2 1/2	8 3/8	5 3/8	454.0
10 8V 3000 N	30.00	29.80	A-3	N	6	1/2	2 1/2	8 3/8	3	468.0	12 8V 3000 P	A-3	P	6 3/8	3/8	2 3/8	9 3/8	3 3/8	605.0
10 8V 3550 P	35.50	35.30	A-3	P	6 3/8	3/8	2 3/8	9 3/8	1 3/8	784.0	12 8V 3550 P	A-3	P	6 3/8	3/8	2 3/8	9 3/8	3 3/8	706.0
10 8V 4000 P	40.00	39.80	A-3	P	6 3/8	3/8	2 3/8	9 3/8	1 3/8	826.0	12 8V 4000 P	A-3	P	6 3/8	3/8	2 3/8	9 3/8	3 3/8	766.0
10 8V 4450 P	44.50	44.30	A-3	P	6 3/8	3/8	2 3/8	9 3/8	1 3/8	996.0	12 8V 4450 P	A-3	P	6 3/8	3/8	2 3/8	9 3/8	3 3/8	910.0
10 8V 5300 P	53.00	52.80	A-3	P	6 3/8	3/8	2 3/8	9 3/8	1 3/8	1010.0	12 8V 5300 W	A-3	W	8 3/8	3/8	2 3/8	11 3/8	2 3/8	1333.0
10 8V 6300 W	63.00	62.80	A-3	W	8 3/8	3/8	2 3/8	11 3/8	0	1443.0	12 8V 6300 W	A-3	W	8 3/8	3/8	2 3/8	11 3/8	2 3/8	1777.0
10 8V 7100 W	71.00	70.80	A-3	W	8 3/8	3/8	2 3/8	11 3/8	0	1842.0	12 8V 7100 W	A-3	W	8 3/8	3/8	2 3/8	11 3/8	2 3/8	2002.0

★ E and M dimensions are nominal and will vary depending on shaft tolerances. Type E sheaves are drilled for reverse mounting only.

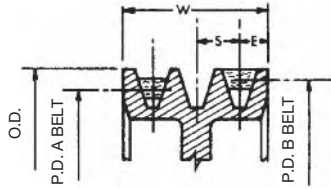

Combination Groove Dimensions

Belt Section	E	S	O.D.
"AB"	1/2	3/4	P.D. "B" + .35

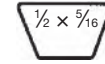

A

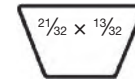

B

Drawing shows position of "A" and "B" belts in groove when used with QD sheaves.

Dimensions in inches, weight in pounds

1 Groove											2 Groove									
F = 7/8 thru 1 B 64 SDS / F = 1 others											F = 1 3/4									
Part Number	PD		OD	Type	Bush	Bush Max. Bore	E	K	L Thru Bore	M	Wt. Less Bush	Part Number	Type	Bush	Bush Max. Bore	E	K	L Thru Bore	M	Wt. Less Bush
	A Belts	B Belts																		
1 B 34 SH	3.0	3.4	3.75	D-1	SH	1 1/16	5/16	0	1 1/16	1/2	1.2	2 B 34 SH	E-1	SH	1 1/16	1	0	1 1/16	5/16	1.0
1 B 36 SH	3.2	3.6	3.95	D-1	SH	1 1/16	5/16	0	1 1/16	1/2	1.3	2 B 36 SH	E-1	SH	1 1/16	5/16	3/16	1 1/16	1 1/16	1.4
1 B 38 SH	3.4	3.8	4.15	D-1	SH	1 1/16	5/16	0	1 1/16	1/2	1.6	2 B 38 SH	E-1	SH	1 1/16	5/16	3/16	1 1/16	1 1/16	1.8
1 B 40 SH	3.6	4.0	4.35	C-1	SH	1 1/16	1/4	5/16	1 1/16	3/16	1.8	2 B 40 SH	A-1	SH	1 1/16	1/2	1 1/16	1 1/16	5/16	2.0
1 B 42 SH	3.8	4.2	4.55	C-1	SH	1 1/16	1/4	5/16	1 1/16	3/16	2.0	2 B 42 SH	A-1	SH	1 1/16	1/2	1 1/16	1 1/16	5/16	2.5
1 B 44 SH	4.0	4.4	4.75	C-1	SH	1 1/16	1/4	5/16	1 1/16	3/16	2.2	2 B 44 SH	A-1	SH	1 1/16	1/2	1 1/16	1 1/16	5/16	2.8
1 B 46 SDS	4.2	4.6	4.95	C-1	SDS	2	5/16	5/16	1 1/16	3/16	2.4	2 B 46 SDS	A-2	SDS	2	1/16	1 1/16	1 1/16	5/16	4.8
1 B 48 SDS	4.4	4.8	5.15	C-1	SDS	2	5/16	5/16	1 1/16	3/16	2.6	2 B 48 SDS	A-2	SDS	2	1/16	1 1/16	1 1/16	5/16	5.0
1 B 50 SDS	4.6	5.0	5.35	C-1	SDS	2	5/16	5/16	1 1/16	3/16	3.0	2 B 50 SDS	A-2	SDS	2	1/16	1 1/16	1 1/16	5/16	5.4
1 B 52 SDS	4.8	5.2	5.55	C-1	SDS	2	5/16	5/16	1 1/16	3/16	3.4	2 B 52 SDS	A-2	SDS	2	1/16	1 1/16	1 1/16	5/16	5.6
1 B 54 SDS	5.0	5.4	5.75	C-1	SDS	2	5/16	5/16	1 1/16	3/16	3.8	2 B 54 SDS	A-2	SDS	2	1/16	1 1/16	1 1/16	5/16	5.8
1 B 56 SDS	5.2	5.6	5.95	C-1	SDS	2	5/16	5/16	1 1/16	3/16	4.0	2 B 56 SDS	A-2	SDS	2	1/16	1 1/16	1 1/16	5/16	6.0
1 B 58 SDS	5.4	5.8	6.15	C-1	SDS	2	5/16	5/16	1 1/16	3/16	4.4	2 B 58 SDS	A-2	SDS	2	1/16	1 1/16	1 1/16	5/16	7.0
1 B 60 SDS	5.6	6.0	6.35	C-1	SDS	2	5/16	5/16	1 1/16	3/16	4.6	2 B 60 SDS	A-2	SDS	2	1/16	1 1/16	1 1/16	5/16	7.5
1 B 62 SDS	5.8	6.2	6.55	C-2	SDS	2	5/16	5/16	1 1/16	3/16	4.8	2 B 62 SDS	A-2	SDS	2	1/16	1 1/16	1 1/16	5/16	7.8
1 B 64 SDS	6.0	6.4	6.75	C-2	SDS	2	5/16	5/16	1 1/16	3/16	5.0	2 B 64 SDS	A-2	SDS	2	1/16	1 1/16	1 1/16	5/16	8.0
1 B 66 SDS	6.2	6.6	6.95	C-2	SDS	2	5/16	5/16	1 1/16	3/16	5.4	2 B 66 SDS	A-2	SDS	2	1/16	1 1/16	1 1/16	5/16	9.0
1 B 68 SDS	6.4	6.8	7.15	C-2	SDS	2	5/16	5/16	1 1/16	3/16	5.6	2 B 68 SDS	A-2	SDS	2	1/16	1 1/16	1 1/16	5/16	9.5
1 B 70 SDS	6.6	7.0	7.35	C-2	SDS	2	1/2	1/2	1 1/16	1/2	6.0	2 B 70 SK	D-2	SK	2 3/4	1/4	7/16	1 1/16	1/16	9.8
1 B 74 SDS	7.0	7.4	7.75	C-2	SDS	2	1/2	1/2	1 1/16	1/2	6.3	2 B 74 SK	D-2	SK	2 3/4	1/4	7/16	1 1/16	1/16	11.0
1 B 80 SDS	7.6	8.0	8.35	C-3	SDS	2	1/2	1/2	1 1/16	1/2	6.6	2 B 80 SK	D-2	SK	2 3/4	1/4	7/16	1 1/16	1/16	12.0
1 B 86 SDS	8.2	8.6	8.95	C-3	SDS	2	1/2	1/2	1 1/16	1/2	7.0	2 B 86 SK	D-3	SK	2 3/4	1/4	7/16	1 1/16	1/16	13.0
1 B 94 SDS	9.0	9.4	9.75	C-3	SDS	2	1/2	1/2	1 1/16	1/2	8.0	2 B 94 SK	D-3	SK	2 3/4	1/4	7/16	1 1/16	1/16	14.0
1 B 110 SDS	10.6	11.0	11.35	C-3	SDS	2	1/2	1/2	1 1/16	1/2	10.0	2 B 110 SK	D-3	SK	2 3/4	1/4	7/16	1 1/16	1/16	15.0
1 B 124 SDS	12.0	12.4	12.75	C-3	SDS	2	1/2	1/2	1 1/16	1/2	12.0	2 B 124 SK	D-3	SK	2 3/4	1/4	7/16	1 1/16	1/16	17.0
1 B 136 SDS	13.2	13.6	13.95	C-3	SDS	2	1/2	1/2	1 1/16	1/2	14.0	2 B 136 SK	D-3	SK	2 3/4	1/4	7/16	1 1/16	1/16	19.0
1 B 154 SK	15.0	15.4	15.75	C-3	SK	2 3/4	5/16	1/2	1 1/16	3/4	17.0	2 B 154 SK	D-3	SK	2 3/4	1/4	7/16	1 1/16	1/16	22.0
1 B 160 SK	15.6	16.0	16.35	C-3	SK	2 3/4	5/16	1/2	1 1/16	3/4	18.0	2 B 160 SK	D-3	SK	2 3/4	1/4	7/16	1 1/16	1/16	25.0
1 B 184 SK	18.0	18.4	18.75	C-3	SK	2 3/4	5/16	1/2	1 1/16	3/4	20.0	2 B 184 SK	D-3	SK	2 3/4	1/4	7/16	1 1/16	1/16	30.0
1 B 200 SK	19.6	20.0	20.35	C-3	SK	2 3/4	5/16	1/2	1 1/16	3/4	23.0	2 B 200 SF	D-3	SF	2 1/16	3/16	3/8	2 1/16	0	39.0
	24.6	25.0	25.35									2 B 250 SF	D-3	SF	2 1/16	5/16	3/8	2 1/16	0	61.0
	29.6	30.0	30.35									2 B 300 SF	D-3	SF	2 1/16	5/16	3/8	2 1/16	0	64.0
	37.6	38.0	38.35									2 B 380 SF	D-3	SF	2 1/16	5/16	3/8	2 1/16	0	86.0

★ Weights do not include bushings. See page B-7 for additional bushing dimensions.

A-B Combination Groove Conventional Stock QD Sheaves

Martin

V-BELT DRIVES

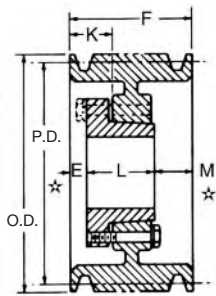

TYPE A

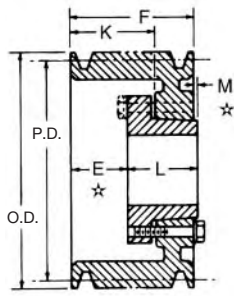

TYPE B

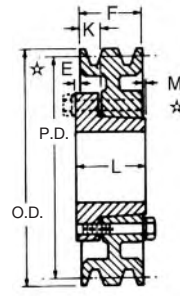

TYPE C

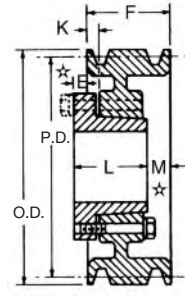

TYPE D

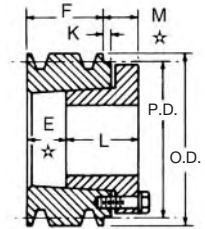

TYPE E

Dimensions in inches, weight in pounds

3 Groove F = 2 1/2												4 Groove F = 3 1/4								
Part Number	PD		OD	Type	Bush	Bush Max. Bore	E	K	L Thru Bore	M	Wt. Less Bush	Part Number	Type	Bush	Bush Max. Bore	E	K	L Thru Bore	M	Wt. Less Bush
	A Belts	B Belts																		
3 B 34 SH	3.0	3.4	3.75	E-1	SH	1 1/16	1 3/4	0	1 1/16	3/16	3.4	4 B 34 SD	E-1	SD	2	2 3/8	5/16	1 3/16	1 5/16	4.0
3 B 36 SH	3.2	3.6	3.95	D-1	SH	1 1/16	3/8	3/16	1 1/16	1 1/16	3.8	4 B 36 SD	E-1	SD	2	2 3/8	5/16	1 1/16	1 1/16	5.0
3 B 38 SH	3.4	3.8	4.15	D-1	SH	1 1/16	3/8	3/16	1 1/16	1 1/16	4.0	4 B 38 SD	E-1	SD	2	2 3/8	5/16	1 1/16	1 1/16	5.5
3 B 40 SH	3.6	4.0	4.35	A-1	SH	1 1/16	1/2	1 1/16	1 1/16	1 1/16	4.5	4 B 40 SD	E-1	SD	2	2 3/8	0	1 3/16	5/8	6.0
3 B 42 SH	3.8	4.2	4.55	A-1	SH	1 1/16	1/2	1 1/16	1 1/16	1 1/16	5.0	4 B 42 SD	E-1	SD	2	2 3/8	0	1 3/16	5/8	7.0
3 B 44 SH	4.0	4.4	4.75	A-1	SH	1 1/16	1/2	1 1/16	1 1/16	1 1/16	5.5	4 B 44 SD	E-1	SD	2	2 3/8	0	1 3/16	5/8	7.3
3 B 46 SD	4.2	4.6	4.95	A-1	SD	2	3/16	1 1/16	1 1/16	1/4	6.0	4 B 46 SD	A-1	SD	2	1 1/16	1 1/16	1 1/16	3/4	7.6
3 B 48 SD	4.4	4.8	5.15	A-1	SD	2	3/16	1 1/16	1 1/16	1/4	6.5	4 B 48 SD	A-1	SD	2	1 1/16	1 1/16	1 1/16	3/4	8.0
3 B 50 SD	4.6	5.0	5.35	A-1	SD	2	3/16	1 1/16	1 1/16	1/4	7.0	4 B 50 SD	A-1	SD	2	1 1/16	1 1/16	1 1/16	3/4	9.0
3 B 52 SD	4.8	5.2	5.55	A-1	SD	2	3/16	1 1/16	1 1/16	1/4	8.0	4 B 52 SD	A-1	SD	2	1 1/16	1 1/16	1 1/16	3/4	10.0
3 B 54 SD	5.0	5.4	5.75	A-1	SD	2	3/16	1 1/16	1 1/16	1/4	8.5	4 B 54 SD	A-1	SD	2	1 1/16	1 1/16	1 1/16	3/4	10.5
3 B 56 SD	5.2	5.6	5.95	A-1	SD	2	3/16	1 1/16	1 1/16	1/4	9.0	4 B 56 SD	A-1	SD	2	1 1/16	1 1/16	1 1/16	3/4	11.0
3 B 58 SD	5.4	5.8	6.15	A-1	SD	2	3/16	1 1/16	1 1/16	1/4	10.0	4 B 58 SD	A-1	SD	2	1 1/16	1 1/16	1 1/16	3/4	12.0
3 B 60 SD	5.6	6.0	6.35	A-1	SD	2	3/16	1 1/16	1 1/16	1/4	11.0	4 B 60 SD	A-1	SD	2	1 1/16	1 1/16	1 1/16	3/4	12.5
3 B 62 SD	5.8	6.2	6.55	A-1	SD	2	3/16	1 1/16	1 1/16	1/4	12.0	4 B 62 SD	A-1	SD	2	1 1/16	1 1/16	1 1/16	3/4	13.0
3 B 64 SD	6.0	6.4	6.75	A-1	SD	2	3/16	1 1/16	1 1/16	1/4	12.3	4 B 64 SD	A-1	SD	2	1 1/16	1 1/16	1 1/16	3/4	14.0
3 B 66 SD	6.2	6.6	6.95	A-1	SD	2	3/16	1 1/16	1 1/16	1/4	12.6	4 B 66 SD	A-1	SD	2	1 1/16	1 1/16	1 1/16	3/4	14.5
3 B 68 SD	6.4	6.8	7.15	A-1	SD	2	3/16	1 1/16	1 1/16	1/4	13.0	4 B 68 SD	A-1	SD	2	1 1/16	1 1/16	1 1/16	3/4	15.0
3 B 70 SK	6.6	7.0	7.35	A-1	SK	2 3/8	0	1 1/16	1 1/16	3/16	14.0	4 B 70 SK	A-1	SK	2 3/8	5/16	1	1 1/16	1	15.5
3 B 74 SK	7.0	7.4	7.75	A-1	SK	2 3/8	0	1 1/16	1 1/16	3/16	15.0	4 B 74 SK	A-1	SK	2 3/8	5/16	1	1 1/16	1	16.0
3 B 80 SK	7.6	8.0	8.35	A-1	SK	2 3/8	0	1 1/16	1 1/16	3/16	16.0	4 B 80 SK	A-1	SK	2 3/8	5/16	1	1 1/16	1	17.0
3 B 86 SK	8.2	8.6	8.95	A-3	SK	2 3/8	0	1 1/16	1 1/16	3/16	17.0	4 B 86 SK	A-3	SK	2 3/8	5/16	1	1 1/16	1	18.0
3 B 94 SK	9.0	9.4	9.75	A-3	SK	2 3/8	0	1 1/16	1 1/16	3/16	18.0	4 B 94 SK	A-3	SK	2 3/8	5/16	1	1 1/16	1	19.0
3 B 110 SK	10.6	11.0	11.35	A-3	SK	2 3/8	0	1 1/16	1 1/16	3/16	19.0	4 B 110 SK	A-3	SK	2 3/8	5/16	1	1 1/16	1	24.0
3 B 124 SK	12.0	12.4	12.75	A-3	SK	2 3/8	0	1 1/16	1 1/16	3/16	23.0	4 B 124 SK	A-3	SK	2 3/8	5/16	1	1 1/16	1	26.0
3 B 136 SK	13.2	13.6	13.95	A-3	SK	2 3/8	0	1 1/16	1 1/16	3/16	24.1	4 B 136 SK	A-3	SK	2 3/8	5/16	1	1 1/16	1	28.0
3 B 154 SK	15.0	15.4	15.75	A-3	SK	2 3/8	0	1 1/16	1 1/16	3/16	28.0	4 B 154 SF	A-3	SF	2 13/16	5/16	1	2 1/16	7/8	41.0
3 B 160 SK	15.6	16.0	16.35	A-3	SK	2 3/8	0	1 1/16	1 1/16	3/16	29.0	4 B 160 SF	A-3	SF	2 13/16	5/16	1	2 1/16	7/8	42.0
3 B 184 SK	18.0	18.4	18.75	A-3	SK	2 3/8	0	1 1/16	1 1/16	3/16	37.0	4 B 184 SF	A-3	SF	2 13/16	5/16	1	2 1/16	7/8	48.0
3 B 200 SF	19.6	20.0	20.35	D-3	SF	2 13/16	1/16	3/8	2 1/16	1/2	39.0	4 B 200 SF	A-3	SF	2 13/16	5/16	1	2 1/16	7/8	58.0
3 B 250 SF	24.6	25.0	25.35	D-3	SF	2 13/16	1/16	3/8	2 1/16	1/2	67.0	4 B 250 E	A-3	E	3 1/2	1/8	1	2 3/8	1/2	78.0
3 B 300 SF	29.6	30.0	30.35	D-3	SF	2 13/16	1/16	3/8	2 1/16	1/2	74.0	4 B 300 E	A-3	E	3 1/2	1/8	1	2 3/8	1/2	93.0
3 B 380 E	37.6	38.0	38.35	D-3	E	3 1/2	1/16	3/8	2 1/16	1/2	122.0	4 B 380 E	A-3	E	3 1/2	1/8	1	2 3/8	1/2	138.0

* E and M dimensions are nominal and will vary depending on shaft tolerances. Type E sheaves are drilled for reverse mounting only.

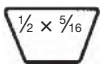

A

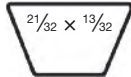

B

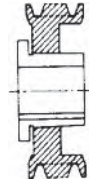

1 = SOLID

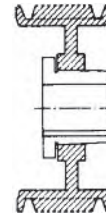

2 = WEB

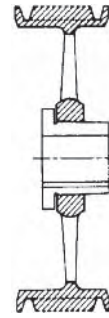

3 = ARM/SPOKE

Dimensions in inches, weight in pounds

5 Groove F = 4											6 Groove F = 4 3/4									
Part Number	PD		OD	Type	Bush	Bush Max. Bore	E	K	L Thru Bore	M	Wt. Less Bush	Part Number	Type	Bush	Bush Max. Bore	E	K	L Thru Bore	M	Wt. Less Bush
	A Belts	B Belts																		
5 B 34 SD	3.0	3.4	3.75	E-1	SD	2	3/4	7/16	1 1/16	1 1/16	5.0	6 B 34 SD	E-1	SD	2	3/8	5/16	1 1/16	1 1/16	6.0
5 B 36 SD	3.2	3.6	3.95	E-1	SD	2	3/4	7/16	1 1/16	1 1/16	6.0	6 B 36 SD	E-1	SD	2	3/8	5/16	1 1/16	1 1/16	7.0
5 B 38 SD	3.4	3.8	4.15	E-1	SD	2	3/4	5/16	1 1/16	1 1/16	6.5	6 B 38 SD	E-1	SD	2	3/8	5/16	1 1/16	1 1/16	7.5
5 B 40 SD	3.6	4.0	4.35	E-1	SD	2	2 1/16	0	1 1/16	1/2	7.0	6 B 40 SD	E-1	SD	2	3/8	0	1 1/16	1/2	8.0
5 B 42 SD	3.8	4.2	4.55	E-1	SD	2	2 1/16	0	1 1/16	1/2	7.5	6 B 42 SD	E-1	SD	2	3/8	0	1 1/16	1/2	9.0
5 B 44 SD	4.0	4.4	4.75	E-1	SD	2	2 1/16	0	1 1/16	1/2	8.0	6 B 44 SD	E-1	SD	2	3/8	0	1 1/16	1/2	9.5
5 B 46 SD	4.2	4.6	4.95	A-1	SD	2	1 1/16	1 1/16	1 1/16	1 1/2	9.0	6 B 46 SD	A-1	SD	2	3/8	1 1/16	1 1/16	2 1/2	10.0
5 B 48 SD	4.4	4.8	5.15	A-1	SD	2	1 1/16	1 1/16	1 1/16	1 1/2	9.5	6 B 48 SD	A-1	SD	2	2 1/4	1 1/16	1 1/16	2 1/2	10.5
5 B 50 SD	4.6	5.0	5.35	A-1	SD	2	1 1/16	1 1/16	1 1/16	1 1/2	10.0	6 B 50 SD	A-1	SD	2	2 1/4	1 1/16	1 1/16	2 1/2	11.0
5 B 52 SD	4.8	5.2	5.75	A-1	SD	2	1 1/16	1 1/16	1 1/16	1 1/2	10.5	6 B 52 SD	A-1	SD	2	2 1/4	1 1/16	1 1/16	2 1/2	11.5
5 B 54 SK	5.0	5.4	5.75	A-1	SK	2 1/2	5/8	1 1/16	1 1/16	1 1/2	11.0	6 B 54 SK	A-1	SK	2 1/2	5/8	1 1/16	1 1/16	2 1/2	12.0
5 B 56 SK	5.2	5.6	5.95	A-1	SK	2 1/2	5/8	1 1/16	1 1/16	1 1/2	11.5	6 B 56 SK	A-1	SK	2 1/2	5/8	1 1/16	1 1/16	2 1/2	13.0
5 B 58 SK	5.4	5.8	6.15	A-1	SK	2 1/2	5/8	1 1/16	1 1/16	1 1/2	12.0	6 B 58 SK	A-1	SK	2 1/2	5/8	1 1/16	1 1/16	2 1/2	14.0
5 B 60 SK	5.6	6.0	6.35	A-1	SK	2 1/2	5/8	1 1/16	1 1/16	1 1/2	13.0	6 B 60 SK	A-1	SK	2 1/2	5/8	1 1/16	1 1/16	2 1/2	15.0
5 B 62 SK	5.8	6.2	6.55	A-1	SK	2 1/2	5/8	1 1/16	1 1/16	1 1/2	14.0	6 B 62 SK	A-1	SK	2 1/2	5/8	1 1/16	1 1/16	2 1/2	16.0
5 B 64 SK	6.0	6.4	6.75	A-1	SK	2 1/2	5/8	1 1/16	1 1/16	1 1/2	15.0	6 B 64 SK	A-1	SK	2 1/2	5/8	1 1/16	1 1/16	2 1/2	17.0
5 B 66 SK	6.2	6.6	6.95	A-1	SK	2 1/2	5/8	1 1/16	1 1/16	1 1/2	16.0	6 B 66 SK	A-1	SK	2 1/2	5/8	1 1/16	1 1/16	2 1/2	18.0
5 B 68 SK	6.4	6.8	7.15	A-1	SK	2 1/2	5/8	1 1/16	1 1/16	1 1/2	17.0	6 B 68 SK	A-1	SK	2 1/2	5/8	1 1/16	1 1/16	2 1/2	19.0
5 B 70 SF	6.6	7.0	7.35	A-1	SF	2 1/2	5/8	1 1/16	2 1/16	1 1/2	18.0	6 B 70 SF	A-1	SF	2 1/2	1	1 1/16	2 1/16	1 1/2	19.5
5 B 74 SF	7.0	7.4	7.75	A-1	SF	2 1/2	5/8	1 1/16	2 1/16	1 1/2	20.0	6 B 74 SF	A-1	SF	2 1/2	1	1 1/16	2 1/16	1 1/2	22.0
5 B 80 SF	7.6	8.0	8.35	A-1	SF	2 1/2	5/8	1 1/16	2 1/16	1 1/2	23.0	6 B 80 SF	A-1	SF	2 1/2	1	1 1/16	2 1/16	1 1/2	25.0
5 B 86 SF	8.2	8.6	8.95	A-2	SF	2 1/2	5/8	1 1/16	2 1/16	1 1/2	24.0	6 B 86 SF	A-2	SF	2 1/2	1	1 1/16	2 1/16	1 1/2	28.0
5 B 94 SF	9.0	9.4	9.75	A-2	SF	2 1/2	5/8	1 1/16	2 1/16	1 1/2	26.0	6 B 94 SF	A-2	SF	2 1/2	1	1 1/16	2 1/16	1 1/2	29.0
5 B 110 SF	10.6	11.0	11.35	A-2	SF	2 1/2	5/8	1 1/16	2 1/16	1 1/2	32.0	6 B 110 SF	A-2	SF	2 1/2	1	1 1/16	2 1/16	1 1/2	30.0
5 B 124 SF	12.0	12.4	12.75	A-3	SF	2 1/2	5/8	1 1/16	2 1/16	1 1/2	35.0	6 B 124 SF	A-3	SF	2 1/2	1	1 1/16	2 1/16	1 1/2	40.0
5 B 136 SF	13.2	13.6	13.95	A-3	SF	2 1/2	5/8	1 1/16	2 1/16	1 1/2	36.0	6 B 136 SF	A-3	SF	2 1/2	1	1 1/16	2 1/16	1 1/2	45.0
5 B 154 SF	15.0	15.4	15.75	A-3	SF	2 1/2	5/8	1 1/16	2 1/16	1 1/2	46.0	6 B 154 SF	A-3	SF	2 1/2	1	1 1/16	2 1/16	1 1/2	46.0
5 B 160 SF	15.6	16.0	16.35	A-3	SF	2 1/2	5/8	1 1/16	2 1/16	1 1/2	48.0	6 B 160 SF	A-3	SF	2 1/2	1	1 1/16	2 1/16	1 1/2	50.0
5 B 184 SF	18.0	18.4	18.75	A-3	SF	2 1/2	5/8	1 1/16	2 1/16	1 1/2	50.0	6 B 184 SF	A-3	SF	2 1/2	1	1 1/16	2 1/16	1 1/2	60.0
5 B 200 E	19.6	20.0	20.35	A-3	E	3 1/2	3/4	1 1/4	2 1/2	1	72.0	6 B 200 E	A-3	E	3 1/2	1/2	1 1/2	2 1/2	1 1/2	78.0
5 B 250 E	24.6	25.0	25.35	A-3	E	3 1/2	3/4	1 1/4	2 1/2	1	90.0	6 B 250 E	A-3	E	3 1/2	1/2	1 1/2	2 1/2	1 1/2	98.0
5 B 300 E	29.6	30.0	30.35	A-3	E	3 1/2	3/4	1 1/4	2 1/2	1	108.0	6 B 300 E	A-3	E	3 1/2	1/2	1 1/2	2 1/2	1 1/2	109.0
5 B 380 E	37.6	38.0	38.35	A-3	E	3 1/2	3/4	1 1/4	2 1/2	1	145.0	6 B 380 E	A-3	E	3 1/2	1/2	1 1/2	2 1/2	1 1/2	173.0

Weights do not include bushings. See page B-7 for additional bushing dimensions.

A-B Combination Groove Conventional Stock QD Sheaves

Martin

V-BELT DRIVES

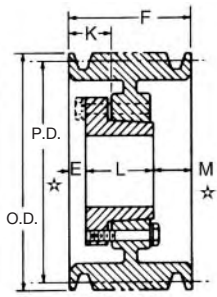

TYPE A

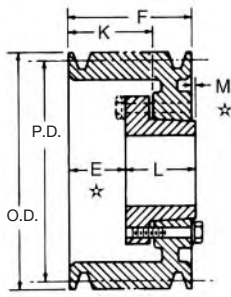

TYPE B

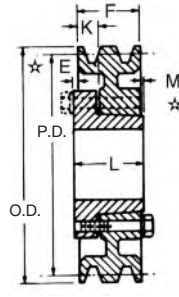

TYPE C

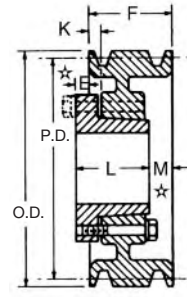

TYPE D

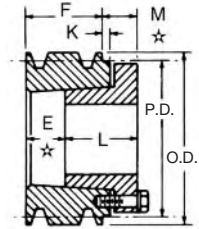

TYPE E

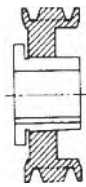

1 = SOLID

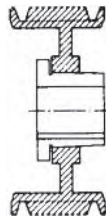

2 = WEB

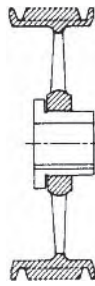

3 = ARM/SPOKE

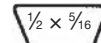

A

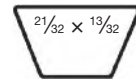

B

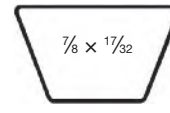

C

Dimensions in inches, weight in pounds

8 Groove F = 6 1/4											10 Groove F = 7 1/4									
Part Number	PD		OD	Type	Bush	Bush Max. Bore	E	K	L Thru Bore	M	Wt. Less Bush	Part Number	Type	Bush	Bush Max. Bore	E	K	L Thru Bore	M	Wt. Less Bush
	A Belts	B Belts																		
8 B 54 SK	5.0	5.4	5.75	A-1	SK	2 1/8	1 1/8	1 1/8	1 1/8	3 1/8	14.0	10 B 54 SK	A-1	SK	2 1/8	1 1/8	2 1/8	1 1/8	3 1/8	15.0
8 B 56 SK	5.2	5.6	5.95	A-1	SK	2 1/8	1 1/8	1 1/8	1 1/8	3 1/8	16.0	10 B 56 SK	A-1	SK	2 1/8	1 1/8	2 1/8	1 1/8	3 1/8	18.0
8 B 58 SK	5.4	5.8	6.15	A-1	SK	2 1/8	1 1/8	1 1/8	1 1/8	3 1/8	16.5	10 B 58 SK	A-1	SK	2 1/8	1 1/8	2 1/8	1 1/8	3 1/8	20.0
8 B 60 SF	5.6	6.0	6.35	A-1	SF	2 1/8	1 1/8	1 1/8	2 1/8	3 1/8	17.0	10 B 60 SF	A-1	SF	2 1/8	1 1/8	2 1/8	2 1/8	3 1/8	22.0
8 B 62 SF	5.8	6.2	6.55	A-1	SF	2 1/8	1 1/8	1 1/8	2 1/8	3 1/8	18.0	10 B 62 SF	A-1	SF	2 1/8	1 1/8	2 1/8	2 1/8	3 1/8	24.0
8 B 64 SF	6.0	6.4	6.75	A-1	SF	2 1/8	1 1/8	1 1/8	2 1/8	3 1/8	18.5	10 B 64 SF	A-1	SF	2 1/8	1 1/8	2 1/8	2 1/8	3 1/8	25.0
8 B 66 SF	6.2	6.6	6.95	A-1	SF	2 1/8	1 1/8	1 1/8	2 1/8	3 1/8	21.0	10 B 66 SF	A-1	SF	2 1/8	1 1/8	2 1/8	2 1/8	3 1/8	26.0
8 B 68 SF	6.4	6.8	7.15	A-1	SF	2 1/8	1 1/8	1 1/8	2 1/8	3 1/8	22.0	10 B 68 SF	A-1	SF	2 1/8	1 1/8	2 1/8	2 1/8	3 1/8	27.0
8 B 70 SF	6.6	7.0	7.35	A-1	SF	2 1/8	1 1/8	1 1/8	2 1/8	3 1/8	22.5	10 B 70 SF	A-1	SF	2 1/8	1 1/8	2 1/8	2 1/8	3 1/8	28.0
8 B 74 SF	7.0	7.4	7.75	A-1	SF	2 1/8	1 1/8	1 1/8	2 1/8	3 1/8	25.0	10 B 74 SF	A-1	SF	2 1/8	1 1/8	2 1/8	2 1/8	3 1/8	31.0
8 B 80 SF	7.6	8.0	8.35	A-1	SF	2 1/8	1 1/8	1 1/8	2 1/8	3 1/8	29.0	10 B 80 SF	A-1	SF	2 1/8	1 1/8	2 1/8	2 1/8	3 1/8	35.0
8 B 86 E	8.2	8.6	8.95	A-1	E	3 1/8	1 1/2	2 1/8	2 1/8	2 1/8	34.0	10 B 86 E	A-1	E	3 1/8	2 1/8	3 1/8	2 1/8	2 1/8	38.0
8 B 94 E	9.0	9.4	9.75	A-1	E	3 1/8	1 1/2	2 1/8	2 1/8	2 1/8	40.0	10 B 94 E	A-1	E	3 1/8	2 1/8	3 1/8	2 1/8	2 1/8	45.0
8 B 110 E	10.6	11.0	11.35	A-2	E	3 1/8	1 1/2	2 1/8	2 1/8	2 1/8	47.0	10 B 110 E	A-2	E	3 1/8	2 1/8	3 1/8	2 1/8	2 1/8	53.0
8 B 124 E	12.0	12.4	12.75	A-3	E	3 1/8	1 1/2	2 1/8	2 1/8	2 1/8	52.0	10 B 124 E	A-3	E	3 1/8	2 1/8	3 1/8	2 1/8	2 1/8	63.0
8 B 136 E	13.2	13.6	13.95	A-3	E	3 1/8	1 1/2	2 1/8	2 1/8	2 1/8	60.0	10 B 136 F	A-3	F	3 1/8	1 1/8	2 1/8	3 1/8	3 1/8	78.0
8 B 154 E	15.0	15.4	15.75	A-3	E	3 1/8	1 1/2	2 1/8	2 1/8	2 1/8	82.0	10 B 154 F	A-3	F	3 1/8	1 1/8	2 1/8	3 1/8	3 1/8	90.0
8 B 160 E	15.6	16.0	16.35	A-3	E	3 1/8	1 1/2	2 1/8	2 1/8	2 1/8	90.0	10 B 160 F	A-3	F	3 1/8	1 1/8	2 1/8	3 1/8	3 1/8	96.0
8 B 184 F	18.0	18.4	18.75	A-3	F	3 1/8	5/8	1 1/8	3 1/8	2 1/8	110.0	10 B 184 F	A-3	F	3 1/8	1 1/8	2 1/8	3 1/8	3 1/8	113.0
8 B 200 F	19.6	20.0	20.35	A-3	F	3 1/8	5/8	1 1/8	3 1/8	2 1/8	122.0	10 B 200 F	A-3	F	3 1/8	1 1/8	2 1/8	3 1/8	3 1/8	114.0
8 B 250 F	24.6	25.0	25.35	A-3	F	3 1/8	5/8	1 1/8	3 1/8	2 1/8	138.0	10 B 250 F	A-3	F	3 1/8	1 1/8	2 1/8	3 1/8	3 1/8	138.0
8 B 300 F	29.6	30.0	30.35	A-3	F	3 1/8	5/8	1 1/8	3 1/8	2 1/8	168.0	10 B 300 F	A-3	F	3 1/8	1 1/8	2 1/8	3 1/8	3 1/8	200.0
8 B 380 F	37.6	38.0	38.35	A-3	F	3 1/8	5/8	1 1/8	3 1/8	2 1/8	222.0	10 B 380 J	A-3	J	4 1/8	3/8	1 1/8	4 1/8	2 1/8	279.0

E and M dimensions are nominal and will vary depending on shaft tolerances. Type E sheaves are drilled for reverse mounting only.



Conventional Stock QD Sheaves C

Dimensions in inches, weight in pounds

1 Groove											2 Groove								
F = 1 3/8											F = 2 1/2								
Part Number	PD	OD	Type	Bush	Bush Max. Bore	E	K	L Thru Bore	M	Wt. Less Bush	Part Number	Type	Bush	Bush Max. Bore	E	K	L Thru Bore	M	Wt. Less Bush
	C Belt																		
1 C 60 SK	6.00	6.40	C-1	SK	2 5/16	5/16	1/2	1 1/16	0	9.4	2 C 60 SF	A-1	SF	2 5/16	3/8	7/8	2 1/16	1/2	8.0
1 C 70 SF	7.00	7.40	C-1	SF	2 5/16	5/16	1/2	2 1/16	1/8	9.8	2 C 70 SF	A-1	SF	2 5/16	1/2	1 3/16	2 1/16	3/8	12.0
1 C 75 SF	7.50	7.90	C-1	SF	2 5/16	5/16	1/2	2 1/16	1/8	11.0	2 C 75 SF	A-1	SF	2 5/16	1/2	1 3/16	2 1/16	3/8	15.0
1 C 80 SF	8.00	8.40	C-1	SF	2 5/16	5/16	1/2	2 1/16	1/8	13.0	2 C 80 SF	A-1	SF	2 5/16	1/2	1 3/16	2 1/16	3/8	16.0
1 C 85 SF	8.50	8.90	C-1	SF	2 5/16	5/16	1/2	2 1/16	1/8	13.3	2 C 85 SF	A-2	SF	2 5/16	1/2	1 3/16	2 1/16	3/8	19.0
1 C 90 SF	9.00	9.40	C-3	SF	2 5/16	5/16	1/2	2 1/16	1/8	13.5	2 C 90 SF	A-2	SF	2 5/16	1/2	1 3/16	2 1/16	3/8	19.5
1 C 95 SF	9.50	9.90	C-3	SF	2 5/16	5/16	1/2	2 1/16	1/8	13.8	2 C 95 SF	A-2	SF	2 5/16	1/2	1 3/16	2 1/16	3/8	21.0
1 C 100 SF	10.00	10.40	C-3	SF	2 5/16	5/16	1/2	2 1/16	1/8	14.0	2 C 100 SF	A-2	SF	2 5/16	1/2	1 3/16	2 1/16	3/8	22.0
1 C 105 SF	10.50	10.90	C-3	SF	2 5/16	5/16	1/2	2 1/16	1/8	15.0	2 C 105 SF	A-2	SF	2 5/16	1/2	1 3/16	2 1/16	3/8	25.0
1 C 110 SF	11.00	11.40	C-3	SF	2 5/16	5/16	1/2	2 1/16	1/8	15.8	2 C 110 SF	A-3	SF	2 5/16	1/2	1 3/16	2 1/16	3/8	26.0
1 C 120 SF	12.00	12.40	C-3	SF	2 5/16	5/16	1/2	2 1/16	1/8	17.0	2 C 120 SF	D-3	SF	2 5/16	1/2	1 3/16	2 1/16	3/8	29.0
1 C 130 SF	13.00	13.40	C-3	SF	2 5/16	5/16	1/2	2 1/16	1/8	18.0	2 C 130 SF	D-3	SF	2 5/16	1/2	1 3/16	2 1/16	3/8	31.0
1 C 140 SF	14.00	14.40	C-3	SF	2 5/16	5/16	1/2	2 1/16	1/8	20.0	2 C 140 SF	D-3	SF	2 5/16	1/2	1 3/16	2 1/16	3/8	35.0
1 C 150 SF	15.00	15.40	C-3	SF	2 5/16	5/16	1/2	2 1/16	1/8	21.0	2 C 150 SF	D-3	SF	2 5/16	1/2	1 3/16	2 1/16	3/8	39.0
1 C 160 SF	16.00	16.40	C-3	SF	2 5/16	5/16	1/2	2 1/16	1/8	24.0	2 C 160 SF	D-3	SF	2 5/16	1/2	1 3/16	2 1/16	3/8	43.0
1 C 180 SF	18.00	18.40	C-3	SF	2 5/16	5/16	1/2	2 1/16	1/8	27.0	2 C 180 SF	D-3	SF	2 5/16	1/2	1 3/16	2 1/16	3/8	48.0
1 C 200 SF	20.00	20.40	C-3	SF	2 5/16	5/16	1/2	2 1/16	1/8	31.0	2 C 200 SF	D-3	SF	2 5/16	1/2	1 3/16	2 1/16	3/8	55.0
1 C 240 SF	24.00	24.40	C-3	SF	2 5/16	5/16	1/2	2 1/16	1/8	37.0	2 C 240 SF	D-3	SF	2 5/16	1/2	1 3/16	2 1/16	3/8	65.0
	27.00	27.40									2 C 270 F	C-3	F	3 1/16	1 1/16	3/8	3%	107.0	
	30.00	30.40									2 C 300 F	C-3	F	3 1/16	1 1/16	3/8	3%	115.0	

V-BELT DRIVES

Dimensions in inches, weight in pounds

3 Groove											4 Groove								
F = 3 3/8											F = 4 3/8								
Part Number	PD	OD	Type	Bush	Bush Max. Bore	E	K	L Thru Bore	M	Wt. Less Bush	Part Number	Type	Bush	Bush Max. Bore	E	K	L Thru Bore	M	Wt. Less Bush
	C Belt																		
3 C 50 SD	5.00	5.40	A-1	SD	2	5/8	1 1/4	1 1/16	1 5/16	8.0	4 C 50 SD	A-1	SD	2	5/8	1 1/4	1 1/16	1 5/16	10.0
3 C 54 SD	5.40	5.80	A-1	SD	2	1 1/16	1 1/8	1 1/16	7/8	9.0	4 C 54 SD	A-1	SD	2	1 1/16	1 1/8	1 1/16	1 1/8	12.0
3 C 55 SD	5.50	5.90	A-1	SD	2	1 1/16	1 1/8	1 1/16	7/8	10.0	4 C 55 SD	A-1	SD	2	1 1/16	1 1/8	1 1/16	1 1/8	12.4
3 C 56 SD	5.60	6.00	A-1	SD	2	1 1/16	1 1/8	1 1/16	7/8	11.0	4 C 56 SD	A-1	SD	2	1 1/16	1 1/8	1 1/16	1 1/8	12.4
3 C 60 SF	6.00	6.40	A-1	SF	2 5/16	3/8	1 1/2	2 1/16	1 1/8	12.0	4 C 60 SF	A-1	SF	2 5/16	3/8	1 1/2	2 1/16	2 1/8	12.6
3 C 70 SF	7.00	7.40	A-1	SF	2 5/16	5/8	1 5/8	2 1/16	1 1/8	14.0	4 C 70 SF	A-2	SF	2 5/16	3/8	1 5/8	2 1/16	1 1/8	13.0
3 C 75 SF	7.50	7.90	A-1	SF	2 5/16	5/8	1 5/8	2 1/16	1 1/8	17.0	4 C 75 SF	A-2	SF	2 5/16	3/8	1 5/8	2 1/16	1 1/8	19.0
3 C 80 E	8.00	8.40	B-1	E	3 1/2	7/8	1 3/4	2 3/8	1 1/2	19.0	4 C 80 E	A-2	E	3 1/2	1 1/2	2	2 3/8	1 1/2	24.0
3 C 85 E	8.50	8.90	B-1	E	3 1/2	7/8	1 3/4	2 3/8	1 1/2	22.0	4 C 85 E	A-1	E	3 1/2	1 1/2	2	2 3/8	1 1/2	27.0
3 C 90 E	9.00	9.40	B-1	E	3 1/2	7/8	1 3/4	2 3/8	1 1/2	26.0	4 C 90 E	A-1	E	3 1/2	1 1/2	2	2 3/8	1 1/2	30.0
3 C 95 E	9.50	9.90	B-1	E	3 1/2	7/8	1 3/4	2 3/8	1 1/2	29.0	4 C 95 E	A-1	E	3 1/2	1 1/2	2	2 3/8	1 1/2	33.0
3 C 100 E	10.00	10.40	B-1	E	3 1/2	7/8	1 3/4	2 3/8	1 1/2	27.0	4 C 100 E	A-1	E	3 1/2	1 1/2	2	2 3/8	1 1/2	35.0
3 C 105 E	10.50	10.90	B-2	E	3 1/2	7/8	1 3/4	2 3/8	1 1/2	31.0	4 C 105 E	A-2	E	3 1/2	1 1/2	2	2 3/8	1 1/2	40.0
3 C 110 E	11.00	11.40	B-2	E	3 1/2	7/8	1 3/4	2 3/8	1 1/2	38.0	4 C 110 E	A-1	E	3 1/2	1 1/2	2	2 3/8	1 1/2	45.0
3 C 120 E	12.00	12.40	B-3	E	3 1/2	7/8	1 3/4	2 3/8	1 1/2	40.0	4 C 120 E	A-1	E	3 1/2	1 1/2	2	2 3/8	1 1/2	48.0
3 C 130 E	13.00	13.40	B-3	E	3 1/2	7/8	1 3/4	2 3/8	1 1/2	43.0	4 C 130 E	A-3	E	3 1/2	1 1/2	2	2 3/8	1 1/2	49.0
3 C 140 E	14.00	14.40	B-3	E	3 1/2	7/8	1 3/4	2 3/8	1 1/2	46.0	4 C 140 E	A-3	E	3 1/2	1 1/2	2	2 3/8	1 1/2	56.0
3 C 150 E	15.00	15.40	B-3	E	3 1/2	7/8	1 3/4	2 3/8	1 1/2	52.0	4 C 150 E	A-3	E	3 1/2	1 1/2	2	2 3/8	1 1/2	62.0
3 C 160 E	16.00	16.40	B-3	E	3 1/2	7/8	1 3/4	2 3/8	1 1/2	58.0	4 C 160 E	A-3	E	3 1/2	1 1/2	2	2 3/8	1 1/2	68.0
3 C 180 E	18.00	18.40	B-3	E	3 1/2	7/8	1 3/4	2 3/8	1 1/2	67.0	4 C 180 E	A-3	E	3 1/2	1 1/2	2	2 3/8	1 1/2	74.0
3 C 200 E	20.00	20.40	A-3	E	3 1/2	1	1	2 3/8	1 1/2	70.0	4 C 200 E	A-3	E	3 1/2	1	1 1/2	2 3/8	1 1/2	81.0
3 C 240 E	24.00	24.40	A-3	E	3 1/2	1	1	2 3/8	1 1/2	90.0	4 C 240 F	A-3	F	3 1/16	5/8	1 1/8	3%	7/8	120.0
3 C 270 F	27.00	27.40	C-3	F	3 3/16	5/8	1 3/8	3 3/8	1 3/8	124.0	4 C 270 F	A-3	F	3 3/16	5/8	1 1/8	3%	7/8	138.0
3 C 300 F	30.00	30.40	C-3	F	3 3/16	5/8	1 3/8	3 3/8	1 3/8	130.0	4 C 300 F	A-3	F	3 3/16	5/8	1 1/8	3%	7/8	166.0
3 C 360 F	36.00	36.40	C-3	F	3 3/16	5/8	1 3/8	3 3/8	1 3/8	166.0	4 C 360 F	A-3	F	3 3/16	5/8	1 1/8	3%	7/8	176.0
3 C 440 F	44.00	44.40	C-3	F	3 3/16	5/8	1 3/8	3 3/8	1 3/8	208.0	4 C 440 J	B-3	J	4 1/2	3/8	1 1/8	4 1/2	1/2	254.0
3 C 500 F	50.00	50.40	C-3	F	3 3/16	5/8	1 3/8	3 3/8	1 3/8	250.0	4 C 500 J	B-3	J	4 1/2	3/8	1 1/8	4 1/2	1/2	318.0

Weights do not include bushings. See page B-7 for additional bushing dimensions.

C Conventional Stock QD Sheaves

Martin

V-BELT DRIVES

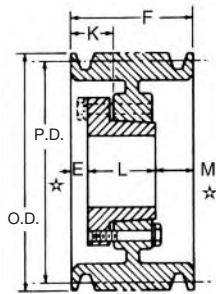

TYPE A

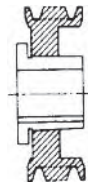

1 = SOLID

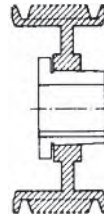

2 = WEB

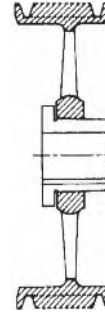

3 = ARM/SPOKE

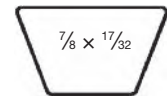

C

Dimensions in inches, weight in pounds

5 Groove F = 5 3/8											6 Groove F = 6 3/8								
Part Number	PD		Type	Bush	Bush Max. Bore	E	K	L Thru Bore	M	Wt. Less Bush	Part Number	Type	Bush	Bush Max. Bore	E	K	L Thru Bore	M	Wt. Less Bush
	C Belt	OD																	
5 C 60 SF	6.00	6.40	A-1	SF	2 5/16	3/8	7/8	2 1/8	3 3/8	14.0	6 C 60 SF	A-1	SF	2 5/16	3/8	7/8	2 1/8	4 1/8	16.0
5 C 70 SF	7.00	7.40	A-1	SF	2 5/16	1 1/4	1 15/16	2 1/8	2 1/8	19.0	6 C 70 SF	A-1	SF	2 5/16	1 1/4	1 15/16	2 1/8	3 3/8	22.0
5 C 75 SF	7.50	7.90	A-1	SF	2 5/16	1 1/4	1 15/16	2 1/8	2 1/8	22.0	6 C 75 SF	A-1	SF	2 5/16	1 1/4	1 15/16	2 1/8	3 3/8	25.0
5 C 80 E	8.00	8.40	A-1	E	3 1/2	1 1/2	2 3/8	2 3/8	1 1/4	28.0	6 C 80 E	A-1	E	3 1/2	1 1/2	2 3/8	2 3/8	2 1/4	31.0
5 C 85 E	8.50	8.90	A-1	E	3 1/2	1 1/2	2 3/8	2 3/8	1 1/4	31.0	6 C 85 E	A-1	E	3 1/2	1 1/2	2 3/8	2 3/8	2 1/4	35.0
5 C 90 E	9.00	9.40	A-1	E	3 1/2	1 1/2	2 3/8	2 3/8	1 1/4	32.0	6 C 90 F	A-1	F	3 15/16	1 1/8	2 1/8	3 3/8	1 1/8	40.0
5 C 95 E	9.50	9.90	A-1	E	3 1/2	1 1/2	2 3/8	2 3/8	1 1/4	36.0	6 C 95 F	A-1	F	3 15/16	1 1/8	2 1/8	3 3/8	1 1/8	44.0
5 C 100 E	10.00	10.40	A-2	E	3 1/2	1 1/2	2 3/8	2 3/8	1 1/4	38.0	6 C 100 F	A-1	F	3 15/16	1 1/8	2 1/8	3 3/8	1 1/8	50.0
5 C 105 E	10.50	10.90	A-2	E	3 1/2	1 1/2	2 3/8	2 3/8	1 1/4	43.0	6 C 105 F	A-1	F	3 15/16	1 1/8	2 1/8	3 3/8	1 1/8	56.0
5 C 110 E	11.00	11.40	A-1	E	3 1/2	1 1/2	2 3/8	2 3/8	1 1/4	50.0	6 C 110 F	A-1	F	3 15/16	1 1/8	2 1/8	3 3/8	1 1/8	60.0
5 C 120 E	12.00	12.40	A-1	E	3 1/2	1 1/2	2 3/8	2 3/8	1 1/4	55.0	6 C 120 F	A-1	F	3 15/16	1 1/8	2 1/8	3 3/8	1 1/8	65.0
5 C 130 E	13.00	13.40	A-3	E	3 1/2	1 1/2	2 3/8	2 3/8	1 1/4	58.0	6 C 130 F	A-3	F	3 15/16	1 1/8	2 1/8	3 3/8	1 1/8	67.0
5 C 140 E	14.00	14.40	A-3	E	3 1/2	1 1/2	2 3/8	2 3/8	1 1/4	61.0	6 C 140 F	A-3	F	3 15/16	1 1/8	2 1/8	3 3/8	1 1/8	75.0
5 C 150 E	15.00	15.40	A-3	E	3 1/2	1 1/2	2 3/8	2 3/8	1 1/4	69.0	6 C 150 F	A-3	F	3 15/16	1 1/8	2 1/8	3 3/8	1 1/8	91.0
5 C 160 E	16.00	16.40	A-3	E	3 1/2	1 1/2	2 3/8	2 3/8	1 1/4	75.0	6 C 160 F	A-3	F	3 15/16	1 1/8	2 1/8	3 3/8	1 1/8	93.0
5 C 180 E	18.00	18.40	A-3	E	3 1/2	1 1/2	2 3/8	2 3/8	1 1/4	85.0	6 C 180 F	A-3	F	3 15/16	1 1/8	2 1/8	3 3/8	1 1/8	106.0
5 C 200 F	20.00	20.40	A-3	F	3 15/16	3/8	1 1/8	3 3/8	1 1/8	108.0	6 C 200 F	A-3	F	3 15/16	15/16	1 1/8	3 3/8	1 3/8	125.0
5 C 240 F	24.00	24.40	A-3	F	3 15/16	3/8	1 1/8	3 3/8	1 1/8	124.0	6 C 240 F	A-3	F	3 15/16	15/16	1 1/8	3 3/8	1 3/8	162.0
5 C 270 F	27.00	27.40	A-3	F	3 15/16	3/8	1 1/8	3 3/8	1 1/8	154.0	6 C 270 J	A-3	J	3 15/16	3/8	1 1/8	4 1/2	1 1/2	190.0
5 C 300 F	30.00	30.40	A-3	F	3 15/16	3/8	1 1/8	3 3/8	1 1/8	174.0	6 C 300 J	A-3	J	4 1/2	3/8	1 1/8	4 1/2	1 1/2	229.0
5 C 360 J	36.00	36.40	A-3	J	4 1/2	3/8	1 1/8	4 1/2	1/2	226.0	6 C 360 J	A-3	J	4 1/2	3/8	1 1/8	4 1/2	1 1/2	270.0
5 C 440 J	44.00	44.40	A-3	J	4 1/2	3/8	1 1/8	4 1/2	1/2	289.0	6 C 440 J	A-3	J	4 1/2	3/8	1 1/8	4 1/2	1 1/2	301.0
5 C 500 J	50.00	50.40	A-3	J	4 1/2	3/8	1 1/8	4 1/2	1/2	316.0	6 C 500 M	B-3	M	5 1/2	1/2	1 1/8	6 1/2	7/8	444.0

★ E and M dimensions are nominal and will vary depending on shaft tolerances. Type E sheaves are drilled for reverse mounting only.

Dimensions in inches, weight in pounds

8 Groove F = 8%											10 Groove F = 10%								
Part Number	PD	OD	Type	Bush	Bush Max. Bore	E	K	L Thru Bore	M	Wt. Less Bush	Part Number	Type	Bush	Bush Max. Bore	E	K	L Thru Bore	M	Wt. Less Bush
	C Belt																		
8 C 70 SF	7.00	7.40	A-1	SF	2 ¹ / ₁₆	2 ⁷ / ₁₆	3	2 ¹ / ₁₆	4	35.0	10 C 80 E	A-1	E	3 ¹ / ₂	2 ³ / ₁₆	3 ¹ / ₄	2 ⁵ / ₁₆	5 ⁵ / ₁₆	42.8
8 C 80 E	8.00	8.40	A-1	E	3 ¹ / ₂	2 ⁷ / ₁₆	3 ¹ / ₄	2 ⁵ / ₁₆	3 ³ / ₁₆	36.6	10 C 85 E	A-1	E	3 ¹ / ₂	2 ³ / ₁₆	3 ¹ / ₄	2 ⁵ / ₁₆	5 ⁵ / ₁₆	48.5
8 C 85 E	8.50	8.90	A-1	E	3 ¹ / ₂	2 ⁷ / ₁₆	3 ¹ / ₄	2 ⁵ / ₁₆	3 ³ / ₁₆	41.0	10 C 90 J	A-1	J	4 ¹ / ₂	2 ³ / ₁₆	3 ³ / ₁₆	4 ¹ / ₂	3 ¹ / ₂	54.0
8 C 90 F	9.00	9.40	A-1	F	3 ³ / ₁₆	2 ⁷ / ₁₆	3 ³ / ₁₆	3 ³ / ₁₆	2 ⁷ / ₁₆	50.0	10 C 95 J	A-1	J	4 ¹ / ₂	2 ³ / ₁₆	3 ³ / ₁₆	4 ¹ / ₂	3 ¹ / ₂	60.0
8 C 95 F	9.50	9.90	A-1	F	3 ³ / ₁₆	2 ⁷ / ₁₆	3 ³ / ₁₆	3 ³ / ₁₆	2 ⁷ / ₁₆	51.0	10 C 100 J	A-1	J	4 ¹ / ₂	2 ³ / ₁₆	3 ³ / ₁₆	4 ¹ / ₂	3 ¹ / ₂	68.0
8 C 100 F	10.00	10.40	A-1	F	3 ³ / ₁₆	2 ⁷ / ₁₆	3 ³ / ₁₆	3 ³ / ₁₆	2 ⁷ / ₁₆	60.0	10 C 105 J	A-1	J	4 ¹ / ₂	2 ³ / ₁₆	3 ³ / ₁₆	4 ¹ / ₂	3 ¹ / ₂	75.0
8 C 105 F	10.50	10.90	A-1	F	3 ³ / ₁₆	2 ⁷ / ₁₆	3 ³ / ₁₆	3 ³ / ₁₆	2 ⁷ / ₁₆	67.0	10 C 110 J	A-1	J	4 ¹ / ₂	2 ³ / ₁₆	3 ³ / ₁₆	4 ¹ / ₂	3 ¹ / ₂	90.0
8 C 110 F	11.00	11.40	A-1	F	3 ³ / ₁₆	2 ⁷ / ₁₆	3 ³ / ₁₆	3 ³ / ₁₆	2 ⁷ / ₁₆	74.0	10 C 120 J	A-1	J	4 ¹ / ₂	2 ³ / ₁₆	3 ³ / ₁₆	4 ¹ / ₂	3 ¹ / ₂	106.0
8 C 120 F	12.00	12.40	A-1	F	3 ³ / ₁₆	2 ⁷ / ₁₆	3 ³ / ₁₆	3 ³ / ₁₆	2 ⁷ / ₁₆	87.0	10 C 130 J	A-2	J	4 ¹ / ₂	2 ³ / ₁₆	3 ³ / ₁₆	4 ¹ / ₂	3 ¹ / ₂	110.0
8 C 130 F	13.00	13.40	A-3	F	3 ³ / ₁₆	2 ⁷ / ₁₆	3 ³ / ₁₆	3 ³ / ₁₆	2 ⁷ / ₁₆	94.0	10 C 140 J	A-2	J	4 ¹ / ₂	2 ³ / ₁₆	3 ³ / ₁₆	4 ¹ / ₂	3 ¹ / ₂	124.0
8 C 140 F	14.00	14.40	A-3	F	3 ³ / ₁₆	2 ⁷ / ₁₆	3 ³ / ₁₆	3 ³ / ₁₆	2 ⁷ / ₁₆	99.0	10 C 150 J	A-2	J	4 ¹ / ₂	2 ³ / ₁₆	3 ³ / ₁₆	4 ¹ / ₂	3 ¹ / ₂	138.0
8 C 150 F	15.00	15.40	A-2	F	3 ³ / ₁₆	2 ⁷ / ₁₆	3 ³ / ₁₆	3 ³ / ₁₆	2 ⁷ / ₁₆	111.0	10 C 160 J	A-3	J	4 ¹ / ₂	2 ³ / ₁₆	3 ³ / ₁₆	4 ¹ / ₂	3 ¹ / ₂	139.0
8 C 160 F	16.00	16.40	A-3	F	3 ³ / ₁₆	2 ⁷ / ₁₆	3 ³ / ₁₆	3 ³ / ₁₆	2 ⁷ / ₁₆	112.0	10 C 180 J	A-3	J	4 ¹ / ₂	2 ³ / ₁₆	3 ³ / ₁₆	4 ¹ / ₂	3 ¹ / ₂	168.0
8 C 180 F	18.00	18.40	A-3	F	3 ³ / ₁₆	2 ⁷ / ₁₆	3 ³ / ₁₆	3 ³ / ₁₆	2 ⁷ / ₁₆	116.0	10 C 200 J	A-3	J	4 ¹ / ₂	2 ³ / ₁₆	3 ³ / ₁₆	4 ¹ / ₂	3 ¹ / ₂	182.0
8 C 200 J	20.00	20.40	A-3	J	4 ¹ / ₂	3 ⁸ / ₁₆	1 ¹ / ₁₆	4 ¹ / ₂	3 ¹ / ₂	146.0	10 C 240 M	A-3	M	5 ¹ / ₂	1 ¹ / ₂	1 ¹ / ₁₆	6 ¹ / ₄	3 ¹ / ₂	272.0
8 C 240 J	24.00	24.40	A-3	J	4 ¹ / ₂	3 ⁸ / ₁₆	1 ¹ / ₁₆	4 ¹ / ₂	3 ¹ / ₂	195.0	10 C 300 M	A-3	M	5 ¹ / ₂	1 ¹ / ₂	1 ¹ / ₁₆	6 ¹ / ₄	3 ¹ / ₂	355.0
8 C 270 J	27.00	27.40	A-3	J	4 ¹ / ₂	3 ⁸ / ₁₆	1 ¹ / ₁₆	4 ¹ / ₂	3 ¹ / ₂	216.0	10 C 360 M	A-3	M	5 ¹ / ₂	1 ¹ / ₂	1 ¹ / ₁₆	6 ¹ / ₄	3 ¹ / ₂	455.0
8 C 300 J	30.00	30.40	A-3	J	4 ¹ / ₂	3 ⁸ / ₁₆	1 ¹ / ₁₆	4 ¹ / ₂	3 ¹ / ₂	268.0	10 C 440 M	A-3	M	5 ¹ / ₂	1 ¹ / ₂	1 ¹ / ₁₆	6 ¹ / ₄	3 ¹ / ₂	544.0
8 C 360 M	36.00	36.40	A-3	M	5 ¹ / ₂	1 ¹ / ₂	1 ¹ / ₁₆	6 ¹ / ₄	1 ¹ / ₈	338.0	10 C 500 M	A-3	M	5 ¹ / ₂	1 ¹ / ₂	1 ¹ / ₁₆	6 ¹ / ₄	3 ¹ / ₂	622.0
8 C 440 M	44.00	44.40	A-3	M	5 ¹ / ₂	1 ¹ / ₂	1 ¹ / ₁₆	6 ¹ / ₄	1 ¹ / ₈	413.0									
8 C 500 M	50.00	50.40	A-3	M	5 ¹ / ₂	1 ¹ / ₂	1 ¹ / ₁₆	6 ¹ / ₄	1 ¹ / ₈	474.0									

V-BELT DRIVES

Dimensions in inches, weight in pounds

12 Groove F = 12%										
Part Number	PD	OD	Type	Bush	Bush Max. Bore	E	K	L Thru Bore	M	Wt. Less Bush
	C Belt									
12 C 90 J	9.00	9.40	A-1	J	4 ¹ / ₂	2 ⁷ / ₁₆	4 ¹ / ₁₆	4 ¹ / ₂	5	63.0
12 C 95 J	9.50	9.90	A-1	J	4 ¹ / ₂	2 ⁷ / ₁₆	4 ¹ / ₁₆	4 ¹ / ₂	5	75.0
12 C 100 J	10.00	10.40	A-1	J	4 ¹ / ₂	2 ⁷ / ₁₆	4 ¹ / ₁₆	4 ¹ / ₂	5	84.0
12 C 105 J	10.50	10.90	A-1	J	4 ¹ / ₂	2 ⁷ / ₁₆	4 ¹ / ₁₆	4 ¹ / ₂	5	86.0
12 C 110 J	11.00	11.40	A-1	J	4 ¹ / ₂	2 ⁷ / ₁₆	4 ¹ / ₁₆	4 ¹ / ₂	5	97.0
12 C 120 J	12.00	12.40	A-1	J	4 ¹ / ₂	2 ⁷ / ₁₆	4 ¹ / ₁₆	4 ¹ / ₂	5	119.0
12 C 130 J	13.00	13.40	A-2	J	4 ¹ / ₂	2 ⁷ / ₁₆	4 ¹ / ₁₆	4 ¹ / ₂	5	125.0
12 C 140 J	14.00	14.40	A-2	J	4 ¹ / ₂	2 ⁷ / ₁₆	4 ¹ / ₁₆	4 ¹ / ₂	5	139.0
12 C 150 J	15.00	15.40	A-2	J	4 ¹ / ₂	2 ⁷ / ₁₆	4 ¹ / ₁₆	4 ¹ / ₂	5	156.0
12 C 160 J	16.00	16.40	A-3	J	4 ¹ / ₂	2 ⁷ / ₁₆	4 ¹ / ₁₆	4 ¹ / ₂	5	175.0
12 C 180 J	18.00	18.40	A-3	J	4 ¹ / ₂	2 ⁷ / ₁₆	4 ¹ / ₁₆	4 ¹ / ₂	5	185.0
12 C 200 M	20.00	20.40	A-3	M	5 ¹ / ₂	1 ¹ / ₂	1 ¹ / ₁₆	6 ¹ / ₄	5 ¹ / ₈	228.0
12 C 240 M	24.00	24.40	A-3	M	5 ¹ / ₂	1 ¹ / ₂	1 ¹ / ₁₆	6 ¹ / ₄	5 ¹ / ₈	287.0
12 C 300 M	30.00	30.40	A-3	M	5 ¹ / ₂	1 ¹ / ₂	1 ¹ / ₁₆	6 ¹ / ₄	5 ¹ / ₈	350.0
12 C 360 M	36.00	36.40	A-3	M	5 ¹ / ₂	1 ¹ / ₂	1 ¹ / ₁₆	6 ¹ / ₄	5 ¹ / ₈	430.0
12 C 440 M	44.00	44.40	A-3	M	5 ¹ / ₂	1 ¹ / ₂	1 ¹ / ₁₆	6 ¹ / ₄	5 ¹ / ₈	565.0
12 C 500 M	50.00	50.40	A-3	M	5 ¹ / ₂	1 ¹ / ₂	1 ¹ / ₁₆	6 ¹ / ₄	5 ¹ / ₈	595.0

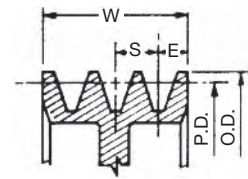

Combination Groove Dimensions

Belt Section	E	S	OD
"C"	1 ¹ / ₁₆	1	P.D. + .40

W = S(N-1) + 2E
N = No. of Grooves

Weights do not include bushings. See page B-7 for additional bushing dimensions.

D Conventional Stock QD Sheaves



V-BELT DRIVES

Dimensions in inches, weight in pounds

3 Groove											4 Groove										
F = 4 5/16											F = 6 1/16										
Part Number	PD D Belt	OD	Type	Bush	Bush Max. Bore	E	K	L Thru Bore	M	Wt. Less Bush	Part Number	Type	Bush	Bush Max. Bore	E	K	L Thru Bore	M	Wt. Less Bush		
3 D 120 F	12.0	12.6	A-2	F	3 1/16	1/2	1 1/2	3 3/8	1/2	58.0	4 D 120 F	A-2	F	3 1/16	1 1/16	2 5/16	3 3/8	1 1/8	68.0		
3 D 130 F	13.0	13.6	A-2	F	3 1/16	1/2	1 1/2	3 3/8	1/2	63.0	4 D 130 F	A-2	F	3 1/16	1 1/16	2 5/16	3 3/8	1 1/8	78.0		
3 D 135 F	13.5	14.1	A-2	F	3 1/16	1/2	1 1/2	3 3/8	1/2	68.0	4 D 135 F	A-2	F	3 1/16	1 1/16	2 5/16	3 3/8	1 1/8	82.0		
3 D 140 F	14.0	14.6	A-2	F	3 1/16	1/2	1 1/2	3 3/8	1/2	71.0	4 D 140 F	A-2	F	3 1/16	1 1/16	2 5/16	3 3/8	1 1/8	91.0		
3 D 145 F	14.5	15.1	A-2	F	3 1/16	1/2	1 1/2	3 3/8	1/2	82.0	4 D 145 F	A-2	F	3 1/16	1 1/16	2 5/16	3 3/8	1 1/8	93.0		
3 D 150 F	15.0	15.6	A-2	F	3 1/16	1/2	1 1/2	3 3/8	1/2	86.0	4 D 150 F	A-2	F	3 1/16	1 1/16	2 5/16	3 3/8	1 1/8	99.0		
3 D 155 F	15.5	16.1	A-2	F	3 1/16	1/2	1 1/2	3 3/8	1/2	93.0	4 D 155 F	A-2	F	3 1/16	1 1/16	2 5/16	3 3/8	1 1/8	111.0		
3 D 160 F	16.0	16.6	A-2	F	3 1/16	1/2	1 1/2	3 3/8	1/2	95.0	4 D 160 F	A-2	F	3 1/16	1 1/16	2 5/16	3 3/8	1 1/8	122.0		
3 D 180 J	18.0	18.6	A-3	J	4 1/2	0	1 3/8	4 1/2	1/8	105.0	4 D 170 J	A-2	J	4 1/2	1 1/8	2 5/16	4 1/2	3/16	136.0		
3 D 200 J	20.0	20.6	A-2	J	4 1/2	0	1 3/8	4 1/2	1/8	148.0	4 D 180 J	A-3	J	4 1/2	1 3/8	2 5/16	4 1/2	3/16	141.0		
3 D 220 J	22.0	22.6	A-3	J	4 1/2	0	1 3/8	4 1/2	1/8	164.0	4 D 200 J	A-2	J	4 1/2	3/8	1 5/16	4 1/2	1 3/16	167.0		
3 D 270 J	27.0	27.6	A-3	J	4 1/2	0	1 3/8	4 1/2	1/8	180.0	4 D 220 J	A-3	J	4 1/2	3/8	1 5/16	4 1/2	1 3/16	183.0		
3 D 330 J	33.0	33.6	A-3	J	4 1/2	0	1 3/8	4 1/2	1/8	195.0	4 D 270 J	A-3	J	4 1/2	3/8	1 5/16	4 1/2	1 3/16	222.0		
3 D 400 J	40.0	40.6	A-3	J	4 1/2	0	1 3/8	4 1/2	1/8	260.0	4 D 330 M	B-3	M	5 1/2	1/2	1 5/16	6 3/4	1 1/8	315.0		
											4 D 400 M	B-3	M	5 1/2	1/2	1 5/16	6 3/4	1 1/8	337.0		

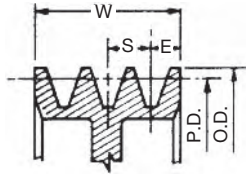

Groove Dimensions

Belt Section	E	S	O.D.
"D"	1/8	1 1/16	P.D. + .60

W = S(N-1) + 2E
N = No. of Grooves

Dimensions in inches, weight in pounds

5 Groove											
F = 7 1/2											
Part Number	PD D Belt	OD	Belt	Type	Bush	Bush Max. Bore	E	K	L Thru Bore	M	Wt. Less Bush
5 D 120 F	12.0	12.6	A-2	F	3 1/16	2 1/16	3 3/8	3 3/8	1 13/16	87.0	
5 D 130 F	13.0	13.6	A-2	F	3 1/16	2 1/16	3 3/8	3 3/8	1 13/16	88.0	
5 D 135 F	13.5	14.1	A-2	F	3 1/16	2 1/16	3 3/8	3 3/8	1 13/16	92.0	
5 D 140 F	14.0	14.6	A-2	F	3 1/16	2 1/16	3 3/8	3 3/8	1 13/16	96.0	
5 D 145 F	14.5	15.1	A-2	F	3 1/16	2 1/16	3 3/8	3 3/8	1 13/16	111.0	
5 D 150 F	15.0	15.6	A-2	F	3 1/16	2 1/16	3 3/8	3 3/8	1 13/16	115.0	
5 D 155 F	15.5	16.1	A-2	F	3 1/16	2 1/16	3 3/8	3 3/8	1 13/16	121.0	
5 D 160 F	16.0	16.6	A-2	F	3 1/16	2 1/16	3 3/8	3 3/8	1 13/16	128.0	
5 D 170 J	17.0	17.6	A-2	J	4 1/2	3/8	1 3/8	4 1/2	2 3/8	135.0	
5 D 180 J	18.0	18.6	A-3	J	4 1/2	3/8	1 3/8	4 1/2	2 3/8	148.0	
5 D 200 J	20.0	20.6	A-3	J	4 1/2	3/8	1 3/8	4 1/2	2 3/8	184.0	
5 D 220 J	22.0	22.6	A-3	J	4 1/2	3/8	1 3/8	4 1/2	2 3/8	202.0	
5 D 270 M	27.0	27.6	A-3	M	5 1/2	1/2	1 5/16	6 3/4	1/4	250.0	
5 D 330 M	33.0	33.6	A-3	M	5 1/2	1/2	1 5/16	6 3/4	1/4	280.0	
5 D 400 M	40.0	40.6	A-3	M	5 1/2	1/2	1 5/16	6 3/4	1/4	380.0	

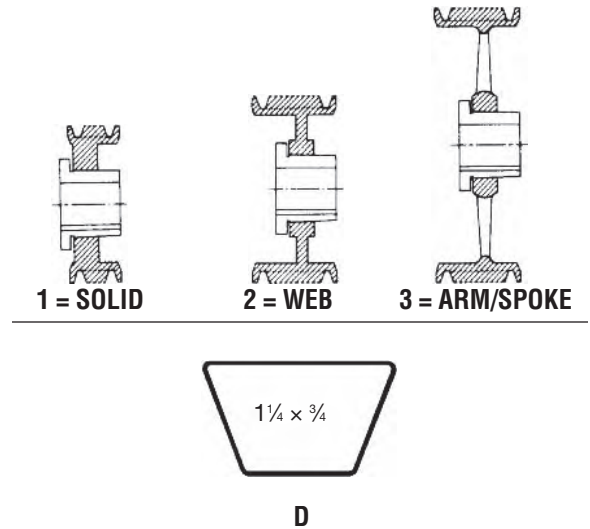

Weights do not include bushings. See page B-7 for additional bushing dimensions.

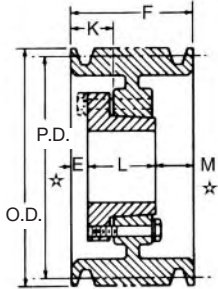

TYPE A

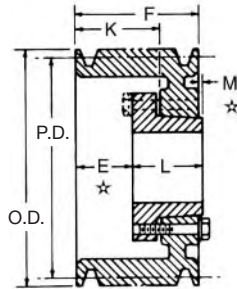

TYPE B

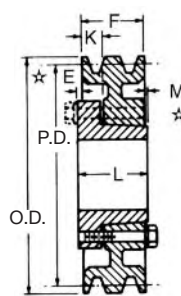

TYPE C

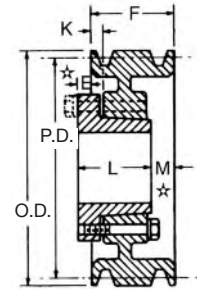

TYPE D

6 Groove F = 8 ¹⁵ / ₁₆											8 Groove F = 11 ¹³ / ₁₆								
Part Number	PD D Belt	OD	Type	Bush	Bush Max. Bore	E	K	L Thru Bore	M	Wt. Less Bush	Part Number	Type	Bush	Bush Max. Bore	E	K	L Thru Bore	M	Wt. Less Bush
6 D 120 J	12.00	12.60	A-1	J	4 ¹ / ₂	2 ¹ / ₈	3 ³ / ₁₆	4 ¹ / ₂	2 ³ / ₁₆	104.0	8 D 120 J	A-1	J	4 ¹ / ₂	2 ¹ / ₈	3 ⁹ / ₁₆	4 ¹ / ₂	4 ¹⁵ / ₁₆	126.0
6 D 130 J	13.00	13.60	A-1	J	4 ¹ / ₂	2 ¹ / ₈	3 ³ / ₁₆	4 ¹ / ₂	2 ³ / ₁₆	122.0	8 D 130 J	A-1	J	4 ¹ / ₂	2 ¹ / ₈	3 ³ / ₁₆	4 ¹ / ₂	4 ¹⁵ / ₁₆	147.0
6 D 135 J	13.50	14.10	A-1	J	4 ¹ / ₂	2 ¹ / ₈	3 ³ / ₁₆	4 ¹ / ₂	2 ³ / ₁₆	125.0	8 D 135 J	A-1	J	4 ¹ / ₂	2 ¹ / ₈	3 ³ / ₁₆	4 ¹ / ₂	4 ¹⁵ / ₁₆	150.0
6 D 140 J	14.00	14.60	A-2	J	4 ¹ / ₂	2 ¹ / ₈	3 ³ / ₁₆	4 ¹ / ₂	2 ³ / ₁₆	128.0	8 D 140 J	A-1	J	4 ¹ / ₂	2 ¹ / ₈	3 ³ / ₁₆	4 ¹ / ₂	4 ¹⁵ / ₁₆	155.0
6 D 145 J	14.50	15.10	A-2	J	4 ¹ / ₂	2 ¹ / ₈	3 ³ / ₁₆	4 ¹ / ₂	2 ³ / ₁₆	130.0	8 D 145 J	A-1	J	4 ¹ / ₂	2 ¹ / ₈	3 ³ / ₁₆	4 ¹ / ₂	4 ¹⁵ / ₁₆	160.0
6 D 150 J	15.00	15.60	A-2	J	4 ¹ / ₂	2 ¹ / ₈	3 ³ / ₁₆	4 ¹ / ₂	2 ³ / ₁₆	136.0	8 D 150 J	A-2	J	4 ¹ / ₂	2 ¹ / ₈	3 ⁹ / ₁₆	4 ¹ / ₂	4 ¹⁵ / ₁₆	176.0
6 D 155 J	15.50	16.10	A-2	J	4 ¹ / ₂	2 ¹ / ₈	3 ³ / ₁₆	4 ¹ / ₂	2 ³ / ₁₆	139.0	8 D 155 J	A-2	J	4 ¹ / ₂	2 ¹ / ₈	3 ³ / ₁₆	4 ¹ / ₂	4 ¹⁵ / ₁₆	180.0
6 D 160 J	16.00	16.60	A-2	J	4 ¹ / ₂	2 ¹ / ₈	3 ³ / ₁₆	4 ¹ / ₂	2 ³ / ₁₆	141.0	8 D 160 J	A-2	J	4 ¹ / ₂	2 ¹ / ₈	3 ³ / ₁₆	4 ¹ / ₂	4 ¹⁵ / ₁₆	200.0
6 D 170 J	17.00	17.60	A-2	J	4 ¹ / ₂	2 ¹ / ₈	3 ³ / ₁₆	4 ¹ / ₂	2 ³ / ₁₆	154.0	8 D 170 M	A-1	M	5 ¹ / ₂	2 ¹ / ₈	3 ³ / ₁₆	6 ¹ / ₂	2 ³ / ₁₆	225.0
6 D 180 J	18.00	18.60	A-2	J	4 ¹ / ₂	2 ¹ / ₈	3 ³ / ₁₆	4 ¹ / ₂	2 ³ / ₁₆	172.0	8 D 180 M	A-2	M	5 ¹ / ₂	2 ¹ / ₈	3 ³ / ₁₆	6 ¹ / ₂	2 ³ / ₁₆	250.0
6 D 200 J	20.00	20.60	A-2	J	4 ¹ / ₂	2 ¹ / ₈	3 ³ / ₁₆	4 ¹ / ₂	2 ³ / ₁₆	183.0	8 D 200 M	A-2	M	5 ¹ / ₂	2 ¹ / ₈	3 ³ / ₁₆	6 ¹ / ₂	2 ³ / ₁₆	270.0
6 D 220 M	22.00	22.60	A-2	M	5 ¹ / ₂	1 ¹ / ₂	1 ¹⁵ / ₁₆	6 ¹ / ₂	1 ¹ / ₁₆	272.0	8 D 220 M	A-2	M	5 ¹ / ₂	1 ¹ / ₂	1 ¹⁵ / ₁₆	6 ¹ / ₂	4 ³ / ₁₆	316.0
6 D 270 M	27.00	27.60	A-3	M	5 ¹ / ₂	1 ¹ / ₂	1 ¹⁵ / ₁₆	6 ¹ / ₂	1 ¹ / ₁₆	280.0	8 D 270 N	A-3	M	5 ¹ / ₂	1 ¹ / ₂	1 ¹⁵ / ₁₆	6 ¹ / ₂	4 ³ / ₁₆	440.0
6 D 330 M	33.00	33.60	A-3	M	5 ¹ / ₂	1 ¹ / ₂	1 ¹⁵ / ₁₆	6 ¹ / ₂	1 ¹ / ₁₆	356.0	8 D 330 N	A-3	M	5 ¹ / ₂	1 ¹ / ₂	1 ¹⁵ / ₁₆	6 ¹ / ₂	4 ³ / ₁₆	458.0
6 D 400 M	40.00	40.60	A-3	M	5 ¹ / ₂	1 ¹ / ₂	1 ¹⁵ / ₁₆	6 ¹ / ₂	1 ¹ / ₁₆	415.0	8 D 400 N	A-3	N	5 ¹ / ₂	1 ¹ / ₂	2 ¹ / ₄	8 ¹ / ₂	3 ³ / ₁₆	638.0
6 D 440 M	44.00	44.60	A-3	M	5 ¹ / ₂	1 ¹ / ₂	1 ¹⁵ / ₁₆	6 ¹ / ₂	1 ¹ / ₁₆	536.0	8 D 440 N	A-3	N	6	1 ¹ / ₂	2 ¹ / ₄	8 ¹ / ₂	3 ³ / ₁₆	616.0
6 D 480 M	48.00	48.60	A-3	M	5 ¹ / ₂	1 ¹ / ₂	1 ¹⁵ / ₁₆	6 ¹ / ₂	1 ¹ / ₁₆	572.0	8 D 480 N	A-3	N	6	1 ¹ / ₂	2 ¹ / ₄	8 ¹ / ₂	3 ³ / ₁₆	755.0
6 D 580 N	58.00	58.60	A-3	N	6	1 ¹ / ₂	2 ¹ / ₄	8 ¹ / ₂	1 ¹ / ₁₆	1006.0	8 D 580 N	A-3	N	6	1 ¹ / ₂	2 ¹ / ₄	8 ¹ / ₂	3 ³ / ₁₆	1112.0

10 Groove F = 14 ¹¹ / ₁₆											12 Groove F = 17 ¹ / ₁₆									
Part Number	PD D Belt	OD	Type	Bush	Bush Max. Bore	E	K	L Thru Bore	M	Wt. Less Bush	Part Number	Type	Bush	Bush Max. Bore	E	K	L Thru Bore	M	Wt. Less Bush	
10 D 120 M	12.00	12.60	A-1	M	5 ¹ / ₂	2 ¹ / ₈	3 ¹⁵ / ₁₆	6 ¹ / ₂	5 ⁷ / ₁₆	158.0	12 D 120 M	A-1	M	5 ¹ / ₂	3 ¹ / ₂	4 ³ / ₁₆	6 ¹ / ₂	7 ⁷ / ₁₆	158.0	
10 D 125 M	12.50	13.10	A-1	M	5 ¹ / ₂	2 ¹ / ₈	3 ¹⁵ / ₁₆	6 ¹ / ₂	5 ⁷ / ₁₆	178.0	12 D 130 M	A-1	M	5 ¹ / ₂	3 ¹ / ₂	4 ³ / ₁₆	6 ¹ / ₂	7 ⁷ / ₁₆	219.0	
10 D 130 M	13.00	13.60	A-1	M	5 ¹ / ₂	2 ¹ / ₈	3 ¹⁵ / ₁₆	6 ¹ / ₂	5 ⁷ / ₁₆	196.0	12 D 135 M	A-1	M	5 ¹ / ₂	3 ¹ / ₂	4 ³ / ₁₆	6 ¹ / ₂	7 ⁷ / ₁₆	242.0	
10 D 135 M	13.50	14.10	A-1	M	5 ¹ / ₂	2 ¹ / ₈	3 ¹⁵ / ₁₆	6 ¹ / ₂	5 ⁷ / ₁₆	207.0	12 D 140 M	A-1	M	5 ¹ / ₂	3 ¹ / ₂	4 ³ / ₁₆	6 ¹ / ₂	7 ⁷ / ₁₆	246.0	
10 D 140 M	14.00	14.60	A-1	M	5 ¹ / ₂	2 ¹ / ₈	3 ¹⁵ / ₁₆	6 ¹ / ₂	5 ⁷ / ₁₆	225.0	12 D 145 M	A-1	M	5 ¹ / ₂	3 ¹ / ₂	4 ³ / ₁₆	6 ¹ / ₂	7 ⁷ / ₁₆	266.0	
10 D 145 M	14.50	15.10	A-1	M	5 ¹ / ₂	2 ¹ / ₈	3 ¹⁵ / ₁₆	6 ¹ / ₂	5 ⁷ / ₁₆	238.0	12 D 150 M	A-1	M	5 ¹ / ₂	3 ¹ / ₂	4 ³ / ₁₆	6 ¹ / ₂	7 ⁷ / ₁₆	287.0	
10 D 150 M	15.00	15.60	A-1	M	5 ¹ / ₂	2 ¹ / ₈	3 ¹⁵ / ₁₆	6 ¹ / ₂	5 ⁷ / ₁₆	260.0	12 D 155 M	A-1	M	5 ¹ / ₂	3 ¹ / ₂	4 ³ / ₁₆	6 ¹ / ₂	7 ⁷ / ₁₆	308.0	
10 D 155 M	15.50	16.10	A-1	M	5 ¹ / ₂	2 ¹ / ₈	3 ¹⁵ / ₁₆	6 ¹ / ₂	5 ⁷ / ₁₆	279.0	12 D 160 M	A-1	M	5 ¹ / ₂	3 ¹ / ₂	4 ³ / ₁₆	6 ¹ / ₂	7 ⁷ / ₁₆	325.0	
10 D 160 M	16.00	16.60	A-1	M	5 ¹ / ₂	2 ¹ / ₈	3 ¹⁵ / ₁₆	6 ¹ / ₂	5 ⁷ / ₁₆	292.0	12 D 170 M	A-1	M	5 ¹ / ₂	3 ¹ / ₂	4 ³ / ₁₆	6 ¹ / ₂	7 ⁷ / ₁₆	330.0	
10 D 170 M	17.00	17.60	A-1	M	5 ¹ / ₂	2 ¹ / ₈	3 ¹⁵ / ₁₆	6 ¹ / ₂	5 ⁷ / ₁₆	330.0	12 D 180 M	A-1	M	5 ¹ / ₂	3 ¹ / ₂	4 ³ / ₁₆	6 ¹ / ₂	7 ⁷ / ₁₆	340.0	
10 D 180 M	18.00	18.60	A-1	M	5 ¹ / ₂	2 ¹ / ₈	3 ¹⁵ / ₁₆	6 ¹ / ₂	5 ⁷ / ₁₆	340.0	12 D 200 M	A-2	M	5 ¹ / ₂	3 ¹ / ₂	4 ³ / ₁₆	6 ¹ / ₂	7 ⁷ / ₁₆	355.0	
10 D 200 M	20.00	20.60	A-2	M	5 ¹ / ₂	2 ¹ / ₈	3 ¹⁵ / ₁₆	6 ¹ / ₂	5 ⁷ / ₁₆	355.0	12 D 220 M	A-2	M	5 ¹ / ₂	2 ¹ / ₈	3 ³ / ₁₆	6 ¹ / ₂	8 ³ / ₁₆	392.0	
10 D 220 M	22.00	22.60	A-3	M	5 ¹ / ₂	1 ¹ / ₂	2 ¹⁵ / ₁₆	6 ¹ / ₂	6 ¹ / ₁₆	348.0	12 D 270 N	A-3	N	6	2 ¹ / ₈	4 ¹ / ₁₆	6 ¹ / ₂	6 ¹⁵ / ₁₆	505.0	
10 D 270 M	27.00	27.60	A-3	M	5 ¹ / ₂	1 ¹ / ₂	2 ¹⁵ / ₁₆	6 ¹ / ₂	6 ¹ / ₁₆	434.0	12 D 330 N	A-3	N	6	2 ¹ / ₈	4 ¹ / ₁₆	6 ¹ / ₂	6 ¹⁵ / ₁₆	619.0	
10 D 330 N	33.00	33.60	A-3	N	6	1 ¹ / ₂	3 ¹ / ₄	8 ¹ / ₂	5 ¹ / ₁₆	502.0	12 D 400 P	A-3	P	6 ¹ / ₂	1 ¹ / ₂	2 ¹ / ₄	8 ¹ / ₂	7 ⁷ / ₁₆	946.0	
10 D 400 N	40.00	40.60	A-3	N	6	1 ¹ / ₂	3 ¹ / ₄	8 ¹ / ₂	5 ¹ / ₁₆	727.0	12 D 480 P	A-3	P	6 ¹ / ₂	1 ¹ / ₂	2 ¹ / ₄	8 ¹ / ₂	7 ⁷ / ₁₆	1155.0	
10 D 480 P	48.00	48.60	A-3	P	6 ¹ / ₂	1 ¹ / ₂	2 ¹ / ₄	9 ¹ / ₂	4 ¹ / ₁₆	755.0	12 D 580 P	A-3	P	6 ¹ / ₂	1 ¹ / ₂	2 ¹ / ₄	8 ¹ / ₂	7 ¹³ / ₁₆	1576.0	
10 D 580 P	58.00	58.60	A-3	P	6 ¹ / ₂	1 ¹ / ₂	2 ¹ / ₄	9 ¹ / ₂	4 ¹ / ₁₆	1286.0										

* E and M dimensions are nominal and will vary depending on shaft tolerances. See page B-7 for additional bushing dimensions.

3V Hi-Cap Wedge Stock Tapered Bushed Sheaves



V-BELT DRIVES

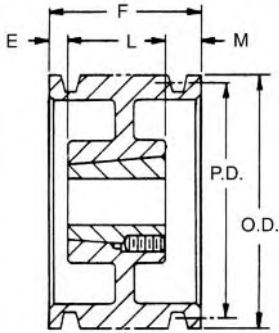

TYPE A

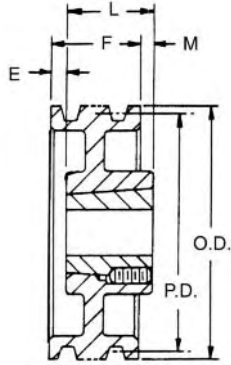

TYPE B

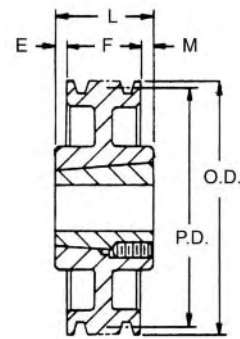

TYPE C

Dimensions in inches, weight in pounds

1 Groove										2 Groove							
F = 1 1/16"										F = 1 3/32"							
Part Number	Diameters		Type	Bush	Bush Max. Bore	E	L Thru Bore	M	Wt. Less Bush	Part Number	Type	Bush	Bush Max. Bore	E	L Thru Bore	M	Wt. Less Bush
	OD	Pitch 3V															
1 3V 265 TB	2.65	2.60	A-1	1108	1 1/8	7/32	7/8	0	.75	2 3V 265 TB	A-1	1108	1 1/8	7/32	7/8	0	.75
1 3V 280 TB	2.80	2.75	A-1	1108	1 1/8	7/32	7/8	0	.85	2 3V 280 TB	A-1	1108	1 1/8	7/32	7/8	0	.90
1 3V 300 TB	3.00	2.95	A-1	1108	1 1/8	7/32	7/8	0	1.00	2 3V 300 TB	A-1	1210	1 1/4	1/2	1	0	1.40
1 3V 315 TB	3.15	3.10	A-1	1108	1 1/8	7/32	7/8	0	1.25	2 3V 315 TB	A-1	1210	1 1/4	1/2	1	0	1.60
1 3V 335 TB	3.35	3.30	A-1	1610	1 1/8	0	1	0	1.50	2 3V 335 TB	A-1	1610	1 1/8	1/2	1	0	1.70
1 3V 365 TB	3.65	3.60	A-1	1610	1 1/8	0	1	0	2.00	2 3V 365 TB	A-1	1610	1 1/8	1/2	1 1/2	0	2.00
1 3V 412 TB	4.12	4.07	B-1	1610	1 1/8	0	1	1 3/32	2.25	2 3V 412 TB	A-1	1610	1 1/8	0	1	0	2.10
1 3V 450 TB	4.50	4.45	B-1	1610	1 1/8	0	1	1 3/32	3.00	2 3V 450 TB	A-1	1610	1 1/8	0	1	0	2.70
1 3V 475 TB	4.75	4.70	B-1	1610	1 1/8	0	1	1 3/32	3.25	2 3V 475 TB	A-1	1610	1 1/8	0	1	0	3.00
1 3V 500 TB	5.00	4.95	B-1	1610	1 1/8	0	1	1 3/32	3.50	2 3V 500 TB	A-1	1610	1 1/8	0	1	0	4.00
1 3V 530 TB	5.30	5.25	B-1	1610	1 1/8	0	1	1 3/32	3.75	2 3V 530 TB	A-1	1610	1 1/8	0	1	0	5.00
1 3V 560 TB	5.60	5.55	B-1	1610	1 1/8	0	1	1 3/32	4.00	2 3V 560 TB	A-1	1610	1 1/8	0	1	0	6.00
1 3V 600 TB	6.00	5.95	B-1	1610	1 1/8	0	1	1 3/32	5.00	2 3V 600 TB	A-1	1610	1 1/8	0	1	0	7.00
1 3V 650 TB	6.50	6.45	B-1	1610	1 1/8	0	1	1 3/32	6.00	2 3V 650 TB	A-1	1610	1 1/8	0	1	0	8.00
1 3V 690 TB	6.90	6.85	B-1	1610	1 1/8	0	1	1 3/32	7.00	2 3V 690 TB	A-1	1610	1 1/8	0	1	0	9.00
1 3V 800 TB	8.00	7.95	B-2	2517	2 1/2	0	1 3/4	1 1/16	9.00	2 3V 800 TB	B-2	2517	2 1/2	0	1 3/4	2 1/2	10.0
1 3V 1060 TB	10.60	10.55	B-2	2517	2 1/2	0	1 3/4	1 1/16	13.00	2 3V 1060 TB	B-2	2517	2 1/2	0	1 3/4	2 1/2	14.0
1 3V 1400 TB*	14.00	13.95	B-3	2517	2 1/2	0	1 3/4	1 5/16	15.00	2 3V 1400 TB	B-3	2517	2 1/2	0	1 3/4	2 1/2	18.0
1 3V 1900 TB*	19.00	18.95	B-3	3020	3	0	2	1 1/16	27.00	2 3V 1900 TB	B-3	3020	3	0	2	2 1/2	32.0
	25.00	24.95								2 3V 2500 TB	C-3	3020	3	1/8	2	2 1/2	45.0

* F = 1 1/16" thru 1 3V 1400 TB
 F = 1 3/16" thru 1 3V 1400 TB and 1 3V 1900 TB

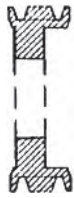

1 = SOLID

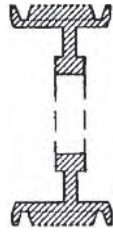

2 = WEB

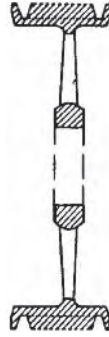

3 = ARM/SPOKE



3V

Dimensions in inches, weight in pounds

3 Groove										4 Groove							
F = 1½										F = 1 ²⁹ / ₃₂							
Part Number	Diameter		Type	Bush	Bush Max. Bore	E	L Thru Bore	M	Wt. Less Bush	Part Number	Type	Bush	Bush Max. Bore	E	L Thru Bore	M	Wt. Less Bush
	OD	Pitch 3V															
3 3V 265 TB	2.65	2.60	A-1	1108	1 ¹ / ₈	⁵ / ₈	⁷ / ₈	0	1.0	4 3V 265 TB	A-1	1108	1 ¹ / ₈	1 ¹ / ₃₂	⁷ / ₈	0	1.2
3 3V 280 TB	2.80	2.75	A-1	1108	1 ¹ / ₈	⁵ / ₈	⁷ / ₈	0	1.1	4 3V 280 TB	A-1	1108	1 ¹ / ₈	1 ¹ / ₃₂	⁷ / ₈	0	1.3
3 3V 300 TB	3.00	2.95	A-1	1210	1 ¹ / ₄	²⁹ / ₃₂	1	0	1.8	4 3V 300 TB	A-1	1210	1 ¹ / ₄	1 ¹ / ₁₆	1	0	2.1
3 3V 315 TB	3.15	3.10	A-1	1210	1 ¹ / ₄	²⁹ / ₃₂	1	0	2.0	4 3V 315 TB	A-1	1210	1 ¹ / ₄	1 ¹ / ₁₆	1	0	2.2
3 3V 335 TB	3.35	3.30	A-1	1610	1 ⁵ / ₈	²⁹ / ₃₂	1	0	2.3	4 3V 335 TB	A-1	1610	1 ⁵ / ₈	1 ¹ / ₁₆	1	0	2.4
3 3V 365 TB	3.65	3.60	A-1	1610	1 ⁵ / ₈	²⁹ / ₃₂	1	0	2.6	4 3V 365 TB	A-1	1610	1 ⁵ / ₈	²⁹ / ₃₂	1	0	2.8
3 3V 412 TB	4.12	4.07	A-1	1610	1 ⁵ / ₈	¹ / ₂	1	0	3.0	4 3V 412 TB	A-1	1610	1 ⁵ / ₈	²⁹ / ₃₂	1	0	3.0
3 3V 450 TB	4.50	4.45	A-1	1610	1 ⁵ / ₈	¹ / ₂	1	0	3.2	4 3V 450 TB	A-1	1610	1 ⁵ / ₈	²⁹ / ₃₂	1	0	4.0
3 3V 475 TB	4.75	4.70	A-1	1610	1 ⁵ / ₈	¹ / ₂	1	0	4.0	4 3V 475 TB	A-1	1610	1 ⁵ / ₈	²⁹ / ₃₂	1	0	5.0
3 3V 500 TB	5.00	4.95	A-1	1610	1 ⁵ / ₈	¹ / ₂	1	0	4.5	4 3V 500 TB	A-1	1610	1 ⁵ / ₈	²⁹ / ₃₂	1	0	5.5
3 3V 530 TB	5.30	5.25	A-1	1610	1 ⁵ / ₈	¹ / ₂	1	0	5.0	4 3V 530 TB	A-1	1610	1 ⁵ / ₈	²⁹ / ₃₂	1	0	6.0
3 3V 560 TB	5.60	5.55	A-1	1610	1 ⁵ / ₈	¹ / ₂	1	0	6.0	4 3V 560 TB	A-1	1610	1 ⁵ / ₈	²⁹ / ₃₂	1	0	7.0
3 3V 600 TB	6.00	5.95	B-1	2517	2 ¹ / ₂	⁵ / ₃₂	1 ³ / ₄	¹³ / ₃₂	7.0	4 3V 600 TB	A-1	2517	2 ¹ / ₂	⁵ / ₃₂	1 ³ / ₄	0	8.0
3 3V 650 TB	6.50	6.45	B-1	2517	2 ¹ / ₂	⁵ / ₃₂	1 ³ / ₄	¹³ / ₃₂	9.0	4 3V 650 TB	A-1	2517	2 ¹ / ₂	⁵ / ₃₂	1 ³ / ₄	0	10.0
3 3V 690 TB	6.90	6.85	B-1	2517	2 ¹ / ₂	⁵ / ₃₂	1 ³ / ₄	¹³ / ₃₂	10.0	4 3V 690 TB	A-1	2517	2 ¹ / ₂	⁵ / ₃₂	1 ³ / ₄	0	12.0
3 3V 800 TB	8.00	7.95	B-1	2517	2 ¹ / ₂	⁵ / ₃₂	1 ³ / ₄	¹³ / ₃₂	15.0	4 3V 800 TB	A-1	2517	2 ¹ / ₂	⁵ / ₃₂	1 ³ / ₄	0	18.0
3 3V 1060 TB	10.60	10.55	B-2	2517	2 ¹ / ₂	0	1 ³ / ₄	¹ / ₄	18.0	4 3V 1060 TB	A-2	2517	2 ¹ / ₂	⁵ / ₃₂	1 ³ / ₄	0	19.0
3 3V 1400 TB	14.00	13.95	B-3	2517	2 ¹ / ₂	0	1 ³ / ₄	¹ / ₄	20.0	4 3V 1400 TB	A-3	2517	2 ¹ / ₂	0	1 ³ / ₄	⁵ / ₃₂	22.0
3 3V 1900 TB	19.00	18.95	B-3	3020	3	0	2	¹ / ₂	36.0	4 3V 1900 TB	C-3	3020	3	0	2	³ / ₃₂	45.0
3 3V 2500 TB	25.00	24.95	B-3	3020	3	0	2	¹ / ₂	47.0	4 3V 2500 TB	C-3	3020	3	0	2	³ / ₃₂	63.0
3 3V 3350 TB	33.50	33.45	B-3	3020	3	¹ / ₄	2	¹ / ₄	76.0	4 3V 3350 TB	C-3	3030	3	³⁵ / ₆₄	3	³⁵ / ₆₄	80.0

Weights do not include bushings. See page B-7 for additional bushing dimensions.

3V Hi-Cap Wedge Stock Tapered Bushed Sheaves



V-BELT DRIVES

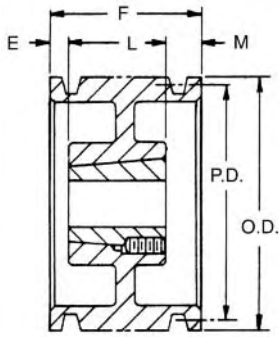

TYPE A

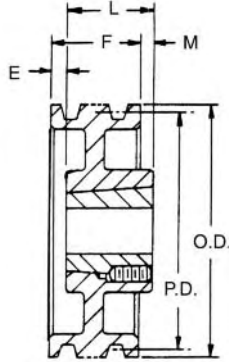

TYPE B

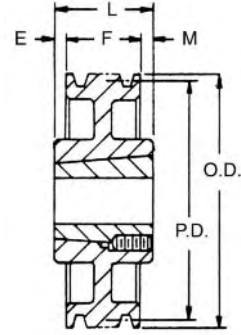

TYPE C

Dimensions in inches, weight in pounds

5 Groove F = 2 ⁵ / ₁₆										6 Groove F = 2 ²³ / ₃₂							
Part Number	Diameter		Type	Bush	Bush Max. Bore	E	L Thru Bore	M	Wt. Less Bush	Part Number	Type	Bush	Bush Max. Bore	E	L Thru Bore	M	Wt. Less Bush
	OD	Pitch 3V															
5 3V 475 TB	4.75	4.70	A-1	2517	2 ¹ / ₂	⁹ / ₁₆	1 ³ / ₄	0	4.0	6 3V 475 TB	A-1	2517	2 ¹ / ₂	³ / ₁₆	1 ³ / ₄	0	4.4
5 3V 500 TB	5.00	4.95	A-1	2517	2 ¹ / ₂	⁹ / ₁₆	1 ³ / ₄	0	4.8	6 3V 500 TB	A-1	2517	2 ¹ / ₂	³ / ₁₆	1 ³ / ₄	0	5.4
5 3V 530 TB	5.30	5.25	A-1	2517	2 ¹ / ₂	⁹ / ₁₆	1 ³ / ₄	0	5.9	6 3V 530 TB	A-1	2517	2 ¹ / ₂	³ / ₁₆	1 ³ / ₄	0	6.5
5 3V 560 TB	5.60	5.55	A-1	2517	2 ¹ / ₂	⁹ / ₁₆	1 ³ / ₄	0	7.0	6 3V 560 TB	A-1	2517	2 ¹ / ₂	³ / ₁₆	1 ³ / ₄	0	7.7
5 3V 600 TB	6.00	5.95	A-1	2517	2 ¹ / ₂	⁹ / ₁₆	1 ³ / ₄	0	8.0	6 3V 600 TB	A-1	2517	2 ¹ / ₂	³ / ₁₆	1 ³ / ₄	0	9.5
5 3V 650 TB	6.50	6.45	A-1	2517	2 ¹ / ₂	⁹ / ₁₆	1 ³ / ₄	0	11.0	6 3V 650 TB	A-1	2517	2 ¹ / ₂	³ / ₁₆	1 ³ / ₄	0	12.0
5 3V 690 TB	6.90	6.85	A-1	2517	2 ¹ / ₂	⁹ / ₁₆	1 ³ / ₄	0	13.0	6 3V 690 TB	A-1	2517	2 ¹ / ₂	³ / ₁₆	1 ³ / ₄	0	13.0
5 3V 800 TB	8.00	7.95	A-1	2517	2 ¹ / ₂	⁹ / ₁₆	1 ³ / ₄	0	19.0	6 3V 800 TB	A-1	2517	2 ¹ / ₂	³ / ₁₆	1 ³ / ₄	0	20.0
5 3V 1060 TB	10.60	10.55	A-2	2517	2 ¹ / ₂	⁹ / ₁₆	1 ³ / ₄	0	21.0	6 3V 1060 TB	A-2	2517	2 ¹ / ₂	³ / ₁₆	1 ³ / ₄	0	21.0
5 3V 1400 TB	14.00	13.95	A-3	2517	2 ¹ / ₂	0	1 ³ / ₄	⁹ / ₁₆	30.0	6 3V 1400 TB	A-3	2517	2 ¹ / ₂	⁷ / ₃₂	1 ³ / ₄	0	30.0
5 3V 1900 TB	19.00	18.95	A-3	3030	3	0	2	⁵ / ₁₆	51.0	6 3V 1900 TB	B-3	3020	3	0	2	²⁹ / ₃₂	51.0
5 3V 2500 TB	25.00	24.95	B-3	3030	3	0	3	¹¹ / ₁₆	76.0	6 3V 2500 TB	B-3	3030	3	0	3	⁹ / ₃₂	81.0
5 3V 3350 TB	33.50	33.45	C-3	3030	3	¹¹ / ₃₂	3	¹¹ / ₃₂	97.0	6 3V 3350 TB	C-3	3030	3	⁹ / ₆₄	3	⁹ / ₆₄	110.0

8 Groove F = 3 ¹⁷ / ₃₂										10 Groove F = 4 ¹¹ / ₃₂							
Part Number	Diameter		Type	Bush	Bush Max. Bore	E	L Thru Bore	M	Wt. Less Bush	Part Number	Type	Bush	Bush Max. Bore	E	L Thru Bore	M	Wt. Less Bush
	OD	Pitch 3V															
8 3V 475 TB	4.75	4.70	A-1	2517	2 ¹ / ₂	1 ²⁵ / ₃₂	1 ³ / ₄	0	5.0	10 3V 475 TB	A-1	2517	2 ¹ / ₂	2 ¹⁹ / ₃₂	1 ³ / ₄	0	6.0
8 3V 500 TB	5.00	4.95	A-1	2517	2 ¹ / ₂	1 ²⁵ / ₃₂	1 ³ / ₄	0	6.0	10 3V 500 TB	A-1	2517	2 ¹ / ₂	2 ¹⁹ / ₃₂	1 ³ / ₄	0	7.0
8 3V 530 TB	5.30	5.25	A-1	2517	2 ¹ / ₂	1 ¹ / ₃₂	1 ³ / ₄	³ / ₄	7.8	10 3V 530 TB	A-1	2517	2 ¹ / ₂	1 ²⁷ / ₃₂	1 ³ / ₄	³ / ₄	8.0
8 3V 560 TB	5.60	5.55	A-1	2517	2 ¹ / ₂	¹ / ₄	1 ³ / ₄	1 ¹¹ / ₃₂	9.0	10 3V 560 TB	A-1	2517	2 ¹ / ₂	¹ / ₂	1 ³ / ₄	2 ³ / ₃₂	9.0
8 3V 600 TB	6.00	5.95	A-1	2517	2 ¹ / ₂	¹ / ₄	1 ³ / ₄	1 ¹⁷ / ₃₂	11.0	10 3V 600 TB	A-1	2517	2 ¹ / ₂	¹ / ₂	1 ³ / ₄	2 ³ / ₃₂	12.0
8 3V 650 TB	6.50	6.45	A-1	2517	2 ¹ / ₂	¹ / ₄	1 ³ / ₄	1 ¹¹ / ₃₂	13.0	10 3V 650 TB	A-1	2517	2 ¹ / ₂	¹ / ₂	1 ³ / ₄	2 ³ / ₃₂	14.0
8 3V 690 TB	6.90	6.85	A-1	2517	2 ¹ / ₂	¹ / ₄	1 ³ / ₄	1 ¹⁷ / ₃₂	15.0	10 3V 690 TB	A-1	2517	2 ¹ / ₂	¹ / ₂	1 ³ / ₄	2 ³ / ₃₂	17.0
8 3V 800 TB	8.00	7.95	A-1	3020	3	¹ / ₂	2	1 ¹ / ₃₂	19.0	10 3V 800 TB	A-1	3020	3	¹ / ₄	2	2 ³ / ₃₂	22.0
8 3V 1060 TB	10.60	10.55	A-2	3020	3	¹ / ₂	2	1 ¹ / ₃₂	26.0	10 3V 1060 TB	A-2	3020	3	²⁷ / ₃₂	2	1 ¹ / ₂	32.0
8 3V 1400 TB	14.00	13.95	A-3	3020	3	² / ₃₂	2	⁷ / ₈	52.0	10 3V 1400 TB	A-2	3535	3 ¹ / ₂	0	3 ¹ / ₂	²⁷ / ₃₂	59.0
8 3V 1900 TB	19.00	18.95	A-3	3535	3 ¹ / ₂	0	3 ¹ / ₂	¹ / ₃₂	63.0	10 3V 1900 TB	A-3	3535	3 ¹ / ₂	0	3 ¹ / ₂	²⁷ / ₃₂	71.0
8 3V 2500 TB	25.00	24.95	A-3	3535	3 ¹ / ₂	0	3 ¹ / ₂	¹ / ₃₂	89.0	10 3V 2500 TB	A-3	4040	4	0	4	¹ / ₃₂	121.0
8 3V 3350 TB	33.50	33.45	C-3	4040	4	¹⁹ / ₆₄	4	¹⁹ / ₆₄	131.0	10 3V 3350 TB	A-3	4040	4	¹ / ₆₄	4	¹ / ₃₂	172.0

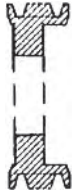

1 = SOLID

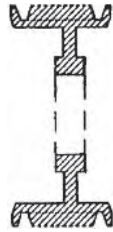

2 = WEB

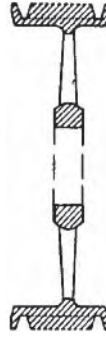

3 = ARM/SPOKE

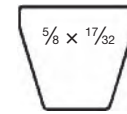

5V

Dimensions in inches, weight in pounds

2 Groove F = 1 ¹¹ / ₁₆										3 Groove F = 2 ³ / ₈							
Part Number	Diameter		Type	Bush	Bush Max. Bore	E	L Thru Bore	M	Wt. Less Bush	Part Number	Type	Bush	Bush Max. Bore	E	L Thru Bore	M	Wt. Less Bush
	OD	Pitch 5V															
2 5V 710 TB	7.10	7.00	B-1	2517	2 ¹ / ₂	¹ / ₁₆	1 ³ / ₄	0	10.0	3 5V 710 TB	A-1	2517	2 ¹ / ₂	⁵ / ₈	1 ³ / ₄	0	11.0
2 5V 750 TB	7.50	7.40	B-1	2517	2 ¹ / ₂	¹ / ₁₆	1 ³ / ₄	0	13.0	3 5V 750 TB	A-1	2517	2 ¹ / ₂	⁵ / ₈	1 ³ / ₄	0	14.0
2 5V 800 TB	8.00	7.90	B-1	2517	2 ¹ / ₂	¹ / ₁₆	1 ³ / ₄	0	14.0	3 5V 800 TB	A-1	2517	2 ¹ / ₂	⁵ / ₈	1 ³ / ₄	0	16.0
2 5V 850 TB	8.50	8.40	B-2	2517	2 ¹ / ₂	¹ / ₁₆	1 ³ / ₄	0	15.0	3 5V 850 TB	A-2	2517	2 ¹ / ₂	⁵ / ₈	1 ³ / ₄	0	17.0
2 5V 900 TB	9.00	8.90	B-2	2517	2 ¹ / ₂	¹ / ₁₆	1 ³ / ₄	0	16.0	3 5V 900 TB	A-2	2517	2 ¹ / ₂	⁵ / ₈	1 ³ / ₄	0	19.0
2 5V 925 TB	9.25	9.15	B-2	3020	3	0	2	⁵ / ₁₆	17.0	3 5V 925 TB	A-1	3020	3	0	2	⁵ / ₈	23.0
2 5V 975 TB	9.75	9.65	B-2	3020	3	0	2	⁵ / ₁₆	18.0	3 5V 975 TB	A-1	3020	3	0	2	⁵ / ₈	24.0
2 5V 1030 TB	10.30	10.20	B-2	3020	3	0	2	⁵ / ₁₆	20.0	3 5V 1030 TB	A-2	3020	3	0	2	⁵ / ₈	27.0
2 5V 1090 TB	10.90	10.80	B-2	3020	3	0	2	⁵ / ₁₆	22.0	3 5V 1090 TB	A-2	3020	3	0	2	⁵ / ₈	28.0
2 5V 1180 TB	11.80	11.70	B-2	3020	3	0	2	⁵ / ₁₆	26.0	3 5V 1180 TB	A-2	3020	3	0	2	⁵ / ₈	30.0
2 5V 1250 TB	12.50	12.40	B-2	3020	3	0	2	⁵ / ₁₆	28.0	3 5V 1250 TB	A-2	3020	3	0	2	⁵ / ₈	32.0
2 5V 1320 TB	13.20	13.10	B-3	3020	3	0	2	⁵ / ₁₆	29.0	3 5V 1320 TB	A-2	3020	3	0	2	⁵ / ₈	34.0
2 5V 1400 TB	14.00	13.90	B-3	3020	3	0	2	⁵ / ₁₆	33.0	3 5V 1400 TB	A-3	3020	3	0	2	⁵ / ₈	36.0
2 5V 1500 TB	15.00	14.90	B-3	3020	3	0	2	⁵ / ₁₆	35.0	3 5V 1500 TB	A-3	3020	3	0	2	⁵ / ₈	41.0
2 5V 1600 TB	16.00	15.90	B-3	3020	3	0	2	⁵ / ₁₆	45.0	3 5V 1600 TB	A-3	3020	3	0	2	⁵ / ₈	50.0
2 5V 2120 TB	21.20	21.10	C-3	3535	3 ¹ / ₂	³ / ₈	3 ¹ / ₂	1 ¹ / ₁₆	68.0	3 5V 2120 TB	B-3	3535	3 ¹ / ₂	0	3 ¹ / ₂	1 ¹ / ₈	65.0
2 5V 2800 TB	28.00	27.90	C-3	3535	3 ¹ / ₂	³ / ₈	3 ¹ / ₂	1 ¹ / ₁₆	96.0	3 5V 2800 TB	B-3	3535	3 ¹ / ₂	0	3 ¹ / ₂	1 ¹ / ₈	99.0
	37.50	37.40								3 5V 3750 TB	C-3	4040	4	¹ / ₂	4	1 ¹ / ₈	172.0
	50.00	49.90								3 5V 5000 TB	C-3	4040	4	¹ / ₂	4	1 ¹ / ₈	201.0

Weights do not include bushings. See page B-10-B-12 for additional bushing dimensions.

5V Hi-Cap Wedge Stock Tapered Bushed Sheaves



V-BELT DRIVES

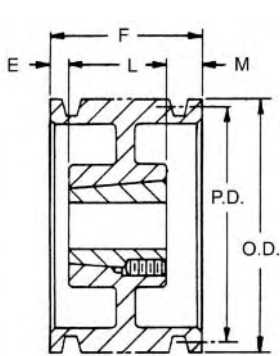

TYPE A

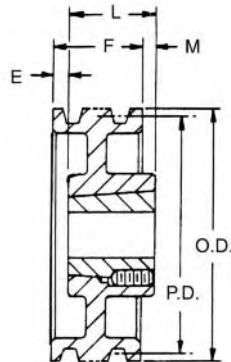

TYPE B

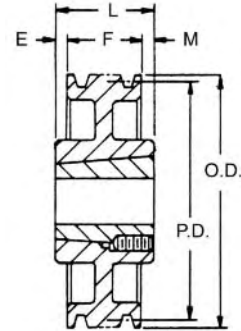

TYPE C



1 = SOLID

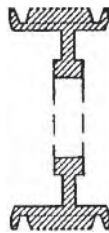

2 = WEB

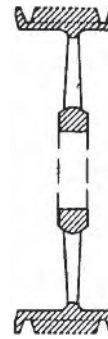

3 = ARM/SPOKE

Dimensions in inches, weight in pounds

4 Groove										5 Groove							
F = 3/16										F = 3/4							
Part Number	Diameter		Type	Bush	Bush Max. Bore	E	L Thru Bore	M	Wt. Less Bush	Part Number	Type	Bush	Bush Max. Bore	E	L Thru Bore	M	Wt. Less Bush
	OD	Pitch 5V															
4 5V 710 TB	7.10	7.00	A-1	2517	2 1/2	1 1/16	1 3/4	0	14.0	5 5V 710 TB	A-1	3020	3	1/2	2	1 1/4	15.0
4 5V 750 TB	7.50	7.40	A-1	2517	2 1/2	1 1/16	1 3/4	0	16.0	5 5V 750 TB	A-1	3020	3	1/2	2	1 1/4	17.0
4 5V 800 TB	8.00	7.90	A-1	2517	2 1/2	1 1/16	1 3/4	0	17.0	5 5V 800 TB	A-1	3020	3	1/2	2	1 1/4	20.0
4 5V 850 TB	8.50	8.40	A-2	2517	2 1/2	1 1/16	1 3/4	0	18.0	5 5V 850 TB	A-1	3020	3	1/2	2	1 1/4	22.0
4 5V 900 TB	9.00	8.90	A-2	2517	2 1/2	1 1/16	1 3/4	0	19.0	5 5V 900 TB	A-1	3020	3	1/2	2	1 1/4	30.0
4 5V 925 TB	9.25	9.15	A-1	3020	3	1/2	2	9/16	22.0	5 5V 925 TB	A-1	3020	3	1/2	2	1 1/4	36.0
4 5V 975 TB	9.75	9.65	A-1	3020	3	1/2	2	9/16	27.0	5 5V 975 TB	A-1	3020	3	1/2	2	1 1/4	37.0
4 5V 1030 TB	10.30	10.20	A-2	3020	3	1/2	2	9/16	28.0	5 5V 1030 TB	A-2	3020	3	1/2	2	1 1/4	38.0
4 5V 1090 TB	10.90	10.80	A-2	3020	3	1/2	2	9/16	31.0	5 5V 1090 TB	A-2	3020	3	1/2	2	1 1/4	39.0
4 5V 1180 TB	11.80	11.70	A-2	3020	3	1/2	2	9/16	35.0	5 5V 1180 TB	A-2	3020	3	1/2	2	1 1/4	40.0
4 5V 1250 TB	12.50	12.40	A-2	3020	3	0	2	1 1/16	44.0	5 5V 1250 TB	A-2	3535	3 1/2	0	3 1/2	1/4	50.0
4 5V 1320 TB	13.20	13.10	A-3	3020	3	0	2	1 1/16	42.0	5 5V 1320 TB	A-2	3535	3 1/2	0	3 1/2	1/4	56.0
4 5V 1400 TB	14.00	13.90	B-3	3535	3 1/2	0	3 1/2	7/16	53.0	5 5V 1400 TB	A-3	3535	3 1/2	0	3 1/2	1/4	58.0
4 5V 1500 TB	15.00	14.90	B-3	3535	3 1/2	0	3 1/2	7/16	54.0	5 5V 1500 TB	A-3	3535	3 1/2	0	3 1/2	1/4	65.0
4 5V 1600 TB	16.00	15.90	B-3	3535	3 1/2	0	3 1/2	7/16	60.0	5 5V 1600 TB	A-3	3535	3 1/2	0	3 1/2	1/4	70.0
4 5V 2120 TB	21.20	21.10	B-3	3535	3 1/2	0	3 1/2	7/16	72.0	5 5V 2120 TB	B-3	4040	4	0	4	1/4	115.0
4 5V 2800 TB	28.00	27.90	B-3	3535	3 1/2	0	3 1/2	7/16	125.0	5 5V 2800 TB	B-3	4040	4	0	4	1/4	160.0
4 5V 3750 TB	37.50	37.40	B-3	4040	4	0	4	1 1/16	189.0	5 5V 3750 TB	B-3	4040	4	0	4	1/4	182.0
4 5V 5000 TB	50.00	49.90	B-3	4040	4	0	4	1 1/16	371.0	5 5V 5000 TB	B-3	4545	4 1/2	0	4 1/2	3/4	288.0



Hi-Cap Wedge Stock Tapered Bushed Sheaves **5V**

Dimensions in inches, weight in pounds

6 Groove										8 Groove							
F = 4 ¹ / ₁₆										F = 5 ¹³ / ₁₆							
Part Number	Diameter		Type	Bush	Bush Max. Bore	E	L Thru Bore	M	Wt. Less Bush	Part Number	Type	Bush	Bush Max. Bore	E	L Thru Bore	M	Wt. Less Bush
	OD	Pitch 5V															
6 5V 710 TB	7.10	7.00	A-1	3020	3	3/4	2	1 ¹ / ₁₆	17.0	8 5V 710 TB	A-1	3030	3	1	3	1 ¹ / ₁₆	24.0
6 5V 750 TB	7.50	7.40	A-1	3020	3	3/4	2	1 ¹ / ₁₆	20.0	8 5V 750 TB	A-1	3030	3	1	3	1 ¹ / ₁₆	27.0
6 5V 800 TB	8.00	7.90	A-1	3020	3	3/4	2	1 ¹ / ₁₆	24.0	8 5V 800 TB	A-1	3030	3	1	3	1 ¹ / ₁₆	33.0
6 5V 850 TB	8.50	8.40	A-1	3020	3	3/4	2	1 ¹ / ₁₆	28.0	8 5V 850 TB	A-1	3030	3	1	3	1 ¹ / ₁₆	39.0
6 5V 900 TB	9.00	8.90	A-1	3020	3	3/4	2	1 ¹ / ₁₆	32.0	8 5V 900 TB	A-1	3535	3 ¹ / ₂	1	3 ¹ / ₂	1 ¹ / ₁₆	44.0
6 5V 925 TB	9.25	9.15	A-1	3535	3 ¹ / ₂	0	3 ¹ / ₂	1 ¹⁵ / ₁₆	39.0	8 5V 925 TB	A-1	3535	3 ¹ / ₂	1	3 ¹ / ₂	1 ¹ / ₁₆	48.0
6 5V 975 TB	9.75	9.65	A-1	3535	3 ¹ / ₂	0	3 ¹ / ₂	1 ¹⁵ / ₁₆	50.0	8 5V 975 TB	A-1	3535	3 ¹ / ₂	1	3 ¹ / ₂	1 ¹ / ₁₆	55.0
6 5V 1030 TB	10.30	10.20	A-1	3535	3 ¹ / ₂	0	3 ¹ / ₂	1 ¹⁵ / ₁₆	58.0	8 5V 1030 TB	A-1	3535	3 ¹ / ₂	1	3 ¹ / ₂	1 ¹ / ₁₆	64.0
6 5V 1090 TB	10.90	10.80	A-1	3535	3 ¹ / ₂	0	3 ¹ / ₂	1 ¹⁵ / ₁₆	60.0	8 5V 1090 TB	A-1	3535	3 ¹ / ₂	1	3 ¹ / ₂	1 ¹ / ₁₆	68.0
6 5V 1180 TB	11.80	11.70	A-2	3535	3 ¹ / ₂	0	3 ¹ / ₂	1 ¹⁵ / ₁₆	62.0	8 5V 1180 TB	A-1	3535	3 ¹ / ₂	1	3 ¹ / ₂	1 ¹ / ₁₆	74.0
6 5V 1250 TB	12.50	12.40	A-2	3535	3 ¹ / ₂	0	3 ¹ / ₂	1 ¹⁵ / ₁₆	65.0	8 5V 1250 TB	A-1	4040	4	1/4	4	1 ¹ / ₁₆	82.0
6 5V 1320 TB	13.20	13.10	A-2	3535	3 ¹ / ₂	0	3 ¹ / ₂	1 ¹⁵ / ₁₆	68.0	8 5V 1320 TB	A-1	4040	4	1/4	4	1 ¹ / ₁₆	87.0
6 5V 1400 TB	14.00	13.90	A-2	3535	3 ¹ / ₂	0	3 ¹ / ₂	1 ¹⁵ / ₁₆	72.0	8 5V 1400 TB	A-2	4040	4	1/4	4	1 ¹ / ₁₆	90.0
6 5V 1500 TB	15.00	14.90	A-2	4040	4	0	4	7/16	91.0	8 5V 1500 TB	A-2	4040	4	1/4	4	1 ¹ / ₁₆	97.0
6 5V 1600 TB	16.00	15.90	A-3	4040	4	0	4	7/16	97.0	8 5V 1600 TB	A-3	4040	4	1/4	4	1 ¹ / ₁₆	106.0
6 5V 2120 TB	21.20	21.10	A-3	4040	4	0	4	7/16	123.0	8 5V 2120 TB	A-3	4040	4	1/4	4	1 ¹ / ₁₆	144.0
6 5V 2800 TB	28.00	27.90	A-3	4040	4	0	4	7/16	176.0	8 5V 2800 TB	A-3	4545	4 ¹ / ₂	1/4	4 ¹ / ₂	1 ¹ / ₁₆	206.0
6 5V 3750 TB	37.50	37.40	B-3	4545	4 ¹ / ₂	0	4 ¹ / ₂	1/16	254.0	8 5V 3750 TB	A-3	4545	4 ¹ / ₂	1/4	4 ¹ / ₂	1 ¹ / ₁₆	271.0
6 5V 5000 TB	50.00	49.90	B-3	4545	4 ¹ / ₂	0	4 ¹ / ₂	1/16	386.0	8 5V 5000 TB	A-3	4545	4 ¹ / ₂	1/4	4 ¹ / ₂	1 ¹ / ₁₆	458.0

V-BELT DRIVES

Dimensions in inches, weight in pounds

10 Groove									
F = 7 ³ / ₁₆									
Part Number	Diameter		Type	Bush	Bush Max. Bore	E	L Thru Bore	M	Wt. Less Bush
	OD	Pitch 5V							
10 5V 800 TB	8.00	7.90	A-1	3030	3	1	3	3 ³ / ₁₆	36.0
10 5V 850 TB	8.50	8.40	A-1	3030	3	1	3	3 ³ / ₁₆	42.0
10 5V 900 TB	9.00	8.90	A-1	3535	3 ¹ / ₂	1	3 ¹ / ₂	2 ¹ / ₁₆	47.0
10 5V 925 TB	9.25	9.15	A-1	4040	4	1	4	2 ³ / ₁₆	50.0
10 5V 975 TB	9.75	9.65	A-1	4040	4	1	4	2 ³ / ₁₆	58.0
10 5V 1030 TB	10.30	10.20	A-1	4040	4	1	4	2 ³ / ₁₆	69.0
10 5V 1090 TB	10.90	10.80	A-1	4040	4	1	4	2 ³ / ₁₆	79.0
10 5V 1180 TB	11.80	11.70	A-1	4040	4	1	4	2 ³ / ₁₆	96.0
10 5V 1250 TB	12.50	12.40	A-2	4040	4	3/4	4	2 ³ / ₁₆	116.0
10 5V 1320 TB	13.20	13.10	A-2	4040	4	3/4	4	2 ³ / ₁₆	130.0
10 5V 1400 TB	14.00	13.90	A-2	4545	4 ¹ / ₂	3/4	4 ¹ / ₂	1 ¹⁵ / ₁₆	150.0
10 5V 1500 TB	15.00	14.90	A-2	4545	4 ¹ / ₂	3/4	4 ¹ / ₂	1 ¹⁵ / ₁₆	155.0
10 5V 1600 TB	16.00	15.90	A-2	4545	4 ¹ / ₂	3/4	4 ¹ / ₂	1 ¹⁵ / ₁₆	160.0
10 5V 2120 TB	21.20	21.10	A-3	4545	4 ¹ / ₂	3/4	4 ¹ / ₂	1 ¹⁵ / ₁₆	210.0
10 5V 2800 TB	28.00	27.90	A-3	4545	4 ¹ / ₂	3/4	4 ¹ / ₂	1 ¹⁵ / ₁₆	248.0
10 5V 3750 TB	37.50	37.40	A-3	4545	4 ¹ / ₂	3/4	4 ¹ / ₂	1 ¹⁵ / ₁₆	375.0
10 5V 5000 TB	50.00	49.90	A-3	5050	5	3/4	5	1 ¹ / ₁₆	502.0

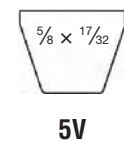

Weights do not include bushings. See page B-10- B12 for additional bushing dimensions.

8V Hi-Cap Wedge Stock Taper Bushed Sheaves



V-BELT DRIVES

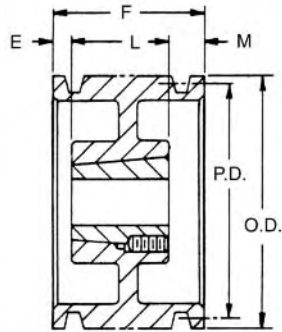

TYPE A

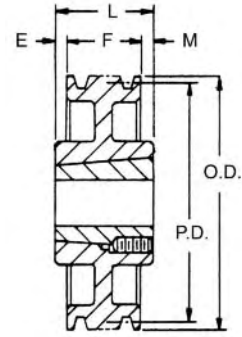

TYPE C



1 = SOLID

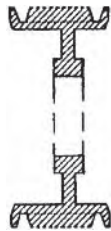

2 = WEB

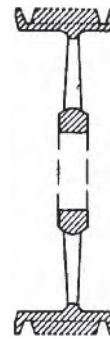

3 = ARM/SPOKE

Dimensions in inches, weight in pounds

4 Groove										5 Groove							
F = 4 7/8										F = 6							
Part Number	Diameters		Type	Bush	Bush Max. Bore	E	L Thru Bore	M	Wt. Less Bush	Part Number	Type	Bush	Bush Max. Bore	E	L Thru Bore	M	Wt. Less Bush
	OD	Pitch 8V															
4 8V 1250 TB	12.5	12.3	A-1	4040	4	0	4	7/8	88.0	5 8V 1250 TB	A-1	4040	4	3/16	4	1 13/16	100.0
4 8V 1320 TB	13.2	13.0	A-1	4040	4	0	4	7/8	102.0	5 8V 1320 TB	A-1	4040	4	3/16	4	1 13/16	115.0
4 8V 1400 TB	14.0	13.8	A-1	4040	4	0	4 1/2	7/8	123.0	5 8V 1400 TB	A-1	4040	4	3/16	4	1 13/16	133.0
4 8V 1500 TB	15.0	14.8	A-1	4040	4	0	4 1/2	7/8	145.0	5 8V 1500 TB	A-1	4040	4	3/16	4	1 13/16	156.0
4 8V 1600 TB	16.0	15.8	A-2	4040	4	0	4 1/2	7/8	111.0	5 8V 1600 TB	A-1	4040	4	1/2	4	1 1/2	181.0
4 8V 1700 TB	17.0	16.8	A-2	4040	4	0	4 1/2	7/8	120.0	5 8V 1700 TB	A-2	4545	4 1/2	0	4 1/2	1 1/2	146.0
4 8V 1800 TB	18.0	17.8	A-2	4040	4	0	4 1/2	7/8	130.0	5 8V 1800 TB	A-2	4545	4 1/2	0	4 1/2	1 1/2	156.0
4 8V 1900 TB	19.0	18.8	A-2	4040	4	0	4 1/2	7/8	140.0	5 8V 1900 TB	A-2	4545	4 1/2	0	4 1/2	1 1/2	176.0
4 8V 2000 TB	20.0	19.8	A-2	4545	4 1/2	0	4 1/2	7/8	151.0	5 8V 2000 TB	A-2	4545	4 1/2	0	4 1/2	1 1/2	186.0
4 8V 2120 TB	21.2	21.0	A-3	4545	4 1/2	0	4 1/2	7/8	154.0	5 8V 2120 TB	A-3	4545	4 1/2	0	4 1/2	1 1/2	195.0
4 8V 2240 TB	22.4	22.2	A-3	4545	4 1/2	0	4 1/2	7/8	185.0	5 8V 2240 TB	A-3	4545	4 1/2	0	4 1/2	1 1/2	200.0
4 8V 3000 TB	30.0	29.8	C-3	5050	5	0	5	1	246.0	5 8V 3000 TB	A-3	5050	5	0	5	1	278.0
4 8V 4000 TB	40.0	39.8	B-3	5050	5	0	5	1	292.0	5 8V 4000 TB	A-3	5050	5	0	5	1	350.0
4 8V 5300 TB	53.0	52.8	B-3	5050	5	0	5	1	573.0	5 8V 5300 TB	A-3	5050	5	0	5	1	565.0



Hi-Cap Wedge Stock 8V Taper Bushed Sheaves

Dimensions in inches, weight in pounds

6 Groove										8 Groove							
F = 6 $\frac{1}{8}$										F = 9 $\frac{1}{8}$							
Part Number	Diameters		Type	Bush	Bush Max. Bore	E	L Thru Bore	M	Wt. Less Bush	Part Number	Type	Bush	Bush Max. Bore	E	L Thru Bore	M	Wt. Less Bush
	OD	Pitch 8V															
6 8V 1250 TB	12.5	12.3	A-1	4040	4 $\frac{1}{2}$	1	4 $\frac{1}{2}$	2 $\frac{1}{2}$	100.0	8 8V 1250 TB	A-1	4545	4 $\frac{1}{2}$	1 $\frac{1}{2}$	4 $\frac{1}{2}$	3 $\frac{3}{8}$	125.0
6 8V 1320 TB	13.2	13.0	A-1	4040	4 $\frac{1}{2}$	1	4 $\frac{1}{2}$	2 $\frac{1}{2}$	124.0	8 8V 1320 TB	A-1	4545	4 $\frac{1}{2}$	1 $\frac{1}{2}$	4 $\frac{1}{2}$	3 $\frac{3}{8}$	135.0
6 8V 1400 TB	14.0	13.8	A-1	4040	4 $\frac{1}{2}$	1	4 $\frac{1}{2}$	2 $\frac{1}{2}$	142.0	8 8V 1400 TB	A-1	4545	4 $\frac{1}{2}$	1 $\frac{1}{2}$	4 $\frac{1}{2}$	3 $\frac{3}{8}$	156.0
6 8V 1500 TB	15.0	14.8	A-1	4545	4 $\frac{1}{2}$	$\frac{1}{2}$	4 $\frac{1}{2}$	2 $\frac{1}{2}$	153.0	8 8V 1500 TB	A-1	4545	4 $\frac{1}{2}$	1 $\frac{1}{2}$	4 $\frac{1}{2}$	3 $\frac{3}{8}$	160.0
6 8V 1600 TB	16.0	15.8	A-2	4545	4 $\frac{1}{2}$	$\frac{1}{2}$	4 $\frac{1}{2}$	2 $\frac{1}{2}$	170.0	8 8V 1600 TB	A-2	4545	4 $\frac{1}{2}$	1 $\frac{1}{2}$	4 $\frac{1}{2}$	3 $\frac{3}{8}$	166.0
6 8V 1700 TB	17.0	16.8	A-2	4545	4 $\frac{1}{2}$	$\frac{1}{2}$	4 $\frac{1}{2}$	2 $\frac{1}{2}$	175.0	8 8V 1700 TB	A-2	5050	5	1	5	3 $\frac{3}{8}$	265.0
6 8V 1800 TB	18.0	17.8	A-2	4545	4 $\frac{1}{2}$	$\frac{1}{2}$	4 $\frac{1}{2}$	2 $\frac{1}{2}$	180.0	8 8V 1800 TB	A-2	5050	5	1	5	3 $\frac{3}{8}$	204.0
6 8V 1900 TB	19.0	18.8	A-2	4545	4 $\frac{1}{2}$	$\frac{1}{2}$	4 $\frac{1}{2}$	2 $\frac{1}{2}$	182.0	8 8V 1900 TB	A-2	5050	5	1	5	3 $\frac{3}{8}$	228.0
6 8V 2000 TB	20.0	19.8	A-2	5050	5	$\frac{1}{2}$	5	1 $\frac{1}{2}$	226.0	8 8V 2000 TB	A-2	5050	5	1	5	3 $\frac{3}{8}$	234.0
6 8V 2120 TB	21.2	21.0	A-3	5050	5	$\frac{1}{2}$	5	1 $\frac{1}{2}$	246.0	8 8V 2120 TB	A-3	5050	5	1	5	3 $\frac{3}{8}$	246.0
6 8V 2240 TB	22.4	22.2	A-3	5050	5	$\frac{1}{2}$	5	1 $\frac{1}{2}$	267.0	8 8V 2240 TB	A-3	5050	5	1	5	3 $\frac{3}{8}$	300.0
6 8V 3000 TB	30.0	29.8	A-3	5050	5	$\frac{1}{2}$	5	1 $\frac{1}{2}$	398.0	8 8V 3000 TB	A-3	5050	5	1	5	3 $\frac{3}{8}$	384.0
6 8V 4000 TB	40.0	39.8	A-3	5050	5	$\frac{1}{2}$	5	1 $\frac{1}{2}$	468.0	8 8V 4000 TB	A-3	5050	5	1	5	3 $\frac{3}{8}$	556.0
6 8V 5300 TB	53.0	52.8	A-3	5050	5	$\frac{1}{2}$	5	1 $\frac{1}{2}$	658.0	8 8V 5300 TB	A-3	6050	6	1	5	3 $\frac{3}{8}$	1040.0

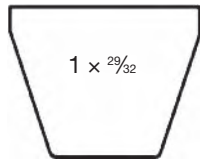

8V

10 Groove									
F = 11 $\frac{1}{8}$									
Part Number	Diameters		Type	Bush	Bush Max. Bore	E	L Thru Bore	M	Wt. Less Bush
	OD	Pitch 8V							
10 8V 1320 TB	13.2	13.0	A-1	4545	4 $\frac{1}{2}$	1	4 $\frac{1}{2}$	6 $\frac{1}{8}$	150.0
10 8V 1400 TB	14.0	13.8	A-1	4545	4 $\frac{1}{2}$	1	4 $\frac{1}{2}$	6 $\frac{1}{8}$	180.0
10 8V 1500 TB	15.0	14.8	A-1	5050	5	1	5	5 $\frac{1}{8}$	211.0
10 8V 1600 TB	16.0	15.8	A-1	5050	5	1	5	5 $\frac{1}{8}$	220.0
10 8V 1700 TB	17.0	16.8	A-2	5050	5	2 $\frac{1}{4}$	5	4 $\frac{1}{8}$	228.0
10 8V 1800 TB	18.0	17.8	A-2	5050	5	2 $\frac{1}{4}$	5	4 $\frac{1}{8}$	244.0
10 8V 1900 TB	19.0	18.8	A-2	5050	5	2 $\frac{1}{4}$	5	4 $\frac{1}{8}$	260.0
10 8V 2000 TB	20.0	19.8	A-2	5050	5	2 $\frac{1}{4}$	5	4 $\frac{1}{8}$	270.0
10 8V 2120 TB	21.2	21.0	A-2	5050	5	2 $\frac{1}{4}$	5	4 $\frac{1}{8}$	282.0
10 8V 2240 TB	22.4	22.2	A-3	5050	5	2 $\frac{1}{4}$	5	4 $\frac{1}{8}$	312.0
10 8V 3000 TB	30.0	29.8	A-3	5050	5	2 $\frac{1}{4}$	5	4 $\frac{1}{8}$	448.0
10 8V 4000 TB	40.0	39.8	A-3	6050	6	2 $\frac{1}{4}$	5	4 $\frac{1}{8}$	550.0
10 8V 5300 TB	53.0	52.8	A-3	6050	6	2 $\frac{1}{4}$	5	4 $\frac{1}{8}$	870.0

Weights do not include bushings. See page B-10-B-12 for additional bushing dimensions.

V-BELT DRIVES

A/B Combination Groove Conventional Taper Bushed Stock Sheaves

V-BELT DRIVES

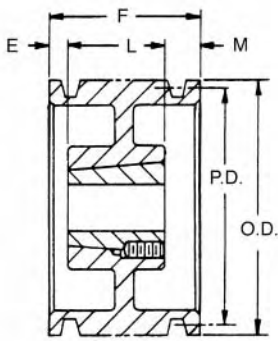

TYPE A

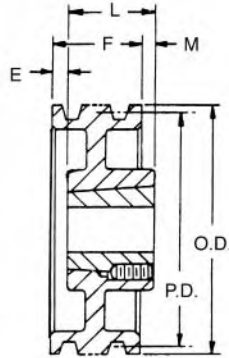

TYPE B

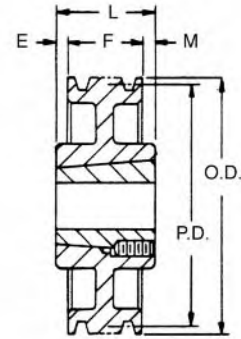

TYPE C

Dimensions in inches, weight in pounds

1 Groove F = 1*											2 Groove F = 1 1/4							
Part Number	Diameters		OD	Type	Bush	Bush Max. Bore	E	L Thru Bore	M	Wt. Less Bush	Part Number	Type	Bush	Bush Max. Bore	E	L Thru Bore	M	Wt. Less Bush
	A Belts	B Belts																
1 B 34 TB	3.0	3.4	3.75	A-1	1210	1 1/4	0	1	0	2.2	2 B 34 TB	A-1	1210	1 1/4	3/4	1	0	2.2
1 B 36 TB	3.2	3.6	3.95	A-1	1210	1 1/4	0	1	0	2.6	2 B 36 TB	A-1	1210	1 1/4	3/4	1	0	2.6
1 B 38 TB	3.4	3.8	4.15	A-1	1610	1 1/4	0	1	0	2.8	2 B 38 TB	A-1	1610	1 1/4	3/4	1	0	2.8
1 B 40 TB	3.6	4.0	4.35	A-1	1610	1 1/4	0	1	0	3.0	2 B 40 TB	A-1	1610	1 1/4	3/4	1	0	3.0
1 B 42 TB	3.8	4.2	4.55	A-1	1610	1 1/4	0	1	0	3.5	2 B 42 TB	A-1	1610	1 1/4	3/4	1	0	4.0
1 B 44 TB	4.0	4.4	4.75	A-1	1610	1 1/4	0	1	0	3.8	2 B 44 TB	A-1	1610	1 1/4	3/4	1	0	4.5
1 B 46 TB	4.2	4.6	4.95	A-1	1610	1 1/4	0	1	0	4.0	2 B 46 TB	A-1	1610	1 1/4	3/4	1	0	5.0
1 B 48 TB	4.4	4.8	5.15	A-1	1610	1 1/4	0	1	0	4.5	2 B 48 TB	A-1	1610	1 1/4	3/4	1	0	5.5
1 B 50 TB	4.6	5.0	5.35	A-1	1610	1 1/4	0	1	0	4.8	2 B 50 TB	A-1	1610	1 1/4	3/4	1	0	6.0
1 B 52 TB	4.8	5.2	5.55	A-1	1610	1 1/4	0	1	0	5.0	2 B 52 TB	A-1	1610	1 1/4	3/4	1	0	6.5
1 B 54 TB	5.0	5.4	5.75	A-1	1610	1 1/4	0	1	0	5.5	2 B 54 TB	A-1	1610	1 1/4	3/4	1	0	7.0
1 B 56 TB	5.2	5.6	5.95	A-1	1610	1 1/4	0	1	0	6.0	2 B 56 TB	A-1	1610	1 1/4	3/4	1	0	8.2
1 B 58 TB	5.4	5.8	6.15	A-1	1610	1 1/4	0	1	0	6.3	2 B 58 TB	A-1	1610	1 1/4	3/4	1	0	8.6
1 B 60 TB	5.6	6.0	6.35	A-1	1610	1 1/4	0	1	0	6.7	2 B 60 TB	A-1	1610	1 1/4	3/4	1	0	8.8
1 B 62 TB	5.8	6.2	6.55	A-1	1610	1 1/4	0	1	0	7.0	2 B 62 TB	A-1	1610	1 1/4	3/4	1	0	9.0
1 B 64 TB	6.0	6.4	6.75	A-1	1610	1 1/4	0	1	0	8.0	2 B 64 TB	A-1	1610	1 1/4	3/4	1	0	10.0
1 B 66 TB	6.2	6.6	6.95	A-1	1610	1 1/4	0	1	0	8.5	2 B 66 TB	A-1	1610	1 1/4	3/4	1	0	10.5
1 B 68 TB	6.4	6.8	7.15	A-1	1610	1 1/4	0	1	0	9.0	2 B 68 TB	A-1	1610	1 1/4	3/4	1	0	11.0
1 B 74 TB	7.0	7.4	7.75	B-1	2517	2 1/2	0	1 1/4	3/4	9.4	2 B 74 TB	A-1	2517	2 1/2	0	1 1/4	0	16.0
1 B 86 TB	8.2	8.6	8.95	B-2	2517	2 1/2	0	1 1/4	3/4	12.0	2 B 86 TB	A-2	2517	2 1/2	0	1 1/4	0	18.0
1 B 94 TB	9.0	9.4	9.75	B-2	2517	2 1/2	0	1 1/4	3/4	14.0	2 B 94 TB	A-2	2517	2 1/2	0	1 1/4	0	20.0
1 B 110 TB	10.6	11.0	11.35	B-2	2517	2 1/2	0	1 1/4	3/4	18.0	2 B 110 TB	A-2	2517	2 1/2	0	1 1/4	0	25.0
1 B 124 TB	12.0	12.4	12.75	C-3	2517	2 1/2	1/4	1 1/4	1/2	18.5	2 B 124 TB	A-3	2517	2 1/2	0	1 1/4	0	27.0
1 B 154 TB	15.0	15.4	15.75	C-3	2517	2 1/2	1/4	1 1/4	1/2	19.0	2 B 154 TB	A-3	2517	2 1/2	0	1 1/4	0	31.0
1 B 184 TB*	18.0	18.4	18.75	C-3	2517	2 1/2	3/8	1 1/4	3/8	24.0	2 B 184 TB	A-3	2517	2 1/2	0	1 1/4	0	33.0
	19.6	20.0	20.35								2 B 200 TB	C-3	3020	3	0	2	1/4	49.0
	24.6	25.0	25.35								2 B 250 TB	C-3	3020	3	0	2	1/4	65.0
	29.6	30.0	30.35								2 B 300 TB	C-3	3020	3	0	2	1/4	75.0
	37.6	38.0	38.35								2 B 380 TB	C-3	3020	3	0	2	1/4	112.0

* F = 1" 1 B 154 TB
F = 1 1/4" for 1 B 184 TB

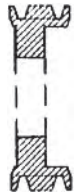

1 = SOLID

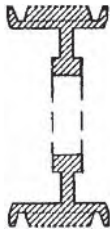

2 = WEB



3 = ARM/SPOKE

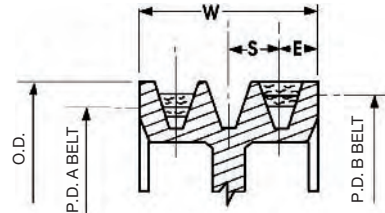

$$W = S(N-1) + 2E$$

N = No. of Grooves

Drawing shows position of "A" and "B" belts in groove.

Combination Groove Dimensions

Belt Section	E	S	OD
"AB"	1/2	3/4	P.D. "B" +.35

Dimensions in inches, weight in pounds

3 Groove F = 2 1/2											4 Groove F = 3 1/4							
Part Number	Diameters		OD	Type	Bush	Bush Max. Bore	E	L Thru Bore	M	Wt. Less Bush	Part Number	Type	Bush	Bush Max. Bore	E	L Thru Bore	M	Wt. Less Bush
	A Belts	B Belts																
3 B 34 TB	3.0	3.4	3.75	A-1	1210	1 1/4	1 1/2	1	0	3.0	4 B 34 TB	A-1	1210	1 1/4	2 1/4	1	0	3.0
3 B 36 TB	3.2	3.6	3.95	A-1	1210	1 1/4	1 1/2	1	0	3.5	4 B 36 TB	A-1	1210	1 1/4	2 1/4	1	0	3.5
3 B 38 TB	3.4	3.8	4.15	A-1	1610	1 1/4	1 1/2	1	0	4.0	4 B 38 TB	A-1	1610	1 1/4	2 1/4	1	0	4.0
3 B 40 TB	3.6	4.0	4.35	A-1	1610	1 1/4	1 1/2	1	0	5.0	4 B 40 TB	A-1	1610	1 1/4	2 1/4	1	0	5.0
3 B 42 TB	3.8	4.2	4.55	A-1	1610	1 1/4	1 1/2	1	0	6.0	4 B 42 TB	A-1	1610	1 1/4	2 1/4	1	0	5.5
3 B 44 TB	4.0	4.4	4.75	A-1	1610	1 1/4	1 1/2	1	0	6.5	4 B 44 TB	A-1	1610	1 1/4	2 1/4	1	0	6.0
3 B 46 TB	4.2	4.6	4.95	A-1	1610	1 1/4	1 1/2	1	0	7.0	4 B 46 TB	A-1	1610	1 1/4	2 1/4	1	0	7.0
3 B 48 TB	4.4	4.8	5.15	A-1	1610	1 1/4	1 1/2	1	0	8.0	4 B 48 TB	A-1	1610	1 1/4	2 1/4	1	0	8.0
3 B 50 TB	4.6	5.0	5.35	A-1	1610	1 1/4	1 1/2	1	0	8.5	4 B 50 TB	A-1	2517	2 1/2	1 1/2	1 1/4	0	8.5
3 B 52 TB	4.8	5.2	5.55	A-1	1610	1 1/4	1 1/2	1	0	9.0	4 B 52 TB	A-1	2517	2 1/2	1 1/2	1 1/4	0	9.0
3 B 54 TB	5.0	5.4	5.75	A-1	2517	2 1/2	1 1/2	1 1/4	0	9.5	4 B 54 TB	A-1	2517	2 1/2	1 1/2	1 1/4	0	9.5
3 B 56 TB	5.2	5.6	5.95	A-1	2517	2 1/2	1 1/2	1 1/4	0	10.0	4 B 56 TB	A-1	2517	2 1/2	1 1/2	1 1/4	0	10.0
3 B 58 TB	5.4	5.8	6.15	A-1	2517	2 1/2	1 1/2	1 1/4	0	10.5	4 B 58 TB	A-1	2517	2 1/2	1 1/2	1 1/4	0	12.0
3 B 60 TB	5.6	6.0	6.35	A-1	2517	2 1/2	1 1/2	1 1/4	0	11.0	4 B 60 TB	A-1	2517	2 1/2	1 1/2	1 1/4	0	12.5
3 B 62 TB	5.8	6.2	6.55	A-1	2517	2 1/2	1 1/2	1 1/4	0	11.5	4 B 62 TB	A-1	2517	2 1/2	1 1/2	1 1/4	0	13.0
3 B 64 TB	6.0	6.4	6.75	A-1	2517	2 1/2	1 1/2	1 1/4	0	12.0	4 B 64 TB	A-1	2517	2 1/2	1 1/2	1 1/4	0	14.0
3 B 66 TB	6.2	6.6	6.95	A-1	2517	2 1/2	1 1/2	1 1/4	0	12.3	4 B 66 TB	A-1	2517	2 1/2	1 1/2	1 1/4	0	15.0
3 B 68 TB	6.4	6.8	7.15	A-1	2517	2 1/2	1 1/2	1 1/4	0	12.8	4 B 68 TB	A-1	2517	2 1/2	1 1/2	1 1/4	0	16.0
3 B 74 TB	7.0	7.4	7.75	A-1	2517	2 1/2	1 1/2	1 1/4	0	16.0	4 B 74 TB	A-1	2517	2 1/2	1 1/2	1 1/4	0	20.0
3 B 86 TB	8.2	8.6	8.95	A-2	2517	2 1/2	1 1/2	1 1/4	0	19.0	4 B 86 TB	A-2	2517	2 1/2	1 1/2	1 1/4	0	21.0
3 B 94 TB	9.0	9.4	9.75	A-2	2517	2 1/2	1 1/2	1 1/4	0	21.0	4 B 94 TB	A-2	2517	2 1/2	1 1/2	1 1/4	0	23.0
3 B 110 TB	10.6	11.0	11.35	A-2	2517	2 1/2	1 1/2	1 1/4	0	24.0	4 B 110 TB	A-2	2517	2 1/2	1 1/2	1 1/4	0	28.0
3 B 124 TB	12.0	12.4	12.75	A-3	2517	2 1/2	0	1 1/4	0	28.0	4 B 124 TB	A-3	2517	2 1/2	1 1/2	1 1/4	1 1/4	34.0
3 B 154 TB	15.0	15.4	15.75	A-3	2517	2 1/2	0	1 1/4	0	30.0	4 B 154 TB	A-3	2517	2 1/2	1 1/2	1 1/4	1 1/4	42.0
3 B 184 TB	18.0	18.4	18.75	A-3	2517	2 1/2	0	1 1/4	0	44.0	4 B 184 TB	A-3	2517	2 1/2	1 1/2	1 1/4	1	53.0
3 B 200 TB	19.6	20.0	20.35	A-3	3020	3	0	2 1/2	1/2	58.0	4 B 200 TB	A-3	3020	3	0	2	3/4	63.0
3 B 250 TB	24.6	25.0	25.35	A-3	3020	3	0	2 1/2	1/2	74.0	4 B 250 TB	A-3	3030	3	0	3	1 1/4	80.0
3 B 300 TB	29.6	30.0	30.35	A-3	3020	3	0	2 1/2	1/2	84.0	4 B 300 TB	A-3	3030	3	0	3	1 1/4	100.0
3 B 380 TB	37.6	38.0	38.35	B-3	3020	3	0	3	1/2	135.0	4 B 380 TB	A-3	3030	3	0	3	1 1/4	142.0

Weights do not include bushings. See page B-10-B-12 for additional bushing dimensions.

A/B Combination Groove Conventional Taper Bushed Stock Sheaves

Dimensions in inches, weight in pounds

V-BELT DRIVES

5 Groove											6 Groove							
F = 4											F = 4 1/4							
Part Number	Diameters		OD	Type	Bush	Bush Max. Bore	E	L Thru Bore	M	Wt. Less Bush	Part Number	Type	Bush	Bush Max. Bore	E	L Thru Bore	M	Wt. Less Bush
	A Belts	B Belts																
5 B 34 TB	3.0	3.4	3.75	A-1	1210	1 1/4	2 1/2	1 1/2	0	5.0								
5 B 36 TB	3.2	3.6	3.95	A-1	1210	1 1/4	2 1/2	1 1/2	0	5.5								
5 B 38 TB	3.4	3.8	4.15	A-1	1215	1 1/2	2 3/4	1 1/2	1 1/2	6.0								
5 B 40 TB	3.6	4.0	4.35	A-1	1215	1 1/2	2 3/4	1 1/2	1 1/2	6.5								
5 B 42 TB	3.8	4.2	4.55	A-1	1615	1 1/2	2 3/4	1 1/2	0	7.0	6 B 42 TB	A-1	1615	1 1/2	3 1/4	1 1/2	0	8.0
5 B 44 TB	4.0	4.4	4.75	A-1	1615	1 1/2	2 3/4	1 1/2	0	8.0	6 B 44 TB	A-1	1615	1 1/2	3 1/4	1 1/2	0	9.0
5 B 46 TB	4.2	4.6	4.95	A-1	1615	1 1/2	2 3/4	1 1/2	0	9.0	6 B 46 TB	A-1	1615	1 1/2	3 1/4	1 1/2	0	10.0
5 B 50 TB	4.6	5.0	5.35	A-1	1615	1 1/2	2 3/4	1 1/2	0	10.5	6 B 50 TB	A-1	1615	1 1/2	3 1/4	1 1/2	2	11.9
5 B 52 TB	4.8	5.2	5.55	A-1	1615	1 1/2	2 3/4	1 1/2	0	11.3	6 B 52 TB	A-1	1615	1 1/2	3 1/4	1 1/2	2	12.8
5 B 54 TB	5.0	5.4	5.75	A-1	2517	2 1/2	2 3/4	1 1/2	0	11.5	6 B 54 TB	A-1	1615	1 1/2	3 1/4	1 1/2	2	13.7
5 B 56 TB	5.2	5.6	5.95	A-1	2517	2 1/2	2 3/4	1 1/2	0	12.0	6 B 56 TB	A-1	1615	1 1/2	3 1/4	1 1/2	2	14.6
5 B 60 TB	5.6	6.0	6.35	A-1	2517	2 1/2	2 3/4	1 1/2	0	14.0	6 B 60 TB	A-1	2517	2 1/2	3	1 1/2	0	16.0
5 B 64 TB	6.0	6.4	6.75	A-1	2517	2 1/2	2 3/4	1 1/2	0	16.0	6 B 64 TB	A-1	2517	2 1/2	3	1 1/2	0	19.5
5 B 68 TB	6.4	6.8	7.15	A-1	2517	2 1/2	2 3/4	1 1/2	0	18.0	6 B 68 TB	A-1	2517	2 1/2	3	1 1/2	0	21.0
5 B 74 TB	7.0	7.4	7.75	A-1	2517	2 1/2	2 3/4	1 1/2	0	22.0	6 B 74 TB	A-1	2517	2 1/2	3	1 1/2	0	25.0
5 B 86 TB	8.2	8.6	8.95	A-2	2517	2 1/2	2 3/4	1 1/2	0	24.0	6 B 86 TB	A-2	2517	2 1/2	3	1 1/2	0	27.0
5 B 94 TB	9.0	9.4	9.75	A-2	2517	2 1/2	2 3/4	1 1/2	0	26.0	6 B 94 TB	A-2	2517	2 1/2	3	1 1/2	0	28.0
5 B 110 TB	10.6	11.0	11.35	A-2	2517	2 1/2	2 3/4	1 1/2	0	35.0	6 B 110 TB	A-2	2517	2 1/2	3	1 1/2	0	34.0
5 B 124 TB	12.0	12.4	12.75	A-3	2517	2 1/2	2 3/4	1 1/2	1 1/2	40.0	6 B 124 TB	A-3	2517	2 1/2	1 1/2	1 1/2	1 1/2	43.0
5 B 154 TB	15.0	15.4	15.75	A-3	2517	2 1/2	2 3/4	1 1/2	1 1/2	47.0	6 B 154 TB	A-3	2517	2 1/2	1 1/2	1 1/2	1 1/2	52.0
5 B 184 TB	18.0	18.4	18.75	A-3	2517	2 1/2	2 3/4	1 1/2	1 1/2	52.0	6 B 184 TB	A-3	2517	2 1/2	1 1/2	1 1/2	1 1/2	62.0
5 B 200 TB	19.6	20.0	20.35	A-3	3030	3	3	3	3	75.0	6 B 200 TB	A-3	3030	3	3	3	1 1/2	85.0
5 B 250 TB	24.6	25.0	25.35	A-3	3030	3	3	3	3	81.0	6 B 250 TB	A-3	3030	3	3	3	1 1/2	100.0
5 B 300 TB	29.6	30.0	30.35	A-3	3030	3	3	3	3	109.0	6 B 300 TB	A-3	3030	3	3	3	1 1/2	137.0
5 B 380 TB	37.6	38.0	38.35	A-3	3030	3	3	3	3	158.0	6 B 380 TB	A-3	3030	3	3	3	1 1/2	168.0

8 Groove											10 Groove							
F = 6 1/4											F = 7 1/4							
Part Number	Diameters		OD	Type	Bush	Bush Max. Bore	E	L Thru Bore	M	Wt. Less Bush	Part Number	Type	Bush	Bush Max. Bore	E	L Thru Bore	M	Wt. Less Bush
	A Belts	B Belts																
8 B 54 TB	5.0	5.4	5.75	A-1	2517	2 1/2	1 1/2	1 1/2	2 1/2	16.0	10 B 54 TB	A-1	2517	2 1/2	3	1 1/2	3	18.0
8 B 56 TB	5.2	5.6	5.95	A-1	2517	2 1/2	1 1/2	1 1/2	2 1/2	17.0	10 B 56 TB	A-1	2517	2 1/2	3	1 1/2	3	20.0
8 B 60 TB	5.6	6.0	6.35	A-1	2517	2 1/2	1 1/2	1 1/2	2 1/2	19.0	10 B 60 TB	A-1	2517	2 1/2	3	1 1/2	3	22.0
8 B 64 TB	6.0	6.4	6.75	A-1	2517	2 1/2	1 1/2	1 1/2	2 1/2	21.0	10 B 64 TB	A-1	2517	2 1/2	3	1 1/2	3	25.5
8 B 68 TB	6.4	6.8	7.15	A-1	2517	2 1/2	1 1/2	1 1/2	2 1/2	25.0	10 B 68 TB	A-1	2517	2 1/2	3	1 1/2	3	28.0
8 B 74 TB	7.0	7.4	7.75	A-1	2517	2 1/2	1 1/2	1 1/2	2 1/2	29.0	10 B 74 TB	A-1	2517	2 1/2	3	1 1/2	3	35.0
8 B 86 TB	8.2	8.6	8.95	A-1	3030	3	1	3	2 1/2	37.0	10 B 86 TB	A-1	3030	3	2	3	2 1/2	43.0
8 B 94 TB	9.0	9.4	9.95	A-2	3030	3	1	3	2 1/2	41.0	10 B 94 TB	A-2	3030	3	2	3	2 1/2	46.0
8 B 110 TB	10.6	11.0	11.35	A-2	3030	3	1	3	2 1/2	51.0	10 B 110 TB	A-2	3030	3	2	3	2 1/2	52.0
8 B 124 TB	12.0	12.4	12.75	A-3	3030	3	1	3	2 1/2	56.0								
8 B 154 TB	15.0	15.4	15.75	A-3	3030	3	1	3	2 1/2	69.0								
8 B 184 TB	18.0	18.4	18.75	A-3	3030	3	1	3	2 1/2	99.0								
8 B 200 TB	19.6	20.0	20.35	A-3	3030	3	1	3	2 1/2	115.0								
8 B 250 TB	24.6	25.0	25.35	A-3	3535	3 1/2	3/4	3 1/2	2	145.0								
8 B 300 TB	29.6	30.0	30.35	A-3	3535	3 1/2	3/4	3 1/2	2	170.0								
8 B 380 TB	37.6	38.0	38.35	A-3	4040	4	1 1/2	4	1 1/2	260.0								

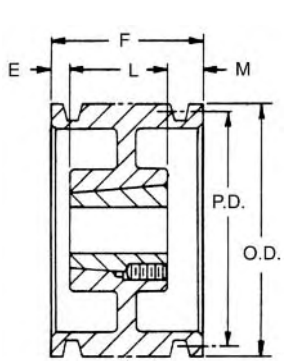

TYPE A

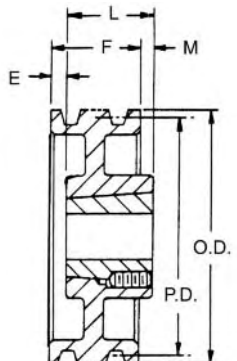

TYPE B

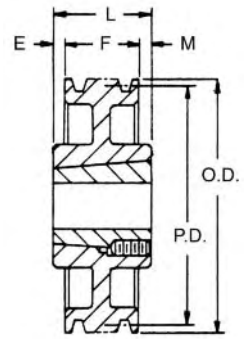

TYPE C

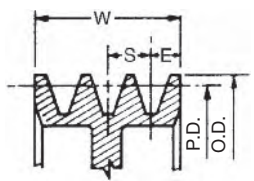

Groove Dimensions

Belt Section	E	S	O.D.
"C"	1/16	1	P.D. + .40

W = S(N-1) + 2E
N = No. of Grooves

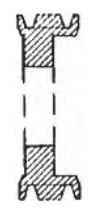

1 = SOLID

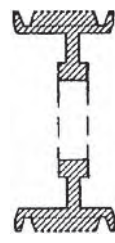

2 = WEB



3 = ARM/SPOKE

Dimensions in inches, weight in pounds

2 Groove										3 Groove							
F = 2 3/8										F = 3 3/8							
Part Number	PD C Belt	OD	Type	Bush	Bush Max. Bore	E	L Thru Bore	M	Wt. Less Bush	Part Number	Type	Bush	Bush Max. Bore	E	L Thru Bore	M	Wt. Less Bush
2 C 70 TB	7.00	7.40	A-1	2517	2 1/2	3/8	1 1/2	0	15.0	3 C 70 TB	A-1	2517	2 1/2	1/4	1 1/2	1 1/2	18.0
2 C 75 TB	7.50	7.90	A-1	2517	2 1/2	3/8	1 1/2	0	17.0	3 C 75 TB	A-1	2517	2 1/2	1/4	1 1/2	1 1/2	20.0
2 C 80 TB	8.00	8.40	A-1	2517	2 1/2	3/8	1 1/2	0	20.0	3 C 80 TB	A-1	2517	2 1/2	1/4	1 1/2	1 1/2	22.0
2 C 85 TB	8.50	8.90	A-2	2517	2 1/2	3/8	1 1/2	0	22.0	3 C 85 TB	A-2	2517	2 1/2	1/4	1 1/2	1 1/2	23.0
2 C 90 TB	9.00	9.40	A-2	2517	2 1/2	3/8	1 1/2	0	23.0	3 C 90 TB	A-2	2517	2 1/2	1/4	1 1/2	1 1/2	24.0
2 C 95 TB	9.50	9.90	A-2	2517	2 1/2	3/8	1 1/2	0	24.0	3 C 95 TB	A-2	2517	2 1/2	1/4	1 1/2	1 1/2	27.0
2 C 100 TB	10.00	10.40	A-2	2517	2 1/2	3/8	1 1/2	0	25.0	3 C 100 TB	A-2	2517	2 1/2	1/4	1 1/2	1 1/2	29.0
2 C 105 TB	10.50	10.90	A-2	2517	2 1/2	3/8	1 1/2	0	26.0	3 C 105 TB	A-2	2517	2 1/2	1/4	1 1/2	1 1/2	32.0
2 C 110 TB	11.00	11.40	A-2	2517	2 1/2	3/8	1 1/2	0	27.0	3 C 110 TB	A-2	2517	2 1/2	1/4	1 1/2	1 1/2	35.0
2 C 120 TB	12.00	12.40	A-2	2517	2 1/2	3/8	1 1/2	0	33.0	3 C 120 TB	A-2	3020	3	0	2	1 1/2	44.0
2 C 130 TB	13.00	13.40	A-3	2517	2 1/2	3/8	1 1/2	0	35.0	3 C 130 TB	A-3	3020	3	0	2	1 1/2	49.0
2 C 140 TB	14.00	14.40	A-3	2517	2 1/2	3/8	1 1/2	0	36.0	3 C 140 TB	A-3	3020	3	0	2	1 1/2	50.0
2 C 160 TB	16.00	16.40	A-3	2517	2 1/2	3/8	1 1/2	0	42.0	3 C 160 TB	A-3	3020	3	0	2	1 1/2	64.0
2 C 180 TB	18.00	18.40	A-3	3020	3	0	2	3/8	42.0	3 C 180 TB	A-3	3030	3	0	3	3/8	64.0
2 C 200 TB	20.00	20.40	A-3	3020	3	0	2	3/8	45.0	3 C 200 TB	A-3	3030	3	0	3	3/8	78.0
2 C 240 TB	24.00	24.40	A-3	3020	3	0	2	3/8	72.0	3 C 240 TB	A-3	3030	3	0	3	3/8	96.0
	30.00	30.40								3 C 300 TB	B-3	3535	3 1/2	0	3 1/2	1/2	125.0
	36.00	36.40								3 C 360 TB	B-3	3535	3 1/2	0	3 1/2	1/2	175.0

Weights do not include bushings. See page B-10-B-12 for additional bushing dimensions.

C Conventional Taper Bushed Sheaves



V-BELT DRIVES

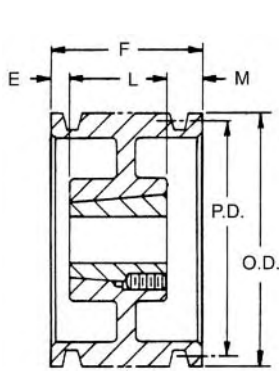

TYPE A

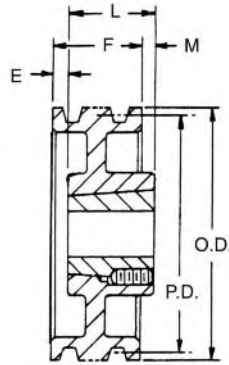

TYPE B

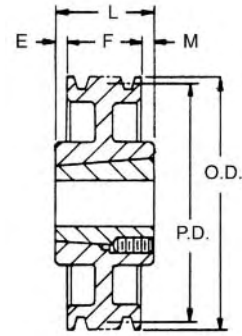

TYPE C



1 = SOLID

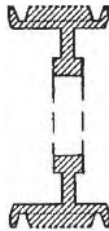

2 = WEB

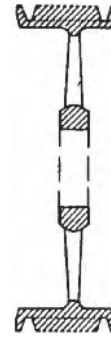

3 = ARM/SPOKE

Dimensions in inches, weight in pounds

4 Groove										5 Groove							
F = 4 3/8										F = 5 3/8							
Part Number	PD C Belt	OD	Type	Bush	Bush Max. Bore	E	L Thru Bore	M	Wt. Less Bush	Part Number	Type	Bush	Bush Max. Bore	E	L Thru Bore	M	Wt. Less Bush
4 C 70 TB	7.00	7.40	A-1	2517	2 1/2	1/2	1 1/4	2 1/2	20.0	5 C 70 TB	A-1	2517	2 1/2	1 1/2	1 1/4	2 1/2	23.0
4 C 75 TB	7.50	7.90	A-1	2517	2 1/2	1/2	1 1/4	2 1/2	23.0	5 C 75 TB	A-1	2517	2 1/2	1 1/2	1 1/4	2 1/2	26.0
4 C 80 TB	8.00	8.40	A-1	2517	2 1/2	1/2	1 1/4	2 1/2	25.0	5 C 80 TB	A-1	2517	2 1/2	1 1/2	1 1/4	2 1/2	30.0
4 C 85 TB	8.50	8.90	A-2	2517	2 1/2	1/2	1 1/4	2 1/2	26.0	5 C 85 TB	A-1	2517	2 1/2	1 1/2	1 1/4	2 1/2	34.0
4 C 90 TB	9.00	9.40	A-2	2517	2 1/2	1/2	1 1/4	2 1/2	27.0	5 C 90 TB	A-2	2517	2 1/2	1 1/2	1 1/4	2 1/2	35.0
4 C 95 TB	9.50	9.90	A-2	2517	2 1/2	1/2	1 1/4	2 1/2	36.0	5 C 95 TB	A-2	2517	2 1/2	1 1/2	1 1/4	2 1/2	36.0
4 C 100 TB	10.00	10.40	A-2	2517	2 1/2	1/2	1 1/4	2 1/2	39.0	5 C 100 TB	A-2	2517	2 1/2	1 1/2	1 1/4	2 1/2	39.0
4 C 105 TB	10.50	10.90	A-2	2517	2 1/2	1/2	1 1/4	2 1/2	42.0	5 C 105 TB	A-2	2517	2 1/2	1 1/2	1 1/4	2 1/2	42.0
4 C 110 TB	11.00	11.40	A-2	2517	2 1/2	1/2	1 1/4	2 1/2	45.0	5 C 110 TB	A-2	2517	2 1/2	1 1/2	1 1/4	2 1/2	43.0
4 C 120 TB	12.00	12.40	A-2	2517	3	0	3	1 1/4	47.0	5 C 120 TB	A-2	3030	3	1/2	3	1 1/4	58.0
4 C 130 TB	13.00	13.40	A-3	3030	3	0	3	1 1/4	51.0	5 C 130 TB	A-3	3030	3	1/2	3	1 1/4	63.0
4 C 140 TB	14.00	14.40	A-3	3030	3	0	3	1 1/4	54.0	5 C 140 TB	A-3	3030	3	1/2	3	1 1/4	65.0
4 C 160 TB	16.00	16.40	A-3	3030	3	0	3	1 1/4	71.0	5 C 160 TB	A-3	3030	3	1/2	3	1 1/4	70.0
4 C 180 TB	18.00	18.40	A-3	3030	3	0	3	1 1/4	81.0	5 C 180 TB	A-3	3030	3	1/2	3	1 1/4	83.0
4 C 200 TB	20.00	20.40	A-3	3030	3	0	3	1 1/4	84.0	5 C 200 TB	A-3	3535	3 1/2	0	3 1/2	1 1/4	110.0
4 C 240 TB	24.00	24.40	A-3	3030	3	0	3	1 1/4	116.0	5 C 240 TB	A-3	3535	3 1/2	0	3 1/2	1 1/4	138.0
4 C 300 TB	30.00	30.40	A-3	3535	3 1/2	0	3 1/2	1 1/4	164.0	5 C 300 TB	A-3	3535	3 1/2	0	3 1/2	1 1/4	176.0
4 C 360 TB	36.00	36.40	A-3	3535	3 1/2	0	3 1/2	1 1/4	192.0	5 C 360 TB	A-3	4040	4	1/4	4	1 1/4	244.0
4 C 440 TB	44.00	44.40	A-3	4040	4	0	4	1 1/4	282.0	5 C 440 TB	A-3	4040	4	1/4	4	1 1/4	288.0



Conventional Taper Bushed Sheaves C

Let *Martin* quote your made to order and large quantity requirements.

Dimensions in inches, weight in pounds

6 Groove										8 Groove							
F = 6%										F = 8%							
Part Number	PD	OD	Type	Bush	Bush Max. Bore	E	L Thru Bore	M	Wt. Less Bush	Part Number	Type	Bush	Bush Max. Bore	E	L Thru Bore	M	Wt. Less Bush
	C Belt																
6 C 70 TB	7.00	7.40	A-1	3030	3	1	3	2%	30.0	8 C 80 TB	A-1	3030	3	2	3	3%	45.0
6 C 75 TB	7.50	7.90	A-1	3030	3	1	3	2%	31.0								
6 C 80 TB	8.00	8.40	A-1	3030	3	1	3	2%	35.0								
6 C 85 TB	8.50	8.90	A-1	3030	3	1	3	2%	40.0								
6 C 90 TB	9.00	9.40	A-1	3030	3	1	3	2%	47.0								
6 C 95 TB	9.50	9.90	A-1	3030	3	1	3	2%	53.0	8 C 95 TB	A-1	3535	3½	1½	3½	3%	67.0
6 C 100 TB	10.00	10.40	A-1	3030	3	1	3	2%	57.0	8 C 100 TB	A-1	3535	3½	1½	3½	3%	70.0
6 C 105 TB	10.50	10.90	A-2	3030	3	1	3	2%	58.0	8 C 105 TB	A-1	3535	3½	1½	3½	3%	84.0
6 C 110 TB	11.00	11.40	A-2	3030	3	1	3	2%	66.0	8 C 110 TB	A-1	3535	3½	1½	3½	3%	87.0
6 C 120 TB	12.00	12.40	A-2	3030	3	1	3	2%	70.0	8 C 120 TB	A-2	3535	3½	1½	3½	3%	90.0
6 C 130 TB	13.00	13.40	A-3	3030	3	1	3	2%	75.0	8 C 130 TB	A-2	3535	3½	1½	3½	3%	97.0
6 C 140 TB	14.00	14.40	A-3	3535	3½	½	3½	2%	80.0	8 C 140 TB	A-2	3535	3½	1½	3½	3%	105.0
6 C 160 TB	16.00	16.40	A-3	3535	3½	½	3½	2%	87.0	8 C 160 TB	A-3	3535	3½	1½	3½	3%	115.0
6 C 180 TB	18.00	18.40	A-3	3535	3½	½	3½	2%	102.0	8 C 180 TB	A-3	4040	4	1½	4	2%	137.0
6 C 200 TB	20.00	20.40	A-3	3535	3½	½	3½	2%	126.0	8 C 200 TB	A-3	4040	4	1½	4	2%	180.0
6 C 240 TB	24.00	24.40	A-3	3535	3½	½	3½	2%	150.0	8 C 240 TB	A-3	4040	4	1½	4	2%	205.0
6 C 300 TB	30.00	30.40	A-3	4040	4	1	4	1%	226.0	8 C 300 TB	A-3	4040	4	1½	4	2%	263.0
6 C 360 TB	36.00	36.40	A-3	4040	4	1	4	1%	270.0	8 C 360 TB	A-3	4545	4½	1½	4½	2%	343.0
6 C 440 TB	44.00	44.40	A-3	4040	4	1	4	1%	320.0	8 C 440 TB	A-3	4545	4½	1½	4½	2%	432.0

10 Groove										12 Groove							
F = 10%										F = 12%							
Part Number	PD	OD	Type	Bush	Bush Max. Bore	E	L Thru Bore	M	Wt. Less Bush	Part Number	Type	Bush	Bush Max. Bore	E	L Thru Bore	M	Wt. Less Bush
	C Belt																
10 C 90 TB	9.00	9.40	A-1	4545	4½	1½	4½	4%	57.0	12 C 90 TB	A-1	4040	4	3½	4	4%	65.0
10 C 95 TB	9.50	9.90	A-1	4545	4½	1½	4½	4%	66.0	12 C 95 TB	A-1	4040	4	3½	4	4%	75.0
10 C 100 TB	10.00	10.40	A-1	4545	4½	1½	4½	4%	77.0	12 C 100 TB	A-1	4040	4	3½	4	4%	85.0
10 C 105 TB	10.50	10.90	A-1	4545	4½	1½	4½	4%	87.0	12 C 105 TB	A-1	4040	4	3½	4	4%	95.0
10 C 110 TB	11.00	11.40	A-1	4545	4½	1½	4½	4%	98.0	12 C 110 TB	A-1	4040	4	3½	4	4%	104.0
10 C 120 TB	12.00	12.40	A-1	4545	4½	1½	4½	4%	121.0	12 C 120 TB	A-1	4040	4	3½	4	4%	126.0
10 C 130 TB	13.00	13.40	A-1	4545	4½	2	4½	3%	146.0	12 C 130 TB	A-1	4545	4½	3	4½	4%	156.0
10 C 140 TB	14.00	14.40	A-2	4545	4½	2	4½	3%	173.0	12 C 140 TB	A-1	4545	4½	3	4½	4%	184.0
10 C 160 TB	16.00	16.40	A-2	4545	4½	2	4½	3%	233.0								
10 C 180 TB	18.00	18.40	A-2	4545	4½	2	4½	3%	176.0								
10 C 200 TB	20.00	20.40	A-3	4545	4½	2	4½	3%	201.0								
10 C 240 TB	24.00	24.40	A-3	4545	4½	2	4½	3%	243.0								
10 C 300 TB	30.00	30.40	A-3	4545	4½	2	4½	3%	320.0								
10 C 360 TB	36.00	36.40	A-3	4545	4½	2	4½	3%	464.0								
10 C 440 TB	44.00	44.40	A-3	4545	4½	2	4½	3%	508.0								

Weights do not include bushings. See page B-10-B-12 for additional bushing dimensions.

V-BELT DRIVES

D Conventional Taper Bushed Sheaves



V-BELT DRIVES

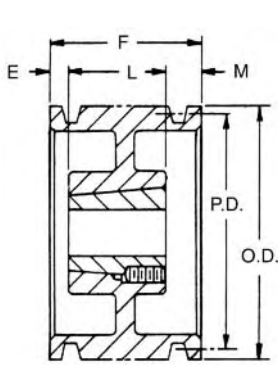

TYPE A

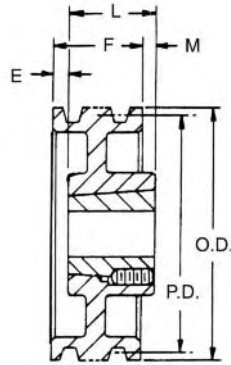

TYPE B

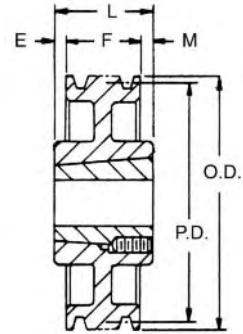

TYPE C



1 = SOLID

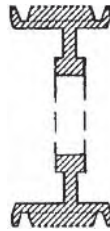

2 = WEB

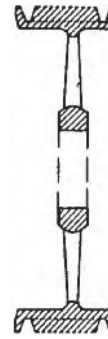

3 = ARM/SPOKE

Dimensions in inches, weight in pounds

4 Groove										5 Groove							
F = 6 1/16										F = 7 1/2							
Part Number	PD	OD	Type	Bush	Bush Max. Bore	E	L Thru Bore	M	Wt. Less Bush	Part Number	Type	Bush	Bush Max. Bore	E	L Thru Bore	M	Wt. Less Bush
	D																
4 D 120 TB	12.0	12.6	A-2	3535	3 1/2	3/8	3 1/2	1 1/16	63.0	5 D 120 TB	A-1	4040	4	3/8	4	2 3/4	82.0
4 D 130 TB	13.0	13.6	A-2	3535	3 1/2	3/8	3 1/2	1 1/16	73.0	5 D 130 TB	A-2	4040	4	3/8	4	2 3/4	87.0
4 D 135 TB	13.5	14.1	A-2	3535	3 1/2	3/8	3 1/2	1 1/16	78.0	5 D 135 TB	A-2	4040	4	3/8	4	2 3/4	92.0
4 D 140 TB	14.0	14.6	A-2	3535	3 1/2	3/8	3 1/2	1 1/16	83.0	5 D 140 TB	A-2	4040	4	3/8	4	2 3/4	97.0
4 D 145 TB	14.5	15.1	A-2	3535	3 1/2	3/8	3 1/2	1 1/16	94.0	5 D 145 TB	A-2	4040	4	3/8	4	2 3/4	102.0
4 D 150 TB	15.0	15.6	A-2	3535	3 1/2	3/8	3 1/2	1 1/16	94.0	5 D 150 TB	A-2	4040	4	3/8	4	2 3/4	107.0
4 D 155 TB	15.5	16.1	A-2	3535	3 1/2	3/8	3 1/2	1 1/16	99.0	5 D 155 TB	A-2	4040	4	3/8	4	2 3/4	112.0
4 D 160 TB	16.0	16.6	A-2	3535	3 1/2	3/8	3 1/2	1 1/16	104.0	5 D 160 TB	A-2	4040	4	3/8	4	2 3/4	112.0
4 D 180 TB	18.0	18.6	A-3	3535	3 1/2	3/8	3 1/2	1 1/16	109.0	5 D 180 TB	A-3	4040	4	1	4	2 1/2	132.0
4 D 220 TB	22.0	22.6	A-3	4040	4	3/8	4	1 1/16	142.0	5 D 220 TB	A-3	4040	4	1	4	2 1/2	162.0
4 D 270 TB	27.0	27.6	A-3	4040	4	3/8	4	1 1/16	182.0	5 D 270 TB	A-3	4040	4	1	4	2 1/2	207.0

Dimensions in inches, weight in pounds

6 Groove										8 Groove							
F = 8 ¹⁵ / ₁₆										F = 11 ¹³ / ₁₆							
Part Number	PD	OD	Type	Bush	Bush Max. Bore	E	L Thru Bore	M	Wt. Less Bush	Part Number	Type	Bush	Bush Max. Bore	E	L Thru Bore	M	Wt. Less Bush
	D																
6 D 120 TB	12.0	12.6	A-1	4040	4	1	4	3 ⁵ / ₁₆	100.0	8 D 120 TB	A-1	4545	4 ¹ / ₂	1/2	4 ¹ / ₂	6 ³ / ₁₆	125.0
6 D 130 TB	13.0	13.6	A-2	4040	4	1 ¹ / ₂	4	3 ³ / ₁₆	100.0	8 D 130 TB	A-1	4545	4 ¹ / ₂	1/2	4 ¹ / ₂	6 ³ / ₁₆	155.0
6 D 135 TB	13.5	14.1	A-2	4040	4	1 ¹ / ₂	4	3 ³ / ₁₆	107.0	8 D 135 TB	A-2	4545	4 ¹ / ₂	1	4 ¹ / ₂	6 ³ / ₁₆	150.0
6 D 140 TB	14.0	14.6	A-2	4040	4	1 ¹ / ₂	4	3 ³ / ₁₆	112.0	8 D 140 TB	A-1	4545	4 ¹ / ₂	1	4 ¹ / ₂	6 ³ / ₁₆	155.0
6 D 145 TB	14.5	15.1	A-2	4040	4	1 ¹ / ₂	4	3 ³ / ₁₆	117.0	8 D 145 TB	A-2	4545	4 ¹ / ₂	2	4 ¹ / ₂	5 ⁵ / ₁₆	155.0
6 D 150 TB	15.0	15.6	A-2	4040	4	1 ¹ / ₂	4	3 ³ / ₁₆	122.0	8 D 150 TB	A-2	4545	4 ¹ / ₂	2	4 ¹ / ₂	5 ⁵ / ₁₆	135.0
6 D 155 TB	15.5	16.1	A-2	4040	4	1 ¹ / ₂	4	3 ³ / ₁₆	127.0	8 D 155 TB	A-2	4545	4 ¹ / ₂	2	4 ¹ / ₂	5 ⁵ / ₁₆	165.0
6 D 160 TB	16.0	16.6	A-2	4040	4	1 ¹ / ₂	4	3 ³ / ₁₆	175.0	8 D 160 TB	A-2	4545	4 ¹ / ₂	2	4 ¹ / ₂	5 ⁵ / ₁₆	165.0
6 D 180 TB	18.0	18.6	A-2	4040	4	1 ¹ / ₂	4	3 ³ / ₁₆	185.0	8 D 180 TB	A-2	4545	4 ¹ / ₂	2 ¹ / ₂	4 ¹ / ₂	4 ⁹ / ₁₆	180.0
6 D 220 TB	22.0	22.6	A-3	4040	4	1 ¹ / ₂	4	3 ³ / ₁₆	210.0	8 D 220 TB	A-3	4545	4 ¹ / ₂	2 ¹ / ₂	4 ¹ / ₂	4 ⁹ / ₁₆	275.0
6 D 270 TB	27.0	27.6	A-3	4545	4 ¹ / ₂	1 ¹ / ₂	4 ¹ / ₂	2 ¹ / ₁₆	260.0	8 D 270 TB	A-3	4545	4 ¹ / ₂	2 ¹ / ₂	4 ¹ / ₂	4 ⁹ / ₁₆	345.0
6 D 330 TB	33.0	33.6	A-3	4545	4 ¹ / ₂	1 ¹ / ₂	4 ¹ / ₂	2 ¹ / ₁₆	340.0	8 D 330 TB	A-3	4545	4 ¹ / ₂	2 ¹ / ₂	4 ¹ / ₂	4 ⁹ / ₁₆	455.0

Dimensions in inches, weight in pounds

10 Groove									
F = 14 ¹¹ / ₁₆									
Part Number	PD	OD	Type	Bush	Bush Max. Bore	E	L Thru Bore	M	Wt. Less Bush
	D								
10 D 120 TB	12.0	12.6	A-1	4545	4 ¹ / ₂	2 ¹ / ₂	4 ¹ / ₂	7 ¹ / ₁₆	140.0
10 D 130 TB	13.0	13.6	A-1	4545	4 ¹ / ₂	2 ¹ / ₂	4 ¹ / ₂	7 ¹ / ₁₆	170.0
10 D 135 TB	13.5	14.1	A-2	4545	4 ¹ / ₂	2 ¹ / ₂	4 ¹ / ₂	7 ¹ / ₁₆	170.0
10 D 140 TB	14.0	14.6	A-2	4545	4 ¹ / ₂	2 ¹ / ₂	4 ¹ / ₂	7 ¹ / ₁₆	175.0
10 D 145 TB	14.5	15.1	A-2	4545	4 ¹ / ₂	2 ¹ / ₂	4 ¹ / ₂	7 ¹ / ₁₆	180.0
10 D 150 TB	15.0	15.6	A-2	4545	4 ¹ / ₂	2 ¹ / ₂	4 ¹ / ₂	7 ¹ / ₁₆	195.0
10 D 155 TB	15.5	16.1	A-2	4545	4 ¹ / ₂	2 ¹ / ₂	4 ¹ / ₂	7 ¹ / ₁₆	175.0
10 D 160 TB	16.0	16.6	A-2	4545	4 ¹ / ₂	2 ¹ / ₂	4 ¹ / ₂	7 ¹ / ₁₆	195.0
10 D 180 TB	18.0	18.6	A-2	4545	4 ¹ / ₂	4	4 ¹ / ₂	6 ¹ / ₁₆	195.0
10 D 220 TB	22.0	22.6	A-3	4545	4 ¹ / ₂	4	4 ¹ / ₂	6 ¹ / ₁₆	340.0
10 D 270 TB	27.0	27.6	A-3	4545	4 ¹ / ₂	4	4 ¹ / ₂	6 ¹ / ₁₆	415.0
10 D 330 TB	33.0	33.6	A-3	4545	4 ¹ / ₂	4 ¹ / ₂	4 ¹ / ₂	5 ¹ / ₁₆	485.0

Weights do not include bushings. See page B-10-B-12 for additional bushing dimensions.

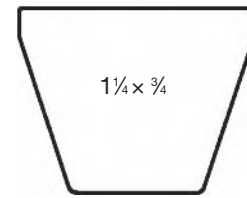

D

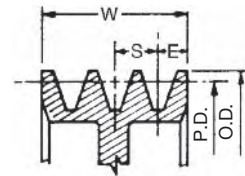

Groove Dimensions

Belt Section	E	S	OD
"D"	3/8	1 ¹ / ₁₆	P.D. + .60

W = S(N-1) + 2E
 N = No. of Grooves

V-BELT DRIVES

Hi-Cap Wedge Groove Dimensions and Tolerances



V-BELT DRIVES

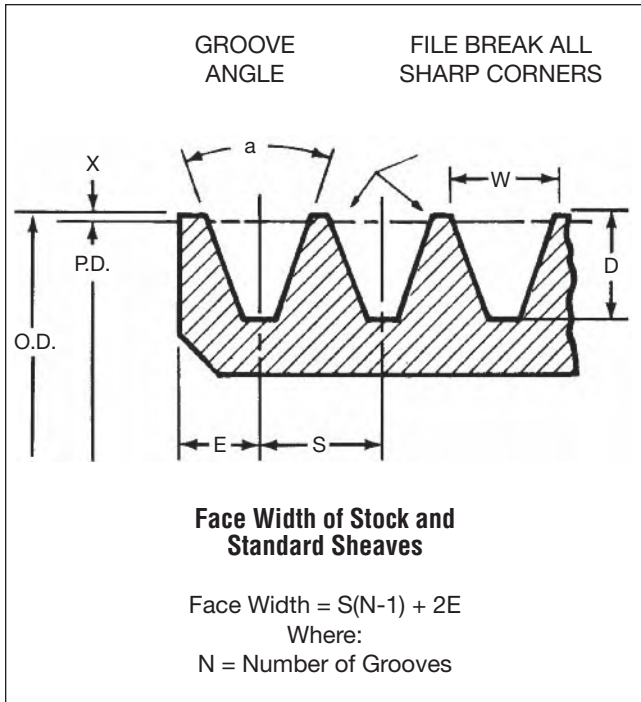

HI-CAP WEDGE SHEAVES TOLERANCES

Outside Diameter	
Under 12.00"	± .005"
12.00" thru 17.99"	+ .010"
18.00" thru 36.00"	± .015"
Over 36.00"	± .020"
Outside Diameter Eccentricity	
Under 9.00"	.008"
9.00" thru 13.99"	.010"
14.00" thru 36.00"	.012"
Over 36.00"	.020"
Side Wobble And Runout	
20.00" O.D. & Under	not to exceed .001" per inch of diameter
Over 20.00" O.D.	.010" plus .0005" per inch of O.D.

Standard Sheaves

Belt	Minimum Recommended Outside Diameter	Outside Effective Diameter	a Groove Angle	Groove Dimensions				
				W	D	X	S	E
3V	2.65	Under 3.5	36°	.350	.350	.025	.407	.344
		3.5 - 6	38°	.350	.350	.025	.407	.344
		6.01 - 12	40°	.350	.350	.025	.407	.344
		Over 12	42°	.350	.350	.025	.407	.344
5V	7.1	Under 10	38°	.600	.600	.050	.688	.500
		10 - 16	40°	.600	.600	.050	.688	.500
		Over 16	42°	.600	.600	.050	.688	.500
8V	12.5	Under 16	38°	1	1	.100	1.125	.750
		16 - 22.4	40°	1	1	.100	1.125	.750
		Over 22.4	42°	1	1	.100	1.125	.750

Dimensions in inches

CONVENTIONAL SHEAVE TOLERANCES

Outside Diameter	
Under 12.00"	± .020"
12.00" thru 23.99"	± .040"
24.00" thru 57.99"	± .060"
58.00" thru 71.99"	± .120"
Over 72.00"	± .250"
Outside Diameter Eccentricity	
Under 10.00" P.D.	.010"
10.01" thru 60.00" P.D.	.010" plus .0005" per inch of P.D.
Over 60.00" P.D.	Add .001" for each add'l inch of P.D.
Side Wobble And Runout	
20.00" P.D. & Under	not to exceed .001" per inch of P.D.
20.00" thru 60.00" P.D.	Add .0005" for each add'l inch of P.D. up to 60.00"
Over 60.00" P.D.	Add .001" for each add'l inch of P.D. above 60.00"

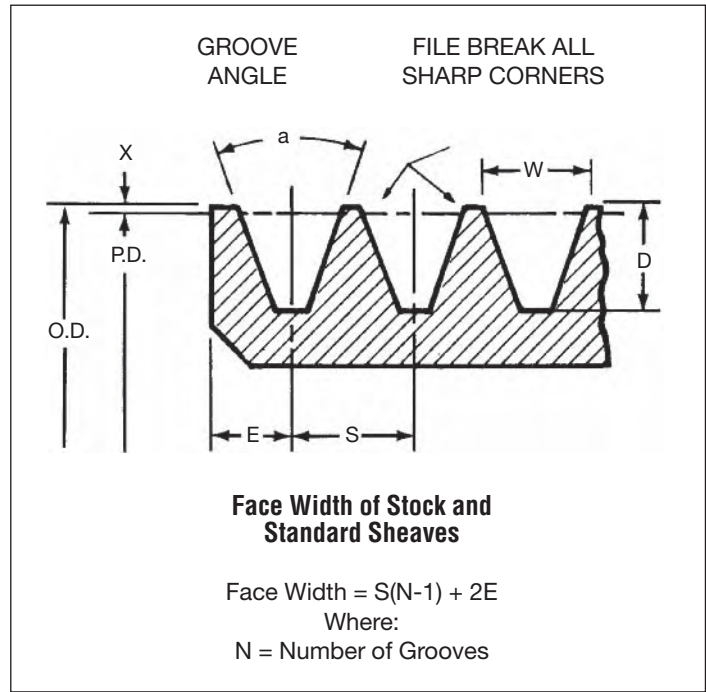

V-BELT DRIVES

Standard Sheaves

Belt	Minimum Recommended Pitch Diameter	P.D. Range	a Groove Angle ± ½°	Groove Dimensions						
				W	D ± .031	X	S* ± .031	E		
A	3.0	2.6 - 5.4 Over 5.4	34° 38°	.494	± .005	.490	.125	.625	.375	+ .070 - .000
				.504						
B	5.4	4.6 - 7.0 Over 7.0	34° 38°	.637	± .005	.580	.175	.750	.500	+ .150 - .000
				.650						
A - B	A 3.0 B 5.4	3.4 - 6.8 Over 6.8	34° 38°	.612	± .005	.625	.175	.750	.500	+ .150 - .000
				.625						
C	9.0	7.0 - 7.99 8.0 - 12.0 Over 12.0	34°	.879	± .007	.780	.200	1	.688	+ .150 - .000
			36°	.887						
			38°	.895						
D	13.0	12.0 - 12.99 13.0 - 17.0 Over 17.0	34°	1.259	± .007	1.050	.300	1.438	.875	+ .250 - .000
			36°	1.271						
			38°	1.283						
E	21.0	18.0 - 24.0 Over 24.0	36°	1.527	± .010	1.300	.400	1.75	1.123	+ .250 - .000
			38°	1.542						

Deep Groove Sheaves

Belt	Minimum Recommended Pitch Diameter	P.D. Range	a Groove Angle ± ½°	Groove Dimensions						
				W	D ± .031	X	S* ± .031	E		
A	3.0	2.6 - 5.4 Over 5.4	34° 38°	.589	± .005	.645	.280	.750	.438	+ .070 - .000
				.611						
B	5.4	4.6 - 7.0 Over 7.0	34° 38°	.747	± .005	.760	.355	.875	.563	+ .150 - .000
				.774						
C	9.0	7.0 - 7.99 8.0 - 12.0 Over 12.0	34°	1.066	± .007	1.085	.505	1.25	.813	+ .150 - .000
			36°	1.085						
			38°	1.105						
D	13.0	12.0 - 12.99 13.0 - 17.0 Over 17.0	34°	1.513	± .007	1.465	.715	1.750	1.063	+ .250 - .000
			36°	1.541						
			38°	1.569						
E	21.0	18.0 - 24.0 Over 24.0	36°	1.816	± .010	1.745	.845	2.063	1.313	+ .250 - .000
			38°	1.849						

Dimensions in inches

*Summation of the deviations from "S" for all grooves in any one sheave shall not exceed ± .063. Available on request, deep groove sheaves are intended for quarter turn drives and for long center vertical shaft drives. They may also be necessary for such applications as car shakers, vibrating screens and certain types of crushers where oscillation in center distance may occur.

V-Belt Drive Selection



V-BELT DRIVES





Stock Drive Selection

To select the best V-Belt Drive for an application, utilizing stock sheaves, simply follow the step by step instructions below:

BEFORE SELECTING A DRIVE, YOU NEED TO KNOW THESE FACTS:

1. The horsepower requirement of the drive.
2. The RPM of the driver.
3. The RPM of the driven machine.
4. The approximate center distance for the drive.
5. Shaft size of both units.
6. Average hours of operation per day.

V-BELT DRIVES

TABLE 1 – SERVICE FACTORS															
<p>THE CORRECT SERVICE FACTOR IS DETERMINED BY:</p> <ol style="list-style-type: none"> 1. The extent and frequency of peak loads. 2. The number of operating hours per year, broken down into average hours per day of continuous service. 3. The proper service category, (intermittent, normal or continuous). Select the one that most closely approximates your application conditions. 			<p>INTERMITTENT SERVICE – SERVICE FACTOR 1.0 TO 1.5</p> <ol style="list-style-type: none"> a. Light Duty – Not more than 6 hours per day. b. Never exceeding rated load. <p>NORMAL SERVICE – SERVICE FACTOR 1.1 TO 1.6</p> <ol style="list-style-type: none"> a. Daily service 6 to 16 hours per day. b. Where occasional starting or peak load does not exceed 200% of the full load. <p>CONTINUOUS SERVICE – SERVICE FACTOR 1.2 TO 1.8</p> <ol style="list-style-type: none"> a. Continuous service 16 to 24 hours per day. b. Where starting or peak load is in excess of 200% of the full load or where starting or peak loads and overloads occur frequently. 												
TYPICAL SERVICE FACTORS															
DRIVEN MACHINE TYPES			DRIVER TYPES												
<p>Driven machine types noted below are representative samples only. Select a category most closely approximating your application from those listed below.</p> <p>IF IDLERS ARE USED, ADD THE FOLLOWING TO THE SERVICE FACTOR:</p> <table border="0"> <tr> <td>Idler on slack side (inside)</td> <td>None</td> </tr> <tr> <td>Idler on slack side (outside)</td> <td>0.1</td> </tr> <tr> <td>Idler on tight side (inside)</td> <td>0.1</td> </tr> <tr> <td>Idler on tight side (outside)</td> <td>0.2</td> </tr> </table>			Idler on slack side (inside)	None	Idler on slack side (outside)	0.1	Idler on tight side (inside)	0.1	Idler on tight side (outside)	0.2	<p>ELECTRIC MOTORS: AC Normal Torque Squirrel Cage and Synchronous AC Split Phase DC Shunt Wound Internal Combustion Engines</p>		<p>ELECTRIC MOTORS: AC Hi-Torque AC Hi-Slip AC Repulsion-Induction AC Single Phase Series Wound AC Slip Ring DC Compound Wound</p>		
			Idler on slack side (inside)	None											
Idler on slack side (outside)	0.1														
Idler on tight side (inside)	0.1														
Idler on tight side (outside)	0.2														
INTERMITTENT SERVICE	NORMAL SERVICE	CONTINUOUS SERVICE	INTERMITTENT SERVICE	NORMAL SERVICE	CONTINUOUS SERVICE										
Agitators for Liquids Blowers and Exhausters Centrifugal Pumps and Compressors Fans up to 10 HP Light Duty Conveyors			1.0	1.1	1.2	1.1	1.2	1.3							
Belt Conveyors For Sand, Grain, etc. Dough Mixers Fans Over 10 HP Generators Line Shafts Laundry Machinery Machine Tools Punches-Presses-Shears Printing Machinery Positive Displacement Rotary Pumps Revolving and Vibrating Screens			1.1	1.2	1.3	1.2	1.3	1.4							
Brick Machinery Bucket Elevators Exciters Piston Compressors Conveyors (Drag-Pan-Screw) Hammer Mills Paper Mill Beaters Piston Pumps Positive Displacement Blowers Pulverizers Saw Mill and Woodworking Machinery Textile Machinery			1.2	1.3	1.4	1.4	1.5	1.6							
Crushers (Gyratory-Jaw-Roll) Mills (Ball-Rod-Tube) Hoists Rubber Calenders-Extruders-Mills			1.3	1.4	1.5	1.5	1.6	1.8							
Chokable Equipment			2.0	2.0	2.0	2.0	2.0	2.0							

FOR A GOOD COMMERCIAL DRIVE SELECTION, USE CONTINUOUS SERVICE FACTOR

Stock Drive Selection



TYPICAL EXAMPLE

1. The driver is a 5 HP, normal torque electric motor.
2. The driver speed is 1750 RPM.
3. A speed reducer for a *Martin* screw conveyor is to be driven at 800 RPM.
4. The desired center distance is 20".
5. The driver shaft diameter is 1 1/2" and the driven shaft diameter is also 1 1/2".
6. The conveyor will operate 18-20 hours per day.

TABLE 2 — HiCap Wedge Cross Section Selection Chart

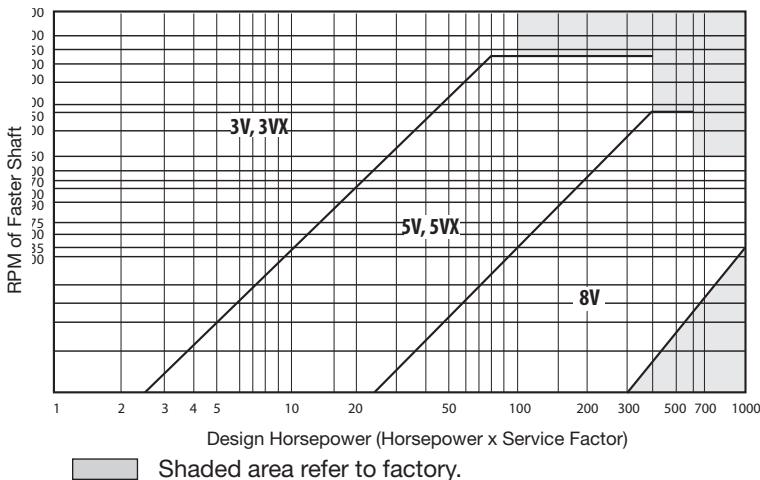

TABLE 3 — Conventional Cross Section Selection

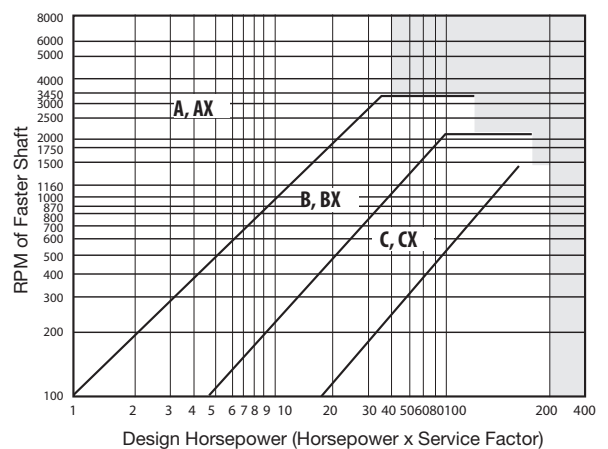

TABLE 4 — Minimum Recommended Sheave Diameters for Electric Motors

MOTOR HORSE-POWER	MOTOR RPM					
	575	695	870	1160	1750	3450
.50	2.50	2.50	2.50	—	—	—
.75	3.00	2.50	2.50	2.50	—	—
1.00	3.00	3.00	2.50	2.50	2.25	—
1.50	3.00	3.00	3.00	2.50	2.50	2.25
2.00	3.75	3.00	3.00	2.50	2.50	2.50
3.00	4.50	3.75	3.00	3.00	2.50	2.50
5.00	4.50	4.50	3.75	3.00	3.00	2.50
7.50	4.25	4.50	4.50	3.75	3.00	3.00
10.00	6.00	5.25	4.50	4.50	3.75	3.00
15.00	6.75	6.00	5.25	4.50	4.50	3.75
20.00	8.25	6.75	6.00	5.25	4.50	4.50
25.00	9.00	8.25	6.75	6.00	4.50	4.50*
* 30.00	10.00	9.00	6.75	6.75	5.25	—
40.00	10.00	10.00	8.25	6.75	6.00	—
50.00	11.00	10.00	9.00	8.25	6.75	—
60.00	12.00	11.00	10.00	9.00	7.50	—
75.00	14.00	13.00	10.00	10.00	9.00	—
100.00	18.00	15.00	13.00	13.00	10.00	—
125.00	20.00	18.00	15.00	13.00	11.00	—
150.00	22.00	20.00	18.00	13.00	—	—
200.00	22.00	22.00	22.00	—	—	—
250.00	22.00	22.00	—	—	—	—
300.00	27.00	27.00	—	—	—	—

*NOTE: Data above the line are from National Electrical Manufacturers Association Standard MG1-3.16 and MG1-3.16A. Data below the line are a composite of Electrical Motor Manufacturers data. They are generally conservative, and specific motors and bearings may permit the use of a smaller motor sheave. Consult the motor manufacturer.

CAUTION

DO NOT USE STOCK SHEAVES ON SUCH EQUIPMENT AS DEBARKERS, WOOD CHIPPERS, CRUSHERS OR OTHER EQUIPMENT SUBJECT TO SEVERE SHOCK LOADS. CONSULT *Martin* FOR RECOMMENDATIONS.

TO DETERMINE THE NEED FOR DYNAMIC BALANCE

This chart shows the maximum speed limit (in RPM) for a standard statically balanced sheave by a given diameter and face width. To exceed this speed limit it is recommended the sheave be dynamically balanced. This information can also be used for pulleys.

STATIC BALANCING – Both stock and Made-to-Order sheaves and pulleys are given a careful static balance for normal speeds. they will operate safely at belt speeds up to 6,500 feet per minute, but at speeds over 5,000 feet per minute and at any speed where vibration is a problem, dynamic balancing is recommended.

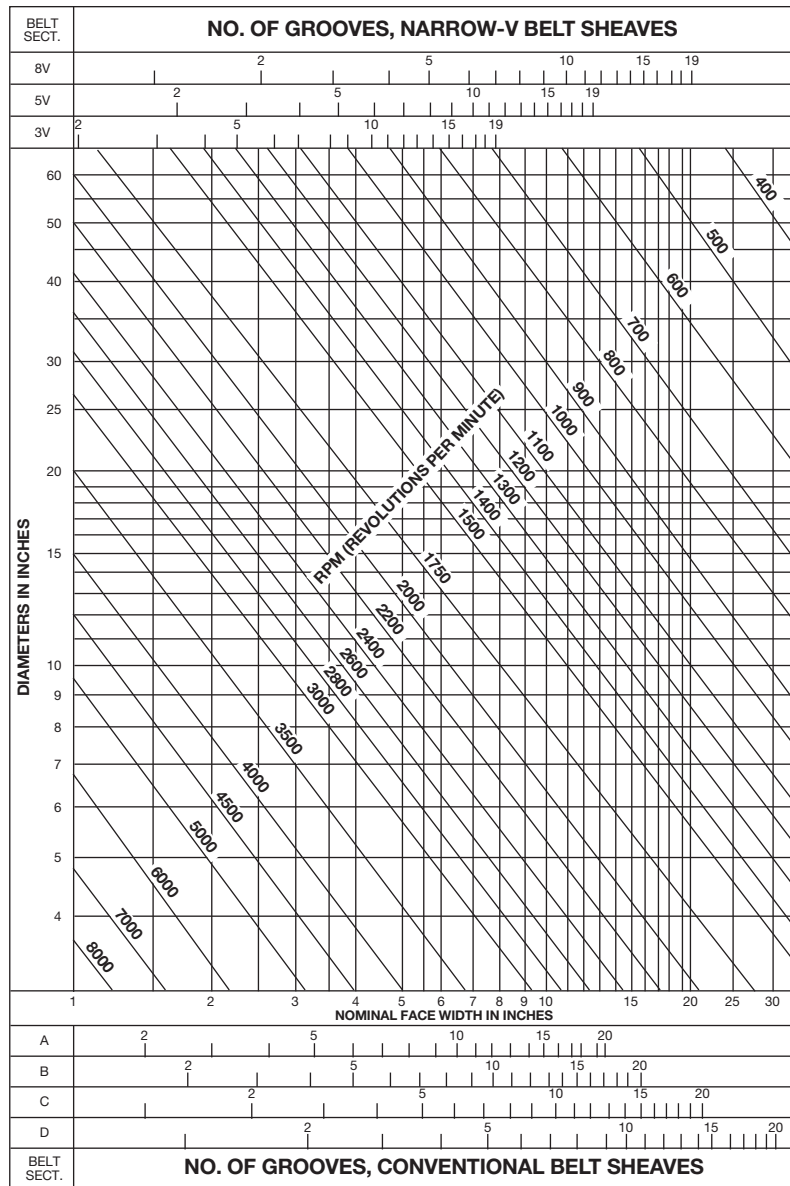

EXAMPLE: A 10" diameter 2" wide sheave or pulley is recommended to be dynamically balanced (balanced in two planes) at 3450 RPM and above. Below 3450 RPM a static balance (balanced in one plane) is sufficient.

WARNING: When belt speeds exceed 6500 feet per minute special materials must be used; consult *Martin* for special design requirements.

STOCK DRIVE SELECTION PROCEDURE

STEP 1. DETERMINE DESIGN HORSEPOWER.

Refer to "Table 1 — Service Factors" Page D-43. Determine proper service (intermittent, normal, or continuous). Find the type of driven machine most similar to your application in the left column. Then to the right, find the driver type to be used and locate the service factor under your proper service selection.

DESIGN HORSEPOWER = HORSEPOWER REQUIREMENT X SERVICE FACTOR

Example: From Table 1 Service Factor 1.4
 HP Requirement x Service Factor = Design HP
 $5 \times 1.4 = 7$ Design HP

STEP 2. DETERMINE PREFERRED BELT CROSS SECTION. The choice of belt selection type (either Hi-Cap Wedge or Conventional) is determined by conditions unique to your specific application. For advantages and disadvantages of belt section type or a recommendation for your specific application, contact your belt manufacturer.

If you have a preferred type, refer to the appropriate chart below. On the horizontal axis of Table 2 or Table 3 below, locate the **Design Horsepower** and read up to the **RPM of the Faster Shaft**. The point at which the lines intersect indicates the **Recommended Belt Cross Section**.

Example: From Table 2 3VX is chosen. (The decision to use Hi-Cap Wedge was arbitrary, conventional could have also been chosen.)

STEP 3. CHECK MINIMUM SMALL (DRIVER) SHEAVE DIAMETER.

Refer to Table 4. Locate intersection of given motor horsepower and speed (rpm) for recommended minimum diameter.
 Example: From Table 4 minimum recommended diameter is 3.00".

STEP 4. SELECT THE DRIVE

- A) Turn to the **Stock Drive Selection Tables** for the applicable belt section.
- B) Find the **RPM of your DriveR**. (Speeds shown are for full load motor ratings.)
- C) Read down the **DriveN speed column** until you reach the speed nearest your desired speed. Under the same column heading you will find the **Horsepower per belt**.
- D) Read across to the left for the required **DriveR and DriveN sheaves**, making sure your DriveR diameter is larger than the minimum shown in Table 4.
- E) Read across to the right for shaft centers nearest to your **Approximate Center Distance**. The belt size is shown at the top of the center distance column.

Example: From Stock Drive Selection tables for 3V belts:

Given: **The DriveR rpm is 1750.**

DriveN speed is 800 rpm.

Therefore: **3.04 is the HP per belt.**

At the far left on the same row, the sheave combination of **3.00" DriveR** and **6.50" DriveN** will provide the desired speeds. (The min. diameter from Table 4 is 3.00".) The nearest shaft centers to the desired 20" provided by a standard belt is **20.5" provided by a 3VX x 560.**

STEP 5. DETERMINE THE NUMBER OF BELTS REQUIRED

To determine the number of belts (thus, the number of grooves) multiply the **horsepower per belt** found in step 4C by the **Arc & Length correction factor** found in the center distance column below the center distance selected. This gives the **corrected or actual horsepower per belt**. Now divide the **Design Horsepower** found in step 1 by the corrected horsepower to determine the number of belts required. (Always round up to the next whole number)

Example: # of Belts Required = $\frac{\text{Design HP}}{\text{Corrected HP}}$

Design HP found in step 1 is **7**, corrected HP is found by: Horsepower per belt (step 4c) x Arc & length correction factor

thus, **corrected HP = $3.04 \times .96 = 2.92$.**

of belts required = $\frac{7}{2.92} = 2.4$

Use 3 belts.

STEP 6. Order *Martin*

- (1) 3 3V 300 SH (driver sheave)
- (1) SH 1 $\frac{5}{8}$ (Bushing)
- (1) 3 3V 650 SDS (driven sheave)
- (1) SDS 1 $\frac{5}{8}$ (Bushing)

(The decision to use QD bushings was arbitrary.)



Stock Drive Selection

V-BELT DRIVES

ALTERNATE EXAMPLE

A 25 horsepower, 1160 RPM squirrel cage normal torque electric motor is to drive a fan 315 RPM. The shaft centers should be about 40". The motor has a 2 1/8" shaft and the fan shaft is 2 1/4". Service is 15 hours per day, constant load.

- 1. Horsepower Requirement of the Drive25 HP
- 2. RPM of DriveR Shaft1160 RPM
- 3. RPM of DriveN Machine315 RPM
- 4. Approximate Center Distance40"

STEP 1 DETERMINE DESIGN HORSEPOWER

From Table 1 Service Factor 1.2
 HP Requirement x Service Factor = Design HP
 25 x 1.2 = 30 Design HP

STEP 2 DETERMINE BELT CROSS SECTION

From Table 3 — B

STEP 3 CHECK MINIMUM SMALL SHEAVE DIAMETER

From Table 4 — 6.75" min.

STEP 4 SELECT THE DRIVE

Locate the Drive Selection Tables
 For B Belts
 RPM of Drive — 1160 RPM
 Driven Speed — HP per Belt
 316 RPM — 8.19 HP per Belt
 Required Driver and Driven Sheave
 (Re-check minimum)
 6.8 Driver
 25.0 Driven (6.75" min.)

NOTE: EQUIPMENT THAT IS SUBJECT TO HEAVY SHOCK LOAD SUCH AS ROCK CRUSHERS OR WOOD CHIP-PERS, USUALLY REQUIRES SPECIAL CONSTRUCTION.

CONSULT FACTORY FOR RECOMMEN-DATIONS.

WARNING: BEFORE USING KEVLAR BELTS, CONSULT FACTORY.

Read across to right for shaft centers nearest required center distance. B-128 = 38.9" centers

Find corrected horsepower by multiplying HP per belt by Arc and Length correction factor. 8.19 x 1.06 = 8.68

Determine number of belts needed by dividing Design HP by corrected HP 30/8.68 = 3.45. Use 4 belts

Order *Martin*

- (1) 4 B 68 TB (Driver Sheave)
- (1) 2517 2 1/8 (Bushing)
- (1) 4 B 250 TB (Driven Sheave)
- (1) 3030 2 1/4 (Bushing)

(The decision to use Taper Bushed Sheaves was arbitrary.)

3V Stock Drive Selection



V-BELT DRIVES

Speed Ratio	Sheave Combination		DriveN Speeds and HP Per Belt								Nominal Center Distance And Arc-Length Correction Factors						
			3500 RPM DriveR		1750 RPM DriveR		1160 RPM DriveR		870 RPM DriveR								
	DriveR O.D.	DriveN O.D.	DriveN RPM	HP Per Belt 3VX	DriveN RPM	HP Per Belt 3VX	DriveN RPM	HP Per Belt 3VX	DriveN RPM	HP Per Belt 3VX	3VX Belt Length Designation						
											250	300	355	400	450	500	560
1.00	2.20	2.20	3500	2.33	1750	1.37	1160	0.98	870	0.77	9.0	11.5	14.3	16.5	19.0	21.5	24.5
1.00	2.35	2.35	3500	2.81	1750	1.63	1160	1.16	870	0.91	8.8	11.3	14.1	16.3	18.8	21.3	24.3
1.00	2.50	2.50	3500	3.30	1750	1.89	1160	1.34	870	1.05	8.6	11.1	13.8	16.1	18.6	21.1	24.1
1.00	2.65	2.65	3500	3.78	1750	2.15	1160	1.52	870	1.18	8.3	10.8	13.6	15.8	18.3	20.8	23.8
1.00	2.80	2.80	3500	4.25	1750	2.41	1160	1.69	870	1.32	8.1	10.6	13.4	15.6	18.1	20.6	23.6
ARC-LENGTH CORRECTION FACTOR											0.83	0.86	0.90	0.92	0.94	0.96	0.98
1.00	3.00	3.00	3500	4.88	1750	2.75	1160	1.93	870	1.50	7.8	10.3	13.0	15.3	17.8	20.3	23.3
1.00	3.15	3.15	3500	5.34	1750	3.01	1160	2.10	870	1.63	7.6	10.1	12.8	15.1	17.6	20.1	23.1
1.00	3.35	3.35	3500	5.96	1750	3.34	1160	2.34	870	1.81	7.2	9.7	12.5	14.7	17.2	19.7	22.7
1.00	3.65	3.65	3500	6.86	1750	3.85	1160	2.68	870	2.08	6.8	9.3	12.0	14.3	16.8	19.3	22.3
1.00	4.12	4.12	3500	8.24	1750	4.63	1160	3.22	870	2.49	6.0	8.5	11.3	13.5	16.0	18.5	21.5
ARC-LENGTH CORRECTION FACTOR											0.83	0.86	0.90	0.92	0.94	0.96	0.98
1.00	4.50	4.50	3500	9.32	1750	5.25	1160	3.65	870	2.82	—	7.9	10.7	12.9	15.4	17.9	20.9
1.00	4.75	4.75	3500	10.01	1750	5.65	1160	3.93	870	3.04	—	7.5	10.3	12.5	15.0	17.5	20.5
1.00	5.00	5.00	3500	10.68	1750	6.06	1160	4.21	870	3.26	—	7.1	9.9	12.1	14.6	17.1	20.1
1.00	5.30	5.30	3500	11.48	1750	6.53	1160	4.55	870	3.51	—	6.7	9.4	11.7	14.2	16.7	19.7
1.00	5.60	5.60	3500	12.25	1750	7.01	1160	4.88	870	3.77	—	—	9.0	11.2	13.7	16.2	19.2
ARC-LENGTH CORRECTION FACTOR											0.0	0.86	0.90	0.92	0.94	0.96	0.98
1.00	6.00	6.00	3500	13.24	1750	7.63	1160	5.32	870	4.11	—	—	8.3	10.6	13.1	15.6	18.6
1.00	6.50	6.50	3500	14.41	1750	8.40	1160	5.87	870	4.53	—	—	—	9.8	12.3	14.8	17.8
1.00	6.90	6.90	3500	15.30	1750	9.01	1160	6.30	870	4.87	—	—	—	9.2	11.7	14.2	17.2
1.00	8.00	8.00	+	+	1750	10.64	1160	7.47	870	5.78	—	—	—	—	9.9	12.4	15.4
1.00	10.60	10.60	+	+	1750	14.22	1160	10.13	870	7.87	—	—	—	—	—	—	—
ARC-LENGTH CORRECTION FACTOR											0.0	0.0	0.90	0.92	0.94	0.96	0.98
1.05	3.00	3.15	3331	5.00	1665	2.81	1140	1.97	828	1.53	7.7	10.2	12.9	15.2	17.7	20.2	23.2
1.05	4.75	5.00	3323	10.13	1662	5.71	1101	3.97	826	3.07	—	7.3	10.1	12.3	14.8	17.3	20.3
1.06	2.50	2.65	3298	3.44	1649	1.96	1093	1.39	820	1.08	8.5	11.0	13.7	16.0	18.5	21.0	24.0
1.06	2.65	2.80	3309	3.92	1655	2.22	1097	1.56	823	1.22	8.2	10.7	13.5	15.7	18.2	20.7	23.7
1.06	3.15	3.35	3288	5.48	1644	3.07	1090	2.15	817	1.67	7.4	9.9	12.6	14.9	17.4	19.9	22.9
ARC-LENGTH CORRECTION FACTOR											0.83	0.86	0.89	0.92	0.94	0.96	0.98
1.06	4.50	4.75	3314	9.45	1657	5.32	1098	3.70	824	2.86	—	7.7	10.5	12.7	15.2	17.7	20.7
1.06	5.00	5.30	3300	10.82	1650	6.12	1094	4.26	820	3.29	—	6.9	9.7	11.9	14.4	16.9	19.9
1.06	5.30	5.60	3311	11.62	1655	6.60	1097	4.59	823	3.55	—	—	9.2	11.4	13.9	16.4	19.4
1.06	6.50	6.90	3296	14.55	1648	8.47	1092	5.91	819	4.57	—	—	—	9.5	12.0	14.5	17.5
1.07	2.20	2.35	3272	2.48	1636	1.45	1084	1.03	813	0.81	8.9	11.4	14.2	16.4	18.9	21.4	24.4
ARC-LENGTH CORRECTION FACTOR											0.83	0.86	0.89	0.92	0.94	0.96	0.98
1.07	2.35	2.50	3286	2.97	1643	1.71	1089	1.21	817	0.95	8.7	11.2	13.9	16.2	18.7	21.2	24.2
1.07	2.80	3.00	3263	4.41	1631	2.49	1081	1.75	811	1.36	7.9	10.4	13.2	15.4	17.9	20.4	23.4
1.07	5.60	6.00	3265	12.40	1632	7.09	1082	4.93	812	3.81	—	—	8.6	10.9	13.4	15.9	18.9
1.08	6.00	6.50	3229	13.41	1614	7.72	1070	5.38	803	4.15	—	—	7.9	10.2	12.7	15.2	18.2
1.09	3.35	3.65	3208	6.15	1604	3.44	1063	2.40	797	1.86	7.0	9.5	12.3	14.5	17.0	19.5	22.5
ARC-LENGTH CORRECTION FACTOR											0.83	0.86	0.90	0.92	0.94	0.96	0.98
1.09	4.12	4.50	3201	8.43	1601	4.72	1061	3.29	796	2.54	5.7	8.2	11.0	13.2	15.7	18.2	21.2
1.11	4.50	5.00	3146	9.54	1573	5.36	1043	3.73	782	2.88	—	7.5	10.3	12.5	15.0	17.5	20.5
1.12	2.50	2.80	3118	3.54	1559	2.01	1033	1.42	775	1.11	8.3	10.8	13.6	15.8	18.3	20.8	23.8
1.12	3.00	3.35	3129	5.12	1564	2.87	1037	2.01	778	1.56	7.5	10.0	12.8	15.0	17.5	20.0	23.0
1.12	4.75	5.30	3133	10.25	1567	5.77	1038	4.01	779	3.10	—	7.1	9.9	12.1	14.6	17.1	20.1
ARC-LENGTH CORRECTION FACTOR											0.82	0.86	0.89	0.92	0.94	0.96	0.98
1.12	5.00	5.60	3122	10.93	1561	6.18	1035	4.29	776	3.32	—	6.7	9.4	11.7	14.2	16.7	19.7
1.13	2.35	2.65	3096	3.07	1548	1.76	1026	1.25	770	0.97	8.6	11.1	13.8	16.1	18.6	21.1	24.1
1.13	2.65	3.00	3085	4.03	1542	2.28	1022	1.60	767	1.25	8.1	10.6	13.3	15.6	18.1	20.6	23.6
1.13	2.80	3.15	3105	4.51	1552	2.54	1029	1.78	772	1.38	7.8	10.3	13.1	15.3	17.8	20.3	23.3
1.13	3.65	4.12	3096	7.12	1548	3.97	1026	2.77	770	2.14	6.4	8.9	11.6	13.9	16.4	18.9	21.9
ARC-LENGTH CORRECTION FACTOR											0.83	0.86	0.89	0.92	0.94	0.96	0.98
1.13	5.30	6.00	3088	11.73	1544	6.66	1024	4.63	768	3.58	—	—	8.9	11.1	13.6	16.1	19.1
1.14	2.20	2.50	3071	2.60	1536	1.50	1018	1.07	763	0.84	8.8	11.3	14.1	16.3	18.8	21.3	24.3
1.15	4.12	4.75	3031	8.52	1515	4.77	1005	3.32	753	2.56	—	8.0	10.8	13.0	15.5	18.0	21.0
1.15	6.00	6.90	3040	13.52	1520	7.78	1008	5.41	756	4.18	—	—	—	9.9	12.4	14.9	17.9
1.16	3.15	3.65	3014	5.64	1507	3.15	999	2.20	749	1.71	7.2	9.7	12.4	14.7	17.2	19.7	22.7
ARC-LENGTH CORRECTION FACTOR											0.83	0.86	0.89	0.92	0.94	0.96	0.98

3VX = COGGED/NOTCHED V-BELT VALUES ARE GIVEN FOR 3VX ONLY DUE TO GENERAL INDUSTRY TRENDS.

+ IF RIM SPEED EXCEEDS 6500 FEET PER MINUTE, CONSULT *Martin*.





Stock Drive Selection 3V

V-BELT DRIVES

Nominal Center Distances And Arc-Length Correction Factor															Sheave Combination		Speed Ratio
3VX Belt Length Designation															DriveR O. D.	DriveN O. D.	
600	630	670	710	800	850	900	950	1000	1060	1120	1180	1250	1320	1400			
26.5	28.0	30.0	32.0	36.5	39.0	41.5	44.0	46.5	49.5	52.5	55.5	59.0	62.5	66.5	2.20	2.20	1.00
26.3	27.8	29.8	31.8	36.3	38.8	41.3	43.8	46.3	49.3	52.3	55.3	58.8	62.3	66.3	2.35	2.35	1.00
26.1	27.6	29.6	31.6	36.1	38.6	41.1	43.6	46.1	49.1	52.1	55.1	58.6	62.1	66.1	2.50	2.50	1.00
25.8	27.3	29.3	31.3	35.8	38.3	40.8	43.3	45.8	48.8	51.8	54.8	58.3	61.8	65.8	2.65	2.65	1.00
25.6	27.1	29.1	31.1	35.6	38.1	40.6	43.1	45.6	48.6	51.6	54.6	58.1	61.6	65.6	2.80	2.80	1.00
0.99	1.00	1.01	1.02	1.04	1.05	1.07	1.08	1.08	1.10	1.11	1.11	1.13	1.14	1.15			
25.3	26.8	28.8	30.8	35.3	37.8	40.3	42.8	45.3	48.3	51.3	54.3	57.8	61.3	65.3	3.00	3.00	1.00
25.1	26.6	28.6	30.6	35.1	37.6	40.1	42.6	45.1	48.1	51.1	54.1	57.6	61.1	65.1	3.15	3.15	1.00
24.7	26.2	28.2	30.2	34.7	37.2	39.7	42.2	44.7	47.7	50.7	53.7	57.2	60.7	64.7	3.35	3.35	1.00
24.3	25.8	27.8	29.8	34.3	36.8	39.3	41.8	44.3	47.3	50.3	53.3	56.8	60.3	64.3	3.65	3.65	1.00
23.5	25.0	27.0	29.0	33.5	36.0	38.5	41.0	43.5	46.5	49.5	52.5	56.0	59.5	63.5	4.12	4.12	1.00
0.99	1.00	1.01	1.02	1.04	1.05	1.07	1.08	1.08	1.10	1.11	1.11	1.13	1.14	1.15			
22.9	24.4	26.4	28.4	32.9	35.4	37.9	40.4	42.9	45.9	48.9	51.9	55.4	58.9	62.9	4.50	4.50	1.00
22.5	24.0	26.0	28.0	32.5	35.0	37.5	40.0	42.5	45.5	48.5	51.5	55.0	58.5	62.5	4.75	4.75	1.00
22.1	23.6	25.6	27.6	32.1	34.6	37.1	39.6	42.1	45.1	48.1	51.1	54.6	58.1	62.1	5.00	5.00	1.00
21.7	23.2	25.2	27.2	31.7	34.2	36.7	39.2	41.7	44.7	47.7	50.7	54.2	57.7	61.7	5.30	5.30	1.00
21.2	22.7	24.7	26.7	31.2	33.7	36.2	38.7	41.2	44.2	47.2	50.2	53.7	57.2	61.2	5.60	5.60	1.00
0.99	1.00	1.01	1.02	1.04	1.05	1.07	1.08	1.08	1.10	1.11	1.11	1.13	1.14	1.15			
20.6	22.1	24.1	26.1	30.6	33.1	35.6	38.1	40.6	43.6	46.6	49.6	53.1	56.6	60.6	6.00	6.00	1.00
19.8	21.3	23.3	25.3	29.8	32.3	34.8	37.3	39.8	42.8	45.8	48.8	52.3	55.8	59.8	6.50	6.50	1.00
19.2	20.7	22.7	24.7	29.2	31.7	34.2	36.7	39.2	42.2	45.2	48.2	51.7	55.2	59.2	6.90	6.90	1.00
17.4	18.9	20.9	22.9	27.4	29.9	32.4	34.9	37.4	40.4	43.4	46.4	49.9	53.4	57.4	8.00	8.00	1.00
13.3	14.8	16.8	18.8	23.3	25.8	28.3	30.8	33.3	36.3	39.3	42.3	45.8	49.3	53.3	10.60	10.60	1.00
0.99	1.00	1.01	1.02	1.04	1.05	1.07	1.08	1.08	1.10	1.11	1.11	1.13	1.14	1.15			
25.2	26.7	28.7	30.7	35.2	37.7	40.2	42.7	45.2	48.2	51.2	54.2	57.7	61.2	65.2	3.00	3.15	1.05
22.3	23.8	25.8	27.8	32.3	34.8	37.3	39.8	42.3	45.3	48.3	51.3	54.8	58.3	62.3	4.75	5.00	1.05
26.0	27.5	29.5	31.5	36.0	38.5	41.0	43.5	46.0	49.0	52.0	55.0	58.5	62.0	66.0	2.50	2.65	1.06
25.7	27.2	29.2	31.2	35.7	38.2	40.7	43.2	45.7	48.7	51.7	54.7	58.2	61.7	65.7	2.65	2.80	1.06
24.9	26.4	28.4	30.4	34.9	37.4	39.9	42.4	44.9	47.9	50.9	53.9	57.4	60.9	64.9	3.15	3.35	1.06
0.99	1.00	1.01	1.02	1.04	1.05	1.07	1.08	1.08	1.10	1.11	1.11	1.13	1.14	1.15			
22.7	24.2	26.2	28.2	32.7	35.2	37.7	40.2	42.7	45.7	48.7	51.7	55.2	58.7	62.7	4.50	4.75	1.06
21.9	23.4	25.4	27.4	31.9	34.4	36.9	39.4	41.9	44.9	47.9	50.9	54.4	57.9	61.9	5.00	5.30	1.06
21.4	22.9	24.9	26.9	31.4	33.9	36.4	38.9	41.4	44.4	47.4	50.4	53.9	57.4	61.4	5.30	5.60	1.06
19.5	21.0	23.0	25.0	29.5	32.0	34.5	37.0	39.5	42.5	45.5	48.5	52.0	55.5	59.5	6.50	6.90	1.06
26.4	27.9	29.9	31.9	36.4	38.9	41.4	43.9	46.4	49.4	52.4	55.4	58.9	62.4	66.4	2.20	2.35	1.07
0.99	1.00	1.01	1.02	1.04	1.05	1.07	1.08	1.08	1.10	1.11	1.11	1.13	1.14	1.15			
26.2	27.7	29.7	31.7	36.2	38.7	41.2	43.7	46.2	49.2	52.2	55.2	58.7	62.2	66.2	2.35	2.50	1.07
25.4	26.9	28.9	30.9	35.4	37.9	40.4	42.9	45.4	48.4	51.4	54.4	57.9	61.4	65.4	2.80	3.00	1.07
20.9	22.4	24.4	26.4	30.9	33.4	35.9	38.4	40.9	43.9	46.9	49.9	53.4	56.9	60.9	5.60	6.00	1.07
20.2	21.7	23.7	25.7	30.2	32.7	35.2	37.7	40.2	43.2	46.2	49.2	52.7	56.2	60.2	6.00	6.50	1.08
24.5	26.0	28.0	30.0	34.5	37.0	39.5	42.0	44.5	47.5	50.5	53.5	57.0	60.5	64.5	3.35	3.65	1.09
0.99	1.00	1.01	1.02	1.04	1.05	1.07	1.08	1.08	1.10	1.11	1.11	1.13	1.14	1.15			
23.2	24.7	26.7	28.7	33.2	35.7	38.2	40.7	43.2	46.2	49.2	52.2	55.7	59.2	63.2	4.12	4.50	1.09
22.5	24.0	26.0	28.0	32.5	35.0	37.5	40.0	42.5	45.5	48.5	51.5	55.0	58.5	62.5	4.50	5.00	1.11
25.8	27.3	29.3	31.3	35.8	38.3	40.8	43.3	45.8	48.8	51.8	54.8	58.3	61.8	65.8	2.50	2.80	1.12
25.0	26.5	28.5	30.5	35.0	37.5	40.0	42.5	45.0	48.0	51.0	54.0	57.5	61.0	65.0	3.00	3.35	1.12
22.1	23.6	25.6	27.6	32.1	34.6	37.1	39.6	42.1	45.1	48.1	51.1	54.6	58.1	62.1	4.75	5.30	1.12
0.99	1.00	1.01	1.02	1.04	1.05	1.07	1.08	1.08	1.10	1.11	1.11	1.13	1.14	1.15			
21.7	23.2	25.2	27.2	31.7	34.2	36.7	39.2	41.7	44.7	47.7	50.7	54.2	57.7	61.7	5.00	5.60	1.12
26.1	27.6	29.6	31.6	36.1	38.6	41.1	43.6	46.1	49.1	52.1	55.1	58.6	62.1	66.1	2.35	2.65	1.13
25.6	27.1	29.1	31.1	35.6	38.1	40.6	43.1	45.6	48.6	51.6	54.6	58.1	61.6	65.6	2.65	3.00	1.13
25.3	26.8	28.8	30.8	35.3	37.8	40.3	42.8	45.3	48.3	51.3	54.3	57.8	61.3	65.3	2.80	3.15	1.13
23.9	25.4	27.4	29.4	33.9	36.4	38.9	41.4	43.9	46.9	49.9	52.9	56.4	59.9	63.9	3.65	4.12	1.13
0.99	1.00	1.01	1.02	1.04	1.05	1.07	1.08	1.08	1.10	1.11	1.11	1.13	1.14	1.15			
21.1	22.6	24.6	26.6	31.1	33.6	36.1	38.6	41.1	44.1	47.1	50.1	53.6	57.1	61.1	5.30	6.00	1.13
26.3	27.8	29.8	31.8	36.3	38.8	41.3	43.8	46.3	49.3	52.3	55.3	58.8	62.3	66.3	2.20	2.50	1.14
23.0	24.5	26.5	28.5	33.0	35.5	38.0	40.5	43.0	46.0	49.0	52.0	55.5	59.0	63.0	4.12	4.75	1.15
19.9	21.4	23.4	25.4	29.9	32.4	34.9	37.4	39.9	42.9	45.9	48.9	52.4	55.9	59.9	6.00	6.90	1.15
24.7	26.2	28.2	30.2	34.7	37.2	39.7	42.2	44.7	47.7	50.7	53.7	57.2	60.7	64.7	3.15	3.65	1.16
0.99	1.00	1.01	1.02	1.04	1.05	1.07	1.08	1.08	1.10	1.11	1.11	1.13	1.14	1.15			

FOR BELT SIZES NOT SHOWN INTERPOLATE FOR ADDITIONAL CENTER DISTANCE.

3VX = COGGED/NOTCHED V-BELT VALUES ARE GIVEN FOR 3VX ONLY DUE TO GENERAL INDUSTRY TRENDS.

+ IF RIM SPEED EXCEEDS 6500 FEET PER MINUTE, CONSULT *Martin*.



3V Stock Drive Selection



V-BELT DRIVES

Speed Ratio	Sheave Combination		DriveN Speeds and HP Per Belt								Nominal Center Distance And Arc-Length Correction Factors						
			3500 RPM DriveR		1750 RPM DriveR		1160 RPM DriveR		870 RPM DriveR								
	DriveR O.D.	DriveN O.D.	DriveN RPM	HP Per Belt 3VX	DriveN RPM	HP Per Belt 3VX	DriveN RPM	HP Per Belt 3VX	DriveN RPM	HP Per Belt 3VX	3VX Belt Length Designation						
											250	300	355	400	450	500	560
1.16	5.60	6.50	3012	12.54	1506	7.16	998	4.98	749	3.84	—	—	8.2	10.5	13.0	15.5	18.5
1.16	6.90	8.00	3016	15.59	1508	9.16	999	6.40	750	4.94	—	—	—	—	10.8	13.3	16.3
1.18	4.50	5.30	2967	9.63	1483	5.41	983	3.76	737	2.90	—	7.3	10.0	12.3	14.8	17.3	20.3
1.18	4.75	5.60	2964	10.33	1482	5.81	982	4.04	737	3.12	—	6.9	9.6	11.9	14.4	16.9	19.9
1.19	2.65	3.15	2935	4.11	1468	2.32	973	1.63	730	1.27	7.9	10.4	13.2	15.4	17.9	20.4	23.4
ARC-LENGTH CORRECTION FACTOR											0.82	0.86	0.89	0.91	0.94	0.95	0.98
1.20	2.35	2.80	2927	3.15	1464	1.80	970	1.27	728	1.00	8.5	11.0	13.7	16.0	18.5	21.0	24.0
1.20	2.50	3.00	2907	3.64	1453	2.06	963	1.45	723	1.13	8.2	10.7	13.4	15.7	18.2	20.7	23.7
1.20	2.80	3.35	2917	4.59	1458	2.58	967	1.81	725	1.40	7.7	10.2	12.9	15.2	17.7	20.2	23.2
1.20	5.00	6.00	2912	11.02	1456	6.22	965	4.33	724	3.34	—	—	9.1	11.3	13.9	16.4	19.4
1.21	2.20	2.65	2894	2.68	1447	1.54	959	1.10	719	0.86	8.7	11.2	13.9	16.2	18.7	21.2	24.2
ARC-LENGTH CORRECTION FACTOR											0.83	0.86	0.89	0.91	0.94	0.96	0.98
1.22	3.00	3.65	2868	5.24	1434	2.93	951	2.05	713	1.59	7.3	9.8	12.5	14.8	17.3	19.8	22.8
1.22	4.12	5.00	2878	8.60	1439	4.81	954	3.34	715	2.58	—	7.8	10.6	12.8	15.3	17.8	20.8
1.23	3.35	4.12	2838	6.32	1419	3.53	941	2.46	705	1.90	6.6	9.1	11.9	14.1	16.6	19.1	22.1
1.23	5.30	6.50	2849	11.84	1424	6.72	944	4.67	708	3.61	—	—	8.5	10.7	13.2	15.7	18.7
1.23	5.60	6.90	2836	12.61	1418	7.19	940	5.00	705	3.86	—	—	7.9	10.2	12.7	15.2	18.2
ARC-LENGTH CORRECTION FACTOR											0.82	0.86	0.89	0.91	0.93	0.95	0.97
1.23	6.50	8.00	2840	14.78	1420	8.59	941	5.99	706	4.62	—	—	—	8.6	11.1	13.6	16.6
1.24	3.65	4.50	2831	7.24	1416	4.03	938	2.81	704	2.17	6.1	8.6	11.3	13.6	16.1	18.6	21.6
1.25	4.50	5.60	2806	9.70	1403	5.44	930	3.78	698	2.92	—	7.0	9.8	12.1	14.6	17.1	20.1
1.27	2.50	3.15	2766	3.70	1383	2.09	917	1.47	688	1.15	8.1	10.6	13.3	15.6	18.1	20.6	23.6
1.27	2.65	3.35	2758	4.18	1379	2.35	914	1.65	685	1.28	7.8	10.3	13.0	15.3	17.8	20.3	23.3
ARC-LENGTH CORRECTION FACTOR											0.82	0.85	0.89	0.91	0.93	0.95	0.98
1.27	4.75	6.00	2765	10.41	1382	5.85	916	4.07	687	3.14	—	—	9.3	11.5	14.0	16.5	19.5
1.28	2.20	2.80	2736	2.73	1368	1.57	907	1.12	680	0.87	8.6	11.1	13.8	16.1	18.6	21.1	24.1
1.28	2.35	3.00	2729	3.22	1364	1.83	904	1.30	678	1.01	8.3	10.8	13.5	15.8	18.3	20.8	23.8
1.29	4.12	5.30	2713	8.65	1357	4.83	899	3.36	674	2.59	—	7.6	10.3	12.6	15.1	17.6	20.6
1.30	5.00	6.50	2686	11.10	1343	6.27	890	4.35	668	3.36	—	—	8.7	10.9	13.4	16.0	19.0
ARC-LENGTH CORRECTION FACTOR											0.82	0.86	0.89	0.91	0.93	0.95	0.98
1.30	5.30	6.90	2682	11.90	1341	6.74	889	4.69	667	3.62	—	—	8.1	10.4	12.9	15.4	18.4
1.31	2.80	3.65	2674	4.68	1337	2.62	886	1.83	665	1.43	7.4	9.9	12.7	14.9	17.4	19.9	22.9
1.31	3.15	4.12	2666	5.77	1333	3.22	884	2.24	663	1.74	6.8	9.3	12.0	14.3	16.8	19.3	22.3
1.31	3.65	4.75	2681	7.29	1340	4.06	889	2.82	666	2.18	5.9	8.4	11.1	13.4	15.9	18.4	21.4
1.32	10.60	14.00	+	+	1323	14.43	877	10.27	658	7.98	—	—	—	—	—	—	—
ARC-LENGTH CORRECTION FACTOR											0.82	0.86	0.89	0.91	0.93	0.95	0.97
1.33	8.00	10.60	+	+	1319	10.86	874	7.61	656	5.89	—	—	—	—	—	—	13.3
1.34	4.50	6.00	2618	9.76	1309	5.47	868	3.80	651	2.93	—	6.7	9.5	11.7	14.2	16.7	19.7
1.34	6.00	8.00	2619	13.68	1310	7.86	868	5.47	651	4.22	—	—	—	8.9	11.5	14.0	17.0
1.35	2.35	3.15	2597	3.26	1298	1.85	861	1.31	645	1.02	8.2	10.7	13.4	15.7	18.2	20.7	23.7
1.35	2.50	3.35	2598	3.75	1299	2.12	861	1.49	646	1.16	7.9	10.4	13.1	15.4	17.9	20.4	23.4
ARC-LENGTH CORRECTION FACTOR											0.82	0.86	0.89	0.91	0.93	0.95	0.97
1.35	3.35	4.50	2596	6.40	1298	3.57	860	2.48	645	1.92	6.3	8.8	11.6	13.8	16.3	18.8	21.8
1.36	4.12	5.60	2567	8.69	1283	4.85	851	3.37	638	2.60	—	7.3	10.1	12.3	14.8	17.4	20.4
1.37	2.20	3.00	2551	2.78	1275	1.60	845	1.13	634	0.89	8.4	10.9	13.7	15.9	18.4	20.9	23.9
1.37	3.65	5.00	2545	7.32	1273	4.08	844	2.83	633	2.19	5.7	8.2	10.9	13.2	15.7	18.2	21.2
1.37	4.75	6.50	2550	10.47	1275	5.88	845	4.09	634	3.15	—	—	8.9	11.1	13.6	16.1	19.1
ARC-LENGTH CORRECTION FACTOR											0.81	0.84	0.88	0.91	0.91	0.93	0.97
1.38	2.65	3.65	2528	4.24	1264	2.38	838	1.67	628	1.30	7.5	10.0	12.8	15.0	17.5	20.0	23.0
1.38	3.00	4.12	2537	5.34	1268	2.98	841	2.08	631	1.61	6.9	9.4	12.1	14.4	16.9	19.4	22.4
1.38	5.00	6.90	2529	11.15	1229	6.29	838	4.37	629	3.37	—	—	8.3	10.6	13.1	15.6	18.6
1.42	3.35	4.75	2457	6.44	1229	3.58	814	2.50	611	1.93	6.1	8.6	11.4	13.6	16.1	18.6	21.6
1.43	2.35	3.35	2439	3.30	1220	1.87	808	1.32	606	1.03	8.0	10.5	13.3	15.5	18.0	20.5	23.5
ARC-LENGTH CORRECTION FACTOR											0.82	0.85	0.89	0.91	0.91	0.95	0.97
1.43	5.60	8.00	2443	12.73	1222	7.25	810	5.04	607	3.89	—	—	—	9.2	11.8	14.3	17.3
1.44	2.20	3.15	2427	2.81	1214	1.61	805	1.14	603	0.89	8.3	10.8	13.5	15.8	18.3	20.8	23.8
1.44	3.15	4.50	2438	5.38	1219	3.25	808	2.27	606	1.75	6.5	9.0	11.7	14.0	16.5	19.0	22.0
1.45	4.50	6.50	2415	9.81	1207	5.49	800	3.82	600	2.95	—	—	9.1	11.3	13.8	16.3	19.3
1.46	3.65	5.30	2400	7.35	1200	4.09	795	2.85	597	2.20	—	7.9	10.7	12.9	15.4	18.0	21.0
ARC-LENGTH CORRECTION FACTOR											0.82	0.85	0.89	0.91	0.93	0.95	0.97

3VX = COGGED/NOTCHED V-BELT VALUES ARE GIVEN FOR 3VX ONLY DUE TO GENERAL INDUSTRY TRENDS.

+ IF RIM SPEED EXCEEDS 6500 FEET PER MINUTE, CONSULT *Martin*.





Stock Drive 3V Selection

Nominal Center Distances And Arc-Length Correction Factor															Sheave Combination		Speed Ratio
3VX Belt Length Designation															DriveR O. D.	DriveN O. D.	
600	630	670	710	800	850	900	950	1000	1060	1120	1180	1250	1320	1400			
20.5	22.0	24.0	26.0	30.5	33.0	35.5	38.0	40.5	43.5	46.5	49.5	53.0	56.5	60.5	5.60	6.50	1.16
18.3	19.8	21.8	23.8	28.3	30.8	33.3	35.8	38.3	41.3	44.3	47.3	50.8	54.3	58.3	6.90	8.00	1.16
22.3	23.8	25.8	27.8	32.3	34.8	37.3	39.8	42.3	45.3	48.3	51.3	54.8	58.3	62.3	4.50	5.30	1.18
21.9	23.4	25.4	27.4	31.9	34.4	36.9	39.4	41.9	44.9	47.9	50.9	54.4	57.9	61.9	4.75	5.60	1.18
25.4	26.9	28.9	30.9	35.4	37.9	40.4	42.9	45.4	48.4	51.4	54.4	57.9	61.4	65.4	2.65	3.15	1.19
0.99	1.00	1.01	1.02	1.04	1.05	1.06	1.07	1.08	1.09	1.10	1.11	1.12	1.13	1.14			
26.0	27.5	29.5	31.5	36.0	38.5	41.0	43.5	46.0	49.0	52.0	55.0	58.5	62.0	66.0	2.35	2.80	1.20
25.7	27.2	29.2	31.2	35.7	38.2	40.7	43.2	45.7	48.7	51.7	54.7	58.2	61.7	65.7	2.50	3.00	1.20
25.2	26.7	28.7	30.7	35.2	37.7	40.2	42.7	45.2	48.2	51.2	54.2	57.7	61.2	65.2	2.80	3.35	1.20
21.4	22.9	24.9	26.9	31.4	33.9	36.4	38.9	41.4	44.4	47.4	50.4	53.9	57.4	61.4	5.00	6.00	1.20
26.2	27.7	29.7	31.7	36.2	38.7	41.2	43.7	46.2	49.2	52.2	55.2	58.7	62.2	66.2	2.20	2.65	1.21
0.99	1.00	1.01	1.02	1.04	1.05	1.06	1.07	1.08	1.09	1.10	1.11	1.12	1.13	1.14			
24.8	26.3	28.3	30.3	34.8	37.3	39.8	42.3	44.8	47.8	50.8	53.8	57.3	60.8	64.8	3.00	3.65	1.22
22.8	24.8	26.3	28.3	32.8	35.3	37.8	40.3	42.8	45.8	48.8	51.8	55.3	58.8	62.8	4.12	5.00	1.22
24.1	25.6	27.6	29.6	34.1	36.6	39.1	41.6	44.1	47.1	50.1	53.1	56.6	60.1	64.1	3.35	4.12	1.23
20.7	22.2	24.2	26.2	30.7	33.2	35.7	38.2	40.7	43.7	46.7	49.7	53.2	56.7	60.7	5.30	6.50	1.23
20.2	21.7	23.7	25.7	30.2	32.7	35.2	37.7	40.2	43.2	46.2	49.2	52.7	56.2	60.2	5.60	6.90	1.23
0.99	1.00	1.01	1.02	1.04	1.05	1.06	1.07	1.08	1.09	1.10	1.11	1.12	1.13	1.14			
18.6	20.1	22.1	24.1	28.6	31.1	33.6	36.1	38.6	41.6	44.6	47.6	51.1	54.6	58.6	6.50	8.00	1.23
23.6	25.1	27.1	29.1	33.6	36.1	38.6	41.1	43.6	46.6	49.6	52.6	56.1	59.6	63.6	3.65	4.50	1.24
22.1	23.6	25.6	27.6	32.1	34.6	37.1	39.6	42.1	45.1	48.1	51.1	54.6	58.1	62.1	4.50	5.60	1.25
25.6	27.1	29.1	31.1	35.6	38.1	40.6	43.1	45.6	48.6	51.6	54.6	58.1	61.6	65.6	2.50	3.15	1.27
25.3	26.8	28.8	30.8	35.3	37.8	40.3	42.8	45.3	48.3	51.3	54.3	57.8	61.3	65.3	2.65	3.35	1.27
0.99	1.00	1.01	1.02	1.04	1.05	1.06	1.07	1.08	1.09	1.10	1.11	1.12	1.13	1.14			
21.5	23.0	25.0	27.0	31.6	34.1	36.6	39.1	41.6	44.6	47.6	50.6	54.1	57.6	61.6	4.75	6.00	1.27
26.1	27.6	29.6	31.6	36.1	38.6	41.1	43.6	46.1	49.1	52.1	55.1	58.6	62.1	66.1	2.20	2.80	1.28
25.8	27.3	29.3	31.3	35.8	38.3	40.8	43.3	45.8	48.8	51.8	54.8	58.3	61.8	65.8	2.35	3.00	1.28
22.6	24.1	26.1	28.1	32.6	35.1	37.6	40.1	42.6	45.6	48.6	51.6	55.1	58.6	62.6	4.12	5.30	1.29
21.0	22.5	24.5	26.5	31.0	33.5	36.0	38.5	41.0	44.0	47.0	50.0	53.5	57.0	61.0	5.00	6.50	1.30
0.99	1.00	1.01	1.02	1.04	1.05	1.06	1.07	1.08	1.09	1.10	1.11	1.12	1.13	1.14			
20.4	21.9	23.9	25.9	30.4	32.9	35.4	37.9	40.4	43.4	46.4	49.4	52.9	56.4	60.4	5.30	6.90	1.30
24.9	26.4	28.4	30.4	34.9	37.4	39.9	42.4	44.9	47.9	50.9	53.9	57.4	60.9	64.9	2.80	3.65	1.31
24.3	25.8	27.8	29.8	34.3	36.8	39.3	41.8	44.3	47.3	50.3	53.3	56.8	60.3	64.3	3.15	4.12	1.31
23.4	24.9	26.9	28.9	33.4	35.9	38.4	40.9	43.4	46.4	49.4	52.4	55.9	59.4	63.4	3.65	4.75	1.31
—	—	14.1	16.1	20.6	23.1	25.6	28.1	30.6	33.6	36.6	39.6	43.1	46.6	50.7	10.60	14.00	1.32
0.99	1.00	1.01	1.02	1.04	1.05	1.06	1.07	1.08	1.09	1.10	1.11	1.12	1.13	1.14			
15.3	16.8	18.8	20.9	25.4	27.9	30.4	32.9	35.4	38.4	41.4	44.4	47.9	51.4	55.4	8.00	10.60	1.33
21.7	23.2	25.2	27.2	31.7	34.2	36.7	39.2	41.7	44.7	47.7	50.7	54.2	57.7	61.7	4.50	6.00	1.34
19.0	20.5	22.5	24.5	29.0	31.5	34.0	36.5	39.0	42.0	45.0	48.0	51.5	55.0	59.0	6.00	8.00	1.34
25.7	27.2	29.2	31.2	35.7	38.2	40.7	43.2	45.7	48.7	51.7	54.7	58.2	61.7	65.7	2.35	3.15	1.35
25.4	26.9	28.9	30.9	35.4	37.9	40.4	42.9	45.4	48.4	51.4	54.4	57.9	61.4	65.4	2.50	3.35	1.35
0.99	1.00	1.01	1.02	1.04	1.05	1.06	1.07	1.08	1.09	1.10	1.11	1.12	1.13	1.14			
23.8	25.3	27.3	29.3	33.8	36.3	38.8	41.3	43.8	46.8	49.8	52.8	56.3	59.8	63.8	3.35	4.50	1.35
22.4	23.9	25.9	27.9	32.4	34.9	37.4	39.9	42.4	45.4	48.4	51.4	54.9	58.4	62.4	4.12	5.60	1.36
25.9	27.4	29.4	31.4	35.9	38.4	40.9	43.4	45.9	48.9	51.9	54.9	58.4	61.9	65.9	2.20	3.00	1.37
23.2	24.7	26.7	28.7	33.2	35.7	38.2	40.7	43.2	46.2	49.2	52.2	55.7	59.2	63.2	3.65	5.00	1.37
21.1	22.6	24.6	26.6	31.2	33.7	36.2	38.7	41.2	44.2	47.2	50.2	53.7	57.2	61.2	4.75	6.50	1.37
0.99	0.99	1.01	1.02	1.04	1.05	1.06	1.07	1.08	1.09	1.10	1.11	1.12	1.13	1.14			
25.0	26.5	28.5	30.5	35.0	37.5	40.0	42.5	45.0	48.0	51.0	54.0	57.5	61.0	65.1	2.65	3.65	1.38
24.4	25.9	27.9	29.9	34.4	36.9	39.4	41.9	44.4	47.4	50.4	53.4	56.9	60.4	64.4	3.00	4.12	1.38
20.6	22.1	24.1	26.1	30.6	33.1	35.6	38.1	40.6	43.6	46.6	49.6	53.1	56.6	60.6	5.00	6.90	1.38
23.6	25.1	27.1	29.1	33.6	36.1	38.6	41.1	43.6	46.6	49.6	52.6	56.1	59.6	63.6	3.35	4.75	1.42
25.5	27.0	29.0	31.0	35.5	38.0	40.5	43.0	45.5	48.5	51.5	54.5	58.0	61.5	65.5	2.35	3.35	1.43
0.99	1.00	1.01	1.02	1.04	1.05	1.06	1.07	1.08	1.09	1.10	1.11	1.12	1.13	1.14			
19.3	20.8	22.8	24.8	29.3	31.8	34.3	36.8	39.3	42.3	45.3	48.3	51.8	55.3	59.3	5.60	8.00	1.43
25.8	27.3	29.3	31.3	35.8	38.3	40.8	43.3	45.8	48.8	51.8	54.8	58.3	61.8	65.8	2.20	3.15	1.44
24.0	25.5	27.5	29.5	34.0	36.5	39.0	41.5	44.0	47.0	50.0	53.0	56.5	60.0	64.0	3.15	4.50	1.44
21.3	22.8	24.8	26.8	31.3	33.8	36.3	38.8	41.3	44.3	47.4	50.4	53.9	57.4	61.4	4.50	6.50	1.45
23.0	24.5	26.5	28.5	33.0	35.5	38.0	40.5	43.0	46.0	49.0	52.0	55.5	59.0	63.0	3.65	5.30	1.46
0.99	1.00	1.01	1.02	1.04	1.05	1.06	1.07	1.08	1.09	1.10	1.11	1.12	1.13	1.14			

FOR BELT SIZES NOT SHOWN, INTERPOLATE FOR ADDITIONAL CENTER DISTANCE.

V-BELT DRIVES

3V Stock Drive Selection



V-BELT DRIVES

Speed Ratio	Sheave Combination		DriveN Speeds and HP Per Belt								Nominal Center Distance And Arc-Length Correction Factors						
			3500 RPM DriveR		1750 RPM DriveR		1160 RPM DriveR		870 RPM DriveR								
	DriveR O.D.	DriveN O.D.	DriveN RPM	HP Per Belt 3VX	DriveN RPM	HP Per Belt 3VX	DriveN RPM	HP Per Belt 3VX	DriveN RPM	HP Per Belt 3VX	3VX Belt Length Designation						
											250	300	355	400	450	500	560
1.46	4.12	6.00	2394	8.73	1197	4.87	793	3.39	595	2.61	—	7.0	9.8	12.0	14.5	17.0	20.0
1.46	4.75	6.90	2401	10.50	1201	5.90	796	4.10	597	3.16	—	—	8.5	10.8	13.3	15.8	18.8
1.47	2.50	3.65	2382	3.80	1191	2.14	789	1.50	592	1.17	7.6	10.2	12.9	15.2	17.7	20.2	23.2
1.48	2.80	4.12	2365	4.75	1182	2.66	784	1.86	588	1.44	7.0	9.5	12.3	14.6	17.1	19.6	22.6
1.50	3.35	5.00	2333	6.46	1167	3.60	773	2.50	580	1.94	5.9	8.4	11.2	13.4	15.9	18.4	21.4
ARC-LENGTH CORRECTION FACTOR											0.81	0.85	0.88	0.91	0.93	0.95	0.97
1.51	3.00	4.50	2320	5.39	1160	3.01	769	2.10	577	1.63	6.6	9.1	11.8	14.1	16.6	19.1	22.1
1.51	5.30	8.00	2311	11.99	1156	6.79	766	4.72	575	3.64	—	—	—	9.5	12.0	14.5	17.5
1.52	3.15	4.75	2309	5.86	1154	3.26	765	2.27	574	1.76	6.2	8.8	11.5	13.8	16.3	18.8	21.8
1.53	2.20	3.35	2280	2.84	1140	1.63	756	1.15	567	0.90	8.1	10.6	13.4	15.6	18.1	20.6	23.6
1.54	3.65	5.60	2270	7.38	1135	4.11	752	2.85	564	2.21	—	7.7	10.4	12.7	15.2	17.7	20.7
ARC-LENGTH CORRECTION FACTOR											0.81	0.85	0.88	0.90	0.93	0.95	0.97
1.54	4.50	6.90	2274	9.83	1137	5.51	754	3.82	565	2.95	—	—	8.7	11.0	13.5	16.0	19.0
1.54	6.90	10.60	2273	15.81	1136	9.27	753	6.47	565	5.00	—	—	—	—	—	11.1	14.1
1.57	2.35	3.65	2236	3.34	1118	1.89	741	1.33	556	1.04	7.8	10.3	13.0	15.3	17.8	20.3	23.3
1.57	2.65	4.12	2236	4.30	1118	2.41	741	1.69	556	1.31	7.1	9.7	12.4	14.7	17.2	19.7	22.7
1.58	4.12	6.50	2209	8.76	1104	4.89	732	3.40	549	2.62	—	—	9.3	11.6	14.1	16.6	19.6
ARC-LENGTH CORRECTION FACTOR											0.81	0.85	0.88	0.91	0.93	0.95	0.97
1.59	3.00	4.75	2197	5.41	1098	3.01	728	2.10	546	1.63	6.4	8.9	11.6	13.9	16.4	18.9	21.9
1.59	3.35	5.30	2200	6.48	1100	3.61	729	2.51	547	1.94	—	8.1	10.9	13.2	15.7	18.2	21.2
1.60	3.15	5.00	2192	5.87	1096	3.27	726	2.28	545	1.77	6.0	8.5	11.3	13.6	16.1	18.6	21.6
1.61	5.00	8.00	2179	11.22	1090	6.32	722	4.39	542	3.39	—	—	—	9.7	12.2	14.7	17.7
1.62	2.80	4.50	2163	4.79	1081	2.68	717	1.87	538	1.45	6.7	9.2	12.0	14.2	16.7	19.2	22.3
ARC-LENGTH CORRECTION FACTOR											0.80	0.84	0.88	0.90	0.93	0.95	0.97
1.64	6.50	10.60	2140	14.95	1070	8.67	709	6.04	532	4.67	—	—	—	—	—	11.4	14.4
1.65	3.65	6.00	2118	7.40	1059	4.12	702	2.86	526	2.21	—	7.3	10.1	12.4	14.9	17.4	20.4
1.66	2.50	4.12	2107	3.84	1053	2.16	698	1.52	524	1.18	7.3	9.8	12.5	14.8	17.3	19.8	22.8
1.67	2.20	3.65	2090	2.87	1045	1.64	693	1.16	520	0.91	7.9	10.4	13.1	15.4	17.9	20.4	23.4
1.68	3.00	5.00	2086	5.42	1043	3.02	691	2.11	518	1.63	6.1	8.7	11.4	13.7	16.2	18.7	21.7
ARC-LENGTH CORRECTION FACTOR											0.81	0.85	0.88	0.90	0.93	0.95	0.97
1.68	3.35	5.60	2081	6.50	1041	3.62	690	2.52	517	1.95	—	7.9	10.7	12.9	15.4	17.9	20.9
1.68	4.12	6.90	2080	8.78	1040	4.90	689	3.40	517	2.63	—	—	9.0	11.3	13.8	16.3	19.3
1.69	3.15	5.30	2067	5.89	1033	3.28	685	2.28	514	1.77	5.8	8.3	11.1	13.3	15.8	18.3	21.3
1.69	4.75	8.00	2069	10.55	1035	5.93	686	4.11	514	3.18	—	—	—	9.9	12.4	14.9	17.9
1.71	2.65	4.50	2045	4.33	1022	2.42	678	1.70	508	1.32	6.8	9.3	12.1	14.4	16.9	19.4	22.4
ARC-LENGTH CORRECTION FACTOR											0.79	0.83	0.87	0.90	0.92	0.94	0.97
1.71	2.80	4.75	2048	4.80	1024	2.68	679	1.88	509	1.46	6.5	9.0	11.8	14.0	16.5	19.0	22.0
1.75	8.00	14.00	+	+	997	10.92	661	7.65	496	5.92	—	—	—	—	—	—	—
1.77	2.35	4.12	1978	3.37	989	1.91	656	1.34	492	1.05	7.4	9.9	12.6	14.9	17.4	19.9	22.9
1.77	6.00	10.60	1974	13.79	987	7.91	654	5.51	491	4.25	—	—	—	—	—	11.7	14.8
1.78	3.00	5.30	1967	5.44	983	3.03	652	2.11	489	1.64	5.9	8.4	11.2	13.4	15.9	18.4	21.5
ARC-LENGTH CORRECTION FACTOR											0.80	0.84	0.88	0.90	0.92	0.95	0.97
1.79	3.15	5.60	1955	5.90	977	3.28	648	2.29	486	1.77	—	8.0	10.8	13.1	15.6	18.1	21.1
1.79	3.65	6.50	1953	7.42	977	4.13	647	2.87	486	2.22	—	6.9	9.7	11.9	14.5	17.0	20.0
1.79	4.50	8.00	1959	9.87	980	5.53	649	3.84	487	2.96	—	—	7.7	10.0	12.6	15.1	18.1
1.80	2.80	5.00	1944	4.81	972	2.69	644	1.88	483	1.46	6.3	8.8	11.6	13.8	16.3	18.8	21.8
1.80	3.35	6.00	1941	6.52	971	3.62	643	2.52	483	1.95	—	7.5	10.3	12.6	15.1	17.6	20.6
ARC-LENGTH CORRECTION FACTOR											0.79	0.84	0.87	0.90	0.92	0.94	0.97
1.80	10.60	19.00	+	+	974	14.50	646	10.32	484	8.01	—	—	—	—	—	—	—
1.81	2.65	4.75	1936	4.34	968	2.43	642	1.70	481	1.32	6.6	9.1	11.9	14.1	16.7	19.2	22.2
1.82	2.50	4.50	1927	3.86	963	2.17	639	1.53	479	1.19	6.9	9.4	12.2	14.5	17.0	19.5	22.5
1.88	3.00	5.60	1860	5.45	930	3.03	617	2.12	462	1.64	—	8.1	10.9	13.2	15.7	18.2	21.2
1.89	2.20	4.12	1849	2.90	924	1.65	613	1.17	460	0.92	7.5	10.0	12.8	15.0	17.5	20.0	23.0
ARC-LENGTH CORRECTION FACTOR											0.79	0.84	0.87	0.90	0.92	0.94	0.97
1.90	2.65	5.00	1838	4.35	919	2.44	609	1.71	457	1.33	6.4	8.9	11.7	13.9	16.4	19.0	22.0
1.90	3.65	6.90	1839	7.43	920	4.13	610	2.87	457	2.22	—	—	9.3	11.6	14.1	16.6	19.6
1.90	5.60	10.60	1841	12.82	921	7.29	610	5.07	458	3.91	—	—	—	—	9.4	12.0	15.1
1.91	2.80	5.30	1833	4.82	917	2.69	608	1.88	456	1.46	6.0	8.5	11.3	13.6	16.1	18.6	21.6
1.92	2.50	4.75	1824	3.87	912	2.18	605	1.53	454	1.19	6.7	9.2	12.0	14.3	16.8	19.3	22.3
ARC-LENGTH CORRECTION FACTOR											0.79	0.83	0.87	0.90	0.92	0.94	0.96

3VX = COGGED/NOTCHED V-BELT VALUES ARE GIVEN FOR 3VX ONLY DUE TO GENERAL INDUSTRY TRENDS.

+ IF RIM SPEED EXCEEDS 6500 FEET PER MINUTE, CONSULT *Martin*.





Stock Drive 3V Selection

V-BELT DRIVES

Nominal Center Distances And Arc-Length Correction Factor															Sheave Combination		Speed Ratio
3VX Belt Length Designation															DriveR O. D.	DriveN O. D.	
600	630	670	710	800	850	900	950	1000	1060	1120	1180	1250	1320	1400			
22.0	23.5	25.5	27.5	32.0	34.5	37.0	39.5	42.0	45.0	48.0	51.0	54.5	58.0	62.0	4.12	6.00	1.46
20.8	22.3	24.3	26.3	30.8	33.3	35.8	38.3	40.8	43.8	46.8	49.8	53.3	56.8	60.8	4.75	6.90	1.46
25.2	26.7	28.7	30.7	35.2	37.7	40.2	42.7	45.2	48.2	51.2	54.2	57.7	61.2	65.2	2.50	3.65	1.47
24.6	26.1	28.1	30.1	34.6	37.1	39.6	42.1	44.6	47.6	50.6	53.6	57.1	60.6	64.6	2.80	4.12	1.48
23.4	24.9	26.9	28.9	33.4	35.9	38.4	40.9	43.4	46.4	49.4	52.4	55.9	59.4	63.4	3.35	5.00	1.50
0.99	0.99	1.01	1.02	1.04	1.05	1.06	1.07	1.08	1.09	1.10	1.11	1.12	1.13	1.14			
24.1	25.6	27.6	29.6	34.1	36.6	39.1	41.6	44.1	47.1	50.1	53.1	56.6	60.1	64.1	3.00	4.50	1.51
19.5	21.0	23.0	25.0	29.5	32.0	34.5	37.0	39.5	42.5	45.5	48.5	52.0	55.5	59.5	5.30	8.00	1.51
23.8	25.3	27.3	29.3	33.8	36.3	38.8	41.3	43.8	46.8	49.8	52.8	56.3	59.8	63.8	3.15	4.75	1.52
25.6	27.1	29.1	31.1	35.6	38.1	40.6	43.1	45.6	48.6	51.6	54.6	58.1	61.6	65.6	2.20	3.35	1.53
22.7	24.2	26.2	28.2	32.7	35.2	37.7	40.2	42.7	45.7	48.7	51.7	55.2	58.7	62.7	3.65	5.60	1.54
0.98	0.99	1.00	1.02	1.04	1.05	1.06	1.07	1.08	1.09	1.10	1.11	1.12	1.13	1.14			
21.0	22.5	24.5	26.5	31.0	33.5	36.0	38.5	41.0	44.0	47.0	50.0	53.5	57.0	61.0	4.50	6.90	1.54
16.1	17.7	19.7	21.7	26.2	28.7	31.2	33.7	36.2	39.2	42.2	45.2	48.7	52.2	56.2	6.90	10.60	1.54
25.3	26.8	28.8	30.8	35.3	37.8	40.3	42.8	45.3	48.3	51.3	54.3	57.8	61.3	65.3	2.35	3.65	1.57
24.7	26.2	28.2	30.2	34.7	37.2	39.7	42.2	44.7	47.7	50.7	53.7	57.2	60.7	64.7	2.65	4.12	1.57
21.6	23.1	25.1	27.1	31.6	34.1	36.6	39.1	41.6	44.6	47.6	50.6	54.1	57.6	61.6	4.12	6.50	1.58
0.98	0.99	1.01	1.02	1.04	1.05	1.06	1.07	1.08	1.09	1.10	1.11	1.12	1.13	1.14			
23.9	25.4	27.4	29.4	33.9	36.4	38.9	41.4	43.9	46.9	49.9	52.9	56.4	59.9	63.9	3.00	4.75	1.59
23.2	24.7	26.7	28.7	33.2	35.7	38.2	40.7	43.2	46.2	49.2	52.2	55.7	59.2	63.2	3.35	5.30	1.59
23.6	25.1	27.1	29.1	33.6	36.1	38.6	41.1	43.6	46.6	49.6	52.6	56.1	59.6	63.6	3.15	5.00	1.60
19.7	21.2	23.2	25.2	29.7	32.2	34.7	37.2	39.7	42.7	45.7	48.7	52.2	55.7	59.7	5.00	8.00	1.61
24.3	25.8	27.8	29.8	34.3	36.8	39.3	41.8	44.3	47.3	50.3	53.3	56.8	60.3	64.3	2.80	4.50	1.62
0.98	0.99	1.00	1.01	1.04	1.05	1.06	1.07	1.08	1.09	1.10	1.11	1.12	1.13	1.14			
16.4	18.0	20.0	22.0	26.5	29.0	31.5	34.0	36.5	39.5	42.5	45.5	49.0	52.5	56.5	6.50	10.60	1.64
22.4	23.9	25.9	27.9	32.4	34.9	37.4	39.9	42.4	45.4	48.4	51.4	54.9	58.4	62.4	3.65	6.00	1.65
24.8	26.3	28.3	30.3	34.8	37.3	39.8	42.3	44.8	47.8	50.8	53.8	57.3	60.8	64.8	2.50	4.12	1.65
25.4	26.9	28.9	30.9	35.4	37.9	40.4	42.9	45.4	48.4	51.4	54.4	57.9	61.4	65.4	2.20	3.65	1.67
23.7	25.2	27.2	29.2	33.7	36.2	38.7	41.2	43.7	46.7	49.7	52.7	56.2	59.7	63.7	3.00	5.00	1.68
0.98	0.99	1.00	1.01	1.04	1.05	1.06	1.07	1.08	1.09	1.10	1.11	1.12	1.13	1.14			
22.9	24.4	26.4	28.4	33.0	35.5	38.0	40.5	43.0	46.0	49.0	52.0	55.5	59.0	63.0	3.35	5.60	1.68
21.3	22.8	24.8	26.8	31.3	33.8	36.3	38.8	41.3	44.3	47.3	50.3	53.8	57.3	61.3	4.12	6.90	1.68
23.3	24.8	26.8	28.8	33.3	35.8	38.3	40.8	43.3	46.3	49.3	52.3	55.8	59.3	63.3	3.15	5.30	1.69
19.9	21.4	23.4	25.4	29.9	32.4	34.9	37.4	40.0	43.0	46.0	49.0	52.5	56.0	60.0	4.75	8.00	1.69
24.4	25.9	27.9	29.9	34.4	36.9	39.4	41.9	44.4	47.4	50.4	53.4	56.9	60.4	64.4	2.65	4.50	1.71
0.98	0.99	1.00	1.01	1.04	1.05	1.06	1.07	1.08	1.09	1.10	1.11	1.12	1.13	1.14			
24.1	25.6	27.6	29.6	34.1	36.6	39.1	41.6	44.1	47.1	50.1	53.1	56.6	60.1	64.1	2.80	4.75	1.71
—	13.9	15.9	18.0	22.5	25.0	27.6	30.1	32.6	35.6	38.6	41.6	45.1	48.6	52.6	8.00	14.00	1.75
24.9	26.4	28.4	30.4	34.9	37.4	39.9	42.4	44.9	47.9	50.9	53.9	57.4	60.9	64.9	2.35	4.12	1.77
16.8	18.3	20.3	22.3	26.9	29.4	31.9	34.4	36.9	39.9	42.9	45.9	49.4	52.9	56.9	6.00	10.60	1.77
23.5	25.0	27.0	29.0	33.5	36.0	38.5	41.0	43.5	46.5	49.5	52.5	56.0	59.5	63.5	3.00	5.30	1.78
0.98	0.99	1.00	1.01	1.04	1.05	1.06	1.07	1.08	1.09	1.10	1.11	1.12	1.13	1.14			
23.1	24.6	26.6	28.6	33.1	35.6	38.1	40.6	43.1	46.1	49.1	52.1	55.6	59.1	63.1	3.15	5.60	1.79
22.0	23.5	25.5	27.5	32.0	34.5	37.0	39.5	42.0	45.0	48.0	51.0	54.5	58.0	62.0	3.65	6.50	1.79
20.1	21.6	23.6	25.6	30.1	32.6	35.1	37.6	40.1	43.1	46.1	49.2	52.7	56.2	60.2	4.50	8.00	1.79
23.8	25.4	27.4	29.4	33.9	36.4	38.9	41.4	43.9	46.9	49.9	52.9	56.4	59.9	63.9	2.80	5.00	1.80
22.6	24.1	26.1	28.1	32.6	35.1	37.6	40.1	42.6	45.6	48.6	51.6	55.1	58.6	62.6	3.35	6.00	1.80
0.98	0.99	1.00	1.01	1.03	1.05	1.06	1.07	1.08	1.09	1.10	1.11	1.12	1.13	1.14			
—	—	—	—	—	18.8	21.3	23.9	26.4	29.5	32.5	35.5	39.0	42.5	46.6	10.60	19.00	1.80
24.2	25.7	27.7	29.7	34.2	36.7	39.2	41.7	44.2	47.2	50.2	53.2	56.7	60.2	64.2	2.65	4.75	1.81
24.5	26.0	28.0	30.0	34.5	37.0	39.5	42.0	44.5	47.5	50.5	53.5	57.0	60.5	64.5	2.50	4.50	1.82
23.2	24.7	26.7	28.7	33.2	35.7	38.2	40.7	43.2	46.2	49.2	52.2	55.7	59.2	63.2	3.00	5.60	1.88
25.0	26.5	28.5	30.5	35.0	37.5	40.0	42.5	45.0	48.0	51.0	54.0	57.5	61.0	65.0	2.20	4.12	1.89
0.98	0.99	1.00	1.01	1.04	1.05	1.06	1.07	1.08	1.09	1.10	1.11	1.12	1.13	1.14			
24.0	25.5	27.5	29.5	34.0	36.5	39.0	41.5	44.0	47.0	50.0	53.0	56.5	60.0	64.0	2.65	5.00	1.90
21.7	23.2	25.2	27.2	31.7	34.2	36.7	39.2	41.7	44.7	47.7	50.7	54.2	57.7	61.7	3.65	6.90	1.90
17.1	18.6	20.6	22.6	27.2	29.7	32.2	34.7	37.2	40.2	43.2	46.2	49.7	53.2	57.2	5.60	10.60	1.90
23.6	25.1	27.1	29.1	33.6	36.1	38.6	41.1	43.6	46.6	49.6	52.6	56.1	59.6	63.6	2.80	5.30	1.91
24.3	25.8	27.8	29.8	34.3	36.8	39.3	41.8	44.3	47.3	50.3	53.3	56.8	60.3	64.3	2.50	4.75	1.92
0.98	0.99	1.00	1.01	1.03	1.05	1.06	1.07	1.08	1.09	1.10	1.11	1.12	1.13	1.14			

FOR BELT SIZES NOT SHOWN, INTERPOLATE FOR ADDITIONAL CENTER DISTANCE.

3V Stock Drive Selection



V-BELT DRIVES

Speed Ratio	Sheave Combination		DriveN Speeds and HP Per Belt								Nominal Center Distance And Arc-Length Correction Factors						
			3500 RPM DriveR		1750 RPM DriveR		1160 RPM DriveR		870 RPM DriveR								
	DriveR O.D.	DriveN O.D.	DriveN RPM	HP Per Belt 3VX	DriveN RPM	HP Per Belt 3VX	DriveN RPM	HP Per Belt 3VX	DriveN RPM	HP Per Belt 3VX	3VX Belt Length Designation						
											250	300	355	400	450	500	560
1.92	3.15	6.00	1824	5.91	912	3.29	604	2.29	453	1.78	—	7.7	10.5	12.7	15.2	17.8	20.8
1.93	2.35	4.50	1809	3.39	904	1.92	600	1.35	450	1.05	7.0	9.6	12.3	14.6	17.1	19.6	22.6
1.95	3.35	6.50	1791	6.53	895	3.63	593	2.53	445	1.95	—	7.1	9.9	12.2	14.7	17.2	20.2
1.95	4.12	8.00	1792	8.81	896	4.91	594	3.41	445	2.63	—	—	8.0	10.3	12.8	15.4	18.4
2.01	5.30	10.60	1742	12.05	871	6.82	577	4.74	433	3.66	—	—	—	—	9.6	12.2	15.3
ARC-LENGTH CORRECTION FACTOR											0.80	0.84	0.87	0.90	0.92	0.94	0.97
2.02	2.50	5.00	1732	3.88	866	2.18	574	1.53	431	1.19	6.5	9.0	11.8	14.1	16.6	19.1	22.1
2.02	2.65	5.30	1733	4.36	867	2.44	574	1.71	431	1.33	6.1	8.7	11.4	13.7	16.2	18.7	21.7
2.02	2.80	5.60	1734	4.83	867	2.70	575	1.89	431	1.46	5.7	8.3	11.1	13.3	15.8	18.3	21.3
2.02	3.00	6.00	1735	5.46	868	3.04	575	2.12	431	1.64	—	7.8	10.6	12.8	15.4	17.9	20.9
2.04	2.35	4.75	1713	3.39	856	1.92	568	1.35	426	1.06	6.8	9.3	12.1	14.4	16.9	19.4	22.4
ARC-LENGTH CORRECTION FACTOR											0.79	0.83	0.87	0.90	0.92	0.94	0.96
2.04	6.90	14.00	1719	15.88	859	9.30	570	6.49	427	5.01	—	—	—	—	—	—	—
2.07	2.20	4.50	1691	2.91	846	1.66	560	1.17	420	0.92	7.1	9.7	12.4	14.7	17.2	19.7	20.7
2.08	3.15	6.50	1682	5.93	841	3.30	558	2.30	418	1.78	—	7.2	10.0	12.3	14.8	17.3	20.4
2.08	3.35	6.90	1686	6.54	843	3.63	559	2.53	419	1.96	—	6.7	9.5	11.8	14.3	16.9	19.9
2.13	2.65	5.60	1640	4.36	820	2.44	543	1.71	408	1.33	5.8	8.4	11.2	13.4	16.0	18.5	21.5
ARC-LENGTH CORRECTION FACTOR											0.79	0.84	0.87	0.90	0.92	0.94	0.97
2.13	5.00	10.60	1642	11.27	821	6.35	544	4.41	408	3.40	—	—	—	—	9.8	12.4	15.5
2.14	2.50	5.30	1633	3.88	817	2.18	541	1.53	406	1.19	6.2	8.8	11.5	13.8	16.3	18.8	21.8
2.15	2.35	5.00	1626	3.40	813	1.92	539	1.35	404	1.06	6.6	9.1	11.9	14.2	16.7	19.2	22.2
2.16	2.80	6.00	1618	4.84	809	2.70	536	1.89	402	1.47	—	7.9	10.7	13.0	15.5	18.0	21.0
2.16	6.50	14.00	1618	14.99	809	8.70	536	6.06	402	4.68	—	—	—	—	—	—	—
ARC-LENGTH CORRECTION FACTOR											0.78	0.83	0.87	0.89	0.92	0.94	0.96
2.19	2.20	4.75	1601	2.91	801	1.66	531	1.18	398	0.92	6.9	9.5	12.2	14.5	17.0	19.5	22.5
2.19	3.00	6.50	1601	5.47	800	3.04	531	2.12	398	1.65	—	7.3	10.1	12.4	14.9	17.5	20.5
2.21	3.15	6.90	1584	5.93	792	3.30	525	2.30	394	1.78	—	6.9	9.7	12.0	14.5	17.0	20.0
2.21	3.65	8.00	1585	7.45	792	4.14	525	2.88	394	2.22	—	—	8.3	10.6	13.2	15.7	18.7
2.24	4.75	10.60	1559	10.60	780	5.95	517	4.13	388	3.19	—	—	—	—	10.0	12.6	15.7
ARC-LENGTH CORRECTION FACTOR											0.79	0.83	0.87	0.90	0.92	0.94	0.96
2.27	2.50	5.60	1545	3.89	773	2.19	512	1.53	384	1.19	5.9	8.5	11.3	13.5	16.1	18.6	21.6
2.28	2.35	5.30	1533	3.40	767	1.93	508	1.36	381	1.06	6.3	8.9	11.6	13.9	16.4	18.9	21.9
2.29	2.65	6.00	1529	4.37	765	2.45	507	1.71	380	1.33	—	8.0	10.8	13.1	15.6	18.1	21.1
2.30	2.20	5.00	1520	2.92	760	1.66	504	1.18	378	0.92	6.7	9.2	12.0	14.3	16.8	19.3	22.3
2.32	3.00	6.90	1507	5.47	754	3.05	500	2.12	375	1.65	—	7.0	9.8	12.1	14.6	17.1	20.1
ARC-LENGTH CORRECTION FACTOR											0.77	0.82	0.86	0.89	0.91	0.94	0.96
2.34	6.00	14.00	1493	13.83	746	7.93	495	5.52	371	4.26	—	—	—	—	—	—	11.6
2.35	2.80	6.50	1492	4.84	746	2.70	495	1.89	371	1.47	—	7.5	10.3	12.6	15.1	17.6	20.6
2.36	10.60	25.00	+	+	740	14.51	491	10.33	368	8.02	—	—	—	—	—	—	—
2.37	4.50	10.60	1476	9.91	738	5.54	489	3.85	367	2.97	—	—	—	—	10.2	12.8	15.8
2.38	8.00	19.00	+	+	734	10.94	487	7.66	365	5.93	—	—	—	—	—	—	—
ARC-LENGTH CORRECTION FACTOR											0.0	0.80	0.85	0.88	0.91	0.93	0.96
2.41	2.35	5.60	1450	3.41	725	1.93	481	1.36	361	1.06	6.0	8.6	11.4	13.7	16.2	18.7	21.7
2.41	3.35	8.00	1453	6.55	726	3.64	482	2.53	361	1.96	—	—	8.5	10.8	13.4	15.9	18.9
2.43	2.50	6.00	1441	3.89	721	2.19	478	1.54	358	1.20	—	8.1	10.9	13.2	15.7	18.2	21.3
2.44	2.20	5.30	1433	2.92	717	1.67	475	1.18	356	0.92	6.4	9.0	11.8	14.0	16.5	19.0	22.0
2.48	2.65	6.50	1411	4.37	705	2.45	468	1.71	351	1.33	—	7.6	10.4	12.7	15.2	17.7	20.7
ARC-LENGTH CORRECTION FACTOR											0.76	0.82	0.86	0.89	0.91	0.94	0.96
2.49	2.80	6.90	1405	4.85	703	2.71	466	1.89	349	1.47	—	7.1	9.9	12.2	14.7	17.3	20.3
2.51	5.60	14.00	1392	12.84	696	7.31	462	5.08	346	3.92	—	—	—	—	—	—	11.9
2.56	3.15	8.00	1365	5.94	682	3.30	452	2.30	339	1.78	—	—	8.7	11.0	13.5	16.1	19.1
2.58	2.20	5.60	1356	2.92	678	1.67	449	1.18	337	0.92	6.1	8.7	11.5	13.8	16.3	18.8	21.8
2.59	2.35	6.00	1353	3.41	676	1.93	448	1.36	336	1.06	5.6	8.2	11.0	13.3	15.8	18.4	21.4
ARC-LENGTH CORRECTION FACTOR											0.76	0.82	0.86	0.89	0.91	0.93	0.96
2.59	4.12	10.60	1350	8.84	675	4.92	448	3.42	336	2.64	—	—	—	—	10.4	13.0	16.1
2.63	2.50	6.50	1329	3.90	665	2.19	441	1.54	330	1.20	—	7.7	10.5	12.8	15.3	17.8	20.8
2.63	2.65	6.90	1328	4.38	664	2.45	440	1.72	330	1.33	—	7.2	10.0	12.3	14.8	17.4	20.4
2.66	5.30	14.00	1317	12.08	659	6.83	437	4.75	327	3.66	—	—	—	—	—	—	12.1
2.69	3.00	8.00	1299	5.48	649	3.05	430	2.13	323	1.65	—	—	8.8	11.1	13.6	16.2	19.2
ARC-LENGTH CORRECTION FACTOR											0.0	0.80	0.85	0.88	0.91	0.93	0.95

3VX = COGGED/NOTCHED V-BELT VALUES ARE GIVEN FOR 3VX ONLY DUE TO GENERAL INDUSTRY TRENDS.

+ IF RIM SPEED EXCEEDS 6500 FEET PER MINUTE, CONSULT *Martin*.



Stock Drive 3V Selection

Nominal Center Distances And Arc-Length Correction Factor															Sheave Combination		Speed Ratio
3VX Belt Length Designation															DriveR O.D.	DriveN O.D.	
600	630	670	710	800	850	900	950	1000	1060	1120	1180	1250	1320	1400			
22.8	24.3	26.3	28.3	32.8	35.3	37.8	40.3	42.8	45.8	48.8	51.8	55.3	58.8	62.8	3.15	6.00	1.92
24.6	26.1	28.1	30.1	34.6	37.1	39.6	42.1	44.6	47.6	50.6	53.6	57.1	60.6	64.6	2.35	4.50	1.93
22.2	23.7	25.7	27.7	32.2	34.7	37.2	39.7	42.2	45.2	48.2	51.2	54.7	58.2	62.2	3.35	6.50	1.95
20.4	21.9	23.9	25.9	30.4	32.9	35.4	37.9	40.4	43.4	46.4	49.4	52.9	56.4	60.4	4.12	8.00	1.95
17.3	18.8	20.8	22.9	27.4	29.9	32.4	34.9	37.4	40.4	43.4	46.4	49.9	53.4	57.5	5.30	10.60	2.01
0.98	0.99	1.00	1.01	1.04	1.05	1.06	1.07	1.08	1.09	1.10	1.11	1.12	1.13	1.14			
24.1	25.6	27.6	29.6	34.1	36.6	39.1	41.6	44.1	47.1	50.1	53.1	56.6	60.1	64.1	2.50	5.00	2.02
23.7	25.2	27.2	29.2	33.7	36.2	38.7	41.2	43.7	46.7	49.7	52.7	56.2	59.7	63.7	2.65	5.30	2.02
23.4	24.9	26.9	28.9	33.4	35.9	38.4	40.9	43.4	46.4	49.4	52.4	55.9	59.4	63.4	2.80	5.60	2.02
22.9	24.4	26.4	28.4	32.9	35.4	37.9	40.4	42.9	45.9	48.9	51.9	55.4	58.9	62.9	3.00	6.00	2.02
24.4	25.9	27.9	29.9	34.4	36.9	39.4	41.9	44.4	47.4	50.4	53.4	56.9	60.4	64.4	2.35	4.75	2.04
0.98	0.99	1.00	1.01	1.03	1.05	1.06	1.07	1.08	1.09	1.10	1.11	1.12	1.13	1.14			
13.1	14.7	16.7	18.7	23.3	25.8	28.4	30.9	33.4	36.4	39.4	42.4	45.9	49.5	53.5	6.90	14.00	2.04
24.7	26.2	28.2	30.2	34.7	37.2	39.7	42.2	44.7	47.7	50.7	53.7	57.2	60.7	64.7	2.20	4.50	2.07
22.4	23.9	25.9	27.9	32.4	34.9	37.4	39.9	42.4	45.4	48.4	51.4	54.9	58.4	62.4	3.15	6.50	2.08
21.9	23.4	25.4	27.4	31.9	34.4	36.9	39.4	41.9	44.9	47.9	50.9	54.4	57.9	61.9	3.35	6.90	2.08
23.5	25.0	27.0	29.0	33.5	36.0	38.5	41.0	43.5	46.5	49.5	52.5	56.0	59.5	63.5	2.65	5.60	2.13
0.98	0.99	1.00	1.01	1.03	1.05	1.06	1.07	1.08	1.09	1.10	1.11	1.12	1.13	1.14			
17.5	19.0	21.1	23.1	27.6	30.1	32.6	35.1	37.6	40.7	43.7	46.7	50.2	53.7	57.7	5.00	10.60	2.13
23.8	25.3	27.3	29.3	33.8	36.3	38.8	41.4	43.9	46.9	49.9	52.9	56.4	59.9	63.9	2.50	5.30	2.14
24.2	25.7	27.7	29.7	34.2	36.7	39.2	41.7	44.2	47.2	50.2	53.2	56.7	60.2	64.2	2.35	5.00	2.15
23.0	24.5	26.5	28.5	33.0	35.5	38.1	40.6	43.1	46.1	49.1	52.1	55.6	59.1	63.1	2.80	6.00	2.16
13.4	14.9	17.0	19.0	23.6	26.1	28.7	31.2	33.7	36.7	39.7	42.7	46.2	49.8	53.8	6.50	14.00	2.16
0.98	0.99	1.00	1.01	1.03	1.04	1.06	1.07	1.08	1.09	1.10	1.11	1.12	1.13	1.14			
24.5	26.0	28.0	30.0	34.5	37.0	39.5	42.0	44.5	47.5	50.5	53.5	57.0	60.5	64.5	2.20	4.75	2.19
22.5	24.0	26.0	28.0	32.5	35.0	37.5	40.0	42.5	45.5	48.5	51.5	55.0	58.5	62.5	3.00	6.50	2.19
22.0	23.5	25.5	27.5	32.1	34.6	37.1	39.6	42.1	45.1	48.1	51.1	54.6	58.1	62.1	3.15	6.90	2.21
20.7	22.2	24.3	26.3	30.8	33.3	35.8	38.3	40.8	43.8	46.8	49.8	53.3	56.8	60.8	3.65	8.00	2.21
17.7	19.2	21.2	23.3	27.8	30.3	32.8	35.3	37.8	40.8	43.8	46.9	50.4	53.9	57.9	4.75	10.60	2.24
0.98	0.99	1.00	1.01	1.03	1.05	1.06	1.07	1.08	1.09	1.10	1.11	1.12	1.13	1.14			
23.6	25.1	27.1	29.1	33.6	36.1	38.6	41.1	43.6	46.6	49.6	52.6	56.1	59.6	63.6	2.50	5.60	2.27
23.9	25.4	27.5	29.5	34.0	36.5	39.0	41.5	44.0	47.0	50.0	53.0	56.5	60.0	64.0	2.35	5.30	2.28
23.1	24.6	26.7	28.7	33.2	35.7	38.2	40.7	43.2	46.2	49.2	52.2	55.7	59.2	63.2	2.65	6.00	2.29
24.3	25.8	27.8	29.8	34.3	36.8	39.3	41.8	44.3	47.3	50.3	53.3	56.8	60.3	64.3	2.20	5.00	2.30
22.1	23.6	25.7	27.7	32.2	34.7	37.2	39.7	42.2	45.2	48.2	51.2	54.7	58.2	62.2	3.00	6.90	2.32
0.97	0.98	1.00	1.01	1.03	1.04	1.05	1.06	1.07	1.09	1.10	1.11	1.12	1.13	1.14			
13.7	15.3	17.3	19.4	24.0	26.5	29.0	31.5	34.1	37.1	40.1	43.1	46.6	50.1	54.1	6.00	14.00	2.34
22.6	24.1	26.1	28.1	32.6	35.1	37.7	40.2	42.7	45.7	48.7	51.7	55.2	58.7	62.7	2.80	6.50	2.35
—	—	—	—	—	—	—	—	20.8	24.0	27.1	30.2	33.8	37.3	41.4	10.60	25.00	2.36
17.9	19.4	21.4	23.4	28.0	30.5	33.0	35.5	38.0	41.0	44.0	47.0	50.5	54.1	58.1	4.50	10.60	2.37
—	—	—	—	18.0	20.6	23.1	25.7	28.3	31.3	34.4	37.4	40.9	44.5	48.5	8.00	19.00	2.38
0.97	0.98	0.99	1.00	1.03	1.04	1.05	1.06	1.07	1.08	1.09	1.10	1.12	1.13	1.14			
23.7	25.2	27.2	29.2	33.7	36.2	38.7	41.2	43.7	46.7	49.7	52.7	56.2	59.7	63.7	2.35	5.60	2.41
21.0	22.5	24.5	26.5	31.0	33.5	36.0	38.5	41.0	44.0	47.0	50.0	53.5	57.0	61.0	3.35	8.00	2.41
23.3	24.8	26.8	28.8	33.3	35.8	38.3	40.8	43.3	46.3	49.3	52.3	55.8	59.3	63.3	2.50	6.00	2.43
24.1	25.6	27.6	29.6	34.1	36.6	39.1	41.6	44.1	47.1	50.1	53.1	56.6	60.1	64.1	2.20	5.30	2.44
22.7	24.2	26.2	28.2	32.8	35.3	37.8	40.3	42.8	45.8	48.8	51.8	55.3	58.8	62.8	2.65	6.50	2.48
0.97	0.98	1.00	1.01	1.03	1.04	1.05	1.06	1.07	1.09	1.10	1.11	1.12	1.13	1.14			
22.3	23.8	25.8	27.8	32.3	34.8	37.3	39.8	42.3	45.3	48.3	51.3	54.8	58.3	62.3	2.80	6.90	2.49
14.0	15.5	17.6	19.7	24.2	26.8	29.3	31.8	34.3	37.4	40.4	43.4	46.9	50.4	54.4	5.60	14.00	2.51
21.1	22.6	24.6	26.6	31.1	33.7	36.2	38.7	41.2	44.2	47.2	50.2	53.7	57.2	61.2	3.15	8.00	2.56
23.8	25.3	27.3	29.3	33.8	36.3	38.8	41.3	43.8	46.8	49.8	52.8	56.3	59.8	63.9	2.20	5.60	2.58
23.4	24.9	26.9	28.9	33.4	35.9	38.4	40.9	43.4	46.4	49.4	52.4	55.9	59.4	63.4	2.35	6.00	2.59
0.97	0.98	0.99	1.01	1.03	1.04	1.05	1.06	1.07	1.08	1.10	1.11	1.12	1.13	1.14			
18.1	19.7	21.7	23.7	28.3	30.8	33.3	35.8	38.3	41.3	44.3	47.3	50.8	54.3	58.3	4.12	10.60	2.59
22.8	24.3	26.4	28.4	32.9	35.4	37.9	40.4	42.9	45.9	48.9	51.9	55.4	58.9	62.9	2.50	6.50	2.63
22.4	23.9	25.9	27.9	32.4	34.9	37.4	39.9	42.4	45.4	48.5	51.5	55.0	58.5	62.5	2.65	6.90	2.63
14.2	15.7	17.8	19.9	24.5	27.0	29.5	32.0	34.6	37.6	40.6	43.6	47.1	50.7	54.7	5.30	14.00	2.66
21.2	22.7	24.7	26.7	31.3	33.8	36.3	38.8	41.3	44.3	47.3	50.3	53.8	57.3	61.3	3.00	8.00	2.69
0.97	0.98	0.99	1.00	1.03	1.04	1.05	1.06	1.07	1.08	1.09	1.10	1.11	1.13	1.14			

FOR BELT SIZES NOT SHOWN, INTERPOLATE FOR ADDITIONAL CENTER DISTANCE.

V-BELT DRIVES

3V Stock Drive Selection



V-BELT DRIVES

Speed Ratio	Sheave Combination		DriveN Speeds and HP Per Belt								Nominal Center Distance And Arc-Length Correction Factors						
			3500 RPM DriveR		1750 RPM DriveR		1160 RPM DriveR		870 RPM DriveR		3VX Belt Length Designation						
	DriveR O.D.	DriveN O.D.	DriveN RPM	HP Per Belt 3VX	DriveN RPM	HP Per Belt 3VX	DriveN RPM	HP Per Belt 3VX	DriveN RPM	HP Per Belt 3VX	250	300	355	400	450	500	560
2.77	2.20	6.00	1265	2.93	632	1.67	419	1.18	314	0.92	5.7	8.3	11.1	13.4	15.9	18.5	21.5
2.77	6.90	19.00	1265	15.90	633	9.31	419	6.50	314	5.02	—	—	—	—	—	—	—
2.80	2.35	6.50	1248	3.42	624	1.93	414	1.36	310	1.06	—	7.8	10.6	12.9	15.4	17.9	20.9
2.80	2.50	6.90	1252	3.90	626	2.19	415	1.54	311	1.20	—	7.3	10.1	12.4	15.0	17.5	20.5
2.82	5.00	14.00	1242	11.29	621	6.36	412	4.41	309	3.41	—	—	—	—	—	—	12.3
ARC-LENGTH CORRECTION FACTOR											0.75	0.81	0.85	0.88	0.91	0.93	0.96
2.89	2.80	8.00	1211	4.86	605	2.71	401	1.89	301	1.47	—	—	8.9	11.2	13.8	16.3	19.3
2.93	3.65	10.60	1194	7.46	597	4.15	396	2.88	297	2.23	—	—	—	—	10.7	13.4	16.4
2.94	6.50	19.00	1191	15.01	596	8.71	395	6.07	296	4.68	—	—	—	—	—	—	—
2.97	4.75	14.00	1179	10.61	590	5.95	391	4.13	293	3.19	—	—	—	—	—	—	12.4
2.98	2.35	6.90	1175	3.42	588	1.93	389	1.36	292	1.06	—	7.4	10.2	12.5	15.1	17.6	20.6
ARC-LENGTH CORRECTION FACTOR											0.0	0.78	0.84	0.87	0.90	0.92	0.95
3.00	2.20	6.50	1167	2.93	583	1.67	387	1.18	290	0.92	—	7.9	10.7	13.0	15.5	18.0	21.1
3.06	2.65	8.00	1145	4.38	572	2.45	379	1.72	285	1.33	—	—	9.0	11.3	13.9	16.4	19.5
3.13	4.50	14.00	1116	9.92	558	5.55	370	3.85	278	2.97	—	—	—	—	—	—	12.6
3.14	8.00	25.00	—	—	558	10.94	370	7.67	277	5.93	—	—	—	—	—	—	—
3.17	10.60	33.50	—	—	552	14.52	366	10.33	274	8.02	—	—	—	—	—	—	—
ARC-LENGTH CORRECTION FACTOR											0.0	0.79	0.84	0.87	0.90	0.93	0.95
3.18	6.00	19.00	1099	13.84	549	7.94	364	5.52	273	4.26	—	—	—	—	—	—	—
3.19	2.20	6.90	1099	2.93	549	1.67	364	1.18	273	0.92	—	7.5	10.3	12.6	15.2	17.7	20.7
3.20	3.35	10.60	1095	6.56	547	3.65	363	2.54	272	1.96	—	—	—	—	10.9	13.6	16.6
3.24	2.50	8.00	1079	3.90	539	2.19	357	1.54	268	1.20	—	—	9.1	11.4	14.0	16.5	19.6
3.40	3.15	10.60	1028	5.95	514	3.31	341	2.31	256	1.78	—	—	—	8.4	11.1	13.7	16.8
ARC-LENGTH CORRECTION FACTOR											0.0	0.78	0.84	0.87	0.90	0.92	0.95
3.41	5.60	19.00	1025	12.85	513	7.31	340	5.08	255	3.92	—	—	—	—	—	—	—
3.43	4.12	14.00	1021	8.85	511	4.93	338	3.42	254	2.64	—	—	—	—	—	—	12.8
3.46	2.35	8.00	1013	3.42	506	1.93	336	1.36	252	1.06	—	—	9.2	11.5	14.1	16.6	19.7
3.58	3.00	10.60	979	5.49	489	3.05	324	2.13	243	1.65	—	—	—	8.5	11.2	13.8	16.9
3.61	5.30	19.00	970	12.09	485	6.84	321	4.75	241	3.67	—	—	—	—	—	—	—
ARC-LENGTH CORRECTION FACTOR											0.0	0.0	0.81	0.85	0.88	0.91	0.94
3.64	6.90	25.00	961	15.91	480	9.32	318	6.50	239	5.02	—	—	—	—	—	—	—
3.70	2.20	8.00	947	2.94	473	1.67	314	1.18	235	0.93	—	—	9.3	11.6	14.2	16.7	19.8
3.83	5.00	19.00	914	11.29	457	6.36	303	4.42	227	3.41	—	—	—	—	—	—	—
3.84	2.80	10.60	912	4.86	456	2.71	302	1.90	227	1.47	—	—	—	8.6	11.3	13.9	17.0
3.87	3.65	14.00	903	7.47	452	4.15	299	2.89	225	2.23	—	—	—	—	—	—	13.1
ARC-LENGTH CORRECTION FACTOR											0.0	0.0	0.81	0.85	0.88	0.91	0.94
3.87	6.50	25.00	905	15.02	452	8.71	300	6.07	225	4.68	—	—	—	—	—	—	—
4.03	4.75	19.00	868	10.62	434	5.96	288	4.14	216	3.19	—	—	—	—	—	—	—
4.06	2.65	10.60	863	4.39	431	2.46	286	1.72	214	1.34	—	—	—	8.7	11.4	14.0	17.1
4.19	6.00	25.00	835	13.85	417	7.94	277	5.52	207	4.26	—	—	—	—	—	—	—
4.21	8.00	33.50	—	—	416	10.95	276	7.67	207	5.93	—	—	—	—	—	—	—
ARC-LENGTH CORRECTION FACTOR											0.0	0.0	0.0	0.77	0.84	0.88	0.91
4.23	3.35	14.00	828	6.57	414	3.65	274	2.54	206	1.96	—	—	—	—	—	—	—
4.26	4.50	19.00	822	9.93	411	5.55	272	3.86	204	2.98	—	—	—	—	—	—	—
4.31	2.50	10.60	813	3.91	406	2.20	269	1.54	202	1.20	—	—	—	8.8	11.5	14.1	17.2
4.50	3.15	14.00	778	5.96	389	3.31	258	2.31	193	1.79	—	—	—	—	—	—	13.4
4.50	5.60	25.00	779	12.86	389	7.31	258	5.08	194	3.92	—	—	—	—	—	—	—
ARC-LENGTH CORRECTION FACTOR											0.0	0.0	0.0	0.77	0.83	0.87	0.91
4.59	2.35	10.60	763	3.43	382	1.94	253	1.36	190	1.06	—	—	—	8.9	11.6	14.2	17.3
4.66	4.12	19.00	752	8.85	376	4.93	249	3.42	187	2.64	—	—	—	—	—	—	—
4.73	3.00	14.00	740	5.49	370	3.06	245	2.13	184	1.65	—	—	—	—	—	10.2	13.5
4.75	5.30	25.00	736	12.09	368	6.84	244	4.75	183	3.67	—	—	—	—	—	—	—
4.88	6.90	33.50	717	15.91	358	9.32	238	6.50	178	5.02	—	—	—	—	—	—	—
ARC-LENGTH CORRECTION FACTOR											0.0	0.0	0.0	0.77	0.83	0.87	0.91
4.91	2.20	10.60	713	2.94	357	1.67	236	1.18	177	0.93	—	—	—	9.0	11.7	14.3	17.4
5.04	5.00	25.00	694	11.30	347	6.36	230	4.42	173	3.41	—	—	—	—	—	—	—
5.07	2.80	14.00	690	4.87	345	2.72	229	1.90	172	1.47	—	—	—	—	—	10.3	13.7
5.19	6.50	33.50	675	15.02	337	8.71	224	6.07	168	4.68	—	—	—	—	—	—	—
5.26	3.65	19.00	665	7.47	332	4.15	220	2.89	165	2.23	—	—	—	—	—	—	—
ARC-LENGTH CORRECTION FACTOR											0.0	0.0	0.0	0.77	0.83	0.87	0.91

3VX = COGGED/NOTCHED V-BELT VALUES ARE GIVEN FOR 3VX ONLY DUE TO GENERAL INDUSTRY TRENDS.

+ IF RIM SPEED EXCEEDS 6500 FEET PER MINUTE, CONSULT *Martin*.





Stock Drive 3V Selection

Nominal Center Distances And Arc-Length Correction Factor															Sheave Combination		Speed Ratio
3VX Belt Length Designation															DriveR O. D.	DriveN O. D.	
600	630	670	710	800	850	900	950	1000	1060	1120	1180	1250	1320	1400			
23.5	25.0	27.0	29.0	33.5	36.0	38.5	41.0	43.5	46.5	49.5	52.5	56.0	59.5	63.5	2.20	6.00	2.77
—	—	—	—	18.7	21.3	23.9	26.5	29.0	32.1	35.1	38.2	41.7	45.3	49.3	6.90	19.00	2.77
23.0	24.5	26.5	28.5	33.0	35.5	38.0	40.5	43.0	46.0	49.0	52.0	55.5	59.0	63.0	2.35	6.50	2.80
22.5	24.0	26.0	28.0	32.5	35.0	37.6	40.1	42.6	45.6	48.6	51.6	55.1	58.6	62.6	2.50	6.90	2.80
14.4	15.9	18.0	20.1	24.7	27.2	29.7	32.3	34.8	37.8	40.8	43.8	47.4	50.9	54.9	5.00	14.00	2.82
0.97	0.98	0.99	1.00	1.03	1.04	1.05	1.06	1.07	1.08	1.09	1.10	1.12	1.13	1.14			
21.4	22.9	24.9	26.9	31.4	33.9	36.4	38.9	41.4	44.4	47.4	50.5	54.0	57.5	61.5	2.80	8.00	2.89
18.5	20.0	22.0	24.1	28.6	31.1	33.6	36.1	38.7	41.7	44.7	47.7	51.2	54.7	58.7	3.65	10.60	2.93
—	—	—	—	18.9	21.6	24.2	26.7	29.3	32.4	35.4	38.5	42.0	45.5	49.6	6.50	19.00	2.94
14.5	16.1	18.2	20.2	24.8	27.4	29.9	32.4	35.0	38.0	41.0	44.0	47.5	51.1	55.1	4.75	14.00	2.97
22.6	24.1	26.1	28.1	32.7	35.2	37.7	40.2	42.7	45.7	48.7	51.7	55.2	58.7	62.7	2.35	6.90	2.98
0.97	0.98	0.99	1.00	1.02	1.04	1.05	1.06	1.07	1.08	1.09	1.10	1.12	1.13	1.14			
23.1	24.6	26.6	28.6	33.1	35.6	38.1	40.6	43.1	46.1	49.1	52.1	55.6	59.1	63.1	2.20	6.50	3.00
21.5	23.0	25.0	27.0	31.5	34.0	36.5	39.0	41.5	44.6	47.6	50.6	54.1	57.6	61.6	2.65	8.00	3.06
14.7	16.3	18.4	20.4	25.0	27.6	30.1	32.6	35.1	38.2	41.2	44.2	47.7	51.3	55.3	4.50	14.00	3.13
—	—	—	—	—	—	—	19.8	22.5	25.7	28.8	32.0	35.6	39.2	43.2	8.00	25.00	3.14
—	—	—	—	—	—	—	—	—	—	—	—	25.3	29.1	33.4	10.60	33.50	3.17
0.97	0.98	0.99	1.00	1.03	1.04	1.05	1.06	1.07	1.08	1.09	1.10	1.12	1.13	1.14			
—	—	—	14.4	19.3	21.9	24.5	27.1	29.7	32.7	35.8	38.8	42.4	45.9	49.9	6.00	19.00	3.18
22.7	24.2	26.2	28.3	32.8	35.3	37.8	40.3	42.8	45.8	48.8	51.8	55.3	58.8	62.8	2.20	6.90	3.19
18.7	20.2	22.2	24.3	28.8	31.3	33.8	36.4	38.9	41.9	44.9	47.9	51.4	54.9	58.9	3.35	10.60	3.20
21.6	23.1	25.1	27.1	31.6	34.1	36.7	39.2	41.7	44.7	47.7	50.7	54.2	57.7	61.7	2.50	8.00	3.24
18.8	20.4	22.4	24.4	29.0	31.5	34.0	36.5	39.0	42.0	45.0	48.1	51.6	55.1	59.1	3.15	10.60	3.40
0.96	0.97	0.99	1.00	1.02	1.04	1.05	1.06	1.07	1.08	1.09	1.10	1.11	1.12	1.13			
—	—	—	14.6	19.5	22.2	24.8	27.4	29.9	33.0	36.1	39.1	42.7	46.2	50.2	5.60	19.00	3.41
15.0	16.5	18.6	20.7	25.3	27.8	30.4	32.9	35.4	38.5	41.5	44.5	48.0	51.5	55.5	4.12	14.00	3.43
21.7	23.2	25.2	27.2	31.7	34.3	36.8	39.3	41.8	44.8	47.8	50.8	54.3	57.8	61.8	2.35	8.00	3.46
18.9	20.5	22.5	24.5	29.1	31.6	34.1	36.6	39.1	42.1	45.2	48.2	51.7	55.2	59.2	3.00	10.60	3.58
—	—	—	14.8	19.7	22.4	25.0	27.6	30.1	33.2	36.3	39.3	42.9	46.4	50.4	5.30	19.00	3.61
0.96	0.97	0.98	0.99	1.02	1.03	1.04	1.05	1.07	1.08	1.09	1.10	1.11	1.12	1.13			
—	—	—	—	—	—	17.6	20.4	23.2	26.4	29.6	32.7	36.3	39.9	44.0	6.90	25.00	3.64
21.8	23.3	25.3	27.3	31.9	34.4	36.9	39.4	41.9	44.9	47.9	50.9	54.4	57.9	61.9	2.20	8.00	3.70
—	—	—	15.0	19.9	22.6	25.2	27.8	30.3	33.4	36.5	39.5	43.1	46.6	50.7	5.00	19.00	3.83
19.1	20.6	22.6	24.7	29.2	31.7	34.3	36.8	39.1	42.3	45.3	48.3	51.8	55.3	59.3	2.80	10.60	3.84
15.3	16.8	18.9	21.0	25.6	28.2	30.7	33.2	35.8	38.8	41.8	44.8	48.4	51.9	55.9	3.65	14.00	3.87
0.95	0.97	0.98	0.99	1.02	1.03	1.04	1.05	1.06	1.08	1.09	1.10	1.11	1.12	1.13			
—	—	—	—	—	—	17.9	20.7	23.4	26.7	29.8	33.0	36.6	40.2	44.3	6.50	25.00	3.87
—	—	—	15.2	20.1	22.7	25.3	27.9	30.5	33.6	36.7	39.7	43.3	46.8	50.8	4.75	19.00	4.03
19.2	20.7	22.7	24.8	29.3	31.8	34.4	36.9	39.4	42.4	45.4	48.4	51.9	55.5	59.5	2.65	10.60	4.06
—	—	—	—	—	—	18.2	21.0	23.8	27.0	30.2	33.3	36.9	40.5	44.6	6.00	25.00	4.19
—	—	—	—	—	—	—	—	—	—	—	22.8	26.9	30.8	35.1	8.00	33.50	4.21
0.93	0.95	0.96	0.98	1.00	1.02	1.03	1.04	1.05	1.07	1.08	1.09	1.10	1.11	1.13			
15.5	17.0	19.1	21.2	25.8	28.4	30.9	33.4	36.0	39.0	42.0	45.1	48.6	52.1	56.1	3.35	14.00	4.23
—	—	—	15.3	20.2	22.9	25.5	28.1	30.7	33.8	36.8	39.9	43.4	47.0	51.0	4.50	19.00	4.26
19.3	20.8	22.9	24.9	29.4	32.0	34.5	37.0	39.5	42.5	45.5	48.5	52.1	55.6	59.6	2.50	10.60	4.31
15.6	17.2	19.3	21.3	26.0	28.5	31.1	33.6	36.1	39.2	42.2	45.2	48.7	52.2	56.3	3.15	14.00	4.50
—	—	—	—	—	—	18.4	21.3	24.0	27.2	30.4	33.6	37.2	40.8	44.9	5.60	25.00	4.50
0.93	0.94	0.96	0.98	1.00	1.02	1.03	1.04	1.05	1.07	1.08	1.09	1.10	1.11	1.13			
19.4	20.9	23.0	25.0	29.5	32.1	34.6	37.1	39.6	42.6	45.6	48.7	52.2	55.7	59.7	2.35	10.60	4.59
—	—	13.3	15.6	20.5	23.1	25.8	28.4	30.9	34.0	37.1	40.2	43.7	47.3	51.3	4.12	19.00	4.66
15.7	17.3	19.4	21.4	26.1	28.6	31.2	33.7	36.2	39.3	42.3	45.3	48.8	52.4	56.4	3.00	14.00	4.73
—	—	—	—	—	—	18.6	21.4	24.2	27.4	30.6	33.8	37.4	41.0	45.1	5.30	25.00	4.75
—	—	—	—	—	—	—	—	—	—	—	23.5	27.6	31.5	35.8	6.90	33.50	4.88
0.93	0.94	0.96	0.97	1.00	1.02	1.03	1.04	1.05	1.07	1.08	1.09	1.10	1.11	1.13			
19.5	21.0	23.1	25.1	29.6	32.2	34.7	37.2	39.7	42.7	45.8	48.8	52.3	55.8	59.8	2.20	10.60	4.91
—	—	—	—	—	—	18.8	21.6	24.4	27.6	30.8	34.0	37.6	41.2	45.3	5.00	25.00	5.04
15.8	17.4	19.5	21.6	26.2	28.8	31.3	33.8	36.4	39.4	42.4	45.5	49.0	52.5	56.5	2.80	14.00	5.07
—	—	—	—	—	—	—	—	—	—	—	23.7	27.8	31.7	36.1	6.50	33.50	5.19
—	—	13.5	15.9	20.8	23.5	26.1	28.7	31.3	34.4	37.4	40.5	44.0	47.6	51.6	3.65	19.00	5.26
0.93	0.94	0.96	0.97	1.00	1.02	1.03	1.04	1.05	1.07	1.08	1.09	1.10	1.11	1.13			

FOR BELT SIZES NOT SHOWN, INTERPOLATE FOR ADDITIONAL CENTER DISTANCE.

V-BELT DRIVES

3V Stock Drive Selection



V-BELT DRIVES

Speed Ratio	Sheave Combination		DriveN Speeds and HP Per Belt								Nominal Center Distance And Arc-Length Correction Factors						
			3500 RPM DriveR		1750 RPM DriveR		1160 RPM DriveR		870 RPM DriveR								
	DriveR O.D.	DriveN O.D.	DriveN RPM	HP Per Belt 3VX	DriveN RPM	HP Per Belt 3VX	DriveN RPM	HP Per Belt 3VX	DriveN RPM	HP Per Belt 3VX	3VX Belt Length Designation						
											250	300	355	400	450	500	560
5.31	4.75	25.00	659	10.62	330	5.96	219	4.14	164	3.19	—	—	—	—	—	—	
5.37	2.65	14.00	652	4.39	326	2.46	216	1.72	162	1.34	—	—	—	—	10.4	—	
5.61	4.50	25.00	624	9.93	312	5.55	207	3.86	155	2.98	—	—	—	—	—	—	
5.62	6.00	33.50	623	13.85	311	7.94	206	5.52	155	4.26	—	—	—	—	—	—	
5.69	2.50	14.00	615	3.91	307	2.20	204	1.54	153	1.20	—	—	—	—	10.5	—	
ARC-LENGTH CORRECTION FACTOR											0.0	0.0	0.0	0.0	0.0	0.76	
5.74	3.35	19.00	609	6.57	305	3.65	202	2.54	152	1.96	—	—	—	—	—	—	
6.03	5.60	33.50	581	12.86	290	7.32	192	5.08	144	3.92	—	—	—	—	—	—	
6.07	2.35	14.00	577	3.43	289	1.94	191	1.36	143	1.06	—	—	—	—	10.6	—	
6.11	3.15	19.00	573	5.96	286	3.31	190	2.31	142	1.79	—	—	—	—	—	—	
6.13	4.12	25.00	571	8.85	285	4.93	189	3.43	142	2.64	—	—	—	—	—	—	
ARC-LENGTH CORRECTION FACTOR											0.0	0.0	0.0	0.0	0.0	0.76	
6.37	5.30	33.50	549	12.09	275	6.84	182	4.75	137	3.67	—	—	—	—	—	—	
6.42	3.00	19.00	545	5.49	272	3.06	181	2.13	135	1.65	—	—	—	—	—	—	
6.49	2.20	14.00	539	2.94	270	1.68	179	1.18	134	0.93	—	—	—	—	10.6	—	
6.76	5.00	33.50	518	11.30	259	6.36	172	4.42	129	3.41	—	—	—	—	—	—	
6.89	2.80	19.00	508	4.87	254	2.72	168	1.90	126	1.47	—	—	—	—	—	—	
ARC-LENGTH CORRECTION FACTOR											0.0	0.0	0.0	0.0	0.0	0.76	
6.93	3.65	25.00	505	7.48	253	4.15	167	2.89	126	2.23	—	—	—	—	—	—	
7.12	4.75	33.50	492	10.62	246	5.96	163	4.14	122	3.19	—	—	—	—	—	—	
7.29	2.65	19.00	480	4.39	240	2.46	159	1.72	119	1.34	—	—	—	—	—	—	
7.52	4.50	33.50	466	9.93	233	5.56	154	3.86	116	2.98	—	—	—	—	—	—	
7.56	3.35	25.00	463	6.57	231	3.65	153	2.54	115	1.97	—	—	—	—	—	—	
ARC-LENGTH CORRECTION FACTOR											0.0	0.0	0.0	0.0	0.0	0.0	0.0
7.73	2.50	19.00	453	3.91	226	2.20	150	1.54	112	1.20	—	—	—	—	—	—	
8.05	3.15	25.00	435	5.96	217	3.31	144	2.31	108	1.79	—	—	—	—	—	—	
8.22	4.12	33.50	426	8.85	213	4.93	141	3.43	106	2.64	—	—	—	—	—	—	
8.24	2.35	19.00	425	3.43	212	1.94	141	1.36	106	1.06	—	—	—	—	—	—	
8.46	3.00	25.00	414	5.50	207	3.06	137	2.13	103	1.65	—	—	—	—	—	—	
ARC-LENGTH CORRECTION FACTOR											0.0	0.0	0.0	0.0	0.0	0.0	0.0
8.81	2.20	19.00	397	2.94	199	1.68	132	1.19	99	0.93	—	—	—	—	—	—	
9.07	2.80	25.00	386	4.87	193	2.72	128	1.90	96	1.47	—	—	—	—	—	—	
9.29	3.65	33.50	377	7.48	188	4.15	125	2.89	94	2.23	—	—	—	—	—	—	
9.60	2.65	25.00	365	4.39	182	2.46	121	1.72	91	1.34	—	—	—	—	—	—	
10.14	3.35	33.50	345	6.57	173	3.65	114	2.54	86	1.97	—	—	—	—	—	—	
ARC-LENGTH CORRECTION FACTOR											0.0	0.0	0.0	0.0	0.0	0.0	0.0
10.18	2.50	25.00	344	3.91	172	2.20	114	1.54	85	1.20	—	—	—	—	—	—	
10.79	3.15	33.50	324	5.96	162	3.31	108	2.31	81	1.79	—	—	—	—	—	—	
10.85	2.35	25.00	323	3.43	161	1.94	107	1.36	80	1.06	—	—	—	—	—	—	
11.34	3.00	33.50	309	5.50	154	3.06	102	2.13	77	1.65	—	—	—	—	—	—	
11.60	2.20	25.00	302	2.94	151	1.68	100	1.19	75	0.93	—	—	—	—	—	—	
ARC-LENGTH CORRECTION FACTOR											0.0	0.0	0.0	0.0	0.0	0.0	0.0
12.16	2.80	33.50	288	4.87	144	2.72	95	1.90	72	1.47	—	—	—	—	—	—	
12.87	2.65	33.50	272	4.39	136	2.46	90	1.72	68	1.34	—	—	—	—	—	—	
13.65	2.50	33.50	256	3.92	128	2.20	85	1.54	64	1.20	—	—	—	—	—	—	
14.54	2.35	33.50	241	3.43	120	1.94	80	1.37	60	1.06	—	—	—	—	—	—	
15.56	2.20	33.50	225	2.94	112	1.68	75	1.19	56	0.93	—	—	—	—	—	—	
ARC-LENGTH CORRECTION FACTOR											0.0	0.0	0.0	0.0	0.0	0.0	0.0

3VX = COGGED/NOTCHED V-BELT VALUES ARE GIVEN FOR 3VX ONLY DUE TO GENERAL INDUSTRY TRENDS.

+ IF RIM SPEED EXCEEDS 6500 FEET PER MINUTE, CONSULT *Martin*.





Stock Drive 3V Selection

V-BELT DRIVES

Nominal Center Distances And Arc-Length Correction Factor															Sheave Combination		Speed Ratio
3VX Belt Length Designation															DriveR O.D.	DriveN O.D.	
600	630	670	710	800	850	900	950	1000	1060	1120	1180	1250	1320	1400			
—	—	—	—	—	—	18.9	21.8	24.5	27.8	31.0	34.1	37.8	41.4	45.5	4.75	25.00	5.31
15.9	17.5	19.6	21.7	26.3	28.9	31.4	33.9	36.5	39.5	42.5	45.6	49.1	52.6	56.6	2.65	14.00	5.37
—	—	—	—	—	—	19.1	21.9	24.7	28.0	31.1	34.3	37.9	41.6	45.7	4.50	25.00	5.61
—	—	—	—	—	—	—	—	—	—	—	24.0	28.1	32.0	36.4	6.00	33.50	5.62
16.0	17.6	19.7	21.8	26.4	29.0	31.5	34.1	36.6	39.6	42.7	45.7	49.2	52.7	56.7	2.50	14.00	5.69
0.88	0.90	0.92	0.94	0.98	1.00	1.01	1.02	1.04	1.05	1.06	1.08	1.09	1.10	1.11			
—	—	13.7	16.0	21.0	23.7	26.3	28.9	31.5	34.6	37.6	40.7	44.3	47.8	51.9	3.35	19.00	5.74
—	—	—	—	—	—	—	—	—	—	—	24.3	28.4	32.3	36.6	5.60	33.50	6.03
16.1	17.7	19.8	21.9	26.5	29.1	31.6	34.2	36.7	39.7	42.8	45.8	49.3	52.8	56.9	2.35	14.00	6.07
—	—	13.8	16.2	21.1	23.8	26.4	29.0	31.6	34.7	37.8	40.8	44.4	47.9	52.0	3.15	19.00	6.11
—	—	—	—	—	16.3	19.3	22.2	24.9	28.2	31.4	34.6	38.2	41.8	45.9	4.12	25.00	6.13
0.88	0.90	0.92	0.94	0.98	0.99	1.01	1.02	1.04	1.05	1.06	1.08	1.09	1.10	1.11			
—	—	—	—	—	—	—	—	—	—	—	24.5	28.5	32.5	36.8	5.30	33.50	6.37
—	—	13.9	16.3	21.2	23.9	26.5	29.1	31.7	34.8	37.9	40.9	44.5	48.1	52.1	3.00	19.00	6.42
16.2	17.8	19.9	22.0	26.6	29.2	31.7	34.3	36.8	39.8	42.9	45.9	49.4	52.9	57.0	2.20	14.00	6.49
—	—	—	—	—	—	—	—	—	—	20.9	24.6	28.7	32.7	37.0	5.00	33.50	6.76
—	—	14.0	16.4	21.3	24.0	26.6	29.3	31.8	34.9	38.0	41.1	44.6	48.2	52.3	2.80	19.00	6.89
0.88	0.90	0.92	0.94	0.98	0.99	1.01	1.02	1.04	1.05	1.06	1.08	1.09	1.10	1.11			
—	—	—	—	—	16.6	19.6	22.5	25.2	28.5	31.7	34.9	38.5	42.1	46.3	3.65	25.00	6.93
—	—	—	—	—	—	—	—	—	—	21.1	24.8	28.9	32.8	37.2	4.75	33.50	7.12
—	—	14.1	16.5	21.4	24.1	26.7	29.4	32.0	35.0	38.1	41.2	44.7	48.3	52.4	2.65	19.00	7.29
—	—	—	—	—	—	—	—	—	—	21.2	24.9	29.0	33.0	37.3	4.50	33.50	7.52
—	—	—	—	—	16.7	19.8	22.6	25.4	28.7	31.9	35.1	38.7	42.4	46.5	3.35	25.00	7.56
0.00	0.0	0.79	0.84	0.92	0.94	0.97	0.99	1.00	1.02	1.04	1.05	1.07	1.08	1.10			
—	—	14.2	16.6	21.5	24.2	26.8	29.5	32.1	35.1	38.2	41.3	44.9	48.4	52.5	2.50	19.00	7.73
—	—	—	—	—	16.8	19.9	22.8	25.6	28.8	32.0	35.2	38.9	42.5	46.6	3.15	25.00	8.05
—	—	—	—	—	—	—	—	—	—	21.4	25.2	29.3	33.2	37.6	4.12	33.50	8.22
—	—	14.3	16.7	21.6	24.3	26.9	29.6	32.2	35.2	38.3	41.4	45.0	48.5	52.6	2.35	19.00	8.24
—	—	—	—	—	16.9	20.0	22.9	25.7	28.9	32.1	35.3	39.0	42.6	46.7	3.00	25.00	8.46
0.00	0.0	0.79	0.84	0.91	0.94	0.96	0.98	1.00	1.02	1.04	1.05	1.07	1.08	1.10			
—	—	14.4	16.7	21.7	24.4	27.0	29.7	32.3	35.4	38.4	41.5	45.1	48.6	52.7	2.20	19.00	8.81
—	—	—	—	—	17.1	20.1	23.0	25.8	29.0	32.3	35.4	39.1	42.7	46.9	2.80	25.00	9.07
—	—	—	—	—	—	—	—	—	—	21.7	25.4	29.6	33.5	37.9	3.65	33.50	9.29
—	—	—	—	—	17.1	20.2	23.1	25.9	29.1	32.4	35.5	39.2	42.8	47.0	2.65	25.00	9.60
—	—	—	—	—	—	—	—	—	—	21.9	25.6	29.7	33.7	38.1	3.35	33.50	10.14
0.00	0.0	0.79	0.84	0.91	0.94	0.96	0.98	1.00	1.02	1.04	1.05	1.07	1.08	1.09			
—	—	—	—	—	17.2	20.3	23.2	26.0	29.2	32.5	35.6	39.3	42.9	47.1	2.50	25.00	10.18
—	—	—	—	—	—	—	—	—	—	22.0	25.7	29.9	33.8	38.2	3.15	33.50	10.79
—	—	—	—	—	17.3	20.4	23.3	26.1	29.3	32.5	35.7	39.4	43.0	47.2	2.35	25.00	10.85
—	—	—	—	—	—	—	—	—	—	22.1	25.8	30.0	33.9	38.3	3.00	33.50	11.34
—	—	—	—	—	17.4	20.5	23.4	26.2	29.4	32.6	35.8	39.5	43.1	47.3	2.20	25.00	11.60
0.00	0.0	0.0	0.0	0.0	0.77	0.85	0.89	0.93	0.96	0.98	1.01	1.03	1.05	1.07			
—	—	—	—	—	—	—	—	—	—	22.2	26.0	30.1	34.0	38.4	2.80	33.50	12.16
—	—	—	—	—	—	—	—	—	—	22.3	26.0	30.2	34.1	38.5	2.65	33.50	12.87
—	—	—	—	—	—	—	—	—	—	22.4	26.1	30.3	34.2	38.6	2.50	33.50	13.65
—	—	—	—	—	—	—	—	—	—	22.4	26.2	30.3	34.3	38.7	2.35	33.50	14.54
—	—	—	—	—	—	—	—	—	—	22.5	26.3	30.4	34.4	38.8	2.20	33.50	15.56
0.00	0.0	0.0	0.0	0.0	0.0	0.0	0.0	0.0	0.0	0.78	0.86	0.92	0.96	1.00			

FOR BELT SIZES NOT SHOWN, INTERPOLATE FOR ADDITIONAL CENTER DISTANCE.

5V Stock Drive Selection



V-BELT DRIVES

Speed Ratio	Sheave Combination		DriveN Speeds and HP Per Belt												Nominal Center Distance And Arc-Length Correction Factors		
			1750 RPM DriveR			1160 RPM DriveR			870 RPM DriveR			690 RPM DriveR					
	DriveR O.D.	DriveN O.D.	DriveN RPM	HP Per Belt 5V	HP Per Belt 5VX	DriveN RPM	HP Per Belt 5V	HP Per Belt 5VX	DriveN RPM	HP Per Belt 5V	HP Per Belt 5VX	DriveN RPM	HP Per Belt 5V	HP Per Belt 5VX	5V/5VX Belt Length Designation		
															500	600	710
1.00	4.40	4.40	1750	3.90	8.23	1160	3.09	5.90	870	2.56	4.64	690	2.18	3.82	18.1	23.1	28.6
1.00	4.65	4.65	1750	5.04	9.40	1160	3.89	6.71	870	3.17	5.26	690	2.67	4.32	17.7	22.7	28.2
1.00	4.90	4.90	1750	6.16	10.55	1160	4.67	7.51	870	3.78	5.88	690	3.17	4.81	17.3	22.3	27.8
1.00	5.20	5.20	1750	7.49	11.93	1160	5.61	8.46	870	4.51	6.61	690	3.76	5.41	16.8	21.8	27.3
1.00	5.50	5.50	1750	8.81	13.30	1160	6.55	9.42	870	5.23	7.35	690	4.34	6.00	16.4	21.4	26.9
ARC-LENGTH CORRECTION FACTOR															0.85	0.88	0.91
1.00	5.90	5.90	1750	10.55	15.11	1160	7.78	10.68	870	6.19	8.32	690	5.12	6.78	15.7	20.7	26.2
1.00	6.30	6.30	1750	12.26	16.89	1160	9.00	11.93	870	7.14	9.28	690	5.89	7.57	15.1	20.1	25.6
1.00	6.70	6.70	1750	13.94	18.66	1160	10.21	13.17	870	8.08	10.24	690	6.66	8.34	14.5	19.5	25.0
1.00	7.10	7.10	1750	15.60	20.41	1160	11.41	14.40	870	9.02	11.20	690	7.42	9.12	13.8	18.8	24.3
1.00	7.50	7.50	1750	17.22	22.13	1160	12.60	15.63	870	9.95	12.15	690	8.17	9.88	13.2	18.2	23.7
ARC-LENGTH CORRECTION FACTOR															0.85	0.88	0.91
1.00	8.00	8.00	1750	19.21	24.26	1160	14.07	17.15	870	11.10	13.33	690	9.12	10.84	12.4	17.4	22.9
1.00	8.50	8.50	1750	21.15	26.35	1160	15.52	18.65	870	12.24	14.50	690	10.05	11.79	11.6	16.6	22.1
1.00	9.00	9.00	1750	23.04	28.41	1160	16.95	20.14	870	13.38	15.66	690	10.98	12.74	—	15.9	21.4
1.00	9.25	9.25	1750	23.96	29.43	1160	17.66	20.89	870	13.94	16.24	690	11.44	13.21	—	15.5	21.0
1.00	9.75	9.75	1750	25.77	31.44	1160	19.06	22.36	870	15.06	17.39	690	12.36	14.15	—	14.7	20.2
ARC-LENGTH CORRECTION FACTOR															0.85	0.88	0.91
1.00	10.30	10.30	1750	27.70	33.60	1160	20.59	23.96	870	16.27	18.65	690	13.36	15.17	—	13.8	19.3
1.00	10.90	10.90	1750	29.72	35.91	1160	22.22	25.69	870	17.59	20.01	690	14.44	16.28	—	—	18.4
1.00	11.30	11.30	1750	31.03	37.42	1160	23.29	26.83	870	18.46	20.91	690	15.16	17.02	—	—	17.8
1.00	11.80	11.80	1750	32.60	39.27	1160	24.61	28.24	870	19.53	22.03	690	16.05	17.94	—	—	17.0
1.00	12.50	12.50	1750	34.70	41.78	1160	26.43	30.19	870	21.02	23.58	690	17.29	19.21	—	—	15.9
ARC-LENGTH CORRECTION FACTOR															0.85	0.88	0.91
1.00	13.20	13.20	1750	36.67	44.22	1160	28.20	32.12	870	22.49	25.12	690	18.51	20.48	—	—	—
1.00	14.00	14.00	1750	38.75	46.89	1160	30.17	34.28	870	24.14	26.87	690	19.90	21.91	—	—	—
1.00	15.00	15.00	+	+	+	1160	32.55	36.92	870	26.16	29.01	690	21.61	23.69	—	—	—
1.00	16.00	16.00	+	+	+	1160	34.83	39.50	870	28.14	31.13	690	23.29	25.45	—	—	—
1.03	9.00	9.25	1702	23.28	28.60	1128	17.12	20.27	846	13.50	15.75	671	11.07	12.81	—	15.7	21.2
ARC-LENGTH CORRECTION FACTOR															0.00	0.88	0.91
1.04	10.90	11.30	1687	30.05	36.16	1119	22.43	25.85	839	17.75	20.13	665	14.57	16.38	—	—	18.1
1.04	11.30	11.80	1675	31.35	37.66	1110	23.50	26.99	833	18.62	21.03	661	15.29	17.12	—	—	17.4
1.05	4.65	4.90	1659	5.43	9.70	1100	4.15	6.90	825	3.37	5.41	654	2.83	4.43	17.5	22.5	28.0
1.05	9.25	9.75	1659	24.35	29.73	1100	17.92	21.09	825	14.13	16.39	654	11.59	13.33	—	15.1	20.6
1.06	4.40	4.65	1654	4.36	8.58	1096	3.40	6.13	822	2.79	4.82	652	2.36	3.96	17.9	22.9	28.4
ARC-LENGTH CORRECTION FACTOR															0.85	0.88	0.91
1.06	4.90	5.20	1647	6.62	10.91	1092	4.98	7.74	819	4.01	6.05	649	3.35	4.95	17.1	22.1	27.6
1.06	5.20	5.50	1653	7.95	12.29	1096	5.92	8.70	822	4.74	6.79	652	3.94	5.55	16.6	21.6	27.1
1.06	6.30	6.70	1644	12.72	17.25	1090	9.31	12.16	817	7.37	9.46	648	6.07	7.70	14.8	19.8	25.3
1.06	6.70	7.10	1650	14.40	19.01	1094	10.52	13.40	820	8.31	10.42	651	6.84	8.48	14.2	19.2	24.7
1.06	7.10	7.50	1655	16.06	20.76	1097	11.72	14.64	823	9.25	11.37	653	7.60	9.25	13.5	18.5	24.0
ARC-LENGTH CORRECTION FACTOR															0.85	0.88	0.91
1.06	8.00	8.50	1646	19.67	24.61	1091	14.37	17.38	818	11.33	13.50	649	9.30	10.98	12.0	17.0	22.5
1.06	8.50	9.00	1652	21.61	26.71	1095	15.83	18.89	821	12.47	14.67	651	10.23	11.93	11.3	16.3	21.8
1.06	9.75	10.30	1656	26.23	31.79	1097	19.37	22.59	823	15.29	17.56	653	12.54	14.28	—	14.3	19.8
1.06	10.30	10.90	1653	28.16	33.95	1096	20.89	24.19	822	16.50	18.82	652	13.54	15.31	—	13.3	18.8
1.06	11.80	12.50	1651	33.06	39.62	1095	24.92	28.47	821	19.76	22.21	651	16.23	18.08	—	—	16.4
ARC-LENGTH CORRECTION FACTOR															0.85	0.88	0.91
1.06	12.50	13.20	1656	35.16	42.14	1098	26.73	30.43	824	21.25	23.76	653	17.47	19.35	—	—	15.3
1.06	13.20	14.00	1649	37.12	44.57	1093	28.50	32.35	820	22.72	25.30	650	18.69	20.62	—	—	—
1.07	5.50	5.90	1629	9.34	13.70	1080	6.89	9.68	810	5.49	7.55	642	4.55	6.16	16.0	21.0	26.5
1.07	5.90	6.30	1637	11.07	15.51	1085	8.13	10.94	814	6.45	8.52	645	5.32	6.94	15.4	20.4	25.9
1.07	7.50	8.00	1639	17.74	22.54	1087	12.95	15.90	815	10.21	12.35	646	8.38	10.04	12.8	17.8	23.3
ARC-LENGTH CORRECTION FACTOR															0.85	0.88	0.91
1.07	14.00	15.00	1633	39.27	47.29	1082	30.51	34.55	812	24.40	27.06	644	20.10	22.07	—	—	—
1.07	15.00	16.00	+	+	+	1087	32.89	37.19	815	26.42	29.21	647	21.81	23.85	—	—	—
1.08	9.00	9.75	1614	23.62	28.86	1070	17.34	20.44	802	13.67	15.88	636	11.21	12.91	—	15.3	20.8
1.08	10.90	11.80	1615	30.31	36.36	1071	22.61	25.98	803	17.88	20.23	637	14.67	16.46	—	—	17.7
1.09	8.50	9.25	1607	21.79	26.85	1065	15.95	18.98	799	12.56	14.74	633	10.30	11.99	11.1	16.1	21.6
ARC-LENGTH CORRECTION FACTOR															0.84	0.88	0.90

5V = STANDARD V-BELT
 5VX = COGGED/NOTCHED V-BELT
 + IF RIM SPEED EXCEEDS 6500 FEET PER MINUTE, CONSULT *Martin*.





Stock Drive Selection 5V

Nominal Center Distances And Arc-Length Correction Factor															Sheave Combination		Speed Ratio
5V/5VX Belt Length Designation															DriveR O.D.	DriveN O.D.	
800	900	1000	1120	1250	1320	1400	1600	1800	2000	2240	2500	2800	3150	3550			
33.1	38.1	43.1	49.1	55.6	59.1	63.1	73.1	83.1	93.1	105.1	118.1	133.1	150.6	170.6	4.40	4.40	1.00
32.7	37.7	42.7	48.7	55.2	58.7	62.7	72.7	82.7	92.7	104.7	117.7	132.7	150.2	170.2	4.65	4.65	1.00
32.3	37.3	42.3	48.3	54.8	58.3	62.3	72.3	82.3	92.3	104.3	117.3	132.3	149.8	169.8	4.90	4.90	1.00
31.8	36.8	41.8	47.8	54.3	57.8	61.8	71.8	81.8	91.8	103.8	116.8	131.8	149.3	169.3	5.20	5.20	1.00
31.4	36.4	41.4	47.4	53.9	57.4	61.4	71.4	81.4	91.4	103.4	116.4	131.4	148.9	168.9	5.50	5.50	1.00
0.93	0.95	0.96	0.98	1.00	1.01	1.02	1.04	1.06	1.08	1.09	1.11	1.13	1.15	1.17			
30.7	35.7	40.7	46.7	53.2	56.7	60.7	70.7	80.7	90.7	102.7	115.7	130.7	148.2	168.2	5.90	5.90	1.00
30.1	35.1	40.1	46.1	52.6	56.1	60.1	70.1	80.1	90.1	102.1	115.1	130.1	147.6	167.6	6.30	6.30	1.00
29.5	34.5	39.5	45.5	52.0	55.5	59.5	69.5	79.5	89.5	101.5	114.5	129.5	147.0	167.0	6.70	6.70	1.00
28.8	33.8	38.8	44.8	51.3	54.8	58.8	68.8	78.8	88.8	100.8	113.8	128.8	146.3	166.3	7.10	7.10	1.00
28.2	33.2	38.2	44.2	50.7	54.2	58.2	68.2	78.2	88.2	100.2	113.2	128.2	145.7	165.7	7.50	7.50	1.00
0.93	0.95	0.96	0.98	1.00	1.01	1.02	1.04	1.06	1.08	1.09	1.11	1.13	1.15	1.17			
27.4	32.4	37.4	43.4	49.9	53.4	57.4	67.4	77.4	87.4	99.4	112.4	127.4	144.9	164.9	8.00	8.00	1.00
26.6	31.6	36.6	42.6	49.1	52.6	56.6	66.6	76.6	86.6	98.6	111.6	126.6	144.1	164.1	8.50	8.50	1.00
25.9	30.9	35.9	41.9	48.4	51.9	55.9	65.9	75.9	85.9	97.9	110.9	125.9	143.4	163.4	9.00	9.00	1.00
25.5	30.5	35.5	41.5	48.0	51.5	55.5	65.5	75.5	85.5	97.5	110.5	125.5	143.0	163.0	9.25	9.25	1.00
24.7	29.7	34.7	40.7	47.2	50.7	54.7	64.7	74.7	84.7	96.7	109.7	124.7	142.2	162.2	9.75	9.75	1.00
0.93	0.95	0.96	0.98	1.00	1.01	1.02	1.04	1.06	1.08	1.09	1.11	1.13	1.15	1.17			
23.8	28.8	33.8	39.8	46.3	49.8	53.8	63.8	73.8	83.8	95.8	108.8	123.8	141.3	161.3	10.30	10.30	1.00
22.9	27.9	32.9	38.9	45.4	48.9	52.9	62.9	72.9	82.9	94.9	107.9	122.9	140.4	160.4	10.90	10.90	1.00
22.3	27.3	32.3	38.3	44.8	48.3	52.3	62.3	72.3	82.3	94.3	107.3	122.2	139.8	159.7	11.30	11.30	1.00
21.5	26.5	31.5	37.5	44.0	47.5	51.5	61.5	71.5	81.5	93.5	106.5	121.5	139.0	159.0	11.80	11.80	1.00
20.4	25.4	30.4	36.4	42.9	46.4	50.4	60.4	70.4	80.4	92.4	105.4	120.4	137.9	157.9	12.50	12.50	1.00
0.93	0.95	0.96	0.98	1.00	1.01	1.02	1.04	1.06	1.08	1.09	1.11	1.13	1.15	1.17			
19.3	24.3	29.3	35.3	41.8	45.3	49.3	59.3	69.3	79.3	91.3	104.3	119.3	136.8	156.8	13.20	13.20	1.00
18.0	23.0	28.0	34.0	40.5	44.0	48.0	58.0	68.0	78.0	90.0	103.0	118.0	135.5	155.5	14.00	14.00	1.00
—	21.4	26.4	32.4	38.9	42.4	46.4	56.4	66.4	76.4	88.4	101.4	116.4	133.9	153.9	15.00	15.00	1.00
—	19.9	24.9	30.9	37.4	40.9	44.9	54.9	64.9	74.9	86.9	99.9	114.9	132.4	152.4	16.00	16.00	1.00
25.7	30.7	35.7	41.7	48.2	51.7	55.7	65.7	75.7	85.7	97.7	110.7	125.7	143.2	163.2	9.00	9.25	1.03
0.93	0.95	0.96	0.98	1.00	1.01	1.02	1.04	1.06	1.08	1.09	1.11	1.13	1.15	1.17			
22.6	27.6	32.6	38.6	45.1	48.6	52.6	62.6	72.6	82.6	94.6	107.6	122.6	140.1	160.1	10.90	11.30	1.04
21.9	26.9	31.9	37.9	44.4	47.9	51.9	61.9	71.9	81.9	93.9	106.9	121.9	139.4	159.4	11.30	11.80	1.04
32.5	37.5	42.5	48.5	55.0	58.5	62.5	72.5	82.5	92.5	104.5	117.5	132.5	150.0	170.0	4.65	4.90	1.05
25.1	30.1	35.1	41.1	47.6	51.1	55.1	65.1	75.1	85.1	97.1	110.1	125.1	142.6	162.6	9.25	9.75	1.05
32.9	37.9	42.9	48.9	55.4	58.9	62.9	72.9	82.9	92.9	104.9	117.9	132.9	150.4	170.4	4.40	4.65	1.06
0.93	0.95	0.96	0.98	1.00	1.01	1.02	1.04	1.06	1.08	1.09	1.11	1.13	1.15	1.17			
32.1	37.1	42.1	48.1	54.6	58.1	62.1	72.1	82.1	92.1	104.1	117.1	132.1	149.6	169.6	4.90	5.20	1.06
31.6	36.6	41.6	47.6	54.1	57.6	61.6	71.6	81.6	91.6	103.6	116.6	131.6	149.1	169.1	5.20	5.50	1.06
29.8	34.8	39.8	45.8	52.3	55.8	59.8	69.8	79.8	89.8	101.8	114.8	129.8	147.3	167.3	6.30	6.70	1.06
29.2	34.2	39.2	45.2	51.7	55.2	59.2	69.2	79.2	89.2	101.2	114.2	129.2	146.7	166.7	6.70	7.10	1.06
28.5	33.5	38.5	44.5	51.0	54.5	58.5	68.5	78.5	88.5	100.5	113.5	128.5	146.0	166.0	7.10	7.50	1.06
0.93	0.95	0.96	0.98	1.00	1.01	1.02	1.04	1.06	1.08	1.09	1.11	1.13	1.15	1.17			
27.0	32.0	37.0	43.0	49.5	53.0	57.0	67.0	77.0	87.0	99.0	112.0	127.0	144.5	164.5	8.00	8.50	1.06
26.3	31.3	36.3	42.3	48.8	52.3	56.3	66.3	76.3	86.3	98.3	111.3	126.3	143.8	163.8	8.50	9.00	1.06
24.3	29.3	34.3	40.3	46.8	50.3	54.3	64.3	74.3	84.3	96.3	109.3	124.3	141.8	161.8	9.75	10.30	1.06
23.3	28.3	33.3	39.3	45.8	49.3	53.3	63.3	73.3	83.3	95.3	108.3	123.3	140.8	160.8	10.30	10.90	1.06
20.9	25.9	30.9	36.9	43.4	46.9	50.9	60.9	70.9	80.9	92.9	105.9	120.9	138.4	158.4	11.80	12.50	1.06
0.93	0.94	0.96	0.98	1.00	1.01	1.02	1.04	1.06	1.08	1.09	1.11	1.13	1.15	1.17			
19.8	24.8	29.8	35.8	42.3	45.8	49.8	59.8	69.8	79.8	91.8	104.8	119.8	137.3	157.3	12.50	13.20	1.06
18.6	23.6	28.6	34.6	41.1	44.6	48.6	58.6	68.6	78.6	90.6	103.6	118.6	136.1	156.1	13.20	14.00	1.06
31.0	36.0	41.0	47.0	53.5	57.0	61.0	71.0	81.0	91.0	103.0	116.0	131.0	148.5	168.5	5.50	5.90	1.07
30.4	35.4	40.4	46.4	52.9	56.4	60.4	70.4	80.4	90.4	102.4	115.4	130.4	147.9	167.9	5.90	6.30	1.07
27.8	32.8	37.8	43.8	50.3	53.8	57.8	67.8	77.8	87.8	99.8	112.8	127.8	145.3	165.3	7.50	8.00	1.07
0.93	0.95	0.96	0.98	1.00	1.01	1.02	1.04	1.06	1.08	1.09	1.11	1.13	1.15	1.17			
17.2	22.2	27.2	33.2	39.7	43.2	47.2	57.2	67.2	77.2	89.2	102.2	117.2	134.7	154.7	14.00	15.00	1.07
—	20.6	25.6	31.6	38.1	41.6	45.6	55.6	65.6	75.6	87.6	100.6	115.6	133.2	153.2	15.00	16.00	1.07
25.3	30.3	35.3	41.3	47.8	51.3	55.3	65.3	75.3	85.3	97.3	110.3	125.3	142.8	162.8	9.00	9.75	1.08
22.2	27.2	32.2	38.2	44.7	48.2	52.2	62.2	72.2	82.2	94.2	107.2	122.2	139.7	159.7	10.90	11.80	1.08
26.1	31.1	36.1	42.1	48.6	52.1	56.1	66.1	76.1	86.1	98.1	111.1	126.1	143.6	163.6	8.50	9.25	1.09
0.92	0.94	0.96	0.98	1.00	1.01	1.02	1.04	1.06	1.08	1.09	1.11	1.13	1.15	1.17			

FOR BELT SIZES NOT SHOWN, INTERPOLATE FOR ADDITIONAL CENTER DISTANCE.

V-BELT DRIVES

5V Stock Drive Selection



V-BELT DRIVES

Speed Ratio	Sheave Combination		DriveN Speeds and HP Per Belt												Nominal Center Distance And Arc-Length Correction Factors		
			1750 RPM DriveR			1160 RPM DriveR			870 RPM DriveR			690 RPM DriveR					
	DriveR O.D.	DriveN O.D.	DriveN RPM	HP Per Belt 5V	HP Per Belt 5VX	DriveN RPM	HP Per Belt 5V	HP Per Belt 5VX	DriveN RPM	HP Per Belt 5V	HP Per Belt 5VX	DriveN RPM	HP Per Belt 5V	HP Per Belt 5VX	5V/5VX Belt Length Designation		
															500	600	710
1.10	10.30	11.30	1594	28.40	34.14	1056	21.05	24.31	792	16.62	18.91	628	13.63	15.38	—	13.0	18.5
1.11	9.25	10.30	1570	24.71	30.01	1041	18.16	21.27	780	14.31	16.52	619	11.73	13.44	—	14.6	20.1
1.11	11.30	12.50	1581	31.78	37.99	1048	23.79	27.21	786	18.83	21.20	623	15.46	17.25	—	—	16.8
1.12	4.40	4.90	1568	4.70	8.84	1039	3.62	6.31	779	2.96	4.95	618	2.49	4.06	17.7	22.7	28.2
1.12	4.65	5.20	1561	5.83	10.01	1035	4.42	7.11	776	3.57	5.57	616	2.99	4.56	17.3	22.3	27.8
ARC-LENGTH CORRECTION FACTOR															0.85	0.88	0.91
1.12	4.90	5.50	1556	6.96	11.17	1031	5.20	7.91	773	4.18	6.18	613	3.48	5.06	16.8	21.8	27.3
1.12	6.70	7.50	1561	14.74	19.28	1035	10.74	13.58	776	8.48	10.55	615	6.97	8.58	13.8	18.8	24.3
1.12	9.75	10.90	1564	26.57	32.05	1036	19.59	22.76	777	15.45	17.70	617	12.67	14.39	—	13.8	19.3
1.12	11.80	13.20	1563	33.40	39.88	1036	25.14	28.65	777	19.93	22.34	616	16.37	18.18	—	—	15.8
1.12	12.50	14.00	1561	35.50	42.40	1035	26.96	30.60	776	21.42	23.89	616	17.60	19.46	—	—	—
ARC-LENGTH CORRECTION FACTOR															0.85	0.88	0.91
1.13	6.30	7.10	1550	13.11	17.55	1027	9.57	12.36	771	7.56	9.61	611	6.22	7.82	14.5	19.5	25.0
1.13	7.10	8.00	1551	16.44	21.06	1028	11.98	14.84	771	9.44	11.52	611	7.75	9.37	13.1	18.1	23.6
1.13	8.00	9.00	1553	20.06	24.91	1030	14.63	17.58	772	11.52	13.65	612	9.45	11.10	11.6	16.6	22.1
1.14	5.20	5.90	1539	8.39	12.62	1020	6.21	8.92	765	4.95	6.95	607	4.11	5.68	16.3	21.3	26.8
1.14	5.90	6.70	1538	11.44	15.79	1019	8.37	11.13	765	6.63	8.66	606	5.47	7.06	15.1	20.1	25.6
ARC-LENGTH CORRECTION FACTOR															0.85	0.88	0.90
1.14	7.50	8.50	1542	18.11	22.82	1022	13.19	16.08	766	10.39	12.49	608	8.53	10.16	12.4	17.4	22.9
1.14	13.20	15.00	1539	37.56	44.90	1020	28.79	32.57	765	22.93	25.47	607	18.87	20.75	—	—	—
1.14	14.00	16.00	1530	39.64	47.58	1014	30.76	34.73	761	24.58	27.21	603	20.25	22.19	—	—	—
1.15	5.50	6.30	1524	9.75	14.02	1010	7.17	9.89	758	5.70	7.70	601	4.71	6.28	15.7	20.7	26.2
1.15	8.50	9.75	1523	22.08	27.07	1010	16.14	19.13	757	12.71	14.85	601	10.42	12.08	—	15.7	21.2
ARC-LENGTH CORRECTION FACTOR															0.84	0.87	0.90
1.15	9.00	10.30	1527	23.97	29.13	1012	17.57	20.62	759	13.84	16.02	602	11.35	13.02	—	14.8	20.3
1.15	10.30	11.80	1526	28.64	34.32	1011	21.21	24.43	758	16.74	19.00	602	13.73	15.45	—	—	18.1
1.15	10.90	12.50	1524	30.66	36.63	1010	22.84	26.16	758	18.05	20.37	601	14.81	16.57	—	—	17.1
1.16	8.00	9.25	1511	20.18	25.01	1002	14.72	17.65	751	11.59	13.70	596	9.50	11.14	11.4	16.4	21.9
1.16	9.75	11.30	1508	26.75	32.19	999	19.71	22.85	750	15.54	17.76	595	12.74	14.44	—	13.4	19.0
ARC-LENGTH CORRECTION FACTOR															0.84	0.87	0.90
1.17	11.30	13.20	1496	32.04	38.20	992	23.96	27.34	744	18.96	21.30	590	15.56	17.33	—	—	16.2
1.17	16.00	18.70	+	+	+	992	35.50	40.02	744	28.64	31.52	590	23.69	25.76	—	—	—
1.18	9.25	10.90	1483	25.01	30.24	983	18.36	21.42	737	14.46	16.64	585	11.85	13.53	—	14.2	19.7
1.19	4.40	5.20	1475	4.99	9.07	978	3.82	6.45	734	3.10	5.06	582	2.61	4.15	17.5	22.5	28.0
1.19	4.65	5.50	1475	6.12	10.23	977	4.61	7.26	733	3.71	5.68	581	3.10	4.65	17.0	22.0	27.5
ARC-LENGTH CORRECTION FACTOR															0.85	0.88	0.91
1.19	6.30	7.50	1466	13.35	17.73	972	9.73	12.48	729	7.68	9.70	578	6.32	7.90	14.1	19.2	24.7
1.19	11.80	14.00	1473	33.69	41.10	976	25.33	28.79	732	20.07	22.45	581	16.48	18.27	—	—	15.2
1.20	6.70	8.00	1462	15.07	19.52	969	10.96	13.74	727	8.64	10.67	576	7.10	8.68	13.4	18.4	23.9
1.20	7.10	8.50	1458	16.72	21.27	967	12.16	14.98	725	9.58	11.63	575	7.86	9.46	12.7	17.7	23.2
1.20	7.50	9.00	1455	18.34	23.00	964	13.35	16.20	723	10.51	12.58	574	8.62	10.22	12.0	17.0	22.5
ARC-LENGTH CORRECTION FACTOR															0.84	0.87	0.90
1.20	12.50	15.00	1456	35.82	42.65	965	27.17	30.76	724	21.58	24.01	574	17.73	19.55	—	—	—
1.21	4.90	5.90	1448	7.31	11.44	960	5.44	8.10	720	4.36	6.32	571	3.62	5.16	16.5	21.5	27.0
1.21	5.90	7.10	1450	11.71	16.00	961	8.55	11.27	721	6.76	8.76	572	5.57	7.13	14.8	19.8	25.3
1.21	8.50	10.30	1441	22.30	27.24	955	16.29	19.24	716	12.82	14.94	568	10.50	12.14	—	15.2	20.7
1.21	9.00	10.90	1442	24.19	29.30	956	17.72	20.73	717	13.95	16.10	569	11.43	13.09	—	14.3	19.8
ARC-LENGTH CORRECTION FACTOR															0.84	0.88	0.90
1.21	9.75	11.80	1443	26.93	32.32	957	19.83	22.94	718	15.63	17.83	569	12.81	14.50	—	13.0	18.5
1.21	10.90	13.20	1443	30.88	36.80	956	22.98	26.27	717	18.16	20.45	569	14.90	16.63	—	—	16.5
1.21	13.20	16.00	1442	37.82	45.10	956	28.96	32.71	717	23.06	25.57	568	18.97	20.83	—	—	—
1.22	5.20	6.30	1440	8.68	12.84	954	6.40	9.07	716	5.10	7.07	568	4.22	5.77	16.0	21.0	26.5
1.22	5.50	6.70	1432	10.00	14.21	949	7.33	10.02	712	5.82	7.80	565	4.81	6.36	15.4	20.3	25.9
ARC-LENGTH CORRECTION FACTOR															0.84	0.88	0.90
1.22	8.00	9.75	1433	20.39	25.17	950	14.86	17.75	712	11.69	13.78	565	9.58	11.20	—	16.0	21.5
1.22	9.25	11.30	1430	25.15	30.34	948	18.45	21.49	711	14.53	16.69	564	11.91	13.57	—	13.8	19.3
1.22	10.30	12.50	1440	28.89	34.51	954	21.37	24.56	716	16.86	19.10	568	13.83	15.53	—	—	17.6
1.24	7.50	9.25	1415	18.46	23.09	938	13.43	16.26	704	10.57	12.62	558	8.67	10.26	11.8	16.8	22.3
1.24	11.30	14.00	1410	32.27	38.37	935	24.11	27.46	701	19.08	21.39	556	15.65	17.40	—	—	15.6
ARC-LENGTH CORRECTION FACTOR															0.83	0.87	0.90

5V = STANDARD V-BELT
 5VX = COGGED/NOTCHED V-BELT
 + IF RIM SPEED EXCEEDS 6500 FEET PER MINUTE, CONSULT *Martin*.





Stock Drive 5V Selection

V-BELT DRIVES

Nominal Center Distances And Arc-Length Correction Factor															Sheave Combination		Speed Ratio
5V/5VX Belt Length Designation															DriveR O.D.	DriveN O.D.	
800	900	1000	1120	1250	1320	1400	1600	1800	2000	2240	2500	2800	3150	3550			
23.0	28.0	33.0	39.0	45.5	49.0	53.0	63.0	73.0	83.0	95.0	108.0	123.0	140.5	160.5	10.30	11.30	1.10
24.6	29.6	34.6	40.6	47.1	50.6	54.6	64.6	74.6	84.6	96.6	109.6	124.6	142.1	162.1	9.25	10.30	1.11
21.3	26.3	31.3	37.3	43.8	47.3	51.3	61.3	71.3	81.3	93.3	106.3	121.3	138.8	158.8	11.30	12.50	1.11
32.7	37.7	42.7	48.7	55.2	58.7	62.7	72.7	82.7	92.7	104.7	117.7	132.7	150.2	170.2	4.40	4.90	1.12
32.3	37.3	42.3	48.3	54.8	58.3	62.3	72.3	82.3	92.3	104.3	117.3	132.3	149.8	169.8	4.65	5.20	1.12
0.93	0.95	0.96	0.98	1.00	1.01	1.02	1.04	1.06	1.08	1.09	1.11	1.13	1.15	1.17			
31.8	36.8	41.8	47.8	54.3	57.8	61.8	71.8	81.8	91.8	103.8	116.8	131.8	149.3	169.3	4.90	5.50	1.12
28.8	33.8	38.8	44.8	51.3	54.8	58.8	68.8	78.8	88.8	100.8	113.8	128.8	146.3	166.3	6.70	7.50	1.12
23.8	28.8	33.8	39.8	46.3	49.8	53.8	63.8	73.8	83.8	95.8	108.8	123.8	141.3	161.3	9.75	10.90	1.12
20.4	25.4	30.4	36.4	42.9	46.4	50.4	60.4	70.4	80.4	92.4	105.4	120.4	137.9	157.9	11.80	13.20	1.12
19.2	24.2	29.2	35.2	41.7	45.2	49.2	59.2	69.2	79.2	91.2	104.2	119.2	136.7	156.7	12.50	14.00	1.12
0.93	0.94	0.96	0.98	1.00	1.01	1.02	1.04	1.06	1.08	1.09	1.11	1.13	1.15	1.17			
29.5	34.5	39.5	45.5	52.0	55.5	59.5	69.5	79.5	89.5	101.5	114.5	129.5	147.0	167.0	6.30	7.10	1.13
28.1	33.1	38.1	44.1	50.6	54.1	58.1	68.1	78.1	88.1	100.1	113.1	128.1	145.6	165.6	7.10	8.00	1.13
26.6	31.6	36.6	42.6	49.1	52.6	56.6	66.6	76.6	86.6	98.6	111.6	126.6	144.1	164.1	8.00	9.00	1.13
31.3	36.3	41.3	47.3	53.8	57.3	61.3	71.3	81.3	91.3	103.3	116.3	131.3	148.8	168.8	5.50	5.90	1.14
30.1	35.1	40.1	46.1	52.6	56.1	60.1	70.1	80.1	90.1	102.1	115.1	130.1	147.6	167.6	5.90	6.70	1.14
0.92	0.94	0.96	0.98	1.00	1.01	1.02	1.04	1.06	1.08	1.09	1.11	1.13	1.15	1.17			
27.4	32.4	37.4	43.4	49.9	53.4	57.4	67.4	77.4	87.4	99.4	112.4	127.4	144.9	164.9	7.50	8.50	1.14
17.8	22.8	27.8	33.8	40.3	43.8	47.8	57.8	67.8	77.8	89.8	102.8	117.8	135.3	155.3	13.20	15.00	1.14
—	21.4	26.4	32.4	38.9	42.4	46.4	56.4	66.4	76.4	88.4	101.4	116.4	133.9	153.9	14.00	16.00	1.14
30.7	35.7	40.7	46.7	53.2	56.7	60.7	70.7	80.7	90.7	102.7	115.7	130.7	148.2	168.2	5.50	6.30	1.15
25.7	30.7	35.7	41.7	48.2	51.7	55.7	65.7	75.7	85.7	97.7	110.7	125.7	143.2	163.2	8.50	9.75	1.15
0.92	0.94	0.96	0.98	1.00	1.01	1.02	1.04	1.06	1.07	1.09	1.11	1.13	1.15	1.17			
24.8	29.8	34.8	40.8	47.3	50.8	54.8	64.8	74.8	84.8	96.8	109.8	124.8	142.3	162.3	9.00	10.30	1.15
22.6	27.6	32.6	38.6	45.1	48.6	52.6	62.6	72.6	82.6	94.6	107.6	122.6	140.1	160.1	10.30	11.80	1.15
21.6	26.6	31.6	37.6	44.1	47.6	51.6	61.6	71.6	81.6	93.6	106.6	121.6	139.1	159.1	10.90	12.50	1.15
26.4	31.4	36.4	42.4	48.9	52.4	56.4	66.4	76.4	86.4	98.4	111.5	126.5	144.0	164.0	8.00	9.25	1.16
23.5	28.5	33.5	39.5	46.0	49.5	53.5	63.5	73.5	83.5	95.5	108.5	123.5	141.0	161.0	9.75	11.30	1.16
0.92	0.94	0.96	0.98	1.00	1.01	1.02	1.04	1.06	1.07	1.09	1.11	1.13	1.15	1.17			
20.7	25.7	30.7	36.7	43.2	46.7	50.7	60.7	70.7	80.7	92.7	105.7	120.7	138.3	158.3	11.30	13.20	1.17
—	—	22.7	28.7	35.2	38.7	42.7	52.7	62.7	72.7	84.7	97.7	112.7	130.2	150.2	16.00	18.70	1.17
24.2	29.2	34.2	40.2	46.7	50.2	54.2	64.2	74.2	84.2	96.2	109.2	124.2	141.7	161.7	9.25	10.90	1.18
32.5	37.5	42.5	48.5	55.0	58.5	62.5	72.5	82.5	92.5	104.5	117.5	132.5	150.0	170.0	4.40	5.20	1.19
32.0	37.0	42.0	48.0	54.5	58.0	62.0	72.0	82.0	92.0	104.0	117.0	132.0	149.5	169.5	4.65	5.50	1.19
0.92	0.94	0.96	0.98	1.00	1.01	1.02	1.04	1.06	1.08	1.09	1.11	1.13	1.15	1.17			
29.2	34.2	39.2	45.2	51.7	55.2	59.2	69.2	79.2	89.2	101.2	114.2	129.2	146.7	166.7	6.30	7.50	1.19
19.7	24.7	29.7	35.7	42.2	45.7	49.7	59.7	69.7	79.7	91.7	104.7	119.7	137.2	157.2	11.80	14.00	1.19
28.4	33.4	38.4	44.4	51.0	54.5	58.5	68.5	78.5	88.5	100.5	113.5	128.5	146.0	166.0	6.70	8.00	1.20
27.7	32.7	37.7	43.7	50.2	53.7	57.7	67.7	77.7	87.7	99.7	112.7	127.7	145.2	165.2	7.10	8.50	1.20
27.0	32.0	37.0	43.0	49.5	53.0	57.0	67.0	77.0	87.0	99.0	112.0	127.0	144.5	164.5	7.50	9.00	1.20
0.92	0.94	0.96	0.98	1.00	1.01	1.02	1.04	1.06	1.07	1.09	1.11	1.13	1.15	1.17			
18.4	23.4	28.4	34.4	40.9	44.4	48.4	58.4	68.4	78.4	90.4	103.4	118.4	135.9	155.9	12.50	15.00	1.20
31.5	36.5	41.5	47.5	54.0	57.5	61.5	71.5	81.5	91.5	103.5	116.5	131.5	149.0	169.0	4.90	5.90	1.21
29.8	34.8	39.8	45.8	52.3	55.8	59.8	69.8	79.8	89.8	101.8	114.8	129.8	147.3	167.3	5.90	7.10	1.21
25.2	30.2	35.2	41.2	47.7	51.2	55.2	65.2	75.2	85.2	97.2	110.2	125.2	142.7	162.7	8.50	10.30	1.21
24.4	29.4	34.4	40.4	46.9	50.4	54.4	64.4	74.4	84.4	96.4	109.4	124.4	141.9	161.9	9.00	10.90	1.21
0.92	0.94	0.96	0.98	1.00	1.01	1.02	1.04	1.06	1.07	1.09	1.11	1.13	1.15	1.17			
23.1	28.1	33.1	39.1	45.6	49.1	53.1	63.1	73.1	83.1	95.1	108.1	123.1	140.6	160.6	9.75	11.80	1.21
21.0	26.0	31.0	37.0	43.6	47.1	51.1	61.1	71.1	81.1	93.1	106.1	121.1	138.6	158.6	10.90	13.20	1.21
17.0	22.0	27.0	33.0	39.5	43.0	47.0	57.0	67.0	77.0	89.0	102.0	117.0	134.6	154.6	13.20	16.00	1.21
31.0	36.0	41.0	47.0	53.5	57.0	61.0	71.0	81.0	91.0	103.0	116.0	131.0	148.5	168.5	5.20	6.30	1.22
30.4	35.4	40.4	46.4	52.9	56.4	60.4	70.4	80.4	90.4	102.4	115.4	130.4	147.9	167.9	5.50	6.70	1.22
0.92	0.94	0.96	0.98	1.00	1.01	1.02	1.04	1.06	1.07	1.09	1.11	1.13	1.15	1.17			
26.0	31.0	36.0	42.0	48.6	52.1	56.1	66.1	76.1	86.1	98.1	111.1	126.1	143.6	163.6	8.00	9.75	1.22
23.8	28.8	33.8	39.8	46.3	49.8	53.8	63.8	73.8	83.8	95.8	108.8	123.8	141.4	161.4	9.25	11.30	1.22
22.1	27.1	32.1	38.1	44.6	48.1	52.1	62.1	72.1	82.1	94.1	107.1	122.1	139.6	159.6	10.30	12.50	1.22
26.8	31.8	36.8	42.8	49.3	52.8	56.8	66.8	76.8	86.8	98.8	111.8	126.8	144.3	164.3	7.50	9.25	1.24
20.1	25.1	30.1	36.1	42.6	46.1	50.1	60.1	70.1	80.1	92.1	105.1	120.1	137.6	157.6	11.30	14.00	1.24
0.92	0.94	0.96	0.98	1.00	1.00	1.01	1.04	1.06	1.07	1.09	1.11	1.13	1.15	1.17			

FOR BELT SIZES NOT SHOWN, INTERPOLATE FOR ADDITIONAL CENTER DISTANCE.

5V Stock Drive Selection



V-BELT DRIVES

Speed Ratio	Sheave Combination		Driven Speeds and HP Per Belt												Nominal Center Distance And Arc-Length Correction Factors		
			1750 RPM DriveR			1160 RPM DriveR			870 RPM DriveR			690 RPM DriveR					
	DriveR O.D.	DriveN O.D.	DriveN RPM	HP Per Belt 5V	HP Per Belt 5VX	DriveN RPM	HP Per Belt 5V	HP Per Belt 5VX	DriveN RPM	HP Per Belt 5V	HP Per Belt 5VX	DriveN RPM	HP Per Belt 5V	HP Per Belt 5VX	5V/5VX Belt Length Designation		
															500	600	710
1.25	15.00	18.70	+	+	+	929	33.39	37.57	697	26.79	29.50	553	22.11	24.08	—	—	—
1.26	4.40	5.50	1394	5.20	9.23	924	3.95	6.56	693	3.21	5.14	549	2.69	4.21	17.2	22.2	27.7
1.26	9.00	11.30	1391	24.33	29.41	922	17.81	20.81	691	14.02	16.15	548	11.49	13.13	—	14.0	19.5
1.27	4.65	5.90	1373	6.36	10.41	910	4.76	7.38	682	3.83	5.77	541	3.20	4.72	16.7	21.7	27.2
1.27	6.30	8.00	1373	13.58	17.91	910	9.88	12.60	683	7.80	9.79	542	6.41	7.97	13.7	18.7	24.3
ARC-LENGTH CORRECTION FACTOR															0.84	0.88	0.90
1.27	6.70	8.50	1375	15.26	19.68	911	11.09	13.84	684	8.74	10.75	542	7.18	8.74	13.0	18.0	23.5
1.27	7.10	9.00	1376	16.92	21.42	912	12.29	15.08	684	9.67	11.70	543	7.94	9.52	12.3	17.3	22.8
1.27	11.80	15.00	1374	33.92	40.28	911	25.49	28.91	683	20.19	22.53	542	16.57	18.34	—	—	—
1.28	5.90	7.50	1372	11.90	16.14	909	8.67	11.36	682	6.86	8.83	541	5.65	7.19	14.5	19.5	25.0
1.28	9.25	11.80	1369	25.31	30.46	907	18.55	21.57	680	14.61	16.75	540	11.97	13.62	—	13.4	18.9
ARC-LENGTH CORRECTION FACTOR															0.84	0.87	0.90
1.28	9.75	12.50	1362	27.12	32.47	903	19.96	23.04	677	15.73	17.90	537	12.89	14.55	—	—	18.0
1.28	10.30	13.20	1363	29.04	34.63	903	21.48	24.64	677	16.94	19.16	537	13.89	15.58	—	—	17.0
1.28	12.50	16.00	1365	36.04	42.82	905	27.32	30.88	678	21.69	24.10	538	17.82	19.62	—	—	—
1.29	4.90	6.30	1355	7.53	11.60	898	5.58	8.20	674	4.46	6.40	534	3.71	5.23	16.2	21.2	26.7
1.29	5.20	6.70	1352	8.86	12.98	896	6.52	9.16	672	5.19	7.14	533	4.29	5.82	15.6	20.6	26.1
ARC-LENGTH CORRECTION FACTOR															0.84	0.87	0.90
1.29	8.00	10.30	1355	20.58	25.31	898	14.98	17.84	674	11.78	13.85	534	9.65	11.26	—	15.6	21.1
1.29	8.50	10.90	1361	22.51	27.41	902	16.43	19.35	677	12.92	15.02	537	10.59	12.21	—	14.7	20.2
1.29	10.90	14.00	1360	31.09	36.96	901	23.12	26.38	676	18.27	20.53	536	14.98	16.70	—	—	15.9
1.30	5.50	7.10	1350	10.20	14.37	895	7.47	10.12	671	5.92	7.88	532	4.89	6.42	15.1	20.1	25.6
1.30	7.50	9.75	1342	18.61	23.20	890	13.52	16.34	667	10.64	12.68	529	8.72	10.31	11.4	16.4	21.9
ARC-LENGTH CORRECTION FACTOR															0.84	0.87	0.90
1.31	7.10	9.25	1339	17.01	21.49	887	12.35	15.12	666	9.72	11.74	528	7.97	9.54	12.1	17.1	22.6
1.31	9.00	11.80	1331	24.45	29.50	882	17.89	20.86	662	14.08	16.20	525	11.53	13.16	—	13.6	19.1
1.33	8.50	11.30	1312	22.60	27.47	870	16.48	19.39	652	12.96	15.05	517	10.62	12.23	—	14.4	19.9
1.33	11.30	15.00	1315	32.47	38.53	872	24.25	27.56	654	19.18	21.46	519	15.73	17.46	—	—	—
1.33	16.00	21.20	+	+	+	874	35.79	40.24	656	28.85	31.68	520	23.86	25.89	—	—	—
ARC-LENGTH CORRECTION FACTOR															0.83	0.87	0.90
1.34	14.00	18.70	1308	40.22	48.02	867	31.14	35.03	650	24.87	27.43	516	20.48	22.36	—	—	—
1.35	4.40	5.90	1297	5.38	9.37	860	4.08	6.66	645	3.30	5.21	512	2.76	4.27	16.9	21.9	27.4
1.35	6.30	8.50	1292	13.74	18.03	856	9.99	12.68	642	7.88	9.85	509	6.47	8.02	13.3	18.3	23.9
1.35	6.70	9.00	1298	15.43	19.80	860	11.20	13.93	645	8.82	10.81	512	7.24	8.79	12.6	17.6	23.1
1.36	4.65	6.30	1284	6.54	10.55	851	4.88	7.47	638	3.92	5.83	506	3.27	4.77	16.4	21.4	26.9
ARC-LENGTH CORRECTION FACTOR															0.84	0.87	0.90
1.36	5.90	8.00	1285	12.05	16.26	852	8.78	11.44	639	6.93	8.89	507	5.71	7.24	14.0	19.1	24.6
1.36	9.25	12.50	1291	25.46	30.58	856	18.66	21.65	642	14.68	16.81	509	12.03	13.66	—	—	18.3
1.36	9.75	13.20	1289	27.27	32.59	855	20.06	23.12	641	15.80	17.96	508	12.95	14.60	—	—	17.4
1.36	10.30	14.00	1284	29.20	34.75	851	21.58	24.72	638	17.02	19.22	506	13.95	15.63	—	—	16.3
1.36	11.80	16.00	1288	34.10	40.42	854	25.61	29.00	640	20.28	22.60	508	16.64	18.39	—	—	—
ARC-LENGTH CORRECTION FACTOR															0.83	0.87	0.90
1.37	4.90	6.70	1273	7.68	11.72	844	5.68	8.28	633	4.54	6.46	502	3.77	5.27	15.9	20.9	26.4
1.37	5.20	7.10	1275	9.01	13.10	845	6.62	9.24	634	5.26	7.19	503	4.35	5.87	15.3	20.3	25.8
1.37	5.50	7.50	1277	10.33	14.47	846	7.55	10.19	635	5.98	7.93	504	4.94	6.46	14.8	19.8	25.3
1.37	8.00	10.90	1280	20.72	25.43	849	15.08	17.92	636	11.85	13.90	505	9.71	11.30	—	15.1	20.6
1.38	7.10	9.75	1269	17.13	21.58	841	12.43	15.18	631	9.78	11.78	501	8.02	9.58	11.7	16.7	22.2
ARC-LENGTH CORRECTION FACTOR															0.84	0.87	0.90
1.38	7.50	10.30	1270	18.75	23.31	842	13.62	16.41	631	10.71	12.73	501	8.78	10.35	—	16.0	21.5
1.38	10.90	15.00	1268	31.26	37.09	841	23.23	26.47	631	18.35	20.59	500	15.05	16.75	—	—	—
1.39	6.70	9.25	1262	15.49	19.85	837	11.24	13.96	628	8.85	10.83	498	7.27	8.81	12.4	17.4	22.9
1.39	8.50	11.80	1256	22.69	27.54	833	16.55	19.44	625	13.01	15.09	495	10.66	12.26	—	14.0	19.5
1.39	9.00	12.50	1256	24.58	29.60	833	17.98	20.93	624	14.15	16.25	495	11.59	13.21	—	13.0	18.5
ARC-LENGTH CORRECTION FACTOR															0.83	0.86	0.90
1.42	8.00	11.30	1234	20.79	25.48	818	15.12	17.96	614	11.89	13.93	487	9.74	11.32	—	14.7	20.3
1.42	11.30	16.00	1233	32.61	38.64	817	24.34	27.64	613	19.25	21.52	486	15.79	17.50	—	—	—
1.42	13.20	18.70	1233	38.25	45.44	817	29.25	32.93	613	23.28	25.73	486	19.14	20.96	—	—	—
1.42	15.00	21.20	+	+	+	819	33.60	37.73	614	26.95	29.62	487	22.23	24.17	—	—	—
1.43	9.25	13.20	1222	25.56	30.66	810	18.72	21.70	608	14.73	16.85	482	12.07	13.69	—	—	17.8
ARC-LENGTH CORRECTION FACTOR															0.00	0.85	0.89

5V = STANDARD V-BELT
 5VX = COGGED/NOTCHED V-BELT
 + IF RIM SPEED EXCEEDS 6500 FEET PER MINUTE, CONSULT *Martin*.





Stock Drive 5V Selection

Nominal Center Distances And Arc-Length Correction Factor															Sheave Combination		Speed Ratio
5V/5VX Belt Length Designation															DriveR O.D.	DriveN O.D.	
800	900	1000	1120	1250	1320	1400	1600	1800	2000	2240	2500	2800	3150	3550			
—	—	23.5	29.5	36.0	39.5	43.5	53.5	63.5	73.5	85.5	98.5	113.5	131.0	151.0	15.00	18.70	1.25
32.2	37.2	42.2	48.2	54.7	58.2	62.2	72.2	82.2	92.2	104.2	117.2	132.2	149.7	169.7	4.40	5.50	1.26
24.0	29.0	34.0	40.0	46.5	50.0	54.0	64.0	74.0	84.0	96.0	109.1	124.1	141.6	161.6	9.00	11.30	1.26
31.7	36.7	41.7	47.7	54.2	57.7	61.7	71.7	81.7	91.7	103.7	116.7	131.7	149.2	169.2	4.65	5.90	1.27
28.8	33.8	38.8	44.8	51.3	54.8	58.8	68.8	78.8	88.8	100.8	113.8	128.8	146.3	166.3	6.30	8.00	1.27
0.92	0.94	0.96	0.98	1.00	1.01	1.02	1.04	1.06	1.07	1.09	1.11	1.13	1.15	1.17			
28.0	33.0	38.1	44.1	50.6	54.1	58.1	68.1	78.1	88.1	100.1	113.1	128.1	145.6	165.6	6.70	8.50	1.27
27.3	32.3	37.3	43.3	49.8	53.3	57.3	67.3	77.3	87.3	99.4	112.4	127.4	144.9	164.9	7.10	9.00	1.27
18.9	23.9	28.9	34.9	41.4	44.9	48.9	58.9	68.9	78.9	90.9	103.9	118.9	136.4	156.4	11.80	15.00	1.27
29.5	34.5	39.5	45.5	52.0	55.5	59.5	69.5	79.5	89.5	101.5	114.5	129.5	147.0	167.0	5.90	7.50	1.28
23.4	28.4	33.4	39.4	45.9	49.5	53.5	63.5	73.5	83.5	95.5	108.5	123.5	141.0	161.0	9.25	11.80	1.28
0.92	0.94	0.96	0.98	1.00	1.00	1.01	1.04	1.06	1.07	1.09	1.11	1.13	1.15	1.17			
22.5	27.5	32.5	38.5	45.0	48.5	52.5	62.5	72.5	82.5	94.5	107.5	122.5	140.0	160.0	9.75	12.50	1.28
21.5	26.5	31.5	37.5	44.0	47.5	51.5	61.5	71.5	81.5	93.5	106.5	121.5	139.0	159.0	10.30	13.20	1.28
17.5	22.5	27.6	33.6	40.1	43.6	47.6	57.6	67.6	77.6	89.6	102.6	117.6	135.1	155.1	12.50	16.00	1.28
31.2	36.2	41.2	47.2	53.7	57.2	61.2	71.2	81.2	91.2	103.2	116.2	131.2	148.7	168.7	4.90	6.30	1.29
30.6	35.6	40.6	46.6	53.1	56.6	60.6	70.6	80.7	90.7	102.7	115.7	130.7	148.2	168.2	5.20	6.70	1.29
0.92	0.94	0.96	0.98	1.00	1.01	1.02	1.04	1.06	1.07	1.09	1.11	1.13	1.15	1.17			
25.6	30.6	35.6	41.6	48.1	51.6	55.6	65.6	75.6	85.6	97.6	110.6	125.6	143.1	163.1	8.00	10.30	1.29
24.7	29.7	34.7	40.7	47.2	50.7	54.8	64.8	74.8	84.8	96.8	109.8	124.8	142.3	162.3	8.50	10.90	1.29
20.4	25.4	30.4	36.4	42.9	46.4	50.4	60.4	70.4	80.4	92.4	105.4	120.4	137.9	157.9	10.90	14.00	1.29
30.1	35.1	40.1	46.1	52.6	56.1	60.1	70.1	80.1	90.1	102.1	115.1	130.1	147.6	167.6	5.50	7.10	1.30
26.4	31.4	36.4	42.4	48.9	52.4	56.4	66.4	76.4	86.4	98.4	111.4	126.4	143.9	163.9	7.50	9.75	1.30
0.92	0.94	0.96	0.98	1.00	1.01	1.02	1.04	1.06	1.07	1.09	1.11	1.13	1.15	1.17			
27.1	32.1	37.1	43.1	49.6	53.1	57.1	67.2	77.2	87.2	99.2	112.2	127.2	144.7	164.7	7.10	9.25	1.31
23.6	28.6	33.6	39.6	46.1	49.6	53.6	63.6	73.7	83.7	95.7	108.7	123.7	141.2	161.2	9.00	11.80	1.31
24.4	29.4	34.4	40.4	46.9	50.4	54.4	64.4	74.4	84.4	96.4	109.4	124.4	141.9	161.9	8.50	11.30	1.33
19.3	24.3	29.3	35.3	41.8	45.3	49.3	59.3	69.3	79.3	91.3	104.3	119.3	136.8	156.8	11.30	15.00	1.33
—	—	—	26.7	33.2	36.7	40.7	50.7	60.7	70.7	82.7	95.7	110.8	128.3	148.3	16.00	21.20	1.33
0.92	0.94	0.96	0.98	0.99	1.00	1.01	1.04	1.06	1.07	1.09	1.11	1.13	1.15	1.17			
—	19.2	24.2	30.2	36.7	40.2	44.3	54.3	64.3	74.3	86.3	99.3	114.3	131.8	151.8	14.00	18.70	1.34
31.9	36.9	41.9	47.9	54.4	57.9	61.9	71.9	81.9	91.9	103.9	116.9	131.9	149.4	169.4	4.40	5.90	1.35
28.4	33.4	38.4	44.4	50.9	54.4	58.4	68.4	78.4	88.4	100.4	113.4	128.4	145.9	165.9	6.30	8.50	1.35
27.6	32.6	37.7	43.7	50.2	53.7	57.7	67.7	77.7	87.7	99.7	112.7	127.7	145.2	165.2	6.70	9.00	1.35
31.4	36.4	41.4	47.4	53.9	57.4	61.4	71.4	81.4	91.4	103.4	116.4	131.4	148.9	168.9	4.65	6.30	1.36
0.92	0.94	0.96	0.98	1.00	1.01	1.02	1.04	1.06	1.07	1.09	1.11	1.13	1.15	1.17			
29.1	34.1	39.1	45.1	51.6	55.1	59.1	69.1	79.1	89.1	101.1	114.1	129.1	146.6	166.6	5.90	8.00	1.36
22.9	27.9	32.9	38.9	45.4	48.9	52.9	62.9	72.9	82.9	94.9	107.9	122.9	140.4	160.4	9.25	12.50	1.36
21.9	26.9	31.9	37.9	44.4	47.9	51.9	62.0	72.0	82.0	94.0	107.0	122.0	139.5	159.5	9.75	13.20	1.36
20.8	25.8	30.9	36.9	43.4	46.9	50.9	60.9	70.9	80.9	92.9	105.9	120.9	138.4	158.4	10.30	14.00	1.36
18.0	23.1	28.1	34.1	40.6	44.1	48.1	58.1	68.1	78.1	90.1	103.1	118.1	135.6	155.7	11.80	16.00	1.36
0.92	0.94	0.96	0.98	0.99	1.00	1.01	1.04	1.06	1.07	1.09	1.11	1.13	1.15	1.17			
30.9	35.9	40.9	46.9	53.4	56.9	60.9	70.9	80.9	90.9	102.9	115.9	130.9	148.4	168.4	4.90	6.70	1.37
30.3	35.3	40.3	46.3	52.8	56.3	60.3	70.3	80.3	90.3	102.3	115.3	130.3	147.8	167.8	5.20	7.10	1.37
29.8	34.8	39.8	45.8	52.3	55.8	59.8	69.8	79.8	89.8	101.8	114.8	129.8	147.3	167.3	5.50	7.50	1.37
25.1	30.1	35.1	41.1	47.6	51.1	55.1	65.1	75.1	85.1	97.1	110.1	125.1	142.6	162.6	8.00	10.90	1.37
26.7	31.7	36.7	42.7	49.2	52.7	56.8	66.8	76.8	86.8	98.8	111.8	126.8	144.3	164.3	7.10	9.75	1.38
0.92	0.94	0.96	0.98	1.00	1.00	1.01	1.04	1.06	1.07	1.09	1.11	1.13	1.15	1.17			
26.0	31.0	36.0	42.0	48.5	52.0	56.0	66.0	76.0	86.0	98.0	111.0	126.0	143.5	163.5	7.50	10.30	1.38
19.6	24.6	29.6	35.6	42.1	45.6	49.6	59.6	69.6	79.6	91.6	104.6	119.6	137.1	157.1	10.90	15.00	1.38
27.4	32.4	37.5	43.5	50.0	53.5	57.5	67.5	77.5	87.5	99.5	112.5	127.5	145.0	165.0	6.70	9.25	1.39
24.0	29.0	34.0	40.0	46.5	50.0	54.0	64.0	74.0	84.0	96.0	109.0	124.0	141.5	161.5	8.50	11.80	1.39
23.0	28.1	33.1	39.1	45.6	49.1	53.1	63.1	73.1	83.1	95.1	108.1	123.1	140.6	160.6	9.00	12.50	1.39
0.92	0.94	0.96	0.97	0.99	1.00	1.01	1.04	1.05	1.07	1.09	1.11	1.13	1.15	1.17			
24.8	29.8	34.8	40.8	47.3	50.8	54.8	64.8	74.8	84.8	96.8	109.8	124.8	142.3	162.3	8.00	11.30	1.42
18.4	23.4	28.5	34.5	41.0	44.5	48.5	58.5	68.5	78.5	90.5	103.5	118.5	136.0	156.0	11.30	16.00	1.42
—	19.8	24.8	30.8	37.3	40.9	44.9	54.9	64.9	74.9	86.9	99.9	114.9	132.4	152.4	13.20	18.70	1.42
—	—	21.3	27.4	33.9	37.4	41.5	51.5	61.5	71.5	83.5	96.5	111.5	129.0	149.0	15.00	21.20	1.42
22.3	27.3	32.3	38.3	44.8	48.3	52.3	62.3	72.3	82.3	94.3	107.3	122.4	139.9	159.9	9.25	13.20	1.43
0.91	0.93	0.95	0.97	0.99	1.00	1.01	1.03	1.05	1.07	1.09	1.11	1.13	1.15	1.17			

FOR BELT SIZES NOT SHOWN, INTERPOLATE FOR ADDITIONAL CENTER DISTANCE.

V-BELT DRIVES

5V Stock Drive Selection



V-BELT DRIVES

Speed Ratio	Sheave Combination		Driven Speeds and HP Per Belt												Nominal Center Distance And Arc-Length Correction Factors		
			1750 RPM DriveR			1160 RPM DriveR			870 RPM DriveR			690 RPM DriveR					
	DriveR O.D.	DriveN O.D.	DriveN RPM	HP Per Belt 5V	HP Per Belt 5VX	DriveN RPM	HP Per Belt 5V	HP Per Belt 5VX	DriveN RPM	HP Per Belt 5V	HP Per Belt 5VX	DriveN RPM	HP Per Belt 5V	HP Per Belt 5VX	5V/5VX Belt Length Designation		
															500	600	710
1.44	4.40	6.30	1214	5.51	9.47	805	4.16	6.72	603	3.36	5.26	479	2.81	4.30	16.6	21.6	27.1
1.44	6.30	9.00	1219	13.87	18.13	808	10.07	12.75	606	7.94	9.90	481	6.52	8.05	12.9	17.9	23.4
1.44	9.75	14.00	1215	27.38	32.67	805	20.13	23.18	604	15.86	18.01	479	12.99	14.63	—	—	16.7
1.45	4.65	6.70	1206	6.66	10.64	800	4.96	7.53	600	3.98	5.88	476	3.31	4.81	16.1	21.1	26.6
1.45	5.20	7.50	1206	9.12	13.18	799	6.69	9.29	600	5.32	7.23	476	4.40	5.90	15.0	20.0	25.5
ARC-LENGTH CORRECTION FACTOR															0.84	0.87	0.90
1.45	5.90	8.50	1208	12.17	16.36	801	8.86	11.50	601	7.00	8.94	476	5.76	7.28	13.6	18.6	24.2
1.46	4.90	7.10	1200	7.79	11.81	795	5.76	8.34	597	4.59	6.50	473	3.81	5.31	15.5	20.5	26.1
1.46	5.50	8.00	1196	10.45	14.56	793	7.63	10.25	595	6.04	7.97	472	4.99	6.49	14.3	19.4	24.9
1.46	6.70	9.75	1197	15.58	19.92	793	11.30	14.00	595	8.89	10.87	472	7.30	8.84	12.0	17.0	22.5
1.46	7.10	10.30	1201	17.23	21.66	796	12.50	15.24	597	9.83	11.82	474	8.06	9.61	11.2	16.3	21.8
ARC-LENGTH CORRECTION FACTOR															0.83	0.86	0.90
1.46	7.50	10.90	1199	18.85	23.39	795	13.69	16.46	596	10.76	12.77	473	8.82	10.38	—	15.5	21.0
1.46	10.30	15.00	1198	29.33	34.86	794	21.67	24.79	596	17.09	19.27	472	14.00	15.67	—	—	15.5
1.47	9.00	13.20	1189	24.68	29.68	788	18.04	20.98	591	14.19	16.29	469	11.63	13.24	—	—	17.9
1.47	10.90	16.00	1189	31.37	37.17	788	23.31	26.52	591	18.41	20.64	469	15.09	16.78	—	—	—
1.48	6.30	9.25	1186	13.92	18.17	786	10.10	12.77	590	7.96	9.92	468	6.54	8.07	12.7	17.7	23.2
ARC-LENGTH CORRECTION FACTOR															0.82	0.86	0.89
1.48	8.00	11.80	1182	20.86	25.53	783	15.17	17.99	587	11.92	13.96	466	9.77	11.34	—	14.3	19.9
1.48	8.50	12.50	1185	22.80	27.63	786	16.62	19.50	589	13.07	15.13	467	10.70	12.29	—	13.4	18.9
1.48	16.00	23.60	+	+	+	785	35.93	40.35	589	28.96	31.76	467	23.94	25.95	—	—	—
1.50	12.50	18.70	1167	36.37	43.07	773	27.54	31.05	580	21.85	24.22	460	17.95	19.72	—	—	—
1.51	7.50	11.30	1156	18.90	23.43	766	13.72	16.49	575	10.79	12.79	456	8.84	10.40	—	15.1	20.6
ARC-LENGTH CORRECTION FACTOR															0.0	0.85	0.88
1.52	9.25	14.00	1152	25.65	30.73	764	18.78	21.75	573	14.78	16.89	454	12.11	13.72	—	—	17.1
1.52	14.00	21.20	1153	40.44	48.19	764	31.29	35.14	573	24.98	27.51	455	20.57	22.43	—	—	—
1.53	4.40	6.70	1140	5.60	9.54	756	4.22	6.77	567	3.41	5.29	450	2.85	4.33	16.2	21.3	26.8
1.53	5.90	9.00	1140	12.25	16.42	756	8.91	11.54	567	7.03	8.97	450	5.79	7.30	13.2	18.2	23.7
1.54	4.65	7.10	1137	6.75	10.71	754	5.02	7.58	565	4.02	5.91	448	3.35	4.83	15.7	20.7	26.2
ARC-LENGTH CORRECTION FACTOR															0.84	0.87	0.90
1.54	4.90	7.50	1135	7.87	11.87	752	5.81	8.38	564	4.63	6.53	448	3.84	5.33	15.2	20.2	25.7
1.54	7.10	10.90	1134	17.31	21.72	752	12.55	15.28	564	9.87	11.85	447	8.09	9.63	—	15.7	21.3
1.54	9.75	15.00	1133	27.48	32.75	751	20.20	23.23	563	15.91	18.04	447	13.03	14.66	—	—	15.8
1.55	5.20	8.00	1130	9.21	13.25	749	6.75	9.34	562	5.36	7.27	445	4.43	5.93	14.6	19.6	25.1
1.55	6.70	10.30	1132	15.66	19.98	751	11.35	14.05	563	8.94	10.90	446	7.33	8.86	11.5	16.6	22.1
ARC-LENGTH CORRECTION FACTOR															0.83	0.87	0.90
1.56	5.50	8.50	1125	10.54	14.63	746	7.69	10.30	559	6.09	8.01	444	5.02	6.52	13.9	18.9	24.5
1.56	6.30	9.75	1124	13.99	18.22	745	10.15	12.81	559	8.00	9.94	443	6.57	8.09	12.3	17.3	22.8
1.56	8.50	13.20	1122	22.87	27.68	744	16.66	19.53	558	13.10	15.16	442	10.73	12.31	—	—	18.3
1.56	9.00	14.00	1121	24.76	29.74	743	18.10	21.02	557	14.23	16.32	442	11.66	13.26	—	—	17.3
1.56	10.30	16.00	1123	29.43	34.93	744	21.73	24.84	558	17.13	19.31	443	14.04	15.69	—	—	—
ARC-LENGTH CORRECTION FACTOR															0.83	0.86	0.89
1.57	8.00	12.50	1115	20.94	25.59	739	15.22	18.03	554	11.96	13.99	440	9.80	11.37	—	13.7	19.3
1.58	5.90	9.25	1109	12.29	16.45	735	8.94	11.56	551	7.05	8.98	437	5.80	7.31	13.0	18.0	23.5
1.58	7.50	11.80	1107	18.96	23.47	734	13.76	16.52	550	10.81	12.81	436	8.86	10.41	—	14.7	20.2
1.58	15.00	23.60	+	+	+	735	33.70	37.81	552	27.02	29.68	437	22.29	24.22	—	—	—
1.59	11.80	18.70	1101	34.35	40.61	730	25.77	29.13	547	20.40	22.70	434	16.74	18.47	—	—	—
ARC-LENGTH CORRECTION FACTOR															0.82	0.86	0.89
1.60	7.10	11.30	1094	17.35	21.76	725	12.58	15.30	544	9.89	11.87	431	8.11	9.65	—	15.4	20.9
1.61	13.20	21.20	1086	38.43	45.57	720	29.36	33.01	540	23.36	25.80	428	19.21	21.01	—	—	—
1.63	4.40	7.10	1075	5.67	9.59	713	4.27	6.80	534	3.44	5.32	424	2.88	4.35	15.9	20.9	26.4
1.63	4.65	7.50	1076	6.81	10.76	713	5.06	7.61	535	4.05	5.94	424	3.37	4.85	15.4	20.4	25.9
1.63	9.25	15.00	1075	25.73	30.79	712	18.84	21.79	534	14.82	16.92	424	12.14	13.75	—	—	16.2
ARC-LENGTH CORRECTION FACTOR															0.83	0.87	0.90
1.64	6.70	10.90	1069	15.72	20.03	709	11.39	14.08	532	8.97	10.92	422	7.36	8.88	11.0	16.0	21.6
1.65	4.90	8.00	1063	7.94	11.93	705	5.86	8.42	529	4.67	6.56	419	3.87	5.35	14.8	19.8	25.3
1.65	5.20	8.50	1062	9.28	13.31	704	6.80	9.37	528	5.40	7.30	419	4.46	5.95	14.1	19.2	24.7
1.65	5.50	9.00	1062	10.60	14.67	704	7.73	10.33	528	6.12	8.03	419	5.05	6.54	13.5	18.5	24.0
1.65	6.30	10.30	1064	14.05	18.27	705	10.19	12.84	529	8.03	9.96	419	6.59	8.11	11.8	16.8	22.4
ARC-LENGTH CORRECTION FACTOR															0.81	0.85	0.88

5V = STANDARD V-BELT
 5VX = COGGED/NOTCHED V-BELT
 + IF RIM SPEED EXCEEDS 6500 FEET PER MINUTE, CONSULT *Martin*.





Stock Drive 5V Selection

Nominal Center Distances And Arc-Length Correction Factor															Sheave Combination		Speed Ratio
5V/5VX Belt Length Designation															DriveR O. D.	DriveN O. D.	
800	900	1000	1120	1250	1320	1400	1600	1800	2000	2240	2500	2800	3150	3550			
31.6	36.6	41.6	47.6	54.1	57.6	61.6	71.6	81.6	91.6	103.6	116.6	131.6	149.1	169.1	4.40	6.30	1.44
28.0	33.0	38.0	44.0	50.5	54.0	58.0	68.0	78.0	88.0	100.0	113.0	128.0	145.5	165.5	6.30	9.00	1.44
21.2	26.3	31.3	37.3	43.8	47.3	51.3	61.3	71.3	81.3	93.3	106.3	121.3	138.8	158.8	9.75	14.00	1.44
31.1	36.1	41.1	47.1	53.6	57.1	61.1	71.1	81.1	91.1	103.1	116.1	131.1	148.6	168.6	4.65	6.70	1.45
30.0	35.0	40.0	46.0	52.5	56.0	60.0	70.0	80.0	90.0	102.0	115.0	130.0	147.5	167.5	5.20	7.50	1.45
0.92	0.94	0.96	0.98	1.00	1.00	1.01	1.04	1.06	1.07	1.09	1.11	1.13	1.15	1.17			
28.7	33.7	38.7	44.7	51.2	54.7	58.7	68.7	78.7	88.7	100.7	113.7	128.7	146.2	166.2	5.90	8.50	1.45
30.6	35.6	40.6	46.6	53.1	56.6	60.6	70.6	80.6	90.6	102.6	115.6	130.6	148.1	168.1	4.90	7.10	1.46
29.4	34.4	39.4	45.4	51.9	55.4	59.4	69.4	79.4	89.4	101.4	114.4	129.4	146.9	166.9	5.50	8.00	1.46
27.0	32.0	37.0	43.1	49.6	53.1	57.1	67.1	77.1	87.1	99.1	112.1	127.1	144.6	164.6	6.70	9.75	1.46
26.3	31.3	36.3	42.3	48.8	52.3	56.3	66.3	76.3	86.3	98.3	111.3	126.3	143.8	163.8	7.10	10.30	1.46
0.92	0.94	0.96	0.97	0.99	1.00	1.01	1.04	1.05	1.07	1.09	1.11	1.13	1.15	1.17			
25.5	30.5	35.5	41.5	48.0	51.5	55.5	65.5	75.5	85.5	97.5	110.5	125.5	143.0	163.0	7.50	10.90	1.46
20.0	25.0	30.0	36.1	42.6	46.1	50.1	60.1	70.1	80.1	92.1	105.1	120.1	137.6	157.6	10.30	15.00	1.46
22.5	27.5	32.5	38.5	45.0	48.5	52.5	62.5	72.5	82.5	94.5	107.5	122.5	140.0	160.0	9.00	13.20	1.47
18.7	23.7	28.8	34.8	41.3	44.8	48.8	58.8	68.8	78.8	90.8	103.8	118.8	136.3	156.4	10.90	16.00	1.47
27.7	32.8	37.8	43.8	50.3	53.8	57.8	67.8	77.8	87.8	99.8	112.8	127.8	145.3	165.3	6.30	9.25	1.48
0.91	0.94	0.95	0.97	0.99	1.00	1.01	1.03	1.05	1.07	1.09	1.11	1.13	1.15	1.17			
24.4	29.4	34.4	40.4	46.9	50.4	54.4	64.4	74.4	84.4	96.4	109.4	124.4	141.9	161.9	8.00	11.80	1.48
23.4	28.4	33.4	39.5	46.0	49.5	53.5	63.5	73.5	83.5	95.5	108.5	123.5	141.0	161.0	8.50	12.50	1.48
—	—	—	24.6	31.2	34.7	38.7	48.8	58.8	68.8	80.8	93.8	108.8	126.3	146.3	16.00	23.60	1.48
—	20.3	25.3	31.3	37.9	41.4	45.4	55.4	65.4	75.4	87.4	100.4	115.5	133.0	153.0	12.50	18.70	1.50
25.2	30.2	35.2	41.2	47.7	51.2	55.2	65.2	75.2	85.2	97.2	110.2	125.2	142.7	162.7	7.50	11.30	1.51
0.91	0.93	0.95	0.97	0.99	1.00	1.01	1.03	1.05	1.07	1.09	1.11	1.13	1.15	1.17			
21.6	26.6	31.7	37.7	44.2	47.7	51.7	61.7	71.7	81.7	93.7	106.7	121.7	139.2	159.2	9.25	14.00	1.52
—	—	22.1	28.1	34.7	38.2	42.2	52.2	62.2	72.3	84.3	97.3	112.3	129.8	149.8	14.00	21.20	1.52
31.3	36.3	41.3	47.3	53.8	57.3	61.3	71.3	81.3	91.3	103.3	116.3	131.3	148.8	168.8	4.40	6.70	1.53
28.3	33.3	38.3	44.3	50.8	54.3	58.3	68.3	78.3	88.3	100.3	113.3	128.3	145.8	165.8	5.90	9.00	1.53
30.7	35.8	40.8	46.8	53.3	56.8	60.8	70.8	80.8	90.8	102.8	115.8	130.8	148.3	168.3	4.65	7.10	1.54
0.92	0.94	0.96	0.98	0.99	1.00	1.01	1.04	1.06	1.07	1.09	1.11	1.13	1.15	1.17			
30.2	35.2	40.2	46.2	52.7	56.2	60.2	70.2	80.3	90.3	102.3	115.3	130.3	147.8	167.8	4.90	7.50	1.54
25.8	30.8	35.8	41.8	48.3	51.8	55.8	65.8	75.8	85.8	97.8	110.8	125.8	143.4	163.4	7.10	10.90	1.54
20.4	25.4	30.4	36.5	43.0	46.5	50.5	60.5	70.5	80.5	92.5	105.5	120.5	138.0	158.0	9.75	15.00	1.54
29.6	34.6	39.6	45.6	52.1	55.6	59.6	69.6	79.6	89.6	101.6	114.6	129.6	147.1	167.1	5.20	8.00	1.55
26.6	31.6	36.6	42.6	49.1	52.6	56.6	66.6	76.6	86.6	98.6	111.6	126.6	144.1	164.1	6.70	10.30	1.55
0.92	0.94	0.96	0.98	0.99	1.00	1.01	1.04	1.05	1.07	1.09	1.11	1.13	1.15	1.17			
29.0	34.0	39.0	45.0	51.5	55.0	59.0	69.0	79.0	89.0	101.0	114.0	129.0	146.5	166.5	5.50	8.50	1.56
27.3	32.3	37.4	43.4	49.9	53.4	57.4	67.4	77.4	87.4	99.4	112.4	127.4	144.9	164.9	6.30	9.75	1.56
22.8	27.9	32.9	38.9	45.4	48.9	52.9	62.9	72.9	82.9	94.9	107.9	122.9	140.4	160.4	8.50	13.20	1.56
21.8	26.8	31.8	37.9	44.4	47.9	51.9	61.9	71.9	81.9	93.9	106.9	121.9	139.4	159.4	9.00	14.00	1.56
19.1	24.2	29.3	35.2	41.7	45.3	49.3	59.3	69.3	79.3	91.3	104.3	119.3	136.8	156.8	10.30	16.00	1.56
0.92	0.94	0.95	0.97	0.99	1.00	1.01	1.03	1.05	1.07	1.09	1.11	1.13	1.15	1.17			
23.8	28.8	33.8	39.8	46.3	49.8	53.8	63.8	73.8	83.8	95.8	108.8	123.8	141.4	161.4	8.00	12.50	1.57
28.1	33.1	38.1	44.1	50.6	54.1	58.1	68.1	78.1	88.1	100.1	113.1	128.1	145.6	165.6	5.90	9.25	1.58
24.7	29.8	34.8	40.8	47.3	50.8	54.8	64.8	74.8	84.8	96.8	109.8	124.8	142.3	162.3	7.50	11.80	1.58
—	—	—	25.3	31.9	35.4	39.4	49.5	59.5	69.6	81.6	94.6	109.6	127.1	147.1	15.00	23.60	1.58
—	20.8	25.8	31.9	38.4	41.9	45.9	55.9	66.0	76.0	88.0	101.0	116.0	133.5	153.5	11.80	18.70	1.59
0.91	0.93	0.95	0.97	0.99	1.00	1.01	1.03	1.05	1.07	1.09	1.11	1.13	1.15	1.17			
25.5	30.5	35.5	41.5	48.0	51.5	55.5	65.5	75.5	85.5	97.5	110.5	125.5	143.0	163.0	7.10	11.30	1.60
—	—	22.6	23.7	35.3	38.8	42.8	52.8	62.9	72.9	84.9	97.9	112.9	130.4	150.4	13.20	21.20	1.61
30.9	35.9	40.9	46.9	53.5	57.0	61.0	71.0	81.0	91.0	103.0	116.0	131.0	148.5	168.5	4.40	7.10	1.63
30.4	35.4	40.4	46.4	52.9	56.4	60.4	70.4	80.4	90.4	102.4	115.4	130.4	148.0	168.0	4.65	7.50	1.63
20.8	25.8	30.8	36.8	43.4	46.9	50.9	60.9	70.9	80.9	92.9	105.9	120.9	138.4	158.4	9.25	15.00	1.63
0.92	0.94	0.96	0.97	0.99	1.00	1.01	1.04	1.05	1.07	1.09	1.11	1.13	1.15	1.17			
26.1	31.1	36.1	42.1	48.6	52.1	56.1	66.1	76.1	86.2	98.2	111.2	126.2	143.7	163.7	6.70	10.90	1.64
29.8	34.8	39.8	45.8	52.3	55.8	59.8	69.8	79.8	89.8	101.8	114.8	129.8	147.4	167.4	4.90	8.00	1.65
29.2	34.2	39.2	45.2	51.7	55.2	59.2	69.2	79.2	89.2	101.2	114.2	129.2	146.7	166.7	5.20	8.50	1.65
28.6	33.6	38.6	44.6	51.1	54.6	58.6	68.6	78.6	88.6	100.6	113.6	128.6	146.1	166.1	5.50	9.00	1.65
26.9	31.9	36.9	42.9	49.4	52.9	56.9	66.9	76.9	86.9	98.9	111.9	126.9	144.4	164.5	6.30	10.30	1.65
0.91	0.93	0.95	0.97	0.99	1.00	1.01	1.03	1.05	1.07	1.09	1.11	1.13	1.15	1.17			

FOR BELT SIZES NOT SHOWN, INTERPOLATE FOR ADDITIONAL CENTER DISTANCE.

V-BELT DRIVES

5V Stock Drive Selection



V-BELT DRIVES

Speed Ratio	Sheave Combination		DriveN Speeds and HP Per Belt												Nominal Center Distance And Arc-Length Correction Factors		
			1750 RPM DriveR			1160 RPM DriveR			870 RPM DriveR			690 RPM DriveR					
	DriveR O.D.	DriveN O.D.	DriveN RPM	HP Per Belt 5V	HP Per Belt 5VX	DriveN RPM	HP Per Belt 5V	HP Per Belt 5VX	DriveN RPM	HP Per Belt 5V	HP Per Belt 5VX	DriveN RPM	HP Per Belt 5V	HP Per Belt 5VX	5V/5VX Belt Length Designation		
															500	600	710
1.65	8.50	14.00	1058	22.93	27.73	701	16.70	19.56	526	13.13	15.18	417	10.75	12.33	—	—	17.6
1.65	9.75	16.00	1062	27.56	32.81	704	20.25	23.27	528	15.94	18.07	419	13.06	14.69	—	—	—
1.66	5.90	9.75	1052	12.34	16.48	697	8.97	11.59	523	7.08	9.00	415	5.82	7.33	12.6	17.6	23.1
1.66	8.00	13.20	1055	21.00	25.64	700	15.26	18.06	525	11.99	14.01	416	9.82	11.38	—	13.1	18.7
1.66	11.30	18.70	1054	32.82	38.79	698	24.48	27.74	524	19.35	21.59	415	15.87	17.56	—	—	—
ARC-LENGTH CORRECTION FACTOR															0.82	0.85	0.89
1.67	7.10	11.80	1047	17.39	21.79	694	12.60	15.32	521	9.91	11.88	413	8.13	9.66	—	15.0	20.5
1.67	9.00	15.00	1045	24.83	29.79	693	18.14	21.06	520	14.27	16.35	412	11.69	13.28	—	—	16.4
1.68	7.50	12.50	1044	19.02	23.52	692	13.80	16.55	519	10.84	12.83	412	8.89	10.43	—	14.1	19.6
1.69	5.50	9.25	1033	10.62	14.69	685	7.74	10.34	513	6.13	8.04	407	5.05	6.55	13.3	18.3	23.8
1.69	14.00	23.60	1035	40.56	48.28	686	31.37	35.20	515	25.04	27.56	408	20.61	22.46	—	—	—
ARC-LENGTH CORRECTION FACTOR															0.82	0.86	0.89
1.70	6.70	11.30	1031	15.75	20.05	684	11.42	14.09	513	8.98	10.93	407	7.37	8.89	—	15.7	21.2
1.70	12.50	21.20	1028	36.51	43.18	682	27.63	31.12	511	21.92	24.28	405	18.00	19.76	—	—	—
1.72	4.40	7.50	1017	5.72	9.63	674	4.30	6.83	506	3.47	5.34	401	2.90	4.37	15.6	20.6	26.1
1.72	10.90	18.70	1016	31.54	37.31	674	23.42	26.61	505	18.49	20.70	401	15.16	16.83	—	—	—
1.74	4.65	8.00	1008	6.86	10.80	668	5.10	7.64	501	4.08	5.96	397	3.40	4.87	15.0	20.0	25.5
ARC-LENGTH CORRECTION FACTOR															0.83	0.86	0.89
1.74	6.30	10.90	1005	14.09	18.30	666	10.22	12.86	499	8.05	9.98	396	6.61	8.12	11.3	16.3	21.9
1.74	9.25	16.00	1007	25.79	30.84	668	18.87	21.82	501	14.85	16.94	397	12.16	13.76	—	—	15.3
1.75	4.90	8.50	1000	7.99	11.96	663	5.89	8.44	497	4.69	6.58	394	3.89	5.37	14.4	19.4	24.9
1.75	5.20	9.00	1003	9.33	13.34	665	6.83	9.40	499	5.42	7.31	395	4.48	5.96	13.7	18.8	24.3
1.75	16.00	28.00	+	+	+	661	36.04	40.44	496	29.05	31.83	393	24.01	26.01	—	—	—
ARC-LENGTH CORRECTION FACTOR															0.80	0.85	0.88
1.76	5.90	10.30	995	12.39	16.52	660	9.00	11.61	495	7.10	9.02	392	5.84	7.34	12.1	17.1	22.7
1.76	8.00	14.00	995	21.05	25.67	659	15.29	18.08	494	12.01	14.03	392	9.84	11.40	—	—	18.0
1.77	6.70	11.80	987	15.78	20.08	654	11.44	14.11	491	9.00	10.95	389	7.38	8.90	—	15.3	20.8
1.77	7.10	12.50	988	17.44	21.82	655	12.63	15.34	491	9.93	11.90	390	8.14	9.67	—	14.4	19.9
1.77	7.50	13.20	989	19.06	23.55	655	13.82	16.57	491	10.86	12.85	390	8.90	10.44	—	13.4	19.0
ARC-LENGTH CORRECTION FACTOR															0.81	0.85	0.88
1.77	8.50	15.00	987	22.99	27.77	654	16.74	19.59	490	13.16	15.20	389	10.78	12.35	—	—	16.7
1.79	5.20	9.25	975	9.34	13.35	647	6.84	9.41	485	5.43	7.32	385	4.48	5.97	13.5	18.5	24.1
1.79	5.50	9.75	979	10.66	14.72	649	7.77	10.36	487	6.15	8.05	386	5.07	6.56	12.8	17.9	23.4
1.79	9.00	16.00	980	24.89	29.83	649	18.18	21.09	487	14.30	16.37	386	11.71	13.30	—	—	15.5
1.79	13.20	23.60	976	38.51	45.64	647	29.42	33.06	485	23.41	25.83	385	19.24	21.04	—	—	—
ARC-LENGTH CORRECTION FACTOR															0.82	0.85	0.89
1.80	11.80	21.20	970	34.45	40.69	643	25.84	29.18	482	20.45	22.74	383	16.78	18.50	—	—	—
1.81	6.30	11.30	969	14.12	18.32	642	10.23	12.87	482	8.06	9.99	382	6.62	8.13	—	16.0	21.5
1.82	10.30	18.70	960	29.56	35.03	636	21.82	24.91	477	17.20	19.36	378	14.09	15.73	—	—	—
1.84	4.40	8.00	953	5.77	9.66	631	4.33	6.85	474	3.49	5.35	376	2.92	4.38	15.2	20.2	25.7
1.85	4.65	8.50	948	6.90	10.83	628	5.13	7.66	471	4.10	5.98	374	3.41	4.88	14.5	19.6	25.1
ARC-LENGTH CORRECTION FACTOR															0.82	0.86	0.89
1.85	4.90	9.00	944	8.03	11.99	626	5.91	8.46	469	4.71	6.59	372	3.90	5.38	13.9	19.0	24.5
1.86	5.90	10.90	940	12.42	16.55	623	9.02	11.63	467	7.12	9.03	371	5.86	7.35	11.5	16.6	22.2
1.87	7.10	13.20	935	17.47	21.85	620	12.66	15.36	465	9.95	11.91	369	8.16	9.68	—	13.7	19.3
1.87	15.00	28.00	+	+	+	619	33.79	37.88	465	27.09	29.73	368	22.34	24.26	—	—	—
1.88	6.70	12.50	931	15.82	20.11	617	11.46	14.13	463	9.02	10.96	367	7.40	8.91	—	14.6	20.2
ARC-LENGTH CORRECTION FACTOR															0.82	0.86	0.89
1.88	7.50	14.00	932	19.10	23.58	618	13.85	16.59	463	10.88	12.86	367	8.92	10.45	—	—	18.3
1.88	11.30	21.20	929	32.91	38.86	616	24.54	27.78	462	19.39	21.63	366	15.90	17.59	—	—	—
1.89	5.20	9.75	925	9.38	13.38	613	6.86	9.42	460	5.44	7.33	365	4.50	5.98	13.1	18.1	23.6
1.89	5.50	10.30	926	10.70	14.75	614	7.79	10.37	461	6.17	8.06	365	5.08	6.57	12.4	17.4	23.0
1.89	6.30	11.80	927	14.14	18.34	615	10.25	12.89	461	8.07	10.00	366	6.63	8.14	—	15.5	21.1
ARC-LENGTH CORRECTION FACTOR															0.81	0.85	0.88
1.89	8.00	15.00	928	21.09	25.71	615	15.32	18.11	461	12.04	14.04	366	9.86	11.41	—	—	17.1
1.89	8.50	16.00	925	23.03	27.80	613	16.77	19.61	460	13.18	15.22	365	10.79	12.36	—	—	15.8
1.90	12.50	23.60	923	36.58	43.23	612	27.67	31.15	459	21.96	24.30	364	18.03	19.78	—	—	—
1.91	4.90	9.25	918	8.05	12.00	609	5.93	8.47	456	4.72	6.60	362	3.91	5.39	13.7	18.8	24.3
1.93	5.90	11.30	906	12.44	16.56	601	9.04	11.64	451	7.13	9.04	357	5.86	7.36	11.2	16.3	21.8
ARC-LENGTH CORRECTION FACTOR															0.81	0.85	0.89

5V = STANDARD V-BELT
 5VX = COGGED/NOTCHED V-BELT
 + IF RIM SPEED EXCEEDS 6500 FEET PER MINUTE, CONSULT *Martin*.





Stock Drive Selection 5V

Nominal Center Distances And Arc-Length Correction Factor															Sheave Combination		Speed Ratio
5V/5VX Belt Length Designation															DriveR O. D.	DriveN O. D.	
800	900	1000	1120	1250	1320	1400	1600	1800	2000	2240	2500	2800	3150	3550			
22.2	27.2	32.2	38.2	44.7	48.3	52.3	62.3	72.3	82.3	94.3	107.3	122.3	139.8	159.8	8.50	14.00	1.65
19.5	24.6	29.6	35.6	42.2	45.7	49.7	59.7	69.7	79.7	91.7	104.7	119.7	137.2	157.2	9.75	16.00	1.65
27.6	32.7	37.7	43.7	50.2	53.7	57.7	67.7	77.7	87.7	99.7	112.7	127.7	145.2	165.2	5.90	9.75	1.66
23.2	28.2	33.2	39.3	45.8	49.3	53.3	63.3	73.3	83.3	95.3	108.3	123.3	140.8	160.8	8.00	13.20	1.66
—	21.1	26.2	32.2	38.8	42.3	46.3	56.3	66.3	76.3	88.4	101.4	116.4	133.9	153.9	11.30	18.70	1.66
0.91	0.93	0.95	0.97	0.99	1.00	1.01	1.03	1.05	1.07	1.09	1.11	1.13	1.15	1.17			
25.0	30.1	35.1	41.1	47.6	51.1	55.1	65.1	75.1	85.1	97.1	110.1	125.1	142.6	162.6	7.10	11.80	1.67
20.9	26.0	31.0	37.0	43.5	47.1	51.1	61.1	71.1	81.1	93.1	106.1	121.1	138.6	158.6	9.00	15.00	1.67
24.2	29.2	34.2	40.2	46.7	50.2	54.2	64.2	74.3	84.3	96.3	109.3	124.3	141.8	161.8	7.50	12.50	1.68
28.4	33.4	38.4	44.4	50.9	54.4	58.4	68.4	78.4	88.4	100.4	113.4	128.3	145.9	165.9	5.50	9.25	1.69
—	—	—	26.0	32.6	36.2	40.2	50.2	60.3	70.3	82.3	95.3	110.4	127.9	147.9	14.00	23.60	1.69
0.91	0.93	0.95	0.97	0.99	1.00	1.01	1.03	1.05	1.07	1.09	1.11	1.13	1.15	1.17			
25.8	30.8	35.8	41.8	48.3	51.8	55.8	65.8	75.8	85.8	97.8	110.8	125.8	143.3	163.3	6.70	11.30	1.70
—	—	23.1	29.2	35.8	39.3	43.3	53.4	63.4	73.4	85.4	98.4	113.4	131.0	151.0	12.50	21.20	1.70
30.6	35.6	40.6	46.6	53.1	56.6	60.6	70.6	80.6	90.6	102.6	115.6	130.6	148.1	168.1	4.40	7.50	1.72
—	21.4	26.5	32.5	39.1	42.6	46.6	56.6	66.6	76.7	88.7	101.7	116.7	134.2	154.2	10.90	18.70	1.72
30.0	35.0	40.0	46.0	52.5	56.0	60.0	70.0	80.0	90.0	102.1	115.1	130.1	147.6	167.6	4.65	8.00	1.74
0.92	0.94	0.95	0.97	0.99	1.00	1.01	1.03	1.05	1.07	1.09	1.11	1.13	1.15	1.17			
26.4	31.4	36.4	42.4	48.9	52.4	56.4	66.5	76.5	86.5	98.5	111.5	126.5	144.0	164.0	6.30	10.90	1.74
19.9	24.9	30.0	36.0	42.5	46.0	50.1	60.1	70.1	80.1	92.1	105.1	120.1	137.6	157.6	9.25	16.00	1.74
29.4	34.4	39.4	45.4	51.9	55.4	59.4	69.5	79.5	89.5	101.5	114.5	129.5	147.0	167.0	4.90	8.50	1.75
28.8	33.8	38.8	44.8	51.3	54.8	58.8	68.8	78.8	88.8	100.8	113.8	128.8	146.3	166.3	5.20	9.00	1.75
—	—	—	—	27.3	30.9	34.9	45.0	55.1	65.2	77.2	90.2	105.3	122.8	142.8	16.00	28.00	1.75
0.91	0.93	0.95	0.97	0.99	1.00	1.01	1.03	1.05	1.07	1.09	1.11	1.13	1.15	1.17			
27.2	32.2	37.2	43.2	49.7	53.2	57.2	67.2	77.2	87.2	99.3	112.2	127.2	144.8	164.8	5.90	10.30	1.76
22.5	27.6	32.6	38.6	45.1	48.6	52.6	62.6	72.7	82.7	94.7	107.7	122.7	140.2	160.2	8.00	14.00	1.76
25.3	30.4	35.4	41.4	47.9	51.4	55.4	65.4	75.4	85.4	97.4	110.4	125.4	142.9	163.0	6.70	11.80	1.77
24.5	29.5	34.5	40.5	47.0	50.5	54.5	64.5	74.6	84.6	96.6	109.6	124.6	142.1	162.1	7.10	12.50	1.77
23.6	28.6	33.6	39.6	46.2	49.7	53.7	63.7	73.7	83.7	95.7	108.7	123.7	141.2	161.2	7.50	13.20	1.77
0.91	0.93	0.95	0.97	0.99	1.00	1.01	1.03	1.05	1.07	1.09	1.11	1.13	1.15	1.17			
21.3	26.3	31.4	37.4	43.9	47.4	51.4	61.5	71.5	81.5	93.5	106.5	121.5	139.0	159.0	8.50	15.00	1.77
28.6	33.6	38.6	44.6	51.1	54.6	58.6	68.6	78.6	88.6	100.6	113.6	128.6	146.1	166.1	5.20	9.25	1.79
27.9	33.0	38.0	44.0	50.5	54.0	58.0	68.0	78.0	88.0	100.0	113.0	128.0	145.5	165.5	5.50	9.75	1.79
20.1	25.1	30.2	36.2	42.7	46.2	50.2	60.3	70.3	80.3	92.3	105.3	120.3	137.8	157.8	9.00	16.00	1.79
—	—	—	26.6	33.2	36.7	40.8	50.8	60.9	70.9	82.9	96.0	111.0	128.5	148.5	13.20	23.60	1.79
0.91	0.93	0.95	0.97	0.99	1.00	1.01	1.03	1.05	1.07	1.09	1.11	1.13	1.15	1.17			
—	—	23.6	29.7	36.3	39.8	43.8	53.9	63.9	73.9	86.0	99.0	114.0	131.5	151.5	11.80	21.20	1.80
26.1	31.1	36.1	42.1	48.6	52.1	56.1	66.1	76.1	86.1	98.1	111.1	126.2	143.7	163.7	6.30	11.30	1.81
—	21.8	26.9	33.0	39.5	43.0	47.0	57.1	67.1	77.1	89.1	102.1	117.1	134.7	154.7	10.30	18.70	1.82
30.2	35.2	40.2	46.2	52.7	56.2	60.2	70.2	80.2	90.2	102.2	115.2	130.2	147.8	167.8	4.40	8.00	1.84
29.6	34.6	39.6	45.6	52.1	55.6	59.6	69.6	79.6	89.7	101.7	114.7	129.7	147.2	167.2	4.65	8.50	1.85
0.91	0.93	0.95	0.97	0.99	1.00	1.01	1.03	1.05	1.07	1.09	1.11	1.13	1.15	1.17			
29.0	34.0	39.0	45.0	51.5	55.0	59.0	69.1	79.1	89.1	101.1	114.1	129.1	146.6	166.6	4.90	9.00	1.85
26.7	31.7	36.7	42.7	49.2	52.7	56.7	66.8	76.8	86.8	98.8	111.8	126.8	144.3	164.3	5.90	10.90	1.86
23.9	28.9	33.9	39.9	46.5	50.0	54.0	64.0	74.0	84.0	96.0	109.0	124.0	141.5	161.5	7.10	13.20	1.87
—	—	—	—	28.0	31.6	35.6	45.8	55.8	65.9	78.0	91.0	106.0	123.6	143.6	15.00	28.00	1.87
24.8	29.8	34.8	40.8	47.3	50.8	54.8	64.9	74.9	84.9	96.9	109.9	125.9	142.4	162.4	6.70	12.50	1.88
0.91	0.93	0.95	0.97	0.99	1.00	1.01	1.03	1.05	1.07	1.09	1.11	1.13	1.15	1.17			
22.9	27.9	33.0	39.0	45.5	49.0	53.0	63.0	73.0	83.1	95.1	108.1	123.1	140.6	160.6	7.50	14.00	1.88
—	18.8	24.0	30.1	36.6	40.2	44.2	54.2	64.3	74.3	86.3	99.4	114.4	131.9	151.9	11.30	21.20	1.88
28.2	33.2	38.2	44.2	50.7	54.2	58.2	68.2	78.2	88.2	100.2	113.2	128.2	145.7	165.7	5.20	9.75	1.89
27.5	32.5	37.5	43.5	50.0	53.5	57.5	67.5	77.6	87.6	99.6	112.6	127.6	145.1	165.1	5.50	10.30	1.89
25.6	30.7	35.7	41.7	48.2	51.7	55.7	65.7	75.7	85.7	97.7	110.8	125.8	143.3	163.3	6.30	11.80	1.89
0.91	0.93	0.95	0.97	0.99	1.00	1.01	1.03	1.05	1.07	1.09	1.11	1.13	1.15	1.17			
21.7	26.7	31.7	37.8	44.3	47.8	51.8	61.8	71.9	81.9	93.9	106.9	121.9	139.4	159.4	8.00	15.00	1.89
20.4	25.5	30.5	36.6	43.1	46.6	50.6	60.6	70.7	80.7	92.7	105.7	120.7	138.2	158.2	8.50	16.00	1.89
—	—	20.9	27.1	33.7	37.2	41.3	51.3	61.4	71.4	83.5	96.5	111.5	129.0	149.0	12.50	23.60	1.90
28.8	33.8	38.8	44.8	51.3	54.8	58.8	68.9	78.9	88.9	100.9	113.9	128.9	146.4	166.4	4.90	9.25	1.91
26.4	31.4	36.4	42.4	48.9	52.4	56.4	66.4	76.4	86.4	98.5	111.5	126.5	144.0	164.0	5.90	11.30	1.93
0.91	0.93	0.95	0.97	0.99	1.00	1.01	1.03	1.05	1.07	1.09	1.11	1.13	1.15	1.17			

FOR BELT SIZES NOT SHOWN, INTERPOLATE FOR ADDITIONAL CENTER DISTANCE.

V-BELT DRIVES

5V Stock Drive Selection



V-BELT DRIVES

Speed Ratio	Sheave Combination		DriveN Speeds and HP Per Belt												Nominal Center Distance And Arc-Length Correction Factors		
			1750 RPM DriveR			1160 RPM DriveR			870 RPM DriveR			690 RPM DriveR					
	DriveR O.D.	DriveN O.D.	DriveN RPM	HP Per Belt 5V	HP Per Belt 5VX	DriveN RPM	HP Per Belt 5V	HP Per Belt 5VX	DriveN RPM	HP Per Belt 5V	HP Per Belt 5VX	DriveN RPM	HP Per Belt 5V	HP Per Belt 5VX	5V/5VX Belt Length Designation		
															500	600	710
1.93	9.75	18.70	908	27.66	32.89	602	20.32	23.32	451	16.00	18.11	358	13.10	14.72	—	—	—
1.95	4.40	8.50	896	5.80	9.69	594	4.35	6.87	445	3.50	5.37	353	2.93	4.39	14.7	19.8	25.3
1.95	10.90	21.20	896	31.62	37.37	594	23.48	26.65	445	18.53	20.73	353	15.19	16.86	—	—	—
1.96	4.65	9.00	895	6.93	10.86	593	5.15	7.67	445	4.12	5.99	353	3.42	4.89	14.1	19.2	24.7
1.97	16.00	31.50	+	+	+	587	36.09	40.47	441	29.08	31.85	349	24.04	26.03	—	—	—
ARC-LENGTH CORRECTION FACTOR															0.82	0.83	0.84
1.98	6.70	13.20	882	15.85	20.12	584	11.48	14.14	438	9.03	10.97	348	7.41	8.92	—	—	—
1.99	7.10	14.00	881	17.50	21.87	584	12.68	15.38	438	9.97	11.93	347	8.17	9.69	—	—	—
2.00	5.20	10.30	875	9.40	13.40	580	6.88	9.44	435	5.46	7.34	345	4.51	5.99	12.6	14.1	15.6
2.00	5.50	10.90	875	10.72	14.77	580	7.81	10.39	435	6.18	8.07	345	5.09	6.58	11.8	13.3	14.9
2.00	6.30	12.50	875	14.17	18.36	580	10.27	12.90	435	8.09	10.01	345	6.64	8.14	—	—	12.9
ARC-LENGTH CORRECTION FACTOR															0.80	0.82	0.83
2.01	4.65	9.25	870	6.95	10.86	577	5.15	7.68	433	4.12	5.99	343	3.43	4.89	13.9	15.4	16.9
2.01	4.90	9.75	870	8.07	12.02	577	5.94	8.48	433	4.73	6.61	343	3.92	5.39	13.3	14.8	16.3
2.01	7.50	15.00	869	19.13	23.60	576	13.87	16.60	432	10.90	12.88	343	8.93	10.46	—	—	—
2.01	8.00	16.00	869	21.12	25.73	576	15.34	18.12	432	12.05	14.06	343	9.87	11.42	—	—	—
2.01	11.80	23.60	871	34.51	40.73	578	25.88	29.21	433	20.48	22.76	344	16.80	18.52	—	—	—
ARC-LENGTH CORRECTION FACTOR															0.81	0.83	0.84
2.01	14.00	28.00	872	40.66	48.36	578	31.43	35.25	433	25.09	27.59	344	20.65	22.49	—	—	—
2.02	5.90	11.80	868	12.46	16.58	575	9.05	11.65	431	7.14	9.05	342	5.87	7.36	—	12.2	13.8
2.03	9.25	18.70	861	25.88	30.90	571	18.93	21.86	428	14.89	16.97	339	12.19	13.79	—	—	—
2.07	4.40	9.00	846	5.82	9.71	560	4.37	6.88	420	3.52	5.38	333	2.94	4.40	14.3	15.8	17.3
2.07	5.50	11.30	844	10.74	14.78	559	7.82	10.40	419	6.19	8.08	333	5.10	6.58	11.4	13.0	14.5
ARC-LENGTH CORRECTION FACTOR															0.81	0.83	0.84
2.07	10.30	21.20	846	29.62	35.08	561	21.86	24.94	421	17.23	19.38	334	14.12	15.75	—	—	—
2.09	9.00	18.70	837	24.96	29.89	555	18.23	21.13	416	14.33	16.40	330	11.74	13.32	—	—	—
2.10	11.30	23.60	834	32.95	38.90	553	24.57	27.81	415	19.41	21.65	329	15.92	17.60	—	—	—
2.11	6.30	13.20	828	14.19	18.38	549	10.28	12.91	412	8.10	10.02	327	6.65	8.15	—	—	12.2
2.11	6.70	14.00	831	15.87	20.14	551	11.49	14.15	413	9.04	10.98	328	7.42	8.93	—	—	—
ARC-LENGTH CORRECTION FACTOR															0.0	0.0	0.80
2.11	15.00	31.50	+	+	+	550	33.83	37.91	413	27.12	29.75	327	22.37	24.28	—	—	—
2.12	4.65	9.75	825	6.97	10.88	547	5.17	7.69	410	4.13	6.00	325	3.44	4.90	13.4	15.0	16.5
2.12	4.90	10.30	824	8.09	12.04	546	5.95	8.49	409	4.74	6.61	325	3.93	5.40	12.8	14.3	15.8
2.12	5.20	10.90	826	9.42	13.42	548	6.89	9.45	411	5.47	7.35	326	4.52	5.99	12.0	13.6	15.1
2.13	4.40	9.25	822	5.83	9.72	545	4.37	6.88	409	3.52	5.38	324	2.94	4.40	14.1	15.6	17.1
ARC-LENGTH CORRECTION FACTOR															0.81	0.82	0.83
2.13	7.10	15.00	822	17.53	21.89	545	12.69	15.39	409	9.98	11.94	324	8.18	9.70	—	—	—
2.13	13.20	28.00	822	38.60	45.70	545	29.48	33.10	408	23.45	25.86	324	19.28	21.06	—	—	—
2.14	5.90	12.50	819	12.49	16.59	543	9.06	11.66	407	7.15	9.06	323	5.88	7.37	—	11.6	13.1
2.15	7.50	16.00	814	19.16	23.62	540	13.88	16.62	405	10.91	12.89	321	8.94	10.47	—	—	—
2.17	5.50	11.80	808	10.75	14.79	535	7.83	10.40	402	6.19	8.09	318	5.11	6.59	11.0	12.5	14.1
ARC-LENGTH CORRECTION FACTOR															0.78	0.80	0.81
2.18	10.90	23.60	804	31.66	37.40	533	23.50	26.67	400	18.55	20.75	317	15.21	16.87	—	—	—
2.19	9.75	21.20	800	27.71	32.93	531	20.35	23.34	398	16.02	18.13	316	13.12	14.73	—	—	—
2.20	5.20	11.30	797	9.44	13.43	528	6.90	9.45	396	5.47	7.36	314	4.52	6.00	11.6	13.2	14.7
2.21	8.50	18.70	790	23.09	27.85	524	26.81	19.64	393	13.21	15.24	312	10.82	12.38	—	—	—
2.24	4.40	9.75	780	5.85	9.73	517	4.38	6.89	388	3.53	5.39	307	2.95	4.41	13.6	15.2	16.7
ARC-LENGTH CORRECTION FACTOR															0.79	0.80	0.82
2.24	4.65	10.30	781	6.98	10.89	517	5.18	7.70	388	4.14	6.00	308	3.44	4.91	13.0	14.5	16.0
2.24	6.30	14.00	781	14.21	18.39	517	10.29	12.92	388	8.11	10.03	308	6.66	8.16	—	—	—
2.25	4.90	10.90	778	8.11	12.05	516	5.97	8.50	387	4.75	6.62	307	3.94	5.40	12.2	13.8	15.3
2.25	12.50	28.00	778	36.65	43.28	516	27.72	31.19	387	21.99	24.33	307	18.06	19.80	—	—	—
2.26	5.90	13.20	775	12.50	16.61	514	9.07	11.67	385	7.16	9.06	305	5.89	7.38	—	—	12.5
ARC-LENGTH CORRECTION FACTOR															0.80	0.81	0.83
2.26	6.70	15.00	775	15.89	20.16	514	11.51	14.16	385	9.05	10.99	306	7.42	8.93	—	—	—
2.26	14.00	31.50	775	40.70	48.39	514	31.46	35.27	385	25.11	27.61	305	20.67	22.51	—	—	—
2.27	7.10	16.00	770	17.55	21.91	511	12.71	15.40	383	9.99	11.94	304	8.19	9.71	—	—	—
2.29	5.20	11.80	763	9.45	13.43	506	6.91	9.46	379	5.48	7.36	301	4.53	6.00	11.2	12.7	14.3
2.30	5.50	12.50	762	10.77	14.80	505	7.84	10.41	379	6.20	8.09	300	5.11	6.59	—	11.8	13.4
ARC-LENGTH CORRECTION FACTOR															0.77	0.79	0.81

5V = STANDARD V-BELT
 5VX = COGGED/NOTCHED V-BELT
 + IF RIM SPEED EXCEEDS 6500 FEET PER MINUTE, CONSULT *Martin*.





Stock Drive 5V Selection

V-BELT DRIVES

Nominal Center Distances And Arc-Length Correction Factor															Sheave Combination		Speed Ratio
5V/5VX Belt Length Designation															DriveR O.D.	DriveN O.D.	
800	900	1000	1120	1250	1320	1400	1600	1800	2000	2240	2500	2800	3150	3550			
17.1	22.2	27.3	33.4	39.9	43.4	47.4	57.5	67.5	77.5	89.5	102.6	117.6	135.1	155.1	9.75	18.70	1.93
29.8	34.8	39.8	45.8	52.3	55.8	59.8	69.8	79.8	89.8	101.8	114.9	129.9	147.4	167.4	4.40	8.50	1.95
—	19.1	24.2	30.4	36.9	40.5	44.5	54.5	64.6	74.6	86.6	99.7	114.7	132.3	152.2	10.90	21.20	1.95
29.2	34.2	39.2	45.2	51.7	55.2	59.2	69.2	79.2	89.3	101.3	114.3	129.3	146.8	166.8	4.65	9.00	1.96
—	—	—	—	—	27.6	31.7	42.0	52.1	62.2	74.3	87.3	102.4	119.9	140.0	16.00	31.50	1.97
0.91	0.93	0.95	0.97	0.99	1.00	1.01	1.03	1.05	1.07	1.09	1.11	1.13	1.15	1.17			
24.2	29.2	34.2	40.2	46.8	50.3	54.3	64.3	74.3	84.3	96.3	109.3	124.3	141.8	161.8	6.70	13.20	1.98
23.2	28.2	33.2	39.3	45.8	49.3	53.3	63.3	73.3	83.4	95.4	108.4	123.4	140.9	160.9	7.10	14.00	1.99
27.7	32.7	37.7	43.8	50.3	53.8	57.8	67.8	77.8	87.8	99.8	112.8	127.8	145.3	165.3	5.20	10.30	2.00
27.0	32.0	37.0	43.0	49.5	53.1	57.1	67.1	77.1	87.1	99.1	112.1	127.1	144.6	164.6	5.50	10.90	2.00
25.0	30.1	35.1	41.1	47.6	51.1	55.1	65.2	75.2	85.2	97.2	110.2	125.2	142.7	162.7	6.30	12.50	2.00
0.90	0.93	0.95	0.97	0.99	1.00	1.01	1.03	1.05	1.07	1.09	1.11	1.13	1.14	1.16			
29.0	34.0	39.0	45.0	51.5	55.0	59.0	69.0	79.0	89.1	101.1	114.1	129.1	146.6	166.6	4.65	9.25	2.01
28.4	33.4	38.4	44.4	50.9	54.4	58.4	68.5	78.5	88.5	100.5	113.5	128.5	146.0	166.0	4.90	9.75	2.01
22.0	27.1	32.1	38.1	44.7	48.2	52.2	62.2	72.2	82.2	94.3	107.3	122.3	139.8	159.8	7.50	15.00	2.01
20.8	25.8	30.9	36.9	43.5	47.0	51.0	61.0	71.0	81.1	93.1	106.1	121.1	138.6	158.6	8.00	16.00	2.01
—	—	21.4	27.6	34.2	37.7	41.8	51.9	61.9	72.0	84.0	97.0	112.0	129.6	149.6	11.80	23.60	2.01
0.91	0.93	0.95	0.97	0.99	1.00	1.01	1.03	1.05	1.07	1.09	1.11	1.13	1.15	1.17			
—	—	—	—	28.7	32.3	36.3	46.5	56.6	66.6	78.7	91.7	106.8	124.3	144.3	14.00	28.00	2.01
25.9	31.0	36.0	42.0	48.5	52.0	56.0	66.0	76.0	86.0	98.1	111.1	126.1	143.6	163.6	5.90	11.80	2.02
17.4	22.6	27.6	33.7	40.3	43.8	47.8	57.9	67.9	77.9	89.9	102.9	118.0	135.5	155.5	9.25	18.70	2.03
29.4	34.4	39.4	45.4	51.9	55.4	59.4	69.4	79.4	89.4	101.4	114.5	129.5	147.0	167.0	4.40	9.00	2.07
26.6	31.7	36.7	42.7	49.2	52.7	56.7	66.7	76.8	86.8	98.8	111.8	126.8	144.3	164.3	5.50	11.30	2.07
0.91	0.93	0.95	0.97	0.99	1.00	1.01	1.03	1.05	1.07	1.09	1.11	1.13	1.15	1.17			
—	19.5	24.7	30.8	37.4	40.9	44.9	55.0	65.0	75.1	87.1	100.1	115.1	132.6	152.7	10.30	21.20	2.07
17.6	22.7	27.8	33.9	40.5	44.0	48.0	58.0	68.1	78.1	90.1	103.1	118.1	135.7	155.7	9.00	18.70	2.09
—	—	21.7	27.9	34.5	38.1	42.1	52.2	62.3	72.3	84.4	97.4	112.4	129.9	150.0	11.30	23.60	2.10
24.4	29.5	34.5	40.5	47.1	50.6	54.6	64.6	74.6	84.6	96.6	109.6	124.6	142.1	162.1	6.30	13.20	2.11
23.5	28.5	33.5	39.6	46.1	49.6	53.6	63.6	73.7	83.7	95.7	108.7	123.7	141.2	161.2	6.70	14.00	2.11
0.89	0.92	0.94	0.96	0.98	0.99	1.00	1.03	1.05	1.06	1.08	1.10	1.12	1.14	1.16			
—	—	—	—	—	28.3	32.4	42.7	52.8	62.9	75.0	88.1	103.1	120.7	140.7	15.00	31.50	2.11
28.6	33.6	38.6	44.6	51.1	54.6	58.6	68.6	78.6	88.7	100.7	113.7	128.7	146.2	166.2	4.65	9.75	2.12
27.9	33.0	38.0	44.0	50.5	54.0	58.0	68.0	78.0	88.0	100.0	113.0	128.0	145.5	165.5	4.90	10.30	2.12
27.2	32.2	37.2	43.3	49.8	53.3	57.3	67.3	77.3	87.3	99.3	112.3	127.3	144.8	164.8	5.20	10.90	2.12
29.2	34.2	39.2	45.2	51.7	55.2	59.2	69.2	79.2	89.2	101.3	114.3	129.3	146.8	166.8	4.40	9.25	2.13
0.91	0.93	0.95	0.97	0.99	1.00	1.01	1.03	1.05	1.07	1.09	1.11	1.13	1.14	1.16			
22.3	27.4	32.4	38.4	45.0	48.5	52.5	62.5	72.5	82.5	94.6	107.6	122.6	140.1	160.1	7.10	15.00	2.13
—	—	—	—	29.2	32.8	36.9	47.1	57.2	67.2	79.3	92.3	107.4	124.9	145.0	13.20	28.00	2.13
25.3	30.4	35.4	41.4	47.9	51.4	55.5	65.5	75.5	85.5	97.5	110.5	125.5	143.0	163.0	5.90	12.50	2.14
21.1	26.2	31.3	37.3	43.8	47.4	51.4	61.4	71.4	81.4	93.4	106.5	121.5	139.0	159.0	7.50	16.00	2.15
26.2	31.3	36.3	42.3	48.8	52.3	56.3	66.3	76.3	86.4	98.4	111.4	126.4	143.9	163.9	5.50	11.80	2.17
0.90	0.92	0.94	0.96	0.98	0.99	1.00	1.03	1.05	1.07	1.09	1.10	1.12	1.14	1.16			
—	—	22.0	28.2	34.8	38.4	42.4	52.5	62.6	72.6	84.7	97.7	112.7	130.2	150.3	10.90	23.60	2.18
—	19.9	25.0	31.2	37.8	41.3	45.3	55.4	65.4	75.5	87.5	100.5	115.6	133.1	153.1	9.75	21.20	2.19
26.9	31.9	36.9	42.9	49.4	53.0	57.0	67.0	77.0	87.0	99.0	112.0	127.0	144.5	164.5	5.20	11.30	2.20
17.9	23.1	28.2	34.3	40.8	44.3	48.4	58.4	68.4	78.5	90.5	103.5	118.5	136.0	156.1	8.50	18.70	2.21
28.8	33.8	38.8	44.8	51.3	54.8	58.8	68.8	78.8	88.8	100.9	113.9	128.9	146.4	166.4	4.40	9.75	2.24
0.90	0.92	0.94	0.96	0.98	0.99	1.00	1.03	1.05	1.07	1.09	1.10	1.12	1.14	1.16			
28.1	33.1	38.2	44.2	50.7	54.2	58.2	68.2	78.2	88.2	100.2	113.2	128.2	145.7	165.7	4.65	10.30	2.24
23.7	28.8	33.8	39.9	46.4	49.9	53.9	63.9	74.0	84.0	96.0	109.0	124.0	141.5	161.5	6.30	14.00	2.24
27.4	32.5	37.5	43.5	50.0	53.5	57.5	67.5	77.5	87.5	99.5	112.6	127.6	145.1	165.1	4.90	10.90	2.25
—	—	—	22.9	29.7	33.3	37.4	47.6	57.7	67.7	79.8	92.9	107.9	125.5	145.5	12.50	28.00	2.25
24.7	29.8	34.8	40.8	47.4	50.9	54.9	64.9	74.9	84.9	96.9	109.9	124.9	142.5	162.5	5.90	13.20	2.26
0.90	0.93	0.94	0.97	0.99	1.00	1.01	1.03	1.05	1.07	1.09	1.11	1.12	1.14	1.16			
22.6	27.6	32.7	38.7	45.3	48.8	52.8	62.8	72.8	82.9	94.9	107.9	122.9	140.4	160.4	6.70	15.00	2.26
—	—	—	—	25.2	28.9	33.1	43.4	53.5	63.7	75.8	88.8	103.9	121.4	141.5	14.00	31.50	2.26
21.4	26.5	31.5	37.6	44.1	47.6	51.7	61.7	71.7	81.7	93.8	106.8	121.8	139.3	159.3	7.10	16.00	2.27
26.4	31.5	36.5	42.5	49.0	52.5	56.6	66.6	76.6	86.6	98.6	111.6	126.6	144.1	164.1	5.20	11.80	2.29
25.6	30.7	35.7	41.7	48.2	51.7	55.8	65.8	75.8	85.8	97.8	110.8	125.8	143.3	163.3	5.50	12.50	2.30
0.90	0.92	0.94	0.96	0.98	0.99	1.00	1.03	1.05	1.07	1.09	1.10	1.12	1.14	1.16			

FOR BELT SIZES NOT SHOWN, INTERPOLATE FOR ADDITIONAL CENTER DISTANCE.

5V Stock Drive Selection



V-BELT DRIVES

Speed Ratio	Sheave Combination		DriveN Speeds and HP Per Belt												Nominal Center Distance And Arc-Length Correction Factors		
			1750 RPM DriveR			1160 RPM DriveR			870 RPM DriveR			690 RPM DriveR					
	DriveR O.D.	DriveN O.D.	DriveN RPM	HP Per Belt 5V	HP Per Belt 5VX	DriveN RPM	HP Per Belt 5V	HP Per Belt 5VX	DriveN RPM	HP Per Belt 5V	HP Per Belt 5VX	DriveN RPM	HP Per Belt 5V	HP Per Belt 5VX	5V/5VX Belt Length Designation		
															500	600	710
2.30	10.30	23.60	760	29.65	35.10	503	21.88	24.95	378	17.25	19.39	299	14.13	15.76	—	—	—
2.31	9.25	21.20	759	25.92	30.93	503	18.96	21.88	377	14.91	16.99	299	12.21	13.80	—	—	—
2.33	4.90	11.30	750	8.12	12.06	497	5.97	8.50	373	4.76	6.62	296	3.94	5.41	11.8	17.0	22.5
2.35	8.00	18.70	743	21.17	25.77	493	15.37	18.15	370	12.07	14.07	293	9.89	11.43	—	—	—
2.35	16.00	37.50	+	+	+	493	36.13	40.50	370	29.11	31.88	293	24.06	26.04	—	—	—
ARC-LENGTH CORRECTION FACTOR															0.78	0.83	0.87
2.37	4.40	10.30	738	5.86	9.74	489	4.39	6.90	367	3.54	5.39	291	2.95	4.41	13.1	18.2	23.8
2.37	4.65	10.90	737	7.00	10.90	489	5.19	7.70	367	4.15	6.01	291	3.45	4.91	12.4	17.5	23.1
2.37	9.00	21.20	738	25.00	29.92	489	18.25	21.14	367	14.35	16.41	291	11.75	13.33	—	—	—
2.38	11.80	28.00	734	34.56	40.77	486	25.91	29.24	365	20.51	22.78	289	16.83	18.53	—	—	—
2.40	5.90	14.00	730	12.52	16.62	484	9.08	11.68	363	7.16	9.07	288	5.89	7.38	—	13.8	19.4
ARC-LENGTH CORRECTION FACTOR															0.80	0.84	0.88
2.40	6.30	15.00	728	14.23	18.40	483	10.31	12.93	362	8.11	10.03	287	6.66	8.16	—	—	18.3
2.40	13.20	31.50	730	38.63	45.73	484	29.50	33.12	363	23.46	25.87	288	19.29	21.07	—	—	—
2.41	6.70	16.00	726	15.91	20.17	482	11.52	14.17	361	9.06	10.99	286	7.43	8.94	—	—	17.0
2.43	5.20	12.50	720	9.46	13.45	477	6.92	9.47	358	5.49	7.36	284	4.53	6.00	—	15.7	21.3
2.43	5.50	13.20	721	10.78	14.81	478	7.85	10.42	359	6.21	8.10	284	5.12	6.60	—	14.8	20.5
ARC-LENGTH CORRECTION FACTOR															0.0	0.82	0.86
2.44	4.90	11.80	718	8.13	12.07	476	5.98	8.51	357	4.76	6.63	283	3.94	5.41	11.4	16.5	22.1
2.44	9.75	23.60	719	27.74	32.95	476	20.37	23.36	357	16.04	18.14	283	13.13	14.74	—	—	—
2.46	4.65	11.30	711	7.00	10.91	471	5.19	7.71	353	4.15	6.01	280	3.45	4.91	12.0	17.2	22.7
2.49	11.30	28.00	703	33.00	38.93	466	24.60	27.83	349	19.44	21.66	277	15.94	17.62	—	—	—
2.51	4.40	10.90	697	5.87	9.75	462	4.40	6.90	346	3.54	5.40	275	2.96	4.41	12.6	17.7	23.3
ARC-LENGTH CORRECTION FACTOR															0.77	0.83	0.87
2.51	7.50	18.70	696	19.19	23.65	462	13.91	16.63	346	10.93	12.90	275	8.95	10.48	—	—	—
2.51	8.50	21.20	697	23.12	27.87	462	16.83	19.66	346	13.22	15.25	275	10.83	12.39	—	—	—
2.51	15.00	37.50	+	+	+	462	33.85	37.93	347	27.14	29.77	275	22.38	24.29	—	—	—
2.53	12.50	31.50	691	36.67	43.30	458	27.73	31.20	344	22.00	24.34	272	18.07	19.81	—	—	—
2.56	6.30	16.00	682	14.24	18.41	452	10.31	12.94	339	8.12	10.04	269	6.67	8.16	—	—	17.3
ARC-LENGTH CORRECTION FACTOR															0.0	0.0	0.83
2.57	4.65	11.80	681	7.01	10.92	451	5.20	7.71	338	4.16	6.02	268	3.45	4.92	11.5	16.7	22.3
2.57	5.20	13.20	681	9.47	13.45	452	6.93	9.47	339	5.49	7.37	269	4.54	6.01	—	15.0	20.7
2.57	5.50	14.00	680	10.79	14.82	451	7.86	10.42	338	6.21	8.10	268	5.12	6.60	—	14.0	19.7
2.57	5.90	15.00	681	12.53	16.63	452	9.09	11.68	339	7.17	9.07	269	5.90	7.38	—	12.8	18.5
2.57	9.25	23.60	681	25.94	30.95	452	18.97	21.89	339	14.92	16.99	269	12.22	13.81	—	—	—
ARC-LENGTH CORRECTION FACTOR															0.77	0.83	0.87
2.58	4.90	12.50	677	8.14	12.07	449	5.99	8.51	337	4.77	6.63	267	3.95	5.41	—	15.9	21.5
2.58	10.90	28.00	677	31.70	37.43	449	23.53	26.69	337	18.57	20.76	267	15.22	16.88	—	—	—
2.60	4.40	11.30	672	5.88	9.75	445	4.41	6.91	334	3.55	5.40	265	2.96	4.42	12.2	17.3	22.9
2.64	9.00	23.60	663	25.02	29.94	439	18.27	21.15	329	14.36	16.42	261	11.76	13.34	—	—	—
2.66	7.10	18.70	659	17.58	21.93	437	12.73	15.42	327	10.00	11.96	260	8.20	9.72	—	—	—
ARC-LENGTH CORRECTION FACTOR															0.78	0.83	0.87
2.67	8.00	21.20	655	21.19	25.79	434	15.39	18.16	326	12.09	14.08	258	9.90	11.44	—	—	—
2.68	11.80	31.50	652	34.58	40.79	432	25.93	29.25	324	20.52	22.79	257	16.83	18.54	—	—	—
2.69	14.00	37.50	650	40.73	48.42	431	31.48	35.29	323	25.12	27.62	256	20.68	22.52	—	—	—
2.72	4.40	11.80	643	5.89	9.76	426	4.41	6.91	320	3.55	5.40	254	2.96	4.42	11.7	16.9	22.5
2.73	4.65	12.50	642	7.02	10.92	426	5.20	7.72	319	4.16	6.02	253	3.46	4.92	10.8	16.1	21.7
ARC-LENGTH CORRECTION FACTOR															0.77	0.83	0.87
2.73	4.90	13.20	641	8.15	12.08	425	5.99	8.52	319	4.77	6.64	253	3.95	5.42	—	15.2	20.9
2.73	5.20	14.00	642	9.48	13.46	426	6.93	9.48	319	5.50	7.37	253	4.54	6.01	—	14.2	19.9
2.74	5.90	16.00	638	12.54	16.64	423	9.10	11.69	317	7.18	9.08	252	5.90	7.39	—	—	17.8
2.74	10.30	28.00	640	29.69	35.13	424	21.90	24.97	318	17.26	19.41	252	14.14	15.77	—	—	—
2.76	5.50	15.00	634	10.80	14.83	420	7.87	10.43	315	6.22	8.11	250	5.13	6.60	—	13.0	18.8
ARC-LENGTH CORRECTION FACTOR															0.0	0.81	0.86
2.80	8.50	23.60	626	23.14	27.88	415	16.84	19.67	311	13.23	15.26	247	10.83	12.40	—	—	—
2.80	11.30	31.50	624	33.02	38.95	414	24.61	27.84	310	19.45	21.67	246	15.94	17.62	—	—	—
2.82	6.70	18.70	621	15.93	20.19	412	11.53	14.19	309	9.07	11.00	245	7.44	8.95	—	—	—
2.85	7.50	21.20	614	19.21	23.66	407	13.92	16.64	305	10.94	12.91	242	8.96	10.49	—	—	—
2.85	13.20	37.50	613	38.66	45.75	406	29.52	33.13	305	23.48	25.89	242	19.30	21.08	—	—	—
ARC-LENGTH CORRECTION FACTOR															0.0	0.0	0.0

5V = STANDARD V-BELT
 5VX = COGGED/NOTCHED V-BELT
 + IF RIM SPEED EXCEEDS 6500 FEET PER MINUTE, CONSULT *Martin*.





Stock Drive Selection 5V

Nominal Center Distances And Arc-Length Correction Factor															Sheave Combination		Speed Ratio
5V/5VX Belt Length Designation															DriveR O. D.	DriveN O. D.	
800	900	1000	1120	1250	1320	1400	1600	1800	2000	2240	2500	2800	3150	3550			
—	—	22.4	28.6	35.2	38.8	42.9	53.0	63.0	73.1	85.1	98.1	113.2	130.7	150.7	10.30	23.60	2.30
—	20.2	25.4	31.5	38.1	41.7	45.7	55.8	65.8	75.8	87.9	100.9	115.9	133.5	153.5	9.25	21.20	2.31
27.1	32.1	37.1	43.2	49.7	53.2	57.2	67.2	77.2	87.2	99.2	112.2	127.2	144.7	164.7	4.90	11.30	2.33
18.2	23.4	28.5	34.6	41.2	44.7	48.7	58.8	68.8	78.8	90.9	103.9	118.9	136.4	156.4	8.00	18.70	2.35
—	—	—	—	—	—	—	36.4	46.7	57.0	69.1	82.3	97.4	115.0	135.1	16.00	37.50	2.35
0.90	0.92	0.94	0.96	0.98	0.99	1.00	1.03	1.05	1.07	1.09	1.10	1.12	1.14	1.16			
28.3	33.3	38.3	44.4	50.9	54.4	58.4	68.4	78.4	88.4	100.4	113.4	128.4	145.9	165.9	4.40	10.30	2.37
27.6	32.6	37.7	43.7	50.2	53.7	57.7	67.7	77.7	87.7	99.7	112.7	127.7	145.3	165.3	4.65	10.90	2.37
—	20.4	25.6	31.7	38.3	41.8	45.9	55.9	66.0	76.0	88.1	101.1	116.1	133.6	153.7	9.00	21.20	2.37
—	—	—	23.3	30.2	33.8	37.9	48.1	58.2	68.3	80.3	93.4	108.4	126.0	146.0	11.80	28.00	2.38
24.0	29.1	34.1	40.2	46.7	50.2	54.2	64.2	74.3	84.3	96.3	109.3	124.3	141.8	161.8	5.90	14.00	2.40
0.90	0.92	0.94	0.97	0.98	0.99	1.01	1.03	1.05	1.07	1.09	1.11	1.12	1.14	1.16			
22.9	27.9	33.0	39.0	45.6	49.1	53.1	63.1	73.1	83.2	95.2	108.2	123.2	140.7	160.7	6.30	15.00	2.40
—	—	—	—	25.8	29.5	33.6	43.9	54.1	64.2	76.3	89.4	104.5	122.0	142.1	13.20	31.50	2.40
21.7	26.8	31.8	37.9	44.4	47.9	52.0	62.0	72.0	82.0	94.1	107.1	122.1	139.6	159.6	6.70	16.00	2.41
25.8	30.9	35.9	41.9	48.5	52.0	56.0	66.0	76.0	86.0	98.0	111.0	126.0	143.6	163.6	5.20	12.50	2.43
25.0	30.1	35.1	41.1	47.7	51.2	55.2	65.2	75.2	85.2	97.2	110.2	125.3	142.8	162.8	5.50	13.20	2.43
0.89	0.92	0.94	0.96	0.98	0.99	1.00	1.03	1.05	1.06	1.08	1.10	1.12	1.14	1.16			
26.7	31.7	36.7	42.7	49.3	52.8	56.8	66.8	76.8	86.8	98.8	111.8	126.8	144.3	164.3	4.90	11.80	2.44
—	—	22.8	29.0	35.6	39.2	43.3	53.4	63.4	73.5	85.5	98.6	113.6	131.1	151.1	9.75	23.60	2.44
27.3	32.3	37.3	43.3	49.9	53.4	57.4	67.4	77.4	87.4	99.4	112.4	127.4	144.9	164.9	4.65	11.30	2.46
—	—	—	23.7	30.5	34.1	38.2	48.4	58.5	68.6	80.7	93.8	108.8	126.4	146.4	11.30	28.00	2.49
27.8	32.8	37.8	43.9	50.4	53.9	57.9	67.9	77.9	87.9	99.9	112.9	127.9	145.4	165.5	4.40	10.90	2.51
0.89	0.92	0.94	0.96	0.98	0.99	1.00	1.03	1.05	1.07	1.08	1.10	1.12	1.14	1.16			
18.6	23.8	28.9	35.0	41.5	45.1	49.1	59.2	69.2	79.2	91.3	104.3	119.3	136.8	156.8	7.50	18.70	2.51
—	20.7	25.9	32.0	38.7	42.2	46.2	56.3	66.4	76.4	88.4	101.5	116.5	134.0	154.0	8.50	21.20	2.51
—	—	—	—	—	—	—	37.1	47.4	57.7	69.9	83.0	98.1	115.7	135.8	15.00	37.50	2.51
—	—	—	—	26.2	29.9	34.1	44.4	54.6	64.7	76.9	89.9	105.0	122.6	142.6	12.50	31.50	2.53
21.9	27.1	32.1	38.2	44.7	48.2	52.3	62.3	72.3	82.3	94.4	107.4	122.4	139.9	159.9	6.30	16.00	2.56
0.87	0.90	0.92	0.95	0.97	0.98	0.99	1.02	1.04	1.06	1.08	1.10	1.12	1.14	1.16			
26.8	31.9	36.9	42.9	49.5	53.0	57.0	67.0	77.0	87.0	99.0	112.0	127.0	144.5	164.5	4.65	11.80	2.57
25.2	30.3	35.3	41.4	47.9	51.4	55.4	65.4	75.4	85.5	97.5	110.5	125.5	143.0	163.0	5.20	13.20	2.57
24.3	29.4	34.4	40.5	47.0	50.5	54.5	64.5	74.6	84.6	96.6	109.6	124.6	142.1	162.1	5.50	14.00	2.57
23.1	28.2	33.3	39.3	45.9	49.4	53.4	63.4	73.4	83.5	95.5	108.5	123.5	141.0	161.0	5.90	15.00	2.57
—	—	—	—	36.0	39.5	43.6	53.7	63.8	73.9	85.9	98.9	114.0	131.5	151.5	9.25	23.60	2.57
0.89	0.92	0.94	0.96	0.98	0.99	1.00	1.03	1.05	1.06	1.08	1.10	1.12	1.14	1.16			
26.1	31.1	36.1	42.2	48.7	52.2	56.2	66.2	76.2	86.3	98.3	111.3	126.3	143.8	163.8	4.90	12.50	2.58
—	—	—	23.9	30.8	34.4	38.5	48.7	58.8	68.9	81.0	94.1	109.1	126.7	146.7	10.90	28.00	2.58
27.5	32.5	37.5	43.5	50.1	53.6	57.6	67.6	77.6	87.6	99.6	112.6	127.6	145.1	165.1	4.40	11.30	2.60
—	—	—	23.3	29.5	32.9	36.2	46.2	56.2	66.2	78.2	91.2	106.2	123.7	143.7	9.00	23.60	2.64
18.8	24.0	29.2	35.3	41.8	45.4	49.4	59.5	69.5	79.5	91.6	104.6	119.6	137.1	157.1	7.10	18.70	2.66
0.90	0.92	0.94	0.96	0.98	0.99	1.00	1.03	1.05	1.07	1.08	1.10	1.12	1.14	1.16			
—	21.0	26.2	32.4	39.0	42.6	46.6	56.7	66.7	76.8	88.8	101.9	116.9	134.4	154.4	8.00	21.20	2.67
—	—	—	—	26.7	30.4	34.6	44.9	55.1	65.2	77.4	90.5	105.5	123.1	143.2	11.80	31.50	2.68
—	—	—	—	—	—	—	37.7	48.1	58.4	70.6	83.7	98.9	116.5	136.5	14.00	37.50	2.69
27.0	32.1	37.1	43.1	49.6	53.1	57.2	67.2	77.2	87.2	99.2	112.2	127.2	144.7	164.7	4.40	11.80	2.72
26.2	31.3	36.3	42.3	48.9	52.4	56.4	66.4	76.4	86.3	98.5	111.5	126.5	144.0	164.0	4.65	12.50	2.73
0.89	0.92	0.94	0.96	0.98	0.99	1.00	1.03	1.05	1.06	1.08	1.10	1.12	1.14	1.16			
25.4	30.5	35.5	41.6	48.1	51.6	55.6	65.7	75.7	85.7	97.7	110.7	125.7	143.2	163.2	4.90	13.20	2.73
24.5	29.6	34.6	40.7	47.2	50.7	54.7	64.8	74.8	84.8	96.8	109.8	124.8	142.4	162.4	5.20	14.00	2.73
22.2	27.3	32.4	38.5	45.0	48.5	52.6	62.6	72.6	82.6	94.7	107.7	122.7	140.2	160.2	5.90	16.00	2.74
—	—	—	24.3	31.2	34.8	38.9	49.1	59.3	69.4	81.4	94.5	109.6	127.1	147.2	10.30	28.00	2.74
23.4	28.5	33.6	39.6	46.2	49.7	53.7	63.7	73.7	83.8	95.8	108.8	123.8	141.3	161.3	5.50	15.00	2.76
0.89	0.91	0.93	0.96	0.98	0.99	1.00	1.02	1.04	1.06	1.08	1.10	1.12	1.14	1.16			
—	—	23.6	29.8	36.5	40.1	44.1	54.3	64.3	74.4	86.5	99.5	114.5	132.1	152.1	8.50	23.60	2.80
—	—	—	—	27.0	30.7	34.9	45.3	55.5	65.6	77.7	90.8	105.9	123.5	143.5	11.30	31.50	2.80
19.1	24.3	29.4	35.5	42.1	45.7	49.7	59.7	69.8	79.8	91.9	104.9	119.9	137.4	157.4	6.70	18.70	2.82
—	—	—	—	39.4	42.9	47.0	57.0	67.1	77.2	89.2	102.2	117.3	134.8	154.8	7.50	21.20	2.85
—	—	—	—	—	—	—	38.3	48.7	58.9	71.1	84.3	99.4	117.0	137.1	13.20	37.50	2.85
0.84	0.88	0.91	0.94	0.96	0.97	0.98	1.01	1.03	1.05	1.08	1.10	1.12	1.14	1.16			

FOR BELT SIZES NOT SHOWN, INTERPOLATE FOR ADDITIONAL CENTER DISTANCE.

V-BELT DRIVES

5V Stock Drive Selection



V-BELT DRIVES

Speed Ratio	Sheave Combination		DriveN Speeds and HP Per Belt												Nominal Center Distance And Arc-Length Correction Factors		
			1750 RPM DriveR			1160 RPM DriveR			870 RPM DriveR			690 RPM DriveR					
	DriveR O.D.	DriveN O.D.	DriveN RPM	HP Per Belt 5V	HP Per Belt 5VX	DriveN RPM	HP Per Belt 5V	HP Per Belt 5VX	DriveN RPM	HP Per Belt 5V	HP Per Belt 5VX	DriveN RPM	HP Per Belt 5V	HP Per Belt 5VX	5V/5VX Belt Length Designation		
															500	600	710
2.88	4.40	12.50	607	5.90	9.76	402	4.42	6.92	302	3.55	5.40	239	2.97	4.42	11.0	16.2	21.9
2.88	4.65	13.20	608	7.03	10.93	403	5.21	7.72	302	4.16	6.02	240	3.46	4.92	—	15.4	21.0
2.89	9.75	28.00	605	27.77	32.97	401	20.39	23.37	301	16.05	18.15	239	13.14	14.75	—	—	—
2.90	4.70	14.00	604	8.15	12.09	401	6.00	8.52	300	4.77	6.64	238	3.95	5.42	—	14.4	20.1
2.91	10.90	31.50	602	31.72	37.44	399	23.54	26.70	299	18.58	20.77	237	15.23	16.89	—	—	—
ARC-LENGTH CORRECTION FACTOR															0.75	0.82	0.86
2.92	5.20	15.00	599	9.49	13.47	397	6.94	9.48	298	5.50	7.38	236	4.54	6.01	—	13.2	19.0
2.94	5.50	16.00	594	10.81	14.84	394	7.87	10.43	295	6.22	8.11	234	5.13	6.60	—	—	17.8
2.97	8.00	23.60	588	21.21	25.80	390	15.39	18.17	292	12.09	14.09	232	9.90	11.45	—	—	—
3.00	6.30	18.70	583	14.26	18.43	387	10.33	12.95	290	8.13	10.05	230	6.68	8.17	—	—	—
3.01	7.10	21.20	581	17.60	21.94	385	12.74	15.42	289	10.01	11.96	229	8.21	9.72	—	—	—
ARC-LENGTH CORRECTION FACTOR															0.0	0.78	0.84
3.02	12.50	37.50	580	36.70	43.32	385	27.75	31.21	288	22.01	24.35	229	18.08	19.82	—	—	—
3.05	4.40	13.20	574	5.90	9.77	381	4.42	6.92	286	3.56	5.41	226	2.97	4.42	—	15.6	21.2
3.05	4.65	14.00	573	7.04	10.83	380	5.21	7.72	285	4.17	6.03	226	3.46	4.92	—	14.6	20.3
3.05	9.25	28.00	574	25.96	30.97	380	18.99	21.90	285	14.93	17.00	226	12.23	13.81	—	—	—
3.08	10.30	31.50	568	29.70	35.14	377	21.91	24.98	283	17.27	19.41	224	14.15	15.78	—	—	—
ARC-LENGTH CORRECTION FACTOR															0.0	0.81	0.85
3.10	4.90	15.00	564	8.16	12.09	374	6.00	8.53	280	4.78	6.64	222	3.96	5.42	—	13.4	19.2
3.12	5.20	16.00	561	9.50	13.47	372	6.94	9.48	279	5.50	7.38	221	4.55	6.01	—	—	18.0
3.13	9.00	28.00	558	25.04	29.95	370	18.28	21.17	278	14.37	16.42	220	11.77	13.34	—	—	—
3.14	16.00	50.00	+	+	+	370	36.16	40.52	277	29.13	31.89	220	24.08	26.06	—	—	—
3.18	7.50	23.60	551	19.22	23.67	365	13.93	16.65	274	10.94	12.91	217	8.97	10.49	—	—	—
ARC-LENGTH CORRECTION FACTOR															0.0	0.77	0.84
3.20	6.70	21.20	547	15.95	20.20	363	11.54	14.19	272	9.08	11.01	216	7.45	8.95	—	—	—
3.20	11.80	37.50	547	34.61	40.81	363	25.94	29.26	272	20.53	22.80	216	16.84	18.54	—	—	—
3.21	5.90	18.70	546	12.56	16.65	362	9.11	11.70	271	7.19	9.08	215	5.91	7.39	—	—	14.8
3.23	4.40	14.00	541	5.91	9.77	359	4.42	6.92	269	3.56	5.41	213	2.97	4.42	—	14.8	20.5
3.25	9.75	31.50	538	27.78	32.98	356	20.39	23.38	267	16.05	18.16	212	13.15	14.75	—	—	—
ARC-LENGTH CORRECTION FACTOR															0.0	0.79	0.85
3.27	4.65	15.00	534	7.04	10.94	354	5.22	7.73	266	4.17	6.03	211	3.47	4.92	—	13.6	19.4
3.31	4.90	16.00	528	8.17	12.10	350	6.01	8.53	263	4.78	6.64	208	3.96	5.42	—	—	18.2
3.32	8.50	28.00	527	23.16	27.90	349	16.85	19.68	262	13.24	15.26	208	10.84	12.40	—	—	—
3.34	11.30	37.50	524	33.04	38.96	347	24.62	27.85	261	19.46	21.68	207	15.95	17.63	—	—	—
3.35	15.00	50.00	+	+	+	346	33.88	37.95	260	27.16	29.78	206	22.40	24.30	—	—	—
ARC-LENGTH CORRECTION FACTOR															0.0	0.77	0.84
3.36	7.10	23.60	521	17.61	21.95	346	12.75	15.43	259	10.02	11.97	206	8.21	9.72	—	—	—
3.40	6.30	21.20	514	14.27	18.44	341	10.34	12.95	256	8.14	10.05	203	6.68	8.17	—	—	—
3.43	9.25	31.50	510	25.97	30.98	338	18.99	21.91	254	14.94	17.01	201	12.23	13.82	—	—	—
3.44	5.50	18.70	508	10.83	14.85	337	7.88	10.44	253	6.23	8.11	200	5.13	6.61	—	—	15.0
3.46	10.90	37.50	505	31.74	37.45	335	23.55	26.71	251	18.59	20.78	199	15.24	16.89	—	—	—
ARC-LENGTH CORRECTION FACTOR															0.0	0.0	0.77
3.47	4.40	15.00	505	5.91	9.78	335	4.43	6.92	251	3.56	5.41	199	2.97	4.43	—	13.7	19.5
3.49	4.65	16.00	501	7.05	10.94	332	5.22	7.73	249	4.17	6.03	197	3.47	4.93	—	—	18.4
3.53	8.00	28.00	496	21.22	25.81	328	15.40	18.17	246	12.10	14.09	195	9.91	11.45	—	—	—
3.53	9.00	31.50	496	25.05	29.96	329	18.29	21.17	247	14.38	16.43	196	11.77	13.35	—	—	—
3.56	6.70	23.80	491	15.96	20.21	326	11.55	14.20	244	9.08	11.01	194	7.45	8.95	—	—	—
ARC-LENGTH CORRECTION FACTOR															0.0	0.77	0.83
3.59	14.00	50.00	487	40.76	48.44	323	31.50	35.30	242	25.14	27.63	192	20.69	22.53	—	—	—
3.64	5.90	21.20	481	12.57	16.66	319	9.12	11.70	239	7.19	9.09	190	5.91	7.40	—	—	—
3.65	5.20	18.70	480	9.51	13.48	318	6.95	9.49	239	5.51	7.38	189	4.55	6.02	—	—	15.2
3.67	10.30	37.50	477	29.71	35.15	316	21.92	24.98	237	17.28	19.42	188	14.15	15.78	—	—	—
3.70	4.40	16.00	473	5.92	9.78	314	4.43	6.93	235	3.56	5.41	187	2.97	4.43	—	12.6	18.6
ARC-LENGTH CORRECTION FACTOR															0.0	0.74	0.82
3.74	8.50	31.50	468	23.16	27.90	310	16.86	19.68	233	13.25	15.27	185	10.84	12.40	—	—	—
3.77	7.50	28.00	464	19.24	23.68	308	13.94	16.66	231	10.95	12.92	183	8.97	10.50	—	—	—
3.79	6.30	23.60	462	14.28	18.45	306	10.34	12.96	230	8.14	10.05	182	6.68	8.18	—	—	—
3.81	13.20	50.00	459	38.68	45.77	305	29.53	33.14	228	23.49	25.90	181	19.31	21.09	—	—	—
3.87	4.90	18.70	452	8.18	12.11	299	6.01	8.54	225	4.79	6.65	178	3.96	5.43	—	—	15.4
ARC-LENGTH CORRECTION FACTOR															0.0	0.0	0.77

5V = STANDARD V-BELT
 5VX = COGGED/NOTCHED V-BELT
 + IF RIM SPEED EXCEEDS 6500 FEET PER MINUTE, CONSULT *Martin*.





Stock Drive Selection 5V

Nominal Center Distances And Arc-Length Correction Factor															Sheave Combination		Speed Ratio
5V/5VX Belt Length Designation															DriveR O. D.	DriveN O. D.	
800	900	1000	1120	1250	1320	1400	1600	1800	2000	2240	2500	2800	3150	3550			
26.4	31.5	36.5	42.5	49.1	52.6	56.6	66.6	76.6	86.6	98.6	111.7	126.7	144.2	164.2	4.40	12.50	2.88
25.6	30.7	35.7	41.8	48.3	51.8	55.8	65.8	75.9	85.9	97.9	110.9	125.9	143.4	163.4	4.65	13.20	2.88
—	—	—	24.7	31.5	35.2	39.3	49.5	59.7	69.8	81.8	94.9	110.0	127.5	147.6	9.75	28.00	2.89
24.7	29.8	34.9	40.9	47.4	51.0	55.0	65.0	75.0	85.0	97.0	110.1	125.1	142.6	162.6	4.90	14.00	2.90
—	—	—	—	27.3	31.0	35.2	45.5	55.7	65.9	78.0	91.1	106.2	123.8	143.8	10.90	31.50	2.91
0.89	0.91	0.93	0.96	0.98	0.99	1.00	1.02	1.04	1.06	1.08	1.10	1.12	1.14	1.16			
23.6	28.7	33.8	39.8	46.4	49.9	53.9	63.9	74.0	84.0	96.0	109.0	124.0	141.6	161.6	5.20	15.00	2.92
22.5	27.6	32.7	38.8	45.3	48.8	52.9	62.9	72.9	82.9	95.0	108.0	123.0	140.5	160.5	5.50	16.00	2.94
—	18.5	23.9	30.2	36.9	40.4	44.5	54.6	64.7	74.8	86.8	99.9	114.9	132.5	152.5	8.00	23.60	2.97
19.4	24.6	29.7	35.8	42.4	45.9	50.0	60.0	70.1	80.1	92.2	105.2	120.2	137.7	157.7	6.30	18.70	3.00
—	21.6	26.8	33.0	39.6	43.2	47.2	57.3	67.4	77.5	89.5	102.5	117.6	135.1	155.1	7.10	21.20	3.01
0.87	0.90	0.93	0.95	0.97	0.98	0.99	1.02	1.04	1.06	1.08	1.10	1.12	1.14	1.16			
—	—	—	—	—	—	27.9	38.7	49.1	59.4	71.6	84.8	99.9	117.6	137.7	12.50	37.50	3.02
25.8	30.9	35.9	41.9	48.5	52.0	56.0	66.0	76.0	86.1	98.1	111.1	126.1	143.6	163.6	4.40	13.20	3.05
24.9	30.0	35.0	41.1	47.6	51.1	55.2	65.2	75.2	85.2	97.2	110.3	125.3	142.8	162.8	4.65	14.00	3.05
—	—	—	25.0	31.9	35.5	39.6	49.9	60.0	70.1	82.2	95.3	110.3	127.9	147.9	9.25	28.00	3.05
—	—	—	—	27.6	31.4	35.6	45.9	56.2	66.3	78.5	91.6	106.6	124.2	144.3	10.30	31.50	3.08
0.88	0.91	0.93	0.95	0.98	0.99	1.00	1.02	1.04	1.06	1.08	1.10	1.12	1.14	1.16			
23.8	28.9	34.0	40.1	46.6	50.1	54.1	64.2	74.2	84.2	96.2	109.3	124.3	141.8	161.8	4.90	15.00	3.10
22.7	27.8	32.9	39.0	45.5	49.1	53.1	63.1	73.2	83.2	95.2	108.2	123.2	140.7	160.8	5.20	16.00	3.12
—	—	—	25.1	32.0	35.7	39.8	50.0	60.2	70.3	82.4	95.5	110.5	128.1	148.1	9.00	28.00	3.13
—	—	—	—	—	—	—	—	—	44.9	57.7	71.1	86.5	104.3	124.5	16.00	50.00	3.14
—	18.9	24.2	30.5	37.2	40.8	44.9	55.0	65.1	75.1	87.2	100.3	115.3	132.8	152.9	7.50	23.60	3.18
0.87	0.90	0.92	0.95	0.97	0.98	0.99	1.02	1.04	1.06	1.08	1.10	1.12	1.14	1.16			
16.5	21.9	27.1	33.3	39.9	43.5	47.5	57.6	67.7	77.7	89.8	102.8	117.9	135.4	155.4	6.70	21.20	3.20
—	—	—	—	—	—	28.4	39.2	49.6	59.9	72.1	85.3	100.5	118.1	138.2	11.80	37.50	3.20
19.6	24.9	30.0	36.1	42.7	46.2	50.3	60.3	70.4	80.4	92.5	105.5	120.5	138.0	158.0	5.90	18.70	3.21
25.1	30.2	35.2	41.3	47.8	51.3	55.3	65.4	75.4	85.4	97.4	110.4	125.5	143.0	163.0	4.40	14.00	3.23
—	—	—	—	28.0	31.7	36.0	46.3	56.6	66.7	78.9	92.0	107.0	124.6	144.7	9.75	31.50	3.25
0.88	0.90	0.93	0.95	0.97	0.98	0.99	1.02	1.04	1.06	1.08	1.10	1.12	1.14	1.16			
24.0	29.1	34.2	40.2	46.8	50.3	54.3	64.4	74.4	84.4	96.4	109.4	124.5	142.0	162.0	4.65	15.00	3.27
22.9	28.0	33.1	39.2	45.7	49.3	53.3	63.3	73.4	83.4	95.4	108.4	123.5	141.0	161.0	4.90	16.00	3.31
—	—	—	25.5	32.4	36.0	40.1	50.4	60.5	70.7	82.8	95.8	110.9	128.5	148.5	8.50	28.00	3.32
—	—	—	—	—	—	28.7	39.5	50.0	60.5	72.5	85.7	100.8	118.4	138.6	11.30	37.50	3.34
—	—	—	—	—	—	—	—	—	45.6	58.3	71.8	87.2	105.0	125.2	15.00	50.00	3.35
0.87	0.90	0.92	0.95	0.97	0.98	0.99	1.02	1.04	1.06	1.08	1.10	1.12	1.14	1.16			
—	19.1	24.5	30.8	37.5	41.1	45.1	55.3	65.4	75.4	87.5	100.5	115.6	133.1	153.2	7.10	23.60	3.36
16.7	22.1	27.4	33.6	40.2	43.8	47.8	57.9	68.0	78.0	90.1	103.1	118.2	135.7	155.7	6.30	21.20	3.40
—	—	—	—	28.3	32.1	36.3	46.7	56.9	67.1	79.2	92.3	107.4	125.0	145.1	9.25	31.50	3.43
19.9	25.1	30.3	36.4	43.0	46.5	50.6	60.6	70.7	80.7	92.8	105.8	120.8	138.3	158.4	5.50	18.70	3.44
—	—	—	—	—	—	28.9	39.8	50.2	60.2	72.8	86.0	101.1	118.7	138.8	10.90	37.50	3.46
0.83	0.87	0.90	0.93	0.96	0.97	0.98	1.01	1.03	1.05	1.07	1.09	1.11	1.14	1.16			
24.2	29.3	34.4	40.4	47.0	50.5	54.5	64.5	74.6	84.6	96.6	109.6	124.7	142.2	162.2	4.40	15.00	3.47
23.1	28.2	33.3	39.4	45.9	49.5	53.5	63.5	73.6	83.6	95.6	108.6	123.7	141.2	161.2	4.65	16.00	3.49
—	—	—	25.8	32.7	36.4	40.5	50.7	60.9	71.0	83.1	96.2	111.3	128.8	148.9	8.00	28.00	3.53
—	—	—	—	28.5	32.2	36.5	46.8	57.1	67.3	79.4	92.5	107.6	125.2	145.3	9.00	31.50	3.53
—	19.4	24.8	31.1	37.8	41.3	45.4	55.6	65.7	75.7	87.8	100.8	115.9	133.4	153.5	6.70	23.60	3.56
0.87	0.90	0.92	0.95	0.97	0.98	0.99	1.02	1.04	1.06	1.08	1.10	1.12	1.14	1.16			
—	—	—	—	—	—	—	—	35.1	46.2	59.0	72.5	87.9	105.7	125.9	14.00	50.00	3.59
17.0	22.4	27.7	33.9	40.5	44.1	48.1	58.2	68.3	78.3	90.4	103.4	118.5	136.0	156.0	5.90	21.20	3.64
20.1	25.3	30.5	36.6	43.2	46.7	50.8	60.9	70.9	80.9	93.0	106.0	121.0	138.6	158.6	5.20	18.70	3.65
—	—	—	—	—	—	29.3	40.2	50.6	60.9	73.2	86.4	101.5	119.2	139.3	10.30	37.50	3.67
23.3	28.4	33.5	39.6	46.1	49.6	53.7	63.7	73.7	83.8	95.8	108.8	123.8	141.4	161.4	4.40	16.00	3.70
0.86	0.89	0.92	0.94	0.97	0.98	0.99	1.01	1.04	1.06	1.08	1.10	1.12	1.14	1.16			
—	—	—	—	28.8	32.6	36.8	47.2	57.4	67.6	79.8	92.9	108.0	125.6	145.6	8.50	31.50	3.74
—	—	—	26.1	33.0	36.7	40.8	51.1	61.3	71.4	83.5	96.6	111.6	129.2	149.3	7.50	28.00	3.77
—	19.6	25.0	31.3	38.0	41.6	45.7	55.8	65.9	76.0	88.1	101.1	116.2	133.7	153.8	6.30	23.60	3.79
—	—	—	—	—	—	—	—	35.6	46.7	59.5	73.0	88.4	106.3	126.5	13.20	50.00	3.81
20.3	25.5	30.7	36.8	43.4	47.0	51.0	61.1	71.1	81.2	93.2	106.2	121.3	138.8	158.8	4.90	18.70	3.87
0.83	0.87	0.90	0.93	0.96	0.97	0.98	1.01	1.03	1.05	1.07	1.09	1.11	1.14	1.16			

FOR BELT SIZES NOT SHOWN, INTERPOLATE FOR ADDITIONAL CENTER DISTANCE.

V-BELT DRIVES

5V Stock Drive Selection



V-BELT DRIVES

Speed Ratio	Sheave Combination		DriveN Speeds and HP Per Belt												Nominal Center Distance And Arc-Length Correction Factors		
			1750 RPM DriveR			1160 RPM DriveR			870 RPM DriveR			690 RPM DriveR					
	DriveR O.D.	DriveN O.D.	DriveN RPM	HP Per Belt 5V	HP Per Belt 5VX	DriveN RPM	HP Per Belt 5V	HP Per Belt 5VX	DriveN RPM	HP Per Belt 5V	HP Per Belt 5VX	DriveN RPM	HP Per Belt 5V	HP Per Belt 5VX	5V/5VX Belt Length Designation		
															500	600	710
3.88	9.75	37.50	452	27.79	32.99	299	20.40	23.98	224	16.06	18.16	178	13.15	14.76	—	—	—
3.91	5.50	21.20	448	10.83	14.85	297	7.89	10.44	223	6.23	8.12	177	5.14	6.61	—	—	—
3.97	8.00	31.50	440	21.23	25.81	292	15.41	18.18	219	12.10	14.10	174	9.91	11.45	—	—	—
3.99	7.10	28.00	439	17.62	21.96	291	12.75	15.43	218	10.02	11.97	173	8.21	9.73	—	—	—
4.02	12.50	50.00	435	36.72	43.34	288	27.76	31.22	216	22.02	24.36	171	18.09	19.83	—	—	—
ARC-LENGTH CORRECTION FACTOR															0.0	0.0	0.0
4.05	5.90	23.60	432	12.57	16.66	286	9.12	11.71	215	7.19	9.09	170	5.91	7.40	—	—	—
4.09	4.65	18.70	428	7.06	10.95	284	5.23	7.73	213	4.18	6.03	169	3.47	4.93	—	—	15.6
4.09	9.25	37.50	428	25.98	30.98	284	19.00	21.92	213	14.94	17.01	169	12.24	13.82	—	—	—
4.14	5.20	21.20	423	9.52	13.49	280	6.95	9.49	210	5.51	7.39	167	4.55	6.02	—	—	—
4.20	9.00	37.50	416	25.06	29.97	276	18.29	21.18	207	14.38	16.43	164	11.77	13.35	—	—	—
ARC-LENGTH CORRECTION FACTOR															0.0	0.0	0.77
4.21	16.00	67.00	+	+	+	276	36.17	40.53	207	29.14	31.90	164	24.08	26.06	—	—	—
4.23	6.70	28.00	414	15.97	20.22	274	11.56	14.20	206	9.09	11.02	163	7.45	8.96	—	—	—
4.24	7.50	31.50	412	19.24	23.69	273	13.94	16.66	205	10.95	12.92	163	8.97	10.50	—	—	—
4.26	11.80	50.00	410	34.62	40.82	272	25.95	29.27	204	20.54	22.80	162	16.85	18.55	—	—	—
4.33	4.40	18.70	405	5.92	9.79	268	4.43	6.93	201	3.57	5.42	160	2.98	4.43	—	—	15.7
ARC-LENGTH CORRECTION FACTOR															0.0	0.0	0.77
4.35	5.50	23.60	402	10.84	14.86	267	7.89	10.45	200	6.24	8.12	159	5.14	6.61	—	—	—
4.40	4.90	21.20	398	8.18	12.11	264	6.02	8.54	198	4.79	6.65	157	3.97	5.43	—	—	—
4.45	8.50	37.50	393	23.17	27.91	261	16.86	19.68	195	13.25	15.27	155	10.85	12.41	—	—	—
4.46	11.30	50.00	393	33.05	38.97	260	24.63	27.86	195	19.46	21.68	155	15.96	17.63	—	—	—
4.49	7.10	31.50	390	17.62	21.96	259	12.76	15.44	194	10.02	11.97	154	8.22	9.73	—	—	—
ARC-LENGTH CORRECTION FACTOR															0.0	0.0	0.0
4.49	15.00	67.00	+	+	+	258	33.89	37.96	194	27.17	29.79	154	22.40	24.31	—	—	—
4.50	6.30	28.00	389	14.29	18.45	258	10.35	12.96	193	8.15	10.06	153	6.69	8.18	—	—	—
4.61	5.20	23.60	380	9.52	13.49	252	6.96	9.50	189	5.52	7.39	150	4.55	6.02	—	—	—
4.62	10.90	50.00	379	31.75	37.47	251	23.56	26.72	188	18.60	20.78	149	15.24	16.90	—	—	—
4.64	4.65	21.20	377	7.06	10.95	250	5.23	7.74	188	4.18	6.04	149	3.47	4.93	—	—	—
ARC-LENGTH CORRECTION FACTOR															0.0	0.0	0.0
4.73	8.00	37.50	370	21.23	25.82	245	15.41	18.18	184	12.11	14.10	146	9.91	11.46	—	—	—
4.76	6.70	31.50	368	15.97	20.22	244	11.56	14.20	183	9.09	11.02	145	7.45	8.96	—	—	—
4.81	5.90	28.00	364	12.58	16.67	241	9.13	11.71	181	7.20	9.09	143	5.92	7.40	—	—	—
4.81	14.00	67.00	364	40.78	48.45	241	31.51	35.31	181	25.15	27.64	143	20.70	22.53	—	—	—
4.89	10.30	50.00	358	29.73	35.16	237	21.93	24.99	178	17.28	19.42	141	14.16	15.79	—	—	—
ARC-LENGTH CORRECTION FACTOR															0.0	0.0	0.0
4.90	4.90	23.60	357	8.19	12.11	237	6.02	8.54	178	4.79	6.65	141	3.97	5.43	—	—	—
4.91	4.40	21.20	357	5.93	9.79	236	4.44	6.93	177	3.57	5.42	141	2.98	4.43	—	—	—
5.05	7.50	37.50	346	19.25	23.69	230	13.95	16.66	172	10.96	12.92	137	8.97	10.50	—	—	—
5.06	6.30	31.50	346	14.29	18.45	229	10.35	12.96	172	8.15	10.06	136	6.69	8.18	—	—	—
5.11	13.20	67.00	343	38.69	45.78	227	29.54	33.15	170	23.50	25.90	135	19.31	21.09	—	—	—
ARC-LENGTH CORRECTION FACTOR															0.0	0.0	0.0
5.16	4.65	23.60	339	7.06	10.96	225	5.23	7.74	168	4.18	6.04	134	3.47	4.93	—	—	—
5.17	5.50	28.00	339	10.84	14.86	225	7.89	10.45	168	6.24	8.12	134	5.14	6.61	—	—	—
5.17	9.75	50.00	338	27.80	33.00	224	20.41	23.39	168	16.07	18.16	133	13.16	14.76	—	—	—
5.34	7.10	37.50	328	17.63	21.97	217	12.76	15.44	163	10.03	11.97	129	8.22	9.73	—	—	—
5.40	12.50	67.00	324	36.73	43.34	215	27.77	31.23	161	22.03	24.36	128	18.09	19.83	—	—	—
ARC-LENGTH CORRECTION FACTOR															0.0	0.0	0.0
5.41	5.90	31.50	323	12.58	16.67	214	9.13	11.71	161	7.20	9.09	127	5.92	7.40	—	—	—
5.45	9.25	50.00	321	25.99	30.99	213	19.01	21.92	160	14.95	17.01	127	12.24	13.82	—	—	—
5.47	4.40	23.60	320	5.93	9.79	212	4.44	6.93	159	3.57	5.42	126	2.98	4.43	—	—	—
5.47	5.20	28.00	320	9.53	13.49	212	6.96	9.50	159	5.52	7.39	126	4.56	6.02	—	—	—
5.61	9.00	50.00	312	25.07	29.98	207	18.30	21.18	155	14.39	16.44	123	11.78	13.35	—	—	—
ARC-LENGTH CORRECTION FACTOR															0.0	0.0	0.0
5.67	6.70	37.50	309	15.98	20.22	205	11.56	14.21	154	9.09	11.02	122	7.46	8.96	—	—	—
5.72	11.80	67.00	306	34.63	40.83	203	25.96	29.27	152	20.54	22.81	121	16.85	18.55	—	—	—
5.81	4.90	28.00	301	8.19	12.12	200	6.02	8.54	150	4.79	6.65	119	3.97	5.43	—	—	—
5.81	5.50	31.50	301	10.85	14.86	199	7.89	10.45	150	6.24	8.12	119	5.14	6.62	—	—	—
5.94	8.50	50.00	295	23.18	27.92	195	16.87	19.69	146	13.25	15.27	116	10.85	12.41	—	—	—
ARC-LENGTH CORRECTION FACTOR															0.0	0.0	0.0

5V = STANDARD V-BELT
 5VX = COGGED/NOTCHED V-BELT
 + IF RIM SPEED EXCEEDS 6500 FEET PER MINUTE, CONSULT *Martin*.





Stock Drive Selection 5V

Nominal Center Distances And Arc-Length Correction Factor															Sheave Combination		Speed Ratio
5V/5VX Belt Length Designation															DriveR O.D.	DriveN O.D.	
800	900	1000	1120	1250	1320	1400	1600	1800	2000	2240	2500	2800	3150	3550			
—	—	—	—	—	—	29.6	40.5	51.0	61.3	73.6	86.8	101.9	119.6	139.7	9.75	37.50	3.88
17.2	22.7	27.9	34.1	40.8	44.3	48.4	58.5	68.6	78.6	90.7	103.7	118.8	136.3	156.3	5.50	21.20	3.91
—	—	—	—	29.1	32.9	37.1	47.5	57.8	68.0	80.1	93.2	108.3	126.9	146.0	8.00	31.50	3.97
—	—	—	26.4	33.3	37.0	41.1	51.4	61.5	71.7	83.8	96.9	111.9	129.5	149.6	7.10	28.00	3.99
—	—	—	—	—	—	—	—	36.0	47.2	60.0	73.5	88.9	106.8	127.0	12.50	50.00	4.02
0.78	0.84	0.88	0.92	0.95	0.96	0.97	1.00	1.03	1.05	1.07	1.09	1.11	1.13	1.15			
—	19.9	25.3	31.6	38.3	41.9	46.0	56.1	66.2	76.3	88.4	101.4	116.5	134.0	154.1	5.90	23.60	4.05
20.5	25.7	30.9	37.0	43.6	47.1	51.2	61.3	71.3	81.4	93.4	106.4	121.5	139.0	159.0	4.65	18.70	4.09
—	—	—	—	—	—	30.0	40.8	51.3	61.7	73.9	87.1	102.3	120.0	140.1	9.25	37.50	4.09
17.4	22.9	28.1	34.3	41.0	44.5	48.6	58.7	68.8	78.9	90.9	104.0	119.0	136.5	156.6	5.20	21.20	4.14
—	—	—	—	—	—	30.1	41.0	51.5	61.8	74.1	87.3	102.5	120.1	140.3	9.00	37.50	4.20
0.83	0.87	0.90	0.93	0.96	0.97	0.98	1.01	1.03	1.05	1.07	1.09	1.11	1.13	1.16			
—	—	—	—	—	—	—	—	—	—	—	53.8	70.2	88.6	109.3	16.00	67.00	4.21
—	—	19.9	26.6	33.6	37.2	41.4	51.6	61.8	72.0	84.1	97.2	112.2	129.8	149.9	6.70	28.00	4.23
—	—	—	22.1	29.4	33.2	37.4	47.9	58.1	68.3	80.5	93.6	108.7	126.3	146.4	7.50	31.50	4.24
—	—	—	—	—	—	—	—	36.5	47.6	60.4	74.0	89.4	107.3	127.5	11.80	50.00	4.26
20.6	25.9	31.0	37.2	43.8	47.3	51.4	61.4	71.5	81.5	93.6	106.6	121.6	139.2	159.2	4.40	18.70	4.33
0.83	0.87	0.90	0.93	0.95	0.97	0.98	1.01	1.03	1.05	1.07	1.09	1.11	1.13	1.16			
—	20.1	25.5	31.9	38.6	42.2	46.3	56.4	66.5	76.6	88.7	101.7	116.8	134.3	154.4	5.50	23.60	4.35
17.6	23.1	28.3	34.5	41.2	44.8	48.8	58.9	69.0	79.1	91.1	104.2	119.2	136.8	156.8	4.90	21.20	4.40
—	—	—	—	—	25.8	30.4	41.3	51.8	62.2	74.5	87.7	102.8	120.5	140.6	8.50	37.50	4.45
—	—	—	—	—	—	—	—	36.8	48.0	60.8	74.3	89.8	107.6	127.9	11.30	50.00	4.46
—	—	—	22.4	29.7	33.5	37.7	48.1	58.4	68.6	80.8	93.9	109.0	126.6	146.7	7.10	31.50	4.49
0.78	0.84	0.88	0.91	0.94	0.96	0.97	1.00	1.03	1.05	1.07	1.09	1.11	1.13	1.15			
—	—	—	—	—	—	—	—	—	—	—	54.4	70.8	89.3	110.0	15.00	67.00	4.49
—	—	20.1	26.9	33.8	37.5	41.6	51.9	62.1	72.2	84.4	97.5	112.5	130.1	150.2	6.30	28.00	4.50
—	20.3	25.7	32.1	38.8	42.4	46.5	56.6	66.7	76.8	88.9	102.0	117.0	134.6	154.6	5.20	23.60	4.61
—	—	—	—	—	—	—	—	37.0	48.2	61.0	74.6	90.0	107.9	128.2	10.90	50.00	4.62
17.8	23.2	28.5	34.7	41.4	44.9	49.0	59.1	69.2	79.3	91.3	104.4	119.4	136.9	157.0	4.65	21.20	4.64
0.78	0.84	0.88	0.91	0.94	0.96	0.97	1.00	1.02	1.05	1.07	1.09	1.11	1.13	1.15			
—	—	—	—	—	26.1	30.7	41.7	52.2	62.5	74.8	88.0	103.2	120.9	141.0	8.00	37.50	4.73
—	—	—	22.6	29.9	33.7	38.0	48.4	58.7	68.9	81.0	94.2	109.3	126.9	147.0	6.70	31.50	4.76
—	—	20.4	27.1	34.1	37.8	41.9	52.2	62.4	72.5	84.7	97.8	112.8	130.4	150.5	5.90	28.00	4.81
—	—	—	—	—	—	—	—	—	—	—	55.0	71.5	90.0	110.7	14.00	67.00	4.81
—	—	—	—	—	—	—	—	37.4	48.6	61.4	75.0	90.5	108.3	128.6	10.30	50.00	4.89
0.0	0.0	0.77	0.85	0.90	0.92	0.94	0.98	1.01	1.03	1.06	1.08	1.10	1.12	1.15			
—	20.5	25.9	32.3	39.0	42.6	46.7	56.8	67.0	77.0	89.1	102.2	117.2	134.8	154.8	4.90	23.60	4.90
17.9	23.4	28.7	34.9	41.5	45.1	49.2	59.3	69.4	79.4	91.5	104.6	119.6	137.1	157.2	4.40	21.20	4.91
—	—	—	—	—	26.4	31.0	42.0	52.5	62.9	75.2	88.4	103.6	121.2	141.4	7.50	37.50	5.05
—	—	—	22.8	30.2	34.0	38.2	48.7	59.0	69.2	81.3	94.5	109.6	127.2	147.3	6.30	31.50	5.06
—	—	—	—	—	—	—	—	—	—	—	55.5	72.0	90.5	111.3	13.20	67.00	5.11
0.78	0.84	0.88	0.91	0.94	0.96	0.97	1.00	1.02	1.05	1.07	1.09	1.11	1.13	1.15			
—	20.6	26.1	32.4	39.2	42.8	46.9	57.0	67.1	77.2	89.3	102.4	117.4	135.0	155.0	4.65	23.60	5.16
—	—	20.6	27.4	34.3	38.0	42.2	52.5	62.7	72.8	84.9	98.0	113.1	130.7	150.8	5.50	28.00	5.17
—	—	—	—	—	—	—	—	37.7	48.9	61.8	75.4	90.8	108.7	129.0	9.75	50.00	5.17
—	—	—	—	—	26.6	31.3	42.2	52.8	63.1	75.4	88.7	103.9	121.5	141.7	7.10	37.50	5.34
—	—	—	—	—	—	—	—	—	—	—	55.9	72.4	91.0	111.7	12.50	67.00	5.40
0.0	0.80	0.85	0.90	0.93	0.94	0.96	0.99	1.02	1.04	1.06	1.08	1.11	1.13	1.15			
—	—	—	23.1	30.4	34.2	38.5	49.0	59.2	69.4	81.6	94.8	109.9	127.5	147.6	5.90	31.50	5.41
—	—	—	—	—	—	—	—	38.0	49.3	62.1	75.7	91.2	109.1	129.4	9.25	50.00	5.45
—	20.8	26.3	32.6	39.3	42.9	47.0	57.2	67.3	77.4	89.5	102.6	117.6	135.2	155.2	4.40	23.60	5.47
—	—	20.8	27.6	34.5	38.2	42.4	52.7	62.9	73.0	85.2	98.3	113.4	130.9	151.0	5.20	28.00	5.47
—	—	—	—	—	—	—	—	38.2	49.4	62.3	75.9	91.4	109.2	129.5	9.00	50.00	5.61
0.0	0.80	0.85	0.89	0.93	0.94	0.96	0.99	1.02	1.04	1.06	1.08	1.11	1.13	1.15			
—	—	—	—	—	26.9	31.5	42.5	53.1	63.4	75.7	89.0	104.1	121.8	141.9	6.70	37.50	5.67
—	—	—	—	—	—	—	—	—	—	—	56.4	72.9	91.4	112.2	11.80	67.00	5.72
—	—	21.0	27.8	34.7	38.4	42.6	52.9	63.1	73.2	85.4	98.5	113.6	131.2	151.2	4.90	28.00	5.81
—	—	—	23.3	30.7	34.5	38.8	49.2	59.5	69.7	81.9	95.1	110.2	127.8	147.9	5.50	31.50	5.81
—	—	—	—	—	—	—	—	38.5	49.7	62.6	76.2	91.7	109.6	129.9	8.50	50.00	5.94
0.0	0.0	0.77	0.85	0.90	0.92	0.94	0.97	1.00	1.03	1.05	1.08	1.10	1.12	1.15			

FOR BELT SIZES NOT SHOWN, INTERPOLATE FOR ADDITIONAL CENTER DISTANCE.

V-BELT DRIVES

5V Stock Drive Selection



V-BELT DRIVES

Speed Ratio	Sheave Combination		DriveN Speeds and HP Per Belt												Nominal Center Distance And Arc-Length Correction Factors		
			1750 RPM DriveR			1160 RPM DriveR			870 RPM DriveR			690 RPM DriveR					
	DriveR O.D.	DriveN O.D.	DriveN RPM	HP Per Belt 5V	HP Per Belt 5VX	DriveN RPM	HP Per Belt 5V	HP Per Belt 5VX	DriveN RPM	HP Per Belt 5V	HP Per Belt 5VX	DriveN RPM	HP Per Belt 5V	HP Per Belt 5VX	5V/5VX Belt Length Designation		
															500	600	710
5.97	11.30	67.00	293	33.06	38.98	194	24.64	27.86	146	19.47	21.69	116	15.96	17.64	—	—	—
6.03	6.30	37.50	290	14.29	18.46	192	10.35	12.96	144	8.15	10.06	114	6.69	8.18	—	—	—
6.13	4.65	28.00	285	7.07	10.96	189	5.23	7.74	142	4.18	6.04	113	3.48	4.93	—	—	—
6.16	5.20	31.50	284	9.53	13.50	188	6.96	9.50	141	5.52	7.39	112	4.56	6.02	—	—	—
6.19	10.90	67.00	283	31.76	37.47	187	23.57	26.72	140	18.60	20.79	+	15.24	16.90	—	—	—
ARC-LENGTH CORRECTION FACTOR															0.0	0.0	0.0
6.32	8.00	50.00	277	21.24	25.82	184	15.42	18.18	138	12.11	14.10	109	9.92	11.46	—	—	—
6.45	5.90	37.50	271	12.59	16.67	180	9.13	11.71	135	7.20	9.09	107	5.92	7.40	—	—	—
6.49	4.40	28.00	270	5.94	9.79	179	4.44	6.94	134	3.57	5.42	106	2.98	4.43	—	—	—
6.54	4.90	31.50	268	8.19	12.12	177	6.02	8.54	133	4.79	6.65	105	3.97	5.43	—	—	—
6.56	10.30	67.00	267	29.73	35.16	177	21.93	24.99	133	17.29	19.42	105	14.16	15.79	—	—	—
ARC-LENGTH CORRECTION FACTOR															0.0	0.0	0.0
6.74	7.50	50.00	260	19.26	23.70	172	13.95	16.67	129	10.96	12.92	102	8.98	10.50	—	—	—
6.90	4.65	31.50	254	7.07	10.96	168	5.24	7.74	126	4.19	6.04	100	3.48	4.93	—	—	—
6.93	5.50	37.50	253	10.85	14.87	167	7.90	10.45	126	6.24	8.12	100	5.14	6.62	—	—	—
6.93	9.75	67.00	252	27.81	33.00	167	20.41	23.39	125	16.07	18.17	100	13.16	14.76	—	—	—
7.13	7.10	50.00	245	17.63	21.97	163	12.76	15.44	122	10.03	11.98	97	8.22	9.73	—	—	—
ARC-LENGTH CORRECTION FACTOR															0.0	0.0	0.0
7.30	4.40	31.50	240	5.94	9.80	159	4.44	6.94	119	3.57	5.42	94	2.98	4.43	—	—	—
7.31	9.25	67.00	239	26.00	31.00	159	19.01	21.92	119	14.95	17.02	94	12.24	13.83	—	—	—
7.33	5.20	37.50	239	9.53	13.50	158	6.96	9.50	119	5.52	7.39	94	4.56	6.02	—	—	—
7.52	9.00	67.00	233	25.07	29.98	154	18.30	21.18	116	14.39	16.44	92	11.78	13.35	—	—	—
7.56	6.70	50.00	231	15.98	20.23	153	11.56	14.21	115	9.09	11.02	91	7.46	8.96	—	—	—
ARC-LENGTH CORRECTION FACTOR															0.0	0.0	0.0
7.79	4.90	37.50	225	8.20	12.12	149	6.03	8.54	112	4.79	6.66	89	3.97	5.43	—	—	—
7.96	8.50	67.00	220	23.18	27.92	146	16.87	19.69	109	13.26	15.27	87	10.85	12.41	—	—	—
8.05	6.30	50.00	217	14.30	18.46	144	10.35	12.97	108	8.15	10.06	86	6.69	8.18	—	—	—
8.22	4.65	37.50	213	7.07	10.96	141	5.24	7.74	106	4.19	6.04	84	3.48	4.93	—	—	—
8.47	8.00	67.00	207	21.25	25.83	137	15.42	18.19	103	12.11	14.10	81	9.92	11.46	—	—	—
ARC-LENGTH CORRECTION FACTOR															0.0	0.0	0.0
8.60	5.90	50.00	203	12.59	16.67	135	9.13	11.72	101	7.20	9.10	80	5.92	7.40	—	—	—
8.70	4.40	37.50	201	5.94	9.80	133	4.44	6.94	100	3.57	5.42	79	2.98	4.43	—	—	—
9.04	7.50	67.00	194	19.26	23.70	128	13.95	16.67	96	10.96	12.93	76	8.98	10.50	—	—	—
9.24	5.50	50.00	189	10.85	14.87	126	7.90	10.45	94	6.24	8.12	75	5.15	6.62	—	—	—
9.56	7.10	67.00	183	17.64	21.97	121	12.77	15.44	91	10.03	11.98	72	8.22	9.73	—	—	—
ARC-LENGTH CORRECTION FACTOR															0.0	0.0	0.0
9.78	5.20	50.00	179	9.53	13.50	119	6.97	9.50	89	5.52	7.39	71	4.56	6.03	—	—	—
10.14	6.70	67.00	173	15.98	20.23	114	11.57	14.21	86	9.10	11.02	68	7.46	8.96	—	—	—
10.40	4.90	50.00	168	8.20	12.12	112	6.03	8.55	84	4.80	6.66	66	3.97	5.43	—	—	—
10.79	6.30	67.00	162	14.30	18.46	108	10.36	12.97	81	8.15	10.06	64	6.69	8.18	—	—	—
10.97	4.65	50.00	160	7.08	10.96	106	5.24	7.74	79	4.19	6.04	63	3.48	4.93	—	—	—
ARC-LENGTH CORRECTION FACTOR															0.0	0.0	0.0
11.53	5.90	67.00	152	12.59	16.68	101	9.13	11.72	75	7.20	9.10	60	5.92	7.40	—	—	—
11.60	4.40	50.00	151	5.94	9.80	100	4.45	6.94	75	3.58	5.42	59	2.98	4.44	—	—	—
12.39	5.50	67.00	141	10.86	14.87	94	7.90	10.46	70	6.25	8.13	56	5.15	6.62	—	—	—
13.12	5.20	67.00	133	9.54	13.50	88	6.97	9.50	66	5.52	7.39	53	4.56	6.03	—	—	—
13.94	4.90	67.00	126	8.20	12.12	83	6.03	8.55	62	4.80	6.66	50	3.97	5.43	—	—	—
ARC-LENGTH CORRECTION FACTOR															0.0	0.0	0.0
14.70	4.65	67.00	119	7.08	10.97	79	5.24	7.75	59	4.19	6.04	47	3.48	4.93	—	—	—
15.56	4.40	67.00	112	5.94	9.80	75	4.45	6.94	56	3.58	5.42	44	2.98	4.44	—	—	—
ARC-LENGTH CORRECTION FACTOR															0.0	0.0	0.0

5V = STANDARD V-BELT
5VX = COGGED/NOTCHED V-BELT

+ IF RIM SPEED EXCEEDS 6500 FEET PER MINUTE, CONSULT *Martin*.





Stock Drive Selection 5V

Nominal Center Distances And Arc-Length Correction Factor															Sheave Combination		Speed Ratio
5V/5VX Belt Length Designation															DriveR O.D.	DriveN O.D.	
800	900	1000	1120	1250	1320	1400	1600	1800	2000	2240	2500	2800	3150	3550			
—	—	—	—	—	—	—	—	—	—	—	56.7	73.2	91.8	112.6	11.30	67.00	5.97
—	—	—	—	—	27.1	31.8	42.8	53.3	63.7	76.0	89.2	104.4	122.1	142.2	6.30	37.50	6.03
—	—	21.1	27.9	34.9	38.6	42.8	53.1	63.3	73.4	85.6	98.7	113.8	131.3	151.4	4.65	28.00	6.13
—	—	—	23.5	30.9	34.7	39.0	49.4	59.7	69.9	82.1	95.3	110.4	128.0	148.1	5.20	31.50	6.16
—	—	—	—	—	—	—	—	—	—	—	56.9	73.5	92.0	112.8	10.90	67.00	6.19
0.0	0.0	0.77	0.85	0.90	0.92	0.94	0.97	1.00	1.03	1.05	1.08	1.10	1.12	1.15			
—	—	—	—	—	—	—	—	38.8	50.0	62.9	76.6	92.1	109.9	130.3	8.00	50.00	6.32
—	—	—	—	—	27.4	32.0	43.0	53.6	64.0	76.3	89.5	104.7	122.4	142.5	5.90	37.50	6.45
—	—	21.3	28.1	35.1	38.8	42.9	53.2	63.5	73.6	85.7	98.8	113.9	131.5	151.6	4.40	28.00	6.49
—	—	—	23.7	31.1	34.9	39.2	49.6	59.9	70.2	82.3	95.5	110.6	128.2	148.3	4.90	31.50	6.54
—	—	—	—	—	—	—	—	—	—	41.6	57.3	73.8	92.4	113.2	10.30	67.00	6.56
0.0	0.0	0.76	0.84	0.89	0.91	0.93	0.97	1.00	1.03	1.05	1.08	1.10	1.12	1.15			
—	—	—	—	—	—	—	—	39.1	50.4	63.3	76.9	92.4	110.3	130.6	7.50	50.00	6.74
—	—	—	23.8	31.2	35.0	39.3	49.8	60.1	70.3	82.5	95.7	110.8	128.4	148.5	4.65	31.50	6.90
—	—	—	—	—	27.6	32.3	43.3	53.9	64.2	76.6	89.8	105.0	122.7	142.8	5.50	37.50	6.93
—	—	—	—	—	—	—	—	—	—	42.0	57.6	74.2	92.8	113.6	9.75	67.00	6.93
—	—	—	—	—	—	—	—	39.3	50.6	63.5	77.2	92.7	110.6	130.9	7.10	50.00	7.13
0.0	0.0	0.0	0.77	0.86	0.88	0.91	0.96	0.99	1.02	1.04	1.07	1.09	1.12	1.14			
—	—	—	24.0	31.4	35.2	39.5	50.0	60.3	70.5	82.7	95.8	111.0	128.6	148.7	4.40	31.50	7.30
—	—	—	—	—	27.8	32.4	43.5	54.1	64.4	76.8	90.0	105.2	122.9	143.1	5.20	37.50	7.33
—	—	—	—	—	—	—	—	—	—	42.4	58.1	74.7	93.3	114.1	9.00	67.00	7.52
—	—	—	—	—	—	—	—	39.5	50.9	63.8	77.4	92.9	110.9	131.2	6.70	50.00	7.56
0.0	0.0	0.0	0.77	0.86	0.88	0.91	0.96	0.99	1.02	1.04	1.07	1.09	1.12	1.14			
—	—	—	—	23.6	27.9	32.6	43.7	54.3	64.6	77.0	90.2	105.4	123.1	143.3	4.90	37.50	7.79
—	—	—	—	—	—	—	—	—	—	42.7	58.4	75.0	93.6	114.5	8.50	67.00	7.96
—	—	—	—	—	—	—	—	39.8	51.1	64.1	77.7	93.2	111.1	131.5	6.30	50.00	8.05
—	—	—	—	23.7	28.1	32.8	43.8	54.4	64.8	77.1	90.4	105.6	123.3	143.5	4.65	37.50	8.22
—	—	—	—	—	—	—	—	—	—	43.0	58.7	75.3	94.0	114.8	8.00	67.00	8.47
0.0	0.0	0.0	0.0	0.70	0.78	0.84	0.92	0.96	1.00	1.03	1.06	1.08	1.11	1.13			
—	—	—	—	23.8	28.2	32.9	44.0	54.6	65.0	77.3	90.6	105.8	123.5	143.6	4.40	37.50	8.70
—	—	—	—	—	—	—	—	—	—	43.3	59.0	75.6	94.3	115.1	7.50	67.00	9.04
—	—	—	—	—	—	—	—	40.3	51.6	64.6	78.2	93.8	111.7	132.0	5.50	50.00	9.24
—	—	—	—	—	—	—	—	—	—	43.5	59.2	75.9	94.6	115.4	7.10	67.00	9.56
0.0	0.0	0.0	0.0	0.70	0.78	0.84	0.91	0.96	1.00	1.03	1.06	1.08	1.11	1.13			
—	—	—	—	—	—	—	—	40.4	51.8	64.8	78.4	94.0	111.9	132.2	5.20	50.00	9.78
—	—	—	—	—	—	—	—	—	—	43.7	59.5	76.1	94.8	115.7	6.70	67.00	10.14
—	—	—	—	—	—	—	—	40.6	52.0	65.0	78.6	94.2	112.1	132.5	4.90	50.00	10.40
—	—	—	—	—	—	—	—	—	—	44.0	59.7	76.4	95.1	116.0	6.30	67.00	10.79
—	—	—	—	—	—	—	—	40.8	52.1	65.1	78.8	94.4	112.3	132.6	4.65	50.00	10.97
0.0	0.0	0.0	0.0	0.0	0.0	0.0	0.0	0.84	0.92	0.98	1.02	1.05	1.08	1.11			
—	—	—	—	—	—	—	—	—	—	44.2	60.0	76.7	95.4	116.2	5.90	67.00	11.53
—	—	—	—	—	—	—	—	40.9	52.3	65.3	79.0	94.5	112.5	132.8	4.40	50.00	11.60
—	—	—	—	—	—	—	—	—	—	44.4	60.2	76.9	95.6	116.5	5.50	67.00	12.39
—	—	—	—	—	—	—	—	—	—	44.6	60.4	77.1	95.8	116.7	5.20	67.00	13.12
—	—	—	—	—	—	—	—	—	—	44.8	60.6	77.3	96.0	116.9	4.90	67.00	13.94
0.0	0.0	0.0	0.0	0.0	0.0	0.0	0.0	0.84	0.92	0.97	1.02	1.05	1.08	1.11			
—	—	—	—	—	—	—	—	—	—	44.9	60.7	77.5	96.2	117.1	4.65	67.00	14.70
—	—	—	—	—	—	—	—	—	—	45.0	60.9	77.6	96.3	117.2	4.40	67.00	15.56
0.0	0.0	0.0	0.0	0.0	0.0	0.0	0.0	0.0	0.0	0.77	0.91	0.98	1.03	1.08			

FOR BELT SIZES NOT SHOWN, INTERPOLATE FOR ADDITIONAL CENTER DISTANCE.

V-BELT DRIVES

8V Stock Drive Selection



V-BELT DRIVES

Speed Ratio	Sheave Combination		DriveN Speeds and HP Per Belt								Nominal Center Distance And Arc-Length Correction Factors						
			1750 RPM DriveR		1160 RPM DriveR		870 RPM DriveR		690 RPM DriveR								
	DriveR O.D.	DriveN O.D.	DriveN RPM	HP Per Belt 8V	DriveN RPM	HP Per Belt 8V	DriveN RPM	HP Per Belt 8V	DriveN RPM	HP Per Belt 8V	8V Belt Length Designation						
											1000	1180	1320	1400	1600	1800	2000
1.00	12.50	12.50	1750	50.91	1160	42.57	870	35.00	690	29.32	30.4	39.4	46.4	50.4	60.4	70.4	80.4
1.00	13.20	13.20	1750	56.13	1160	47.26	870	38.87	690	32.56	29.3	38.3	45.3	49.3	59.3	69.3	79.3
1.00	14.00	14.00	1750	61.66	1160	52.48	870	43.24	690	36.21	28.0	37.0	44.0	48.0	58.0	68.0	78.0
1.00	15.00	15.00	+	+	1160	58.77	870	48.58	690	40.72	26.4	35.4	42.4	46.4	56.4	66.4	76.4
1.00	16.00	16.00	+	+	1160	64.81	870	53.81	690	45.16	24.9	33.9	40.9	44.9	54.9	64.9	74.9
ARC-LENGTH CORRECTION FACTOR											0.87	0.89	0.91	0.92	0.94	0.95	0.97
1.00	17.00	17.00	+	+	1160	70.58	870	58.90	690	49.53	23.3	32.3	39.3	43.3	53.3	63.3	73.3
1.00	18.00	18.00	+	+	1160	76.06	870	63.87	690	53.82	21.7	30.7	37.7	41.7	51.7	61.7	71.7
1.00	19.00	19.00	+	+	1160	81.25	870	68.70	690	58.04	—	29.2	36.2	40.2	50.2	60.2	70.2
1.00	20.00	20.00	+	+	1160	86.12	870	73.39	690	62.18	—	27.6	34.6	38.6	48.6	58.6	68.6
1.00	21.20	21.20	+	+	1160	91.55	870	78.82	690	67.05	—	25.7	32.7	36.7	46.7	56.7	66.7
ARC-LENGTH CORRECTION FACTOR											0.87	0.89	0.91	0.92	0.94	0.95	0.97
1.00	22.40	22.40	+	+	+	+	870	84.03	690	71.80	—	—	30.8	34.8	44.8	54.8	64.8
1.00	24.80	24.80	+	+	+	+	870	93.77	690	80.92	—	—	—	31.0	41.0	51.0	61.0
1.05	19.00	20.00	+	+	1101	82.51	826	69.65	655	58.80	—	28.4	35.4	39.4	49.4	59.4	69.4
1.06	12.50	13.20	1656	53.14	1098	44.06	823	36.11	653	30.21	29.8	38.8	45.8	49.8	59.8	69.8	79.8
1.06	13.20	14.00	1649	58.37	1093	48.75	820	39.99	650	33.44	28.6	37.6	44.6	48.6	58.6	68.6	78.6
ARC-LENGTH CORRECTION FACTOR											0.86	0.89	0.91	0.91	0.93	0.95	0.97
1.06	16.00	17.00	+	+	1091	66.29	818	54.92	649	46.04	24.1	33.1	40.1	44.1	54.1	64.1	74.1
1.06	17.00	18.00	+	+	1095	72.06	821	60.01	651	50.41	22.5	31.5	38.5	42.5	52.5	62.5	72.5
1.06	18.00	19.00	+	+	1098	77.54	824	64.98	653	54.71	—	29.9	36.9	40.9	50.9	60.9	70.9
1.06	20.00	21.20	+	+	1094	87.60	820	74.50	651	63.07	—	26.6	33.6	37.6	47.6	57.6	67.6
1.06	21.20	22.40	+	+	1097	93.03	823	79.93	653	67.93	—	—	31.8	35.8	45.8	55.8	65.8
ARC-LENGTH CORRECTION FACTOR											0.86	0.89	0.90	0.91	0.93	0.95	0.97
1.07	14.00	15.00	1632	64.21	1082	54.17	811	44.50	643	37.22	27.2	36.2	43.2	47.2	57.2	67.2	77.2
1.07	15.00	16.00	+	+	1087	60.46	815	49.85	646	41.73	25.6	34.6	41.6	45.6	55.6	65.6	75.6
1.11	18.00	20.00	+	+	1043	78.48	782	65.68	620	55.26	—	29.1	36.1	40.1	50.1	60.1	70.1
1.11	22.40	24.80	+	+	+	+	785	85.85	623	73.24	—	—	28.9	32.9	42.9	52.9	62.9
1.12	12.50	14.00	1560	54.80	1034	45.16	775	36.93	615	30.86	29.2	38.2	45.2	49.2	59.2	69.2	79.2
ARC-LENGTH CORRECTION FACTOR											0.86	0.89	0.90	0.91	0.93	0.95	0.97
1.12	17.00	19.00	+	+	1037	73.16	777	60.84	617	51.07	21.7	30.7	37.7	41.7	51.7	61.7	71.7
1.12	19.00	21.20	+	+	1038	83.83	779	70.63	618	59.58	—	27.4	34.4	38.4	48.4	58.4	68.4
1.12	20.00	22.40	+	+	1035	88.70	776	75.32	615	63.72	—	25.7	32.7	36.7	46.7	56.7	66.7
1.13	16.00	18.00	+	+	1030	67.55	772	55.86	612	46.79	23.3	32.3	39.3	43.3	53.3	63.3	73.3
1.14	13.20	15.00	1537	60.48	1019	50.15	764	41.04	606	34.27	27.8	36.8	43.8	47.8	57.8	67.8	77.8
ARC-LENGTH CORRECTION FACTOR											0.86	0.88	0.90	0.91	0.93	0.95	0.96
1.14	14.00	16.00	1528	66.01	1013	55.36	760	45.40	603	37.93	26.4	35.4	42.4	46.4	56.4	66.4	76.4
1.14	15.00	17.00	+	+	1022	61.66	766	50.74	608	42.44	24.8	33.9	40.9	44.9	54.9	64.9	74.9
1.17	21.20	24.80	+	+	990	94.83	743	81.28	589	69.00	—	—	29.8	33.8	43.8	53.8	63.8
1.18	17.00	20.00	+	+	984	73.98	738	61.45	585	51.55	—	29.9	36.9	40.9	50.9	60.9	70.9
1.18	18.00	21.20	+	+	983	79.46	737	66.42	585	55.85	—	28.2	35.2	39.2	49.2	59.2	69.2
ARC-LENGTH CORRECTION FACTOR											0.86	0.88	0.90	0.91	0.93	0.95	0.96
1.18	19.00	22.40	+	+	982	84.65	737	71.25	584	60.07	—	26.4	33.4	37.4	47.4	57.4	67.4
1.19	16.00	19.00	+	+	975	68.33	731	56.44	580	47.25	22.5	31.5	38.5	42.5	52.5	62.5	72.5
1.20	12.50	15.00	1454	56.38	964	46.20	723	37.72	573	31.48	28.4	37.4	44.4	48.4	58.4	68.4	78.4
1.20	15.00	18.00	+	+	964	62.40	723	51.30	574	42.88	24.0	33.0	40.1	44.1	54.1	64.1	74.1
1.21	24.80	30.00	+	+	+	+	718	96.57	570	83.14	—	—	—	—	36.9	46.9	56.9
ARC-LENGTH CORRECTION FACTOR											0.85	0.88	0.90	0.91	0.93	0.95	0.96
1.22	13.20	16.00	1440	61.91	954	51.09	716	41.75	568	34.84	27.0	36.0	43.0	47.0	57.0	67.1	77.1
1.22	14.00	17.00	1438	67.44	953	56.31	715	46.11	567	38.49	25.6	34.6	41.6	45.6	55.6	65.6	75.6
1.24	20.00	24.80	+	+	934	90.14	700	76.40	555	64.57	—	—	30.7	34.7	44.8	54.8	64.8
1.25	16.00	20.00	+	+	926	68.92	694	56.88	551	47.60	21.6	30.7	37.7	41.7	51.7	61.7	71.7
1.25	17.00	21.20	+	+	928	74.68	696	61.98	552	51.97	—	28.9	35.9	39.9	50.0	60.0	70.0
ARC-LENGTH CORRECTION FACTOR											0.85	0.88	0.90	0.91	0.93	0.95	0.96
1.25	18.00	22.40	+	+	930	80.16	698	66.95	553	56.26	—	27.2	34.2	38.2	48.2	58.2	68.2
1.27	15.00	19.00	+	+	913	63.04	685	51.78	543	43.26	23.2	32.2	39.2	43.2	53.2	63.2	73.2
1.28	12.50	16.00	1362	57.46	903	46.92	677	38.25	537	31.91	27.6	36.6	43.6	47.6	57.6	67.6	77.6
1.29	13.20	17.00	1354	62.79	898	51.68	673	42.19	534	35.18	26.2	35.2	42.2	46.2	56.2	66.2	76.2
1.29	14.00	18.00	1357	68.32	899	56.89	674	46.55	535	38.84	24.8	33.8	40.8	44.8	54.8	64.8	74.8
ARC-LENGTH CORRECTION FACTOR											0.85	0.88	0.89	0.90	0.93	0.94	0.96

8V = STANDARD V-BELT

+ IF RIM SPEED EXCEEDS 6500 FEET PER MINUTE, CONSULT *Martin*.



Stock Drive 8V Selection

V-BELT DRIVES

Nominal Center Distances And Arc-Length Correction Factor															Sheave Combination		Speed Ratio
8V Belt Length Designation															DriveR OD	DriveN OD	
2120	2240	2360	2500	2650	2800	3000	3150	3350	3550	3750	4000	4500	5000	5600			
86.4	92.4	98.4	105.4	112.9	120.4	130.4	137.9	147.9	157.9	167.9	180.4	205.4	230.4	260.4	12.50	12.50	1.00
85.3	91.3	97.3	104.3	111.8	119.3	129.3	136.8	146.8	156.8	166.8	179.3	204.3	229.3	259.3	13.20	13.20	1.00
84.0	90.0	96.0	103.0	110.5	118.0	128.0	135.5	145.5	155.5	165.5	178.0	203.0	228.0	258.0	14.00	14.00	1.00
82.4	88.4	94.4	101.4	108.9	116.4	126.4	133.9	143.9	153.9	163.9	176.4	201.4	226.4	256.4	15.00	15.00	1.00
80.9	86.9	92.9	99.9	107.4	114.9	124.9	132.4	142.4	152.4	162.4	174.9	199.9	224.9	254.9	16.00	16.00	1.00
0.98	0.98	0.99	1.00	1.01	1.02	1.03	1.03	1.04	1.05	1.06	1.07	1.09	1.10	1.12			
79.3	85.3	91.3	98.3	105.8	113.3	123.3	130.8	140.8	150.8	160.8	173.3	198.3	223.3	253.3	17.00	17.00	1.00
77.7	83.7	89.7	96.7	104.2	111.7	121.7	129.2	139.2	149.2	159.2	171.7	196.7	221.7	251.7	18.00	18.00	1.00
76.2	82.2	88.2	95.2	102.7	110.2	120.2	127.7	137.7	147.7	157.7	170.2	195.2	220.2	250.2	19.00	19.00	1.00
74.6	80.6	86.6	93.6	101.1	108.6	118.6	126.1	136.1	146.1	156.1	168.6	193.6	218.6	248.6	20.00	20.00	1.00
72.7	78.7	84.7	91.7	99.2	106.7	116.7	124.2	134.2	144.2	154.2	166.7	191.7	216.7	246.7	21.20	21.20	1.00
0.98	0.98	0.99	1.00	1.01	1.02	1.03	1.03	1.04	1.05	1.06	1.07	1.09	1.10	1.12			
70.8	76.8	82.8	89.8	97.3	104.8	114.8	122.3	132.3	142.3	152.3	164.8	189.8	214.8	244.8	22.40	22.40	1.00
67.0	73.0	79.0	86.0	93.5	101.0	111.0	118.5	128.5	138.5	148.5	161.0	186.0	211.0	241.0	24.80	24.80	1.00
75.4	81.4	87.4	94.4	101.9	109.4	119.4	126.9	136.9	146.9	156.9	169.4	194.4	219.4	249.4	19.00	20.00	1.05
85.8	91.8	97.8	104.8	112.3	119.8	129.8	137.3	147.3	157.3	167.3	179.8	204.8	229.8	259.8	12.50	13.20	1.06
84.6	90.6	96.6	103.6	111.1	118.6	128.6	136.1	146.1	156.1	166.1	178.6	203.6	228.6	258.6	13.20	14.00	1.06
0.98	0.98	0.99	1.00	1.01	1.02	1.03	1.03	1.04	1.05	1.06	1.07	1.09	1.10	1.12			
80.1	86.1	92.1	99.1	106.6	114.1	124.1	131.6	141.6	151.6	161.6	174.1	199.1	224.1	254.1	16.00	17.00	1.06
78.5	84.5	90.5	97.5	105.0	112.5	122.5	130.0	140.0	150.0	160.0	172.5	197.5	222.5	252.5	17.00	18.00	1.06
76.9	82.9	88.9	95.9	103.4	110.9	120.9	128.4	138.4	148.4	158.4	170.9	195.9	220.9	250.9	18.00	19.00	1.06
73.6	79.6	85.6	92.6	100.1	107.6	117.6	125.1	135.1	145.1	155.1	167.6	192.6	217.6	247.6	20.00	21.20	1.06
71.8	77.8	83.8	90.8	98.3	105.8	115.8	123.3	133.3	143.3	153.3	165.8	190.8	215.8	245.8	21.20	22.40	1.06
0.97	0.98	0.99	1.00	1.01	1.02	1.03	1.03	1.04	1.05	1.06	1.07	1.09	1.10	1.12			
83.2	89.2	95.2	102.2	109.7	117.2	127.2	134.7	144.7	154.7	164.7	177.2	202.2	227.2	257.2	14.00	15.00	1.07
81.7	87.7	93.7	100.7	108.2	115.7	125.7	133.2	143.2	153.2	163.2	175.7	200.7	225.7	255.7	15.00	16.00	1.07
76.1	82.1	88.1	95.1	102.6	110.1	120.1	127.6	137.6	147.6	157.6	170.1	195.1	220.1	250.1	18.00	20.00	1.11
68.9	74.9	80.9	87.9	95.4	102.9	112.9	120.4	130.4	140.4	150.4	162.9	187.9	212.9	242.9	22.40	24.80	1.11
85.2	91.2	97.2	104.2	111.7	119.2	129.2	136.7	146.7	156.7	166.7	179.2	204.2	229.2	259.2	12.50	14.00	1.12
0.97	0.98	0.99	1.00	1.01	1.02	1.03	1.03	1.04	1.05	1.06	1.07	1.09	1.10	1.12			
77.7	83.7	89.7	96.7	104.2	111.7	121.7	129.2	139.2	149.2	159.2	171.7	196.7	221.7	251.7	17.00	19.00	1.12
74.4	80.4	86.4	93.4	100.9	108.4	118.4	125.9	135.9	145.9	155.9	168.4	193.4	218.4	248.4	19.00	21.20	1.12
72.7	78.7	84.7	91.7	99.2	106.7	116.7	124.2	134.2	144.2	154.2	166.7	191.7	216.7	246.7	20.00	22.40	1.12
79.3	85.3	91.3	98.3	105.8	113.3	123.3	130.8	140.8	150.8	160.8	173.3	198.3	223.3	253.3	16.00	18.00	1.13
83.8	89.8	95.8	102.8	110.3	117.8	127.8	135.3	145.3	155.3	165.3	177.8	202.8	227.8	257.8	13.20	15.00	1.14
0.97	0.98	0.99	1.00	1.01	1.01	1.02	1.03	1.04	1.05	1.06	1.07	1.08	1.10	1.12			
82.4	88.4	94.4	101.4	108.9	116.4	126.4	133.9	143.9	153.9	163.9	176.4	201.4	226.4	256.4	14.00	16.00	1.14
80.9	86.9	92.9	99.9	107.4	114.9	124.9	132.4	142.4	152.4	162.4	174.9	199.9	224.9	254.9	15.00	17.00	1.14
69.8	75.8	81.8	88.8	96.3	103.8	113.8	121.3	131.3	141.3	151.3	163.8	188.8	213.8	243.8	21.20	24.80	1.17
76.9	82.9	88.9	95.9	103.4	110.9	120.9	128.4	138.4	148.4	158.4	170.9	195.9	220.9	250.9	17.00	20.00	1.18
75.2	81.2	87.2	94.2	101.7	109.2	119.2	126.7	136.7	146.7	156.7	169.2	194.2	219.2	249.2	18.00	21.20	1.18
0.97	0.98	0.99	1.00	1.01	1.01	1.02	1.03	1.04	1.05	1.06	1.07	1.08	1.10	1.12			
73.5	79.5	85.5	92.5	100.0	107.5	117.5	125.0	135.0	145.0	155.0	167.5	192.5	217.5	247.5	19.00	22.40	1.18
78.5	84.5	90.5	97.5	105.0	112.5	122.5	130.0	140.0	150.0	160.0	172.5	197.5	222.5	252.5	16.00	19.00	1.19
84.4	90.4	96.4	103.4	110.9	118.4	128.4	135.9	145.9	155.9	165.9	178.4	203.4	228.4	258.4	12.50	15.00	1.20
80.1	86.1	92.1	99.1	106.6	114.1	124.1	131.6	141.6	151.6	161.6	174.1	199.1	224.1	254.1	15.00	18.00	1.20
62.9	68.9	74.9	81.9	89.4	96.9	106.9	114.4	124.4	134.4	144.4	156.9	181.9	206.9	236.9	24.80	30.00	1.21
0.97	0.98	0.99	1.00	1.00	1.01	1.02	1.03	1.04	1.05	1.06	1.07	1.08	1.10	1.12			
83.1	89.1	95.1	102.1	109.6	117.1	127.1	134.6	144.6	154.6	164.6	177.1	202.1	227.1	257.1	13.20	16.00	1.22
81.6	87.6	93.6	100.6	108.1	115.6	125.6	133.1	143.1	153.1	163.1	175.6	200.6	225.6	255.6	14.00	17.00	1.22
70.8	76.8	82.8	89.8	97.3	104.8	114.8	122.3	132.3	142.3	152.3	164.8	189.8	214.8	244.8	20.00	24.80	1.24
77.7	83.7	89.7	96.7	104.2	111.7	121.7	129.2	139.2	149.2	159.2	171.7	196.7	221.7	251.7	16.00	20.00	1.25
76.0	82.0	88.0	95.0	102.5	110.0	120.0	127.5	137.5	147.5	157.5	170.0	195.0	220.0	250.0	17.00	21.20	1.25
0.97	0.98	0.99	1.00	1.01	1.01	1.02	1.03	1.04	1.05	1.06	1.07	1.08	1.10	1.12			
74.2	80.2	86.2	93.2	100.7	108.2	118.2	125.7	135.7	145.7	155.7	168.2	193.2	218.2	248.2	18.00	22.40	1.25
79.3	85.3	91.3	98.3	105.8	113.3	123.3	130.8	140.8	150.8	160.8	173.3	198.3	223.3	253.3	15.00	19.00	1.27
83.6	89.6	95.6	102.6	110.1	117.6	127.6	135.1	145.1	155.1	165.1	177.6	202.6	227.6	257.6	12.50	16.00	1.28
82.3	88.3	94.3	101.3	108.8	116.3	126.3	133.8	143.8	153.8	163.8	176.3	201.3	226.3	256.3	13.20	17.00	1.29
80.8	86.8	92.8	99.8	107.3	114.8	124.8	132.3	142.3	152.3	162.3	174.8	199.8	224.8	254.8	14.00	18.00	1.29
0.97	0.98	0.99	0.99	1.00	1.01	1.02	1.03	1.04	1.05	1.06	1.07	1.08	1.10	1.12			

FOR BELT SIZES NOT SHOWN, INTERPOLATE FOR ADDITIONAL CENTER DISTANCE.

8V Stock Drive Selection



V-BELT DRIVES

Speed Ratio	Sheave Combination		DriveN Speeds and HP Per Belt								Nominal Center Distance And Arc-Length Correction Factors						
			1750 RPM DriveR		1160 RPM DriveR		870 RPM DriveR		690 RPM DriveR		8V Belt Length Designation						
	DriveR O.D.	DriveN O.D.	DriveN RPM	HP Per Belt 8V	DriveN RPM	HP Per Belt 8V	DriveN RPM	HP Per Belt 8V	DriveN RPM	HP Per Belt 8V	1000	1180	1320	1400	1600	1800	2000
1.31	19.00	24.80	+	+	887	85.80	665	72.11	527	60.75	—	—	31.5	35.5	45.5	55.5	65.5
1.32	17.00	22.40	+	+	878	75.19	658	62.36	522	52.27	—	27.9	35.0	39.0	49.0	59.0	69.0
1.33	16.00	21.20	+	+	873	69.49	655	57.31	519	47.94	—	29.7	36.7	40.7	50.7	60.7	70.7
1.34	15.00	20.00	+	+	867	63.51	650	52.13	516	43.54	22.4	31.4	38.4	42.4	52.5	62.5	72.5
1.34	22.40	30.00	+	+	+	+	648	87.58	514	74.61	—	—	—	—	38.7	48.7	58.7
ARC-LENGTH CORRECTION FACTOR											0.84	0.87	0.89	0.90	0.92	0.94	0.96
1.36	14.00	19.00	1285	68.97	851	57.32	639	46.87	506	39.10	24.0	33.0	40.0	44.0	54.0	64.0	74.0
1.37	12.50	17.00	1281	58.29	849	47.47	637	38.67	505	32.24	26.7	35.8	42.8	46.8	56.8	66.8	76.8
1.37	13.20	18.00	1278	63.51	847	52.16	635	42.55	504	35.47	25.4	34.4	41.4	45.4	55.4	65.5	75.5
1.38	18.00	24.80	+	+	839	81.01	630	67.58	499	56.77	—	25.2	32.2	36.2	46.3	56.3	66.3
1.41	16.00	22.40	+	+	826	69.89	619	57.62	491	48.19	—	28.7	35.7	39.7	49.7	59.8	69.8
ARC-LENGTH CORRECTION FACTOR											0.84	0.87	0.89	0.90	0.92	0.94	0.96
1.42	15.00	21.20	+	+	818	63.90	613	52.43	486	43.77	—	30.4	37.4	41.5	51.5	61.5	71.5
1.42	21.20	30.00	+	+	817	96.67	613	82.66	486	70.10	—	—	—	29.5	39.5	49.6	59.6
1.43	14.00	20.00	1220	69.45	808	57.64	606	47.11	481	39.29	23.1	32.2	39.2	43.2	53.2	63.2	73.2
1.43	24.80	35.50	+	+	+	+	606	97.64	481	83.99	—	—	—	—	—	42.3	52.4
1.45	12.50	18.00	1209	58.82	802	47.82	601	38.93	477	32.44	25.9	34.9	42.0	46.0	56.0	66.0	76.0
ARC-LENGTH CORRECTION FACTOR											0.84	0.87	0.89	0.90	0.92	0.94	0.96
1.45	13.20	19.00	1210	64.04	802	52.50	602	42.81	477	35.68	24.5	33.6	40.6	44.6	54.6	64.6	74.7
1.46	17.00	24.80	+	+	792	75.86	594	62.86	471	52.67	—	25.9	32.9	37.0	47.0	57.0	67.1
1.50	15.00	22.40	+	+	773	64.18	580	52.64	460	43.94	—	29.4	36.4	40.5	50.5	60.5	70.5
1.51	20.00	30.00	+	+	771	91.56	578	77.47	458	65.42	—	—	—	30.3	40.4	50.5	60.5
1.52	13.20	20.00	1149	64.38	762	52.73	571	42.98	453	35.81	23.7	32.7	39.8	43.8	53.8	63.8	73.8
ARC-LENGTH CORRECTION FACTOR											0.84	0.87	0.89	0.90	0.92	0.94	0.96
1.52	14.00	21.20	1150	69.91	762	57.95	572	47.34	453	39.47	22.1	31.1	38.2	42.2	52.2	62.3	72.3
1.53	12.50	19.00	1145	59.20	759	48.07	569	39.12	451	32.59	25.0	34.1	41.1	45.1	55.2	65.2	75.2
1.56	16.00	24.80	+	+	745	70.39	559	57.99	443	43.48	—	26.6	33.7	37.7	47.8	57.8	67.8
1.59	19.00	30.00	+	+	732	86.89	549	72.93	435	61.40	—	—	—	31.0	41.1	51.2	61.3
1.59	22.40	35.50	+	+	+	+	547	88.27	434	75.15	—	—	—	—	33.9	44.0	54.1
ARC-LENGTH CORRECTION FACTOR											0.83	0.86	0.88	0.89	0.92	0.94	0.95
1.61	12.50	20.00	1087	59.49	721	48.26	540	39.26	429	32.71	24.2	33.3	40.3	44.3	54.3	64.4	74.4
1.61	14.00	22.40	1088	70.24	721	58.17	541	47.50	429	39.60	—	30.1	37.2	41.2	51.2	61.3	71.3
1.62	13.20	21.20	1083	64.74	718	52.97	539	43.16	427	35.95	22.6	31.7	38.8	42.8	52.8	62.9	72.9
1.62	24.80	40.00	+	+	+	+	538	98.05	426	84.32	—	—	—	—	—	38.4	48.5
1.66	15.00	24.80	+	+	698	64.56	523	52.92	415	44.16	—	27.3	34.4	38.4	48.5	58.5	68.6
ARC-LENGTH CORRECTION FACTOR											0.83	0.86	0.88	0.89	0.92	0.94	0.95
1.67	18.00	30.00	+	+	693	81.86	520	68.22	412	57.27	—	—	27.7	31.7	41.9	52.0	62.0
1.68	21.20	35.50	+	+	690	97.36	518	83.18	410	70.51	—	—	—	—	34.7	44.9	55.0
1.71	12.50	21.20	1025	59.75	679	48.44	510	39.40	404	32.81	23.1	32.2	39.3	43.3	53.4	63.4	73.4
1.71	13.20	22.40	1025	64.98	679	53.13	509	43.27	404	36.05	21.5	30.7	37.8	41.8	51.8	61.9	71.9
1.77	17.00	30.00	+	+	654	76.52	490	63.36	389	53.07	—	—	28.3	32.4	42.6	52.7	62.7
ARC-LENGTH CORRECTION FACTOR											0.82	0.86	0.88	0.89	0.91	0.93	0.95
1.78	14.00	24.80	982	70.65	651	58.44	488	47.71	387	39.76	—	28.0	35.1	39.2	49.2	59.3	69.3
1.78	20.00	35.50	+	+	651	92.08	488	77.86	387	65.73	—	—	—	—	35.6	45.8	55.9
1.79	22.40	40.00	+	+	+	+	485	88.51	385	75.35	—	—	—	—	—	40.0	50.2
1.80	12.50	22.40	970	59.93	643	48.56	482	39.48	382	32.88	22.0	31.2	38.3	42.3	52.4	62.4	72.4
1.80	24.80	44.50	+	+	+	+	483	98.26	383	84.48	—	—	—	—	—	—	44.5
ARC-LENGTH CORRECTION FACTOR											0.81	0.85	0.87	0.89	0.91	0.93	0.95
1.88	19.00	35.50	+	+	618	87.31	463	73.25	367	61.65	—	—	—	—	36.3	46.5	56.6
1.89	13.20	24.80	925	65.29	613	53.34	460	43.43	365	36.17	—	28.6	35.7	39.7	49.8	59.9	69.9
1.89	16.00	30.00	+	+	615	70.89	461	58.36	366	48.78	—	—	29.0	33.1	43.3	53.4	63.5
1.90	21.20	40.00	+	+	612	97.63	459	83.38	364	70.67	—	—	—	—	—	40.9	51.1
1.98	18.00	35.50	+	+	585	82.21	439	68.48	348	57.48	—	—	—	—	36.9	47.2	57.3
ARC-LENGTH CORRECTION FACTOR											0.0	0.84	0.87	0.88	0.91	0.93	0.95
2.00	12.50	24.80	875	60.20	580	48.74	435	39.62	345	32.99	—	29.1	36.2	40.2	50.3	60.4	70.4
2.00	22.40	44.50	+	+	+	+	436	88.66	346	75.46	—	—	—	—	—	—	46.1
2.01	15.00	30.00	+	+	576	64.94	432	53.21	343	44.39	—	—	29.7	33.8	44.0	54.1	64.2
2.01	20.00	40.00	+	+	577	92.29	433	78.01	343	65.85	—	—	—	—	—	41.7	51.9
2.10	17.00	35.50	+	+	552	76.80	414	63.57	328	53.23	—	—	—	—	37.6	47.9	58.0
ARC-LENGTH CORRECTION FACTOR											0.0	0.84	0.86	0.88	0.90	0.93	0.94

8V = STANDARD V-BELT

+ IF RIM SPEED EXCEEDS 6500 FEET PER MINUTE, CONSULT *Martin*.



Stock Drive 8V Selection

V-BELT DRIVES

Nominal Center Distances And Arc-Length Correction Factor															Sheave Combination		Speed Ratio
8V Belt Length Designation															DriveR OD	DriveN OD	
2120	2240	2360	2500	2650	2800	3000	3150	3350	3550	3750	4000	4500	5000	5600			
71.5	77.5	83.5	90.6	98.1	105.6	115.6	123.1	133.1	143.1	153.1	165.6	190.6	215.6	245.6	19.00	24.80	1.31
75.0	81.0	87.0	94.0	101.5	109.0	119.0	126.5	136.5	146.5	156.5	169.0	194.0	219.0	249.0	17.00	22.40	1.32
76.7	82.7	88.7	95.7	103.3	110.8	120.8	128.3	138.3	148.3	158.3	170.8	195.8	220.8	250.8	16.00	21.20	1.33
78.5	84.5	90.5	97.5	105.0	112.5	122.5	130.0	140.0	150.0	160.0	172.5	197.5	222.5	252.5	15.00	20.00	1.34
64.7	70.7	76.8	83.8	91.3	98.8	108.8	116.3	126.3	136.3	146.3	158.8	183.8	208.8	238.8	22.40	30.00	1.34
0.97	0.98	0.98	0.99	1.00	1.01	1.02	1.03	1.04	1.05	1.06	1.06	1.08	1.10	1.11			
80.0	86.0	92.0	99.1	106.6	114.1	124.1	131.6	141.6	151.6	161.6	174.1	199.1	224.1	254.1	14.00	19.00	1.36
82.8	88.8	94.8	101.8	109.3	116.8	126.8	134.3	144.3	154.3	164.3	176.8	201.8	226.8	256.8	12.50	17.00	1.37
81.5	87.5	93.5	100.5	108.0	115.5	125.5	133.0	143.0	153.0	163.0	175.5	200.5	225.5	255.5	13.20	18.00	1.37
72.3	78.3	84.3	91.3	98.8	106.3	116.3	123.8	133.8	143.8	153.8	166.4	191.4	216.4	246.4	18.00	24.80	1.38
75.8	81.8	87.8	94.8	102.3	109.8	119.8	127.3	137.3	147.3	157.3	169.8	194.8	219.8	249.8	16.00	22.40	1.41
0.97	0.98	0.98	0.99	1.00	1.01	1.02	1.03	1.04	1.05	1.06	1.06	1.08	1.10	1.11			
77.5	83.5	89.5	96.5	104.0	111.5	121.5	129.0	139.0	149.0	159.0	171.5	196.5	221.5	251.5	15.00	21.20	1.42
65.6	71.7	77.7	84.7	92.2	99.7	109.7	117.2	127.2	137.2	147.2	159.7	184.7	209.7	239.7	21.20	30.00	1.42
79.2	85.2	91.2	98.3	105.8	113.3	123.3	130.8	140.8	150.8	160.8	173.3	198.3	223.3	253.3	14.00	20.00	1.43
58.4	64.4	70.4	77.5	85.0	92.5	102.5	110.0	120.0	130.0	140.0	152.5	177.6	202.6	232.6	24.80	35.50	1.43
82.0	88.0	94.0	101.0	108.5	116.0	126.0	133.5	143.5	153.5	163.5	176.0	201.0	226.0	256.0	12.50	18.00	1.45
0.97	0.98	0.98	0.99	1.00	1.01	1.02	1.03	1.04	1.05	1.05	1.06	1.08	1.10	1.11			
80.7	86.7	92.7	99.7	107.2	114.7	124.7	132.2	142.2	152.2	162.2	174.7	199.7	224.7	254.7	13.20	19.00	1.45
73.1	79.1	85.1	92.1	99.6	107.1	117.1	124.6	134.6	144.6	154.6	167.1	192.1	217.1	247.1	17.00	24.80	1.46
76.5	82.5	88.5	95.6	103.1	110.6	120.6	128.1	138.1	148.1	158.1	170.6	195.6	220.6	250.6	15.00	22.40	1.50
66.5	72.6	78.6	85.6	93.1	100.6	110.6	118.1	128.1	138.1	148.1	160.7	185.7	210.7	240.7	20.00	30.00	1.51
79.9	85.9	91.9	98.9	106.4	113.9	123.9	131.4	141.4	151.4	161.4	173.9	198.9	223.9	253.9	13.20	20.00	1.52
0.97	0.98	0.98	0.99	1.00	1.01	1.02	1.03	1.04	1.05	1.05	1.06	1.08	1.10	1.11			
78.3	84.3	90.3	97.3	104.8	112.3	122.3	129.8	139.8	149.8	159.8	172.3	197.3	222.3	252.3	14.00	21.20	1.52
81.2	87.2	93.2	100.2	107.7	115.2	125.2	132.7	142.7	152.7	162.7	175.2	200.2	225.2	255.2	12.50	19.00	1.53
73.8	79.8	85.8	92.9	100.4	107.9	117.9	125.4	135.4	145.4	155.4	167.9	192.9	217.9	247.9	16.00	24.80	1.56
67.3	73.3	79.3	86.3	93.9	101.4	111.4	118.9	128.9	138.9	148.9	161.4	186.4	211.4	241.5	19.00	30.00	1.59
60.2	66.2	72.2	79.3	86.8	94.3	104.3	111.8	121.8	131.9	141.9	154.4	179.4	204.4	234.4	22.40	35.50	1.59
0.96	0.97	0.98	0.99	1.00	1.01	1.02	1.03	1.04	1.04	1.05	1.06	1.08	1.10	1.11			
80.4	86.4	92.4	99.4	106.9	114.4	124.4	131.9	141.9	151.9	161.9	174.4	199.4	224.4	254.4	12.50	20.00	1.61
77.3	83.3	89.3	96.3	103.8	111.3	121.3	128.8	138.8	148.8	158.8	171.4	196.4	221.4	251.4	14.00	22.40	1.61
78.9	84.9	90.9	97.9	105.4	112.9	122.9	130.4	140.4	150.4	160.4	172.9	197.9	222.9	252.9	13.20	21.20	1.62
54.6	60.6	66.7	73.7	81.3	88.8	98.8	106.3	116.4	126.4	136.4	148.9	173.9	199.0	229.0	24.80	40.00	1.62
74.6	80.6	86.6	93.6	101.1	108.6	118.6	126.1	136.2	146.2	156.2	168.7	193.7	218.7	248.7	15.00	24.80	1.66
0.96	0.97	0.98	0.99	1.00	1.01	1.02	1.03	1.04	1.04	1.05	1.06	1.08	1.10	1.11			
68.0	74.1	80.1	87.1	94.6	102.1	112.1	119.7	129.7	139.7	149.7	162.2	187.2	212.2	242.2	18.00	30.00	1.67
61.0	67.1	73.1	80.1	87.7	95.2	105.2	112.7	122.8	132.8	142.8	155.3	180.3	205.3	235.4	21.20	35.50	1.68
79.4	85.4	91.4	98.4	105.9	113.4	123.5	131.0	141.0	151.0	161.0	173.5	198.5	223.5	253.5	12.50	21.20	1.71
77.9	83.9	89.9	96.9	104.4	111.9	122.0	129.5	139.5	149.5	159.5	172.0	197.0	222.0	252.0	13.20	22.40	1.71
68.8	74.8	80.8	87.8	95.4	102.9	112.9	120.4	130.4	140.4	150.4	163.0	188.0	213.0	243.0	17.00	30.00	1.77
0.96	0.97	0.98	0.99	1.00	1.01	1.02	1.02	1.03	1.04	1.05	1.06	1.08	1.10	1.11			
75.3	81.3	87.4	94.4	101.9	109.4	119.4	126.9	136.9	146.9	156.9	169.4	194.4	219.4	249.5	14.00	24.80	1.78
61.9	68.0	74.0	81.0	88.6	96.1	106.1	113.6	123.7	133.7	143.7	156.2	181.2	206.3	236.3	20.00	35.50	1.78
56.3	62.4	68.4	75.5	83.0	90.6	100.6	108.1	118.2	128.2	138.2	150.7	175.7	200.8	230.8	22.40	40.00	1.79
78.4	84.4	90.5	97.5	105.0	112.5	122.5	130.0	140.0	150.0	160.0	172.5	197.5	222.5	252.5	12.50	22.40	1.80
50.6	56.7	62.8	69.9	77.4	85.0	95.1	102.6	112.6	122.7	132.7	145.2	170.3	195.3	225.4	24.80	44.50	1.80
0.96	0.97	0.98	0.99	1.00	1.00	1.02	1.02	1.03	1.04	1.05	1.06	1.08	1.09	1.11			
62.7	68.7	74.7	81.8	89.3	96.8	106.9	114.4	124.4	134.4	144.5	157.0	182.0	207.0	237.1	19.00	35.50	1.88
75.9	81.9	88.0	95.0	102.5	110.0	120.0	127.5	137.5	147.5	157.5	170.1	195.1	220.1	250.1	13.20	24.80	1.89
69.5	75.5	81.6	88.6	96.1	103.6	113.7	121.2	131.2	141.2	151.2	163.7	188.7	213.8	243.8	16.00	30.00	1.89
57.2	63.2	69.3	76.4	83.9	91.5	101.5	109.0	119.1	129.1	139.1	151.6	176.7	201.7	231.7	21.20	40.00	1.90
63.4	69.4	75.5	82.5	90.1	97.6	107.6	115.1	125.2	135.2	145.2	157.7	182.8	207.8	237.8	18.00	35.50	1.98
0.96	0.97	0.97	0.98	0.99	1.00	1.01	1.02	1.03	1.04	1.05	1.06	1.08	1.09	1.11			
76.5	82.5	88.5	95.5	103.0	110.5	120.5	128.1	138.1	148.1	158.1	170.6	195.6	220.6	250.6	12.50	24.80	2.00
52.3	58.4	64.5	71.6	79.2	86.8	96.8	104.4	114.4	124.5	134.5	147.0	172.1	197.1	227.2	22.40	44.50	2.00
70.3	76.3	82.3	89.3	96.9	104.4	114.4	121.9	131.9	142.0	152.0	164.5	189.5	214.5	244.5	15.00	30.00	2.01
58.0	64.1	70.2	77.2	84.8	92.3	102.4	109.9	120.0	130.0	140.0	152.5	177.6	202.6	232.7	20.00	40.00	2.01
64.1	70.2	76.2	83.3	90.8	98.3	108.4	115.9	125.9	136.0	146.0	158.5	183.5	208.6	238.6	17.00	35.50	2.10
0.96	0.96	0.97	0.98	0.99	1.00	1.01	1.02	1.03	1.04	1.05	1.06	1.08	1.09	1.11			

FOR BELT SIZES NOT SHOWN, INTERPOLATE FOR ADDITIONAL CENTER DISTANCE.

8V Stock Drive Selection



V-BELT DRIVES

Speed Ratio	Sheave Combination		DriveN Speeds and HP Per Belt								Nominal Center Distance And Arc-Length Correction Factors						
			1750 RPM DriveR		1160 RPM DriveR		870 RPM DriveR		690 RPM DriveR		8V Belt Length Designation						
	DriveR O.D.	DriveN O.D.	DriveN RPM	HP Per Belt 8V	DriveN RPM	HP Per Belt 8V	DriveN RPM	HP Per Belt 8V	DriveN RPM	HP Per Belt 8V	1000	1180	1320	1400	1600	1800	2000
2.11	21.20	44.50	+	+	550	97.77	412	83.49	327	70.75	—	—	—	—	—	36.5	47.0
2.12	19.00	40.00	+	+	548	87.48	411	73.37	326	61.75	—	—	—	—	—	42.4	52.6
2.15	24.80	53.00	+	+	+	+	405	98.46	321	84.64	—	—	—	—	—	—	—
2.16	14.00	30.00	810	71.09	537	58.73	403	47.93	320	39.93	—	—	30.4	34.5	44.7	54.9	64.9
2.23	16.00	35.50	+	+	519	71.10	389	58.52	309	48.90	—	—	—	—	38.3	48.6	58.7
ARC-LENGTH CORRECTION FACTOR											0.0	0.0	0.84	0.85	0.89	0.91	0.93
2.24	18.00	40.00	+	+	519	82.35	389	68.58	309	57.56	—	—	—	—	—	43.0	53.3
2.24	20.00	44.50	+	+	518	92.41	389	78.10	308	65.93	—	—	—	—	—	37.3	47.8
2.29	13.20	30.00	763	65.64	506	53.57	380	43.61	301	36.31	—	—	30.9	35.1	45.3	55.4	65.5
2.36	19.00	44.50	+	+	492	87.58	369	73.45	293	61.81	—	—	—	—	—	38.0	48.4
2.37	17.00	40.00	+	+	490	76.91	367	63.65	291	53.30	—	—	—	—	33.2	43.7	54.0
ARC-LENGTH CORRECTION FACTOR											0.0	0.0	0.83	0.85	0.89	0.91	0.93
2.38	22.40	53.00	+	+	+	+	365	88.79	290	75.57	—	—	—	—	—	—	—
2.39	15.00	35.50	+	+	486	65.11	365	53.34	289	44.49	—	—	—	—	39.0	49.3	59.5
2.42	12.50	30.00	722	60.49	479	48.92	359	39.76	285	33.10	—	—	31.4	35.5	45.8	55.9	66.0
2.49	18.00	44.50	+	+	466	82.43	350	68.64	277	57.61	—	—	—	—	—	38.6	49.1
2.51	21.20	53.00	+	+	461	97.92	346	83.60	274	70.84	—	—	—	—	—	—	—
ARC-LENGTH CORRECTION FACTOR											0.0	0.0	0.83	0.85	0.88	0.91	0.93
2.52	16.00	40.00	+	+	461	71.19	345	58.59	274	48.95	—	—	—	—	33.9	44.4	54.7
2.55	24.80	63.00	+	+	+	+	341	98.56	270	84.72	—	—	—	—	—	—	—
2.56	14.00	35.50	684	71.29	453	58.86	340	48.02	270	40.01	—	—	29.1	39.7	50.0	60.2	—
2.64	17.00	44.50	+	+	440	76.98	330	63.70	262	53.34	—	—	—	—	—	39.3	49.8
2.67	20.00	53.00	+	+	435	92.53	326	78.19	259	66.00	—	—	—	—	—	—	—
ARC-LENGTH CORRECTION FACTOR											0.0	0.0	0.0	0.81	0.86	0.89	0.92
2.69	15.00	40.00	+	+	431	65.18	324	53.39	257	44.54	—	—	—	—	34.5	45.1	55.4
2.72	13.20	35.50	644	65.81	427	53.68	320	43.69	254	36.37	—	—	29.7	40.2	50.5	60.7	—
2.80	16.00	44.50	+	+	414	71.24	310	58.63	246	48.99	—	—	—	—	—	39.9	50.5
2.81	19.00	53.00	+	+	413	87.68	310	73.52	246	61.87	—	—	—	—	—	—	39.8
2.83	22.40	63.00	+	+	+	+	308	88.86	244	75.62	—	—	—	—	—	—	—
ARC-LENGTH CORRECTION FACTOR											0.0	0.0	0.0	0.80	0.86	0.89	0.92
2.87	12.50	35.50	610	60.62	404	49.01	303	39.83	240	33.15	—	—	—	30.1	40.7	51.0	61.2
2.88	14.00	40.00	607	71.37	402	58.92	302	48.07	239	40.05	—	—	—	—	35.2	45.7	56.1
2.88	24.80	71.00	+	+	+	+	302	98.60	240	84.75	—	—	—	—	—	—	—
2.97	18.00	53.00	+	+	391	82.51	293	68.71	233	57.66	—	—	—	—	—	—	40.5
2.99	15.00	44.50	+	+	388	65.23	291	53.42	231	44.56	—	—	—	—	—	40.6	51.1
ARC-LENGTH CORRECTION FACTOR											0.0	0.0	0.0	0.80	0.86	0.89	0.92
2.99	21.20	63.00	+	+	388	98.00	291	83.66	231	70.89	—	—	—	—	—	—	—
3.06	13.20	40.00	572	65.88	379	53.72	284	43.72	225	36.40	—	—	—	—	35.7	46.3	56.6
3.14	17.00	53.00	+	+	369	77.05	277	63.75	220	53.38	—	—	—	—	—	—	41.1
3.17	20.00	63.00	+	+	366	92.59	274	78.24	218	66.03	—	—	—	—	—	—	—
3.19	22.40	71.00	+	+	+	+	273	88.89	216	75.65	—	—	—	—	—	—	—
ARC-LENGTH CORRECTION FACTOR											0.0	0.0	0.0	0.0	0.82	0.87	0.90
3.21	14.00	44.50	545	71.43	361	58.95	271	48.09	215	40.07	—	—	—	—	—	41.2	51.8
3.24	12.50	40.00	541	60.68	358	49.05	269	39.86	213	33.18	—	—	—	—	36.2	46.7	57.1
3.34	16.00	53.00	+	+	347	71.30	260	58.67	206	49.02	—	—	—	—	—	—	41.7
3.34	19.00	63.00	+	+	347	87.73	260	73.56	207	61.90	—	—	—	—	—	—	—
3.37	21.20	71.00	+	+	344	98.04	258	83.69	205	70.91	—	—	—	—	—	—	—
ARC-LENGTH CORRECTION FACTOR											0.0	0.0	0.0	0.0	0.82	0.87	0.90
3.41	13.20	44.50	514	65.92	340	53.76	255	43.74	202	36.42	—	—	—	—	—	41.7	52.3
3.53	18.00	63.00	+	+	329	82.56	247	68.74	196	57.69	—	—	—	—	—	—	—
3.57	15.00	53.00	+	+	325	65.28	244	53.46	193	44.59	—	—	—	—	—	—	42.3
3.58	20.00	71.00	+	+	324	92.63	243	78.26	193	66.05	—	—	—	—	—	—	—
3.60	12.50	44.50	486	60.72	322	49.08	242	39.88	192	33.19	—	—	—	—	—	42.2	52.8
ARC-LENGTH CORRECTION FACTOR											0.0	0.0	0.0	0.0	0.0	0.84	0.88

8V = STANDARD V-BELT

+ IF RIM SPEED EXCEEDS 6500 FEET PER MINUTE, CONSULT *Martin*.



Stock Drive 8V Selection

Nominal Center Distances And Arc-Length Correction Factor															Sheave Combination		Speed Ratio
8V Belt Length Designation															DriveR OD	DriveN OD	
2120	2240	2360	2500	2650	2800	3000	3150	3350	3550	3750	4000	4500	5000	5600			
53.1	59.3	65.4	72.5	80.1	87.6	97.7	105.3	115.3	125.4	135.4	147.9	173.0	198.1	228.1	21.20	44.50	2.11
58.7	64.8	70.9	78.0	85.5	93.1	103.1	110.7	120.7	130.7	140.8	153.3	178.4	203.4	233.4	19.00	40.00	2.12
42.6	48.9	55.1	62.3	70.0	77.6	87.8	95.4	105.5	115.5	125.6	138.2	163.3	188.4	218.4	24.80	53.00	2.15
71.0	77.0	83.1	90.1	97.6	105.1	115.2	122.7	132.7	142.7	152.7	165.2	190.3	215.3	245.3	14.00	30.00	2.16
64.8	70.9	76.9	84.0	91.5	99.1	109.1	116.6	126.7	136.7	146.7	159.3	184.3	209.3	239.4	16.00	35.50	2.23
0.95	0.96	0.97	0.98	0.99	1.00	1.01	1.02	1.03	1.04	1.04	1.06	1.07	1.09	1.11			
59.4	65.5	71.6	78.7	86.2	93.8	103.9	111.4	121.4	131.5	141.5	154.1	179.1	204.2	234.2	18.00	40.00	2.24
54.0	60.1	66.2	73.3	80.9	88.5	98.6	106.1	116.2	126.2	136.3	148.8	173.9	199.0	229.0	20.00	44.50	2.24
71.6	77.6	83.6	90.7	98.2	105.7	115.8	123.3	133.3	143.3	153.3	165.9	190.9	215.9	245.9	13.20	30.00	2.29
54.6	60.8	66.9	74.0	81.6	89.2	99.3	106.9	116.9	127.0	137.0	149.6	174.7	199.7	229.8	19.00	44.50	2.36
60.1	66.2	72.3	79.4	87.0	94.5	104.6	112.1	122.2	132.2	142.3	154.8	179.9	204.9	235.0	17.00	40.00	2.37
0.94	0.96	0.96	0.98	0.99	1.00	1.01	1.02	1.03	1.04	1.04	1.06	1.07	1.09	1.11			
44.1	50.5	56.7	64.0	71.6	79.3	89.5	97.1	107.2	117.3	127.4	139.9	165.1	190.2	220.2	22.40	53.00	2.38
65.5	71.6	77.7	84.7	92.3	99.8	109.9	117.4	127.4	137.5	147.5	160.0	185.1	210.1	240.1	15.00	35.50	2.39
72.1	78.1	84.2	91.2	98.7	106.3	116.3	123.8	133.8	143.9	153.9	166.4	191.4	216.4	246.4	12.50	30.00	2.42
55.3	61.5	67.6	74.7	82.3	89.9	100.0	107.6	117.7	127.7	137.8	150.3	175.4	200.5	230.5	18.00	44.50	2.49
44.9	51.3	57.5	64.8	72.5	80.1	90.3	97.9	108.1	118.2	128.2	140.8	166.0	191.1	221.2	21.20	53.00	2.51
0.94	0.95	0.96	0.97	0.98	0.99	1.01	1.01	1.02	1.03	1.04	1.05	1.07	1.09	1.11			
60.8	66.9	73.0	80.1	87.7	95.3	105.3	112.9	122.9	133.0	143.0	155.6	180.6	205.7	235.7	16.00	40.00	2.52
—	—	—	52.6	60.5	68.4	78.7	86.4	96.7	106.8	117.0	129.6	154.9	180.0	210.2	24.80	63.00	2.55
66.3	72.3	78.4	85.4	93.0	100.5	110.6	118.1	128.2	138.2	148.2	160.8	185.8	210.8	240.9	14.00	35.50	2.56
56.0	62.2	68.3	75.4	83.1	90.7	100.8	108.3	118.4	128.5	138.5	151.1	176.2	201.2	231.3	17.00	44.50	2.64
45.7	52.1	58.3	65.6	73.3	81.0	91.2	98.8	108.9	119.0	129.1	141.7	166.9	192.0	222.1	20.00	53.00	2.67
0.93	0.94	0.95	0.97	0.98	0.99	1.00	1.01	1.02	1.03	1.04	1.05	1.07	1.09	1.10			
61.5	67.6	73.7	80.8	88.4	96.0	106.1	113.6	123.7	133.7	143.8	156.3	181.4	206.4	236.5	15.00	40.00	2.69
66.8	72.9	79.0	86.0	93.6	101.1	111.2	118.7	128.8	138.8	148.8	161.4	186.4	211.5	241.5	13.20	35.50	2.72
56.7	62.9	69.0	76.2	83.8	91.4	101.5	109.1	119.1	129.2	139.3	151.8	176.9	202.0	232.0	16.00	44.50	2.80
46.3	52.7	59.0	66.3	74.0	81.7	91.9	99.5	109.6	119.7	129.8	142.4	167.6	192.7	222.8	19.00	53.00	2.81
—	—	46.5	54.1	62.1	70.0	80.4	88.1	98.3	108.5	118.7	131.4	156.6	181.8	212.0	22.40	63.00	2.83
0.93	0.94	0.95	0.96	0.98	0.99	1.00	1.01	1.02	1.03	1.04	1.05	1.07	1.09	1.10			
67.3	73.4	79.5	86.5	94.1	101.7	111.7	119.2	129.3	139.3	149.4	161.9	186.9	212.0	242.0	12.50	35.50	2.87
62.2	68.4	74.5	81.6	89.1	96.7	106.8	114.3	124.4	134.5	144.5	157.1	182.1	207.2	237.2	14.00	40.00	2.88
—	—	—	52.1	60.3	68.3	78.9	89.3	99.6	109.8	120.0	132.6	157.8	182.9	213.0	24.80	71.00	2.88
47.0	53.4	59.7	66.9	74.7	82.4	92.6	100.2	110.3	120.5	130.6	143.2	168.3	193.4	223.6	18.00	53.00	2.97
57.4	63.6	69.7	76.9	84.5	92.1	102.2	109.8	119.9	129.9	140.0	152.6	177.7	202.7	232.8	15.00	44.50	2.99
0.93	0.94	0.95	0.96	0.97	0.99	1.00	1.01	1.02	1.03	1.04	1.05	1.07	1.09	1.10			
—	—	47.2	54.9	62.9	70.8	81.2	88.9	99.2	109.4	119.5	132.2	157.5	182.7	212.8	21.20	63.00	2.99
62.8	68.9	75.0	82.1	89.7	97.3	107.4	114.9	125.0	135.1	145.1	157.6	182.7	207.8	237.8	13.20	40.00	3.06
47.6	54.0	60.3	67.6	75.4	83.1	93.3	100.9	111.1	121.2	131.3	143.9	169.1	194.2	224.3	17.00	53.00	3.14
—	—	48.0	55.7	63.7	71.6	82.0	89.7	100.0	110.2	120.4	133.1	158.4	183.6	213.7	20.00	63.00	3.17
—	—	—	53.6	61.9	72.6	80.5	90.9	101.2	111.5	124.3	149.7	175.0	205.2	224.0	22.40	71.00	3.19
0.92	0.93	0.94	0.95	0.97	0.98	0.99	1.00	1.01	1.02	1.03	1.04	1.06	1.08	1.10			
58.1	64.2	70.4	77.6	85.2	92.8	102.9	110.5	120.6	130.7	140.7	153.3	178.4	203.5	233.6	14.00	44.50	3.21
63.3	69.4	75.5	82.6	90.2	97.8	107.9	115.4	125.5	135.6	145.6	158.2	183.3	208.3	238.4	12.50	40.00	3.24
48.3	54.7	61.0	68.3	76.1	83.8	94.0	101.6	111.8	121.9	132.0	144.6	169.8	194.9	225.0	16.00	53.00	3.34
—	—	48.6	56.3	64.3	72.2	82.7	90.4	100.7	110.9	121.1	133.8	159.1	184.3	214.5	19.00	63.00	3.34
—	—	—	54.4	62.6	73.4	81.3	91.7	102.0	112.3	125.1	150.5	175.8	206.1	212.0	21.20	71.00	3.37
0.91	0.93	0.94	0.95	0.97	0.98	0.99	1.00	1.01	1.02	1.03	1.04	1.06	1.08	1.10			
58.6	64.8	71.0	78.1	85.8	93.4	103.5	111.1	121.2	131.2	141.3	153.9	179.0	204.1	234.2	13.20	44.50	3.41
—	—	49.2	56.9	65.0	72.9	83.3	91.1	101.4	111.6	121.8	134.5	159.8	185.0	215.2	18.00	63.00	3.53
48.9	55.3	61.7	69.0	76.7	84.5	94.7	102.3	112.5	122.6	132.7	145.4	170.5	195.7	225.8	15.00	53.00	3.57
—	—	—	55.1	63.4	74.1	82.1	92.5	102.9	113.2	125.9	151.4	176.7	207.0	207.0	20.00	71.00	3.58
59.1	65.3	71.4	78.6	86.2	93.9	104.0	111.6	121.7	131.8	141.8	154.4	179.5	204.6	234.7	12.50	44.50	3.60
0.90	0.91	0.93	0.94	0.96	0.97	0.98	0.99	1.01	1.02	1.03	1.04	1.06	1.08	1.10			

FOR BELT SIZES NOT SHOWN, INTERPOLATE FOR ADDITIONAL CENTER DISTANCE.

V-BELT DRIVES

8V Stock Drive Selection



V-BELT DRIVES

Speed Ratio	Sheave Combination		DriveN Speeds and HP Per Belt								Nominal Center Distance And Arc-Length Correction Factors							
			1750 RPM DriveR		1160 RPM DriveR		870 RPM DriveR		690 RPM DriveR		8V Belt Length Designation							
	DriveR O.D.	DriveN O.D.	DriveN RPM	HP Per Belt 8V	DriveN RPM	HP Per Belt 8V	DriveN RPM	HP Per Belt 8V	DriveN RPM	HP Per Belt 8V	1000	1180	1320	1400	1600	1800	2000	
3.74	17.00	63.00	—	—	310	77.09	233	63.79	185	53.40	—	—	—	—	—	—	—	
3.77	19.00	71.00	—	—	308	87.76	231	73.58	183	61.92	—	—	—	—	—	—	—	
3.83	14.00	53.00	457	71.49	303	58.99	227	48.12	180	40.09	—	—	—	—	—	—	43.0	
3.85	24.80	95.00	—	—	—	—	226	98.66	179	84.80	—	—	—	—	—	—	—	
3.97	16.00	63.00	—	—	292	71.33	219	58.70	174	49.04	—	—	—	—	—	—	—	
ARC-LENGTH CORRECTION FACTOR											0.0	0.0	0.0	0.0	0.0	0.0	0.0	0.82
3.98	18.00	71.00	—	—	292	82.58	219	68.76	173	57.70	—	—	—	—	—	—	—	
4.06	13.20	53.00	431	65.97	286	53.79	214	43.77	170	36.44	—	—	—	—	—	—	43.4	
4.21	17.00	71.00	—	—	275	77.11	206	63.80	164	53.41	—	—	—	—	—	—	—	
4.24	15.00	63.00	—	—	273	65.31	205	53.48	163	44.61	—	—	—	—	—	—	—	
4.27	22.40	95.00	—	—	—	—	204	88.93	162	75.68	—	—	—	—	—	—	—	
ARC-LENGTH CORRECTION FACTOR											0.0	0.0	0.0	0.0	0.0	0.0	0.0	0.82
4.29	12.50	53.00	408	60.76	270	49.11	203	39.90	161	33.21	—	—	—	—	—	—	43.9	
4.48	16.00	71.00	—	—	259	71.35	194	58.71	154	49.05	—	—	—	—	—	—	—	
4.51	21.20	95.00	—	—	257	98.09	193	83.72	153	70.94	—	—	—	—	—	—	—	
4.55	14.00	63.00	385	71.53	255	59.02	191	48.14	152	40.11	—	—	—	—	—	—	—	
4.78	15.00	71.00	—	—	242	65.32	182	53.49	144	44.62	—	—	—	—	—	—	—	
ARC-LENGTH CORRECTION FACTOR											0.0	0.0	0.0	0.0	0.0	0.0	0.0	0.81
4.79	20.00	95.00	+	+	242	92.67	182	78.30	144	66.08	—	—	—	—	—	—	—	
4.83	13.20	63.00	362	66.01	240	53.81	180	43.79	143	36.45	—	—	—	—	—	—	—	
5.04	19.00	95.00	+	+	230	87.80	173	73.61	137	61.94	—	—	—	—	—	—	—	
5.11	12.50	63.00	343	60.79	227	49.13	170	39.91	135	33.22	—	—	—	—	—	—	—	
5.13	14.00	71.00	341	71.54	226	59.03	170	48.15	134	40.11	—	—	—	—	—	—	—	
ARC-LENGTH CORRECTION FACTOR											0.0	0.0	0.0	0.0	0.0	0.0	0.0	0.0
5.33	18.00	95.00	+	+	218	82.62	163	68.79	130	57.72	—	—	—	—	—	—	—	
5.45	13.20	71.00	321	66.02	213	53.82	160	43.79	127	36.46	—	—	—	—	—	—	—	
5.64	17.00	95.00	+	+	206	77.14	154	63.82	122	53.43	—	—	—	—	—	—	—	
5.76	12.50	71.00	304	60.81	202	49.14	151	39.92	120	33.23	—	—	—	—	—	—	—	
6.00	16.00	95.00	+	+	193	71.38	145	58.73	115	49.07	—	—	—	—	—	—	—	
ARC-LENGTH CORRECTION FACTOR											0.0	0.0	0.0	0.0	0.0	0.0	0.0	0.0
6.41	15.00	95.00	+	+	181	65.34	136	53.51	108	44.63	—	—	—	—	—	—	—	
6.87	14.00	95.00	255	71.57	169	59.05	127	48.17	100	40.12	—	—	—	—	—	—	—	
7.29	13.20	95.00	240	66.05	159	53.84	119	43.81	95	36.47	—	—	—	—	—	—	—	
7.71	12.50	95.00	227	60.83	151	49.15	113	39.93	90	33.24	—	—	—	—	—	—	—	
ARC-LENGTH CORRECTION FACTOR											0.0	0.0	0.0	0.0	0.0	0.0	0.0	0.0

8V = STANDARD V-BELT

+ IF RIM SPEED EXCEEDS 6500 FEET PER MINUTE, CONSULT *Martin*.



Stock Drive 8V Selection

Nominal Center Distances And Arc-Length Correction Factor															Sheave Combination		Speed Ratio
8V Belt Length Designation															DriveR OD	DriveN OD	
2120	2240	2360	2500	2650	2800	3000	3150	3350	3550	3750	4000	4500	5000	5600			
—	—	49.9	57.6	65.6	73.6	84.0	91.8	102.1	112.3	122.5	135.2	160.5	185.7	215.9	17.00	63.00	3.74
—	—	—	—	55.8	64.0	74.8	82.7	93.2	103.6	113.8	126.6	152.1	177.4	207.7	19.00	71.00	3.77
49.5	56.0	62.3	69.6	77.4	85.1	95.4	103.0	113.2	123.3	133.5	146.1	171.3	196.4	226.5	14.00	53.00	3.83
—	—	—	—	—	—	—	—	—	75.2	86.3	99.7	126.0	151.9	182.5	24.80	95.00	3.85
—	43.6	50.5	58.2	66.3	74.2	84.7	92.5	102.8	113.0	123.2	135.9	161.2	186.5	216.7	16.00	63.00	3.97
0.85	0.88	0.90	0.92	0.93	0.95	0.97	0.98	0.99	1.00	1.02	1.03	1.05	1.07	1.09			
—	—	—	—	56.4	64.7	75.4	83.4	93.9	104.2	114.5	127.3	152.8	178.1	208.4	18.00	71.00	3.98
50.1	56.5	62.9	70.2	78.0	85.7	95.9	103.6	113.8	123.9	134.0	146.7	171.9	197.0	227.1	13.20	53.00	4.06
—	—	—	48.3	57.0	65.3	76.1	84.0	94.5	104.9	115.2	128.0	153.5	178.8	209.1	17.00	71.00	4.21
—	44.2	51.1	58.8	66.9	74.9	85.4	93.1	103.5	113.7	123.9	136.6	162.0	187.2	217.4	15.00	63.00	4.24
—	—	—	—	—	—	—	—	65.2	76.7	87.8	101.3	127.6	153.5	184.2	22.40	95.00	4.27
0.85	0.87	0.89	0.91	0.93	0.95	0.97	0.98	0.99	1.00	1.02	1.03	1.05	1.07	1.09			
50.5	57.0	63.3	70.7	78.4	86.2	96.4	104.1	114.3	124.4	134.5	147.2	172.4	197.5	227.7	12.50	53.00	4.29
—	—	—	48.9	57.6	65.9	76.7	84.7	95.2	105.6	115.9	128.7	154.2	179.6	209.9	16.00	71.00	4.48
—	—	—	—	—	—	—	—	65.9	77.4	88.5	102.1	128.4	154.3	185.1	21.20	95.00	4.51
—	44.8	51.7	59.5	67.6	75.6	86.0	93.8	104.1	114.4	124.6	137.3	162.7	187.9	218.1	14.00	63.00	4.55
—	—	—	49.5	58.2	66.6	77.4	85.4	95.9	106.3	116.6	129.4	154.9	180.3	210.6	15.00	71.00	4.78
0.85	0.87	0.89	0.91	0.93	0.95	0.96	0.98	0.99	1.00	1.01	1.03	1.05	1.07	1.09			
—	—	—	—	—	—	—	—	66.6	78.2	89.3	102.8	129.2	155.1	185.9	20.00	95.00	4.79
—	45.3	52.2	60.0	68.1	76.1	86.6	94.4	104.7	115.0	125.2	137.9	163.3	188.5	218.7	13.20	63.00	4.83
—	—	—	—	—	—	—	—	67.2	78.8	89.9	103.5	129.9	155.8	186.6	19.00	95.00	5.04
—	45.7	52.6	60.4	68.6	76.5	87.0	94.8	105.2	115.4	125.7	138.4	163.8	189.0	219.2	12.50	63.00	5.11
—	—	—	50.1	58.8	67.2	78.0	86.0	96.5	106.9	117.3	130.1	155.6	181.0	211.3	14.00	71.00	5.13
0.0	0.78	0.83	0.86	0.89	0.91	0.94	0.95	0.97	0.99	1.00	1.01	1.04	1.06	1.08			
—	—	—	—	—	—	—	—	67.8	79.4	90.6	104.1	130.6	156.5	187.3	18.00	95.00	5.33
—	—	—	50.6	59.3	67.7	78.6	86.5	97.1	107.5	117.8	130.7	156.2	181.6	211.9	13.20	71.00	5.45
—	—	—	—	—	—	—	—	68.4	80.0	91.2	104.8	131.2	157.2	188.0	17.00	95.00	5.64
—	—	—	51.0	59.8	68.1	79.0	87.0	97.5	108.0	118.3	131.2	156.7	182.1	212.4	12.50	71.00	5.76
—	—	—	—	—	—	—	—	69.0	80.6	91.8	105.4	131.9	157.9	188.7	16.00	95.00	6.00
0.0	0.0	0.0	0.78	0.84	0.87	0.91	0.93	0.95	0.97	0.98	1.00	1.03	1.05	1.08			
—	—	—	—	—	—	—	—	69.6	81.3	92.5	106.1	132.6	158.6	189.4	15.00	95.00	6.41
—	—	—	—	—	—	—	—	70.2	81.9	93.1	106.7	133.2	159.2	190.1	14.00	95.00	6.87
—	—	—	—	—	—	—	—	70.7	82.4	93.6	107.2	133.8	159.8	190.6	13.20	95.00	7.29
—	—	—	—	—	—	—	58.5	71.1	82.8	94.0	107.7	134.2	160.3	191.1	12.50	95.00	7.71
0.0	0.0	0.0	0.0	0.0	0.0	0.0	0.72	0.81	0.87	0.90	0.94	0.98	1.02	1.05			

FOR BELT SIZES NOT SHOWN, INTERPOLATE FOR ADDITIONAL CENTER DISTANCE.

V-BELT DRIVES

A Stock Drive Selection



V-BELT DRIVES

Speed Ratio	Sheave Combination		DriveN Speeds and HP Per Belt									Nominal Center Distance And Arc-Length Correction Factor						
			3500 RPM DriveR			1750 RPM DriveR			1160 RPM DriveR									
	DriveR P.D.	DriveN P.D.	DriveN RPM	HP Per Belt A	HP Per Belt AX	DriveN RPM	HP Per Belt A	HP Per Belt AX	DriveN RPM	HP Per Belt A	HP Per Belt AX	A/AX Belt Length Designation						
												26	31	35	38	42	46	51
1.00	3.0	3.0	3500	2.24	3.17	1750	1.67	2.10	1160	1.29	1.57	8.9	11.4	13.4	14.9	16.9	18.9	21.4
1.00	3.2	3.2	3500	2.87	3.82	1750	2.04	2.47	1160	1.55	1.83	8.6	11.1	13.1	14.6	16.6	18.6	21.1
1.00	3.4	3.4	3500	3.48	4.45	1750	2.41	2.84	1160	1.81	2.09	8.3	10.8	12.8	14.3	16.3	18.3	20.8
1.00	3.6	3.6	3500	4.08	5.07	1750	2.77	3.21	1160	2.06	2.34	8.0	10.5	12.5	14.0	16.0	18.0	20.5
1.00	3.8	3.8	3500	4.66	5.68	1750	3.13	3.57	1160	2.32	2.60	7.7	10.2	12.2	13.7	15.7	17.7	20.2
ARC-LENGTH CORRECTION FACTOR												0.75	0.79	0.82	0.85	0.87	0.90	0.92
1.00	4.0	4.0	3500	5.22	6.27	1750	3.48	3.92	1160	2.57	2.85	7.4	9.9	11.9	13.4	15.4	17.4	19.9
1.00	4.2	4.2	3500	5.77	6.86	1750	3.83	4.28	1160	2.82	3.10	7.1	9.6	11.6	13.1	15.1	17.1	19.6
1.00	4.4	4.4	3500	6.30	7.43	1750	4.18	4.63	1160	3.06	3.35	6.7	9.2	11.2	12.7	14.7	16.7	19.2
1.00	4.6	4.6	3500	6.82	7.98	1750	4.52	4.98	1160	3.31	3.60	6.4	8.9	10.9	12.4	14.4	16.4	18.9
1.00	4.8	4.8	3500	7.32	8.52	1750	4.86	5.33	1160	3.55	3.84	—	8.6	10.6	12.1	14.1	16.1	18.6
ARC-LENGTH CORRECTION FACTOR												0.75	0.79	0.82	0.85	0.87	0.90	0.92
1.00	5.0	5.0	3500	7.80	9.05	1750	5.20	5.67	1160	3.80	4.09	—	8.3	10.3	11.8	13.8	15.8	18.3
1.00	5.2	5.2	3500	8.26	9.56	1750	5.53	6.01	1160	4.04	4.33	—	8.0	10.0	11.5	13.5	15.5	18.0
1.00	5.4	5.4	3500	8.71	10.06	1750	5.86	6.34	1160	4.28	4.57	—	7.7	9.7	11.2	13.2	15.2	17.7
1.00	5.6	5.6	3500	9.13	10.54	1750	6.18	6.68	1160	4.51	4.81	—	7.4	9.4	10.9	12.9	14.9	17.4
1.00	5.8	5.8	3500	9.54	11.01	1750	6.51	7.01	1160	4.75	5.05	—	—	9.0	10.5	12.5	14.5	17.0
ARC-LENGTH CORRECTION FACTOR												0.0	0.79	0.82	0.85	0.87	0.90	0.92
1.00	6.0	6.0	3500	9.92	11.46	1750	6.83	7.34	1160	4.99	5.29	—	—	8.7	10.2	12.2	14.2	16.7
1.00	6.2	6.2	3500	10.29	11.89	1750	7.14	7.66	1160	5.22	5.52	—	—	8.4	9.9	11.9	13.9	16.4
1.00	6.4	6.4	3500	10.63	12.31	1750	7.45	7.98	1160	5.45	5.76	—	—	8.1	9.6	11.6	13.6	16.1
1.00	6.6	6.6	3500	10.95	12.71	1750	7.76	8.30	1160	5.68	5.99	—	—	—	9.3	11.3	13.3	15.8
1.00	7.0	7.0	3500	11.53	13.46	1750	8.36	8.93	1160	6.13	6.45	—	—	—	8.7	10.7	12.7	15.2
ARC-LENGTH CORRECTION FACTOR												0.0	0.0	0.82	0.85	0.87	0.90	0.92
1.03	5.8	6.0	3383	9.67	11.12	1692	6.57	7.07	1121	4.79	5.09	—	—	8.9	10.4	12.4	14.4	16.9
1.03	6.0	6.2	3387	10.05	11.58	1694	6.89	7.39	1123	5.03	5.33	—	—	8.6	10.1	12.1	14.1	16.6
1.03	6.2	6.4	3391	10.42	12.01	1695	7.20	7.72	1124	5.26	5.56	—	—	8.3	9.8	11.8	13.8	16.3
1.03	6.4	6.6	3394	10.76	12.43	1697	7.52	8.04	1125	5.49	5.80	—	—	—	9.4	11.4	13.4	15.9
1.04	4.6	4.8	3354	6.99	8.13	1677	4.60	5.05	1112	3.37	3.65	6.3	8.8	10.8	12.3	14.3	16.3	18.8
ARC-LENGTH CORRECTION FACTOR												0.74	0.79	0.82	0.84	0.87	0.89	0.92
1.04	4.8	5.0	3360	7.49	8.67	1680	4.94	5.40	1114	3.61	3.89	—	8.5	10.5	12.0	14.0	16.0	18.5
1.04	5.0	5.2	3365	7.97	9.20	1683	5.28	5.74	1115	3.85	4.14	—	8.1	10.1	11.6	13.6	15.6	18.1
1.04	5.2	5.4	3370	8.43	9.71	1685	5.61	6.08	1117	4.09	4.38	—	7.8	9.8	11.3	13.3	15.3	17.8
1.04	5.4	5.6	3375	8.87	10.21	1687	5.94	6.42	1119	4.33	4.62	—	7.5	9.5	11.0	13.0	15.0	17.5
1.04	5.6	5.8	3379	9.30	10.69	1690	6.27	6.75	1120	4.57	4.86	—	—	9.2	10.7	12.7	14.7	17.2
ARC-LENGTH CORRECTION FACTOR												0.0	0.79	0.82	0.84	0.87	0.89	0.92
1.05	3.8	4.0	3325	4.86	5.86	1662	3.23	3.66	1102	2.38	2.66	7.5	10.0	12.0	13.5	15.5	17.5	20.0
1.05	4.0	4.2	3333	5.42	6.46	1667	3.58	4.02	1105	2.63	2.91	7.2	9.7	11.7	13.2	15.2	17.2	19.7
1.05	4.2	4.4	3341	5.97	7.04	1670	3.93	4.37	1107	2.88	3.16	6.9	9.4	11.4	12.9	14.9	16.9	19.4
1.05	4.4	4.6	3348	6.51	7.61	1674	4.28	4.72	1110	3.13	3.41	6.6	9.1	11.1	12.6	14.6	16.6	19.1
1.06	3.2	3.4	3294	3.10	4.03	1647	2.16	2.58	1092	1.63	1.90	8.5	11.0	13.0	14.5	16.5	18.5	21.0
ARC-LENGTH CORRECTION FACTOR												0.74	0.79	0.82	0.84	0.87	0.89	0.92
1.06	3.4	3.6	3306	3.71	4.66	1653	2.52	2.95	1096	1.89	2.16	8.2	10.7	12.7	14.2	16.2	18.2	20.7
1.06	3.6	3.8	3316	4.31	5.29	1658	2.89	3.31	1099	2.14	2.41	7.8	10.3	12.3	13.8	15.8	17.8	20.3
1.06	6.2	6.6	3288	10.52	12.11	1644	7.26	7.77	1090	5.30	5.59	—	—	8.1	9.6	11.6	13.6	16.1
1.06	6.6	7.0	3300	11.19	12.93	1650	7.88	8.41	1094	5.76	6.06	—	—	—	9.0	11.0	13.0	15.5
1.07	3.0	3.2	3281	2.51	3.41	1641	1.81	2.22	1088	1.38	1.65	8.8	11.3	13.3	14.8	16.8	18.8	21.3
ARC-LENGTH CORRECTION FACTOR												0.74	0.79	0.82	0.84	0.87	0.89	0.92
1.07	5.4	5.8	3259	8.98	10.30	1629	5.99	6.47	1080	4.37	4.65	—	7.4	9.4	10.9	12.9	14.9	17.4
1.07	5.6	6.0	3267	9.40	10.79	1633	6.32	6.80	1083	4.60	4.89	—	—	9.0	10.5	12.5	14.5	17.0
1.07	5.8	6.2	3274	9.81	11.25	1637	6.64	7.13	1085	4.84	5.13	—	—	8.7	10.2	12.2	14.2	16.7
1.07	6.0	6.4	3281	10.19	11.70	1641	6.96	7.46	1088	5.07	5.37	—	—	8.4	9.9	11.9	13.9	16.4
1.08	4.8	5.2	3231	7.62	8.79	1615	5.01	5.46	1071	3.65	3.93	—	8.3	10.3	11.8	13.8	15.8	18.3
ARC-LENGTH CORRECTION FACTOR												0.0	0.79	0.82	0.84	0.87	0.89	0.92
1.08	5.0	5.4	3241	8.10	9.32	1620	5.35	5.80	1074	3.90	4.18	—	8.0	10.0	11.5	13.5	15.5	18.0
1.08	5.2	5.6	3250	8.56	9.83	1625	5.68	6.14	1077	4.14	4.42	—	7.7	9.7	11.2	13.2	15.2	17.7
1.09	4.4	4.8	3208	6.63	7.72	1604	4.34	4.78	1063	3.17	3.45	6.4	8.9	10.9	12.4	14.4	16.4	18.9
1.09	4.6	5.0	3220	7.15	8.28	1610	4.68	5.13	1067	3.42	3.70	—	8.6	10.6	12.1	14.1	16.1	18.6
1.09	6.4	7.0	3200	10.96	12.61	1600	7.62	8.13	1061	5.56	5.86	—	—	—	9.1	11.1	13.1	15.6
ARC-LENGTH CORRECTION FACTOR												0.74	0.79	0.82	0.84	0.87	0.89	0.92

A = STANDARD V-BELT
 AX = COGGED/NOTCHED V-BELT
 + IF RIM SPEED EXCEEDS 6500 FEET PER MINUTE, CONSULT *Martin*.



Stock Drive Selection **A**

V-BELT DRIVES

Nominal Center Distances And Arc-Length Correction Factor												Sheave Combination		Speed Ratio
A/AX Belt Length Designation												DriveR P. D.	DriveN P. D.	
55	60	68	75	80	85	90	96	105	112	120	128			
23.4	25.9	29.9	33.4	35.9	38.4	40.9	43.9	48.4	51.9	55.9	59.9	3.0	3.0	1.00
23.1	25.6	29.6	33.1	35.6	38.1	40.6	43.6	48.1	51.6	55.6	59.6	3.2	3.2	1.00
22.8	25.3	29.3	32.8	35.3	37.8	40.3	43.3	47.8	51.3	55.3	59.3	3.4	3.4	1.00
22.5	25.0	29.0	32.5	35.0	37.5	40.0	43.0	47.5	51.0	55.0	59.0	3.6	3.6	1.00
22.2	24.7	28.7	32.2	34.7	37.2	39.7	42.7	47.2	50.7	54.7	58.7	3.8	3.8	1.00
0.94	0.97	1.00	1.03	1.04	1.06	1.08	1.09	1.12	1.13	1.15	1.17			
21.9	24.4	28.4	31.9	34.4	36.9	39.4	42.4	46.9	50.4	54.4	58.4	4.0	4.0	1.00
21.6	24.1	28.1	31.6	34.1	36.6	39.1	42.1	46.6	50.1	54.1	58.1	4.2	4.2	1.00
21.2	23.7	27.7	31.2	33.7	36.2	38.7	41.7	46.2	49.7	53.7	57.7	4.4	4.4	1.00
20.9	23.4	27.4	30.9	33.4	35.9	38.4	41.4	45.9	49.4	53.4	57.4	4.6	4.6	1.00
20.6	23.1	27.1	30.6	33.1	35.6	38.1	41.1	45.6	49.1	53.1	57.1	4.8	4.8	1.00
0.94	0.97	1.00	1.03	1.04	1.06	1.08	1.09	1.12	1.13	1.15	1.17			
20.3	22.8	26.8	30.3	32.8	35.3	37.8	40.8	45.3	48.8	52.8	56.8	5.0	5.0	1.00
20.0	22.5	26.5	30.0	32.5	35.0	37.5	40.5	45.0	48.5	52.5	56.5	5.2	5.2	1.00
19.7	22.2	26.2	29.7	32.2	34.7	37.2	40.2	44.7	48.2	52.2	56.2	5.4	5.4	1.00
19.4	21.9	25.9	29.4	31.9	34.4	36.9	39.9	44.4	47.9	51.9	55.9	5.6	5.6	1.00
19.0	21.5	25.5	29.0	31.5	34.0	36.5	39.5	44.0	47.5	51.5	55.5	5.8	5.8	1.00
0.94	0.97	1.00	1.03	1.04	1.06	1.08	1.09	1.12	1.13	1.15	1.17			
18.7	21.2	25.2	28.7	31.2	33.7	36.2	39.2	43.7	47.2	51.2	55.2	6.0	6.0	1.00
18.4	20.9	24.9	28.4	30.9	33.4	35.9	38.9	43.4	46.9	50.9	54.9	6.2	6.2	1.00
18.1	20.6	24.6	28.1	30.6	33.1	35.6	38.6	43.1	46.6	50.6	54.6	6.4	6.4	1.00
17.8	20.3	24.3	27.8	30.3	32.8	35.3	38.3	42.8	46.3	50.3	54.3	6.6	6.6	1.00
17.2	19.7	23.7	27.2	29.7	32.2	34.7	37.7	42.2	45.7	49.7	53.7	7.0	7.0	1.00
0.94	0.97	1.00	1.03	1.04	1.06	1.08	1.09	1.12	1.13	1.15	1.17			
18.9	21.4	25.4	28.9	31.4	33.9	36.4	39.4	43.9	47.4	51.4	55.4	5.8	6.0	1.03
18.6	21.1	25.1	28.6	31.1	33.6	36.1	39.1	43.6	47.1	51.1	55.1	6.0	6.2	1.03
18.3	20.8	24.8	28.3	30.8	33.3	35.8	38.8	43.3	46.8	50.8	54.8	6.2	6.4	1.03
17.9	20.4	24.4	27.9	30.4	32.9	35.4	38.4	42.9	46.4	50.4	54.4	6.4	6.6	1.03
20.8	23.3	27.3	30.8	33.3	35.8	38.3	41.3	45.8	49.3	53.3	57.3	4.6	4.8	1.04
0.94	0.97	1.00	1.03	1.04	1.06	1.07	1.09	1.12	1.13	1.15	1.17			
20.5	23.0	27.0	30.5	33.0	35.5	38.0	41.0	45.5	49.0	53.0	57.0	4.8	5.0	1.04
20.1	22.6	26.6	30.1	32.6	35.1	37.6	40.6	45.1	48.6	52.6	56.6	5.0	5.2	1.04
19.8	22.3	26.3	29.8	32.3	34.8	37.3	40.3	44.8	48.3	52.3	56.3	5.2	5.4	1.04
19.5	22.0	26.0	29.5	32.0	34.5	37.0	40.0	44.5	48.0	52.0	56.0	5.4	5.6	1.04
19.2	21.7	25.7	29.2	31.7	34.2	36.7	39.7	44.2	47.7	51.7	55.7	5.6	5.8	1.04
0.94	0.97	1.00	1.03	1.04	1.06	1.07	1.09	1.12	1.13	1.15	1.17			
22.0	24.5	28.5	32.0	34.5	37.0	39.5	42.5	47.0	50.5	54.5	58.5	3.8	4.0	1.05
21.7	24.2	28.2	31.7	34.2	36.7	39.2	42.2	46.7	50.2	54.2	58.2	4.0	4.2	1.05
21.4	23.9	27.9	31.4	33.9	36.4	38.9	41.9	46.4	49.9	53.9	57.9	4.2	4.4	1.05
21.1	23.6	27.6	31.1	33.6	36.1	38.6	41.6	46.1	49.6	53.6	57.6	4.4	4.6	1.05
23.0	25.5	29.5	33.0	35.5	38.0	40.5	43.5	48.0	51.5	55.5	59.5	3.2	3.4	1.06
0.94	0.97	1.00	1.03	1.04	1.06	1.07	1.09	1.12	1.13	1.15	1.17			
22.7	25.2	29.2	32.7	35.2	37.7	40.2	43.2	47.7	51.2	55.2	59.2	3.4	3.6	1.06
22.3	24.8	28.8	32.3	34.8	37.3	39.8	42.8	47.3	50.8	54.8	58.8	3.6	3.8	1.06
18.1	20.6	24.6	28.1	30.6	33.1	35.6	38.6	43.1	46.6	50.6	54.6	6.2	6.6	1.06
17.5	20.0	24.0	27.5	30.0	32.5	35.0	38.0	42.5	46.0	50.0	54.0	6.6	7.0	1.06
23.3	25.8	29.8	33.3	35.8	38.3	40.8	43.8	48.3	51.8	55.8	59.8	3.0	3.2	1.07
0.94	0.97	1.00	1.03	1.04	1.06	1.07	1.09	1.12	1.13	1.15	1.17			
19.4	21.9	25.9	29.4	31.9	34.4	36.9	39.9	44.4	47.9	51.9	55.9	5.4	5.8	1.07
19.0	21.5	25.5	29.0	31.5	34.0	36.5	39.5	44.0	47.5	51.5	55.5	5.6	6.0	1.07
18.7	21.2	25.2	28.7	31.2	33.7	36.2	39.2	43.7	47.2	51.2	55.2	5.8	6.2	1.07
18.4	20.9	24.9	28.4	30.9	33.4	35.9	38.9	43.4	46.9	50.9	54.9	6.0	6.4	1.07
20.3	22.8	26.8	30.3	32.8	35.3	37.8	40.8	45.3	48.8	52.8	56.8	4.8	5.2	1.08
0.94	0.96	1.00	1.02	1.04	1.06	1.07	1.09	1.12	1.13	1.15	1.17			
20.0	22.5	26.5	30.0	32.5	35.0	37.5	40.5	45.0	48.5	52.5	56.5	5.0	5.4	1.08
19.7	22.2	26.2	29.7	32.2	34.7	37.2	40.2	44.7	48.2	52.2	56.2	5.2	5.6	1.08
20.9	23.4	27.4	30.9	33.4	35.9	38.4	41.4	45.9	49.4	53.4	57.4	4.4	4.8	1.09
20.6	23.1	27.1	30.6	33.1	35.6	38.1	41.1	45.6	49.1	53.1	57.1	4.6	5.0	1.09
17.6	20.1	24.1	27.6	30.1	32.6	35.1	38.1	42.6	46.1	50.1	54.1	6.4	7.0	1.09
0.94	0.96	1.00	1.02	1.04	1.06	1.07	1.09	1.12	1.13	1.15	1.17			

FOR BELT SIZES NOT SHOWN, INTERPOLATE FOR ADDITIONAL CENTER DISTANCE.

A Stock Drive Selection



V-BELT DRIVES

Speed Ratio	Sheave Combination		DriveN Speeds and HP Per Belt									Nominal Center Distance And Arc-Length Correction Factor						
			3500 RPM DriveR			1750 RPM DriveR			1160 RPM DriveR									
	DriveR P.D.	DriveN P.D.	DriveN RPM	HP Per Belt A	HP Per Belt AX	DriveN RPM	HP Per Belt A	HP Per Belt AX	DriveN RPM	HP Per Belt A	HP Per Belt AX	A/AX Belt Length Designation						
												26	31	35	38	42	46	51
1.09	7.0	7.6	3224	11.86	13.76	1612	8.53	9.07	1068	6.24	6.55	—	—	—	—	10.2	12.2	14.7
1.10	4.0	4.4	3182	5.58	6.60	1591	3.66	4.09	1055	2.69	2.96	7.0	9.6	11.6	13.1	15.1	17.1	19.6
1.10	4.2	4.6	3196	6.13	7.18	1598	4.01	4.44	1059	2.93	3.21	6.7	9.2	11.2	12.7	14.7	16.7	19.2
1.10	5.8	6.4	3172	9.89	11.33	1586	6.68	7.17	1051	4.87	5.16	—	—	8.6	10.1	12.1	14.1	16.6
1.10	6.0	6.6	3182	10.28	11.78	1591	7.00	7.50	1055	5.10	5.39	—	—	8.2	9.7	11.8	13.8	16.3
ARC-LENGTH CORRECTION FACTOR												0.74	0.79	0.82	0.84	0.87	0.89	0.92
1.11	3.6	4.0	3150	4.46	5.42	1575	2.96	3.38	1044	2.19	2.46	7.7	10.2	12.2	13.7	15.7	17.7	20.2
1.11	3.8	4.2	3167	5.04	6.03	1583	3.32	3.74	1050	2.44	2.71	7.4	9.9	11.9	13.4	15.4	17.4	19.9
1.11	5.4	6.0	3150	9.09	10.41	1575	6.05	6.52	1044	4.40	4.69	—	—	9.2	10.7	12.7	14.7	17.2
1.11	5.6	6.2	3161	9.51	10.89	1581	6.38	6.85	1048	4.64	4.93	—	—	8.9	10.4	12.4	14.4	16.9
1.12	3.2	3.6	3111	3.27	4.19	1556	2.25	2.66	1031	1.69	1.95	8.3	10.8	12.8	14.3	16.3	18.3	20.8
ARC-LENGTH CORRECTION FACTOR												0.74	0.79	0.82	0.84	0.87	0.89	0.92
1.12	3.4	3.8	3132	3.88	4.82	1566	2.61	3.03	1038	1.94	2.21	8.0	10.5	12.5	14.0	16.0	18.0	20.5
1.12	4.8	5.4	3111	7.73	8.89	1556	5.06	5.51	1031	3.69	3.97	—	8.1	10.1	11.6	13.6	15.6	18.1
1.12	5.0	5.6	3125	8.21	9.42	1563	5.40	5.85	1036	3.93	4.21	—	7.8	9.8	11.3	13.3	15.3	17.8
1.12	5.2	5.8	3138	8.67	9.93	1569	5.73	6.19	1040	4.17	4.45	—	7.5	9.5	11.0	13.0	15.0	17.5
1.13	3.0	3.4	3088	2.67	3.56	1544	1.89	2.30	1024	1.44	1.70	8.6	11.1	13.1	14.6	16.6	18.6	21.1
ARC-LENGTH CORRECTION FACTOR												0.74	0.79	0.82	0.84	0.87	0.89	0.92
1.13	4.6	5.2	3096	7.25	8.37	1548	4.74	5.17	1026	3.45	3.73	—	8.4	10.4	11.9	13.9	16.0	18.5
1.13	6.2	7.0	3100	10.72	12.28	1550	7.36	7.85	1027	5.36	5.65	—	—	—	9.3	11.3	13.3	15.8
1.14	4.2	4.8	3062	6.22	7.27	1531	4.06	4.48	1015	2.97	3.24	6.6	9.1	11.1	12.6	14.6	16.6	19.1
1.14	4.4	5.0	3080	6.76	7.84	1540	4.40	4.84	1021	3.21	3.49	6.3	8.8	10.8	12.3	14.3	16.3	18.8
1.14	5.6	6.4	3062	9.59	10.95	1531	6.41	6.88	1015	4.66	4.95	—	—	8.7	10.2	12.2	14.2	16.7
ARC-LENGTH CORRECTION FACTOR												0.74	0.78	0.82	0.84	0.87	0.89	0.92
1.14	5.8	6.6	3076	9.99	11.42	1538	6.73	7.21	1019	4.90	5.19	—	—	8.4	9.9	11.9	13.9	16.4
1.15	4.0	4.6	3043	5.70	6.70	1522	3.72	4.14	1009	2.72	2.99	6.9	9.4	11.4	12.9	14.9	16.9	19.4
1.15	5.2	6.0	3033	8.74	9.99	1517	5.77	6.22	1005	4.19	4.47	—	7.3	9.3	10.8	12.8	14.8	17.3
1.15	5.4	6.2	3048	9.18	10.49	1524	6.10	6.56	1010	4.43	4.71	—	—	9.0	10.5	12.5	14.5	17.0
1.15	6.6	7.6	3039	11.43	13.14	1520	8.00	8.51	1007	5.84	6.13	—	—	—	—	10.5	12.5	15.0
ARC-LENGTH CORRECTION FACTOR												0.74	0.79	0.82	0.84	0.87	0.89	0.92
1.16	3.8	4.4	3023	5.15	6.13	1511	3.37	3.79	1002	2.48	2.75	7.2	9.7	11.7	13.2	15.2	17.2	19.7
1.16	5.0	5.8	3017	8.29	9.50	1509	5.44	5.89	1000	3.96	4.24	—	7.7	9.7	11.2	13.2	15.2	17.7
1.17	3.6	4.2	3000	4.59	5.54	1500	3.02	3.44	994	2.23	2.50	7.5	10.0	12.0	13.5	15.5	17.5	20.0
1.17	4.6	5.4	2981	7.33	8.45	1491	4.78	5.21	988	3.48	3.75	—	8.3	10.3	11.8	13.8	15.8	18.3
1.17	4.8	5.6	3000	7.83	8.99	1500	5.12	5.56	994	3.72	4.00	—	8.0	10.0	11.5	13.5	15.5	18.0
ARC-LENGTH CORRECTION FACTOR												0.74	0.79	0.82	0.84	0.87	0.89	0.92
1.17	6.0	7.0	3000	10.44	11.93	1500	7.08	7.57	994	5.16	5.44	—	—	—	9.4	11.4	13.4	15.9
1.17	7.0	8.2	2988	12.04	13.93	1494	8.62	9.16	990	6.30	6.61	—	—	—	—	9.7	11.7	14.2
1.18	3.4	4.0	2975	4.01	4.93	1487	2.67	3.08	986	1.98	2.25	7.8	10.3	12.3	13.8	15.8	17.8	20.3
1.18	4.4	5.2	2962	6.84	7.91	1481	4.44	4.87	982	3.24	3.51	—	8.6	10.6	12.1	14.1	16.1	18.6
1.18	5.6	6.6	2970	9.66	11.02	1485	6.45	6.92	984	4.69	4.97	—	—	8.6	10.1	12.1	14.1	16.6
ARC-LENGTH CORRECTION FACTOR												0.74	0.79	0.82	0.84	0.87	0.89	0.92
1.19	3.2	3.8	2947	3.41	4.31	1474	2.32	2.72	977	1.73	1.99	8.1	10.6	12.6	14.1	16.1	18.1	20.7
1.19	4.2	5.0	2940	6.32	7.35	1470	4.10	4.53	974	3.00	3.27	6.4	8.9	10.9	12.4	14.4	16.4	18.9
1.19	5.2	6.2	2935	8.81	10.06	1468	5.80	6.26	973	4.22	4.50	—	—	9.2	10.7	12.7	14.7	17.2
1.19	5.4	6.4	2953	9.26	10.56	1477	6.13	6.59	979	4.46	4.74	—	—	8.9	10.4	12.4	14.4	16.9
1.19	6.4	7.6	2947	11.18	12.81	1474	7.73	8.23	977	5.63	5.92	—	—	—	8.6	10.6	12.6	15.1
ARC-LENGTH CORRECTION FACTOR												0.74	0.79	0.82	0.84	0.87	0.89	0.92
1.20	3.0	3.6	2917	2.80	3.68	1458	1.96	2.36	967	1.48	1.74	8.5	11.0	13.0	14.5	16.5	18.5	21.0
1.20	4.0	4.8	2917	5.79	6.79	1458	3.76	4.18	967	2.75	3.02	6.7	9.2	11.2	12.7	14.7	16.7	19.2
1.20	5.0	6.0	2917	8.37	9.56	1458	5.48	5.92	967	3.98	4.26	—	7.5	9.5	11.0	13.0	15.0	17.5
1.21	3.8	4.6	2891	5.24	6.21	1446	3.42	3.83	958	2.51	2.77	7.0	9.5	11.5	13.0	15.0	17.0	19.5
1.21	4.8	5.8	2897	7.90	9.05	1448	5.15	5.59	960	3.75	4.02	—	7.8	9.8	11.3	13.3	15.3	17.8
ARC-LENGTH CORRECTION FACTOR												0.74	0.79	0.82	0.84	0.87	0.89	0.92
1.21	5.8	7.0	2900	10.12	11.54	1450	6.80	7.27	961	4.94	5.22	—	—	8.1	9.6	11.6	13.6	16.1
1.22	3.6	4.4	2864	4.67	5.61	1432	3.07	3.48	949	2.26	2.52	7.4	9.9	11.9	13.4	15.4	17.4	19.9
1.22	4.6	5.6	2875	7.42	8.52	1437	4.82	5.25	953	3.51	3.78	—	8.1	10.1	11.6	13.6	15.6	18.1
1.22	5.4	6.6	2864	9.30	10.60	1432	6.16	6.61	949	4.47	4.75	—	—	8.7	10.2	12.2	14.2	16.7
1.23	4.4	5.4	2852	6.91	7.98	1426	4.48	4.91	945	3.27	3.53	—	8.4	10.4	11.9	13.9	15.9	18.4
ARC-LENGTH CORRECTION FACTOR												0.74	0.78	0.82	0.84	0.87	0.89	0.92

A = STANDARD V-BELT
 AX = COGGED/NOTCHED V-BELT
 + IF RIM SPEED EXCEEDS 6500 FEET PER MINUTE, CONSULT *Martin*.



Stock Drive Selection A

V-BELT DRIVES

Nominal Center Distances And Arc-Length Correction Factor												Sheave Combination		Speed Ratio
A/AX Belt Length Designation												DriveR P. D.	DriveN P. D.	
55	60	68	75	80	85	90	96	105	112	120	128			
16.7	19.2	23.2	26.7	29.2	31.7	34.2	37.2	41.7	45.2	49.2	53.2	7.0	7.6	1.09
21.6	24.1	28.1	31.6	34.1	36.6	39.1	42.1	46.6	50.1	54.1	58.1	4.0	4.4	1.10
21.2	23.7	27.7	31.2	33.7	36.2	38.7	41.7	46.2	49.7	53.7	57.7	4.2	4.6	1.10
18.6	21.1	25.1	28.6	31.1	33.6	36.1	39.1	43.6	47.1	51.1	55.1	5.8	6.4	1.10
18.3	20.8	24.8	28.3	30.8	33.3	35.8	38.8	43.3	46.8	50.8	54.8	6.0	6.6	1.10
0.94	0.96	1.00	1.02	1.04	1.06	1.07	1.09	1.12	1.13	1.15	1.17			
22.2	24.7	28.7	32.2	34.7	37.2	39.7	42.7	47.2	50.7	54.7	58.7	3.6	4.0	1.11
21.9	24.4	28.4	31.9	34.4	36.9	39.4	42.4	46.9	50.4	54.4	58.4	3.8	4.2	1.11
19.2	21.7	25.7	29.2	31.7	34.2	36.7	39.7	44.2	47.7	51.7	55.7	5.4	6.0	1.11
18.9	21.4	25.4	28.9	31.4	33.9	36.4	39.4	43.9	47.4	51.4	55.4	5.6	6.2	1.11
22.8	25.3	29.3	32.8	35.3	37.8	40.3	43.3	47.8	51.3	55.3	59.3	3.2	3.6	1.12
0.94	0.96	1.00	1.02	1.04	1.06	1.07	1.09	1.12	1.13	1.15	1.17			
22.5	25.0	29.0	32.5	35.0	37.5	40.0	43.0	47.5	51.0	55.0	59.0	3.4	3.8	1.12
20.1	22.6	26.6	30.1	32.6	35.1	37.6	40.6	45.1	48.6	52.6	56.6	4.8	5.4	1.12
19.8	22.3	26.3	29.8	32.3	34.8	37.3	40.3	44.8	48.3	52.3	56.3	5.0	5.6	1.12
19.5	22.0	26.0	29.5	32.0	34.5	37.0	40.0	44.5	48.0	52.0	56.0	5.2	5.8	1.12
23.1	25.6	29.6	33.1	35.6	38.1	40.6	43.6	48.1	51.6	55.6	59.6	3.0	3.4	1.13
0.94	0.96	1.00	1.02	1.04	1.06	1.07	1.09	1.12	1.13	1.15	1.17			
20.5	23.0	27.0	30.5	33.0	35.5	38.0	41.0	45.5	49.0	53.0	57.0	4.6	5.2	1.13
17.8	20.3	24.3	27.8	30.3	32.8	35.3	38.3	42.8	46.3	50.3	54.3	6.2	7.0	1.13
21.1	23.6	27.6	31.1	33.6	36.1	38.6	41.6	46.1	49.6	53.6	57.6	4.2	4.8	1.14
20.8	23.3	27.3	30.8	33.3	35.8	38.3	41.3	45.8	49.3	53.3	57.3	4.4	5.0	1.14
18.7	21.2	25.2	28.7	31.2	33.7	36.2	39.2	43.7	47.2	51.2	55.2	5.6	6.4	1.14
0.94	0.96	1.00	1.02	1.04	1.06	1.07	1.09	1.12	1.13	1.15	1.17			
18.4	20.9	24.9	28.4	30.9	33.4	35.9	38.9	43.4	46.9	50.9	54.9	5.8	6.6	1.14
21.4	23.9	27.9	31.4	33.9	36.4	38.9	41.9	46.4	49.9	53.9	57.9	4.0	4.6	1.15
19.3	21.8	25.9	29.4	31.9	34.4	36.9	39.9	44.4	47.9	51.9	55.9	5.2	6.0	1.15
19.0	21.5	25.5	29.0	31.5	34.0	36.5	39.5	44.0	47.5	51.5	55.5	5.4	6.2	1.15
17.0	19.5	23.5	27.0	29.5	32.0	34.5	37.5	42.0	45.5	49.5	53.5	6.6	7.6	1.15
0.94	0.96	1.00	1.02	1.04	1.06	1.07	1.09	1.12	1.13	1.15	1.17			
21.7	24.2	28.2	31.7	34.2	36.7	39.2	42.2	46.7	50.2	54.2	58.2	3.8	4.4	1.16
19.7	22.2	26.2	29.7	32.2	34.7	37.2	40.2	44.7	48.2	52.2	56.2	5.0	5.8	1.16
22.0	24.5	28.5	32.0	34.5	37.0	39.5	42.5	47.0	50.5	54.5	58.5	3.6	4.2	1.17
20.3	22.8	26.8	30.3	32.8	35.3	37.8	40.8	45.3	48.8	52.8	56.8	4.6	5.4	1.17
20.0	22.5	26.5	30.0	32.5	35.0	37.5	40.5	45.0	48.5	52.5	56.5	4.8	5.6	1.17
0.94	0.96	1.00	1.02	1.04	1.06	1.07	1.09	1.12	1.13	1.15	1.17			
17.9	20.4	24.4	27.9	30.4	32.9	35.4	38.4	42.9	46.4	50.4	54.4	6.0	7.0	1.17
16.2	18.7	22.7	26.2	28.7	31.2	33.7	36.7	41.2	44.7	48.7	52.7	7.0	8.2	1.17
22.3	24.8	28.8	32.3	34.8	37.3	39.8	42.8	47.3	50.8	54.8	58.8	3.4	4.0	1.18
20.6	23.1	27.1	30.6	33.1	35.6	38.1	41.1	45.6	49.1	53.1	57.1	4.4	5.2	1.18
18.6	21.1	25.1	28.6	31.1	33.6	36.1	39.1	43.6	47.1	51.1	55.1	5.6	6.6	1.18
0.94	0.96	1.00	1.02	1.04	1.06	1.07	1.09	1.12	1.13	1.15	1.17			
22.7	25.2	29.2	32.7	35.2	37.7	40.2	43.2	47.7	51.2	55.2	59.2	3.2	3.8	1.19
20.9	23.4	27.4	30.9	33.4	35.9	38.4	41.4	45.9	49.4	53.4	57.4	4.2	5.0	1.19
19.2	21.7	25.7	29.2	31.7	34.2	36.7	39.7	44.2	47.7	51.7	55.7	5.2	6.2	1.19
18.9	21.4	25.4	28.9	31.4	33.9	36.4	39.4	43.9	47.4	51.4	55.4	5.4	6.4	1.19
17.1	19.6	23.6	27.1	29.6	32.1	34.6	37.6	42.2	45.7	49.7	53.7	6.4	7.6	1.19
0.94	0.96	1.00	1.02	1.04	1.06	1.07	1.09	1.12	1.13	1.15	1.17			
23.0	25.5	29.5	33.0	35.5	38.0	40.5	43.5	48.0	51.5	55.5	59.5	3.0	3.6	1.20
21.2	23.7	27.7	31.2	33.7	36.2	38.7	41.7	46.2	49.7	53.7	57.7	4.0	4.8	1.20
19.5	22.0	26.0	29.5	32.0	34.5	37.0	40.0	44.5	48.0	52.0	56.0	5.0	6.0	1.20
21.5	24.0	28.0	31.6	34.1	36.6	39.1	42.1	46.6	50.1	54.1	58.1	3.8	4.6	1.21
19.8	22.3	26.3	29.8	32.3	34.8	37.3	40.3	44.8	48.3	52.3	56.3	4.8	5.8	1.21
0.94	0.96	1.00	1.02	1.04	1.06	1.07	1.09	1.12	1.13	1.15	1.17			
18.1	20.6	24.6	28.1	30.6	33.1	35.6	38.6	43.1	46.6	50.6	54.6	5.8	7.0	1.21
21.9	24.4	28.4	31.9	34.4	36.9	39.4	42.4	46.9	50.4	54.4	58.4	3.6	4.4	1.22
20.1	22.6	26.6	30.1	32.6	35.1	37.6	40.6	45.1	48.6	52.6	56.6	4.6	5.6	1.22
18.7	21.2	25.2	28.7	31.2	33.7	36.2	39.2	43.7	47.2	51.2	55.2	5.4	6.6	1.22
20.4	22.9	26.9	30.4	32.9	35.4	37.9	41.0	45.5	49.0	53.0	57.0	4.4	5.4	1.23
0.94	0.96	1.00	1.02	1.04	1.06	1.07	1.09	1.11	1.13	1.15	1.17			

FOR BELT SIZES NOT SHOWN, INTERPOLATE FOR ADDITIONAL CENTER DISTANCE.

A Stock Drive Selection



V-BELT DRIVES

Speed Ratio	Sheave Combination		DriveN Speeds and HP Per Belt									Nominal Center Distance And Arc-Length Correction Factor						
			3500 RPM DriveR			1750 RPM DriveR			1160 RPM DriveR									
	DriveR P.D.	DriveN P.D.	DriveN RPM	HP Per Belt A	HP Per Belt AX	DriveN RPM	HP Per Belt A	HP Per Belt AX	DriveN RPM	HP Per Belt A	HP Per Belt AX	A/AX Belt Length Designation						
												26	31	35	38	42	46	51
1.23	5.2	6.4	2844	8.87	10.11	1422	5.83	6.28	942	4.24	4.51	—	—	9.0	10.5	12.5	14.5	17.0
1.23	6.2	7.6	2855	10.90	12.45	1428	7.44	7.94	946	5.42	5.71	—	—	—	8.8	10.8	12.8	15.3
1.24	3.4	4.2	2833	4.10	5.02	1417	2.72	3.12	939	2.01	2.27	7.7	10.2	12.2	13.7	15.7	17.7	20.2
1.24	4.2	5.2	2827	6.39	7.42	1413	4.14	4.56	937	3.02	3.29	6.2	8.8	10.8	12.3	14.3	16.3	18.8
1.24	5.0	6.2	2823	8.42	9.61	1411	5.51	5.95	935	4.00	4.27	—	7.3	9.3	10.8	12.8	14.8	17.3
ARC-LENGTH CORRECTION FACTOR												0.74	0.78	0.82	0.84	0.87	0.89	0.92
1.24	6.6	8.2	2817	11.58	13.28	1409	8.07	8.58	934	5.89	6.18	—	—	—	—	10.0	12.0	14.5
1.25	3.2	4.0	2800	3.50	4.39	1400	2.36	2.76	928	1.76	2.02	8.0	10.5	12.5	14.0	16.0	18.0	20.5
1.25	4.0	5.0	2800	5.86	6.85	1400	3.80	4.21	928	2.78	3.04	6.6	9.1	11.1	12.6	14.6	16.6	19.1
1.25	4.8	6.0	2800	7.95	9.10	1400	5.18	5.61	928	3.76	4.03	—	7.6	9.6	11.2	13.2	15.2	17.7
1.25	5.6	7.0	2800	9.77	11.12	1400	6.50	6.97	928	4.72	5.00	—	—	8.2	9.7	11.7	13.7	16.2
ARC-LENGTH CORRECTION FACTOR												0.74	0.78	0.82	0.84	0.87	0.89	0.92
1.26	3.8	4.8	2771	5.30	6.27	1385	3.45	3.86	918	2.53	2.79	6.9	9.4	11.4	12.9	14.9	16.9	19.4
1.26	4.6	5.8	2776	7.47	8.57	1388	4.84	5.27	920	3.52	3.79	—	8.0	10.0	11.5	13.5	15.5	18.0
1.27	3.0	3.8	2763	2.90	3.77	1382	2.00	2.40	916	1.51	1.77	8.3	10.8	12.8	14.3	16.3	18.3	20.8
1.27	4.4	5.6	2750	6.96	8.02	1375	4.51	4.93	911	3.28	3.55	—	8.3	10.3	11.8	13.8	15.8	18.3
1.27	5.2	6.6	2758	8.92	10.16	1379	5.86	6.31	914	4.26	4.53	—	—	8.9	10.4	12.4	14.4	16.9
ARC-LENGTH CORRECTION FACTOR												0.73	0.78	0.81	0.84	0.86	0.89	0.92
1.27	6.0	7.6	2763	10.58	12.06	1382	7.15	7.63	916	5.20	5.49	—	—	—	8.9	10.9	12.9	15.4
1.28	3.6	4.6	2739	4.74	5.68	1370	3.10	3.51	908	2.29	2.55	7.2	9.7	11.7	13.2	15.2	17.2	19.7
1.28	5.0	6.4	2734	8.47	9.66	1367	5.53	5.97	906	4.02	4.29	—	—	9.2	10.7	12.7	14.7	17.2
1.28	6.4	8.2	2732	11.30	12.92	1366	7.79	8.28	905	5.67	5.96	—	—	—	—	10.1	12.1	14.7
1.29	3.4	4.4	2705	4.16	5.07	1352	2.75	3.15	896	2.03	2.29	7.5	10.0	12.0	13.5	15.5	17.5	20.0
ARC-LENGTH CORRECTION FACTOR												0.73	0.78	0.81	0.84	0.86	0.89	0.92
1.29	4.2	5.4	2722	6.45	7.47	1361	4.17	4.59	902	3.04	3.31	—	8.6	10.6	12.1	14.1	16.1	18.6
1.29	4.8	6.2	2710	8.00	9.14	1355	5.20	5.63	898	3.78	4.05	—	7.5	9.5	11.0	13.0	15.0	17.5
1.29	7.0	9.0	2722	12.21	14.08	1361	8.70	9.23	902	6.36	6.66	—	—	—	—	—	11.0	13.5
1.30	4.0	5.2	2692	5.91	6.90	1346	3.82	4.24	892	2.80	3.06	6.4	8.9	10.9	12.4	14.4	16.4	18.9
1.30	4.6	6.0	2683	7.51	8.61	1342	4.87	5.29	889	3.54	3.80	—	7.8	9.8	11.3	13.3	15.3	17.8
ARC-LENGTH CORRECTION FACTOR												0.73	0.78	0.81	0.83	0.86	0.89	0.92
1.30	5.4	7.0	2700	9.40	10.69	1350	6.20	6.66	895	4.51	4.78	—	—	8.4	9.9	11.9	13.9	16.4
1.31	3.2	4.2	2667	3.57	4.45	1333	2.39	2.79	884	1.78	2.04	7.8	10.3	12.3	13.8	15.8	17.8	20.3
1.31	5.8	7.6	2671	10.24	11.64	1336	6.86	7.33	885	4.98	5.26	—	—	—	9.1	11.1	13.1	15.6
1.32	3.8	5.0	2660	5.37	6.32	1330	3.48	3.89	882	2.55	2.81	6.7	9.2	11.2	12.7	14.7	16.7	19.2
1.32	4.4	5.8	2655	7.01	8.07	1328	4.53	4.95	880	3.30	3.56	—	8.1	10.1	11.6	13.6	15.6	18.1
ARC-LENGTH CORRECTION FACTOR												0.73	0.78	0.81	0.84	0.86	0.89	0.92
1.32	5.0	6.6	2652	8.51	9.69	1326	5.55	5.99	879	4.03	4.30	—	—	9.0	10.5	12.5	14.5	17.0
1.32	6.2	8.2	2646	11.00	12.54	1323	7.49	7.98	877	5.45	5.74	—	—	—	—	10.3	12.3	14.8
1.33	3.0	4.0	2625	2.96	3.82	1313	2.03	2.43	870	1.53	1.79	8.1	10.6	12.6	14.1	16.1	18.1	20.6
1.33	3.6	4.8	2625	4.79	5.72	1312	3.13	3.53	870	2.30	2.56	7.0	9.5	11.5	13.0	15.0	17.0	19.5
1.33	4.2	5.6	2625	6.49	7.51	1312	4.19	4.60	870	3.05	3.32	—	8.4	10.4	11.9	13.9	15.9	18.4
ARC-LENGTH CORRECTION FACTOR												0.73	0.78	0.82	0.84	0.86	0.89	0.92
1.33	4.8	6.4	2625	8.04	9.17	1312	5.22	5.65	870	3.79	4.06	—	7.3	9.3	10.8	12.8	14.8	17.3
1.35	3.4	4.6	2587	4.21	5.12	1293	2.77	3.17	857	2.05	2.31	7.3	9.8	11.9	13.4	15.4	17.4	19.9
1.35	4.0	5.4	2593	5.96	6.94	1296	3.85	4.26	859	2.81	3.07	6.2	8.7	10.7	12.2	14.3	16.3	18.8
1.35	4.6	6.2	2597	7.55	8.65	1298	4.89	5.31	861	3.55	3.82	—	7.6	9.6	11.1	13.1	15.1	17.6
1.35	5.2	7.0	2600	9.00	10.23	1300	5.90	6.34	862	4.28	4.55	—	—	8.5	10.0	12.0	14.0	16.5
ARC-LENGTH CORRECTION FACTOR												0.73	0.78	0.81	0.84	0.86	0.89	0.92
1.36	4.4	6.0	2567	7.05	8.10	1283	4.55	4.97	851	3.31	3.57	—	7.9	9.9	11.5	13.5	15.5	18.0
1.36	5.6	7.6	2579	9.87	11.21	1289	6.55	7.01	855	4.76	5.03	—	—	—	9.2	11.2	13.2	15.8
1.36	6.6	9.0	2567	11.69	13.39	1283	8.13	8.64	851	5.92	6.21	—	—	—	—	—	11.3	13.8
1.37	3.2	4.4	2545	3.62	4.50	1273	2.42	2.81	844	1.80	2.06	7.7	10.2	12.2	13.7	15.7	17.7	20.2
1.37	3.8	5.2	2558	5.40	6.36	1279	3.50	3.91	848	2.56	2.82	6.5	9.1	11.1	12.6	14.6	16.6	19.1
ARC-LENGTH CORRECTION FACTOR												0.73	0.78	0.81	0.84	0.86	0.89	0.92
1.37	4.8	6.6	2545	8.07	9.20	1273	5.23	5.67	844	3.80	4.07	—	—	9.2	10.7	12.7	14.7	17.2
1.37	6.0	8.2	2561	10.67	12.14	1280	7.20	7.67	849	5.23	5.51	—	—	—	—	10.4	12.4	15.0
1.38	4.2	5.8	2534	6.53	7.54	1267	4.21	4.62	840	3.07	3.33	—	8.3	10.3	11.8	13.8	15.8	18.3
1.39	3.6	5.0	2520	4.84	5.76	1260	3.15	3.55	835	2.32	2.57	6.9	9.4	11.4	12.9	14.9	16.9	19.4
1.39	4.6	6.4	2516	7.58	8.67	1258	4.90	5.33	834	3.56	3.83	—	7.5	9.5	11.0	13.0	15.0	17.5
ARC-LENGTH CORRECTION FACTOR												0.73	0.78	0.81	0.83	0.86	0.89	0.91

A = STANDARD V-BELT
 AX = COGGED/NOTCHED V-BELT
 + IF RIM SPEED EXCEEDS 6500 FEET PER MINUTE, CONSULT *Martin*.



Stock Drive Selection **A**

V-BELT DRIVES

Nominal Center Distances And Arc-Length Correction Factor												Sheave Combination		Speed Ratio
A/AX Belt Length Designation												DriveR P. D.	DriveN P. D.	
55	60	68	75	80	85	90	96	105	112	120	128			
19.0	21.5	25.5	29.0	31.5	34.0	36.5	39.5	44.0	47.5	51.5	55.5	5.2	6.4	1.23
17.3	19.8	23.8	27.3	29.8	32.3	34.8	37.8	42.3	45.8	49.8	53.8	6.2	7.6	1.23
22.2	24.7	28.7	32.2	34.7	37.2	39.7	42.7	47.2	50.7	54.7	58.7	3.4	4.2	1.24
20.8	23.3	27.3	30.8	33.3	35.8	38.3	41.3	45.8	49.3	53.3	57.3	4.2	5.2	1.24
19.3	21.8	25.8	29.3	31.8	34.3	36.8	39.8	44.3	47.8	51.9	55.9	5.0	6.2	1.24
0.94	0.96	1.00	1.02	1.04	1.06	1.07	1.09	1.11	1.13	1.15	1.17			
16.5	19.0	23.0	26.5	29.0	31.5	34.0	37.0	41.5	45.0	49.0	53.0	6.6	8.2	1.24
22.5	25.0	29.0	32.5	35.0	37.5	40.0	43.0	47.5	51.0	55.0	59.0	3.2	4.0	1.25
21.1	23.6	27.6	31.1	33.6	36.1	38.6	41.6	46.1	49.6	53.6	57.6	4.0	5.0	1.25
19.7	22.2	26.2	29.7	32.2	34.7	37.2	40.2	44.7	48.2	52.2	56.2	4.8	6.0	1.25
18.2	20.7	24.7	28.2	30.7	33.2	35.7	38.7	43.2	46.7	50.7	54.7	5.6	7.0	1.25
0.94	0.96	1.00	1.02	1.04	1.06	1.07	1.09	1.11	1.13	1.15	1.17			
21.4	23.9	27.9	31.4	33.9	36.4	38.9	41.9	46.4	49.9	53.9	57.9	3.8	4.8	1.26
20.0	22.5	26.5	30.0	32.5	35.0	37.5	40.5	45.0	48.5	52.5	56.5	4.6	5.8	1.26
22.8	25.3	29.3	32.8	35.3	37.8	40.3	43.3	47.8	51.3	55.3	59.3	3.0	3.8	1.27
20.3	22.8	26.8	30.3	32.8	35.3	37.8	40.8	45.3	48.8	52.8	56.8	4.4	5.6	1.27
18.9	21.4	25.4	28.9	31.4	33.9	36.4	39.4	43.9	47.4	51.4	55.4	5.2	6.6	1.27
0.94	0.96	1.00	1.02	1.04	1.06	1.07	1.09	1.11	1.13	1.15	1.17			
17.5	20.0	24.0	27.5	30.0	32.5	35.0	38.0	42.5	46.0	50.0	54.0	6.0	7.6	1.27
21.7	24.2	28.2	31.7	34.2	36.7	39.2	42.2	46.7	50.2	54.2	58.2	3.6	4.6	1.28
19.2	21.7	25.7	29.2	31.7	34.2	36.7	39.7	44.2	47.7	51.7	55.7	5.0	6.4	1.28
16.7	19.2	23.2	26.7	29.2	31.7	34.2	37.2	41.7	45.2	49.2	53.2	6.4	8.2	1.28
22.0	24.5	28.5	32.0	34.5	37.0	39.5	42.5	47.0	50.5	54.5	58.5	3.4	4.4	1.29
0.94	0.96	1.00	1.02	1.04	1.06	1.07	1.09	1.11	1.13	1.15	1.17			
20.6	23.1	27.1	30.6	33.1	35.6	38.1	41.1	45.6	49.1	53.1	57.1	4.2	5.4	1.29
19.5	22.0	26.0	29.5	32.0	34.5	37.0	40.0	44.5	48.0	52.0	56.0	4.8	6.2	1.29
15.6	18.1	22.1	25.6	28.1	30.6	33.1	36.1	40.6	44.1	48.1	52.1	7.0	9.0	1.29
20.9	23.4	27.4	30.9	33.4	35.9	38.4	41.4	45.9	49.4	53.4	57.4	4.0	5.2	1.30
19.8	22.3	26.3	29.8	32.3	34.8	37.3	40.3	44.8	48.3	52.3	56.3	4.6	6.0	1.30
0.94	0.96	0.99	1.02	1.04	1.06	1.07	1.09	1.11	1.13	1.15	1.17			
18.4	20.9	24.9	28.4	30.9	33.4	35.9	38.9	43.4	46.9	50.9	54.9	5.4	7.0	1.30
22.3	24.8	28.8	32.3	34.8	37.3	39.8	42.8	47.3	50.8	54.8	58.8	3.2	4.2	1.31
17.6	20.1	24.1	27.6	30.1	32.6	35.1	38.1	42.6	46.1	50.1	54.1	5.8	7.6	1.31
21.2	23.7	27.7	31.2	33.7	36.2	38.7	41.7	46.2	49.7	53.7	57.7	3.8	5.0	1.32
20.1	22.6	26.6	30.1	32.6	35.1	37.6	40.6	45.1	48.6	52.6	56.6	4.4	5.8	1.32
0.94	0.96	1.00	1.02	1.04	1.06	1.07	1.09	1.11	1.13	1.15	1.17			
19.0	21.5	25.5	29.0	31.5	34.0	36.5	39.5	44.0	47.5	51.5	55.5	5.0	6.6	1.32
16.8	19.3	23.3	26.8	29.3	31.8	34.3	37.3	41.8	45.3	49.3	53.3	6.2	8.2	1.32
22.6	25.1	29.1	32.6	35.1	37.6	40.1	43.1	47.6	51.1	55.1	59.1	3.0	4.0	1.33
21.5	24.0	28.0	31.5	34.0	36.5	39.0	42.0	46.5	50.0	54.0	58.0	3.6	4.8	1.33
20.4	22.9	26.9	30.4	32.9	35.4	37.9	40.9	45.4	48.9	52.9	56.9	4.2	5.6	1.33
0.94	0.96	1.00	1.02	1.04	1.06	1.07	1.09	1.11	1.13	1.15	1.17			
19.3	21.8	25.8	29.3	31.8	34.3	36.8	39.8	44.3	47.8	51.8	55.8	4.8	6.4	1.33
21.9	24.4	28.4	31.9	34.4	36.9	39.4	42.4	46.9	50.4	54.4	58.4	3.4	4.6	1.35
20.8	23.3	27.3	30.8	33.3	35.8	38.3	41.3	45.8	49.3	53.3	57.3	4.0	5.4	1.35
19.7	22.2	26.2	29.7	32.2	34.7	37.2	40.2	44.7	48.2	52.2	56.2	4.6	6.2	1.35
18.5	21.0	25.1	28.6	31.1	33.6	36.1	39.1	43.6	47.1	51.1	55.1	5.2	7.0	1.35
0.94	0.96	0.99	1.02	1.04	1.06	1.07	1.09	1.11	1.13	1.15	1.17			
20.0	22.5	26.5	30.0	32.5	35.0	37.5	40.5	45.0	48.5	52.5	56.5	4.4	6.0	1.36
17.8	20.3	24.3	27.8	30.3	32.8	35.3	38.3	42.8	46.3	50.3	54.3	5.6	7.6	1.36
15.9	18.4	22.4	25.9	28.4	30.9	33.4	36.4	40.9	44.4	48.4	52.4	6.6	9.0	1.36
22.2	24.7	28.7	32.2	34.7	37.2	39.7	42.7	47.2	50.7	54.7	58.7	3.2	4.4	1.37
21.1	23.6	27.6	31.1	33.6	36.1	38.6	41.6	46.1	49.6	53.6	57.6	3.8	5.2	1.37
0.94	0.96	0.99	1.02	1.04	1.06	1.07	1.09	1.11	1.13	1.15	1.17			
19.2	21.7	25.7	29.2	31.7	34.2	36.7	39.7	44.2	47.7	51.7	55.7	4.8	6.6	1.37
17.0	19.5	23.5	27.0	29.5	32.0	34.5	37.5	42.0	45.5	49.5	53.5	6.0	8.2	1.37
20.3	22.8	26.8	30.3	32.8	35.3	37.8	40.8	45.3	48.8	52.8	56.8	4.2	5.8	1.38
21.4	23.9	27.9	31.4	33.9	36.4	38.9	41.9	46.4	49.9	53.9	57.9	3.6	5.0	1.39
19.5	22.0	26.0	29.5	32.0	34.5	37.0	40.0	44.5	48.0	52.0	56.0	4.6	6.4	1.39
0.94	0.96	0.99	1.02	1.04	1.05	1.07	1.09	1.11	1.13	1.15	1.17			

FOR BELT SIZES NOT SHOWN, INTERPOLATE FOR ADDITIONAL CENTER DISTANCE.

A Stock Drive Selection



V-BELT DRIVES

Speed Ratio	Sheave Combination		DriveN Speeds and HP Per Belt									Nominal Center Distance And Arc-Length Correction Factor						
			3500 RPM DriveR			1750 RPM DriveR			1160 RPM DriveR									
	DriveR P.D.	DriveN P.D.	DriveN RPM	HP Per Belt A	HP Per Belt AX	DriveN RPM	HP Per Belt A	HP Per Belt AX	DriveN RPM	HP Per Belt A	HP Per Belt AX	A/AX Belt Length Designation						
												26	31	35	38	42	46	51
1.40	3.0	4.2	2500	3.01	3.87	1250	2.06	2.45	829	1.55	1.80	8.0	10.5	12.5	14.0	16.0	18.0	20.5
1.40	4.0	5.6	2500	5.99	6.97	1250	3.86	4.27	829	2.82	3.08	—	8.6	10.6	12.1	14.1	16.1	18.6
1.40	5.0	7.0	2500	8.57	9.75	1250	5.58	6.02	829	4.05	4.32	—	—	8.7	10.2	12.2	14.2	16.7
1.41	3.4	4.8	2479	4.25	5.15	1240	2.79	3.19	822	2.07	2.32	7.2	9.7	11.7	13.2	15.2	17.2	19.7
1.41	4.4	6.2	2484	7.08	8.13	1242	4.56	4.98	823	3.32	3.58	—	7.8	9.8	11.3	13.3	15.3	17.8
ARC-LENGTH CORRECTION FACTOR												0.73	0.78	0.81	0.84	0.86	0.89	0.92
1.41	5.4	7.6	2487	9.48	10.76	1243	6.25	6.70	824	4.53	4.80	—	—	—	9.4	11.4	13.4	15.9
1.41	5.8	8.2	2476	10.31	11.71	1238	6.89	7.36	820	5.01	5.28	—	—	—	8.6	10.6	12.6	15.1
1.41	6.4	9.0	2489	11.41	13.02	1244	7.84	8.33	825	5.71	5.99	—	—	—	—	9.5	11.5	14.0
1.42	3.8	5.4	2463	5.44	6.39	1231	3.52	3.92	816	2.58	2.83	6.4	8.9	10.9	12.4	14.4	16.4	18.9
1.43	4.2	6.0	2450	6.56	7.57	1225	4.22	4.64	812	3.08	3.34	—	8.1	10.1	11.6	13.6	15.6	18.1
ARC-LENGTH CORRECTION FACTOR												0.72	0.77	0.81	0.83	0.86	0.88	0.91
1.43	4.6	6.6	2439	7.61	8.69	1220	4.91	5.34	808	3.57	3.83	—	7.3	9.3	10.8	12.8	14.8	17.3
1.44	3.2	4.6	2435	3.66	4.54	1217	2.44	2.83	807	1.81	2.07	7.5	10.0	12.0	13.5	15.5	17.5	20.0
1.44	3.6	5.2	2423	4.87	5.79	1212	3.16	3.56	803	2.33	2.58	6.7	9.2	11.2	12.7	14.7	16.7	19.2
1.45	4.0	5.8	2414	6.02	7.00	1207	3.88	4.29	800	2.83	3.09	—	8.4	10.4	11.9	13.9	15.9	18.4
1.45	4.4	6.4	2406	7.10	8.15	1203	4.57	4.99	797	3.33	3.59	—	7.6	9.6	11.1	13.1	15.1	17.6
ARC-LENGTH CORRECTION FACTOR												0.73	0.78	0.81	0.83	0.86	0.89	0.91
1.45	6.2	9.0	2411	11.08	12.62	1206	7.54	8.02	799	5.48	5.76	—	—	—	9.6	11.6	14.1	16.6
1.46	4.8	7.0	2400	8.12	9.25	1200	5.26	5.69	795	3.82	4.08	—	—	8.8	10.3	12.3	14.3	16.8
1.46	5.2	7.6	2395	9.06	10.29	1197	5.93	6.37	794	4.30	4.57	—	—	8.0	9.5	11.5	13.5	16.1
1.46	5.6	8.2	2390	9.93	11.27	1195	6.58	7.04	792	4.78	5.05	—	—	—	8.7	10.7	12.7	15.3
1.47	3.0	4.4	2386	3.05	3.90	1193	2.08	2.47	791	1.56	1.81	7.8	10.3	12.3	13.8	15.8	17.8	20.3
ARC-LENGTH CORRECTION FACTOR												0.73	0.78	0.81	0.83	0.86	0.89	0.91
1.47	3.4	5.0	2380	4.28	5.18	1190	2.81	3.21	789	2.08	2.33	7.0	9.5	11.5	13.0	15.0	17.0	19.5
1.47	3.8	5.6	2375	5.46	6.41	1187	3.53	3.93	787	2.58	2.84	6.2	8.7	10.7	12.2	14.2	16.2	18.7
1.48	4.2	6.2	2371	6.58	7.59	1185	4.24	4.65	786	3.09	3.34	—	7.9	9.9	11.4	13.4	15.4	18.0
1.50	3.2	4.8	2333	3.69	4.56	1167	2.45	2.84	773	1.82	2.08	7.3	9.8	11.8	13.3	15.3	17.3	19.9
1.50	3.6	5.4	2333	4.89	5.81	1167	3.18	3.58	773	2.33	2.59	6.5	9.0	11.0	12.5	14.6	16.6	19.1
ARC-LENGTH CORRECTION FACTOR												0.72	0.77	0.81	0.83	0.86	0.88	0.91
1.50	4.0	6.0	2333	6.04	7.02	1167	3.89	4.30	773	2.84	3.10	—	8.2	10.2	11.8	13.8	15.8	18.3
1.50	4.4	6.6	2333	7.12	8.17	1167	4.59	5.00	773	3.34	3.60	—	7.4	9.4	11.0	13.0	15.0	17.5
1.50	6.0	9.0	2333	10.74	12.20	1167	7.23	7.71	773	5.26	5.53	—	—	—	9.8	11.8	14.3	16.8
1.51	7.0	10.6	2311	12.35	14.21	1156	8.77	9.30	766	6.41	6.70	—	—	—	—	—	—	12.2
1.52	4.2	6.4	2297	6.60	7.61	1148	4.24	4.65	761	3.09	3.35	—	7.7	9.8	11.3	13.3	15.3	17.8
ARC-LENGTH CORRECTION FACTOR												0.0	0.77	0.80	0.83	0.85	0.88	0.91
1.52	4.6	7.0	2300	7.65	8.73	1150	4.93	5.35	762	3.58	3.85	—	—	9.0	10.5	12.5	14.5	17.0
1.52	5.0	7.6	2303	8.63	9.80	1151	5.61	6.04	763	4.07	4.34	—	—	8.2	9.7	11.7	13.7	16.2
1.52	5.4	8.2	2305	9.53	10.81	1152	6.27	6.72	764	4.55	4.82	—	—	—	8.9	10.9	12.9	15.4
1.53	3.0	4.6	2283	3.07	3.93	1141	2.09	2.48	757	1.57	1.82	7.6	10.1	12.2	13.7	15.7	17.7	20.2
1.53	3.4	5.2	2288	4.31	5.20	1144	2.82	3.22	758	2.08	2.34	6.8	9.4	11.4	12.9	14.9	16.9	19.4
ARC-LENGTH CORRECTION FACTOR												0.72	0.78	0.81	0.83	0.86	0.89	0.91
1.53	3.8	5.8	2293	5.49	6.43	1147	3.54	3.94	760	2.59	2.85	—	8.6	10.6	12.1	14.1	16.1	18.6
1.55	4.0	6.2	2258	6.06	7.04	1129	3.90	4.30	748	2.85	3.10	—	8.1	10.1	11.6	13.6	15.6	18.1
1.55	5.8	9.0	2256	10.38	11.77	1128	6.93	7.39	748	5.03	5.30	—	—	—	—	9.9	11.9	14.4
1.56	3.2	5.0	2240	3.71	4.58	1120	2.46	2.85	742	1.83	2.08	7.2	9.7	11.7	13.2	15.2	17.2	19.7
1.56	3.6	5.6	2250	4.92	5.83	1125	3.19	3.59	746	2.34	2.60	6.3	8.9	10.9	12.4	14.4	16.4	18.9
ARC-LENGTH CORRECTION FACTOR												0.72	0.77	0.81	0.83	0.86	0.88	0.91
1.57	4.2	6.6	2227	6.62	7.62	1114	4.25	4.66	738	3.10	3.35	—	7.6	9.6	11.1	13.1	15.1	17.6
1.58	3.8	6.0	2217	5.50	6.45	1108	3.55	3.95	735	2.60	2.85	—	8.4	10.4	11.9	13.9	15.9	18.4
1.58	4.8	7.6	2211	8.17	9.29	1105	5.28	5.71	733	3.84	4.10	—	—	8.3	9.8	11.8	13.8	16.4
1.58	5.2	8.2	2220	9.11	10.33	1110	5.95	6.39	736	4.32	4.59	—	—	—	9.0	11.0	13.0	15.6
1.59	3.4	5.4	2204	4.33	5.22	1102	2.83	3.23	730	2.09	2.34	6.7	9.2	11.2	12.7	14.7	16.7	19.2
ARC-LENGTH CORRECTION FACTOR												0.71	0.77	0.80	0.83	0.86	0.88	0.91
1.59	4.4	7.0	2200	7.15	8.20	1100	4.60	5.02	729	3.35	3.61	—	—	9.1	10.6	12.6	14.6	17.1
1.60	3.0	4.8	2188	3.09	3.95	1094	2.10	2.49	725	1.58	1.83	7.5	10.0	12.0	13.5	15.5	17.5	20.0
1.60	4.0	6.4	2188	6.07	7.05	1094	3.91	4.31	725	2.85	3.11	—	7.9	9.9	11.4	13.4	15.4	17.9
1.61	3.6	5.8	2172	4.93	5.85	1086	3.20	3.59	720	2.35	2.60	—	8.7	10.7	12.2	14.2	16.2	18.7
1.61	5.6	9.0	2178	9.99	11.32	1089	6.61	7.07	722	4.80	5.07	—	—	—	10.0	12.1	14.6	17.1
ARC-LENGTH CORRECTION FACTOR												0.72	0.77	0.81	0.83	0.86	0.88	0.91

A = STANDARD V-BELT
 AX = COGGED/NOTCHED V-BELT
 + IF RIM SPEED EXCEEDS 6500 FEET PER MINUTE, CONSULT *Martin*.



Stock Drive Selection **A**

Nominal Center Distances And Arc-Length Correction Factor												Sheave Combination		Speed Ratio
A/AX Belt Length Designation												DriveR P. D.	DriveN P. D.	
55	60	68	75	80	85	90	96	105	112	120	128			
22.5	25.0	29.0	32.5	35.0	37.5	40.0	43.0	47.5	51.0	55.0	59.0	3.0	4.2	1.40
20.6	23.1	27.1	30.6	33.1	35.6	38.1	41.1	45.6	49.1	53.1	57.1	4.0	5.6	1.40
18.7	21.2	25.2	28.7	31.2	33.7	36.2	39.2	43.7	47.2	51.2	55.2	5.0	7.0	1.40
21.7	24.2	28.2	31.7	34.2	36.7	39.2	42.2	46.7	50.2	54.2	58.2	3.4	4.8	1.41
19.8	22.3	26.3	29.8	32.3	34.8	37.3	40.3	44.8	48.3	52.3	56.3	4.4	6.2	1.41
0.94	0.96	0.99	1.02	1.04	1.06	1.07	1.09	1.11	1.13	1.15	1.17			
17.9	20.4	24.4	27.9	30.4	32.9	35.4	38.4	42.9	46.4	50.4	54.4	5.4	7.6	1.41
17.1	19.6	23.6	27.1	29.6	32.1	34.6	37.6	42.1	45.6	49.6	53.6	5.8	8.2	1.41
16.0	18.5	22.5	26.0	28.5	31.0	33.5	36.5	41.0	44.5	48.5	52.5	6.4	9.0	1.41
20.9	23.4	27.4	30.9	33.4	35.9	38.4	41.4	45.9	49.4	53.4	57.4	3.8	5.4	1.42
20.1	22.6	26.6	30.1	32.6	35.1	37.6	40.6	45.1	48.6	52.6	56.6	4.2	6.0	1.43
0.93	0.96	0.99	1.02	1.04	1.05	1.07	1.09	1.11	1.13	1.15	1.17			
19.3	21.8	25.8	29.3	31.8	34.3	36.8	39.8	44.3	47.8	51.8	55.8	4.6	6.6	1.43
22.0	24.5	28.5	32.0	34.5	37.0	39.5	42.5	47.0	50.5	54.5	58.5	3.2	4.6	1.44
21.2	23.7	27.7	31.2	33.7	36.2	38.7	41.7	46.2	49.7	53.7	57.7	3.6	5.2	1.44
20.4	22.9	26.9	30.4	32.9	35.4	37.9	40.9	45.4	48.9	52.9	56.9	4.0	5.8	1.45
19.6	22.1	26.1	29.7	32.2	34.7	37.2	40.2	44.7	48.2	52.2	56.2	4.4	6.4	1.45
0.94	0.96	0.99	1.02	1.04	1.05	1.07	1.09	1.11	1.13	1.15	1.17			
16.2	18.7	22.7	26.2	28.7	31.2	33.7	36.7	41.2	44.7	48.7	52.7	6.2	9.0	1.45
18.9	21.4	25.4	28.9	31.4	33.9	36.4	39.4	43.9	47.4	51.4	55.4	4.8	7.0	1.46
18.1	20.6	24.6	28.1	30.6	33.1	35.6	38.6	43.1	46.6	50.6	54.6	5.2	7.6	1.46
17.3	19.8	23.8	27.3	29.8	32.3	34.8	37.8	42.3	45.8	49.8	53.8	5.6	8.2	1.46
22.3	24.8	28.8	32.3	34.8	37.3	39.8	42.8	47.3	50.8	54.8	58.8	3.0	4.4	1.47
0.94	0.96	0.99	1.02	1.04	1.05	1.07	1.09	1.11	1.13	1.15	1.17			
21.5	24.0	28.0	31.5	34.0	36.5	39.0	42.0	46.5	50.0	54.0	58.0	3.4	5.0	1.47
20.7	23.2	27.3	30.8	33.3	35.8	38.3	41.3	45.8	49.3	53.3	57.3	3.8	5.6	1.47
20.0	22.5	26.5	30.0	32.5	35.0	37.5	40.5	45.0	48.5	52.5	56.5	4.2	6.2	1.48
21.9	24.4	28.4	31.9	34.4	36.9	39.4	42.4	46.9	50.4	54.4	58.4	3.2	4.8	1.50
21.1	23.6	27.6	31.1	33.6	36.1	38.6	41.6	46.1	49.6	53.6	57.6	3.6	5.4	1.50
0.93	0.96	0.99	1.02	1.04	1.05	1.07	1.09	1.11	1.13	1.15	1.17			
20.3	22.8	26.8	30.3	32.8	35.3	37.8	40.8	45.3	48.8	52.8	56.8	4.0	6.0	1.50
19.5	22.0	26.0	29.5	32.0	34.5	37.0	40.0	44.5	48.0	52.0	56.0	4.4	6.6	1.50
16.3	18.8	22.8	26.3	28.8	31.3	33.8	36.8	41.3	44.8	48.8	52.8	6.0	9.0	1.50
14.2	16.7	20.7	24.3	26.8	29.3	31.8	34.8	39.3	42.8	46.8	50.8	7.0	10.6	1.51
19.8	22.3	26.3	29.8	32.3	34.8	37.3	40.3	44.8	48.3	52.3	56.3	4.2	6.4	1.52
0.93	0.96	0.99	1.02	1.04	1.05	1.07	1.09	1.11	1.13	1.15	1.17			
19.0	21.5	25.5	29.0	31.5	34.0	36.5	39.5	44.0	47.5	51.5	55.5	4.6	7.0	1.52
18.2	20.7	24.7	28.2	30.7	33.2	35.7	38.7	43.2	46.7	50.7	54.7	5.0	7.6	1.52
17.4	19.9	23.9	27.4	29.9	32.4	34.9	37.9	42.4	45.9	49.9	54.0	5.4	8.2	1.52
22.2	24.7	28.7	32.2	34.7	37.2	39.7	42.7	47.2	50.7	54.7	58.7	3.0	4.6	1.53
21.4	23.9	27.9	31.4	33.9	36.4	38.9	41.9	46.4	49.9	53.9	57.9	3.4	5.2	1.53
0.93	0.96	0.99	1.02	1.04	1.05	1.07	1.09	1.11	1.13	1.15	1.17			
20.6	23.1	27.1	30.6	33.1	35.6	38.1	41.1	45.6	49.1	53.1	57.1	3.8	5.8	1.53
20.1	22.6	26.6	30.1	32.6	35.1	37.6	40.6	45.1	48.6	52.6	56.6	4.0	6.2	1.55
16.4	19.0	23.0	26.5	29.0	31.5	34.0	37.0	41.5	45.0	49.0	53.0	5.8	9.0	1.55
21.7	24.2	28.2	31.7	34.2	36.7	39.2	42.2	46.7	50.2	54.2	58.2	3.2	5.0	1.56
20.9	23.4	27.4	30.9	33.4	35.9	38.4	41.4	45.9	49.4	53.4	57.4	3.6	5.6	1.56
0.93	0.96	0.99	1.02	1.04	1.05	1.07	1.09	1.11	1.13	1.15	1.17			
19.6	22.1	26.1	29.6	32.1	34.6	37.1	40.1	44.7	48.2	52.2	56.2	4.2	6.6	1.57
20.4	22.9	26.9	30.4	32.9	35.4	37.9	40.9	45.4	48.9	52.9	56.9	3.8	6.0	1.58
18.4	20.9	24.9	28.4	30.9	33.4	35.9	38.9	43.4	46.9	50.9	54.9	4.8	7.6	1.58
17.6	20.1	24.1	27.6	30.1	32.6	35.1	38.1	42.6	46.1	50.1	54.1	5.2	8.2	1.58
21.2	23.7	27.7	31.2	33.7	36.2	38.7	41.7	46.2	49.7	53.7	57.7	3.4	5.4	1.59
0.93	0.96	0.99	1.02	1.04	1.05	1.07	1.09	1.11	1.13	1.15	1.17			
19.2	21.7	25.7	29.2	31.7	34.2	36.7	39.7	44.2	47.7	51.7	55.7	4.4	7.0	1.59
22.0	24.5	28.5	32.0	34.5	37.0	39.5	42.5	47.0	50.5	54.5	58.5	3.0	4.8	1.60
19.9	22.4	26.5	30.0	32.5	35.0	37.5	40.5	45.0	48.5	52.5	56.5	4.0	6.4	1.60
20.7	23.2	27.2	30.7	33.2	35.7	38.3	41.3	45.8	49.3	53.3	57.3	3.6	5.8	1.61
16.6	19.1	23.1	26.6	29.1	31.6	34.1	37.1	41.6	45.2	49.2	53.2	5.6	9.0	1.61
0.93	0.96	0.99	1.02	1.04	1.05	1.07	1.09	1.11	1.13	1.15	1.17			

FOR BELT SIZES NOT SHOWN, INTERPOLATE FOR ADDITIONAL CENTER DISTANCE.

V-BELT DRIVES

A Stock Drive Selection



V-BELT DRIVES

Speed Ratio	Sheave Combination		DriveN Speeds and HP Per Belt									Nominal Center Distance And Arc-Length Correction Factor						
			3500 RPM DriveR			1750 RPM DriveR			1160 RPM DriveR									
	DriveR P.D.	DriveN P.D.	DriveN RPM	HP Per Belt A	HP Per Belt AX	DriveN RPM	HP Per Belt A	HP Per Belt AX	DriveN RPM	HP Per Belt A	HP Per Belt AX	A/AX Belt Length Designation						
												26	31	35	38	42	46	51
1.61	6.6	10.6	2179	11.81	13.49	1090	8.19	8.69	722	5.96	6.25	—	—	—	—	—	—	
1.62	3.2	5.2	2154	3.72	4.60	1077	2.47	2.86	714	1.84	2.09	7.0	9.5	11.5	13.0	15.0	17.0	19.5
1.63	3.8	6.2	2145	5.52	6.46	1073	3.56	3.96	711	2.60	2.86	—	8.2	10.2	11.7	13.7	15.8	18.3
1.64	5.0	8.2	2134	8.66	9.83	1067	5.63	6.06	707	4.08	4.35	—	—	—	9.1	11.2	13.2	15.7
1.65	3.4	5.6	2125	4.34	5.24	1062	2.84	3.23	704	2.10	2.35	6.5	9.0	11.0	12.5	14.5	16.5	19.0
ARC-LENGTH CORRECTION FACTOR												0.72	0.77	0.80	0.83	0.86	0.88	0.91
1.65	4.0	6.6	2121	6.09	7.06	1061	3.91	4.32	703	2.85	3.11	—	7.7	9.7	11.2	13.3	15.3	17.8
1.65	4.6	7.6	2118	7.69	8.77	1059	4.95	5.37	702	3.60	3.86	—	—	8.4	10.0	12.0	14.0	16.5
1.66	6.4	10.6	2113	11.50	13.10	1057	7.89	8.37	700	5.74	6.02	—	—	—	—	—	10.1	12.6
1.67	3.0	5.0	2100	3.11	3.96	1050	2.11	2.50	696	1.58	1.83	7.3	9.8	11.8	13.3	15.3	17.3	19.8
1.67	3.6	6.0	2100	4.95	5.86	1050	3.20	3.60	696	2.35	2.61	—	8.5	10.5	12.1	14.1	16.1	18.6
ARC-LENGTH CORRECTION FACTOR												0.72	0.77	0.80	0.83	0.86	0.88	0.91
1.67	4.2	7.0	2100	6.64	7.65	1050	4.27	4.67	696	3.11	3.36	—	7.2	9.2	10.8	12.8	14.8	17.3
1.67	5.4	9.0	2100	9.58	10.85	1050	6.29	6.74	696	4.57	4.83	—	—	—	10.2	12.2	14.7	—
1.68	3.8	6.4	2078	5.53	6.47	1039	3.56	3.96	689	2.61	2.86	—	8.0	10.1	11.6	13.6	15.6	18.1
1.69	3.2	5.4	2074	3.74	4.61	1037	2.48	2.87	687	1.84	2.09	6.8	9.3	11.3	12.8	14.9	16.9	19.4
1.71	3.4	5.8	2052	4.36	5.25	1026	2.85	3.24	680	2.10	2.35	6.3	8.8	10.9	12.4	14.4	16.4	18.9
ARC-LENGTH CORRECTION FACTOR												0.71	0.77	0.80	0.83	0.85	0.88	0.91
1.71	4.8	8.2	2049	8.20	9.32	1024	5.30	5.72	679	3.85	4.11	—	—	—	9.3	11.3	13.3	15.8
1.71	6.2	10.6	2047	11.17	12.69	1024	7.58	8.06	678	5.51	5.79	—	—	—	—	—	10.2	12.8
1.71	7.0	12.0	2042	12.41	14.26	1021	8.80	9.32	677	6.43	6.72	—	—	—	—	—	—	—
1.72	3.6	6.2	2032	4.96	5.87	1016	3.21	3.60	674	2.36	2.61	—	8.4	10.4	11.9	13.9	15.9	18.4
1.73	3.0	5.2	2019	3.12	3.97	1010	2.11	2.50	669	1.59	1.84	7.1	9.6	11.7	13.2	15.2	17.2	19.7
ARC-LENGTH CORRECTION FACTOR												0.71	0.77	0.80	0.83	0.85	0.88	0.91
1.73	4.4	7.6	2026	7.19	8.23	1013	4.62	5.03	672	3.36	3.62	—	—	8.6	10.1	12.1	14.1	16.6
1.73	5.2	9.0	2022	9.15	10.36	1011	5.97	6.41	670	4.33	4.60	—	—	—	10.3	12.4	14.9	—
1.74	3.8	6.6	2015	5.54	6.48	1008	3.57	3.97	668	2.61	2.86	—	7.9	9.9	11.4	13.4	15.4	17.9
1.75	3.2	5.6	2000	3.75	4.62	1000	2.48	2.88	663	1.85	2.10	6.6	9.2	11.2	12.7	14.7	16.7	19.2
1.75	4.0	7.0	2000	6.11	7.08	1000	3.92	4.33	663	2.86	3.12	—	7.4	9.4	10.9	12.9	14.9	17.4
ARC-LENGTH CORRECTION FACTOR												0.71	0.76	0.80	0.82	0.85	0.88	0.91
1.76	3.4	6.0	1983	4.37	5.26	992	2.85	3.24	657	2.10	2.35	—	8.7	10.7	12.2	14.2	16.2	18.7
1.77	6.0	10.6	1981	10.81	12.27	991	7.27	7.74	657	5.28	5.55	—	—	—	—	—	10.4	12.9
1.78	3.6	6.4	1969	4.97	5.88	984	3.21	3.61	652	2.36	2.61	—	8.2	10.2	11.7	13.7	15.7	18.2
1.78	4.6	8.2	1963	7.71	8.79	982	4.97	5.38	651	3.61	3.86	—	—	—	9.4	11.5	13.5	16.0
1.80	3.0	5.4	1944	3.13	3.98	972	2.12	2.51	644	1.59	1.84	6.9	9.5	11.5	13.0	15.0	17.0	19.5
ARC-LENGTH CORRECTION FACTOR												0.71	0.76	0.80	0.82	0.85	0.88	0.91
1.80	5.0	9.0	1944	8.69	9.86	972	5.64	6.07	644	4.09	4.36	—	—	—	10.5	12.5	15.0	—
1.81	3.2	5.8	1931	3.76	4.63	966	2.49	2.88	640	1.85	2.10	6.5	9.0	11.0	12.5	14.5	16.5	19.0
1.81	4.2	7.6	1934	6.67	7.67	967	4.28	4.69	641	3.11	3.37	—	—	8.7	10.2	12.3	14.3	16.8
1.82	3.4	6.2	1919	4.37	5.26	960	2.86	3.25	636	2.11	2.36	—	8.5	10.5	12.0	14.0	16.0	18.6
1.82	6.6	12.0	1925	11.85	13.53	962	8.21	8.71	638	5.98	6.26	—	—	—	—	—	—	11.2
ARC-LENGTH CORRECTION FACTOR												0.70	0.76	0.80	0.82	0.85	0.88	0.91
1.83	3.6	6.6	1909	4.97	5.89	955	3.22	3.61	633	2.36	2.61	—	8.0	10.0	11.5	13.6	15.6	18.1
1.83	5.8	10.6	1915	10.44	11.82	958	6.96	7.42	635	5.05	5.32	—	—	—	—	—	10.5	13.0
1.84	3.8	7.0	1900	5.56	6.50	950	3.58	3.97	630	2.61	2.87	—	7.5	9.5	11.1	13.1	15.1	17.6
1.86	4.4	8.2	1878	7.21	8.24	939	4.63	5.04	622	3.36	3.62	—	—	8.0	9.6	11.6	13.6	16.1
1.87	3.0	5.6	1875	3.14	3.99	938	2.12	2.51	621	1.59	1.84	6.8	9.3	11.3	12.8	14.8	16.8	19.4
ARC-LENGTH CORRECTION FACTOR												0.70	0.76	0.80	0.82	0.85	0.88	0.91
1.88	3.2	6.0	1867	3.77	4.64	933	2.49	2.88	619	1.85	2.10	6.3	8.8	10.8	12.3	14.4	16.4	18.9
1.88	3.4	6.4	1859	4.38	5.27	930	2.86	3.25	616	2.11	2.36	—	8.3	10.3	11.9	13.9	15.9	18.4
1.88	4.8	9.0	1867	8.22	9.34	933	5.31	5.74	619	3.85	4.11	—	—	—	8.6	10.6	12.6	15.2
1.88	6.4	12.0	1867	11.54	13.13	933	7.90	8.39	619	5.75	6.03	—	—	—	—	—	—	11.4
1.89	5.6	10.6	1849	10.04	11.36	925	6.64	7.09	613	4.81	5.08	—	—	—	—	—	10.6	13.2
ARC-LENGTH CORRECTION FACTOR												0.70	0.76	0.79	0.82	0.85	0.88	0.91
1.89	7.0	13.2	1856	12.43	14.28	928	8.82	9.34	615	6.43	6.73	—	—	—	—	—	—	—
1.90	4.0	7.6	1842	6.13	7.10	921	3.93	4.34	611	2.87	3.12	—	—	8.9	10.4	12.4	14.4	16.9
1.93	3.0	5.8	1810	3.15	4.00	905	2.13	2.51	600	1.59	1.84	6.6	9.1	11.2	12.7	14.7	16.7	19.2
1.94	3.2	6.2	1806	3.78	4.64	903	2.50	2.89	599	1.85	2.10	—	8.6	10.7	12.2	14.2	16.2	18.7
1.94	3.4	6.6	1803	4.39	5.28	902	2.86	3.25	598	2.11	2.36	—	8.1	10.2	11.7	13.7	15.7	18.2
ARC-LENGTH CORRECTION FACTOR												0.70	0.76	0.80	0.82	0.85	0.88	0.91

A = STANDARD V-BELT
 AX = COGGED/NOTCHED V-BELT
 + IF RIM SPEED EXCEEDS 6500 FEET PER MINUTE, CONSULT *Martin*.



Stock Drive Selection **A**

V-BELT DRIVES

Nominal Center Distances And Arc-Length Correction Factor												Sheave Combination		Speed Ratio
A/AX Belt Length Designation												DriveR P. D.	DriveN P. D.	
55	60	68	75	80	85	90	96	105	112	120	128			
14.5	17.0	21.0	24.6	27.1	29.6	32.1	35.1	39.6	43.1	47.1	51.1	6.6	10.6	1.61
21.5	24.0	28.0	31.5	34.0	36.5	39.0	42.0	46.5	50.0	54.0	58.0	3.2	5.2	1.62
20.3	22.8	26.8	30.3	32.8	35.3	37.8	40.8	45.3	48.8	52.8	56.8	3.8	6.2	1.63
17.7	20.2	24.2	27.7	30.2	32.7	35.2	38.2	42.8	46.3	50.3	54.3	5.0	8.2	1.64
21.1	23.6	27.6	31.1	33.6	36.1	38.6	41.6	46.1	49.6	53.6	57.6	3.4	5.6	1.65
0.93	0.96	0.99	1.02	1.04	1.05	1.07	1.09	1.11	1.13	1.15	1.17			
19.8	22.3	26.3	29.8	32.3	34.8	37.3	40.3	44.8	48.3	52.3	56.3	4.0	6.6	1.65
18.5	21.0	25.0	28.5	31.0	33.5	36.0	39.0	43.5	47.0	51.0	55.0	4.6	7.6	1.65
14.6	17.2	21.2	24.7	27.2	29.7	32.2	35.2	39.7	43.2	47.3	51.3	6.4	10.6	1.66
21.8	24.3	28.3	31.9	34.4	36.9	39.4	42.4	46.9	50.4	54.4	58.4	3.0	5.0	1.67
20.6	23.1	27.1	30.6	33.1	35.6	38.1	41.1	45.6	49.1	53.1	57.1	3.6	6.0	1.67
0.93	0.96	0.99	1.02	1.04	1.05	1.07	1.09	1.11	1.13	1.15	1.17			
19.3	21.8	25.8	29.3	31.8	34.3	36.8	39.8	44.3	47.8	51.8	55.8	4.2	7.0	1.67
16.7	19.3	23.3	26.8	29.3	31.8	34.3	37.3	41.8	45.3	49.3	53.3	5.4	9.0	1.67
20.1	22.6	26.6	30.1	32.6	35.1	37.6	40.6	45.1	48.6	52.6	56.6	3.8	6.4	1.68
21.4	23.9	27.9	31.4	33.9	36.4	38.9	41.9	46.4	49.9	53.9	57.9	3.2	6.4	1.69
20.9	23.4	27.4	30.9	33.4	35.9	38.4	41.4	45.9	49.4	53.4	57.4	3.4	5.8	1.71
0.93	0.95	0.99	1.02	1.03	1.05	1.07	1.09	1.11	1.13	1.15	1.16			
17.9	20.4	24.4	27.9	30.4	32.9	35.4	38.4	42.9	46.4	50.4	54.4	4.8	8.2	1.71
14.8	17.3	21.3	24.9	27.4	29.9	32.4	35.4	39.9	43.4	47.4	51.4	6.2	10.6	1.71
13.0	15.5	19.6	23.1	25.6	28.1	30.6	33.6	38.1	41.7	45.7	49.7	7.0	12.0	1.71
20.4	22.9	26.9	30.4	32.9	35.4	37.9	40.9	45.4	48.9	52.9	56.9	3.6	6.2	1.72
21.7	24.2	28.2	31.7	34.2	36.7	39.2	42.2	46.7	50.2	54.2	58.2	3.0	5.2	1.73
0.93	0.96	0.99	1.02	1.04	1.05	1.07	1.09	1.11	1.13	1.15	1.16			
18.7	21.2	25.2	28.7	31.2	33.7	36.2	39.2	43.7	47.2	51.2	55.2	4.4	7.6	1.73
16.9	19.4	23.4	26.9	29.4	31.9	34.4	37.4	42.0	45.5	49.5	53.5	5.2	9.0	1.73
19.9	22.4	26.4	29.9	32.5	35.0	37.5	40.5	45.0	48.5	52.5	56.5	3.8	6.6	1.74
21.2	23.7	27.7	31.2	33.7	36.2	38.7	41.7	46.2	49.7	53.7	57.7	3.2	5.6	1.75
19.5	22.0	26.0	29.5	32.0	34.5	37.0	40.0	44.5	48.0	52.0	56.0	4.0	7.0	1.75
0.93	0.95	0.99	1.02	1.03	1.05	1.07	1.08	1.11	1.13	1.15	1.16			
20.7	23.2	27.2	30.7	33.2	35.7	38.2	41.2	45.7	49.3	53.3	57.3	3.4	6.0	1.76
14.9	17.5	21.5	25.0	27.5	30.0	32.5	35.5	40.0	43.6	47.6	51.6	6.0	10.6	1.77
20.2	22.8	26.8	30.3	32.8	35.3	37.8	40.8	45.3	48.8	52.8	56.8	3.6	6.4	1.78
18.0	20.5	24.5	28.0	30.5	33.0	35.6	38.6	43.1	46.6	50.6	54.6	4.6	8.2	1.78
21.5	24.0	28.0	31.5	34.0	36.5	39.0	42.0	46.5	50.0	54.0	58.0	3.0	5.4	1.80
0.93	0.95	0.99	1.02	1.03	1.05	1.07	1.08	1.11	1.13	1.15	1.16			
17.0	19.6	23.6	27.1	29.6	32.1	34.6	37.6	42.1	45.6	49.6	53.6	5.0	9.0	1.80
21.0	23.5	27.6	31.1	33.6	36.1	38.6	41.6	46.1	49.6	53.6	57.6	3.2	5.8	1.81
18.8	21.3	25.3	28.8	31.3	33.8	36.3	39.3	43.8	47.4	51.4	55.4	4.2	7.6	1.81
20.6	23.1	27.1	30.6	33.1	35.6	38.1	41.1	45.6	49.1	53.1	57.1	3.4	6.2	1.82
13.3	15.8	19.9	23.4	25.9	28.4	30.9	33.9	38.4	42.0	46.0	50.0	6.6	12.0	1.82
0.93	0.95	0.99	1.02	1.03	1.05	1.07	1.08	1.11	1.13	1.15	1.16			
20.1	22.6	26.6	30.1	32.6	35.1	37.6	40.6	45.1	48.6	52.6	56.6	3.6	6.6	1.83
15.1	17.6	21.6	25.2	27.7	30.2	32.7	35.7	40.2	43.7	47.7	51.7	5.8	10.6	1.83
19.6	22.1	26.1	29.6	32.1	34.6	37.1	40.1	44.6	48.1	52.1	56.1	3.8	7.0	1.84
18.2	20.7	24.7	28.2	30.7	33.2	35.7	38.7	43.2	46.7	50.7	54.7	4.4	8.2	1.86
21.4	23.9	27.9	31.4	33.9	36.4	38.9	41.9	46.4	49.9	53.9	57.9	3.0	5.6	1.87
0.93	0.95	0.99	1.02	1.03	1.05	1.07	1.08	1.11	1.13	1.15	1.16			
20.9	23.4	27.4	30.9	33.4	35.9	38.4	41.4	45.9	49.4	53.4	57.4	3.2	6.0	1.88
20.4	22.9	26.9	30.4	32.9	35.4	37.9	40.9	45.4	48.9	52.9	56.9	3.4	6.4	1.88
17.2	19.7	23.7	27.2	29.7	32.2	34.7	37.8	42.3	45.8	49.8	53.8	4.8	9.0	1.88
13.4	16.0	20.0	23.5	26.0	28.6	31.1	34.1	38.6	42.1	46.1	50.1	6.4	12.0	1.88
15.2	17.8	21.8	25.3	27.8	30.3	32.8	35.8	40.3	43.9	47.9	51.9	5.6	10.6	1.89
0.93	0.95	0.99	1.01	1.03	1.05	1.07	1.08	1.11	1.13	1.15	1.16			
11.9	14.5	18.5	22.1	24.6	27.1	29.6	32.6	37.2	40.7	44.7	48.7	7.0	13.2	1.89
19.0	21.5	25.5	29.0	31.5	34.0	36.5	39.5	44.0	47.5	51.5	55.5	4.0	7.6	1.90
21.2	23.7	27.7	31.2	33.7	36.2	38.7	41.7	46.2	49.7	53.7	57.7	3.0	5.8	1.93
20.7	23.2	27.2	30.7	33.2	35.7	38.2	41.2	45.7	49.2	53.2	57.2	3.2	6.2	1.94
20.2	22.7	26.7	30.3	32.8	35.3	37.8	40.8	45.3	48.8	52.8	56.8	3.4	6.6	1.94
0.93	0.95	0.99	1.01	1.03	1.05	1.07	1.08	1.11	1.13	1.15	1.16			

FOR BELT SIZES NOT SHOWN, INTERPOLATE FOR ADDITIONAL CENTER DISTANCE.

A Stock Drive Selection



V-BELT DRIVES

Speed Ratio	Sheave Combination		DriveN Speeds and HP Per Belt									Nominal Center Distance And Arc-Length Correction Factor						
			3500 RPM DriveR			1750 RPM DriveR			1160 RPM DriveR									
	DriveR P.D.	DriveN P.D.	DriveN RPM	HP Per Belt A	HP Per Belt AX	DriveN RPM	HP Per Belt A	HP Per Belt AX	DriveN RPM	HP Per Belt A	HP Per Belt AX	A/AX Belt Length Designation						
												26	31	35	38	42	46	51
1.94	3.6	7.0	1800	4.98	5.90	900	3.22	3.62	597	2.37	2.62	—	7.6	9.7	11.2	13.2	15.2	17.7
1.94	6.2	12.8	1808	11.20	12.72	904	7.59	8.07	599	5.52	5.80	—	—	—	—	—	—	11.5
1.95	4.2	8.2	1793	6.68	7.68	896	4.29	4.69	594	3.12	3.37	—	—	8.2	9.7	11.7	13.8	16.3
1.96	4.6	9.0	1789	7.73	8.81	894	4.98	5.39	593	3.61	3.87	—	—	—	8.7	10.7	12.8	15.3
1.96	5.4	10.6	1783	9.62	10.89	892	6.31	6.76	591	4.58	4.85	—	—	—	—	—	10.8	13.3
ARC-LENGTH CORRECTION FACTOR												0.0	0.74	0.78	0.81	0.84	0.87	0.90
2.00	3.0	6.0	1750	3.16	4.00	875	2.13	2.52	580	1.60	1.85	6.4	9.0	11.0	12.5	14.5	16.5	19.0
2.00	3.2	6.4	1750	3.78	4.65	875	2.50	2.89	580	1.86	2.11	—	8.5	10.5	12.0	14.0	16.0	18.5
2.00	3.8	7.6	1750	5.57	6.51	875	3.58	3.98	580	2.62	2.87	—	—	9.0	10.5	12.6	14.6	17.1
2.00	6.0	12.0	1750	10.84	12.29	875	7.28	7.75	580	5.29	5.56	—	—	—	—	—	—	11.6
2.00	6.6	13.2	1750	11.87	13.54	875	8.22	8.71	580	5.98	6.27	—	—	—	—	—	—	—
ARC-LENGTH CORRECTION FACTOR												0.69	0.75	0.79	0.82	0.85	0.87	0.90
2.04	5.2	10.6	1717	9.18	10.40	858	5.99	6.42	569	4.34	4.61	—	—	—	—	—	10.9	13.5
2.05	4.0	8.2	1707	6.14	7.11	854	3.94	4.34	566	2.87	3.13	—	—	8.3	9.8	11.9	13.9	16.4
2.05	4.4	9.0	1711	7.22	8.26	856	4.64	5.05	567	3.37	3.63	—	—	—	8.8	10.9	12.9	15.5
2.06	3.2	6.6	1697	3.79	4.65	848	2.50	2.89	562	1.86	2.11	—	8.3	10.3	11.8	13.8	15.9	18.4
2.06	3.4	7.0	1700	4.40	5.29	850	2.87	3.26	563	2.11	2.36	—	7.8	9.8	11.3	13.4	15.4	17.9
ARC-LENGTH CORRECTION FACTOR												0.0	0.75	0.79	0.81	0.84	0.87	0.90
2.06	6.4	13.2	1697	11.55	13.15	848	7.91	8.40	562	5.75	6.03	—	—	—	—	—	—	—
2.07	3.0	6.2	1694	3.16	4.01	847	2.13	2.52	561	1.60	1.85	6.2	8.8	10.8	12.3	14.3	16.3	18.9
2.07	5.8	12.0	1692	10.46	11.84	846	6.97	7.43	561	5.06	5.33	—	—	—	—	—	—	11.8
2.11	3.6	7.6	1658	5.00	5.91	829	3.23	3.62	549	2.37	2.62	—	—	9.1	10.7	12.7	14.7	17.2
2.12	5.0	10.6	1651	8.72	9.89	825	5.66	6.09	547	4.10	4.37	—	—	—	—	—	11.0	13.6
ARC-LENGTH CORRECTION FACTOR												0.69	0.75	0.79	0.82	0.85	0.87	0.90
2.13	3.0	6.4	1641	3.16	4.01	820	2.14	2.52	544	1.60	1.85	—	8.6	10.6	12.1	14.2	16.2	18.7
2.13	6.2	13.2	1644	11.21	12.73	822	7.60	8.08	545	5.52	5.80	—	—	—	—	—	—	—
2.14	4.2	9.0	1633	6.70	7.70	817	4.29	4.70	541	3.12	3.38	—	—	9.0	11.0	13.1	15.6	—
2.14	5.6	12.0	1633	10.06	11.38	817	6.65	7.10	541	4.82	5.09	—	—	—	—	—	—	11.9
2.14	7.0	15.0	1633	12.45	14.30	817	8.83	9.35	541	6.44	6.73	—	—	—	—	—	—	—
ARC-LENGTH CORRECTION FACTOR												0.0	0.75	0.79	0.81	0.84	0.87	0.90
2.16	3.8	8.2	1622	5.58	6.52	811	3.59	3.99	538	2.62	2.88	—	—	8.4	10.0	12.0	14.1	16.6
2.19	3.2	7.0	1600	3.79	4.66	800	2.51	2.89	530	1.86	2.11	—	7.9	10.0	11.5	13.5	15.5	18.0
2.20	3.0	6.6	1591	3.17	4.01	795	2.14	2.52	527	1.60	1.85	—	8.4	10.5	12.0	14.0	16.0	18.5
2.20	6.0	13.2	1591	10.85	12.30	795	7.29	7.76	527	5.29	5.57	—	—	—	—	—	—	—
2.21	4.8	10.6	1585	8.25	9.37	792	5.32	5.75	525	3.86	4.12	—	—	—	—	—	11.2	13.7
ARC-LENGTH CORRECTION FACTOR												0.0	0.74	0.78	0.81	0.84	0.87	0.90
2.22	5.4	12.0	1575	9.64	10.90	787	6.32	6.77	522	4.58	4.85	—	—	—	—	—	—	12.0
2.23	7.0	15.6	1571	12.46	14.31	785	8.83	9.35	521	6.44	6.73	—	—	—	—	—	—	—
2.24	3.4	7.6	1566	4.41	5.29	783	2.87	3.26	519	2.12	2.37	—	7.2	9.3	10.8	12.8	14.9	17.4
2.25	4.0	9.0	1556	6.15	7.12	778	3.94	4.35	516	2.88	3.13	—	—	9.1	11.2	13.2	15.7	—
2.27	6.6	15.0	1540	11.88	13.56	770	8.22	8.72	510	5.99	6.27	—	—	—	—	—	—	—
ARC-LENGTH CORRECTION FACTOR												0.0	0.72	0.77	0.80	0.83	0.86	0.89
2.28	3.6	8.2	1537	5.01	5.92	768	3.23	3.63	509	2.37	2.62	—	—	8.6	10.1	12.2	14.2	16.7
2.28	5.8	13.2	1538	10.47	11.86	769	6.97	7.43	510	5.06	5.33	—	—	—	—	—	—	—
2.30	4.6	10.6	1519	7.75	8.83	759	4.99	5.40	503	3.62	3.88	—	—	—	9.2	11.3	13.9	—
2.31	5.2	12.0	1517	9.20	10.41	758	6.00	6.43	503	4.35	4.61	—	—	—	—	—	—	12.2
2.33	3.0	7.0	1500	3.17	4.02	750	2.14	2.53	497	1.60	1.85	—	8.0	10.1	11.6	13.6	15.7	18.2
ARC-LENGTH CORRECTION FACTOR												0.0	0.73	0.78	0.80	0.84	0.86	0.90
2.34	6.4	15.0	1493	11.57	13.16	747	7.92	8.40	495	5.76	6.04	—	—	—	—	—	—	—
2.36	5.6	13.2	1485	10.07	11.39	742	6.65	7.10	492	4.82	5.09	—	—	—	—	—	—	—
2.36	6.6	15.6	1481	11.89	13.56	740	8.23	8.72	491	5.99	6.27	—	—	—	—	—	—	—
2.37	3.2	7.6	1474	3.80	4.67	737	2.51	2.90	488	1.86	2.11	—	7.3	9.4	10.9	13.0	15.0	17.5
2.37	3.8	9.0	1478	5.59	6.53	739	3.59	3.99	490	2.63	2.88	—	—	—	9.2	11.3	13.3	15.9
ARC-LENGTH CORRECTION FACTOR												0.0	0.72	0.77	0.80	0.83	0.86	0.89
2.40	5.0	12.0	1458	8.74	9.90	729	5.66	6.09	483	4.11	4.37	—	—	—	—	—	—	12.3
2.41	3.4	8.2	1451	4.42	5.30	726	2.88	3.27	481	2.12	2.37	—	—	8.7	10.3	12.3	14.3	16.9
2.41	4.4	10.6	1453	7.24	8.28	726	4.65	5.06	482	3.37	3.63	—	—	—	9.4	11.4	14.0	—
2.42	6.2	15.0	1447	11.23	12.75	723	7.61	8.08	479	5.53	5.81	—	—	—	—	—	—	—
2.44	5.4	13.2	1432	9.65	10.91	716	6.33	6.77	475	4.59	4.85	—	—	—	—	—	—	—
ARC-LENGTH CORRECTION FACTOR												0.0	0.0	0.76	0.79	0.82	0.85	0.89

A = STANDARD V-BELT
 AX = COGGED/NOTCHED V-BELT
 + IF RIM SPEED EXCEEDS 6500 FEET PER MINUTE, CONSULT *Martin*.



Stock Drive Selection **A**

V-BELT DRIVES

Nominal Center Distances And Arc-Length Correction Factor												Sheave Combination		Speed Ratio
A/AX Belt Length Designation												DriveR P. D.	DriveN P. D.	
55	60	68	75	80	85	90	96	105	112	120	128			
19.8	22.3	26.3	29.8	32.3	34.8	37.3	40.3	44.8	48.3	52.3	56.3	3.6	7.0	1.94
13.5	16.1	20.1	23.7	26.2	28.7	31.2	34.2	38.7	42.3	46.3	50.3	6.2	12.0	1.94
18.3	20.8	24.8	28.3	30.8	33.4	35.9	38.9	43.4	46.9	50.9	54.9	4.2	8.2	1.95
17.3	19.8	23.9	27.4	29.9	32.4	34.9	37.9	42.4	45.9	49.9	53.9	4.6	9.0	1.96
15.4	17.9	21.9	25.5	28.0	30.5	33.0	36.0	40.5	44.0	48.0	52.0	5.4	10.6	1.96
0.92	0.95	0.98	1.01	1.03	1.05	1.06	1.08	1.11	1.12	1.14	1.16			
21.0	23.5	27.5	31.0	33.5	36.1	38.6	41.6	46.1	49.6	53.6	57.6	3.0	6.0	2.00
20.5	23.1	27.1	30.6	33.1	35.6	38.1	41.1	45.6	49.1	53.1	57.1	3.2	6.4	2.00
19.1	21.6	25.6	29.1	31.6	34.1	36.6	39.7	44.2	47.7	51.7	55.7	3.8	7.6	2.00
13.7	16.2	20.3	23.8	26.3	28.9	31.4	34.4	38.9	42.4	46.4	50.4	6.0	12.0	2.00
12.2	14.7	18.8	22.4	24.9	27.4	29.9	32.9	37.5	41.0	45.0	49.0	6.6	13.2	2.00
0.93	0.95	0.99	1.01	1.03	1.05	1.06	1.08	1.11	1.13	1.14	1.16			
15.5	18.0	22.1	25.6	28.1	30.6	33.1	36.1	40.7	44.2	48.2	52.2	5.2	10.6	2.04
18.4	21.0	25.0	28.5	31.0	33.5	36.0	39.0	43.5	47.0	51.0	55.0	4.0	8.2	2.05
17.5	20.0	24.0	27.5	30.0	32.5	35.1	38.1	42.6	46.1	50.1	54.1	4.4	9.0	2.05
20.4	22.9	26.9	30.4	32.9	35.4	37.9	40.9	45.4	48.9	52.9	56.9	3.2	6.6	2.06
19.9	22.4	26.4	29.9	32.4	34.9	37.4	40.4	44.9	48.4	52.5	56.5	3.4	7.0	2.06
0.92	0.95	0.98	1.01	1.03	1.05	1.06	1.08	1.11	1.12	1.14	1.16			
12.3	14.9	19.0	22.5	25.0	27.5	30.1	33.1	37.6	41.1	45.1	49.1	6.4	13.2	2.06
20.9	23.4	27.4	30.9	33.4	35.9	38.4	41.4	45.9	49.4	53.4	57.4	3.0	6.2	2.07
13.8	16.4	20.4	24.0	26.5	29.0	31.5	34.5	39.0	42.6	46.6	50.6	5.8	12.0	2.07
19.2	21.8	25.8	29.3	31.8	34.3	36.8	39.8	44.3	47.8	51.8	55.8	3.6	7.6	2.11
15.6	18.2	22.2	25.7	28.3	30.8	33.3	36.3	40.8	44.3	48.3	52.3	5.0	10.6	2.12
0.92	0.95	0.98	1.01	1.03	1.05	1.06	1.08	1.11	1.12	1.14	1.16			
20.7	23.2	27.2	30.7	33.2	35.7	38.2	41.2	45.7	49.2	53.2	57.2	3.0	6.4	2.13
12.4	15.0	19.1	22.6	25.2	27.7	30.2	33.2	37.8	41.3	45.3	49.3	6.2	13.2	2.13
17.6	20.1	24.2	27.7	30.2	32.7	35.2	38.2	42.7	46.2	50.2	54.2	4.2	9.0	2.14
14.0	16.5	20.6	24.1	26.6	29.2	31.7	34.7	39.2	42.7	46.7	50.7	5.6	12.0	2.14
—	12.7	16.9	20.5	23.0	25.6	28.1	31.1	35.6	39.2	43.2	47.2	7.0	15.0	2.14
0.92	0.95	0.98	1.01	1.03	1.05	1.06	1.08	1.11	1.12	1.14	1.16			
18.6	21.1	25.1	28.6	31.1	33.7	36.2	39.2	43.7	47.2	51.2	55.2	3.8	8.2	2.16
20.0	22.6	26.6	30.1	32.6	35.1	37.6	40.6	45.1	48.6	52.6	56.6	3.2	7.0	2.19
20.5	23.0	27.1	30.6	33.1	35.6	38.1	41.1	45.6	49.1	53.1	57.1	3.0	6.6	2.20
12.6	15.1	19.2	22.8	25.3	27.8	30.4	33.4	37.9	41.4	45.4	49.4	6.0	13.2	2.20
15.8	18.3	22.4	25.9	28.4	30.9	33.4	36.4	41.0	44.5	48.5	52.5	4.8	10.6	2.21
0.92	0.94	0.98	1.01	1.03	1.04	1.06	1.08	1.10	1.12	1.14	1.16			
14.1	16.7	20.7	24.3	26.8	29.3	31.8	34.8	39.3	42.9	46.9	50.9	5.4	12.0	2.22
—	—	16.3	19.9	22.5	25.0	27.6	30.6	35.1	38.7	42.7	46.7	7.0	15.6	2.23
19.4	21.9	25.9	29.4	31.9	34.4	37.0	40.0	44.5	48.0	52.0	56.0	3.4	7.6	2.24
17.8	20.3	24.3	27.8	30.3	32.8	35.4	38.4	42.9	46.4	50.4	54.4	4.0	9.0	2.25
—	13.0	17.2	20.8	23.3	25.8	28.4	31.4	35.9	39.5	43.5	47.5	6.6	15.0	2.27
0.92	0.94	0.98	1.01	1.03	1.04	1.06	1.08	1.10	1.12	1.14	1.16			
18.7	21.3	25.3	28.8	31.3	33.8	36.3	39.3	43.8	47.3	51.3	55.3	3.6	8.2	2.28
12.7	15.3	19.4	22.9	25.5	28.0	30.5	33.5	38.0	41.6	45.6	49.6	5.8	13.2	2.28
15.9	18.5	22.5	26.0	28.6	31.1	33.6	36.6	41.1	44.6	48.6	52.6	4.6	10.6	2.30
14.2	16.8	20.9	24.4	26.9	29.4	32.0	35.0	39.5	43.0	47.0	51.0	5.2	12.0	2.31
20.2	22.7	26.7	30.2	32.7	35.2	37.7	40.7	45.3	48.8	52.8	56.8	3.0	7.0	2.33
0.92	0.94	0.98	1.01	1.03	1.04	1.06	1.08	1.10	1.12	1.14	1.16			
—	13.1	17.3	20.9	23.4	26.0	28.5	31.5	36.1	39.6	43.6	47.6	6.4	15.0	2.34
12.8	15.4	19.5	23.1	25.6	28.1	30.6	33.7	38.2	41.7	45.7	49.7	5.6	13.2	2.36
—	—	16.6	20.2	22.8	25.3	27.9	30.9	35.4	39.0	43.0	47.0	6.6	15.6	2.36
19.5	22.1	26.1	29.6	32.1	34.6	37.1	40.1	44.6	48.1	52.1	56.1	3.2	7.6	2.37
17.9	20.4	24.5	28.0	30.5	33.0	35.5	38.5	43.0	46.5	50.5	54.5	3.8	9.0	2.37
0.91	0.94	0.98	1.01	1.02	1.04	1.06	1.08	1.10	1.12	1.14	1.16			
14.4	16.9	21.0	24.5	27.1	29.6	32.1	35.1	39.6	43.2	47.2	51.2	5.0	12.0	2.40
18.9	21.4	25.4	28.9	31.4	34.0	36.5	39.5	44.0	47.5	51.5	55.5	3.4	8.2	2.41
16.1	18.6	22.7	26.2	28.7	31.2	33.7	36.7	41.3	44.8	48.8	52.8	4.4	10.6	2.41
—	13.3	17.4	21.0	23.6	26.1	28.7	31.7	36.2	39.8	43.8	47.8	6.2	15.0	2.42
13.0	15.6	19.7	23.2	25.7	28.3	30.8	33.8	38.3	41.9	45.9	49.9	5.4	13.2	2.44
0.91	0.94	0.97	1.00	1.02	1.04	1.06	1.08	1.10	1.12	1.14	1.16			

FOR BELT SIZES NOT SHOWN, INTERPOLATE FOR ADDITIONAL CENTER DISTANCE.

A Stock Drive Selection



V-BELT DRIVES

Speed Ratio	Sheave Combination		DriveN Speeds and HP Per Belt									Nominal Center Distance And Arc-Length Correction Factor						
			3500 RPM DriveR			1750 RPM DriveR			1160 RPM DriveR			A/AX Belt Length Designation						
	DriveR P.D.	DriveN P.D.	DriveN RPM	HP Per Belt A	HP Per Belt AX	DriveN RPM	HP Per Belt A	HP Per Belt AX	DriveN RPM	HP Per Belt A	HP Per Belt AX	26	31	35	38	42	46	51
2.44	6.4	15.6	1436	11.57	13.16	718	7.92	8.41	476	5.76	6.04	—	—	—	—	—	—	—
2.50	3.6	9.0	1400	5.01	5.92	700	3.24	3.63	464	2.37	2.63	—	—	—	9.4	11.4	13.5	16.0
2.50	4.8	12.0	1400	8.26	9.38	700	5.33	5.75	464	3.87	4.13	—	—	—	—	—	—	12.4
2.50	6.0	15.0	1400	10.86	12.31	700	7.29	7.76	464	5.30	5.57	—	—	—	—	—	—	—
2.52	4.2	10.6	1387	6.71	7.71	693	4.30	4.71	460	3.13	3.38	—	—	—	—	9.5	11.6	14.2
ARC-LENGTH CORRECTION FACTOR												0.0	0.0	0.0	0.77	0.81	0.84	0.88
2.52	6.2	15.6	1391	11.23	12.75	696	7.61	8.09	461	5.53	5.81	—	—	—	—	—	—	—
2.53	3.0	7.6	1382	3.18	4.03	691	2.14	2.53	458	1.60	1.85	—	7.5	9.5	11.1	13.1	15.2	17.7
2.54	5.2	13.2	1379	9.20	10.42	689	6.00	6.43	457	4.35	4.61	—	—	—	—	—	—	11.0
2.56	3.2	8.2	1366	3.81	4.67	683	2.51	2.90	453	1.86	2.11	—	—	8.8	10.4	12.4	14.5	17.0
2.57	7.0	18.0	1361	12.47	14.32	681	8.83	9.35	451	6.45	6.74	—	—	—	—	—	—	—
ARC-LENGTH CORRECTION FACTOR												0.0	0.72	0.77	0.79	0.83	0.86	0.89
2.59	5.8	15.0	1353	10.48	11.86	677	6.98	7.44	449	5.06	5.33	—	—	—	—	—	—	—
2.60	6.0	15.6	1346	10.87	12.32	673	7.30	7.76	446	5.30	5.57	—	—	—	—	—	—	—
2.61	4.6	12.0	1342	7.76	8.84	671	4.99	5.41	445	3.62	3.88	—	—	—	—	—	9.9	12.6
2.64	5.0	13.2	1326	8.74	9.91	663	5.67	6.10	439	4.11	4.37	—	—	—	—	—	—	11.1
2.65	3.4	9.0	1322	4.42	5.31	661	2.88	3.27	438	2.12	2.37	—	—	7.9	9.5	11.6	13.6	16.2
ARC-LENGTH CORRECTION FACTOR												0.0	0.0	0.73	0.77	0.81	0.84	0.88
2.65	4.0	10.6	1321	6.17	7.13	660	3.95	4.35	438	2.88	3.13	—	—	—	—	9.6	11.7	14.3
2.68	5.6	15.0	1307	10.08	11.40	653	6.66	7.11	433	4.83	5.10	—	—	—	—	—	—	—
2.69	5.8	15.6	1301	10.48	11.87	651	6.98	7.44	431	5.06	5.33	—	—	—	—	—	—	—
2.73	3.0	8.2	1280	3.19	4.03	640	2.15	2.53	424	1.61	1.85	—	—	9.0	10.5	12.6	14.6	17.2
2.73	4.4	12.0	1283	7.25	8.28	642	4.65	5.06	425	3.38	3.63	—	—	—	—	—	10.1	12.7
ARC-LENGTH CORRECTION FACTOR												0.0	0.0	0.75	0.78	0.82	0.85	0.88
2.73	6.6	18.0	1283	11.90	13.57	642	8.23	8.73	425	5.99	6.28	—	—	—	—	—	—	—
2.75	4.8	13.2	1273	8.26	9.38	636	5.33	5.75	422	3.87	4.13	—	—	—	—	—	—	11.2
2.78	5.4	15.0	1260	9.65	10.92	630	6.33	6.77	418	4.59	4.86	—	—	—	—	—	—	—
2.79	3.8	10.6	1255	5.60	6.54	627	3.60	4.00	416	2.63	2.88	—	—	—	—	9.7	11.9	14.4
2.79	5.6	15.6	1256	10.08	11.40	628	6.66	7.11	416	4.83	5.10	—	—	—	—	—	—	—
ARC-LENGTH CORRECTION FACTOR												0.0	0.0	0.0	0.0	0.78	0.82	0.88
2.80	7.0	19.6	1250	12.48	14.32	625	8.84	9.36	414	6.45	6.74	—	—	—	—	—	—	—
2.81	3.2	9.0	1244	3.81	4.68	622	2.52	2.90	412	1.87	2.11	—	—	8.0	9.6	11.7	13.8	16.3
2.81	6.4	18.0	1244	11.58	13.17	622	7.92	8.41	412	5.76	6.04	—	—	—	—	—	—	—
2.86	4.2	12.0	1225	6.72	7.72	612	4.30	4.71	406	3.13	3.39	—	—	—	—	—	10.2	12.8
2.87	4.6	13.2	1220	7.77	8.84	610	4.99	5.41	404	3.62	3.88	—	—	—	—	—	—	11.4
ARC-LENGTH CORRECTION FACTOR												0.0	0.0	0.73	0.77	0.81	0.84	0.88
2.88	5.2	15.0	1213	9.21	10.42	607	6.00	6.44	402	4.35	5.62	—	—	—	—	—	—	—
2.89	5.4	15.6	1212	9.66	10.92	606	6.33	6.77	402	4.59	4.86	—	—	—	—	—	—	—
2.90	6.2	18.0	1206	11.24	12.75	603	7.61	8.09	400	5.53	5.81	—	—	—	—	—	—	—
2.94	3.6	10.6	1189	5.02	5.93	594	3.24	3.64	394	2.38	2.63	—	—	—	—	9.9	12.0	14.6
2.97	6.6	19.6	1179	11.90	13.57	589	8.23	8.73	391	5.99	6.28	—	—	—	—	—	—	—
ARC-LENGTH CORRECTION FACTOR												0.0	0.0	0.0	0.0	0.77	0.82	0.86
3.00	3.0	9.0	1167	3.19	4.03	583	2.15	2.53	387	1.61	1.86	—	—	8.2	9.8	11.8	13.9	16.5
3.00	4.0	12.0	1167	6.17	7.14	583	3.95	4.36	387	2.88	3.14	—	—	—	—	—	10.3	13.0
3.00	4.4	13.2	1167	7.25	8.29	583	4.65	5.06	387	3.38	3.64	—	—	—	—	—	—	11.5
3.00	5.0	15.0	1167	8.75	9.91	583	5.67	6.10	387	4.11	4.37	—	—	—	—	—	—	—
3.00	5.2	15.6	1167	9.21	10.42	583	6.00	6.44	387	4.35	4.62	—	—	—	—	—	—	—
ARC-LENGTH CORRECTION FACTOR												0.0	0.0	0.73	0.77	0.81	0.84	0.88
3.00	6.0	18.0	1167	10.87	12.32	583	7.30	7.77	387	5.30	5.57	—	—	—	—	—	—	—
3.06	6.4	19.6	1143	11.58	13.17	571	7.93	8.41	379	5.76	6.04	—	—	—	—	—	—	—
3.10	5.8	18.0	1128	10.49	11.87	564	6.98	7.44	374	5.07	5.34	—	—	—	—	—	—	—
3.12	3.4	10.6	1123	4.43	5.31	561	2.88	3.27	372	2.12	2.37	—	—	—	—	10.0	12.1	14.7
3.12	5.0	15.6	1122	8.75	9.91	561	5.67	6.10	372	4.11	4.37	—	—	—	—	—	—	—
ARC-LENGTH CORRECTION FACTOR												0.0	0.0	0.0	0.0	0.77	0.81	0.86
3.13	4.8	15.0	1120	8.27	9.39	560	5.34	5.76	371	3.87	4.13	—	—	—	—	—	—	—
3.14	4.2	13.2	1114	6.72	7.72	557	4.31	4.71	369	3.13	3.39	—	—	—	—	—	—	11.6
3.16	3.8	12.0	1108	5.61	6.54	554	3.60	4.00	367	2.63	2.88	—	—	—	—	—	10.4	13.1
3.16	6.2	19.6	1107	11.24	12.76	554	7.62	8.09	367	5.53	5.81	—	—	—	—	—	—	—
3.21	5.6	18.0	1089	10.08	11.41	544	6.66	7.11	361	4.83	5.10	—	—	—	—	—	—	—
ARC-LENGTH CORRECTION FACTOR												0.0	0.0	0.0	0.0	0.0	0.78	0.83

A = STANDARD V-BELT
 AX = COGGED/NOTCHED V-BELT
 + IF RIM SPEED EXCEEDS 6500 FEET PER MINUTE, CONSULT *Martin*.



Stock Drive Selection **A**

Nominal Center Distances And Arc-Length Correction Factor												Sheave Combination		Speed Ratio
A/AX Belt Length Designation												DriveR P. D.	DriveN P. D.	
55	60	68	75	80	85	90	96	105	112	120	128			
—	—	16.7	20.4	22.9	25.5	28.0	31.0	35.6	39.1	43.1	47.1	6.4	15.6	2.44
18.1	20.6	24.6	28.1	30.6	33.1	35.7	38.7	43.2	46.7	50.7	54.7	3.6	9.0	2.50
14.5	17.1	21.1	24.7	27.2	29.7	32.3	35.3	39.8	43.3	47.3	51.3	4.8	12.0	2.50
—	13.4	17.6	21.2	23.7	26.3	28.8	31.8	36.4	39.9	43.9	47.9	6.0	15.0	2.50
16.2	18.8	22.8	26.3	28.8	31.4	33.9	36.9	41.4	44.9	48.9	52.9	4.2	10.6	2.52
0.90	0.93	0.97	1.00	1.02	1.04	1.05	1.07	1.10	1.12	1.14	1.16			
—	12.7	16.9	20.5	23.0	25.6	28.1	31.2	35.7	39.2	43.3	47.3	6.2	15.6	2.52
19.7	22.2	26.2	29.7	32.2	34.7	37.3	40.3	44.8	48.3	52.3	56.3	3.0	7.6	2.53
13.1	15.7	19.8	23.4	25.9	28.4	30.9	34.0	38.5	42.0	46.0	50.0	5.2	13.2	2.54
19.0	21.6	25.6	29.1	31.6	34.1	36.6	39.6	44.1	47.6	51.6	55.6	3.2	8.2	2.56
—	—	—	17.7	20.3	22.9	25.4	28.5	33.1	36.6	40.6	44.7	7.0	18.0	2.57
0.91	0.94	0.98	1.01	1.02	1.04	1.06	1.08	1.10	1.12	1.14	1.16			
—	13.5	17.7	21.3	23.9	26.4	28.9	32.0	36.5	40.0	44.1	48.1	5.8	15.0	2.59
—	12.8	17.0	20.6	23.2	25.7	28.3	31.3	35.9	39.4	43.4	47.4	6.0	15.6	2.60
14.6	17.2	21.3	24.8	27.4	29.9	32.4	35.4	39.9	43.5	47.5	51.5	4.6	12.0	2.61
13.2	15.8	19.9	23.5	26.0	28.6	31.1	34.1	38.6	42.2	46.2	50.2	5.0	13.2	2.64
18.2	20.7	24.8	28.3	30.8	33.3	35.8	38.8	43.3	46.8	50.8	54.8	3.4	9.0	2.65
0.90	0.93	0.97	1.00	1.02	1.04	1.05	1.07	1.10	1.12	1.14	1.15			
16.4	18.9	22.9	26.5	29.0	31.5	34.0	37.0	41.6	45.1	49.1	53.1	4.0	10.6	2.65
—	13.7	17.9	21.5	24.0	26.6	29.1	32.1	36.7	40.2	44.2	48.2	5.6	15.0	2.68
—	12.9	17.1	20.8	23.3	25.9	28.4	31.5	36.0	39.5	43.6	47.6	5.8	15.6	2.69
19.2	21.7	25.7	29.2	31.7	34.3	36.8	39.8	44.3	47.8	51.8	55.8	3.0	8.2	2.73
14.8	17.4	21.4	25.0	27.5	30.0	32.5	35.6	40.1	43.6	47.6	51.6	4.4	12.0	2.73
0.91	0.94	0.97	1.00	1.02	1.04	1.06	1.07	1.10	1.12	1.14	1.16			
—	—	14.2	17.9	20.5	23.1	25.7	28.8	33.3	36.9	40.9	45.0	6.6	18.0	2.73
13.4	16.0	20.1	23.6	26.2	28.7	31.2	34.3	38.8	42.3	46.3	50.3	4.8	13.2	2.75
—	13.8	18.0	21.6	24.2	26.7	29.2	32.3	36.8	40.3	44.4	48.4	5.4	15.0	2.78
16.5	19.0	23.1	26.6	29.1	31.7	34.2	37.2	41.7	45.2	49.2	53.2	3.8	10.6	2.79
—	13.0	17.3	20.9	23.5	26.0	28.6	31.6	36.2	39.7	43.7	47.7	5.6	15.6	2.79
0.89	0.92	0.96	0.99	1.01	1.03	1.05	1.07	1.09	1.11	1.13	1.15			
—	—	—	16.0	18.7	21.3	23.9	27.0	31.6	35.2	39.3	43.3	7.0	19.6	2.80
18.3	20.9	24.9	28.4	30.9	33.4	36.0	39.0	43.5	47.0	51.0	55.0	3.2	9.0	2.81
—	—	14.3	18.1	20.7	23.3	25.8	28.9	33.5	37.0	41.1	45.1	6.4	18.0	2.81
14.9	17.5	21.6	25.1	27.7	30.2	32.7	35.7	40.2	43.8	47.8	51.8	4.2	12.0	2.86
13.5	16.1	20.2	23.8	26.3	28.8	31.4	34.4	38.9	42.5	46.5	50.5	4.6	13.2	2.87
0.90	0.93	0.97	1.00	1.02	1.04	1.05	1.07	1.10	1.12	1.14	1.15			
—	13.9	18.1	21.7	24.3	26.8	29.4	32.4	37.0	40.5	44.5	48.5	5.2	15.0	2.88
—	13.2	17.4	21.0	23.6	26.2	28.7	31.7	36.3	39.8	43.9	47.9	5.4	15.6	2.89
—	—	14.4	18.2	20.8	23.4	26.0	29.0	33.6	37.2	41.2	45.3	6.2	18.0	2.90
16.6	19.2	23.2	26.8	29.3	31.8	34.3	37.3	41.9	45.4	49.4	53.4	3.6	10.6	2.94
—	—	—	16.3	19.0	21.6	24.2	27.3	31.9	35.5	39.5	43.6	6.6	19.6	2.97
0.89	0.92	0.96	0.99	1.01	1.03	1.05	1.07	1.09	1.11	1.13	1.15			
18.5	21.0	25.0	28.6	31.1	33.6	36.1	39.1	43.6	47.1	51.1	55.1	3.0	9.0	3.00
15.1	17.6	21.7	25.3	27.8	30.3	32.8	35.9	40.4	43.9	47.9	51.9	4.0	12.0	3.00
13.6	16.2	20.4	23.9	26.5	29.0	31.5	34.5	39.1	42.6	46.6	50.6	4.4	13.2	3.00
—	14.1	18.3	21.9	24.4	27.0	29.5	32.6	37.1	40.6	44.7	48.7	5.0	15.0	3.00
—	13.3	17.5	21.2	23.7	26.3	28.8	31.9	36.4	40.0	44.0	48.0	5.2	15.6	3.00
0.90	0.93	0.97	1.00	1.02	1.03	1.05	1.07	1.10	1.12	1.14	1.15			
—	—	14.6	18.3	20.9	23.5	26.1	29.2	33.8	37.3	41.4	45.4	6.0	18.0	3.00
—	—	—	16.4	19.1	21.7	24.3	27.4	32.1	35.6	39.7	43.7	6.4	19.6	3.06
—	—	14.7	18.4	21.1	23.7	26.2	29.3	33.9	37.5	41.5	45.5	5.8	18.0	3.10
16.8	19.3	23.4	26.9	29.4	32.0	34.5	37.5	42.0	45.5	49.5	53.5	3.4	10.6	3.12
—	13.4	17.7	21.3	23.9	26.4	29.0	32.0	36.6	40.1	44.2	48.2	5.0	15.6	3.12
0.88	0.92	0.96	0.99	1.01	1.03	1.05	1.06	1.09	1.11	1.13	1.15			
11.5	14.2	18.4	22.0	24.6	27.1	29.7	32.7	37.2	40.8	44.8	48.8	4.8	15.0	3.13
13.7	16.4	20.5	24.1	26.6	29.1	31.7	34.7	39.2	42.7	46.8	50.8	4.2	13.2	3.14
15.2	17.8	21.9	25.4	27.9	30.5	33.0	36.0	40.5	44.0	48.1	52.1	3.8	12.0	3.16
—	—	—	16.5	19.2	21.9	24.5	27.6	32.2	35.8	39.8	43.9	6.2	19.6	3.16
—	—	14.8	18.6	21.2	23.8	26.4	29.5	34.1	37.6	41.7	45.7	5.6	18.0	3.21
0.87	0.90	0.95	0.98	1.00	1.02	1.04	1.06	1.09	1.11	1.13	1.15			

FOR BELT SIZES NOT SHOWN, INTERPOLATE FOR ADDITIONAL CENTER DISTANCE.

V-BELT DRIVES

A Stock Drive Selection



V-BELT DRIVES

Speed Ratio	Sheave Combination		DriveN Speeds and HP Per Belt									Nominal Center Distance And Arc-Length Correction Factor						
			3500 RPM DriveR			1750 RPM DriveR			1160 RPM DriveR									
	DriveR P.D.	DriveN P.D.	DriveN RPM	HP Per Belt A	HP Per Belt AX	DriveN RPM	HP Per Belt A	HP Per Belt AX	DriveN RPM	HP Per Belt A	HP Per Belt AX	A/AX Belt Length Designation						
												26	31	35	38	42	46	51
3.25	4.8	15.6	1077	8.27	9.39	538	5.34	5.76	357	3.87	4.13	—	—	—	—	—	—	
3.26	4.6	15.0	1073	7.77	8.85	537	5.00	5.41	356	3.63	3.88	—	—	—	—	—	—	
3.27	6.0	19.6	1071	10.88	12.32	536	7.30	7.77	355	5.30	5.57	—	—	—	—	—	—	
3.30	4.0	13.2	1061	6.17	7.14	530	3.96	4.36	352	2.88	3.14	—	—	—	—	—	11.7	
3.31	3.2	10.6	1057	3.82	4.68	528	2.52	2.91	350	1.87	2.12	—	—	—	10.1	12.3	14.9	
ARC-LENGTH CORRECTION FACTOR												0.0	0.0	0.0	0.0	0.77	0.81	0.86
3.33	3.6	12.0	1050	5.03	5.94	525	3.24	3.64	348	2.38	2.63	—	—	—	—	10.6	13.2	
3.33	5.4	18.0	1050	9.66	10.92	525	6.33	6.78	348	4.59	4.86	—	—	—	—	—	—	
3.38	5.8	19.6	1036	10.49	11.87	518	6.98	7.44	343	5.07	5.34	—	—	—	—	—	—	
3.39	4.6	15.6	1032	7.77	8.85	516	5.00	5.41	342	3.63	3.88	—	—	—	—	—	—	
3.41	4.4	15.0	1027	7.26	8.29	513	4.65	5.06	340	3.38	3.64	—	—	—	—	—	—	
ARC-LENGTH CORRECTION FACTOR												0.0	0.0	0.0	0.0	0.0	0.78	0.83
3.46	5.2	18.0	1011	9.22	10.43	506	6.01	6.44	335	4.35	4.62	—	—	—	—	—	—	
3.47	3.8	13.2	1008	5.61	6.55	504	3.60	4.00	334	2.63	2.88	—	—	—	—	—	11.9	
3.50	5.6	19.6	1000	10.09	11.41	500	6.66	7.11	331	4.83	5.10	—	—	—	—	—	—	
3.51	7.0	24.6	996	12.48	14.33	498	8.84	9.36	330	6.45	6.74	—	—	—	—	—	—	
3.53	3.0	10.6	991	3.19	4.04	495	2.15	2.53	328	1.61	1.86	—	—	—	10.3	12.4	15.0	
ARC-LENGTH CORRECTION FACTOR												0.0	0.0	0.0	0.0	0.77	0.81	0.85
3.53	3.4	12.0	992	4.43	5.32	496	2.88	3.27	329	2.12	2.37	—	—	—	—	10.7	13.4	
3.55	4.4	15.6	987	7.26	8.29	494	4.65	5.06	327	3.38	3.64	—	—	—	—	—	—	
3.57	4.2	15.0	980	6.73	7.72	490	4.31	4.71	325	3.13	3.39	—	—	—	—	—	—	
3.60	5.0	18.0	972	8.76	9.92	486	5.67	6.10	322	4.11	4.37	—	—	—	—	—	—	
3.63	5.4	19.6	964	9.66	10.93	482	6.34	6.78	320	4.59	4.86	—	—	—	—	—	—	
ARC-LENGTH CORRECTION FACTOR												0.0	0.0	0.0	0.0	0.0	0.78	0.83
3.67	3.6	13.2	955	5.03	5.94	477	3.25	3.64	316	2.38	2.63	—	—	—	—	—	12.0	
3.71	4.2	15.6	942	6.73	7.72	471	4.31	4.71	312	3.13	3.39	—	—	—	—	—	—	
3.73	6.6	24.6	939	11.91	13.58	470	8.24	8.73	311	6.00	6.28	—	—	—	—	—	—	
3.75	3.2	12.0	933	3.82	4.68	467	2.52	2.91	309	1.87	2.12	—	—	—	—	10.8	13.5	
3.75	4.0	15.0	933	6.18	7.14	467	3.96	4.36	309	2.88	3.14	—	—	—	—	—	—	
ARC-LENGTH CORRECTION FACTOR												0.0	0.0	0.0	0.0	0.0	0.78	0.83
3.75	4.8	18.0	933	8.27	9.39	467	5.34	5.76	309	3.87	4.13	—	—	—	—	—	—	
3.77	5.2	19.6	929	9.22	10.43	464	6.01	6.44	308	4.35	4.62	—	—	—	—	—	—	
3.84	6.4	24.6	911	11.59	13.18	455	7.93	8.41	302	5.77	6.05	—	—	—	—	—	—	
3.88	3.4	13.2	902	4.43	5.32	451	2.88	3.27	299	2.13	2.38	—	—	—	—	—	12.1	
3.90	4.0	15.6	897	6.18	7.14	449	3.96	4.36	297	2.88	3.14	—	—	—	—	—	—	
ARC-LENGTH CORRECTION FACTOR												0.0	0.0	0.0	0.0	0.0	0.0	0.80
3.91	4.6	18.0	894	7.78	8.85	447	5.00	5.41	296	3.63	3.88	—	—	—	—	—	—	
3.92	5.0	19.6	893	8.76	9.92	446	5.67	6.10	296	4.11	4.37	—	—	—	—	—	—	
3.95	3.8	15.0	887	5.61	6.55	443	3.60	4.00	294	2.63	2.89	—	—	—	—	—	—	
3.97	6.2	24.6	882	11.24	12.76	441	7.62	8.09	292	5.53	5.81	—	—	—	—	—	—	
4.00	3.0	12.0	875	3.20	4.04	438	2.15	2.54	290	1.61	1.86	—	—	—	10.9	13.6	—	
ARC-LENGTH CORRECTION FACTOR												0.0	0.0	0.0	0.0	0.0	0.77	0.83
4.08	4.8	19.6	857	8.28	9.39	429	5.34	5.76	284	3.87	4.13	—	—	—	—	—	—	
4.09	4.4	18.0	856	7.26	8.29	428	4.66	5.07	284	3.38	3.64	—	—	—	—	—	—	
4.10	6.0	24.6	854	10.88	12.33	427	7.30	7.77	283	5.30	5.58	—	—	—	—	—	—	
4.11	3.8	15.6	853	5.61	6.55	426	3.60	4.00	283	2.63	2.89	—	—	—	—	—	—	
4.12	3.2	13.2	848	3.82	4.69	424	2.52	2.91	281	1.87	2.12	—	—	—	—	—	12.2	
ARC-LENGTH CORRECTION FACTOR												0.0	0.0	0.0	0.0	0.0	0.0	0.80
4.17	3.6	15.0	840	5.03	5.94	420	3.25	3.64	278	2.38	2.63	—	—	—	—	—	—	
4.23	7.0	29.6	828	12.49	14.33	414	8.84	9.36	274	6.45	6.74	—	—	—	—	—	—	
4.24	5.8	24.6	825	10.50	11.88	413	6.98	7.44	273	5.07	5.34	—	—	—	—	—	—	
4.26	4.6	19.6	821	7.78	8.85	411	5.00	5.41	272	3.63	3.89	—	—	—	—	—	—	
4.29	4.2	18.0	817	6.73	7.73	408	4.31	4.71	271	3.13	3.39	—	—	—	—	—	—	
ARC-LENGTH CORRECTION FACTOR												0.0	0.0	0.0	0.0	0.0	0.0	0.0
4.33	3.6	15.6	808	5.03	5.94	404	3.25	3.64	268	2.38	2.63	—	—	—	—	—	—	
4.39	5.6	24.6	797	10.09	11.41	398	6.66	7.11	264	4.83	5.10	—	—	—	—	—	—	
4.40	3.0	13.2	795	3.20	4.04	398	2.15	2.54	264	1.61	1.86	—	—	—	—	—	12.4	
4.41	3.4	15.0	793	4.44	5.32	397	2.89	3.28	263	2.13	2.38	—	—	—	—	—	—	
4.45	4.4	19.6	786	7.26	8.30	393	4.66	5.07	260	3.38	3.64	—	—	—	—	—	—	
ARC-LENGTH CORRECTION FACTOR												0.0	0.0	0.0	0.0	0.0	0.0	0.80

A = STANDARD V-BELT
 AX = COGGED/NOTCHED V-BELT
 + IF RIM SPEED EXCEEDS 6500 FEET PER MINUTE, CONSULT *Martin*.



Stock Drive Selection **A**

Nominal Center Distances And Arc-Length Correction Factor												Sheave Combination		Speed Ratio
A/AX Belt Length Designation												DriveR P. D.	DriveN P. D.	
55	60	68	75	80	85	90	96	105	112	120	128			
—	13.6	17.8	21.4	24.0	26.6	29.1	32.2	36.7	40.3	44.3	48.3	4.8	15.6	3.25
11.6	14.3	18.5	22.1	24.7	27.3	29.8	32.8	37.4	40.9	45.0	49.0	4.6	15.0	3.26
—	—	—	16.7	19.3	22.0	24.6	27.7	32.3	35.9	40.0	44.0	6.0	19.6	3.27
13.9	16.5	20.6	24.2	26.7	29.3	31.8	34.8	39.4	42.9	46.9	50.9	4.0	13.2	3.30
16.9	19.5	23.5	27.1	29.6	32.1	34.6	37.6	42.1	45.7	49.7	53.7	3.2	10.6	3.31
0.88	0.91	0.96	0.99	1.01	1.03	1.04	1.06	1.09	1.11	1.13	1.15			
15.3	17.9	22.0	25.6	28.1	30.6	33.1	36.2	40.7	44.2	48.2	52.2	3.6	12.0	3.33
—	—	14.9	18.7	21.3	23.9	26.5	29.6	34.2	37.7	41.8	45.8	5.4	18.0	3.33
—	—	—	16.8	19.5	22.1	24.7	27.8	32.5	36.0	40.1	44.2	5.8	19.6	3.38
—	13.7	17.9	21.6	24.2	26.7	29.3	32.3	36.9	40.4	44.4	48.5	4.6	15.6	3.39
11.7	14.4	18.7	22.3	24.8	27.4	29.9	33.0	37.5	41.1	45.1	49.1	4.4	15.0	3.41
0.87	0.90	0.95	0.98	1.00	1.02	1.04	1.06	1.09	1.11	1.13	1.15			
—	—	15.1	18.8	21.5	24.1	26.7	29.7	34.3	37.9	41.9	46.0	5.2	18.0	3.46
14.0	16.6	20.8	24.3	26.9	29.4	32.0	35.0	39.5	43.0	47.1	51.1	3.8	13.2	3.47
—	—	—	16.9	19.6	22.3	24.9	28.0	32.6	36.2	40.2	44.3	5.6	19.6	3.50
—	—	—	—	—	—	18.8	22.1	26.9	30.6	34.7	38.8	7.0	24.6	3.51
17.0	19.6	23.7	27.2	29.7	32.2	34.8	37.8	42.3	45.8	49.8	53.8	3.0	10.6	3.53
0.88	0.91	0.96	0.99	1.01	1.03	1.04	1.06	1.09	1.11	1.13	1.15			
15.5	18.0	22.1	25.7	28.2	30.8	33.3	36.3	40.8	44.3	48.4	52.4	3.4	12.0	3.53
—	13.8	18.1	21.7	24.3	26.9	29.4	32.5	37.0	40.6	44.6	48.6	4.4	15.6	3.55
11.8	14.6	18.8	22.4	25.0	27.5	30.1	33.1	37.7	41.2	45.2	49.3	4.2	15.0	3.57
—	—	15.2	19.0	21.6	24.2	26.8	29.9	34.5	38.0	42.1	46.1	5.0	18.0	3.60
—	—	—	17.0	19.7	22.4	25.0	28.1	32.7	36.3	40.4	44.4	5.4	19.6	3.63
0.86	0.90	0.94	0.98	1.00	1.02	1.04	1.06	1.09	1.10	1.13	1.14			
14.1	16.8	20.9	24.5	27.0	29.6	32.1	35.1	39.7	43.2	47.2	51.2	3.6	13.2	3.67
—	13.9	18.2	21.9	24.4	27.0	29.5	32.6	37.2	40.7	44.7	48.8	4.2	15.6	3.71
—	—	—	—	—	—	19.0	22.3	27.2	30.8	35.0	39.1	6.6	24.6	3.73
15.6	18.2	22.3	25.8	28.4	30.9	33.4	36.4	41.0	44.5	48.5	52.5	3.2	12.0	3.75
12.0	14.7	18.9	22.6	25.1	27.7	30.2	33.3	37.8	41.4	45.4	49.4	4.0	15.0	3.75
0.86	0.90	0.94	0.98	1.00	1.02	1.04	1.06	1.08	1.10	1.12	1.14			
—	—	15.3	19.1	21.7	24.3	26.9	30.0	34.6	38.2	42.2	46.3	4.8	18.0	3.75
—	—	—	17.2	19.9	22.5	25.1	28.3	32.9	36.5	40.5	44.6	5.2	19.6	3.77
—	—	—	—	—	—	19.1	22.5	27.3	31.0	35.1	39.2	6.4	24.6	3.84
14.3	16.9	21.0	24.6	27.2	29.7	32.2	35.3	39.8	43.3	47.4	51.4	3.4	13.2	3.88
—	14.1	18.3	22.0	24.6	27.1	29.7	32.7	37.3	40.8	44.9	48.9	4.0	15.6	3.90
0.84	0.88	0.93	0.97	0.99	1.01	1.03	1.05	1.08	1.10	1.12	1.14			
—	—	15.4	19.2	21.9	24.5	27.1	30.2	34.8	38.3	42.4	46.4	4.6	18.0	3.91
—	—	—	17.3	20.0	22.7	25.3	28.4	33.0	36.6	40.7	44.7	5.0	19.6	3.92
12.1	14.8	19.1	22.7	25.3	27.8	30.4	33.4	38.0	41.5	45.5	49.6	3.8	15.0	3.95
—	—	—	—	—	—	19.3	22.6	27.4	31.1	35.3	39.4	6.2	24.6	3.97
15.7	18.3	22.4	26.0	28.5	31.0	33.6	36.6	41.1	44.6	48.7	52.7	3.0	12.0	4.00
0.86	0.90	0.94	0.98	1.00	1.02	1.04	1.06	1.08	1.10	1.12	1.14			
—	—	—	17.4	20.1	22.8	25.4	28.5	33.2	36.7	40.8	44.9	4.8	19.6	4.08
—	—	15.6	19.4	22.0	24.6	27.2	30.3	34.9	38.5	42.5	46.6	4.4	18.0	4.09
—	—	—	—	—	—	19.4	22.7	27.5	31.2	35.4	39.5	6.0	24.6	4.10
11.4	14.2	18.5	22.1	24.7	27.3	29.8	32.9	37.4	41.0	45.0	49.1	3.8	15.6	4.11
14.4	17.0	21.2	24.8	27.3	29.9	32.4	35.4	40.0	43.5	47.5	51.5	3.2	13.2	4.12
0.84	0.88	0.93	0.97	0.99	1.01	1.03	1.05	1.08	1.10	1.12	1.14			
12.2	15.0	19.2	22.8	25.4	28.0	30.5	33.6	38.1	41.7	45.7	49.7	3.6	15.0	4.17
—	—	—	—	—	—	—	—	21.4	25.4	29.8	34.0	7.0	29.6	4.23
—	—	—	—	—	—	19.5	22.8	27.7	31.4	35.5	39.7	5.8	24.6	4.24
—	—	—	17.5	20.3	22.9	25.5	28.7	33.3	36.9	41.0	45.0	4.6	19.6	4.26
—	—	15.7	19.5	22.1	24.8	27.3	30.4	35.0	38.6	42.7	46.7	4.2	18.0	4.29
0.79	0.85	0.91	0.95	0.98	1.00	1.02	1.04	1.07	1.09	1.11	1.13			
11.5	14.3	18.6	22.3	24.8	27.4	30.0	33.0	37.6	41.1	45.2	49.2	3.6	15.6	4.33
—	—	—	—	—	—	19.6	23.0	27.8	31.5	35.7	39.8	5.6	24.6	4.39
14.5	17.2	21.3	24.9	27.5	30.0	32.5	35.6	40.1	43.6	47.7	51.7	3.0	13.2	4.40
12.3	15.1	19.3	23.0	25.5	28.1	30.6	33.7	38.3	41.8	45.8	49.9	3.4	15.0	4.41
—	—	13.7	17.7	20.4	23.0	25.7	28.8	33.4	37.0	41.1	45.2	4.4	19.6	4.45
0.84	0.88	0.93	0.97	0.99	1.01	1.03	1.05	1.08	1.10	1.12	1.14			

FOR BELT SIZES NOT SHOWN, INTERPOLATE FOR ADDITIONAL CENTER DISTANCE.

V-BELT DRIVES

A Stock Drive Selection



V-BELT DRIVES

Speed Ratio	Sheave Combination		DriveN Speeds and HP Per Belt									Nominal Center Distance And Arc-Length Correction Factor						
			3500 RPM DriveR			1750 RPM DriveR			1160 RPM DriveR									
	DriveR P.D.	DriveN P.D.	DriveN RPM	HP Per Belt A	HP Per Belt AX	DriveN RPM	HP Per Belt A	HP Per Belt AX	DriveN RPM	HP Per Belt A	HP Per Belt AX	A/AX Belt Length Designation						
												26	31	35	38	42	46	51
4.48	6.6	29.6	780	11.91	13.58	390	8.24	8.73	259	6.00	6.28	-	-	-	-	-	-	
4.50	4.0	18.0	778	6.18	7.14	389	3.96	4.36	258	2.89	3.14	-	-	-	-	-	-	
4.56	5.4	24.6	768	9.67	10.93	384	6.34	6.78	255	4.59	4.86	-	-	-	-	-	-	
4.59	3.4	15.6	763	4.44	5.32	381	2.89	3.28	253	2.13	2.38	-	-	-	-	-	-	
4.62	6.4	29.6	757	11.59	13.18	378	7.93	8.42	251	5.77	6.05	-	-	-	-	-	-	
ARC-LENGTH CORRECTION FACTOR												0.0	0.0	0.0	0.0	0.0	0.0	0.0
4.67	4.2	19.6	750	6.73	7.73	375	4.31	4.71	249	3.13	3.39	-	-	-	-	-	-	
4.69	3.2	15.0	747	3.83	4.69	373	2.52	2.91	247	1.87	2.12	-	-	-	-	-	-	
4.73	5.2	24.6	740	9.22	10.43	370	6.01	6.44	245	4.36	4.62	-	-	-	-	-	-	
4.74	3.8	18.0	739	5.61	6.55	369	3.60	4.00	245	2.63	2.89	-	-	-	-	-	-	
4.77	6.2	29.6	733	11.25	12.76	367	7.62	8.09	243	5.54	5.81	-	-	-	-	-	-	
ARC-LENGTH CORRECTION FACTOR												0.0	0.0	0.0	0.0	0.0	0.0	0.0
4.87	3.2	15.6	718	3.83	4.69	359	2.52	2.91	238	1.87	2.12	-	-	-	-	-	-	
4.90	4.0	19.6	714	6.18	7.15	357	3.96	4.36	237	2.89	3.14	-	-	-	-	-	-	
4.92	5.0	24.6	711	8.76	9.92	356	5.68	6.10	236	4.11	4.38	-	-	-	-	-	-	
4.93	6.0	29.6	709	10.88	12.33	355	7.30	7.77	235	5.30	5.58	-	-	-	-	-	-	
5.00	3.0	15.0	700	3.20	4.04	350	2.15	2.54	232	1.61	1.86	-	-	-	-	-	-	
ARC-LENGTH CORRECTION FACTOR												0.0	0.0	0.0	0.0	0.0	0.0	0.0
5.00	3.6	18.0	700	5.03	5.94	350	3.25	3.64	232	2.38	2.62	-	-	-	-	-	-	
5.10	5.8	29.6	686	10.50	11.88	343	6.99	7.44	227	5.07	5.34	-	-	-	-	-	-	
5.12	4.8	24.6	683	8.28	9.39	341	5.34	5.76	226	3.87	4.13	-	-	-	-	-	-	
5.16	3.8	19.6	679	5.62	6.55	339	3.61	4.00	225	2.63	2.89	-	-	-	-	-	-	
5.20	3.0	15.6	673	3.20	4.04	337	2.15	2.54	223	1.61	1.86	-	-	-	-	-	-	
ARC-LENGTH CORRECTION FACTOR												0.0	0.0	0.0	0.0	0.0	0.0	0.0
5.29	3.4	18.0	661	4.44	5.32	331	2.89	3.28	219	2.13	2.38	-	-	-	-	-	-	
5.29	5.6	29.6	662	10.09	11.41	331	6.66	7.11	219	4.83	5.10	-	-	-	-	-	-	
5.35	4.6	24.6	654	7.78	8.85	327	5.00	5.42	217	3.63	3.89	-	-	-	-	-	-	
5.37	7.0	37.6	652	12.49	14.33	326	8.84	9.36	216	6.45	6.74	-	-	-	-	-	-	
5.44	3.6	19.6	643	5.03	5.94	321	3.25	3.64	213	2.38	2.63	-	-	-	-	-	-	
ARC-LENGTH CORRECTION FACTOR												0.0	0.0	0.0	0.0	0.0	0.0	0.0
5.48	5.4	29.6	639	9.67	10.93	319	6.34	6.78	212	4.59	4.86	-	-	-	-	-	-	
5.59	4.4	24.6	626	7.26	8.30	313	4.66	5.07	207	3.38	3.64	-	-	-	-	-	-	
5.63	3.2	18.0	622	3.83	4.69	311	2.52	2.91	206	1.87	2.12	-	-	-	-	-	-	
5.69	5.2	29.6	615	9.22	10.43	307	6.01	6.44	204	4.36	4.62	-	-	-	-	-	-	
5.70	6.6	37.6	614	11.91	13.59	207	8.24	8.73	204	6.00	6.28	-	-	-	-	-	-	
ARC-LENGTH CORRECTION FACTOR												0.0	0.0	0.0	0.0	0.0	0.0	0.0
5.76	3.4	19.6	607	4.44	5.32	304	2.89	3.28	201	2.13	2.38	-	-	-	-	-	-	
5.86	4.2	24.6	598	6.73	7.73	299	4.31	4.72	198	3.14	3.39	-	-	-	-	-	-	
5.87	6.4	37.6	596	11.59	13.18	298	7.93	8.42	197	5.77	6.05	-	-	-	-	-	-	
5.92	5.0	29.6	591	8.76	9.92	296	5.68	6.10	196	4.12	4.38	-	-	-	-	-	-	
6.00	3.0	18.0	583	3.20	4.04	292	2.15	2.54	193	1.61	1.86	-	-	-	-	-	-	
ARC-LENGTH CORRECTION FACTOR												0.0	0.0	0.0	0.0	0.0	0.0	0.0
6.06	6.2	37.6	577	11.25	12.77	289	7.62	8.10	191	5.54	5.81	-	-	-	-	-	-	
6.12	3.2	19.6	571	3.83	4.69	286	2.52	2.91	189	1.87	2.12	-	-	-	-	-	-	
6.15	4.0	24.6	569	6.18	7.15	285	3.96	4.36	189	2.89	3.14	-	-	-	-	-	-	
6.17	4.8	29.6	568	8.28	9.39	284	5.34	5.76	188	3.87	4.13	-	-	-	-	-	-	
6.27	6.0	37.6	559	10.88	12.33	279	7.31	7.77	185	5.30	5.58	-	-	-	-	-	-	
ARC-LENGTH CORRECTION FACTOR												0.0	0.0	0.0	0.0	0.0	0.0	0.0
6.43	4.6	29.6	544	7.78	8.85	272	5.00	5.42	180	3.63	3.89	-	-	-	-	-	-	
6.47	3.8	24.6	541	5.62	6.55	270	3.61	4.00	179	2.63	2.89	-	-	-	-	-	-	
6.48	5.8	37.6	540	10.50	11.88	270	6.99	7.44	179	5.07	5.34	-	-	-	-	-	-	
6.53	3.0	19.6	536	3.20	4.04	268	2.15	2.54	178	1.61	1.86	-	-	-	-	-	-	
6.71	5.6	37.6	521	10.09	11.41	261	6.66	7.11	173	4.83	5.10	-	-	-	-	-	-	
ARC-LENGTH CORRECTION FACTOR												0.0	0.0	0.0	0.0	0.0	0.0	0.0
6.73	4.4	29.6	520	7.27	8.30	260	4.66	5.07	172	3.38	3.64	-	-	-	-	-	-	
6.83	3.6	24.6	512	5.04	5.94	256	3.25	3.64	170	2.38	2.63	-	-	-	-	-	-	
6.96	5.4	37.6	503	9.67	10.93	251	6.34	6.78	167	4.60	4.86	-	-	-	-	-	-	
7.05	4.2	29.6	497	6.73	7.73	248	4.31	4.72	165	3.14	3.39	-	-	-	-	-	-	
7.23	5.2	37.6	484	9.23	10.43	242	6.01	6.44	160	4.36	4.62	-	-	-	-	-	-	
ARC-LENGTH CORRECTION FACTOR												0.0	0.0	0.0	0.0	0.0	0.0	0.0

A = STANDARD V-BELT
 AX = COGGED/NOTCHED V-BELT
 + IF RIM SPEED EXCEEDS 6500 FEET PER MINUTE, CONSULT *Martin*.



Stock Drive Selection **A**

Nominal Center Distances And Arc-Length Correction Factor												Sheave Combination		Speed Ratio
A/AX Belt Length Designation												DriveR P. D.	DriveN P. D.	
55	60	68	75	80	85	90	96	105	112	120	128			
—	—	—	—	—	—	—	—	21.7	25.6	30.0	34.3	6.6	29.6	4.48
—	—	15.8	19.6	22.3	24.9	27.5	30.6	35.2	38.7	42.8	46.8	4.0	18.0	4.50
—	—	—	—	—	16.9	19.8	23.1	27.9	31.6	35.8	39.9	5.4	24.6	4.56
11.6	14.4	18.7	22.4	25.0	27.6	30.1	33.2	37.7	41.3	45.3	49.4	3.4	15.6	4.59
—	—	—	—	—	—	—	—	21.8	25.8	30.1	34.4	6.4	29.6	4.62
0.76	0.83	0.90	0.94	0.97	0.99	1.01	1.04	1.07	1.09	1.11	1.13			
—	—	13.8	17.8	20.5	23.2	25.8	28.9	33.6	37.2	41.2	45.3	4.2	19.6	4.67
12.5	15.2	19.5	23.1	25.7	28.2	30.8	33.8	38.4	41.9	46.0	50.0	3.2	15.0	4.69
—	—	—	—	—	17.0	19.9	23.2	28.1	31.8	35.9	40.1	5.2	24.6	4.73
—	—	15.9	19.8	22.4	25.0	27.6	30.7	35.3	38.9	42.9	47.0	3.8	18.0	4.74
—	—	—	—	—	—	—	—	21.9	25.9	30.3	34.6	6.2	29.6	4.77
0.79	0.84	0.91	0.95	0.97	1.00	1.02	1.04	1.07	1.09	1.11	1.13			
11.7	14.6	18.9	22.5	25.1	27.7	30.2	33.3	37.9	41.4	45.5	49.5	3.2	15.6	4.87
—	—	13.9	17.9	20.6	23.3	25.9	29.1	33.7	37.3	41.4	45.4	4.0	19.6	4.90
—	—	—	—	—	17.1	20.0	23.3	28.2	31.9	36.1	40.2	5.0	24.6	4.92
—	—	—	—	—	—	—	—	22.0	26.0	30.4	34.7	5.0	29.6	4.93
12.6	15.3	19.6	23.2	25.8	28.4	30.9	34.0	38.5	42.1	46.1	50.2	3.0	15.0	5.00
0.76	0.83	0.90	0.94	0.97	0.99	1.01	1.04	1.07	1.09	1.11	1.13			
—	—	16.1	19.9	22.5	25.2	27.8	30.8	35.5	39.0	43.1	47.1	3.6	18.0	5.00
—	—	—	—	—	—	—	—	22.2	26.1	30.5	34.8	5.8	29.6	5.10
—	—	—	—	—	17.2	20.1	23.5	28.3	32.0	36.2	40.3	4.8	24.6	5.12
—	—	14.1	18.0	20.8	23.4	26.1	29.2	33.8	37.4	41.5	45.6	3.8	19.6	5.16
11.9	14.7	19.0	22.7	25.3	27.8	30.4	33.4	38.0	41.6	45.6	49.6	3.0	15.6	5.20
0.76	0.83	0.90	0.94	0.97	0.99	1.01	1.03	1.07	1.09	1.11	1.13			
—	—	16.2	20.0	22.7	25.3	27.9	31.0	35.6	39.2	43.2	47.3	3.4	18.0	5.29
—	—	—	—	—	—	—	—	22.3	26.3	30.7	34.9	5.6	29.6	5.29
—	—	—	—	—	17.3	20.2	23.6	28.5	32.2	36.3	40.5	4.6	24.6	5.35
—	—	—	—	—	—	—	—	—	—	—	24.9	7.0	37.6	5.37
—	—	14.2	18.2	20.9	23.6	26.2	29.3	34.0	37.6	41.7	45.7	3.6	19.6	5.44
0.0	0.0	0.85	0.91	0.94	0.97	0.99	1.02	1.05	1.07	1.10	1.12			
—	—	—	—	—	—	—	—	22.4	26.4	30.8	35.1	5.4	29.6	5.48
—	—	—	—	—	17.5	20.4	23.7	28.6	32.3	36.5	40.6	4.4	24.6	5.59
—	—	16.3	20.1	22.8	25.4	28.0	31.1	35.7	39.3	43.4	47.4	3.2	18.0	5.63
—	—	—	—	—	—	—	—	22.5	26.5	30.9	35.2	5.2	29.6	5.69
—	—	—	—	—	—	—	—	—	—	—	25.2	6.6	37.6	5.70
0.0	0.0	0.85	0.91	0.94	0.97	0.99	1.02	1.05	1.07	1.10	1.12			
—	—	14.3	18.3	21.0	23.7	26.3	29.5	34.1	37.7	41.8	45.9	3.4	19.6	5.76
—	—	—	—	—	17.6	20.5	23.8	28.7	32.4	36.6	40.8	4.2	24.6	5.86
—	—	—	—	—	—	—	—	—	—	—	25.3	6.2	37.6	5.87
—	—	—	—	—	—	—	—	22.6	26.6	31.0	35.3	5.0	29.6	5.92
—	—	16.4	20.3	22.9	25.6	28.2	31.3	35.9	39.4	43.5	47.6	3.0	18.0	6.00
0.0	0.0	0.79	0.87	0.91	0.95	0.97	1.00	1.04	1.06	1.09	1.11			
—	—	—	—	—	—	—	—	—	—	—	25.4	6.2	37.6	6.06
—	—	14.4	18.4	21.2	23.8	26.5	29.6	34.3	37.9	41.9	46.0	3.2	19.6	6.12
—	—	—	—	—	17.7	20.6	24.0	28.8	32.6	36.7	40.9	4.0	24.6	6.15
—	—	—	—	—	—	—	—	22.8	26.8	31.2	35.5	4.8	29.6	6.17
—	—	—	—	—	—	—	—	—	—	—	25.5	6.0	37.6	6.27
0.0	0.0	0.79	0.87	0.91	0.95	0.97	1.00	1.04	1.06	1.09	1.11			
—	—	—	—	—	—	—	—	22.9	26.9	31.3	35.6	4.6	29.6	6.43
—	—	—	—	—	17.8	20.7	24.1	29.0	32.7	36.9	41.0	3.8	24.6	6.47
—	—	—	—	—	—	—	—	—	—	—	25.6	5.8	37.6	6.48
—	—	14.5	18.5	21.3	24.0	26.6	29.7	34.4	38.0	42.1	46.2	3.0	19.6	6.53
—	—	—	—	—	—	—	—	—	—	—	25.7	5.6	37.6	6.71
0.0	0.0	0.78	0.87	0.91	0.94	0.97	1.00	1.04	1.06	1.09	1.11			
—	—	—	—	—	—	—	—	23.0	27.0	31.4	35.7	4.4	29.6	6.73
—	—	—	—	—	17.9	20.9	24.2	29.1	32.8	37.0	41.2	3.6	24.6	6.83
—	—	—	—	—	—	—	—	—	—	—	25.9	5.4	37.6	6.96
—	—	—	—	—	—	—	—	23.1	27.1	31.5	35.9	4.2	29.6	7.05
—	—	—	—	—	—	—	—	—	—	—	26.0	5.2	37.6	7.23
0.0	0.0	0.0	0.0	0.0	0.82	0.88	0.93	0.99	1.02	1.05	1.08			

FOR BELT SIZES NOT SHOWN, INTERPOLATE FOR ADDITIONAL CENTER DISTANCE.

V-BELT DRIVES

A Stock Drive Selection



V-BELT DRIVES

Speed Ratio	Sheave Combination		DriveN Speeds and HP Per Belt									Nominal Center Distance And Arc-Length Correction Factor						
			3500 RPM DriveR			1750 RPM DriveR			1160 RPM DriveR									
	DriveR P.D.	DriveN P.D.	DriveN RPM	HP Per Belt A	HP Per Belt AX	DriveN RPM	HP Per Belt A	HP Per Belt AX	DriveN RPM	HP Per Belt A	HP Per Belt AX	A/AX Belt Length Designation						
												26	31	35	38	42	46	51
7.24	3.4	24.6	484	4.44	5.32	242	2.89	3.28	160	2.13	2.38	—	—	—	—	—	—	
7.40	4.0	29.6	473	6.18	7.15	236	3.96	4.36	157	2.89	3.14	—	—	—	—	—	—	
7.52	5.0	37.6	465	8.76	9.92	233	5.68	6.10	154	4.12	4.38	—	—	—	—	—	—	
7.69	3.2	24.6	455	3.83	4.69	228	2.52	2.91	151	1.87	2.12	—	—	—	—	—	—	
7.79	3.8	29.6	449	5.62	6.55	225	3.61	4.00	149	2.64	2.89	—	—	—	—	—	—	
ARC-LENGTH CORRECTION FACTOR												0.0	0.0	0.0	0.0	0.0	0.0	0.0
7.83	4.8	37.6	447	8.28	9.40	223	5.34	5.76	148	3.87	4.13	—	—	—	—	—	—	
8.17	4.6	37.6	428	7.78	8.85	214	5.00	5.42	142	3.63	3.89	—	—	—	—	—	—	
8.20	3.0	24.6	427	3.20	4.04	213	2.15	2.54	141	1.61	1.86	—	—	—	—	—	—	
8.22	3.6	29.6	426	5.04	5.94	213	3.25	3.64	141	2.38	2.63	—	—	—	—	—	—	
8.55	4.4	37.6	410	7.27	8.30	205	4.66	5.07	136	3.38	3.64	—	—	—	—	—	—	
ARC-LENGTH CORRECTION FACTOR												0.0	0.0	0.0	0.0	0.0	0.0	0.0
8.71	3.4	29.6	402	4.44	5.32	201	2.89	3.28	133	2.13	2.38	—	—	—	—	—	—	
8.95	4.2	37.6	391	6.73	7.73	195	4.31	4.72	130	3.14	3.39	—	—	—	—	—	—	
9.25	3.2	29.6	378	3.83	4.69	189	2.52	2.91	125	1.87	2.12	—	—	—	—	—	—	
9.40	4.0	37.6	372	6.18	7.15	186	3.96	4.36	123	2.89	3.14	—	—	—	—	—	—	
9.87	3.0	29.6	355	3.20	4.05	177	2.15	2.54	118	1.61	1.86	—	—	—	—	—	—	
ARC-LENGTH CORRECTION FACTOR												0.0	0.0	0.0	0.0	0.0	0.0	0.0
9.89	3.8	37.6	354	5.62	6.55	177	3.61	4.00	117	2.64	2.89	—	—	—	—	—	—	
10.44	3.6	37.6	335	5.04	5.95	168	3.25	3.64	111	2.38	2.63	—	—	—	—	—	—	
11.06	3.4	37.6	316	4.44	5.32	158	2.89	3.28	105	2.13	2.38	—	—	—	—	—	—	
11.75	3.2	37.6	298	3.83	4.69	149	2.52	2.91	99	1.87	2.12	—	—	—	—	—	—	
12.53	3.0	37.6	279	3.20	4.05	140	2.16	2.54	93	1.61	1.86	—	—	—	—	—	—	
ARC-LENGTH CORRECTION FACTOR												0.0	0.0	0.0	0.0	0.0	0.0	0.0

A = STANDARD V-BELT
 AX = COGGED/NOTCHED V-BELT
 + IF RIM SPEED EXCEEDS 6500 FEET PER MINUTE, CONSULT *Martin*.



Stock Drive Selection **A**

Nominal Center Distances And Arc-Length Correction Factor												Sheave Combination		Speed Ratio
A/AX Belt Length Designation												DriveR P.D.	DriveN P.D.	
55	60	68	75	80	85	90	96	105	112	120	128			
—	—	—	—	—	18.0	21.0	24.4	29.2	33.0	37.1	41.3	3.4	24.6	7.24
—	—	—	—	—	—	—	—	23.2	27.3	31.7	36.0	4.0	29.6	7.40
—	—	—	—	—	—	—	—	—	—	—	26.1	5.0	37.6	7.52
—	—	—	—	—	18.2	21.1	24.5	29.4	33.1	37.3	41.4	3.2	24.6	7.69
—	—	—	—	—	—	—	—	23.4	27.4	31.8	36.1	3.8	29.6	7.79
0.0	0.0	0.0	0.0	0.0	0.82	0.88	0.93	0.99	1.02	1.05	1.08			
—	—	—	—	—	—	—	—	—	—	—	26.2	4.8	37.6	7.83
—	—	—	—	—	—	—	—	—	—	—	26.3	4.6	37.6	8.17
—	—	—	—	—	18.3	21.2	24.6	29.5	33.2	37.4	41.6	3.0	24.6	8.20
—	—	—	—	—	—	—	—	23.5	27.5	31.9	36.2	3.6	29.6	8.22
—	—	—	—	—	—	—	—	—	—	—	26.5	4.4	37.6	8.55
0.0	0.0	0.0	0.0	0.0	0.82	0.88	0.93	0.99	1.02	1.05	1.08			
—	—	—	—	—	—	—	—	23.6	27.6	32.1	36.4	3.4	29.6	8.71
—	—	—	—	—	—	—	—	—	—	—	26.6	4.2	37.6	8.95
—	—	—	—	—	—	—	—	23.7	27.7	32.2	36.5	3.2	29.6	9.25
—	—	—	—	—	—	—	—	—	—	—	26.7	4.0	37.6	9.40
—	—	—	—	—	—	—	18.2	23.8	27.9	32.3	36.6	3.0	29.6	9.87
0.0	0.0	0.0	0.0	0.0	0.0	0.0	0.73	0.88	0.95	1.00	1.03			
—	—	—	—	—	—	—	—	—	—	—	26.8	3.8	37.6	9.89
—	—	—	—	—	—	—	—	—	—	—	26.9	3.6	37.6	10.44
—	—	—	—	—	—	—	—	—	—	—	27.0	3.4	37.6	11.06
—	—	—	—	—	—	—	—	—	—	—	27.2	3.2	37.6	11.75
—	—	—	—	—	—	—	—	—	—	—	27.3	3.0	37.6	12.53
0.0	0.0	0.0	0.0	0.0	0.0	0.0	0.0	0.0	0.0	0.0	0.87			

FOR BELT SIZES NOT SHOWN, INTERPOLATE FOR ADDITIONAL CENTER DISTANCE.

V-BELT DRIVES

B Stock Drive Selection



V-BELT DRIVES

Speed Ratio	Sheave Combination		DriveN Speeds and HP Per Belt									Nominal Center Distance And Arc-Length Correction Factor					
			3500 RPM DriveR			1750 RPM DriveR			1160 RPM DriveR								
	DriveR P.D.	DriveN P.D.	DriveN RPM	HP Per Belt B	HP Per Belt BX	DriveN RPM	HP Per Belt B	HP Per Belt BX	DriveN RPM	HP Per Belt B	HP Per Belt BX	B/BX Belt Length Designation					
												35	38	42	46	51	60
1.00	3.4	3.4	3500	0.0	3.34	1750	0.91	2.57	1160	0.94	2.00	13.1	14.6	16.6	18.6	21.1	25.6
1.00	3.6	3.6	3500	0.67	4.38	1750	1.49	3.17	1160	1.34	2.42	12.7	14.2	16.2	18.2	20.7	25.2
1.00	3.8	3.8	3500	1.59	5.39	1750	2.06	3.77	1160	1.75	2.83	12.4	13.9	15.9	17.9	20.4	24.9
1.00	4.0	4.0	3500	2.50	6.38	1750	2.62	4.36	1160	2.15	3.25	12.1	13.6	15.6	17.6	20.1	24.6
1.00	4.2	4.2	3500	3.37	7.35	1750	3.18	4.95	1160	2.55	3.66	11.8	13.3	15.3	17.3	19.8	24.3
ARC-LENGTH CORRECTION FACTOR												0.77	0.79	0.81	0.83	0.86	0.90
1.00	4.4	4.4	3500	4.22	8.30	1750	3.74	5.53	1160	2.94	4.06	11.5	13.0	15.0	17.0	19.5	24.0
1.00	4.6	4.6	3500	5.04	9.22	1750	4.29	6.10	1160	3.33	4.47	11.2	12.7	14.7	16.7	19.2	23.7
1.00	4.8	4.8	3500	5.84	10.12	1750	4.83	6.67	1160	3.72	4.88	10.9	12.4	14.4	16.4	18.9	23.4
1.00	5.0	5.0	3500	6.60	11.00	1750	5.37	7.24	1160	4.11	5.28	10.5	12.0	14.0	16.0	18.5	23.0
1.00	5.2	5.2	3500	7.34	11.86	1750	5.90	7.80	1160	4.50	5.68	10.2	11.7	13.7	15.7	18.2	22.7
ARC-LENGTH CORRECTION FACTOR												0.77	0.79	0.81	0.83	0.86	0.90
1.00	5.4	5.4	3500	8.04	12.69	1750	6.43	8.36	1160	4.88	6.07	9.9	11.4	13.4	15.4	17.9	22.4
1.00	5.6	5.6	3500	8.72	13.49	1750	6.95	8.91	1160	5.26	6.47	9.6	11.1	13.1	15.1	17.6	22.1
1.00	5.8	5.8	3500	9.36	14.27	1750	7.46	9.46	1160	5.64	6.86	9.3	10.8	12.8	14.8	17.3	21.8
1.00	6.0	6.0	3500	9.96	15.03	1750	7.97	10.00	1160	6.01	7.25	9.0	10.5	12.5	14.5	17.0	21.5
1.00	6.2	6.2	3500	10.54	15.75	1750	8.47	10.54	1160	6.38	7.64	8.7	10.2	12.2	14.2	16.7	21.2
ARC-LENGTH CORRECTION FACTOR												0.77	0.79	0.81	0.83	0.86	0.90
1.00	6.4	6.4	3500	11.08	16.45	1750	8.97	11.07	1160	6.75	8.03	8.3	9.8	11.8	13.8	16.3	20.8
1.00	6.6	6.6	3500	11.58	17.12	1750	9.46	11.60	1160	7.12	8.41	—	9.5	11.5	13.5	16.0	20.5
1.00	6.8	6.8	3500	12.05	17.76	1750	9.95	12.13	1160	7.48	8.80	—	9.2	11.2	13.2	15.7	20.2
1.00	7.0	7.0	3500	12.48	18.37	1750	10.43	12.64	1160	7.85	9.18	—	8.9	10.9	12.9	15.4	19.9
1.00	7.4	7.4	+	+	+	1750	11.37	13.67	1160	8.56	9.93	—	—	10.3	12.3	14.8	19.3
ARC-LENGTH CORRECTION FACTOR												0.77	0.79	0.81	0.83	0.86	0.90
1.00	8.0	8.0	+	+	+	1750	12.73	15.16	1160	9.62	11.05	—	—	—	11.3	13.8	18.3
1.00	8.6	8.6	+	+	+	1750	14.03	16.61	1160	10.66	12.15	—	—	—	—	12.9	17.4
1.00	9.4	9.4	+	+	+	1750	15.68	18.46	1160	12.00	13.58	—	—	—	—	11.6	16.1
1.03	5.8	6.0	3383	9.64	14.52	1692	7.60	9.58	1121	5.73	6.94	9.1	10.6	12.6	14.6	17.1	21.6
1.03	6.0	6.2	3387	10.25	15.27	1694	8.11	10.12	1123	6.10	7.33	8.8	10.3	12.3	14.3	16.8	21.3
ARC-LENGTH CORRECTION FACTOR												0.77	0.79	0.81	0.83	0.86	0.90
1.03	6.2	6.4	3391	10.82	15.99	1695	8.62	10.66	1124	6.48	7.72	8.5	10.0	12.0	14.0	16.5	21.0
1.03	6.4	6.6	3394	11.36	16.69	1697	9.11	11.20	1125	6.85	8.11	—	9.7	11.7	13.7	16.2	20.7
1.03	6.6	6.8	3397	11.87	17.36	1699	9.60	11.72	1126	7.21	8.50	—	9.4	11.4	13.4	15.9	20.4
1.03	6.8	7.0	3400	12.33	18.00	1700	10.09	12.25	1127	7.58	8.88	—	9.1	11.1	13.1	15.6	20.1
1.04	4.6	4.8	3354	5.41	9.54	1677	4.47	6.26	1112	3.46	4.58	11.0	12.5	14.5	16.5	19.0	23.5
ARC-LENGTH CORRECTION FACTOR												0.77	0.79	0.81	0.83	0.86	0.90
1.04	4.8	5.0	3360	6.21	10.44	1680	5.02	6.83	1114	3.85	4.98	10.7	12.2	14.2	16.2	18.7	23.2
1.04	5.0	5.2	3365	6.97	11.32	1683	5.55	7.40	1115	4.23	5.38	10.4	11.9	13.9	15.9	18.4	22.9
1.04	5.2	5.4	3370	7.71	12.17	1685	6.08	7.96	1117	4.62	5.78	10.1	11.6	13.6	15.6	18.1	22.6
1.04	5.4	5.6	3375	8.41	13.00	1687	6.61	8.52	1119	5.00	6.18	9.8	11.3	13.3	15.3	17.8	22.3
1.04	5.6	5.8	3379	9.08	13.81	1690	7.13	9.07	1120	5.38	6.57	9.4	10.9	12.9	14.9	17.4	21.9
ARC-LENGTH CORRECTION FACTOR												0.77	0.79	0.81	0.83	0.86	0.90
1.05	3.8	4.0	3325	2.04	5.77	1662	2.28	3.96	1102	1.90	2.96	12.3	13.8	15.8	17.8	20.3	24.8
1.05	4.0	4.2	3333	2.95	6.76	1667	2.85	4.55	1105	2.30	3.37	12.0	13.5	15.5	17.5	20.0	24.5
1.05	4.2	4.4	3341	3.82	7.73	1670	3.41	5.14	1107	2.70	3.78	11.6	13.1	15.1	17.1	19.6	24.1
1.05	4.4	4.6	3348	4.67	8.68	1674	3.96	5.72	1110	3.09	4.19	11.3	12.8	14.8	16.8	19.3	23.8
1.06	3.4	3.6	3306	0.24	3.79	1653	1.17	2.80	1096	1.11	2.15	12.9	14.4	16.4	18.4	20.9	25.4
ARC-LENGTH CORRECTION FACTOR												0.77	0.79	0.81	0.83	0.86	0.90
1.06	3.6	3.8	3316	1.19	4.83	1658	1.75	3.40	1099	1.52	2.57	12.6	14.1	16.1	18.1	20.6	25.1
1.06	6.2	6.6	3288	11.06	16.20	1644	8.74	10.77	1090	6.56	7.79	8.3	9.8	11.8	13.8	16.3	20.8
1.06	6.4	6.8	3294	11.60	16.90	1647	9.23	11.30	1092	6.93	8.18	—	9.5	11.5	13.5	16.0	20.5
1.06	6.6	7.0	3300	12.11	17.57	1650	9.73	11.83	1094	7.29	8.56	—	9.2	11.2	13.2	15.7	20.2
1.06	7.0	7.4	3311	13.01	18.82	1655	10.69	12.87	1097	8.02	9.33	—	—	10.6	12.6	15.1	19.6
ARC-LENGTH CORRECTION FACTOR												0.77	0.79	0.81	0.83	0.86	0.90
1.07	5.4	5.8	3259	8.64	13.20	1629	6.73	8.62	1080	5.08	6.24	9.6	11.1	13.1	15.1	17.6	22.1
1.07	5.6	6.0	3267	9.31	14.01	1633	7.25	9.17	1083	5.46	6.64	9.3	10.8	12.8	14.8	17.3	21.8
1.07	5.8	6.2	3274	9.95	14.79	1637	7.76	9.72	1085	5.83	7.03	9.0	10.5	12.5	14.5	17.0	21.5
1.07	6.0	6.4	3281	10.56	15.54	1641	8.27	10.26	1088	6.21	7.42	8.7	10.2	12.2	14.2	16.7	21.2
1.07	8.0	8.6	+	+	+	1628	13.03	15.42	1079	9.82	11.22	—	—	—	10.9	13.4	17.9
ARC-LENGTH CORRECTION FACTOR												0.76	0.78	0.81	0.83	0.86	0.90

B = STANDARD V-BELT
 BX = COGGED/NOTCHED V-BELT
 + IF RIM SPEED EXCEEDS 6500 FEET PER MINUTE, CONSULT *Martin*.



Stock Drive Selection **B**

Nominal Center Distances And Arc-Length Correction Factor															Sheave Combination		Speed Ratio
B/BX Belt Length Designation															DriveR P.D.	DriveN P.D.	
68	75	81	85	90	97	105	112	120	128	158	180	210	240	300			
29.6	33.1	36.1	38.1	40.6	44.1	48.1	51.6	55.6	59.6	74.6	85.6	100.6	114.8	144.8	3.4	3.4	1.00
29.2	32.7	35.7	37.7	40.2	43.7	47.7	51.2	55.2	59.2	74.2	85.2	100.2	114.5	144.5	3.6	3.6	1.00
28.9	32.4	35.4	37.4	39.9	43.4	47.4	50.9	54.9	58.9	73.9	84.9	99.9	114.2	144.2	3.8	3.8	1.00
28.6	32.1	35.1	37.1	39.6	43.1	47.1	50.6	54.6	58.6	73.6	84.6	99.6	113.9	143.9	4.0	4.0	1.00
28.3	31.8	34.8	36.8	39.3	42.8	46.8	50.3	54.3	58.3	73.3	84.3	99.3	113.6	143.6	4.2	4.2	1.00
0.93	0.95	0.97	0.99	1.00	1.02	1.04	1.05	1.07	1.09	1.14	1.17	1.21	1.24	1.30			
28.0	31.5	34.5	36.5	39.0	42.5	46.5	50.0	54.0	58.0	73.0	84.0	99.0	113.2	143.2	4.4	4.4	1.00
27.7	31.2	34.2	36.2	38.7	42.2	46.2	49.7	53.7	57.7	72.7	83.7	98.7	112.9	142.9	4.6	4.6	1.00
27.4	30.9	33.9	35.9	38.4	41.9	45.9	49.4	53.4	57.4	72.4	83.4	98.4	112.6	142.6	4.8	4.8	1.00
27.0	30.5	33.5	35.5	38.0	41.5	45.5	49.0	53.0	57.0	72.0	83.0	98.0	112.3	142.3	5.0	5.0	1.00
26.7	30.2	33.2	35.2	37.7	41.2	45.2	48.7	52.7	56.7	71.7	82.7	97.7	112.0	142.0	5.2	5.2	1.00
0.93	0.95	0.97	0.99	1.00	1.02	1.04	1.05	1.07	1.09	1.14	1.17	1.21	1.24	1.30			
26.4	29.9	32.9	34.9	37.4	40.9	44.9	48.4	52.4	56.4	71.4	82.4	97.4	111.7	141.7	5.4	5.4	1.00
26.1	29.6	32.6	34.6	37.1	40.6	44.6	48.1	52.1	56.1	71.1	82.1	97.1	111.4	141.4	5.6	5.6	1.00
25.8	29.3	32.3	34.3	36.8	40.3	44.3	47.8	51.8	55.8	70.8	81.8	96.8	111.0	141.0	5.8	5.8	1.00
25.5	29.0	32.0	34.0	36.5	40.0	44.0	47.5	51.5	55.5	70.5	81.5	96.5	110.7	140.7	6.0	6.0	1.00
25.2	28.7	31.7	33.7	36.2	39.7	43.7	47.2	51.2	55.2	70.2	81.2	96.2	110.4	140.4	6.2	6.2	1.00
0.93	0.95	0.97	0.99	1.00	1.02	1.04	1.05	1.07	1.09	1.14	1.17	1.21	1.24	1.30			
24.8	28.3	31.3	33.3	35.8	39.3	43.3	46.8	50.8	54.8	69.8	80.8	95.8	110.1	140.1	6.4	6.4	1.00
24.5	28.0	31.0	33.0	35.5	39.0	43.0	46.5	50.5	54.5	69.5	80.5	95.5	109.8	139.8	6.6	6.6	1.00
24.2	27.7	30.7	32.7	35.2	38.7	42.7	46.2	50.2	54.2	69.2	80.2	95.2	109.5	139.5	6.8	6.8	1.00
23.9	27.4	30.4	32.4	34.9	38.4	42.4	45.9	49.9	53.9	68.9	79.9	94.9	109.2	139.2	7.0	7.0	1.00
23.3	26.8	29.8	31.8	34.3	37.8	41.8	45.3	49.3	53.3	68.3	79.3	94.3	108.5	138.5	7.4	7.4	1.00
0.93	0.95	0.97	0.99	1.00	1.02	1.04	1.05	1.07	1.09	1.14	1.17	1.21	1.24	1.30			
22.3	25.8	28.8	30.8	33.3	36.8	40.8	44.3	48.3	52.3	67.3	78.3	93.3	107.6	137.6	8.0	8.0	1.00
21.4	24.9	27.9	29.9	32.4	35.9	39.9	43.4	47.4	51.4	66.4	77.4	92.4	106.6	136.6	8.6	8.6	1.00
20.1	23.6	26.6	28.6	31.1	34.6	38.6	42.1	46.1	50.1	65.1	76.1	91.1	105.4	135.4	9.4	9.4	1.00
25.6	29.1	32.1	34.1	36.6	40.1	44.1	47.6	51.6	55.6	70.6	81.6	96.6	110.9	140.9	5.8	6.0	1.03
25.3	28.8	31.8	33.8	36.3	39.8	43.8	47.3	51.3	55.3	70.3	81.3	96.3	110.6	140.6	6.0	6.2	1.03
0.93	0.95	0.97	0.99	1.00	1.02	1.04	1.05	1.07	1.09	1.14	1.17	1.21	1.24	1.30			
25.0	28.5	31.5	33.5	36.0	39.5	43.5	47.0	51.0	55.0	70.0	81.0	96.0	110.3	140.3	6.2	6.4	1.03
24.7	28.2	31.2	33.2	35.7	39.2	43.2	46.7	50.7	54.7	69.7	80.7	95.7	109.9	139.9	6.4	6.6	1.03
24.4	27.9	30.9	32.9	35.4	38.9	42.9	46.4	50.4	54.4	69.4	80.4	95.4	109.6	139.6	6.6	6.8	1.03
24.1	27.6	30.6	32.6	35.1	38.6	42.6	46.1	50.1	54.1	69.1	80.1	95.1	109.3	139.3	6.8	7.0	1.03
27.5	31.0	34.0	36.0	38.5	42.0	46.0	49.5	53.5	57.5	72.5	83.5	98.5	112.8	142.8	4.6	4.8	1.04
0.93	0.95	0.97	0.99	1.00	1.02	1.04	1.05	1.07	1.09	1.14	1.17	1.21	1.24	1.30			
27.2	30.7	33.7	35.7	38.2	41.7	45.7	49.2	53.2	57.2	72.2	83.2	98.2	112.5	142.5	4.8	5.0	1.04
26.9	30.4	33.4	35.4	37.9	41.4	45.4	48.9	52.9	56.9	71.9	82.9	97.9	112.1	142.1	5.0	5.2	1.04
26.6	30.1	33.1	35.1	37.6	41.1	45.1	48.6	52.6	56.6	71.6	82.6	97.6	111.8	141.8	5.2	5.4	1.04
26.3	29.8	32.8	34.8	37.3	40.8	44.8	48.3	52.3	56.3	71.3	82.3	97.3	111.5	141.5	5.4	5.6	1.04
25.9	29.4	32.4	34.4	36.9	40.4	44.4	47.9	51.9	55.9	70.9	81.9	96.9	111.2	141.2	5.6	5.8	1.04
0.93	0.95	0.97	0.99	1.00	1.02	1.04	1.05	1.07	1.09	1.14	1.17	1.21	1.24	1.30			
28.8	32.3	35.3	37.3	39.8	43.3	47.3	50.8	54.8	58.8	73.8	84.8	99.8	114.0	144.0	3.8	4.0	1.05
28.5	32.0	35.0	37.0	39.5	43.0	47.0	50.5	54.5	58.5	73.5	84.5	99.5	113.7	143.7	4.0	4.2	1.05
28.1	31.6	34.6	36.6	39.1	42.6	46.6	50.1	54.1	58.1	73.1	84.1	99.1	113.4	143.4	4.2	4.4	1.05
27.8	31.3	34.3	36.3	38.8	42.3	46.3	49.8	53.8	57.8	72.8	83.8	98.8	113.1	143.1	4.4	4.6	1.05
29.4	32.9	35.9	37.9	40.4	43.9	47.9	51.4	55.4	59.4	74.4	85.4	100.4	114.7	144.7	3.4	3.6	1.06
0.93	0.95	0.97	0.99	1.00	1.02	1.04	1.05	1.07	1.09	1.14	1.17	1.21	1.24	1.30			
29.1	32.6	35.6	37.6	40.1	43.6	47.6	51.1	55.1	59.1	74.1	85.1	100.1	114.3	144.3	3.6	3.8	1.06
24.8	28.3	31.3	33.3	35.8	39.3	43.3	46.8	50.8	54.8	69.8	80.8	95.8	110.1	140.1	6.2	6.6	1.06
24.5	28.0	31.0	33.0	35.5	39.0	43.0	46.5	50.5	54.5	69.5	80.5	95.5	109.8	139.8	6.4	6.8	1.06
24.2	27.7	30.7	32.7	35.2	38.7	42.7	46.2	50.2	54.2	69.2	80.2	95.2	109.5	139.5	6.6	7.0	1.06
23.6	27.1	30.1	32.1	34.6	38.1	42.1	45.6	49.6	53.6	68.6	79.6	94.6	108.8	138.8	7.0	7.4	1.06
0.93	0.95	0.97	0.99	1.00	1.02	1.04	1.05	1.07	1.09	1.14	1.17	1.21	1.24	1.30			
26.1	29.6	32.6	34.6	37.1	40.6	44.6	48.1	52.1	56.1	71.1	82.1	97.1	111.4	141.4	5.4	5.8	1.07
25.8	29.3	32.3	34.3	36.8	40.3	44.3	47.8	51.8	55.8	70.8	81.8	96.8	111.0	141.0	5.6	6.0	1.07
25.5	29.0	32.0	34.0	36.5	40.0	44.0	47.5	51.5	55.5	70.5	81.5	96.5	110.7	140.7	5.8	6.2	1.07
25.2	28.7	31.7	33.7	36.2	39.7	43.7	47.2	51.2	55.2	70.2	81.2	96.2	110.4	140.4	6.0	6.4	1.07
21.9	25.4	28.4	30.4	32.9	36.4	40.4	43.9	47.9	51.9	66.9	77.9	92.9	107.1	137.1	8.0	8.6	1.07
0.93	0.95	0.97	0.99	1.00	1.02	1.04	1.05	1.07	1.09	1.14	1.17	1.21	1.24	1.30			

FOR BELT SIZES NOT SHOWN, INTERPOLATE FOR ADDITIONAL CENTER DISTANCE.

V-BELT DRIVES

B Stock Drive Selection



V-BELT DRIVES

Speed Ratio	Sheave Combination		DriveN Speeds and HP Per Belt									Nominal Center Distance And Arc-Length Correction Factors					
			3500 RPM DriveR			1750 RPM DriveR			1160 RPM DriveR								
	DriveR P.D.	DriveN P.D.	DriveN RPM	HP Per Belt B	HP Per Belt BX	DriveN RPM	HP Per Belt B	HP Per Belt BX	DriveN RPM	HP Per Belt B	HP Per Belt BX	B/BX Belt Length Designation					
												35	38	42	46	51	60
1.08	4.8	5.2	3231	6.50	10.70	1615	5.16	6.96	1071	3.95	5.06	10.5	12.0	14.0	16.0	18.5	23.0
1.08	5.0	5.4	3241	7.27	11.57	1620	5.70	7.53	1074	4.33	5.47	10.2	11.7	13.7	15.7	18.2	22.7
1.08	5.2	5.6	3250	8.00	12.43	1625	6.23	8.09	1077	4.72	5.87	9.9	11.4	13.4	15.4	17.9	22.4
1.08	7.4	8.0	+	+	+	1619	11.70	13.95	1073	8.79	10.12	—	—	9.8	11.8	14.3	18.8
1.09	4.4	4.8	3208	4.95	8.92	1604	4.10	5.84	1063	3.18	4.27	11.2	12.7	14.7	16.7	19.2	23.7
ARC-LENGTH CORRECTION FACTOR												0.76	0.78	0.81	0.83	0.86	0.90
1.09	4.6	5.0	3220	5.78	9.85	1610	4.65	6.42	1067	3.58	4.68	10.9	12.4	14.4	16.4	18.9	23.4
1.09	6.4	7.0	3200	11.81	17.08	1600	9.34	11.39	1061	7.00	8.24	—	9.4	11.4	13.4	15.9	20.4
1.09	6.8	7.4	3216	12.78	18.38	1608	10.31	12.44	1066	7.73	9.01	—	—	10.7	12.7	15.2	19.7
1.09	8.6	9.4	+	+	+	1601	14.40	16.92	1061	10.90	12.36	—	—	—	—	12.3	16.8
1.10	4.0	4.4	3182	3.29	7.06	1591	3.02	4.70	1055	2.41	3.47	11.8	13.3	15.3	17.3	19.8	24.3
ARC-LENGTH CORRECTION FACTOR												0.76	0.78	0.81	0.83	0.86	0.90
1.10	4.2	4.6	3196	4.17	8.03	1598	3.58	5.29	1059	2.81	3.88	11.5	13.0	15.0	17.0	19.5	24.0
1.10	5.8	6.4	3172	10.15	14.95	1586	7.86	9.80	1051	5.90	7.09	8.8	10.3	12.3	14.3	16.8	21.3
1.10	6.0	6.6	3182	10.76	15.71	1591	8.37	10.34	1055	6.27	7.48	8.5	10.0	12.0	14.0	16.5	21.0
1.10	6.2	6.8	3191	11.33	16.43	1596	8.87	10.88	1058	6.65	7.87	—	9.7	11.7	13.7	16.2	20.7
1.11	3.6	4.0	3150	1.52	5.11	1575	1.91	3.54	1044	1.63	2.66	12.4	13.9	15.9	17.9	20.4	24.9
ARC-LENGTH CORRECTION FACTOR												0.76	0.79	0.81	0.83	0.86	0.90
1.11	3.8	4.2	3167	2.45	6.12	1583	2.49	4.14	1050	2.03	3.07	12.1	13.6	15.6	17.6	20.1	24.6
1.11	5.4	6.0	3150	8.89	13.42	1575	6.85	8.72	1044	5.16	6.32	9.4	10.9	12.9	14.9	17.4	21.9
1.11	5.6	6.2	3161	9.57	14.22	1581	7.37	9.28	1048	5.54	6.71	9.1	10.6	12.6	14.6	17.1	21.6
1.12	3.4	3.8	3132	0.62	4.12	1566	1.36	2.96	1038	1.24	2.26	12.7	14.2	16.2	18.2	20.7	25.2
1.12	4.8	5.4	3111	6.75	10.90	1556	5.28	7.06	1031	4.03	5.13	10.4	11.9	13.9	15.9	18.4	22.9
ARC-LENGTH CORRECTION FACTOR												0.77	0.79	0.81	0.83	0.86	0.90
1.12	5.0	5.6	3125	7.51	11.78	1563	5.82	7.63	1036	4.41	5.54	10.1	11.6	13.6	15.6	18.1	22.6
1.12	5.2	5.8	3138	8.25	12.64	1569	6.35	8.19	1040	4.80	5.93	9.8	11.3	13.3	15.3	17.8	22.3
1.12	6.6	7.4	3122	12.49	17.90	1561	9.92	11.99	1035	7.42	8.67	—	8.9	10.9	12.9	15.4	19.9
1.13	4.6	5.2	3096	6.00	10.04	1548	4.77	6.51	1026	3.65	4.74	10.7	12.2	14.2	16.2	18.7	23.2
1.13	6.0	6.8	3088	10.92	15.85	1544	8.45	10.41	1024	6.33	7.53	8.3	9.8	11.8	13.8	16.3	20.8
ARC-LENGTH CORRECTION FACTOR												0.76	0.78	0.81	0.83	0.86	0.90
1.13	6.2	7.0	3100	11.50	16.57	1550	8.95	10.95	1027	6.70	7.92	—	9.5	11.5	13.5	16.0	20.5
1.14	4.2	4.8	3062	4.38	8.21	1531	3.69	5.38	1015	2.88	3.94	11.3	12.8	14.8	16.8	19.3	23.8
1.14	4.4	5.0	3080	5.23	9.16	1540	4.24	5.96	1021	3.28	4.35	11.0	12.5	14.5	16.5	19.0	23.5
1.14	5.6	6.4	3062	9.73	14.36	1531	7.45	9.34	1015	5.59	6.76	9.0	10.5	12.5	14.5	17.0	21.5
1.14	5.8	6.6	3076	10.37	15.14	1538	7.97	9.89	1019	5.97	7.15	8.7	10.2	12.2	14.2	16.7	21.2
ARC-LENGTH CORRECTION FACTOR												0.76	0.78	0.81	0.83	0.86	0.90
1.14	7.0	8.0	3063	13.49	19.23	1531	10.93	13.08	1015	8.18	9.46	—	—	10.1	12.1	14.6	19.1
1.15	4.0	4.6	3043	3.55	7.28	1522	3.15	4.81	1009	2.50	3.55	11.6	13.1	15.1	17.1	19.6	24.1
1.15	5.2	6.0	3033	8.39	12.76	1517	6.43	8.26	1005	4.85	5.98	9.6	11.1	13.1	15.1	17.6	22.1
1.15	5.4	6.2	3048	9.10	13.59	1524	6.95	8.81	1010	5.23	6.37	9.3	10.8	12.8	14.8	17.3	21.8
1.16	3.8	4.4	3023	2.70	6.33	1511	2.61	4.24	1002	2.11	3.15	12.0	13.5	15.5	17.5	20.0	24.5
ARC-LENGTH CORRECTION FACTOR												0.76	0.78	0.81	0.83	0.86	0.90
1.16	5.0	5.8	3017	7.70	11.95	1509	5.92	7.71	1000	4.48	5.59	9.9	11.4	13.4	15.4	17.9	22.4
1.16	6.4	7.4	3027	12.18	17.39	1514	9.52	11.55	1003	7.12	8.34	—	9.0	11.1	13.1	15.6	20.1
1.16	7.4	8.6	+	+	+	1506	11.92	14.14	998	8.93	10.25	—	—	—	11.3	13.8	18.3
1.17	3.6	4.2	3000	1.81	5.36	1500	2.06	3.67	994	1.72	2.74	12.3	13.8	15.8	17.8	20.3	24.8
1.17	4.6	5.4	2981	6.19	10.20	1491	4.86	6.59	988	3.71	4.80	10.5	12.0	14.0	16.0	18.5	23.0
ARC-LENGTH CORRECTION FACTOR												0.76	0.78	0.81	0.83	0.85	0.90
1.17	4.8	5.6	3000	6.98	11.11	1500	5.40	7.16	994	4.10	5.20	10.2	11.7	13.7	15.7	18.2	22.7
1.17	5.8	6.8	2985	10.50	15.25	1493	8.03	9.95	989	6.02	7.19	8.5	10.0	12.0	14.0	16.5	21.0
1.17	6.0	7.0	3000	11.11	16.01	1500	8.54	10.49	994	6.39	7.58	—	9.7	11.7	13.7	16.2	20.7
1.17	8.0	9.4	+	+	+	1489	13.30	15.65	987	10.00	11.38	—	—	—	—	12.7	17.2
1.17	9.4	11.0	+	+	+	1495	16.25	18.95	991	12.38	13.91	—	—	—	—	—	14.9
ARC-LENGTH CORRECTION FACTOR												0.76	0.78	0.81	0.83	0.86	0.90
1.18	3.4	4.0	2975	0.90	4.36	1487	1.50	3.08	986	1.33	2.33	12.6	14.1	16.1	18.1	20.6	25.1
1.18	4.4	5.2	2962	5.41	9.31	1481	4.33	6.03	982	3.33	4.40	10.9	12.4	14.4	16.4	18.9	23.4
1.18	5.6	6.6	2970	9.90	14.51	1485	7.54	9.42	984	5.65	6.81	8.8	10.3	12.3	14.3	16.8	21.3
1.18	6.8	8.0	2975	13.24	18.77	1487	10.54	12.63	986	7.88	9.13	—	—	10.3	12.3	14.8	19.3
1.19	4.2	5.0	2940	4.60	8.40	1470	3.80	5.47	974	2.95	4.00	11.2	12.7	14.7	16.7	19.2	23.7
ARC-LENGTH CORRECTION FACTOR												0.76	0.78	0.81	0.83	0.86	0.90

B = STANDARD V-BELT
 BX = COGGED/NOTCHED V-BELT
 + IF RIM SPEED EXCEEDS 6500 FEET PER MINUTE, CONSULT *Martin*.



Stock Drive Selection **B**

V-BELT DRIVES

Nominal Center Distances And Arc-Length Correction Factor															Sheave Combination		Speed Ratio
B/BX Belt Length Designation															DriveR P.D.	DriveN P.D.	
68	75	81	85	90	97	105	112	120	128	158	180	210	240	300			
27.0	30.5	33.5	35.5	38.0	41.5	45.5	49.0	53.0	57.0	72.0	83.0	98.0	112.3	142.3	4.8	5.2	1.08
26.7	30.2	33.2	35.2	37.7	41.2	45.2	48.7	52.7	56.7	71.7	82.7	97.7	112.0	142.0	5.0	5.4	1.08
26.4	29.9	32.9	34.9	37.4	40.9	44.9	48.4	52.4	56.4	71.4	82.4	97.4	111.7	141.7	5.2	5.6	1.08
22.8	26.3	29.3	31.3	33.8	37.3	41.3	44.8	48.8	52.8	67.8	78.8	93.8	108.1	138.1	7.4	8.0	1.08
27.7	31.2	34.2	36.2	38.7	42.2	46.2	49.7	53.7	57.7	72.7	83.7	98.7	112.9	142.9	4.4	4.8	1.09
0.93	0.95	0.97	0.98	1.00	1.02	1.04	1.05	1.07	1.09	1.14	1.17	1.21	1.24	1.30			
27.4	30.9	33.9	35.9	38.4	41.9	45.9	49.4	53.4	57.4	72.4	83.4	98.4	112.6	142.6	4.6	5.0	1.09
24.4	27.9	30.9	32.9	35.4	38.9	42.9	46.4	50.4	54.4	69.4	80.4	95.4	109.6	139.6	6.4	7.0	1.09
23.7	27.2	30.2	32.2	34.7	38.2	42.2	45.7	49.7	53.7	68.7	79.7	94.7	109.0	139.0	6.8	7.4	1.09
20.8	24.3	27.3	29.3	31.8	35.3	39.3	42.8	46.8	50.8	65.8	76.8	91.8	106.0	136.0	8.6	9.4	1.09
28.3	31.8	34.8	36.8	39.3	42.8	46.8	50.3	54.3	58.3	73.3	84.3	99.3	113.6	143.6	4.0	4.4	1.10
0.93	0.95	0.97	0.98	1.00	1.02	1.04	1.05	1.07	1.09	1.14	1.17	1.21	1.24	1.30			
28.0	31.5	34.5	36.5	39.0	42.5	46.5	50.0	54.0	58.0	73.0	84.0	99.0	113.2	143.2	4.2	4.6	1.10
25.3	28.8	31.8	33.8	36.3	39.8	43.8	47.3	51.3	55.3	70.3	81.3	96.3	110.6	140.6	5.8	6.4	1.10
25.0	28.5	31.5	33.5	36.0	39.5	43.5	47.0	51.0	55.0	70.0	81.0	96.0	110.3	140.3	6.0	6.6	1.10
24.7	28.2	31.2	33.2	35.7	39.2	43.2	46.7	50.7	54.7	69.7	80.7	95.7	109.9	139.9	6.2	6.8	1.10
28.9	32.4	35.4	37.4	39.9	43.4	47.4	50.9	54.9	58.9	73.9	84.9	99.9	114.2	144.2	3.6	4.0	1.11
0.93	0.95	0.97	0.98	1.00	1.02	1.04	1.05	1.07	1.09	1.14	1.17	1.21	1.24	1.30			
28.6	32.1	35.1	37.1	39.6	43.1	47.1	50.6	54.6	58.6	73.6	84.6	99.6	113.9	143.9	3.8	4.2	1.11
25.9	29.4	32.4	34.4	36.9	40.4	44.4	47.9	51.9	55.9	70.9	81.9	96.9	111.2	141.2	5.4	6.0	1.11
25.6	29.1	32.1	34.1	36.6	40.1	44.1	47.6	51.6	55.6	70.6	81.6	96.6	110.9	140.9	5.6	6.2	1.11
29.2	32.7	35.7	37.7	40.2	43.7	47.7	51.2	55.2	59.2	74.2	85.2	100.2	114.5	144.5	3.4	3.8	1.12
26.9	30.4	33.4	35.4	37.9	41.4	45.4	48.9	52.9	56.9	71.9	82.9	97.9	112.1	142.1	4.8	5.4	1.12
0.93	0.95	0.97	0.98	1.00	1.02	1.04	1.05	1.07	1.09	1.14	1.17	1.21	1.24	1.30			
26.6	30.1	33.1	35.1	37.6	41.1	45.1	48.6	52.6	56.6	71.6	82.6	97.6	111.8	141.8	5.0	5.6	1.12
26.3	29.8	32.8	34.8	37.3	40.8	44.8	48.3	52.3	56.3	71.3	82.3	97.3	111.5	141.5	5.2	5.8	1.12
23.9	27.4	30.4	32.4	34.9	38.4	42.4	45.9	49.9	53.9	68.9	79.9	94.9	109.2	139.2	6.6	7.4	1.12
27.2	30.7	33.7	35.7	38.2	41.7	45.7	49.2	53.2	57.2	72.2	83.2	98.2	112.5	142.5	4.6	5.2	1.13
24.8	28.3	31.3	33.3	35.8	39.3	43.3	46.8	50.8	54.8	69.8	80.8	95.8	110.1	140.1	6.0	6.8	1.13
0.93	0.95	0.97	0.98	1.00	1.02	1.04	1.05	1.07	1.09	1.14	1.17	1.21	1.24	1.30			
24.5	28.0	31.0	33.0	35.5	39.0	43.0	46.5	50.5	54.5	69.5	80.5	95.5	109.8	139.8	6.2	7.0	1.13
27.8	31.3	34.3	36.3	38.8	42.3	46.3	49.8	53.8	57.8	72.8	83.8	98.8	113.1	143.1	4.2	4.8	1.14
27.5	31.0	34.0	36.0	38.5	42.0	46.0	49.5	53.5	57.5	72.5	83.5	98.5	112.8	142.8	4.4	5.0	1.14
25.5	29.0	32.0	34.0	36.5	40.0	44.0	47.5	51.5	55.5	70.5	81.5	96.5	110.7	140.7	5.6	6.4	1.14
25.2	28.7	31.7	33.7	36.2	39.7	43.7	47.2	51.2	55.2	70.2	81.2	96.2	110.4	140.4	5.8	6.6	1.14
0.93	0.95	0.97	0.98	1.00	1.02	1.04	1.05	1.07	1.09	1.14	1.17	1.21	1.24	1.30			
23.1	26.6	29.6	31.6	34.1	37.6	41.6	45.1	49.1	53.1	68.1	79.1	94.1	108.4	138.4	7.0	8.0	1.14
28.1	31.6	34.6	36.6	39.1	42.6	46.6	50.1	54.1	58.1	73.1	84.1	99.1	113.4	143.4	4.0	4.6	1.15
26.1	29.6	32.6	34.6	37.1	40.6	44.6	48.1	52.1	56.1	71.1	82.1	97.1	111.4	141.4	5.2	6.0	1.15
25.8	29.3	32.3	34.3	36.8	40.3	44.3	47.8	51.8	55.8	70.8	81.8	96.8	111.0	141.0	5.4	6.2	1.15
28.5	32.0	35.0	37.0	39.5	43.0	47.0	50.5	54.5	58.5	73.5	84.5	99.5	113.7	143.7	3.8	4.4	1.16
0.93	0.95	0.97	0.98	1.00	1.02	1.04	1.05	1.07	1.09	1.14	1.17	1.21	1.24	1.30			
26.4	29.9	32.9	34.9	37.4	40.9	44.9	48.4	52.4	56.4	71.4	82.4	97.4	111.7	141.7	5.0	5.8	1.16
24.1	27.6	30.6	32.6	35.1	38.6	42.6	46.1	50.1	54.1	69.1	80.1	95.1	109.3	139.3	6.4	7.4	1.16
22.3	25.8	28.8	30.8	33.3	36.8	40.8	44.3	48.3	52.3	67.3	78.3	93.3	107.6	137.6	7.4	8.6	1.16
28.8	32.3	35.3	37.3	39.8	43.3	47.3	50.8	54.8	58.8	73.8	84.8	99.8	114.0	144.0	3.6	4.2	1.17
27.0	30.5	33.5	35.5	38.0	41.5	45.5	49.0	53.0	57.0	72.0	83.0	98.0	112.3	142.3	4.6	5.4	1.17
0.93	0.95	0.97	0.98	1.00	1.02	1.04	1.05	1.07	1.09	1.14	1.17	1.21	1.24	1.30			
26.7	30.2	33.2	35.2	37.7	41.2	45.2	48.7	52.7	56.7	71.7	82.7	97.7	112.0	142.0	4.8	5.6	1.17
25.0	28.5	31.5	33.5	36.0	39.5	43.5	47.0	51.0	55.0	70.0	81.0	96.0	110.3	140.3	5.8	6.8	1.17
24.7	28.2	31.2	33.2	35.7	39.2	43.2	46.7	50.7	54.7	69.7	80.7	95.7	109.9	139.9	6.0	7.0	1.17
21.2	24.7	27.7	29.7	32.2	35.7	39.7	43.2	47.2	51.2	66.2	77.2	92.2	106.5	136.5	8.0	9.4	1.17
18.9	22.4	25.4	27.4	29.9	33.4	37.4	40.9	44.9	48.9	63.9	74.9	89.9	104.1	134.1	9.4	11.0	1.17
0.93	0.95	0.97	0.98	1.00	1.02	1.04	1.05	1.07	1.09	1.14	1.17	1.21	1.24	1.30			
29.1	32.6	35.6	37.6	40.1	43.6	47.6	51.1	55.1	59.1	74.1	85.1	100.1	114.3	144.3	3.4	4.0	1.18
27.4	30.9	33.9	35.9	38.4	41.9	45.9	49.4	53.4	57.4	72.4	83.4	98.4	112.6	142.6	4.4	5.2	1.18
25.3	28.8	31.8	33.8	36.3	39.8	43.8	47.3	51.3	55.3	70.3	81.3	96.3	110.6	140.6	5.6	6.6	1.18
23.3	26.8	29.8	31.8	34.3	37.8	41.8	45.3	49.3	53.3	68.3	79.3	94.3	108.5	138.5	6.8	8.0	1.18
27.7	31.2	34.2	36.2	38.7	42.2	46.2	49.7	53.7	57.7	72.7	83.7	98.7	112.9	142.9	4.2	5.0	1.19
0.93	0.95	0.97	0.98	1.00	1.02	1.04	1.05	1.07	1.09	1.14	1.17	1.21	1.24	1.30			

FOR BELT SIZES NOT SHOWN, INTERPOLATE FOR ADDITIONAL CENTER DISTANCE.



B Stock Drive Selection



V-BELT DRIVES

Speed Ratio	Sheave Combination		DriveN Speeds and HP Per Belt									Nominal Center Distance And Arc-Length Correction Factors					
			3500 RPM DriveR			1750 RPM DriveR			1160 RPM DriveR			B/BX Belt Length Designation					
	DriveR P.D.	DriveN P.D.	DriveN RPM	HP Per Belt B	HP Per Belt BX	DriveN RPM	HP Per Belt B	HP Per Belt BX	DriveN RPM	HP Per Belt B	HP Per Belt BX	35	38	42	46	51	60
1.19	5.2	6.2	2935	8.56	12.91	1468	6.51	8.33	973	4.90	6.02	9.4	10.9	12.9	14.9	17.4	21.9
1.19	5.4	6.4	2953	9.27	13.74	1477	7.04	8.88	979	5.28	6.42	9.1	10.6	12.6	14.6	17.1	21.6
1.19	6.2	7.4	2932	11.76	16.80	1466	9.09	11.07	972	6.79	7.99	—	9.2	11.2	13.2	15.7	20.2
1.20	4.0	4.8	2917	3.76	7.46	1458	3.25	4.90	967	2.57	3.60	11.5	13.0	15.0	17.0	19.5	24.0
1.20	5.0	6.0	2917	7.86	12.08	1458	6.00	7.78	967	4.53	5.64	9.7	11.2	13.3	15.3	17.8	22.3
ARC-LENGTH CORRECTION FACTOR												0.76	0.78	0.80	0.83	0.85	0.89
1.21	3.8	4.6	2891	2.89	6.50	1446	2.71	4.33	958	2.18	3.20	11.8	13.3	15.3	17.3	19.8	24.3
1.21	4.8	5.8	2897	7.13	11.23	1448	5.48	7.23	960	4.15	5.24	10.1	11.6	13.6	15.6	18.1	22.6
1.21	5.6	6.8	2882	10.01	14.60	1441	7.59	9.47	955	5.69	6.84	8.6	10.1	12.1	14.1	16.7	21.2
1.21	5.8	7.0	2900	10.65	15.38	1450	8.11	10.01	961	6.07	7.23	8.3	9.8	11.8	13.8	16.3	20.8
1.21	6.6	8.0	2887	12.88	18.23	1444	10.11	12.16	957	7.55	8.78	—	—	10.4	12.4	14.9	19.4
ARC-LENGTH CORRECTION FACTOR												0.76	0.78	0.81	0.83	0.86	0.90
1.22	3.6	4.4	2864	1.99	5.51	1432	2.15	3.74	949	1.78	2.79	12.1	13.6	15.6	17.6	20.1	24.6
1.22	4.6	5.6	2875	6.37	10.36	1437	4.95	6.67	953	3.77	4.85	10.4	11.9	13.9	15.9	18.4	22.9
1.22	5.4	6.6	2864	9.37	13.83	1432	7.09	8.93	949	5.32	6.45	9.0	10.5	12.5	14.5	17.0	21.5
1.23	4.4	5.4	2852	5.58	9.46	1426	4.42	6.11	945	3.39	4.45	10.7	12.2	14.2	16.2	18.7	23.2
1.23	5.2	6.4	2844	8.70	13.02	1422	6.58	8.39	942	4.95	6.06	9.3	10.8	12.8	14.8	17.3	21.8
ARC-LENGTH CORRECTION FACTOR												0.76	0.78	0.81	0.83	0.86	0.90
1.23	6.0	7.4	2838	11.32	16.19	1419	8.65	10.59	941	6.46	7.64	—	9.3	11.4	13.4	15.9	20.4
1.23	7.0	8.6	2849	13.84	19.53	1424	11.11	13.23	944	8.30	9.56	—	—	11.6	14.1	18.6	23.1
1.24	3.4	4.2	2833	1.10	4.53	1417	1.61	3.17	939	1.40	2.39	12.4	13.9	15.9	17.9	20.4	24.9
1.24	4.2	5.2	2827	4.76	8.54	1413	3.88	5.54	937	3.01	4.05	11.0	12.5	14.5	16.5	19.0	23.5
1.24	5.0	6.2	2823	7.99	12.19	1411	6.06	7.84	935	4.57	5.67	9.6	11.1	13.1	15.1	17.6	22.1
ARC-LENGTH CORRECTION FACTOR												0.76	0.78	0.81	0.83	0.86	0.90
1.25	4.0	5.0	2800	3.91	7.59	1400	3.33	4.97	928	2.62	3.65	11.3	12.8	14.8	16.8	19.3	23.8
1.25	4.8	6.0	2800	7.26	11.34	1400	5.54	7.28	928	4.19	5.28	9.9	11.4	13.4	15.4	17.9	22.4
1.25	5.6	7.0	2800	10.13	14.71	1400	7.66	9.52	928	5.73	6.87	8.5	10.0	12.0	14.0	16.5	21.0
1.25	6.4	8.0	2800	12.50	17.66	1400	9.68	11.68	928	7.22	8.43	—	—	10.6	12.6	15.1	19.6
1.26	3.8	4.8	2771	3.04	6.63	1385	2.78	4.39	918	2.23	3.24	11.6	13.1	15.1	17.1	19.6	24.1
ARC-LENGTH CORRECTION FACTOR												0.76	0.78	0.81	0.83	0.85	0.89
1.26	4.6	5.8	2776	6.49	10.46	1388	5.01	6.72	920	3.81	4.88	10.2	11.7	13.7	15.7	18.2	22.7
1.26	5.4	6.8	2779	9.49	13.93	1390	7.15	8.98	921	5.36	6.48	8.8	10.3	12.3	14.3	16.8	21.3
1.26	6.8	8.6	2767	13.49	19.00	1384	10.67	12.75	917	7.96	9.21	—	—	9.8	11.8	14.3	18.8
1.27	4.4	5.6	2750	5.69	9.56	1375	4.47	6.16	911	3.43	4.48	10.5	12.0	14.0	16.0	18.5	23.0
1.27	5.2	6.6	2758	8.81	13.12	1379	6.64	8.43	914	4.98	6.09	9.1	10.6	12.6	14.6	17.1	21.6
ARC-LENGTH CORRECTION FACTOR												0.76	0.78	0.80	0.83	0.85	0.89
1.27	7.4	9.4	+	+	+	1378	12.10	14.30	913	9.05	10.35	—	—	—	10.7	13.2	17.7
1.28	3.6	4.6	2739	2.16	5.66	1370	2.24	3.82	908	1.84	2.84	11.9	13.5	15.5	17.5	20.0	24.5
1.28	5.0	6.4	2734	8.10	12.28	1367	6.12	7.88	906	4.61	5.70	9.4	10.9	12.9	14.9	17.4	21.9
1.28	5.8	7.4	2743	10.85	15.55	1372	8.21	10.10	909	6.13	7.29	—	9.5	11.5	13.5	16.0	20.5
1.28	8.6	11.0	+	+	+	1368	14.78	17.25	907	11.15	12.57	—	—	—	—	—	15.5
ARC-LENGTH CORRECTION FACTOR												0.76	0.78	0.81	0.83	0.85	0.90
1.29	3.4	4.4	2705	1.23	4.65	1352	1.67	3.23	896	1.44	2.43	12.3	13.8	15.8	17.8	20.3	24.8
1.29	4.2	5.4	2722	4.89	8.65	1361	3.94	5.60	902	3.05	4.09	10.8	12.3	14.3	16.3	18.9	23.4
1.29	4.8	6.2	2710	7.36	11.43	1355	5.59	7.32	898	4.23	5.31	9.7	11.2	13.2	15.2	17.7	22.2
1.29	6.2	8.0	2712	12.06	17.05	1356	9.23	11.19	899	6.89	8.07	—	—	10.7	12.7	15.2	19.7
1.30	4.0	5.2	2692	4.04	7.70	1346	3.39	5.02	892	2.66	3.68	11.2	12.7	14.7	16.7	19.2	23.7
ARC-LENGTH CORRECTION FACTOR												0.76	0.78	0.81	0.83	0.85	0.90
1.30	4.6	6.0	2683	6.58	10.54	1342	5.06	6.76	889	3.85	4.91	10.1	11.6	13.6	15.6	18.1	22.6
1.30	5.4	7.0	2700	9.58	14.01	1350	7.20	9.02	895	5.39	6.51	8.6	10.1	12.1	14.1	16.6	21.1
1.30	6.6	8.6	2686	13.12	18.44	1343	10.23	12.26	890	7.63	8.85	—	—	9.9	11.9	14.4	18.9
1.31	5.2	6.8	2676	8.90	13.20	1338	6.68	8.47	887	5.01	6.12	8.9	10.4	12.4	14.5	17.0	21.5
1.32	3.8	5.0	2660	3.18	6.74	1330	2.85	4.45	882	2.27	3.28	11.5	13.0	15.0	17.0	19.5	24.0
ARC-LENGTH CORRECTION FACTOR												0.75	0.78	0.80	0.82	0.85	0.89
1.32	4.4	5.8	2655	5.80	9.65	1328	4.53	6.20	880	3.47	4.51	10.4	11.9	13.9	15.9	18.4	22.9
1.32	5.0	6.6	2652	8.18	12.36	1326	6.16	7.92	879	4.64	5.73	9.3	10.8	12.8	14.8	17.3	21.8
1.32	5.6	7.4	2649	10.30	14.85	1324	7.74	9.59	878	5.78	6.92	—	9.6	11.7	13.7	16.2	20.7
1.32	9.4	12.4	+	+	+	1327	16.47	19.14	879	12.53	14.03	—	—	—	—	—	13.7
1.33	3.6	4.8	2625	2.27	5.75	1312	2.29	3.86	870	1.87	2.87	11.8	13.3	15.3	17.3	19.8	24.3
ARC-LENGTH CORRECTION FACTOR												0.75	0.78	0.80	0.83	0.85	0.89

B = STANDARD V-BELT
 BX = COGGED/NOTCHED V-BELT
 + IF RIM SPEED EXCEEDS 6500 FEET PER MINUTE, CONSULT *Martin*.



Stock Drive Selection **B**

Nominal Center Distances And Arc-Length Correction Factor															Sheave Combination		Speed Ratio
B/BX Belt Length Designation															DriveR P.D.	DriveN P.D.	
68	75	81	85	90	97	105	112	120	128	158	180	210	240	300			
25.9	29.4	32.4	34.4	36.9	40.4	44.4	47.9	51.9	55.9	70.9	81.9	96.9	111.2	141.2	5.2	6.2	1.19
25.6	29.1	32.1	34.1	36.6	40.1	44.1	47.6	51.6	55.6	70.6	81.6	96.6	110.9	140.9	5.4	6.4	1.19
24.2	27.7	30.7	32.7	35.2	38.7	42.7	46.2	50.2	54.2	69.2	80.2	95.2	109.5	139.5	6.2	7.4	1.19
28.0	31.5	34.5	36.5	39.0	42.5	46.5	50.0	54.0	58.0	73.0	84.0	99.0	113.2	143.2	4.0	4.8	1.20
26.3	29.8	32.8	34.8	37.3	40.8	44.8	48.3	52.3	56.3	71.3	82.3	97.3	111.5	141.5	5.0	6.0	1.20
0.93	0.95	0.97	0.98	1.00	1.02	1.04	1.05	1.07	1.09	1.14	1.17	1.21	1.24	1.30			
28.3	31.8	34.8	36.8	39.3	42.8	46.8	50.3	54.3	58.3	73.3	84.3	99.3	113.6	143.6	3.8	4.6	1.21
26.6	30.1	33.1	35.1	37.6	41.1	45.1	48.6	52.6	56.6	71.6	82.6	97.6	111.8	141.8	4.8	5.8	1.21
25.2	28.7	31.7	33.7	36.2	39.7	43.7	47.2	51.2	55.2	70.2	81.2	96.2	110.4	140.4	5.6	6.8	1.21
24.8	28.3	31.3	33.3	35.8	39.3	43.3	46.8	50.8	54.8	69.8	80.8	95.8	110.1	140.1	5.8	7.0	1.21
23.4	26.9	29.9	31.9	34.4	37.9	41.9	45.4	49.4	53.4	68.4	79.4	94.4	108.7	138.7	6.6	8.0	1.21
0.93	0.95	0.97	0.98	1.00	1.02	1.04	1.05	1.07	1.09	1.14	1.17	1.21	1.24	1.30			
28.6	32.1	35.1	37.1	39.6	43.1	47.1	50.6	54.6	58.6	73.6	84.6	99.6	113.9	143.9	3.6	4.4	1.22
26.9	30.4	33.4	35.4	37.9	41.4	45.4	48.9	52.9	56.9	71.9	82.9	97.9	112.1	142.1	4.6	5.6	1.22
25.5	29.0	32.0	34.0	36.5	40.0	44.0	47.5	51.5	55.5	70.5	81.5	96.5	110.7	140.7	5.4	6.6	1.22
27.2	30.7	33.7	35.7	38.2	41.7	45.7	49.2	53.2	57.2	72.2	83.2	98.2	112.5	142.5	4.4	5.4	1.23
25.8	29.3	32.3	34.3	36.8	40.3	44.3	47.8	51.8	55.8	70.8	81.8	96.8	111.0	141.0	5.2	6.4	1.23
0.93	0.95	0.97	0.98	1.00	1.02	1.04	1.05	1.07	1.09	1.14	1.17	1.21	1.24	1.30			
24.4	27.9	30.9	32.9	35.4	38.9	42.9	46.4	50.4	54.4	69.4	80.4	95.4	109.6	139.6	6.0	7.4	1.23
22.6	26.1	29.1	31.1	33.6	37.1	41.1	44.6	48.6	52.6	67.6	78.6	93.6	107.9	137.9	7.0	8.6	1.23
28.9	32.4	35.4	37.4	39.9	43.4	47.4	50.9	54.9	58.9	73.9	84.9	99.9	114.2	144.2	3.4	4.2	1.24
27.5	31.0	34.0	36.0	38.5	42.0	46.0	49.5	53.5	57.5	72.5	83.5	98.5	112.8	142.8	4.2	5.2	1.24
26.1	29.6	32.6	34.6	37.1	40.6	44.6	48.1	52.1	56.1	71.1	82.1	97.1	111.4	141.4	5.0	6.2	1.24
0.93	0.95	0.97	0.98	1.00	1.02	1.04	1.05	1.07	1.09	1.14	1.17	1.21	1.24	1.30			
27.8	31.3	34.3	36.3	38.8	42.3	46.3	49.8	53.8	57.8	72.8	83.8	98.8	113.1	143.1	4.0	5.0	1.25
26.4	29.9	32.9	34.9	37.4	40.9	44.9	48.4	52.4	56.4	71.4	82.4	97.4	111.7	141.7	4.8	6.0	1.25
25.0	28.5	31.5	33.5	36.0	39.5	43.5	47.0	51.0	55.0	70.0	81.0	96.0	110.3	140.3	5.6	7.0	1.25
23.6	27.1	30.1	32.1	34.6	38.1	42.1	45.6	49.6	53.6	68.6	79.6	94.6	108.8	138.8	6.4	8.0	1.25
28.1	31.6	34.6	36.6	39.1	42.6	46.6	50.1	54.1	58.1	73.1	84.1	99.1	113.4	143.4	3.8	4.8	1.26
0.93	0.95	0.97	0.98	1.00	1.02	1.04	1.05	1.07	1.09	1.14	1.17	1.21	1.24	1.30			
26.7	30.2	33.2	35.2	37.7	41.2	45.2	48.7	52.7	56.7	71.7	82.7	97.7	112.0	142.0	4.6	5.8	1.26
25.3	28.8	31.8	33.8	36.3	39.8	43.8	47.3	51.3	55.3	70.3	81.3	96.3	110.6	140.6	5.4	6.8	1.26
22.8	26.3	29.3	31.3	33.8	37.3	41.3	44.8	48.8	52.8	67.8	78.8	93.8	108.1	138.1	6.8	8.6	1.26
27.0	30.5	33.5	35.5	38.0	41.5	45.5	49.0	53.0	57.0	72.0	83.0	98.0	112.3	142.3	4.4	5.6	1.27
25.6	29.1	32.1	34.1	36.6	40.1	44.1	47.6	51.6	55.6	70.6	81.6	96.6	110.9	140.9	5.2	6.6	1.27
0.93	0.95	0.97	0.98	1.00	1.01	1.03	1.05	1.07	1.09	1.14	1.17	1.21	1.24	1.30			
21.7	25.2	28.2	30.2	32.7	36.2	40.2	43.7	47.7	51.7	66.7	77.7	92.7	107.0	137.0	7.4	9.4	1.27
28.5	32.0	35.0	37.0	39.5	43.0	47.0	50.5	54.5	58.5	73.5	84.5	99.5	113.7	143.7	3.6	4.6	1.28
25.9	29.4	32.4	34.4	36.9	40.4	44.4	47.9	51.9	55.9	70.9	81.9	96.9	111.2	141.2	5.0	6.4	1.28
24.5	28.0	31.0	33.0	35.5	39.0	43.0	46.5	50.5	54.5	69.5	80.5	95.5	109.8	139.8	5.8	7.4	1.28
19.5	23.0	26.0	28.0	30.5	34.0	38.0	41.5	45.5	49.5	64.5	75.5	90.5	104.7	134.8	8.6	11.0	1.28
0.93	0.95	0.97	0.98	1.00	1.02	1.04	1.05	1.07	1.09	1.14	1.17	1.21	1.24	1.30			
28.8	32.3	35.3	37.3	39.8	43.3	47.3	50.8	54.8	58.8	73.8	84.8	99.8	114.0	144.0	3.4	4.4	1.29
27.4	30.9	33.9	35.9	38.4	41.9	45.9	49.4	53.4	57.4	72.4	83.4	98.4	112.6	142.6	4.2	5.4	1.29
26.3	29.8	32.8	34.8	37.3	40.8	44.8	48.3	52.3	56.3	71.3	82.3	97.3	111.5	141.5	4.8	6.2	1.29
23.7	27.2	30.2	32.2	34.7	38.2	42.2	45.7	49.7	53.7	68.7	79.7	94.7	109.0	139.0	6.2	8.0	1.29
27.7	31.2	34.2	36.2	38.7	42.2	46.2	49.7	53.7	57.7	72.7	83.7	98.7	112.9	142.9	4.0	5.2	1.30
0.93	0.95	0.97	0.98	1.00	1.02	1.04	1.05	1.07	1.09	1.14	1.17	1.21	1.24	1.30			
26.6	30.1	33.1	35.1	37.6	41.1	45.1	48.6	52.6	56.6	71.6	82.6	97.6	111.8	141.8	4.6	6.0	1.30
25.1	28.6	31.6	33.6	36.1	39.6	43.6	47.1	51.1	55.1	70.1	81.1	96.1	110.4	140.4	5.4	7.0	1.30
22.9	26.4	29.4	31.4	33.9	37.4	41.4	45.0	49.0	53.0	68.0	79.0	94.0	108.2	138.2	6.6	8.6	1.30
25.5	29.0	32.0	34.0	36.5	40.0	44.0	47.5	51.5	55.5	70.5	81.5	96.5	110.7	140.7	5.2	6.8	1.31
28.0	31.5	34.5	36.5	39.0	42.5	46.5	50.0	54.0	58.0	73.0	84.0	99.0	113.2	143.2	3.8	5.0	1.32
0.92	0.95	0.97	0.98	1.00	1.01	1.03	1.05	1.07	1.08	1.14	1.17	1.21	1.24	1.30			
26.9	30.4	33.4	35.4	37.9	41.4	45.4	48.9	52.9	56.9	71.9	82.9	97.9	112.1	142.1	4.4	5.8	1.32
25.8	29.3	32.3	34.3	36.8	40.3	44.3	47.8	51.8	55.8	70.8	81.8	96.8	111.0	141.0	5.0	6.6	1.32
24.7	28.2	31.2	33.2	35.7	39.2	43.2	46.7	50.7	54.7	69.7	80.7	95.7	109.9	139.9	5.6	7.4	1.32
17.7	21.2	24.2	26.2	28.7	32.2	36.2	39.8	43.8	47.8	62.8	73.8	88.8	103.0	133.0	9.4	12.4	1.32
28.3	31.8	34.8	36.8	39.3	42.8	46.8	50.3	54.3	58.3	73.3	84.3	99.3	113.6	143.6	3.6	4.8	1.33
0.92	0.95	0.97	0.98	1.00	1.01	1.03	1.05	1.07	1.08	1.14	1.17	1.21	1.24	1.30			

FOR BELT SIZES NOT SHOWN INTERPOLATE FOR ADDITIONAL CENTER DISTANCE.

V-BELT DRIVES

B Stock Drive Selection



V-BELT DRIVES

Speed Ratio	Sheave Combination		DriveN Speeds and HP Per Belt									Nominal Center Distance And Arc-Length Correction Factors					
			3500 RPM DriveR			1750 RPM DriveR			1160 RPM DriveR			B/BX Belt Length Designation					
	DriveR P.D.	DriveN P.D.	DriveN RPM	HP Per Belt B	HP Per Belt BX	DriveN RPM	HP Per Belt B	HP Per Belt BX	DriveN RPM	HP Per Belt B	HP Per Belt BX	35	38	42	46	51	60
1.33	4.2	5.6	2625	4.97	8.72	1312	3.99	5.63	870	3.08	4.11	10.7	12.2	14.2	16.2	18.7	23.2
1.33	4.8	6.4	2625	7.44	11.50	1312	5.63	7.36	870	4.26	5.33	9.6	11.1	13.1	15.1	17.6	22.1
1.33	6.0	8.0	2625	11.57	16.40	1313	8.77	10.69	870	6.54	7.71	—	—	10.9	12.9	15.4	19.9
1.34	6.4	8.6	2605	12.70	17.84	1302	9.78	11.77	863	7.29	8.49	—	—	10.1	12.1	14.6	19.1
1.34	7.0	9.4	2606	14.10	19.76	1303	11.24	13.34	864	8.38	9.64	—	—	—	11.0	13.5	18.0
ARC-LENGTH CORRECTION FACTOR											0.75	0.78	0.80	0.83	0.85	0.89	
1.35	3.4	4.6	2587	1.35	4.75	1293	1.73	3.28	857	1.48	2.46	12.1	13.6	15.6	17.6	20.1	24.6
1.35	4.0	5.4	2593	4.13	7.78	1296	3.44	5.06	859	2.69	3.71	11.0	12.5	14.5	16.5	19.0	23.5
1.35	4.6	6.2	2597	6.68	10.63	1298	5.11	6.80	861	3.88	4.94	9.9	11.4	13.4	15.4	17.9	22.4
1.35	5.2	7.0	2600	8.98	13.26	1300	6.72	8.50	862	5.04	6.14	8.8	10.3	12.3	14.3	16.8	21.3
1.36	4.4	6.0	2567	5.88	9.71	1283	4.57	6.24	851	3.49	4.54	10.2	11.7	13.7	15.7	18.2	22.7
ARC-LENGTH CORRECTION FACTOR											0.76	0.78	0.80	0.83	0.85	0.89	
1.36	5.0	6.8	2574	8.26	12.42	1287	6.20	7.95	853	4.66	5.75	9.1	10.6	12.6	14.6	17.1	21.6
1.37	3.8	5.2	2558	3.26	6.82	1279	2.89	4.49	848	2.30	3.31	11.3	12.8	14.8	16.8	19.3	23.8
1.37	4.8	6.6	2545	7.51	11.56	1273	5.67	7.39	844	4.28	5.35	9.4	10.9	12.9	14.9	17.4	21.9
1.37	5.4	7.4	2554	9.71	14.12	1277	7.26	9.08	846	5.43	6.55	8.3	9.8	11.8	13.8	16.3	20.8
1.38	4.2	5.8	2534	5.06	8.79	1267	4.03	5.67	840	3.11	4.14	10.5	12.0	14.0	16.0	18.5	23.0
ARC-LENGTH CORRECTION FACTOR											0.75	0.77	0.80	0.82	0.85	0.89	
1.38	5.8	8.0	2537	11.04	15.72	1269	8.30	10.18	841	6.19	7.34	—	9.0	11.0	13.0	15.5	20.0
1.38	6.8	9.4	2532	13.74	19.20	1266	10.79	12.85	839	8.04	9.28	—	—	—	11.1	13.6	18.1
1.38	8.0	11.0	+	+	+	1273	13.57	15.88	844	10.18	11.53	—	—	—	—	11.4	15.9
1.39	3.6	5.0	2520	2.37	5.83	1260	2.34	3.90	835	1.91	2.90	11.6	13.1	15.1	17.1	19.6	24.1
1.39	4.6	6.4	2516	6.74	10.68	1258	5.14	6.83	834	3.90	4.95	9.7	11.2	13.2	15.2	17.7	22.2
ARC-LENGTH CORRECTION FACTOR											0.76	0.78	0.80	0.83	0.85	0.89	
1.39	6.2	8.6	2523	12.24	17.21	1262	9.32	11.27	836	6.95	8.13	—	—	10.2	12.2	14.7	19.2
1.40	4.0	5.6	2500	4.21	7.85	1250	3.48	5.10	829	2.72	3.73	10.8	12.3	14.3	16.3	18.8	23.3
1.40	5.0	7.0	2500	8.32	12.47	1250	6.23	7.98	829	4.68	5.76	8.9	10.4	12.4	14.4	16.9	21.5
1.41	3.4	4.8	2479	1.44	4.83	1240	1.78	3.32	822	1.51	2.49	11.9	13.4	15.4	17.4	19.9	24.4
1.41	4.4	6.2	2484	5.95	9.78	1242	4.60	6.27	823	3.51	4.56	10.0	11.5	13.5	15.5	18.1	22.6
ARC-LENGTH CORRECTION FACTOR											0.75	0.77	0.80	0.82	0.85	0.89	
1.42	3.8	5.4	2463	3.34	6.88	1231	2.93	4.52	816	2.32	3.33	11.1	12.6	14.7	16.7	19.2	23.7
1.42	4.8	6.8	2471	7.58	11.62	1235	5.70	7.42	819	4.30	5.37	9.2	10.7	12.8	14.8	17.3	21.8
1.42	5.2	7.4	2459	9.08	13.35	1230	6.77	8.55	815	5.07	6.17	8.4	9.9	12.0	14.0	16.5	21.0
1.42	6.6	9.4	2457	13.32	18.61	1229	10.33	12.35	814	7.70	8.91	—	—	—	11.2	13.8	18.3
1.43	4.2	6.0	2450	5.13	8.85	1225	4.06	5.70	812	3.13	4.15	10.3	11.9	13.9	15.9	18.4	22.9
ARC-LENGTH CORRECTION FACTOR											0.75	0.78	0.80	0.82	0.85	0.89	
1.43	4.6	6.6	2439	6.80	10.73	1220	5.16	6.85	808	3.92	4.97	9.6	11.1	13.1	15.1	17.6	22.1
1.43	5.6	8.0	2450	10.47	15.00	1225	7.82	9.66	812	5.84	6.97	—	9.1	11.2	13.2	15.7	20.2
1.43	6.0	8.6	2442	11.72	16.53	1221	8.85	10.75	809	6.59	7.75	—	—	10.4	12.4	14.9	19.4
1.44	3.6	5.2	2423	2.43	5.89	1212	2.37	3.93	803	1.93	2.92	11.5	13.0	15.0	17.0	19.5	24.0
1.44	8.6	12.4	+	+	+	1214	14.92	17.36	805	11.24	12.65	—	—	—	—	—	14.3
ARC-LENGTH CORRECTION FACTOR											0.75	0.77	0.80	0.82	0.85	0.89	
1.45	4.0	5.8	2414	4.27	7.90	1207	3.51	5.12	800	2.74	3.75	10.7	12.2	14.2	16.2	18.7	23.2
1.45	4.4	6.4	2406	6.00	9.82	1203	4.63	6.29	797	3.53	4.57	9.9	11.4	13.4	15.4	17.9	22.4
1.45	9.4	13.6	+	+	+	1210	16.57	19.22	802	12.59	14.09	—	—	—	—	—	—
1.46	4.8	7.0	2400	7.63	11.66	1200	5.72	7.44	795	4.32	5.38	9.1	10.6	12.6	14.6	17.1	21.6
1.47	3.4	5.0	2380	1.51	4.89	1190	1.81	3.35	789	1.53	2.51	11.8	13.3	15.3	17.3	19.8	24.3
ARC-LENGTH CORRECTION FACTOR											0.75	0.77	0.80	0.82	0.85	0.89	
1.47	3.8	5.6	2375	3.39	6.93	1187	2.96	4.54	787	2.34	3.34	11.0	12.5	14.5	16.5	19.0	23.5
1.47	6.4	9.4	2383	12.88	17.99	1191	9.87	11.85	790	7.35	8.54	—	—	—	11.4	13.9	18.4
1.48	4.2	6.2	2371	5.18	8.90	1185	4.09	5.72	786	3.15	4.17	10.2	11.7	13.7	15.7	18.2	22.7
1.48	4.6	6.8	2368	6.85	10.77	1184	5.19	6.88	785	3.93	4.99	9.4	10.9	12.9	14.9	17.4	21.9
1.48	5.0	7.4	2365	8.41	12.55	1182	6.27	8.02	784	4.71	5.79	8.6	10.1	12.1	14.1	16.6	21.1
ARC-LENGTH CORRECTION FACTOR											0.75	0.77	0.80	0.82	0.85	0.89	
1.48	5.4	8.0	2362	9.85	14.24	1181	7.33	9.14	783	5.48	6.59	—	9.3	11.3	13.3	15.8	20.3
1.48	5.8	8.6	2360	11.17	15.82	1180	8.37	10.24	782	6.24	7.38	—	—	10.5	12.5	15.0	19.5
1.49	7.4	11.0	+	+	+	1177	12.28	14.45	780	9.17	10.45	—	—	—	—	11.8	16.3
1.50	3.6	5.4	2333	2.49	5.94	1167	2.40	3.96	773	1.95	2.94	11.3	12.8	14.8	16.8	19.3	23.8
1.50	4.0	6.0	2333	4.32	7.95	1167	3.54	5.14	773	2.75	3.76	10.5	12.0	14.0	16.0	18.5	23.0
ARC-LENGTH CORRECTION FACTOR											0.75	0.77	0.80	0.82	0.85	0.89	

B = STANDARD V-BELT
 BX = COGGED/NOTCHED V-BELT
 + IF RIM SPEED EXCEEDS 6500 FEET PER MINUTE, CONSULT *Martin*.





Stock Drive Selection **B**

Nominal Center Distances And Arc-Length Correction Factor															Sheave Combination		Speed Ratio
B/BX Belt Length Designation															DriveR P. D.	DriveN P. D.	
68	75	81	85	90	97	105	112	120	128	158	180	210	240	300			
27.2	30.7	33.7	35.7	38.2	41.7	45.7	49.2	53.2	57.2	72.2	83.2	98.2	112.5	142.5	4.2	5.6	1.33
26.1	29.6	32.6	34.6	37.1	40.6	44.6	48.1	52.1	56.1	71.1	82.1	97.1	111.4	141.4	4.8	6.4	1.33
23.9	27.4	30.4	32.4	34.9	38.4	42.4	45.9	49.9	53.9	68.9	79.9	94.9	109.1	139.2	6.0	8.0	1.33
23.1	26.6	29.6	31.6	34.1	37.6	41.6	45.1	49.1	53.1	68.1	79.1	94.1	108.4	138.4	6.4	8.6	1.34
22.0	25.5	28.5	30.5	33.0	36.5	40.5	44.0	48.0	52.0	67.0	78.0	93.0	107.3	137.3	7.0	9.4	1.34
0.92	0.95	0.97	0.98	1.00	1.01	1.03	1.05	1.07	1.08	1.14	1.17	1.21	1.24	1.30			
28.6	32.1	35.1	37.1	39.6	43.1	47.1	50.6	54.6	58.6	73.6	84.6	99.6	113.9	143.9	3.4	4.6	1.35
27.5	31.0	34.0	36.0	38.5	42.0	46.0	49.5	53.5	57.5	72.5	83.5	98.5	112.8	142.8	4.0	5.4	1.35
26.4	29.9	32.9	34.9	37.4	40.9	44.9	48.4	52.4	56.4	71.4	82.4	97.4	111.7	141.7	4.6	6.2	1.35
25.3	28.8	31.8	33.8	36.3	39.8	43.8	47.3	51.3	55.3	70.3	81.3	96.3	110.6	140.6	5.2	7.0	1.35
26.7	30.2	33.2	35.2	37.7	41.2	45.2	48.7	52.7	56.7	71.7	82.7	97.7	112.0	142.0	4.4	6.0	1.36
0.93	0.95	0.97	0.98	1.00	1.02	1.04	1.05	1.07	1.09	1.14	1.17	1.21	1.24	1.30			
25.6	29.1	32.1	34.1	36.6	40.1	44.1	47.6	51.6	55.6	70.6	81.6	96.6	110.9	140.9	5.0	6.8	1.36
27.8	31.3	34.3	36.3	38.8	42.3	46.3	49.8	53.8	57.8	72.8	83.8	98.8	113.1	143.1	3.8	5.2	1.37
25.9	29.4	32.4	34.4	36.9	40.4	44.4	47.9	51.9	55.9	70.9	81.9	96.9	111.2	141.2	4.8	6.6	1.37
24.8	28.3	31.3	33.3	35.8	39.3	43.3	46.8	50.8	54.8	69.8	80.8	95.8	110.1	140.1	5.4	7.4	1.37
27.0	30.5	33.5	35.5	38.0	41.5	45.5	49.0	53.0	57.0	72.0	83.0	98.0	112.3	142.3	4.2	5.8	1.38
0.92	0.95	0.97	0.98	0.99	1.01	1.03	1.05	1.07	1.08	1.14	1.17	1.21	1.24	1.30			
24.0	27.5	30.5	32.5	35.0	38.5	42.5	46.0	50.0	54.1	69.1	80.1	95.1	109.3	139.3	5.8	8.0	1.38
22.1	25.6	28.6	30.6	33.2	36.7	40.7	44.2	48.2	52.2	67.2	78.2	93.2	107.4	137.4	6.8	9.4	1.38
19.9	23.4	26.4	28.4	30.9	34.4	38.4	42.0	46.0	50.0	65.0	76.0	91.0	105.2	135.2	8.0	11.0	1.38
28.1	31.6	34.6	36.6	39.1	42.6	46.6	50.1	54.1	58.1	73.1	84.1	99.1	113.4	143.4	3.6	5.0	1.39
26.2	29.7	32.7	34.7	37.2	40.8	44.8	48.3	52.3	56.3	71.3	82.3	97.3	111.5	141.5	4.6	6.4	1.39
0.92	0.95	0.97	0.98	1.00	1.01	1.03	1.05	1.07	1.08	1.14	1.17	1.21	1.24	1.30			
23.2	26.7	29.8	31.8	34.3	37.8	41.8	45.3	49.3	53.3	68.3	79.3	94.3	108.5	138.5	6.2	8.6	1.39
27.3	30.8	33.9	35.9	38.4	41.9	45.9	49.4	53.4	57.4	72.4	83.4	98.4	112.6	142.6	4.0	5.6	1.40
25.5	29.0	32.0	34.0	36.5	40.0	44.0	47.5	51.5	55.5	70.5	81.5	96.5	110.7	140.7	5.0	7.0	1.40
28.5	32.0	35.0	37.0	39.5	43.0	47.0	50.5	54.5	58.5	73.5	84.5	99.5	113.7	143.7	3.4	4.8	1.41
26.6	30.1	33.1	35.1	37.6	41.1	45.1	48.6	52.6	56.6	71.6	82.6	97.6	111.8	141.8	4.4	6.2	1.41
0.92	0.95	0.97	0.98	0.99	1.01	1.03	1.05	1.07	1.08	1.14	1.17	1.21	1.24	1.30			
27.7	31.2	34.2	36.2	38.7	42.2	46.2	49.7	53.7	57.7	72.7	83.7	98.7	112.9	142.9	3.8	5.4	1.42
25.8	29.3	32.3	34.3	36.8	40.3	44.3	47.8	51.8	55.8	70.8	81.8	96.8	111.0	141.0	4.8	6.8	1.42
25.0	28.5	31.5	33.5	36.0	39.5	43.5	47.0	51.0	55.0	70.0	81.0	96.0	110.2	140.2	5.2	7.4	1.42
22.3	25.8	28.8	30.8	33.3	36.8	40.8	44.3	48.3	52.3	67.3	78.3	93.3	107.6	137.6	6.6	9.4	1.42
26.9	30.4	33.4	35.4	37.9	41.4	45.4	48.9	52.9	56.9	71.9	82.9	97.9	112.1	142.1	4.2	6.0	1.43
0.92	0.95	0.97	0.98	0.99	1.01	1.03	1.05	1.07	1.08	1.14	1.17	1.21	1.24	1.30			
26.1	29.6	32.6	34.6	37.1	40.6	44.6	48.1	52.1	56.1	71.1	82.1	97.1	111.3	141.3	4.6	6.6	1.43
24.2	27.7	30.7	32.7	35.2	38.7	42.7	46.2	50.2	54.2	69.2	80.2	95.2	109.5	139.5	5.6	8.0	1.43
23.4	26.9	29.9	31.9	34.4	37.9	41.9	45.4	49.4	53.4	68.4	79.4	94.4	108.7	138.7	6.0	8.6	1.43
28.0	31.5	34.5	36.5	39.0	42.5	46.5	50.0	54.0	58.0	73.0	84.0	99.0	113.2	143.2	3.6	5.2	1.44
18.3	21.8	24.8	26.8	29.3	32.9	36.9	40.4	44.4	48.4	63.4	74.4	89.4	103.6	133.6	8.6	12.4	1.44
0.92	0.95	0.97	0.98	0.99	1.01	1.03	1.05	1.07	1.08	1.14	1.17	1.21	1.24	1.30			
27.2	30.7	33.7	35.7	38.2	41.7	45.7	49.2	53.2	57.2	72.2	83.2	98.2	112.4	142.4	4.0	5.8	1.45
26.4	29.9	32.9	34.9	37.4	40.9	44.9	48.4	52.4	56.4	71.4	82.4	97.4	111.7	141.7	4.4	6.4	1.45
16.7	20.2	23.2	25.2	27.8	31.3	35.3	38.8	42.8	46.8	61.8	72.8	87.8	102.1	132.1	9.4	13.6	1.45
25.6	29.1	32.1	34.1	36.6	40.1	44.1	47.6	51.6	55.6	70.6	81.6	96.6	110.9	140.9	4.8	7.0	1.46
28.3	31.8	34.8	36.8	39.3	42.8	46.8	50.3	54.3	58.3	73.3	84.3	99.3	113.5	143.6	3.4	5.0	1.47
0.92	0.95	0.97	0.98	0.99	1.01	1.03	1.05	1.07	1.08	1.14	1.17	1.21	1.24	1.30			
27.5	31.0	34.0	36.0	38.5	42.0	46.0	49.5	53.5	57.5	72.5	83.5	98.5	112.8	142.8	3.8	5.6	1.47
22.4	25.9	29.0	31.0	33.5	37.0	41.0	44.5	48.5	52.5	67.5	78.5	93.5	107.7	137.7	6.4	9.4	1.47
26.7	30.2	33.2	35.2	37.7	41.2	45.2	48.7	52.7	56.7	71.7	82.7	97.7	112.0	142.0	4.2	6.2	1.48
25.9	29.4	32.4	34.4	36.9	40.4	44.4	47.9	51.9	55.9	70.9	81.9	96.9	111.2	141.2	4.6	6.8	1.48
25.1	28.6	31.6	33.6	36.1	39.6	43.6	47.1	51.1	55.1	70.2	81.2	96.2	110.4	140.4	5.0	7.4	1.48
0.92	0.95	0.97	0.98	0.99	1.01	1.03	1.05	1.07	1.08	1.14	1.17	1.21	1.24	1.30			
24.3	27.8	30.8	32.8	35.4	38.9	42.9	46.4	50.4	54.4	69.4	80.4	95.4	109.6	139.6	5.4	8.0	1.48
23.5	27.1	30.1	32.1	34.6	38.1	42.1	45.6	49.6	53.6	68.6	79.6	94.6	108.8	138.8	5.8	8.6	1.48
20.4	23.9	26.9	28.9	31.4	34.9	38.9	42.4	46.4	50.4	65.4	76.4	91.4	105.7	135.7	7.4	11.0	1.49
27.8	31.3	34.3	36.3	38.8	42.3	46.3	49.8	53.8	57.8	72.8	83.8	98.8	113.1	143.1	3.6	5.4	1.50
27.0	30.5	33.5	35.5	38.0	41.5	45.5	49.0	53.0	57.0	72.0	83.0	98.0	112.3	142.3	4.0	6.0	1.50
0.92	0.95	0.97	0.98	0.99	1.01	1.03	1.05	1.07	1.08	1.14	1.17	1.21	1.24	1.30			

FOR BELT SIZES NOT SHOWN, INTERPOLATE FOR ADDITIONAL CENTER DISTANCE.

V-BELT DRIVES

B Stock Drive Selection



V-BELT DRIVES

Speed Ratio	Sheave Combination		DriveN Speeds and HP Per Belt									Nominal Center Distance And Arc-Length Correction Factors					
			3500 RPM DriveR			1750 RPM DriveR			1160 RPM DriveR								
	DriveR P.D.	DriveN P.D.	DriveN RPM	HP Per Belt B	HP Per Belt BX	DriveN RPM	HP Per Belt B	HP Per Belt BX	DriveN RPM	HP Per Belt B	HP Per Belt BX	B/BX Belt Length Designation					
												35	38	42	46	51	60
1.50	4.4	6.6	2333	6.05	9.86	1167	4.65	6.31	773	3.55	4.58	9.7	11.2	13.2	15.2	17.7	22.2
1.52	4.2	6.4	2297	5.22	8.93	1148	4.11	5.74	761	3.16	4.18	10.0	11.5	13.5	15.5	18.0	22.5
1.52	4.6	7.0	2300	6.89	10.80	1150	5.21	6.89	762	3.95	5.00	9.2	10.7	12.7	14.7	17.2	21.8
1.52	6.2	9.4	2309	12.38	17.33	1154	9.40	11.33	765	6.99	8.17	—	—	—	11.5	14.1	18.6
1.53	3.4	5.2	2288	1.57	4.93	1144	1.84	3.37	758	1.55	2.52	11.6	13.1	15.1	17.1	19.6	24.1
ARC-LENGTH CORRECTION FACTOR												0.74	0.77	0.79	0.82	0.85	0.89
1.53	3.8	5.8	2293	3.45	6.98	1147	2.99	4.56	760	2.36	3.36	10.8	12.3	14.3	16.3	18.8	23.3
1.54	4.8	7.4	2270	7.70	11.72	1135	5.76	7.47	752	4.34	5.40	8.7	10.2	12.2	14.3	16.8	21.3
1.54	5.2	8.0	2275	9.20	13.45	1137	6.83	8.60	754	5.11	6.21	—	9.4	11.4	13.5	16.0	20.5
1.54	5.6	8.6	2279	10.58	15.09	1140	7.88	9.71	755	5.88	7.00	—	—	10.6	12.7	15.2	19.7
1.55	4.0	6.2	2258	4.37	7.98	1129	3.56	5.16	748	2.77	3.78	10.3	11.8	13.8	15.9	18.4	22.9
ARC-LENGTH CORRECTION FACTOR												0.75	0.77	0.80	0.82	0.85	0.89
1.55	4.4	6.8	2265	6.09	9.90	1132	4.67	6.33	751	3.56	4.60	9.5	11.0	13.0	15.1	17.6	22.1
1.55	8.0	12.4	+	+	+	1129	13.66	15.96	748	10.24	11.58	—	—	—	—	—	14.7
1.56	3.6	5.6	2250	2.54	5.99	1125	2.43	3.98	746	1.97	2.95	11.1	12.6	14.6	16.6	19.1	23.7
1.57	4.2	6.6	2227	5.26	8.96	1114	4.13	5.75	738	3.17	4.19	9.8	11.4	13.4	15.4	17.9	22.4
1.57	6.0	9.4	2234	11.85	16.64	1117	8.91	10.81	740	6.63	7.79	—	—	9.7	11.7	14.2	18.7
ARC-LENGTH CORRECTION FACTOR												0.74	0.76	0.79	0.82	0.84	0.89
1.57	7.0	11.0	2227	14.36	19.98	1114	11.37	13.45	738	8.47	9.71	—	—	—	—	12.1	16.6
1.58	3.8	6.0	2217	3.48	7.01	1108	3.00	4.58	735	2.37	3.37	10.6	12.2	14.2	16.2	18.7	23.2
1.58	8.6	13.6	+	+	+	1107	14.98	17.42	734	11.28	12.69	—	—	—	—	—	13.2
1.59	3.4	5.4	2204	1.61	4.97	1102	1.86	3.39	730	1.57	2.54	11.4	12.9	15.0	17.0	19.5	24.0
1.59	4.4	7.0	2200	6.12	9.92	1100	4.69	6.34	729	3.57	4.60	9.4	10.9	12.9	14.9	17.4	21.9
ARC-LENGTH CORRECTION FACTOR												0.75	0.77	0.80	0.82	0.85	0.89
1.59	5.4	8.6	2198	9.94	14.32	1099	7.37	9.17	728	5.51	6.61	—	—	10.8	12.8	15.3	19.8
1.60	4.0	6.4	2188	4.40	8.01	1094	3.58	5.18	725	2.78	3.79	10.2	11.7	13.7	15.7	18.2	22.7
1.60	5.0	8.0	2188	8.51	12.64	1094	6.32	8.06	725	4.74	5.82	—	9.6	11.6	13.6	16.1	20.6
1.61	3.6	5.8	2172	2.58	6.01	1086	2.44	3.99	720	1.98	2.96	11.0	12.5	14.5	16.5	19.0	23.5
1.61	4.6	7.4	2176	6.95	10.86	1088	5.24	6.92	721	3.97	5.01	8.9	10.4	12.4	14.4	16.9	21.4
ARC-LENGTH CORRECTION FACTOR												0.74	0.77	0.79	0.82	0.84	0.89
1.62	4.2	6.8	2162	5.29	8.99	1081	4.14	5.77	716	3.18	4.20	9.7	11.2	13.2	15.2	17.7	22.2
1.62	5.8	9.4	2160	11.27	15.92	1080	8.42	10.28	716	6.27	7.41	—	—	9.8	11.8	14.3	18.9
1.62	6.8	11.0	2164	13.97	19.40	1082	10.91	12.95	717	8.12	9.34	—	—	—	—	12.2	16.8
1.63	3.8	6.2	2145	3.52	7.04	1073	3.02	4.59	711	2.38	3.38	10.5	12.0	14.0	16.0	18.5	23.0
1.64	9.4	15.4	+	+	+	1068	16.64	19.28	708	12.64	14.13	—	—	—	—	—	—
ARC-LENGTH CORRECTION FACTOR												0.74	0.76	0.79	0.82	0.84	0.89
1.65	3.4	5.6	2125	1.65	5.00	1062	1.88	3.40	704	1.58	2.55	11.3	12.8	14.8	16.8	19.3	23.8
1.65	4.0	6.6	2121	4.43	8.04	1061	3.59	5.19	703	2.79	3.79	10.0	11.5	13.5	15.5	18.0	22.5
1.65	5.2	8.6	2116	9.27	13.52	1058	6.87	8.63	701	5.14	6.23	—	8.9	10.9	12.9	15.5	20.0
1.67	3.6	6.0	2100	2.61	6.04	1050	2.46	4.01	696	1.99	2.97	10.8	12.3	14.3	16.3	18.8	23.3
1.67	4.2	7.0	2100	5.31	9.01	1050	4.16	5.78	696	3.19	4.21	9.5	11.0	13.0	15.0	17.5	22.1
ARC-LENGTH CORRECTION FACTOR												0.75	0.77	0.80	0.82	0.85	0.89
1.67	4.8	8.0	2100	7.78	11.79	1050	5.80	7.51	696	4.37	5.43	—	9.7	11.7	13.8	16.3	20.8
1.67	6.6	11.0	2100	13.52	18.78	1050	10.43	12.44	696	7.76	8.97	—	—	—	—	12.4	16.9
1.68	3.8	6.4	2078	3.54	7.06	1039	3.03	4.61	689	2.39	3.39	10.3	11.8	13.8	15.8	18.3	22.9
1.68	4.4	7.4	2081	6.17	9.97	1041	4.71	6.36	690	3.59	4.62	9.0	10.5	12.5	14.6	17.1	21.6
1.68	5.6	9.4	2085	10.66	15.16	1043	7.92	9.75	691	5.90	7.02	—	—	9.9	12.0	14.5	19.0
ARC-LENGTH CORRECTION FACTOR												0.74	0.76	0.79	0.82	0.84	0.89
1.68	7.4	12.4	+	+	+	1044	12.34	14.50	692	9.21	10.49	—	—	—	—	—	15.1
1.70	4.0	6.8	2059	4.45	8.06	1029	3.60	5.20	682	2.80	3.80	9.8	11.3	13.3	15.4	17.9	22.4
1.70	8.0	13.6	+	+	+	1029	13.71	16.00	682	10.27	11.61	—	—	—	—	—	13.6
1.70	9.4	16.0	+	+	+	1028	16.66	19.30	681	12.65	14.14	—	—	—	—	—	—
1.71	3.4	5.8	2052	1.67	5.03	1026	1.89	3.42	680	1.59	2.55	11.1	12.6	14.6	16.6	19.1	23.6
ARC-LENGTH CORRECTION FACTOR												0.74	0.76	0.79	0.81	0.84	0.88
1.72	3.6	6.2	2032	2.63	6.06	1016	2.47	4.02	674	1.99	2.97	10.6	12.1	14.1	16.2	18.7	23.2
1.72	5.0	8.6	2035	8.57	12.69	1017	6.35	8.08	674	4.76	5.84	—	9.0	11.1	13.1	15.6	20.1
1.72	6.4	11.0	2036	13.04	18.13	1018	9.95	11.92	675	7.40	8.59	—	—	—	—	12.5	17.1
1.74	3.8	6.6	2015	3.57	7.08	1008	3.05	4.62	668	2.40	3.39	10.1	11.6	13.7	15.7	18.2	22.7
1.74	4.6	8.0	2012	7.02	10.91	1006	5.27	6.95	667	3.99	5.03	8.3	9.9	11.9	13.9	16.4	20.9
ARC-LENGTH CORRECTION FACTOR												0.74	0.77	0.79	0.82	0.84	0.89

B = STANDARD V-BELT
 BX = COGGED/NOTCHED V-BELT
 + IF RIM SPEED EXCEEDS 6500 FEET PER MINUTE, CONSULT *Martin*.





Stock Drive Selection **B**

Nominal Center Distances And Arc-Length Correction Factor															Sheave Combination		Speed Ratio
B/BX Belt Length Designation															DriveR P.D.	DriveN P.D.	
68	75	81	85	90	97	105	112	120	128	158	180	210	240	300			
26.2	29.7	32.7	34.7	37.2	40.7	44.7	48.2	52.2	56.2	71.3	82.3	97.3	111.5	141.5	4.4	6.6	1.50
26.6	30.1	33.1	35.1	37.6	41.1	45.1	48.6	52.6	56.6	71.6	82.6	97.6	111.8	141.8	4.2	6.4	1.52
25.8	29.3	32.3	34.3	36.8	40.3	44.3	47.8	51.8	55.8	70.8	81.8	96.8	111.0	141.0	4.6	7.0	1.52
22.6	26.1	29.1	31.1	33.6	37.1	41.1	44.6	48.6	52.6	67.6	78.6	93.6	107.9	137.9	6.2	9.4	1.52
28.1	31.6	34.6	36.6	39.1	42.6	46.6	50.1	54.1	58.1	73.1	84.1	99.1	113.4	143.4	3.4	5.2	1.53
0.92	0.95	0.97	0.98	0.99	1.01	1.03	1.05	1.07	1.08	1.14	1.17	1.21	1.24	1.30			
27.3	30.8	33.8	35.8	38.3	41.8	45.8	49.4	53.4	57.4	72.4	83.4	98.4	112.6	142.6	3.8	5.8	1.53
25.3	28.8	31.8	33.8	36.3	39.8	43.8	47.3	51.3	55.3	70.3	81.3	96.3	110.6	140.6	4.8	7.4	1.54
24.5	28.0	31.0	33.0	35.5	39.0	43.0	46.5	50.5	54.5	69.5	80.5	95.5	109.8	139.8	5.2	8.0	1.54
23.7	27.2	30.2	32.2	34.7	38.2	42.2	45.7	49.7	53.7	68.7	79.7	94.7	109.0	139.0	5.6	8.6	1.54
26.9	30.4	33.4	35.4	37.9	41.4	45.4	48.9	52.9	56.9	71.9	82.9	97.9	112.1	142.1	4.0	6.2	1.55
0.92	0.95	0.97	0.98	0.99	1.01	1.03	1.05	1.07	1.08	1.14	1.17	1.21	1.24	1.30			
26.1	29.6	32.6	34.6	37.1	40.6	44.6	48.1	52.1	56.1	71.1	82.1	97.1	111.3	141.3	4.4	6.8	1.55
18.7	22.3	25.3	27.3	29.8	33.3	37.3	40.8	44.8	48.8	63.8	74.8	89.8	104.1	134.1	8.0	12.4	1.55
27.7	31.2	34.2	36.2	38.7	42.2	46.2	49.7	53.7	57.7	72.7	83.7	98.7	112.9	142.9	3.6	5.6	1.56
26.4	29.9	32.9	34.9	37.4	40.9	44.9	48.4	52.4	56.4	71.4	82.4	97.4	111.7	141.7	4.2	6.6	1.57
22.7	26.2	29.3	31.3	33.8	37.3	41.3	44.8	48.8	52.8	67.8	78.8	93.8	108.0	138.0	6.0	9.4	1.57
0.92	0.94	0.96	0.98	0.99	1.01	1.03	1.05	1.07	1.08	1.14	1.17	1.21	1.24	1.30			
20.7	24.2	27.2	29.2	31.7	35.2	39.2	42.7	46.7	50.7	65.7	76.7	91.7	106.0	136.0	7.0	11.0	1.57
27.2	30.7	33.7	35.7	38.2	41.7	45.7	49.2	53.2	57.2	72.2	83.2	98.2	112.4	142.4	3.8	6.0	1.58
17.3	20.8	23.8	25.8	28.4	31.9	35.9	39.4	43.4	47.4	62.4	73.4	88.4	102.7	132.7	8.6	13.6	1.58
28.0	31.5	34.5	36.5	39.0	42.5	46.5	50.0	54.0	58.0	73.0	84.0	99.0	113.2	143.2	3.4	5.4	1.59
25.9	29.4	32.4	34.4	36.9	40.4	44.4	47.9	51.9	55.9	70.9	81.9	96.9	111.2	141.2	4.4	7.0	1.59
0.92	0.95	0.97	0.98	0.99	1.01	1.03	1.05	1.07	1.08	1.14	1.17	1.21	1.24	1.30			
23.9	27.4	30.4	32.4	34.9	38.4	42.4	45.9	49.9	53.9	68.9	79.9	94.9	109.1	139.1	5.4	8.6	1.59
26.7	30.2	33.2	35.2	37.7	41.2	45.2	48.7	52.7	56.7	71.7	82.7	97.7	112.0	142.0	4.0	6.4	1.60
24.6	28.1	31.2	33.2	35.7	39.2	43.2	46.7	50.7	54.7	69.7	80.7	95.7	109.9	139.9	5.0	8.0	1.60
27.5	31.0	34.0	36.0	38.5	42.0	46.0	49.5	53.5	57.5	72.5	83.5	98.5	112.8	142.8	3.6	5.8	1.61
25.4	28.9	31.9	33.9	36.4	40.0	44.0	47.5	51.5	55.5	70.5	81.5	96.5	110.7	140.7	4.6	7.4	1.61
0.92	0.94	0.96	0.98	0.99	1.01	1.03	1.05	1.07	1.08	1.14	1.17	1.21	1.24	1.30			
26.2	29.7	32.7	34.7	37.2	40.7	44.7	48.2	52.2	56.2	71.2	82.2	97.2	111.5	141.5	4.2	6.8	1.62
22.9	26.4	29.4	31.4	33.9	37.4	41.4	44.9	48.9	52.9	67.9	78.9	93.9	108.2	138.2	5.8	9.4	1.62
20.8	24.3	27.3	29.3	31.9	35.4	39.4	42.9	46.9	50.9	65.9	76.9	91.9	106.1	136.2	6.8	11.0	1.62
27.0	30.5	33.5	35.5	38.0	41.5	45.5	49.0	53.0	57.0	72.0	83.0	98.0	112.3	142.3	3.8	6.2	1.63
15.1	18.7	21.7	23.7	26.3	29.8	33.8	37.3	41.3	45.3	60.3	71.3	86.3	100.6	130.6	9.4	15.4	1.64
0.92	0.94	0.96	0.98	0.99	1.01	1.03	1.05	1.06	1.08	1.14	1.17	1.21	1.24	1.30			
27.8	31.3	34.3	36.3	38.8	42.3	46.3	49.8	53.8	57.8	72.8	83.8	98.8	113.1	143.1	3.4	5.6	1.65
26.5	30.0	33.0	35.1	37.6	41.1	45.1	48.6	52.6	56.6	71.6	82.6	97.6	111.8	141.8	4.0	6.6	1.65
24.0	27.5	30.5	32.5	35.0	38.5	42.5	46.0	50.0	54.0	69.0	80.0	95.0	109.3	139.3	5.2	8.6	1.65
27.3	30.8	33.8	35.8	38.3	41.8	45.8	49.3	53.3	57.3	72.3	83.3	98.3	112.6	142.6	3.6	6.0	1.67
26.1	29.6	32.6	34.6	37.1	40.6	44.6	48.1	52.1	56.1	71.1	82.1	97.1	111.3	141.3	4.2	7.0	1.67
0.92	0.95	0.97	0.98	0.99	1.01	1.03	1.05	1.07	1.08	1.14	1.17	1.21	1.24	1.30			
24.8	28.3	31.3	33.3	35.8	39.3	43.3	46.8	50.8	54.8	69.8	80.8	95.8	110.1	140.1	4.8	8.0	1.67
21.0	24.5	27.5	29.5	32.0	35.5	39.5	43.0	47.0	51.0	66.0	77.0	92.1	106.3	136.3	6.6	11.0	1.67
26.9	30.4	33.4	35.4	37.9	41.4	45.4	48.9	52.9	56.9	71.9	82.9	97.9	112.1	142.1	3.8	6.4	1.68
25.6	29.1	32.1	34.1	36.6	40.1	44.1	47.6	51.6	55.6	70.6	81.6	96.6	110.9	140.9	4.4	7.4	1.68
23.0	26.6	29.6	31.6	34.1	37.6	41.6	45.1	49.1	53.1	68.1	79.1	94.1	108.4	138.4	5.6	9.4	1.68
0.92	0.94	0.96	0.98	0.99	1.01	1.03	1.05	1.07	1.08	1.14	1.17	1.21	1.24	1.30			
19.2	22.7	25.7	27.7	30.2	33.8	37.8	41.3	45.3	49.3	64.3	75.3	90.3	104.6	134.6	7.4	12.4	1.68
26.4	29.9	32.9	34.9	37.4	40.9	44.9	48.4	52.4	56.4	71.4	82.4	97.4	111.7	141.7	4.0	6.8	1.70
17.7	21.3	24.3	26.3	28.8	32.3	36.3	39.8	43.8	47.8	62.8	73.8	88.8	103.1	133.2	8.0	13.6	1.70
—	18.2	21.2	23.2	25.7	29.3	33.3	36.8	40.8	44.8	59.8	70.8	85.8	100.1	130.2	9.4	16.0	1.70
27.6	31.2	34.2	36.2	38.7	42.2	46.2	49.7	53.7	57.7	72.7	83.7	98.7	112.9	142.9	3.4	5.8	1.71
0.92	0.94	0.96	0.98	0.99	1.01	1.03	1.05	1.06	1.08	1.13	1.17	1.21	1.24	1.30			
27.2	30.7	33.7	35.7	38.2	41.7	45.7	49.2	53.2	57.2	72.2	83.2	98.2	112.4	142.4	3.6	6.2	1.72
24.2	27.7	30.7	32.7	35.2	38.7	42.7	46.2	50.2	54.2	69.2	80.2	95.2	109.5	139.5	5.0	8.6	1.72
21.1	24.6	27.6	29.6	32.2	35.7	39.7	43.2	47.2	51.2	66.2	77.2	92.2	106.5	136.5	6.4	11.0	1.72
26.7	30.2	33.2	35.2	37.7	41.2	45.2	48.7	52.7	56.7	71.7	82.7	97.7	112.0	142.0	3.8	6.6	1.74
24.9	28.5	31.5	33.5	36.0	39.5	43.5	47.0	51.0	55.0	70.0	81.0	96.0	110.2	140.2	4.6	8.0	1.74
0.92	0.94	0.96	0.98	0.99	1.01	1.03	1.05	1.07	1.08	1.14	1.17	1.21	1.24	1.30			

FOR BELT SIZES NOT SHOWN, INTERPOLATE FOR ADDITIONAL CENTER DISTANCE.

V-BELT DRIVES

B Stock Drive Selection



V-BELT DRIVES

Speed Ratio	Sheave Combination		DriveN Speeds and HP Per Belt									Nominal Center Distance And Arc-Length Correction Factors					
			3500 RPM DriveR			1750 RPM DriveR			1160 RPM DriveR			B/BX Belt Length Designation					
	DriveR P.D.	DriveN P.D.	DriveN RPM	HP Per Belt B	HP Per Belt BX	DriveN RPM	HP Per Belt B	HP Per Belt BX	DriveN RPM	HP Per Belt B	HP Per Belt BX	35	38	42	46	51	60
1.74	5.4	9.4	2011	10.01	14.38	1005	7.41	9.21	666	5.53	6.64	—	—	10.1	12.1	14.6	19.2
1.75	4.0	7.0	2000	4.47	8.07	1000	3.61	5.21	663	2.80	3.81	9.6	11.2	13.2	15.2	17.7	22.2
1.76	3.4	6.0	1983	1.69	5.04	992	1.90	3.42	657	1.59	2.56	10.9	12.4	14.5	16.5	19.0	23.5
1.76	4.2	7.4	1986	5.35	9.05	993	4.17	5.80	658	3.20	4.22	9.1	10.7	12.7	14.7	17.2	21.7
1.77	6.2	11.0	1973	12.52	17.45	986	9.47	11.39	654	7.04	8.21	—	—	—	—	12.7	17.2
ARC-LENGTH CORRECTION FACTOR											0.74	0.76	0.79	0.81	0.84	0.88	
1.77	7.0	12.4	1976	14.46	20.07	988	11.42	13.50	655	8.50	9.74	—	—	—	—	—	15.4
1.78	3.6	6.4	1969	2.65	6.08	984	2.48	4.03	652	2.00	2.98	10.5	12.0	14.0	16.0	18.5	23.0
1.79	3.8	6.8	1956	3.58	7.09	978	3.05	4.62	648	2.41	3.40	10.0	11.5	13.5	15.5	18.0	22.5
1.79	4.8	8.6	1953	7.83	11.83	977	5.83	7.53	647	4.38	5.44	—	9.2	11.2	13.2	15.8	20.3
1.79	8.6	15.4	+	+	+	977	15.03	17.46	648	11.32	12.71	—	—	—	—	—	—
ARC-LENGTH CORRECTION FACTOR											0.74	0.76	0.79	0.82	0.84	0.89	
1.81	5.2	9.4	1936	9.33	13.57	968	6.90	8.66	642	5.16	6.24	—	—	10.2	12.3	14.8	19.3
1.82	3.4	6.2	1919	1.71	5.06	960	1.91	3.43	636	1.60	2.57	10.8	12.3	14.3	16.3	18.8	23.3
1.82	4.4	8.0	1925	6.22	10.41	962	4.74	6.38	638	3.60	4.63	8.5	10.0	12.0	14.0	16.6	21.1
1.82	6.8	12.4	1919	14.05	19.97	960	10.95	12.98	636	8.15	9.37	—	—	—	—	—	15.6
1.83	3.6	6.6	1909	2.67	6.09	955	2.49	4.03	633	2.01	2.99	10.3	11.8	13.8	15.8	18.3	22.8
ARC-LENGTH CORRECTION FACTOR											0.74	0.76	0.79	0.82	0.84	0.89	
1.83	6.0	11.0	1909	11.97	16.74	955	8.97	10.86	633	6.67	7.82	—	—	—	—	12.8	17.4
1.84	3.8	7.0	1900	3.60	7.11	950	3.06	4.63	630	2.41	3.40	9.8	11.3	13.3	15.3	17.8	22.4
1.84	7.4	13.6	+	+	+	952	12.37	14.53	631	9.23	10.50	—	—	—	—	—	14.1
1.85	4.0	7.4	1892	4.51	8.10	946	3.63	5.22	627	2.81	3.82	9.3	10.8	12.8	14.8	17.4	21.9
1.86	8.6	16.0	+	+	+	941	15.04	17.47	623	11.32	12.72	—	—	—	—	—	—
ARC-LENGTH CORRECTION FACTOR											0.73	0.76	0.79	0.81	0.84	0.88	
1.87	4.6	8.6	1872	7.06	10.95	936	5.29	6.97	620	4.00	5.04	—	9.3	11.4	13.4	15.9	20.4
1.88	3.4	6.4	1859	1.73	5.07	930	1.92	3.44	616	1.61	2.57	10.6	12.1	14.1	16.1	18.6	23.2
1.88	5.0	9.4	1862	8.62	12.73	931	6.38	8.11	617	4.78	5.85	—	—	10.4	12.4	14.9	19.5
1.88	6.6	12.4	1863	13.60	18.85	931	10.47	12.47	617	7.79	8.99	—	—	—	—	—	15.7
1.89	3.6	6.8	1853	2.69	6.11	926	2.50	4.04	614	2.01	2.99	10.1	11.6	13.6	15.7	18.2	22.7
ARC-LENGTH CORRECTION FACTOR											0.74	0.76	0.79	0.81	0.84	0.88	
1.90	4.2	8.0	1837	5.39	9.08	919	4.20	5.81	609	3.22	4.23	8.6	10.1	12.2	14.2	16.7	21.2
1.90	5.8	11.0	1845	11.38	16.01	923	8.47	10.33	612	6.31	7.44	—	—	—	10.4	12.9	17.5
1.92	8.0	15.4	+	+	+	909	13.74	16.03	603	10.29	11.63	—	—	—	—	—	—
1.94	3.4	6.6	1803	1.75	5.09	902	1.93	3.45	598	1.61	2.57	10.4	11.9	14.0	16.0	18.5	23.0
1.94	3.6	7.0	1800	2.70	6.12	900	2.50	4.05	597	2.02	2.99	9.9	11.4	13.5	15.5	18.0	22.5
ARC-LENGTH CORRECTION FACTOR											0.72	0.75	0.78	0.80	0.83	0.88	
1.94	6.4	12.4	1806	13.11	18.19	903	9.99	11.95	599	7.43	8.61	—	—	—	—	—	15.9
1.94	7.0	13.6	1801	14.51	20.11	901	11.44	13.52	597	8.52	9.76	—	—	—	—	—	14.3
1.95	3.8	7.4	1797	3.63	7.13	899	3.08	4.64	596	2.42	3.41	9.4	11.0	13.0	15.0	17.5	22.0
1.95	4.4	8.6	1791	6.26	10.04	895	4.76	6.40	593	3.62	4.64	—	9.5	11.5	13.5	16.1	20.6
1.96	4.8	9.4	1787	7.87	11.87	894	5.85	7.55	592	4.40	5.45	—	—	10.5	12.5	15.1	19.6
ARC-LENGTH CORRECTION FACTOR											0.73	0.75	0.78	0.81	0.84	0.88	
1.96	5.6	11.0	1782	10.75	15.24	891	7.96	9.78	591	5.93	7.05	—	—	—	10.5	13.1	17.7
1.96	9.4	18.4	+	+	+	894	16.70	19.33	593	12.68	14.16	—	—	—	—	—	—
2.00	3.4	6.8	1750	1.76	5.10	875	1.93	3.45	580	1.61	2.58	10.2	11.8	13.8	15.8	18.3	22.8
2.00	4.0	8.0	1750	4.54	8.13	875	3.65	5.24	580	2.83	3.83	8.7	10.3	12.3	14.3	16.9	21.4
2.00	6.2	12.4	1750	12.58	17.50	875	9.50	11.42	580	7.06	8.22	—	—	—	—	11.4	16.0
ARC-LENGTH CORRECTION FACTOR											0.73	0.76	0.79	0.81	0.84	0.88	
2.00	6.8	13.6	1750	14.09	19.51	875	10.97	13.00	580	8.16	9.38	—	—	—	—	—	14.5
2.00	8.0	16.0	+	+	+	875	13.75	16.04	580	10.30	11.63	—	—	—	—	—	—
2.04	4.6	9.4	1713	7.09	10.98	856	5.31	6.98	568	4.01	5.05	—	—	10.6	12.7	15.2	19.8
2.04	5.4	11.0	1718	10.09	14.45	859	7.45	9.24	569	5.56	6.66	—	—	—	10.7	13.2	17.8
2.05	4.2	8.6	1709	5.42	9.11	855	4.21	5.83	567	3.23	4.24	—	9.6	11.6	13.7	16.2	20.7
ARC-LENGTH CORRECTION FACTOR											0.0	0.74	0.77	0.80	0.83	0.87	
2.06	3.4	7.0	1700	5.10	5.10	850	1.94	3.46	563	1.62	2.58	10.1	11.6	13.6	15.6	18.1	22.7
2.06	3.6	7.4	1703	2.72	6.14	851	2.51	4.06	564	2.02	3.00	9.6	11.1	13.1	15.1	17.7	22.2
2.06	6.6	13.6	1699	13.64	18.88	849	10.49	12.48	563	7.80	9.00	—	—	—	—	—	14.6
2.07	6.0	12.4	1694	12.02	16.79	847	9.00	10.88	561	6.69	7.84	—	—	—	—	11.5	16.1
2.08	7.4	15.4	+	+	+	841	12.40	14.55	557	9.25	10.52	—	—	—	—	—	—
ARC-LENGTH CORRECTION FACTOR											0.73	0.75	0.78	0.81	0.84	0.88	

B = STANDARD V-BELT
 BX = COGGED/NOTCHED V-BELT
 + IF RIM SPEED EXCEEDS 6500 FEET PER MINUTE, CONSULT *Martin*.



Stock Drive Selection **B**

Nominal Center Distances And Arc-Length Correction Factor															Sheave Combination		Speed Ratio
B/BX Belt Length Designation															DriveR P.D.	DriveN P.D.	
68	75	81	85	90	97	105	112	120	128	158	180	210	240	300			
23.2	26.7	29.7	31.7	34.2	37.7	41.7	45.2	49.2	53.2	68.2	79.3	94.3	108.5	138.5	5.4	9.4	1.74
26.2	29.7	32.7	34.7	37.2	40.7	44.7	48.2	52.2	56.2	71.2	82.2	97.2	111.5	141.5	4.0	7.0	1.75
27.5	31.0	34.0	36.0	38.5	42.0	46.0	49.5	53.5	57.5	72.5	83.5	98.5	112.8	142.8	3.4	6.0	1.76
25.7	29.2	32.2	34.3	36.8	40.3	44.3	47.8	51.8	55.8	70.8	81.8	96.8	111.0	141.0	4.2	7.4	1.76
21.3	24.8	27.8	29.8	32.3	35.8	39.8	43.3	47.3	51.3	66.3	77.4	92.4	106.6	136.6	6.2	11.0	1.77
0.92	0.94	0.96	0.97	0.99	1.01	1.03	1.05	1.06	1.08	1.13	1.17	1.21	1.24	1.30			
19.5	23.0	26.0	28.0	30.5	34.1	38.1	41.6	45.6	49.6	64.6	75.6	90.6	104.9	134.9	7.0	12.4	1.77
27.0	30.5	33.5	35.5	38.0	41.5	45.5	49.0	53.0	57.0	72.0	83.0	98.0	112.3	142.3	3.6	6.4	1.78
26.5	30.0	33.0	35.0	37.5	41.0	45.0	48.6	52.6	56.6	71.6	82.6	97.6	111.8	141.8	3.8	6.8	1.79
24.3	27.8	30.8	32.8	35.3	38.8	42.8	46.3	50.3	54.3	69.3	80.4	95.4	109.6	139.6	4.8	8.6	1.79
15.7	19.3	22.3	24.3	26.8	30.4	34.4	37.9	41.9	45.9	61.0	72.0	87.0	101.2	131.3	8.6	15.4	1.79
0.92	0.94	0.96	0.98	0.99	1.01	1.03	1.05	1.06	1.08	1.13	1.17	1.21	1.24	1.30			
23.3	26.9	29.9	31.9	34.4	37.9	41.9	45.4	49.4	53.4	68.4	79.4	94.4	108.7	138.7	5.2	9.4	1.81
27.3	30.8	33.8	35.8	38.3	41.8	45.8	49.3	53.3	57.3	72.3	83.3	98.4	112.6	142.6	3.4	6.2	1.82
25.1	28.6	31.6	33.6	36.1	39.6	43.6	47.1	51.1	55.1	70.1	81.1	96.1	110.4	140.4	4.4	8.0	1.82
19.6	23.2	26.2	28.2	30.7	34.2	38.2	41.7	45.7	49.7	64.8	75.8	90.8	105.0	135.0	6.8	12.4	1.82
26.8	30.4	33.4	35.4	37.9	41.4	45.4	48.9	52.9	56.9	71.9	82.9	97.9	112.1	142.1	3.6	6.6	1.83
0.92	0.94	0.96	0.98	0.99	1.01	1.03	1.05	1.06	1.08	1.14	1.17	1.21	1.24	1.30			
21.4	24.9	27.9	29.9	32.5	36.0	40.0	43.5	47.5	51.5	66.5	77.5	92.5	106.8	136.8	6.0	11.0	1.83
26.4	29.9	32.9	34.9	37.4	40.9	44.9	48.4	52.4	56.4	71.4	82.4	97.4	111.7	141.7	3.8	7.0	1.84
18.1	21.7	24.7	26.7	29.2	32.8	36.8	40.3	44.3	48.3	63.3	74.3	89.4	103.6	133.6	7.4	13.6	1.84
25.9	29.4	32.4	34.4	36.9	40.4	44.4	47.9	51.9	55.9	70.9	81.9	96.9	111.2	141.2	4.0	7.4	1.85
15.1	18.7	21.8	23.8	26.3	29.8	33.9	37.4	41.4	45.4	60.5	71.5	86.5	100.8	130.8	8.6	16.0	1.86
0.92	0.94	0.96	0.97	0.99	1.01	1.03	1.05	1.06	1.08	1.13	1.17	1.21	1.24	1.30			
24.5	28.0	31.0	33.0	35.5	39.0	43.0	46.5	50.5	54.5	69.5	80.5	95.5	109.8	139.8	4.6	8.6	1.87
27.2	30.7	33.7	35.7	38.2	41.7	45.7	49.2	53.2	57.2	72.2	83.2	98.2	112.4	142.4	3.4	6.4	1.88
23.5	27.0	30.0	32.0	34.5	38.0	42.0	45.5	49.5	53.5	68.6	79.6	94.6	108.8	138.8	5.0	9.4	1.88
19.8	23.3	26.3	28.3	30.8	34.4	38.4	41.9	45.9	49.9	64.9	75.9	90.9	105.2	135.2	6.6	12.4	1.88
26.7	30.2	33.2	35.2	37.7	41.2	45.2	48.7	52.7	56.7	71.7	82.7	97.7	112.0	142.0	3.6	6.8	1.89
0.92	0.94	0.96	0.98	0.99	1.01	1.03	1.05	1.06	1.08	1.13	1.17	1.21	1.24	1.30			
25.2	28.8	31.8	33.8	36.3	39.8	43.8	47.3	51.3	55.3	70.3	81.3	96.3	110.6	140.6	4.2	8.0	1.90
21.5	25.1	28.1	30.1	32.6	36.1	40.1	43.6	47.6	51.6	66.7	77.7	92.7	106.9	136.9	5.8	11.0	1.90
16.1	19.7	22.7	24.7	27.3	30.8	34.8	38.3	42.4	46.4	61.4	72.4	87.4	101.7	131.7	8.0	15.4	1.92
27.0	30.5	33.5	35.5	38.0	41.5	45.5	49.0	53.0	57.0	72.0	83.0	98.0	112.3	142.3	3.4	6.6	1.94
26.5	30.0	33.0	35.0	37.5	41.0	45.0	48.5	52.5	56.5	71.6	82.6	97.6	111.8	141.8	3.6	7.0	1.94
0.91	0.94	0.96	0.97	0.99	1.01	1.03	1.04	1.06	1.08	1.13	1.17	1.21	1.24	1.30			
19.9	23.4	26.5	28.5	31.0	34.5	38.5	42.0	46.0	50.0	65.1	76.1	91.1	105.3	135.4	6.4	12.4	1.94
18.4	22.0	25.0	27.0	29.5	33.1	37.1	40.6	44.6	48.6	63.6	74.6	89.7	103.9	133.9	7.0	13.6	1.94
26.0	29.5	32.6	34.6	37.1	40.6	44.6	48.1	52.1	56.1	71.1	82.1	97.1	111.3	141.3	3.8	7.4	1.95
24.6	28.1	31.1	33.1	35.6	39.1	43.1	46.6	50.6	54.6	69.7	80.7	95.7	109.9	139.9	4.4	8.6	1.95
23.6	27.1	30.2	32.2	34.7	38.2	42.2	45.7	49.7	53.7	68.7	79.7	94.7	109.0	139.0	4.8	9.4	1.96
0.91	0.94	0.96	0.97	0.99	1.01	1.03	1.04	1.06	1.08	1.13	1.17	1.21	1.24	1.30			
21.7	25.2	28.2	30.2	32.8	36.3	40.3	43.8	47.8	51.8	66.8	77.8	92.8	107.1	137.1	5.6	11.0	1.96
—	15.9	19.0	21.1	23.6	27.2	31.2	34.8	38.8	42.8	57.9	68.9	83.9	98.2	128.2	9.4	18.4	1.96
26.8	30.3	33.3	35.3	37.9	41.4	45.4	48.9	52.9	56.9	71.9	82.9	97.9	112.1	142.1	3.4	6.8	2.00
25.4	28.9	31.9	33.9	36.4	39.9	43.9	47.4	51.4	55.4	70.4	81.5	96.5	110.7	140.7	4.0	8.0	2.00
20.1	23.6	26.6	28.6	31.1	34.7	38.7	42.2	46.2	50.2	65.2	76.2	91.2	105.5	135.5	6.2	12.4	2.00
0.92	0.94	0.96	0.97	0.99	1.01	1.03	1.05	1.06	1.08	1.13	1.17	1.21	1.24	1.30			
18.6	22.1	25.1	27.2	29.7	33.2	37.2	40.7	44.7	48.8	63.8	74.8	89.8	104.1	134.1	6.8	13.6	2.00
15.5	19.1	22.2	24.2	26.8	30.3	34.3	37.8	41.9	45.9	60.9	71.9	87.0	101.2	131.2	8.0	16.0	2.00
23.8	27.3	30.3	32.3	34.8	38.3	42.3	45.8	49.8	53.9	68.9	79.9	94.9	109.1	139.1	4.6	9.4	2.04
21.8	25.4	28.4	30.4	32.9	36.4	40.4	43.9	47.9	51.9	67.0	78.0	93.0	107.2	137.2	5.4	11.0	2.04
24.7	28.3	31.3	33.3	35.8	39.3	43.3	46.8	50.8	54.8	69.8	80.8	95.8	110.1	140.1	4.2	8.6	2.05
0.91	0.94	0.96	0.97	0.98	1.00	1.02	1.04	1.06	1.08	1.13	1.17	1.20	1.24	1.30			
26.7	30.2	33.2	35.2	37.7	41.2	45.2	48.7	52.7	56.7	71.7	82.7	97.7	112.0	142.0	3.4	7.0	2.06
26.2	29.7	32.7	34.7	37.2	40.7	44.7	48.2	52.2	56.2	71.2	82.2	97.2	111.5	141.5	3.6	7.4	2.06
18.7	22.3	25.3	27.3	29.8	33.4	37.4	40.9	44.9	48.9	63.9	75.0	90.0	104.2	134.2	6.6	13.6	2.06
20.2	23.7	26.8	28.8	31.3	34.8	38.8	42.3	46.3	50.3	65.4	76.4	91.4	105.7	135.7	6.0	12.4	2.07
16.5	20.1	23.1	25.2	27.7	31.2	35.3	38.8	42.8	46.8	61.9	72.9	87.9	102.2	132.2	7.4	15.4	2.08
0.91	0.94	0.96	0.97	0.99	1.01	1.03	1.04	1.06	1.08	1.13	1.17	1.21	1.24	1.30			

FOR BELT SIZES NOT SHOWN, INTERPOLATE FOR ADDITIONAL CENTER DISTANCE.

V-BELT DRIVES

B Stock Drive Selection



V-BELT DRIVES

Speed Ratio	Sheave Combination		DriveN Speeds and HP Per Belt									Nominal Center Distance And Arc-Length Correction Factors					
			3500 RPM DriveR			1750 RPM DriveR			1160 RPM DriveR			B/BX Belt Length Designation					
	DriveR P.D.	DriveN P.D.	DriveN RPM	HP Per Belt B	HP Per Belt BX	DriveN RPM	HP Per Belt B	HP Per Belt BX	DriveN RPM	HP Per Belt B	HP Per Belt BX	35	38	42	46	51	60
2.11	3.8	8.0	1662	3.65	7.15	831	3.09	4.65	551	2.43	3.42	8.9	10.4	12.5	14.5	17.0	21.5
2.12	5.2	11.0	1655	9.40	13.63	827	6.93	8.69	548	5.18	6.26	—	—	—	10.8	13.4	17.9
2.12	6.4	13.6	1647	13.14	18.22	824	10.00	11.96	546	7.44	8.62	—	—	—	—	—	14.8
2.13	9.4	20.0	+	+	+	822	16.71	19.34	545	12.68	14.17	—	—	—	—	—	—
2.14	4.4	9.4	1638	6.29	10.07	819	4.77	6.41	543	3.63	4.65	—	—	10.8	12.8	15.4	19.9
ARC-LENGTH CORRECTION FACTOR												0.72	0.74	0.77	0.80	0.83	0.88
2.14	5.8	12.4	1637	11.42	16.04	819	8.49	10.35	543	6.32	7.45	—	—	—	—	11.6	16.3
2.14	8.6	18.4	+	+	+	818	15.07	17.49	542	11.34	12.74	—	—	—	—	—	—
2.15	4.0	8.6	1628	4.56	8.15	814	3.66	5.25	540	2.83	3.83	8.2	9.7	11.8	13.8	16.3	20.9
2.16	7.4	16.0	+	+	+	809	12.40	14.55	536	9.25	10.52	—	—	—	—	—	—
2.18	3.4	7.4	1608	1.78	5.12	804	1.95	3.46	533	1.62	2.59	9.7	11.2	13.3	15.3	17.8	22.3
ARC-LENGTH CORRECTION FACTOR												0.70	0.73	0.77	0.80	0.83	0.87
2.19	6.2	13.6	1596	12.61	17.53	798	9.51	11.43	529	7.07	8.23	—	—	—	—	—	14.9
2.20	5.0	11.0	1591	8.67	12.78	795	6.40	8.13	527	4.80	5.87	—	—	—	10.9	13.5	18.1
2.20	7.0	15.4	1591	14.55	20.14	795	11.46	13.53	527	8.53	9.77	—	—	—	—	—	—
2.21	5.6	12.4	1581	10.79	15.27	790	7.98	9.80	524	5.95	7.06	—	—	—	—	11.8	16.4
2.22	3.6	8.0	1575	2.74	6.15	787	2.52	4.06	522	2.03	3.01	9.0	10.6	12.6	14.6	17.1	21.7
ARC-LENGTH CORRECTION FACTOR												0.71	0.74	0.77	0.80	0.83	0.88
2.24	4.2	9.4	1564	5.45	9.13	782	4.22	5.84	518	3.23	4.25	—	8.8	10.9	13.0	15.5	20.1
2.26	3.8	8.6	1547	3.67	7.17	773	3.10	4.66	513	2.44	3.42	8.3	9.9	11.9	14.0	16.5	21.0
2.26	6.8	15.4	1545	14.13	19.54	773	10.99	13.02	512	8.17	9.39	—	—	—	—	—	—
2.27	6.0	13.6	1544	12.04	16.81	772	9.01	10.89	512	6.70	7.85	—	—	—	—	—	15.0
2.29	4.8	11.0	1527	7.92	11.91	764	5.87	7.57	506	4.41	5.47	—	—	—	11.1	13.6	18.2
ARC-LENGTH CORRECTION FACTOR												0.70	0.73	0.77	0.79	0.83	0.87
2.29	7.0	16.0	1531	14.56	20.15	766	11.47	13.54	508	8.54	9.77	—	—	—	—	—	—
2.30	5.4	12.4	1524	10.12	14.47	762	7.47	9.25	505	5.57	6.67	—	—	—	—	11.9	16.5
2.30	8.0	18.4	+	+	+	761	13.77	16.05	504	10.31	11.64	—	—	—	—	—	—
2.33	6.6	15.4	1500	13.67	18.91	750	10.50	12.50	497	7.81	9.01	—	—	—	—	—	—
2.33	8.6	20.0	+	+	+	752	15.08	17.50	499	11.35	12.74	—	—	—	—	—	—
ARC-LENGTH CORRECTION FACTOR												0.0	0.0	0.0	0.0	0.78	0.84
2.34	5.8	13.6	1493	11.44	16.06	746	8.50	10.35	495	6.33	7.46	—	—	—	—	—	15.2
2.35	3.4	8.0	1487	1.80	5.13	744	1.95	3.47	493	1.63	2.59	9.2	10.7	12.7	14.8	17.3	21.8
2.35	4.0	9.4	1489	4.58	8.17	745	3.67	5.26	494	2.84	3.84	—	9.0	11.0	13.1	15.6	20.2
2.35	6.8	16.0	1487	14.14	19.55	744	10.99	13.02	493	8.18	9.39	—	—	—	—	—	—
2.38	5.2	12.4	1468	9.43	13.65	734	6.94	8.70	486	5.19	6.27	—	—	—	—	12.0	16.7
ARC-LENGTH CORRECTION FACTOR												0.71	0.74	0.77	0.80	0.83	0.87
2.39	3.6	8.6	1465	2.76	6.17	733	2.53	4.07	486	2.04	3.01	8.4	10.0	12.1	14.1	16.6	21.2
2.39	4.6	11.0	1464	7.13	11.01	732	5.33	7.00	485	4.03	5.07	—	—	—	11.2	13.8	18.4
2.41	6.4	15.4	1455	13.17	18.24	727	10.02	11.97	482	7.45	8.62	—	—	—	—	—	13.0
2.42	6.6	16.0	1444	13.67	18.91	722	10.51	12.50	478	7.81	9.01	—	—	—	—	—	—
2.43	5.6	13.6	1441	10.81	15.29	721	7.99	9.81	478	5.95	7.06	—	—	—	—	—	15.3
ARC-LENGTH CORRECTION FACTOR												0.70	0.73	0.76	0.79	0.82	0.87
2.47	3.8	9.4	1415	3.69	7.18	707	3.11	4.67	469	2.44	3.43	—	9.1	11.2	13.2	15.8	20.3
2.48	5.0	12.4	1411	8.70	12.80	706	6.42	8.14	468	4.81	5.87	—	—	—	—	12.2	16.8
2.48	6.2	15.4	1409	12.63	17.55	705	9.52	11.44	467	7.08	8.24	—	—	—	—	—	13.1
2.49	7.4	18.4	+	+	+	704	12.42	14.57	467	9.26	10.53	—	—	—	—	—	—
2.50	4.4	11.0	1400	6.32	10.09	700	4.79	6.43	464	3.64	4.66	—	—	—	11.3	13.9	18.5
ARC-LENGTH CORRECTION FACTOR												0.0	0.71	0.75	0.78	0.82	0.87
2.50	6.4	16.0	1400	13.18	18.25	700	10.02	11.97	464	7.45	8.63	—	—	—	—	—	—
2.50	8.0	20.0	+	+	+	700	13.78	16.06	464	10.32	11.65	—	—	—	—	—	—
2.52	5.4	13.6	1390	10.14	14.49	695	7.48	9.26	461	5.57	6.67	—	—	—	—	—	15.4
2.53	3.4	8.6	1384	1.81	5.14	692	1.96	3.48	459	1.63	2.59	8.6	10.1	12.2	14.2	16.8	21.3
2.57	6.0	15.4	1364	12.07	16.83	682	9.02	10.90	452	6.71	7.85	—	—	—	—	—	13.3
ARC-LENGTH CORRECTION FACTOR												0.70	0.73	0.76	0.79	0.82	0.87
2.58	4.8	12.4	1355	7.94	11.93	677	5.88	7.58	449	4.42	5.47	—	—	—	—	12.3	17.0
2.58	6.2	16.0	1356	12.64	17.55	678	9.52	11.44	449	7.08	8.24	—	—	—	—	—	—
2.61	3.6	9.4	1340	2.77	6.18	670	2.54	4.08	444	2.04	3.01	—	9.2	11.3	13.4	15.9	20.5
2.62	4.2	11.0	1336	5.48	9.15	668	4.24	5.85	443	3.24	4.25	—	—	—	11.5	14.1	18.7
2.62	5.2	13.6	1338	9.44	13.66	669	6.95	8.70	444	5.19	6.28	—	—	—	—	—	15.6
ARC-LENGTH CORRECTION FACTOR												0.0	0.71	0.75	0.78	0.82	0.86

B = STANDARD V-BELT
 BX = COGGED/NOTCHED V-BELT
 + IF RIM SPEED EXCEEDS 6500 FEET PER MINUTE, CONSULT *Martin*.



Stock Drive Selection **B**

Nominal Center Distances And Arc-Length Correction Factor															Sheave Combination		Speed Ratio
B/BX Belt Length Designation															DriveR P.D.	DriveN P.D.	
68	75	81	85	90	97	105	112	120	128	158	180	210	240	300			
25.5	29.1	32.1	34.1	36.6	40.1	44.1	47.6	51.6	55.6	70.6	81.6	96.6	110.9	140.9	3.8	8.0	2.11
22.0	25.5	28.5	30.5	33.0	36.6	40.6	44.1	48.1	52.1	67.1	78.1	93.1	107.4	137.4	5.2	11.0	2.12
18.8	22.4	25.4	27.5	30.0	33.5	37.5	41.0	45.0	49.1	64.1	75.1	90.1	104.4	134.4	6.4	13.6	2.12
—	—	17.5	19.6	22.2	25.8	29.8	33.4	37.4	41.5	56.6	67.6	82.6	96.9	126.9	9.4	20.0	2.13
23.9	27.4	30.5	32.5	35.0	38.5	42.5	46.0	50.0	54.0	69.0	80.0	95.0	109.3	139.3	4.4	9.4	2.14
0.91	0.94	0.96	0.97	0.99	1.00	1.03	1.04	1.06	1.08	1.13	1.17	1.21	1.24	1.30			
20.3	23.9	26.9	28.9	31.4	34.9	39.0	42.5	46.5	50.5	65.5	76.5	91.5	105.8	135.8	5.8	12.4	2.14
—	16.5	19.6	21.6	24.2	27.8	31.8	35.4	39.4	43.4	58.5	69.5	84.6	98.8	128.9	8.6	18.4	2.14
24.9	28.4	31.4	33.4	35.9	39.4	43.4	46.9	51.0	55.0	70.0	81.0	96.0	110.2	140.2	4.0	8.6	2.15
15.9	19.5	22.6	24.6	27.2	30.7	34.8	38.3	42.3	46.3	61.4	72.4	87.4	101.7	131.7	7.4	16.0	2.16
26.3	29.9	32.9	34.9	37.4	40.9	44.9	48.4	52.4	56.4	71.4	82.4	97.4	111.6	141.7	3.4	7.4	2.18
0.91	0.93	0.96	0.97	0.98	1.00	1.02	1.04	1.06	1.08	1.13	1.16	1.20	1.24	1.30			
19.0	22.5	25.6	27.6	30.1	33.6	37.7	41.2	45.2	49.2	64.2	75.3	90.3	104.5	134.5	6.2	13.6	2.19
22.1	25.7	28.7	30.7	33.2	36.7	40.7	44.2	48.2	52.2	67.3	78.3	93.3	107.5	137.6	5.0	11.0	2.20
16.8	20.4	23.4	25.5	28.0	31.5	35.6	39.1	43.1	47.1	62.2	73.2	88.2	102.5	132.5	7.0	15.4	2.20
20.5	24.0	27.0	29.1	31.6	35.1	39.1	42.6	46.6	50.6	65.7	76.7	91.7	106.0	136.0	5.6	12.4	2.21
25.7	29.2	32.2	34.2	36.7	40.2	44.2	47.7	51.7	55.7	70.8	81.8	96.8	111.0	141.0	3.6	8.0	2.22
0.91	0.94	0.96	0.97	0.98	1.00	1.02	1.04	1.06	1.08	1.13	1.17	1.21	1.24	1.30			
24.1	27.6	30.6	32.6	35.1	38.6	42.6	46.1	50.2	54.2	69.2	80.2	95.2	109.4	139.4	4.2	9.4	2.24
25.0	28.6	31.6	33.6	36.1	39.8	43.6	47.1	51.1	55.1	70.1	81.1	96.1	110.4	140.4	3.8	8.6	2.26
16.9	20.5	23.6	25.6	28.1	31.7	35.7	39.2	43.3	47.3	62.3	73.3	88.4	102.6	132.6	6.8	15.4	2.26
19.1	22.7	25.7	27.7	30.3	33.8	37.8	41.3	45.3	49.4	64.4	75.4	90.4	104.7	134.7	6.0	13.6	2.27
22.3	25.8	28.8	30.8	33.3	36.9	40.9	44.4	48.4	52.4	67.4	78.4	93.4	107.7	137.7	4.8	11.0	2.29
0.91	0.93	0.95	0.97	0.98	1.00	1.02	1.04	1.06	1.08	1.13	1.16	1.20	1.24	1.29			
16.2	19.8	22.9	24.9	27.5	31.0	35.0	38.6	42.6	46.6	61.7	72.7	87.7	102.0	132.0	7.0	16.0	2.29
20.6	24.2	27.2	29.2	31.7	35.2	39.3	42.8	46.8	50.8	65.8	76.8	91.9	106.1	136.1	5.4	12.4	2.30
—	16.9	20.0	22.1	24.6	28.2	32.2	35.8	39.8	43.9	58.9	70.0	85.0	99.3	129.3	8.0	18.4	2.30
17.1	20.7	23.7	25.7	28.3	31.8	35.9	39.4	43.4	47.4	62.5	73.5	88.5	102.8	132.8	6.6	15.4	2.33
—	—	18.0	20.1	22.7	26.3	30.4	34.0	38.0	42.1	57.2	68.2	83.2	97.5	127.6	8.6	20.0	2.33
0.89	0.92	0.94	0.95	0.97	0.99	1.01	1.03	1.05	1.07	1.12	1.16	1.20	1.23	1.29			
19.3	22.8	25.9	27.9	30.4	33.9	38.0	41.5	45.5	49.5	64.5	75.6	90.6	104.8	134.9	5.8	13.6	2.34
25.8	29.4	32.4	34.4	36.9	40.4	44.4	47.9	51.9	55.9	70.9	81.9	96.9	111.2	141.2	3.4	8.0	2.35
24.2	27.7	30.8	32.8	35.3	38.8	42.8	46.3	50.3	54.3	69.3	80.3	95.3	109.6	139.6	4.0	9.4	2.35
16.3	20.0	23.0	25.1	27.6	31.2	35.2	38.7	42.7	46.8	61.8	72.8	87.9	102.1	132.2	6.8	16.0	2.35
20.8	24.3	27.3	29.4	31.9	35.4	39.4	42.9	46.9	50.9	66.0	77.0	92.0	106.3	136.3	5.2	12.4	2.38
0.91	0.93	0.96	0.97	0.98	1.00	1.02	1.04	1.06	1.08	1.13	1.16	1.20	1.24	1.30			
25.2	28.7	31.7	33.7	36.2	39.7	43.7	47.3	51.3	55.3	70.3	81.3	96.3	110.5	140.5	3.6	8.6	2.39
22.4	26.0	29.0	31.0	33.5	37.0	41.0	44.5	48.5	52.6	67.6	78.6	93.6	107.9	137.9	4.6	11.0	2.39
17.2	20.8	23.9	25.9	28.4	32.0	36.0	39.5	43.5	47.6	62.6	73.6	88.7	102.9	133.0	6.4	15.4	2.41
16.5	20.1	23.2	25.2	27.8	31.3	35.3	38.9	42.9	46.9	62.0	73.0	88.0	102.3	132.3	6.6	16.0	2.42
19.4	23.0	26.0	28.0	30.6	34.1	38.1	41.6	45.6	49.7	64.7	75.7	90.7	105.0	135.0	5.6	13.6	2.43
0.91	0.93	0.95	0.97	0.98	1.00	1.02	1.04	1.06	1.08	1.13	1.16	1.20	1.24	1.29			
24.4	27.9	30.9	32.9	35.4	38.9	42.9	46.4	50.5	54.5	69.5	80.5	95.5	109.7	139.8	3.8	9.4	2.47
20.9	24.5	27.5	29.5	32.0	35.5	39.6	43.1	47.1	51.1	66.1	77.1	92.2	106.4	136.4	5.0	12.4	2.48
17.3	20.9	24.0	26.0	28.6	32.1	36.1	39.7	43.7	47.7	62.8	73.8	88.8	103.1	133.1	6.2	15.4	2.48
—	17.3	20.4	22.5	25.0	28.6	32.7	36.2	40.3	44.3	59.4	70.4	85.5	99.7	129.8	7.4	18.4	2.49
22.6	26.1	29.1	31.1	33.6	37.2	41.2	44.7	48.7	52.7	67.7	78.7	93.7	108.0	138.0	4.4	11.0	2.50
0.90	0.93	0.95	0.96	0.98	1.00	1.02	1.04	1.06	1.07	1.13	1.16	1.20	1.24	1.29			
16.6	20.2	23.3	25.4	27.9	31.4	35.5	39.0	43.0	47.1	62.1	73.1	88.2	102.4	132.5	6.4	16.0	2.50
—	—	18.4	20.5	23.1	26.7	30.8	34.4	38.4	42.5	57.6	68.6	83.7	98.0	128.0	8.0	20.0	2.50
19.5	23.1	26.2	28.2	30.7	34.2	38.3	41.8	45.8	49.8	64.8	75.9	90.9	105.1	135.2	5.4	13.6	2.52
25.3	28.9	31.9	33.9	36.4	39.9	43.9	47.4	51.4	55.4	70.4	81.4	96.4	110.7	140.7	3.4	8.6	2.53
17.5	21.1	24.1	26.2	28.7	32.2	36.3	39.8	43.8	47.9	62.9	73.9	89.0	103.2	133.3	6.0	15.4	2.57
0.90	0.93	0.95	0.97	0.98	1.00	1.02	1.04	1.06	1.07	1.13	1.16	1.20	1.24	1.29			
21.0	24.6	27.6	29.6	32.2	35.7	39.7	43.2	47.2	51.3	66.3	77.3	92.3	106.6	136.6	4.8	12.4	2.58
16.7	20.4	23.5	25.5	28.0	31.6	35.6	39.2	43.2	47.2	62.3	73.3	88.3	102.6	132.6	6.2	16.0	2.58
24.5	28.0	31.1	33.1	35.6	39.1	43.1	46.6	50.6	54.6	69.6	80.6	95.6	109.9	139.9	3.6	9.4	2.61
22.7	26.2	29.3	31.3	33.8	37.3	41.3	44.8	48.8	52.9	67.9	78.9	93.9	108.2	138.2	4.2	11.0	2.62
19.7	23.3	26.3	28.3	30.8	34.4	38.4	41.9	45.9	50.0	65.0	76.0	91.0	105.3	135.3	5.2	13.6	2.62
0.90	0.93	0.95	0.96	0.98	1.00	1.02	1.04	1.06	1.07	1.13	1.16	1.20	1.24	1.29			

FOR BELT SIZES NOT SHOWN, INTERPOLATE FOR ADDITIONAL CENTER DISTANCE.

V-BELT DRIVES

B Stock Drive Selection



V-BELT DRIVES

Speed Ratio	Sheave Combination		DriveN Speeds and HP Per Belt									Nominal Center Distance And Arc-Length Correction Factors					
			3500 RPM DriveR			1750 RPM DriveR			1160 RPM DriveR			B/BX Belt Length Designation					
	DriveR P.D.	DriveN P.D.	DriveN RPM	HP Per Belt B	HP Per Belt BX	DriveN RPM	HP Per Belt B	HP Per Belt BX	DriveN RPM	HP Per Belt B	HP Per Belt BX	35	38	42	46	51	60
2.63	7.0	18.4	1332	14.59	20.17	666	11.48	13.55	441	8.54	9.78	—	—	—	—	—	—
2.66	5.8	15.4	1318	11.46	16.08	659	8.51	10.36	437	6.33	7.46	—	—	—	—	—	13.4
2.66	9.4	25.0	+	+	+	658	16.73	19.36	436	12.70	14.18	—	—	—	—	—	—
2.67	6.0	16.0	1313	12.07	16.83	656	9.02	10.91	435	6.71	7.85	—	—	—	—	—	—
2.70	4.6	12.4	1298	7.15	11.03	649	5.34	7.01	430	4.03	5.07	—	—	—	—	12.4	17.1
ARC-LENGTH CORRECTION FACTOR												0.0	0.0	0.0	0.0	0.78	0.84
2.70	7.4	20.0	+	+	+	647	12.42	14.57	429	9.26	10.53	—	—	—	—	—	—
2.71	6.8	18.4	1293	14.16	19.57	647	11.00	13.03	429	8.18	9.40	—	—	—	—	—	—
2.72	5.0	13.6	1287	8.71	12.81	643	6.42	8.14	426	4.81	5.88	—	—	—	—	—	15.7
2.75	4.0	11.0	1273	4.61	8.19	636	3.68	5.27	422	2.85	3.85	—	—	9.5	11.6	14.2	18.8
2.75	5.6	15.4	1273	10.83	15.30	636	8.00	9.82	422	5.96	7.07	—	—	—	—	—	13.5
ARC-LENGTH CORRECTION FACTOR												0.0	0.0	0.72	0.76	0.80	0.85
2.76	3.4	9.4	1266	1.82	5.15	633	1.97	3.48	420	1.64	2.60	—	—	9.4	11.5	13.5	20.6
2.76	5.8	16.0	1269	11.47	16.08	634	8.52	10.36	420	6.34	7.46	—	—	—	—	—	—
2.79	6.6	18.4	1255	13.69	18.93	628	10.52	12.51	416	7.82	9.01	—	—	—	—	—	—
2.82	4.4	12.4	1242	6.33	10.11	621	4.80	6.43	412	3.64	4.67	—	—	—	—	12.6	17.2
2.83	4.8	13.6	1235	7.95	11.94	618	5.89	7.58	409	4.42	5.48	—	—	—	—	11.1	15.8
ARC-LENGTH CORRECTION FACTOR												0.0	0.71	0.75	0.78	0.81	0.86
2.85	5.4	15.4	1227	10.16	14.50	614	7.48	9.27	407	5.58	6.68	—	—	—	—	—	13.6
2.86	5.6	16.0	1225	10.83	15.31	612	8.00	9.82	406	5.96	7.07	—	—	—	—	—	12.9
2.86	7.0	20.0	1225	14.59	20.18	613	11.48	13.55	406	8.55	9.78	—	—	—	—	—	—
2.87	6.4	18.4	1217	13.19	18.26	609	10.03	11.98	403	7.45	8.63	—	—	—	—	—	—
2.89	3.8	11.0	1209	3.71	7.20	605	3.12	4.68	401	2.45	3.43	—	—	9.6	11.7	14.3	18.9
ARC-LENGTH CORRECTION FACTOR												0.0	0.0	0.71	0.76	0.80	0.85
2.91	8.6	25.0	+	+	+	602	15.09	17.51	399	11.36	12.75	—	—	—	—	—	—
2.94	6.8	20.0	1190	14.17	19.57	595	11.01	13.03	394	8.19	9.40	—	—	—	—	—	—
2.95	4.2	12.4	1185	5.49	9.16	593	4.24	5.85	393	3.25	4.26	—	—	—	—	12.7	17.4
2.96	4.6	13.6	1184	7.16	11.04	592	5.35	7.01	392	4.04	5.07	—	—	—	—	11.2	16.0
2.96	5.2	15.4	1182	9.45	13.67	591	6.96	8.71	392	5.20	6.28	—	—	—	—	—	13.8
ARC-LENGTH CORRECTION FACTOR												0.0	0.0	0.0	0.0	0.77	0.84
2.96	5.4	16.0	1181	10.16	14.50	591	7.48	9.27	391	5.58	6.68	—	—	—	—	—	13.0
2.97	6.2	18.4	1179	12.66	17.57	590	9.53	11.45	391	7.08	8.24	—	—	—	—	—	—
3.03	6.6	20.0	1155	13.70	18.94	577	10.52	12.51	383	7.82	9.02	—	—	—	—	—	—
3.06	3.6	11.0	1145	2.79	6.19	573	2.55	4.08	380	2.05	3.02	—	—	9.7	11.9	14.5	19.1
3.07	6.0	18.4	1141	12.08	16.84	571	9.03	10.91	378	6.71	7.86	—	—	—	—	—	—
ARC-LENGTH CORRECTION FACTOR												0.0	0.0	0.71	0.75	0.79	0.85
3.08	5.0	15.4	1136	8.72	12.82	568	6.43	8.15	377	4.81	5.88	—	—	—	—	—	13.9
3.08	5.2	16.0	1137	9.46	13.68	569	6.96	8.71	377	5.20	6.28	—	—	—	—	—	13.1
3.09	4.4	13.6	1132	6.34	10.11	566	4.80	6.44	375	3.64	4.67	—	—	—	—	11.3	16.1
3.10	4.0	12.4	1129	4.62	8.20	565	3.69	5.27	374	2.85	3.85	—	—	—	10.2	12.8	17.5
3.13	6.4	20.0	1120	13.20	18.27	560	10.03	11.98	371	7.46	8.63	—	—	—	—	—	—
ARC-LENGTH CORRECTION FACTOR												0.0	0.0	0.0	0.72	0.77	0.84
3.13	8.0	25.0	+	+	+	560	13.79	16.07	371	10.32	11.65	—	—	—	—	—	—
3.17	5.8	18.4	1103	11.48	16.09	552	8.52	10.37	366	6.34	7.47	—	—	—	—	—	—
3.19	9.4	30.0	+	+	+	548	16.74	19.37	363	12.70	14.19	—	—	—	—	—	—
3.20	5.0	16.0	1094	8.73	12.82	547	6.43	8.15	363	4.82	5.88	—	—	—	—	—	13.3
3.21	4.8	15.4	1091	7.96	11.95	545	5.89	7.58	362	4.43	5.48	—	—	—	—	—	14.0
ARC-LENGTH CORRECTION FACTOR												0.0	0.0	0.0	0.0	0.0	0.78
3.23	6.2	20.0	1085	12.66	17.57	542	9.54	11.45	360	7.09	8.25	—	—	—	—	—	—
3.24	3.4	11.0	1082	1.84	5.17	541	1.97	3.49	359	1.64	2.60	—	—	9.9	12.0	14.6	19.2
3.24	4.2	13.6	1081	5.50	9.17	540	4.25	5.86	358	3.25	4.26	—	—	—	—	11.5	16.2
3.26	3.8	12.4	1073	3.72	7.21	536	3.12	4.68	355	2.45	3.44	—	—	—	10.3	13.0	17.7
3.29	5.6	18.4	1065	10.84	15.32	533	8.01	9.82	353	5.96	7.07	—	—	—	—	—	—
ARC-LENGTH CORRECTION FACTOR												0.0	0.0	0.71	0.75	0.79	0.85
3.33	4.8	16.0	1050	7.96	11.95	525	5.89	7.59	348	4.43	5.48	—	—	—	—	—	13.4
3.33	6.0	20.0	1050	12.09	16.85	525	9.03	10.91	348	6.72	7.86	—	—	—	—	—	—
3.35	4.6	15.4	1045	7.17	11.05	523	5.35	7.01	346	4.04	5.08	—	—	—	—	—	14.2
3.38	7.4	25.0	+	+	+	518	12.43	14.58	343	9.27	10.54	—	—	—	—	—	—
3.40	4.0	13.6	1029	4.62	8.20	515	3.69	5.27	341	2.85	3.85	—	—	—	—	11.6	16.4
ARC-LENGTH CORRECTION FACTOR												0.0	0.0	0.0	0.0	0.74	0.82

B = STANDARD V-BELT
 BX = COGGED/NOTCHED V-BELT
 + IF RIM SPEED EXCEEDS 6500 FEET PER MINUTE, CONSULT *Martin*.



Stock Drive Selection **B**

Nominal Center Distances And Arc-Length Correction Factor																Sheave Combination		Speed Ratio
B/BX Belt Length Designation																DriveR P.D.	DriveN P.D.	
68	75	81	85	90	97	105	112	120	128	158	180	195	210	240	300			
—	17.5	20.7	22.7	25.3	28.9	33.0	36.5	40.6	44.6	59.7	70.7	78.2	85.8	100.0	130.1	7.0	18.4	2.63
17.6	21.2	24.3	26.3	28.9	32.4	36.4	40.0	44.0	48.0	63.1	74.1	81.6	89.1	103.4	133.4	5.8	15.4	2.66
—	—	—	—	—	20.9	25.2	28.8	33.0	37.1	52.3	63.4	71.0	78.5	92.8	122.9	9.4	25.0	2.66
16.9	20.5	23.6	25.6	28.2	31.7	35.8	39.3	43.3	47.4	62.4	73.5	81.0	88.5	102.7	132.8	6.0	16.0	2.67
21.2	24.7	27.8	29.8	32.3	35.8	39.9	43.4	47.4	51.4	66.4	77.5	85.0	92.5	106.7	136.7	4.6	12.4	2.70
0.88	0.91	0.94	0.95	0.97	0.99	1.01	1.03	1.05	1.07	1.12	1.16	1.18	1.20	1.23	1.29			
—	—	18.8	20.9	23.5	27.1	31.2	34.8	38.9	42.9	58.0	69.1	76.6	84.1	98.4	128.5	7.4	20.0	2.70
—	17.7	20.8	22.9	25.4	29.0	33.1	36.6	40.7	44.7	59.8	70.9	78.4	85.9	100.2	130.2	6.8	18.4	2.71
19.8	23.4	26.4	28.5	31.0	34.5	38.6	42.1	46.1	50.1	65.1	76.2	83.7	91.2	105.5	135.5	5.0	13.6	2.72
22.9	26.4	29.4	31.4	33.9	37.5	41.5	45.0	49.0	53.0	68.0	79.0	86.5	94.1	108.3	138.3	4.0	11.0	2.75
17.7	21.3	24.4	26.5	29.0	32.5	36.6	40.1	44.1	48.2	63.2	74.2	81.8	89.3	103.5	133.6	5.6	15.4	2.75
0.89	0.92	0.94	0.96	0.97	0.99	1.02	1.03	1.05	1.07	1.13	1.16	1.18	1.20	1.23	1.29			
24.7	28.3	31.2	33.2	35.7	39.2	43.2	46.8	50.8	54.8	69.8	80.8	88.3	95.8	110.1	140.1	3.4	9.4	2.76
17.0	20.6	23.7	25.8	28.3	31.9	35.9	39.4	43.5	47.5	62.6	73.6	81.1	88.6	102.9	132.9	5.8	16.0	2.76
—	17.8	20.9	23.0	25.6	29.2	33.2	36.8	40.8	44.9	60.0	71.0	78.5	86.1	100.3	130.4	6.6	18.4	2.79
21.3	24.9	27.9	29.9	32.5	36.0	40.0	43.5	47.5	51.6	66.6	77.6	85.1	92.6	106.9	136.9	4.4	12.4	2.82
20.0	23.5	26.6	28.6	31.1	34.7	38.7	42.2	46.2	50.3	65.3	76.3	83.8	91.3	105.6	135.6	4.8	13.6	2.83
0.90	0.93	0.95	0.96	0.98	1.00	1.02	1.04	1.06	1.07	1.13	1.16	1.18	1.20	1.24	1.29			
17.9	21.5	24.6	26.6	29.1	32.7	36.7	40.3	44.3	48.3	63.4	74.4	81.9	89.4	103.7	133.7	5.4	15.4	2.85
17.1	20.8	23.9	25.9	28.5	32.0	36.1	39.6	43.6	47.7	62.7	73.8	81.3	88.8	103.1	133.1	5.6	16.0	2.86
—	15.9	19.1	21.2	23.8	27.4	31.5	35.1	39.2	43.2	58.3	69.4	76.9	84.4	98.7	128.8	7.0	20.0	2.86
—	17.9	21.1	23.1	25.7	29.3	33.4	36.9	41.0	45.0	60.1	71.2	78.7	86.2	100.5	130.5	6.4	18.4	2.87
23.0	26.5	29.6	31.6	34.1	37.6	41.6	45.1	49.1	53.2	68.2	79.2	86.7	94.2	108.5	138.5	3.8	11.0	2.89
0.89	0.92	0.94	0.96	0.97	0.99	1.01	1.03	1.05	1.07	1.12	1.16	1.18	1.20	1.23	1.29			
—	—	—	—	—	21.4	25.7	29.4	33.5	37.6	52.9	64.0	71.5	79.1	93.4	123.5	8.6	25.0	2.91
—	16.0	19.2	21.3	23.9	27.6	31.7	35.2	39.3	43.3	58.5	69.5	77.1	84.6	98.9	128.9	6.6	20.0	2.94
21.5	25.0	28.1	30.1	32.6	36.1	40.2	43.7	47.7	51.7	66.7	77.8	85.3	92.8	107.0	137.1	4.2	12.4	2.95
20.1	23.7	26.7	28.8	31.3	34.8	38.8	42.4	46.4	50.4	65.5	76.5	84.0	91.5	105.8	135.8	4.6	13.6	2.96
18.0	21.6	24.7	26.7	29.3	32.8	36.9	40.4	44.4	48.5	63.5	74.5	82.1	89.6	103.8	133.9	5.2	15.4	2.96
0.88	0.91	0.93	0.95	0.97	0.99	1.01	1.03	1.05	1.06	1.12	1.16	1.18	1.20	1.23	1.29			
17.3	20.9	24.0	26.1	28.6	32.2	36.2	39.7	43.8	47.8	62.9	73.9	81.4	88.9	103.2	133.2	5.4	16.0	2.96
14.3	18.0	21.2	23.3	25.9	29.4	33.5	37.1	41.1	45.2	60.3	71.3	78.8	86.4	100.6	130.7	6.2	18.4	2.97
—	16.1	19.3	21.5	24.1	27.7	31.8	35.4	39.4	43.5	58.6	69.7	77.2	84.7	99.0	129.1	6.6	20.0	3.03
23.1	26.7	29.7	31.7	34.2	37.8	41.8	45.3	49.3	53.3	68.3	79.3	86.9	94.4	108.6	138.6	3.6	11.0	3.06
14.4	18.2	21.3	23.4	26.0	29.6	33.7	37.2	41.3	45.3	60.4	71.5	79.0	86.5	100.8	130.8	6.0	18.4	3.07
0.89	0.92	0.94	0.95	0.97	0.99	1.01	1.03	1.05	1.07	1.12	1.16	1.18	1.20	1.23	1.29			
18.1	21.8	24.8	26.9	29.4	33.0	37.0	40.5	44.6	48.6	63.7	74.7	82.2	89.7	104.0	134.0	5.0	15.4	3.08
17.4	21.1	24.1	26.2	28.7	32.3	36.3	39.9	43.9	47.9	63.0	74.1	81.6	89.1	103.4	133.4	5.2	16.0	3.08
20.2	23.8	26.9	28.9	31.4	35.0	39.0	42.5	46.5	50.6	65.6	76.6	84.1	91.6	105.9	135.9	4.4	13.6	3.09
21.6	25.2	28.2	30.2	32.8	36.3	40.3	43.8	47.8	51.8	66.9	77.9	85.4	92.9	107.2	137.2	4.0	12.4	3.10
—	16.2	19.5	21.6	24.2	27.8	31.9	35.5	39.6	43.6	58.8	69.8	77.4	84.9	99.2	129.2	6.4	20.0	3.13
0.88	0.91	0.93	0.95	0.96	0.99	1.01	1.03	1.05	1.06	1.12	1.16	1.18	1.20	1.23	1.29			
—	—	—	—	—	21.8	26.1	29.8	33.9	38.0	53.3	64.4	72.0	79.5	93.8	123.9	8.0	25.0	3.13
14.5	18.3	21.5	23.6	26.1	29.7	33.8	37.4	41.4	45.5	60.6	71.6	79.1	86.7	100.9	131.0	5.8	18.4	3.17
—	—	—	—	—	—	—	23.7	28.1	32.3	47.8	59.1	66.7	74.2	88.6	118.8	9.4	30.0	3.19
17.5	21.2	24.3	26.3	28.9	32.4	36.5	40.0	44.1	48.1	63.2	74.2	81.7	89.2	103.5	133.5	5.0	16.0	3.20
18.3	21.9	25.0	27.0	29.6	33.1	37.2	40.7	44.7	48.7	63.8	74.8	82.4	89.9	104.2	134.2	4.8	15.4	3.21
0.84	0.88	0.91	0.93	0.95	0.97	1.00	1.01	1.04	1.05	1.11	1.15	1.17	1.19	1.23	1.29			
—	16.4	19.6	21.7	24.3	28.0	32.1	35.7	39.7	43.8	58.9	70.0	77.5	85.0	99.3	129.4	6.2	20.0	3.23
23.3	26.8	29.8	31.9	34.4	37.9	41.9	45.4	49.4	53.5	68.5	79.5	87.0	94.5	108.8	138.8	3.4	11.0	3.24
20.4	24.0	27.0	29.0	31.6	35.1	39.1	42.7	46.7	50.7	65.8	76.8	84.3	91.8	106.1	136.1	4.2	13.6	3.24
21.8	25.3	28.4	30.4	32.9	36.4	40.4	44.0	48.0	52.0	67.0	78.1	85.6	93.1	107.3	137.4	3.8	12.4	3.26
14.7	18.4	21.6	23.7	26.3	29.9	33.9	37.5	41.6	45.6	60.7	71.8	79.3	86.8	101.1	131.1	5.6	18.4	3.29
0.89	0.92	0.94	0.95	0.97	0.99	1.01	1.03	1.05	1.07	1.12	1.16	1.18	1.20	1.23	1.29			
17.7	21.3	24.4	26.5	29.0	32.6	36.6	40.2	44.2	48.2	63.3	74.4	81.9	89.4	103.7	133.7	4.8	16.0	3.33
—	16.5	19.7	21.9	24.5	28.1	32.2	35.8	39.9	43.9	59.1	70.1	77.7	85.2	99.5	129.5	6.0	20.0	3.33
18.4	22.0	25.1	27.2	29.7	33.3	37.3	40.8	44.9	48.9	64.0	75.0	82.5	90.0	104.3	134.3	4.6	15.4	3.35
—	—	—	—	18.3	22.2	26.5	30.2	34.3	38.4	53.7	64.9	72.4	80.0	94.3	124.4	7.4	25.0	3.38
20.5	24.1	27.2	29.2	31.7	35.3	39.3	42.8	46.8	50.9	65.9	76.9	84.4	92.0	106.2	136.2	4.0	13.6	3.40
0.87	0.90	0.93	0.94	0.96	0.98	1.00	1.02	1.04	1.06	1.12	1.15	1.18	1.20	1.23	1.29			

FOR BELT SIZES NOT SHOWN, INTERPOLATE FOR ADDITIONAL CENTER DISTANCE.

V-BELT DRIVES

B Stock Drive Selection



V-BELT DRIVES

Speed Ratio	Sheave Combination		DriveN Speeds and HP Per Belt									Nominal Center Distance And Arc-Length Correction Factors					
			3500 RPM DriveR			1750 RPM DriveR			1160 RPM DriveR			B/BX Belt Length Designation					
	DriveR P.D.	DriveN P.D.	DriveN RPM	HP Per Belt B	HP Per Belt BX	DriveN RPM	HP Per Belt B	HP Per Belt BX	DriveN RPM	HP Per Belt B	HP Per Belt BX	35	38	42	46	51	60
3.41	5.4	18.4	1027	10.17	14.51	514	7.49	9.27	340	5.58	6.68	—	—	—	—	—	—
3.44	3.6	12.4	1016	2.79	6.20	508	2.55	4.09	337	2.05	3.02	—	—	—	10.4	13.1	17.8
3.45	5.8	20.0	1015	11.48	16.10	507	8.53	10.37	336	6.34	7.47	—	—	—	—	—	—
3.48	4.6	16.0	1006	7.17	11.05	503	5.35	7.02	333	4.04	5.08	—	—	—	—	—	13.5
3.49	8.6	30.0	+	+	+	502	15.10	17.52	333	11.36	12.75	—	—	—	—	—	—
ARC-LENGTH CORRECTION FACTOR												0.0	0.0	0.0	0.72	0.77	0.83
3.50	4.4	15.4	1000	6.35	10.12	500	4.80	6.44	331	3.65	4.67	—	—	—	—	—	14.3
3.54	5.2	18.4	989	9.47	13.68	495	6.96	8.72	328	5.20	6.28	—	—	—	—	—	—
3.57	5.6	20.0	980	10.84	15.32	490	8.01	9.83	325	5.96	7.08	—	—	—	—	—	—
3.57	7.0	25.0	980	14.61	20.19	490	11.49	13.56	325	8.55	9.78	—	—	—	—	—	—
3.58	3.8	13.6	978	3.72	7.21	489	3.12	4.68	324	2.45	3.44	—	—	—	—	11.7	16.5
ARC-LENGTH CORRECTION FACTOR												0.0	0.0	0.0	0.0	0.74	0.82
3.64	4.4	16.0	962	6.35	10.12	481	4.80	6.44	319	3.65	4.67	—	—	—	—	—	13.6
3.65	3.4	12.4	960	1.84	5.17	480	1.98	3.49	318	1.64	2.60	—	—	—	10.5	13.2	17.9
3.67	4.2	15.4	955	5.50	9.18	477	4.25	5.86	316	3.25	4.26	—	—	—	—	—	14.4
3.68	5.0	18.4	951	8.73	12.83	476	6.43	8.15	315	4.82	5.88	—	—	—	—	—	—
3.68	6.8	25.0	952	14.18	19.59	476	11.01	13.04	316	8.19	9.40	—	—	—	—	—	—
ARC-LENGTH CORRECTION FACTOR												0.0	0.0	0.0	0.72	0.77	0.83
3.70	5.4	20.0	945	10.17	14.52	472	7.49	9.27	313	5.59	6.68	—	—	—	—	—	—
3.75	8.0	30.0	+	+	+	467	13.80	16.08	309	10.33	11.66	—	—	—	—	—	—
3.78	3.6	13.6	926	2.80	6.20	463	2.55	4.09	307	2.05	3.02	—	—	—	—	11.8	16.6
3.79	6.6	25.0	924	13.71	18.95	462	10.53	12.52	306	7.83	9.02	—	—	—	—	—	—
3.81	4.2	16.0	919	5.51	9.18	459	4.25	5.86	304	3.25	4.26	—	—	—	—	—	13.8
ARC-LENGTH CORRECTION FACTOR												0.0	0.0	0.0	0.0	0.74	0.82
3.83	4.8	18.4	913	7.97	11.95	457	5.90	7.59	303	4.43	5.48	—	—	—	—	—	—
3.85	4.0	15.4	909	4.63	8.21	455	3.69	5.28	301	2.86	3.85	—	—	—	—	—	14.5
3.85	5.2	20.0	910	9.47	13.69	455	6.97	8.72	302	5.20	6.28	—	—	—	—	—	—
3.91	6.4	25.0	896	13.21	18.28	448	10.04	11.99	297	7.46	8.64	—	—	—	—	—	—
4.00	3.4	13.6	875	1.85	5.17	437	1.98	3.49	290	1.64	2.60	—	—	—	—	12.0	16.8
ARC-LENGTH CORRECTION FACTOR												0.0	0.0	0.0	0.0	0.74	0.82
4.00	4.0	16.0	875	4.63	8.21	438	3.69	5.28	290	2.86	3.85	—	—	—	—	—	13.9
4.00	4.6	18.4	875	7.18	11.05	437	5.35	7.02	290	4.04	5.08	—	—	—	—	—	—
4.00	5.0	20.0	875	8.74	12.83	438	6.44	8.16	290	4.82	5.88	—	—	—	—	—	—
4.03	6.2	25.0	868	12.67	17.58	434	9.54	11.46	288	7.09	8.25	—	—	—	—	—	—
4.04	9.4	38.0	+	+	+	433	16.75	19.37	287	12.71	14.19	—	—	—	—	—	—
ARC-LENGTH CORRECTION FACTOR												0.0	0.0	0.0	0.0	0.0	0.77
4.05	3.8	15.4	864	3.73	7.22	432	3.13	4.69	286	2.46	3.44	—	—	—	—	—	14.7
4.05	7.4	30.0	+	+	+	432	12.43	14.58	286	9.27	10.54	—	—	—	—	—	—
4.17	4.8	20.0	840	7.97	11.96	420	5.90	7.59	278	4.43	5.48	—	—	—	—	—	—
4.17	6.0	25.0	840	12.10	16.86	420	9.04	10.92	278	6.72	7.86	—	—	—	—	—	—
4.18	4.4	18.4	837	6.36	10.13	418	4.81	6.44	277	3.65	4.67	—	—	—	—	—	—
ARC-LENGTH CORRECTION FACTOR												0.0	0.0	0.0	0.0	0.0	0.78
4.21	3.8	16.0	831	3.73	7.22	416	3.13	4.69	275	2.46	3.44	—	—	—	—	—	14.0
4.28	3.6	15.4	818	2.80	6.21	409	2.56	4.09	271	2.05	3.02	—	—	—	—	—	14.8
4.29	7.0	30.0	817	14.62	20.20	408	11.50	13.56	271	8.56	9.79	—	—	—	—	—	—
4.31	5.8	25.0	812	11.49	16.11	406	8.53	10.38	269	6.34	7.47	—	—	—	—	—	—
4.35	4.6	20.0	805	7.18	11.05	402	5.36	7.02	267	4.04	5.08	—	—	—	—	—	—
ARC-LENGTH CORRECTION FACTOR												0.0	0.0	0.0	0.0	0.0	0.78
4.38	4.2	18.4	799	5.51	9.18	399	4.25	5.86	265	3.26	4.26	—	—	—	—	—	—
4.41	6.8	30.0	793	14.19	19.59	397	11.02	13.04	263	8.19	9.41	—	—	—	—	—	—
4.42	8.6	38.0	+	+	+	396	15.10	17.52	263	11.37	12.76	—	—	—	—	—	—
4.44	3.6	16.0	787	2.80	6.21	394	2.56	4.09	261	2.05	3.02	—	—	—	—	—	14.1
4.46	5.6	25.0	784	10.85	15.33	392	8.02	9.83	260	5.97	7.08	—	—	—	—	—	—
ARC-LENGTH CORRECTION FACTOR												0.0	0.0	0.0	0.0	0.0	0.77
4.53	3.4	15.4	773	1.85	5.18	386	1.98	3.49	256	1.65	2.61	—	—	—	—	—	14.9
4.55	4.4	20.0	770	6.36	10.13	385	4.81	6.44	255	3.65	4.67	—	—	—	—	—	—
4.55	6.6	30.0	770	13.72	18.95	385	10.53	12.52	255	7.83	9.02	—	—	—	—	—	—
4.60	4.0	18.4	761	4.64	8.21	380	3.69	5.28	252	2.86	3.85	—	—	—	—	—	—
4.63	5.4	25.0	756	10.18	14.52	378	7.50	9.28	251	5.59	6.68	—	—	—	—	—	—
ARC-LENGTH CORRECTION FACTOR												0.0	0.0	0.0	0.0	0.0	0.78

B = STANDARD V-BELT
 BX = COGGED/NOTCHED V-BELT
 + IF RIM SPEED EXCEEDS 6500 FEET PER MINUTE, CONSULT *Martin*.



Stock Drive Selection **B**

V-BELT DRIVES

Nominal Center Distances And Arc-Length Correction Factor															Sheave Combination		Speed Ratio	
B/BX Belt Length Designation															DriveR P.D.	DriveN P.D.		
68	75	81	85	90	97	105	112	120	128	158	180	195	210	240			300	
14.8	18.6	21.7	23.8	26.4	30.0	34.1	37.6	41.7	45.7	60.9	71.9	79.4	87.0	101.2	131.3	5.4	18.4	3.41
21.9	25.5	28.5	30.5	33.0	36.6	40.6	44.1	48.1	52.1	67.2	78.2	85.7	93.2	107.5	137.5	3.6	12.4	3.44
—	16.6	19.9	22.0	24.6	28.2	32.4	35.9	40.0	44.1	59.2	70.3	77.8	85.3	99.6	129.7	5.8	20.0	3.45
17.8	21.5	24.6	26.6	29.2	32.7	36.8	40.3	44.4	48.4	63.5	74.5	82.0	89.5	103.8	133.8	4.6	16.0	3.48
—	—	—	—	—	—	—	24.2	28.6	32.8	48.4	59.6	67.2	74.8	89.2	119.4	8.6	30.0	3.49
0.88	0.91	0.93	0.95	0.96	0.99	1.01	1.03	1.05	1.06	1.12	1.16	1.18	1.20	1.23	1.29			
18.5	22.2	25.3	27.3	29.8	33.4	37.4	41.0	45.0	49.0	64.1	75.1	82.7	90.2	104.5	134.5	4.4	15.4	3.50
14.9	18.7	21.9	24.0	26.5	30.1	34.2	37.8	41.8	45.9	61.0	72.1	79.6	87.1	101.4	131.4	5.2	18.4	3.54
—	16.7	20.0	22.1	24.7	28.4	32.5	36.1	40.1	44.2	59.4	70.4	78.0	85.5	99.8	129.8	5.6	20.0	3.57
—	—	—	—	18.6	22.5	26.8	30.4	34.6	38.7	54.0	65.1	72.7	80.3	94.6	124.7	7.0	25.0	3.57
20.7	24.2	27.3	29.3	31.9	35.4	39.4	43.0	47.0	51.0	66.1	77.1	84.6	92.1	106.4	136.4	3.8	13.6	3.58
0.87	0.90	0.92	0.94	0.96	0.98	1.00	1.02	1.04	1.06	1.12	1.15	1.18	1.20	1.23	1.29			
17.9	21.6	24.7	26.7	29.3	32.9	36.9	40.5	44.5	48.5	63.6	74.7	82.2	89.7	104.0	134.0	4.4	16.0	3.64
22.0	25.6	28.6	30.7	33.2	36.7	40.7	44.3	48.3	52.3	67.3	78.4	85.9	93.4	107.5	137.7	3.4	12.4	3.65
18.7	22.3	25.4	27.4	30.0	33.5	37.6	41.1	45.2	49.2	64.3	75.3	82.8	90.3	104.6	134.6	4.2	15.4	3.67
15.0	18.8	22.0	24.1	26.7	30.3	34.4	37.9	42.0	46.0	61.2	72.2	79.7	87.3	101.6	131.6	5.0	18.4	3.68
—	—	—	—	18.7	22.6	26.9	30.6	34.7	38.9	54.2	65.3	72.9	80.4	94.7	124.8	6.8	25.0	3.68
0.88	0.91	0.93	0.95	0.96	0.98	1.01	1.03	1.04	1.06	1.12	1.16	1.18	1.20	1.23	1.29			
—	16.9	20.1	22.3	24.9	28.5	32.6	36.2	40.3	44.4	59.5	70.6	78.1	85.6	99.9	130.0	5.4	20.0	3.70
—	—	—	—	—	—	—	24.6	29.0	33.2	48.8	60.0	67.7	75.3	89.6	119.8	8.0	30.0	3.75
20.8	24.4	27.4	29.5	32.0	35.5	39.6	43.1	47.1	51.1	66.2	77.2	84.7	92.3	106.5	136.5	3.6	13.6	3.78
—	—	—	—	18.8	22.7	27.0	30.7	34.9	39.0	54.3	65.4	73.0	80.6	94.9	125.0	6.6	25.0	3.79
18.1	21.7	24.8	26.9	29.4	33.0	37.1	40.6	44.6	48.7	63.8	74.8	82.3	89.8	104.1	134.2	4.2	16.0	3.81
0.86	0.90	0.92	0.94	0.96	0.98	1.00	1.02	1.04	1.06	1.12	1.15	1.17	1.19	1.23	1.29			
15.2	19.0	22.1	24.2	26.8	30.4	34.5	38.1	42.1	46.2	61.3	72.4	79.9	87.4	101.7	131.8	4.8	18.4	3.83
18.8	22.4	25.5	27.6	30.1	33.7	37.7	41.3	45.3	49.3	64.4	75.4	83.0	90.5	104.8	134.8	4.0	15.4	3.85
—	17.0	20.3	22.4	25.0	28.7	32.8	36.4	40.4	44.5	59.6	70.7	78.3	85.8	100.1	130.1	5.2	20.0	3.85
—	—	—	—	19.0	22.8	27.1	30.8	35.0	39.1	54.4	65.6	73.1	80.7	95.0	125.1	6.4	25.0	3.91
20.9	24.5	27.6	29.6	32.1	35.7	39.7	43.2	47.3	51.3	66.4	77.4	84.9	92.4	106.7	136.7	3.4	13.6	4.00
0.86	0.90	0.92	0.94	0.96	0.98	1.00	1.02	1.04	1.06	1.12	1.15	1.17	1.19	1.23	1.29			
18.2	21.9	25.0	27.0	29.6	33.1	37.2	40.8	44.8	48.8	63.9	75.0	82.5	90.0	104.3	134.3	4.0	16.0	4.00
15.3	19.1	22.3	24.4	27.0	30.6	34.6	38.2	42.3	46.3	61.4	72.5	80.0	87.6	101.9	131.9	4.6	18.4	4.00
—	17.1	20.4	22.5	25.1	28.8	32.9	36.5	40.6	44.6	59.8	70.9	78.4	85.9	100.2	130.3	5.0	20.0	4.00
—	—	—	—	19.1	23.0	27.3	31.0	35.1	39.3	54.6	65.7	73.3	80.8	95.2	125.3	6.2	25.0	4.03
—	—	—	—	—	—	—	—	—	—	40.1	51.7	59.5	67.1	81.7	112.0	9.4	38.0	4.04
0.84	0.88	0.91	0.92	0.94	0.97	0.99	1.01	1.03	1.05	1.11	1.15	1.17	1.19	1.23	1.29			
18.9	22.6	25.7	27.7	30.3	33.8	37.9	41.4	45.5	49.5	64.6	75.6	83.1	90.6	104.9	134.9	3.8	15.4	4.05
—	—	—	—	—	—	21.0	25.0	29.4	33.6	49.2	60.5	68.1	75.7	90.1	120.2	7.4	30.0	4.05
—	17.2	20.5	22.6	25.3	28.9	33.0	36.6	40.7	44.8	59.9	71.0	78.6	86.1	100.4	130.5	4.8	20.0	4.17
—	—	—	—	19.2	23.1	27.4	31.1	35.3	39.4	54.7	65.9	73.4	81.0	95.3	125.4	6.0	25.0	4.17
15.4	19.2	22.4	24.5	27.1	30.7	34.8	38.4	42.4	46.5	61.6	72.7	80.2	87.7	102.0	132.1	4.4	18.4	4.18
0.84	0.88	0.91	0.93	0.95	0.97	0.99	1.01	1.03	1.05	1.11	1.15	1.17	1.19	1.23	1.29			
18.3	22.0	25.1	27.2	29.7	33.3	37.4	40.9	44.9	49.0	64.1	75.1	82.6	90.1	104.4	134.5	3.8	16.0	4.21
19.1	22.7	25.8	27.9	30.4	34.0	38.0	41.6	45.6	49.6	64.7	75.7	83.3	90.8	105.1	135.1	3.6	15.4	4.28
—	—	—	—	—	—	21.2	25.2	29.6	33.9	49.5	60.8	68.4	76.0	90.4	120.5	7.0	30.0	4.29
—	—	—	—	19.3	23.2	27.5	31.2	35.4	39.5	54.9	66.0	73.6	81.1	95.5	125.6	5.8	25.0	4.31
—	17.4	20.6	22.8	25.4	29.1	33.2	36.8	40.9	44.9	60.1	71.2	78.7	86.2	100.5	130.6	4.6	20.0	4.35
0.84	0.88	0.91	0.93	0.94	0.97	0.99	1.01	1.03	1.05	1.11	1.15	1.17	1.19	1.23	1.29			
15.5	19.3	22.5	24.6	27.2	30.8	34.9	38.5	42.6	46.6	61.7	72.8	80.3	87.9	102.2	132.2	4.2	18.4	4.38
—	—	—	—	—	—	21.3	25.3	29.7	34.0	49.6	60.9	68.5	76.1	90.5	120.7	6.8	30.0	4.41
—	—	—	—	—	—	—	—	—	—	40.6	52.2	60.0	67.7	82.2	112.6	8.6	38.0	4.42
18.5	22.1	25.2	27.3	29.9	33.4	37.5	41.0	45.1	49.1	64.2	75.3	82.8	90.3	104.6	134.6	3.6	16.0	4.44
—	—	—	—	19.4	23.4	27.7	31.4	35.5	39.7	55.0	66.2	73.7	81.3	95.6	125.7	5.6	25.0	4.46
0.83	0.87	0.90	0.92	0.94	0.97	0.99	1.01	1.03	1.05	1.11	1.15	1.17	1.19	1.22	1.28			
19.2	22.8	25.9	28.0	30.5	34.1	38.2	41.7	45.7	49.8	64.9	75.9	83.4	90.9	105.2	135.3	3.4	15.4	4.53
—	17.5	20.8	22.9	25.5	29.2	33.3	36.9	41.0	45.1	60.2	71.3	78.9	86.4	100.7	130.8	4.4	20.0	4.55
—	—	—	—	—	—	21.5	25.5	29.9	34.2	49.8	61.0	68.7	76.3	90.6	120.8	6.6	30.0	4.55
15.7	19.5	22.7	24.8	27.4	31.0	35.1	38.6	42.7	46.8	61.9	73.0	80.5	88.0	102.3	132.4	4.0	18.4	4.60
—	—	—	—	19.6	23.5	27.8	31.5	35.7	39.8	55.2	66.3	73.9	81.4	95.8	125.9	5.4	25.0	4.63
0.84	0.88	0.91	0.92	0.94	0.97	0.99	1.01	1.03	1.05	1.11	1.15	1.17	1.19	1.23	1.29			

FOR BELT SIZES NOT SHOWN, INTERPOLATE FOR ADDITIONAL CENTER DISTANCE.

B Stock Drive Selection



V-BELT DRIVES

Speed Ratio	Sheave Combination		DriveN Speeds and HP Per Belt									Nominal Center Distance And Arc-Length Correction Factors					
			3500 RPM DriveR			1750 RPM DriveR			1160 RPM DriveR								
	DriveR P.D.	DriveN P.D.	DriveN RPM	HP Per Belt B	HP Per Belt BX	DriveN RPM	HP Per Belt B	HP Per Belt BX	DriveN RPM	HP Per Belt B	HP Per Belt BX	B/BX Belt Length Designation					
												35	38	42	46	51	60
4.69	6.4	30.0	747	13.22	18.28	373	10.04	11.99	247	7.46	8.64	-	-	-	-	-	
4.71	3.4	16.0	744	1.85	5.18	372	1.98	3.49	246	1.65	2.61	-	-	-	-	14.3	
4.75	8.0	38.0	+	+	+	368	13.80	16.08	244	10.33	11.66	-	-	-	-	-	
4.76	4.2	20.0	735	5.51	9.18	367	4.25	5.86	244	3.26	4.26	-	-	-	-	-	
4.81	5.2	25.0	728	9.48	13.69	364	6.97	8.72	241	5.21	6.29	-	-	-	-	-	
ARC-LENGTH CORRECTION FACTOR												0.0	0.0	0.0	0.0	0.0	0.77
4.84	3.8	18.4	723	3.73	7.22	361	3.13	4.69	240	2.46	3.44	-	-	-	-	-	
4.84	6.2	30.0	723	12.68	17.59	362	9.54	11.46	240	7.09	8.25	-	-	-	-	-	
5.00	4.0	20.0	700	4.64	8.21	350	3.70	5.28	232	2.86	3.85	-	-	-	-	-	
5.00	5.0	25.0	700	8.74	12.84	350	6.44	8.16	232	4.82	5.89	-	-	-	-	-	
5.00	6.0	30.0	700	12.11	16.86	350	9.04	10.92	232	6.72	7.86	-	-	-	-	-	
ARC-LENGTH CORRECTION FACTOR												0.0	0.0	0.0	0.0	0.0	0.0
5.11	3.6	18.4	685	2.81	6.21	342	2.56	4.09	227	2.05	3.02	-	-	-	-	-	
5.14	7.4	38.0	+	+	+	341	12.44	14.58	226	9.27	10.54	-	-	-	-	-	
5.17	5.8	30.0	677	11.50	16.11	338	8.53	10.38	224	6.35	7.47	-	-	-	-	-	
5.21	4.8	25.0	672	7.98	11.96	336	5.90	7.59	223	4.43	5.48	-	-	-	-	-	
5.26	3.8	20.0	665	3.74	7.22	332	3.13	4.69	220	2.46	3.44	-	-	-	-	-	
ARC-LENGTH CORRECTION FACTOR												0.0	0.0	0.0	0.0	0.0	0.0
5.36	5.6	30.0	653	10.86	15.33	327	8.02	9.83	217	5.97	7.08	-	-	-	-	-	
5.41	3.4	18.4	647	1.86	5.18	323	1.98	3.49	214	1.65	2.61	-	-	-	-	-	
5.43	4.6	25.0	644	7.19	11.06	322	5.36	7.02	213	4.04	5.08	-	-	-	-	-	
5.43	7.0	38.0	645	14.62	20.21	322	11.50	13.56	214	8.56	9.79	-	-	-	-	-	
5.56	3.6	20.0	630	2.81	6.21	315	2.56	4.09	209	2.05	3.03	-	-	-	-	-	
ARC-LENGTH CORRECTION FACTOR												0.0	0.0	0.0	0.0	0.0	0.0
5.56	5.4	30.0	630	10.18	14.53	315	7.50	9.28	209	5.59	6.68	-	-	-	-	-	
5.59	6.8	38.0	626	14.19	19.60	313	11.02	13.05	208	8.19	9.41	-	-	-	-	-	
5.68	4.4	25.0	616	6.37	10.13	308	4.81	6.45	204	3.65	4.67	-	-	-	-	-	
5.76	6.6	38.0	608	13.73	18.96	304	10.53	12.52	201	7.83	9.02	-	-	-	-	-	
5.77	5.2	30.0	607	9.48	13.70	303	6.97	8.72	201	5.21	6.29	-	-	-	-	-	
ARC-LENGTH CORRECTION FACTOR												0.0	0.0	0.0	0.0	0.0	0.0
5.88	3.4	20.0	595	1.86	5.18	297	1.98	3.49	197	1.65	2.61	-	-	-	-	-	
5.94	6.4	38.0	589	13.22	18.29	295	10.04	11.99	195	7.46	8.64	-	-	-	-	-	
5.95	4.2	25.0	588	5.52	9.19	294	4.26	5.87	195	3.26	4.27	-	-	-	-	-	
6.00	5.0	30.0	583	8.75	12.84	292	6.44	8.16	193	4.82	5.89	-	-	-	-	-	
6.13	6.2	38.0	571	12.68	17.59	286	9.55	11.46	189	7.09	8.25	-	-	-	-	-	
ARC-LENGTH CORRECTION FACTOR												0.0	0.0	0.0	0.0	0.0	0.0
6.25	4.0	25.0	560	4.64	8.22	280	3.70	5.28	186	2.86	3.86	-	-	-	-	-	
6.25	4.8	30.0	560	7.98	11.96	280	5.90	7.59	186	4.44	5.49	-	-	-	-	-	
6.33	6.0	38.0	553	12.11	16.87	276	9.04	10.92	183	6.72	7.86	-	-	-	-	-	
6.52	4.6	30.0	537	7.19	11.06	268	5.36	7.02	178	4.05	5.08	-	-	-	-	-	
6.55	5.8	38.0	534	11.50	16.11	267	8.53	10.38	177	6.35	7.47	-	-	-	-	-	
ARC-LENGTH CORRECTION FACTOR												0.0	0.0	0.0	0.0	0.0	0.0
6.58	3.8	25.0	532	3.74	7.23	266	3.13	4.69	176	2.46	3.44	-	-	-	-	-	
6.79	5.6	38.0	516	10.86	15.33	258	8.02	9.83	171	5.97	7.08	-	-	-	-	-	
6.82	4.4	30.0	513	6.37	10.14	257	4.81	6.45	170	3.65	4.68	-	-	-	-	-	
6.94	3.6	25.0	504	2.81	6.22	252	2.56	4.10	167	2.05	3.03	-	-	-	-	-	
7.04	5.4	38.0	497	10.19	14.53	249	7.50	9.28	165	5.59	6.68	-	-	-	-	-	
ARC-LENGTH CORRECTION FACTOR												0.0	0.0	0.0	0.0	0.0	0.0
7.14	4.2	30.0	490	5.52	9.19	245	4.26	5.87	162	3.26	4.27	-	-	-	-	-	
7.31	5.2	38.0	479	9.48	13.70	239	6.97	8.72	159	5.21	6.29	-	-	-	-	-	
7.35	3.4	25.0	476	1.86	5.18	238	1.98	3.50	158	1.65	2.61	-	-	-	-	-	
7.50	4.0	30.0	467	4.64	8.22	233	3.70	5.28	155	2.86	3.86	-	-	-	-	-	
7.60	5.0	38.0	461	8.75	12.84	230	6.44	8.16	153	4.82	5.89	-	-	-	-	-	
ARC-LENGTH CORRECTION FACTOR												0.0	0.0	0.0	0.0	0.0	0.0
7.89	3.8	30.0	443	3.74	7.23	222	3.13	4.69	147	2.46	3.44	-	-	-	-	-	
7.92	4.8	38.0	442	7.98	11.97	221	5.90	7.59	147	4.44	5.49	-	-	-	-	-	
8.26	4.6	38.0	424	7.19	11.06	212	5.36	7.02	140	4.05	5.08	-	-	-	-	-	
8.33	3.6	30.0	420	2.81	6.22	210	2.56	4.10	139	2.06	3.03	-	-	-	-	-	
8.64	4.4	38.0	405	6.37	10.14	203	4.81	6.45	134	3.65	4.68	-	-	-	-	-	
ARC-LENGTH CORRECTION FACTOR												0.0	0.0	0.0	0.0	0.0	0.0

B = STANDARD V-BELT
 BX = COGGED/NOTCHED V-BELT
 + IF RIM SPEED EXCEEDS 6500 FEET PER MINUTE, CONSULT *Martin*.



Stock Drive Selection **B**

Nominal Center Distances And Arc-Length Correction Factor															Sheave Combination		Speed Ratio	
B/BX Belt Length Designation															DriveR P.D.	DriveN P.D.		
68	75	81	85	90	97	105	112	120	128	158	180	195	210	240			300	
—	—	—	—	—	—	21.6	25.6	30.0	34.3	49.9	61.2	68.8	76.4	90.8	121.0	6.4	30.0	4.69
18.6	22.3	25.4	27.4	30.0	33.6	37.6	41.2	45.2	49.3	64.4	75.4	82.9	90.4	104.7	134.8	3.4	16.0	4.71
—	—	—	—	—	—	—	—	—	—	41.0	52.6	60.4	68.1	82.7	113.0	8.0	38.0	4.75
—	17.6	20.9	23.0	25.7	29.3	33.5	37.1	41.1	45.2	60.4	71.5	79.0	86.5	100.8	130.9	4.2	20.0	4.76
—	—	—	—	19.7	23.6	27.9	31.6	35.8	40.0	55.3	66.4	74.0	81.6	95.9	126.0	5.2	25.0	4.81
0.83	0.87	0.90	0.92	0.94	0.96	0.99	1.01	1.03	1.05	1.11	1.15	1.17	1.19	1.22	1.28			
15.8	19.6	22.8	24.9	27.5	31.1	35.2	38.8	42.8	46.9	62.0	73.1	80.6	88.2	102.5	132.5	3.8	18.4	4.84
—	—	—	—	—	—	21.7	25.7	30.1	34.4	50.1	61.3	68.9	76.5	90.9	121.1	6.2	30.0	4.84
—	17.7	21.0	23.2	25.8	29.5	33.6	37.2	41.3	45.3	60.5	71.6	79.1	86.7	101.0	131.1	4.0	20.0	5.00
—	—	—	—	19.8	23.7	28.1	31.8	35.9	40.1	55.4	66.6	74.2	81.7	96.1	126.2	5.0	25.0	5.00
—	—	—	—	—	—	21.8	25.8	30.2	34.5	50.2	61.5	69.1	76.7	91.1	121.3	6.0	30.0	5.00
0.78	0.84	0.88	0.90	0.92	0.95	0.98	1.00	1.02	1.04	1.10	1.14	1.16	1.19	1.22	1.28			
15.9	19.7	22.9	25.0	27.6	31.2	35.3	38.9	43.0	47.0	62.2	73.2	80.8	88.3	102.6	132.7	3.6	18.4	5.11
—	—	—	—	—	—	—	—	—	—	41.4	53.0	60.8	68.5	83.1	113.5	7.4	38.0	5.14
—	—	—	—	—	—	21.9	26.0	30.4	34.7	50.3	61.6	69.2	76.8	91.2	121.4	5.8	30.0	5.17
—	—	—	17.0	19.9	23.9	28.2	31.9	36.1	40.2	55.6	66.7	74.3	81.9	96.2	126.3	4.8	25.0	5.21
—	17.9	21.2	23.3	25.9	29.6	33.7	37.3	41.4	45.5	60.7	71.8	79.3	86.8	101.1	131.2	3.8	20.0	5.26
0.78	0.84	0.88	0.90	0.92	0.95	0.98	1.00	1.02	1.04	1.10	1.14	1.16	1.18	1.22	1.28			
—	—	—	—	—	—	22.1	26.1	30.5	34.8	50.5	61.7	69.4	77.0	91.4	121.6	5.6	30.0	5.36
16.0	19.9	23.1	25.2	27.8	31.4	35.5	39.1	43.1	47.2	62.3	73.4	80.9	88.5	102.8	132.8	3.4	18.4	5.41
—	—	—	17.1	20.1	24.0	28.3	32.0	36.2	40.4	55.7	66.9	74.5	82.0	96.4	126.5	4.6	25.0	5.43
—	—	—	—	—	—	—	—	—	—	41.7	53.3	61.1	68.8	83.4	113.8	7.0	38.0	5.43
14.0	18.0	21.3	23.4	26.1	29.7	33.9	37.5	41.6	45.6	60.8	71.9	79.4	87.0	101.3	131.4	3.6	20.0	5.56
0.78	0.84	0.88	0.90	0.92	0.95	0.98	1.00	1.02	1.04	1.10	1.14	1.16	1.18	1.22	1.28			
—	—	—	—	—	—	22.2	26.2	30.6	34.9	50.6	61.9	69.5	77.1	91.5	121.7	5.4	30.0	5.56
—	—	—	—	—	—	—	—	—	24.8	41.8	53.4	61.2	68.9	83.5	113.9	6.8	38.0	5.59
—	—	—	17.2	20.2	24.1	28.4	32.2	36.3	40.5	55.9	67.0	74.6	82.2	96.5	126.6	4.4	25.0	5.68
—	—	—	—	—	—	—	—	—	24.9	41.9	53.6	61.4	69.1	83.6	114.0	6.6	38.0	5.76
—	—	—	—	—	—	22.3	26.3	30.8	35.1	50.7	62.0	69.7	77.3	91.7	121.9	5.2	30.0	5.77
0.0	0.0	0.0	0.76	0.82	0.87	0.92	0.95	0.98	1.01	1.08	1.12	1.15	1.17	1.21	1.27			
14.1	18.1	21.4	23.6	26.2	29.9	34.0	37.6	41.7	45.8	61.0	72.0	79.6	87.1	101.4	131.5	3.4	20.0	5.88
—	—	—	—	—	—	—	—	—	25.0	42.1	53.7	61.5	69.2	83.8	114.2	6.4	38.0	5.94
—	—	—	17.3	20.3	24.2	28.6	32.3	36.5	40.6	56.0	67.2	74.7	82.3	96.7	126.8	4.2	25.0	5.95
—	—	—	—	—	—	—	22.4	26.5	30.9	46.2	57.4	64.9	72.4	86.8	117.0	5.0	30.0	6.00
—	—	—	—	—	—	—	—	—	25.2	42.2	53.8	61.6	69.4	83.9	114.3	6.2	38.0	6.13
0.72	0.80	0.85	0.88	0.90	0.93	0.96	0.99	1.01	1.03	1.10	1.14	1.16	1.18	1.22	1.28			
—	—	—	17.5	20.4	24.4	28.7	32.4	36.6	40.8	56.1	67.3	74.9	82.5	96.8	126.9	4.0	25.0	6.25
—	—	—	—	—	—	22.5	26.6	31.0	35.3	51.0	62.3	69.9	77.5	92.0	122.2	4.8	30.0	6.25
—	—	—	—	—	—	—	—	—	25.3	42.3	54.0	61.8	69.5	84.1	114.5	6.0	38.0	6.33
—	—	—	—	—	—	22.7	26.7	31.1	35.5	51.1	62.4	70.1	77.7	92.1	122.3	4.6	30.0	6.52
—	—	—	—	—	—	—	—	—	25.4	42.4	54.1	61.9	69.6	84.2	114.6	5.8	38.0	6.55
0.0	0.0	0.0	0.76	0.82	0.87	0.92	0.95	0.98	1.00	1.08	1.12	1.15	1.17	1.21	1.27			
—	—	—	17.6	20.5	24.5	28.8	32.6	36.8	40.9	56.3	67.4	75.0	82.6	97.0	127.1	3.8	25.0	6.58
—	—	—	—	—	—	—	—	—	25.5	42.6	54.2	62.0	69.8	84.4	114.8	5.6	38.0	6.79
—	—	—	—	—	—	22.8	26.8	31.3	35.6	51.3	62.6	70.2	77.8	92.2	122.5	4.4	30.0	6.82
—	—	—	17.7	20.7	24.6	29.0	32.7	36.9	41.0	56.4	67.6	75.2	82.7	97.1	127.2	3.6	25.0	6.94
—	—	—	—	—	—	—	—	—	25.6	42.7	54.4	62.2	69.9	84.5	114.9	5.4	38.0	7.04
0.0	0.0	0.0	0.75	0.81	0.87	0.92	0.95	0.98	1.00	1.08	1.12	1.15	1.17	1.21	1.27			
—	—	—	—	—	—	22.9	27.0	31.4	35.7	51.4	62.7	70.4	78.0	92.4	122.6	4.2	30.0	7.14
—	—	—	—	—	—	—	—	—	25.7	42.8	54.5	62.3	70.1	84.6	115.1	5.2	38.0	7.31
—	—	—	17.8	20.8	24.7	29.1	32.8	37.0	41.2	56.6	67.7	75.3	82.9	97.2	127.4	3.4	25.0	7.35
—	—	—	—	—	—	23.0	27.1	31.5	35.8	51.6	62.9	70.5	78.1	92.5	122.8	4.0	30.0	7.50
—	—	—	—	—	—	—	—	—	25.9	43.0	54.6	62.4	70.2	84.8	115.2	5.0	38.0	7.60
0.0	0.0	0.0	0.75	0.81	0.87	0.91	0.95	0.98	1.00	1.08	1.12	1.15	1.17	1.21	1.27			
—	—	—	—	—	—	23.1	27.2	31.6	36.0	51.7	63.0	70.6	78.3	92.7	122.9	3.8	30.0	7.89
—	—	—	—	—	—	—	—	—	26.0	43.1	54.8	62.6	70.3	84.9	115.3	4.8	38.0	7.92
—	—	—	—	—	—	—	—	—	26.1	43.2	54.9	62.7	70.5	85.1	115.5	4.6	38.0	8.26
—	—	—	—	—	23.3	27.3	31.8	36.1	40.5	56.1	67.4	75.0	82.6	97.0	127.1	3.6	30.0	8.33
—	—	—	—	—	—	—	—	—	26.6	43.3	55.0	62.9	70.6	85.2	115.6	4.4	38.0	8.64
0.0	0.0	0.0	0.0	0.0	0.0	0.82	0.88	0.92	0.96	1.06	1.10	1.13	1.16	1.20	1.26			

FOR BELT SIZES NOT SHOWN, INTERPOLATE FOR ADDITIONAL CENTER DISTANCE.

V-BELT DRIVES

B Stock Drive Selection



V-BELT DRIVES

Speed Ratio	Sheave Combination		DriveN Speeds and HP Per Belt									Nominal Center Distance And Arc-Length Correction Factors					
			3500 RPM DriveR			1750 RPM DriveR			1160 RPM DriveR			B/BX Belt Length Designation					
	DriveR P.D.	DriveN P.D.	DriveN RPM	HP Per Belt B	HP Per Belt BX	DriveN RPM	HP Per Belt B	HP Per Belt BX	DriveN RPM	HP Per Belt B	HP Per Belt BX	35	38	42	46	51	60
8.82	3.4	30.0	397	1.86	5.19	198	1.98	3.50	131	1.65	2.61	—	—	—	—	—	—
9.05	4.2	38.0	387	5.52	9.19	193	4.26	5.87	128	3.26	4.27	—	—	—	—	—	—
9.50	4.0	38.0	368	4.64	8.22	184	3.70	5.28	122	2.86	3.89	—	—	—	—	—	—
10.00	3.8	38.0	350	3.74	7.23	175	3.13	4.69	116	2.46	3.44	—	—	—	—	—	—
10.56	3.6	38.0	332	2.82	6.22	166	2.56	4.10	110	2.06	3.03	—	—	—	—	—	—
ARC-LENGTH CORRECTION FACTOR												0.0	0.0	0.0	0.0	0.0	0.0
11.18	3.4	38.0	313	1.86	5.19	157	1.99	3.50	104	1.65	2.61	—	—	—	—	—	—
ARC-LENGTH CORRECTION FACTOR												0.0	0.0	0.0	0.0	0.0	0.0

B = STANDARD V-BELT
 BX = COGGED/NOTCHED V-BELT
 + IF RIM SPEED EXCEEDS 6500 FEET PER MINUTE, CONSULT *Martin*.



Stock Drive Selection **B**

Nominal Center Distances And Arc-Length Correction Factor																Sheave Combination		Speed Ratio
B/BX Belt Length Designation																DriveR P.D.	DriveN P.D.	
68	75	81	85	90	97	105	112	120	128	158	180	195	210	240	300			
—	—	—	—	—	—	23.4	27.4	31.9	36.2	52.0	63.3	70.9	78.5	93.0	123.2	3.4	30.0	8.82
—	—	—	—	—	—	—	—	—	26.3	43.5	55.2	63.0	70.7	85.3	115.8	4.2	38.0	9.05
—	—	—	—	—	—	—	—	—	26.5	43.6	55.3	63.1	70.9	85.5	115.9	4.0	38.0	9.50
—	—	—	—	—	—	—	—	—	26.6	43.7	55.4	63.3	71.0	85.6	116.1	3.8	38.0	10.00
—	—	—	—	—	—	—	—	—	26.7	43.9	55.6	63.4	71.1	85.8	116.2	3.6	38.0	10.56
0.0	0.0	0.0	0.0	0.0	0.0	0.82	0.88	0.92	0.96	1.05	1.10	1.13	1.15	1.19	1.26			
—	—	—	—	—	—	—	—	—	26.8	44.0	55.7	63.5	71.3	85.9	116.3	3.4	38.0	11.18
0.0	0.0	0.0	0.0	0.0	0.0	0.0	0.0	0.0	0.80	0.99	1.06	1.10	1.13	1.17	1.25			

FOR BELT SIZES NOT SHOWN, INTERPOLATE FOR ADDITIONAL CENTER DISTANCE.

V-BELT DRIVES

C Stock Drive Selection



V-BELT DRIVES

Speed Ratio	Sheave Combination		DriveN Speeds and HP Per Belt									Nominal Center Distance And Arc-Length Correction Factors					
			1750 RPM DriveR			1160 RPM DriveR			870 RPM DriveR			C/CX Belt Length Designation					
	DriveR P.D.	DriveN P.D.	DriveN RPM	HP Per Belt C	HP Per Belt CX	DriveN RPM	HP Per Belt C	HP Per Belt CX	DriveN RPM	HP Per Belt C	HP Per Belt CX	51	60	68	75	81	85
1.00	5.0	5.0	1750	2.03	6.39	1160	2.24	5.05	870	2.10	4.17	19.1	23.6	27.6	31.1	34.1	36.1
1.00	5.5	5.5	1750	4.24	8.67	1160	3.84	6.68	870	3.35	5.45	18.3	22.8	26.8	30.3	33.3	35.3
1.00	6.0	6.0	1750	6.39	10.90	1160	5.42	8.29	870	4.59	6.70	17.5	22.0	26.0	29.5	32.5	34.5
1.00	7.0	7.0	1750	10.51	15.20	1160	8.49	11.44	870	7.02	9.18	16.0	20.5	24.5	28.0	31.0	33.0
1.00	7.5	7.5	1750	12.47	17.27	1160	9.99	12.98	870	8.21	10.39	15.2	19.7	23.7	27.2	30.2	32.2
ARC-LENGTH CORRECTION FACTOR												0.77	0.81	0.84	0.86	0.87	0.88
1.00	8.0	8.0	1750	14.37	19.28	1160	11.46	14.50	870	9.39	11.60	14.4	18.9	22.9	26.4	29.4	31.4
1.00	8.5	8.5	1750	16.20	21.24	1160	12.91	16.00	870	10.56	12.79	13.6	18.1	22.1	25.6	28.6	30.6
1.00	9.0	9.0	1750	17.96	23.14	1160	14.33	17.47	870	11.71	13.97	12.8	17.3	21.3	24.8	27.8	29.8
1.00	9.5	9.5	1750	19.65	24.98	1160	15.73	18.92	870	12.84	15.14	12.0	16.5	20.5	24.0	27.0	29.0
1.00	10.0	10.0	1750	21.26	26.75	1160	17.10	20.35	870	13.97	16.29	—	15.7	19.7	23.2	26.2	28.2
ARC-LENGTH CORRECTION FACTOR												0.77	0.81	0.84	0.86	0.87	0.88
1.00	10.5	10.5	1750	22.79	28.46	1160	18.44	21.76	870	15.07	17.43	—	15.0	19.0	22.5	25.5	27.5
1.00	11.0	11.0	1750	24.24	30.10	1160	19.75	23.14	870	16.17	18.56	—	—	18.2	21.7	24.7	26.7
1.00	12.0	12.0	1750	26.90	33.18	1160	22.29	25.83	870	18.31	20.78	—	—	16.6	20.1	23.1	25.1
1.00	13.0	13.0	1750	29.19	35.95	1160	24.71	28.42	870	20.39	22.95	—	—	—	18.5	21.5	23.5
1.00	14.0	14.0	1750	31.11	38.42	1160	27.00	30.90	870	22.41	25.07	—	—	—	—	20.0	22.0
ARC-LENGTH CORRECTION FACTOR												0.0	0.81	0.84	0.86	0.87	0.88
1.00	16.0	16.0	+	+	+	1160	31.19	35.54	870	26.26	29.14	—	—	—	—	—	—
1.05	9.5	10.0	1663	20.18	25.41	1102	16.08	19.22	827	13.11	15.35	—	16.1	20.1	23.6	26.6	28.6
1.05	10.0	10.5	1667	21.79	27.19	1105	17.45	20.64	829	14.23	16.51	—	15.3	19.3	22.8	25.8	27.8
1.05	10.5	11.0	1670	23.32	28.90	1107	18.79	22.05	830	15.33	17.65	—	—	18.6	22.1	25.1	27.1
1.06	8.0	8.5	1647	14.99	19.80	1092	11.87	14.84	819	9.70	11.85	14.0	18.5	22.5	26.0	29.0	31.0
ARC-LENGTH CORRECTION FACTOR												0.77	0.81	0.83	0.85	0.87	0.88
1.06	8.5	9.0	1653	16.82	21.75	1096	13.32	16.34	822	10.86	13.04	13.2	17.7	21.7	25.2	28.2	30.2
1.06	9.0	9.5	1658	18.58	23.65	1099	14.74	17.81	824	12.01	14.22	12.4	16.9	20.9	24.4	27.4	29.4
1.07	7.0	7.5	1633	11.21	15.78	1083	8.96	11.83	812	7.37	9.47	15.6	20.1	24.1	27.6	30.6	32.6
1.07	7.5	8.0	1641	13.18	17.85	1088	10.46	13.37	816	8.56	10.68	14.8	19.3	23.3	26.8	29.8	31.8
1.08	12.0	13.0	1615	27.68	33.83	1071	22.81	26.26	803	18.70	21.10	—	—	—	19.3	22.3	24.3
ARC-LENGTH CORRECTION FACTOR												0.77	0.81	0.83	0.85	0.87	0.88
1.08	13.0	14.0	1625	29.97	36.60	1077	25.23	28.85	808	20.78	23.27	—	—	—	—	20.7	22.7
1.09	5.5	6.0	1604	5.10	9.38	1063	4.41	7.16	798	3.78	5.80	17.9	22.4	26.4	29.9	32.9	34.9
1.09	11.0	12.0	1604	25.10	30.81	1063	20.32	23.61	798	16.59	18.91	—	—	17.4	20.9	23.9	25.9
1.10	5.0	5.5	1591	2.96	7.16	1055	2.86	5.56	791	2.56	4.56	18.7	23.2	27.2	30.7	33.7	35.7
1.10	10.0	11.0	1591	22.19	27.52	1055	17.71	20.87	791	14.43	16.67	—	—	19.0	22.5	25.5	27.5
ARC-LENGTH CORRECTION FACTOR												0.77	0.81	0.83	0.85	0.87	0.88
1.11	9.0	10.0	1575	18.96	23.97	1044	14.99	18.02	783	12.20	14.83	12.0	16.5	20.5	24.0	27.0	29.0
1.11	9.5	10.5	1583	20.65	25.81	1050	16.39	19.48	787	13.34	15.55	—	15.7	19.7	23.2	26.2	28.2
1.12	8.5	9.5	1566	17.27	22.13	1038	13.62	16.58	778	11.09	13.23	12.8	17.3	21.3	24.8	27.8	29.8
1.13	7.5	8.5	1544	13.60	18.21	1024	10.74	13.60	768	8.77	10.86	14.4	18.9	22.9	26.4	29.4	31.4
1.13	8.0	9.0	1556	15.50	20.22	1031	12.21	15.12	773	9.95	12.06	13.6	18.1	22.1	25.6	28.6	30.6
ARC-LENGTH CORRECTION FACTOR												0.76	0.80	0.83	0.85	0.87	0.88
1.13	16.0	18.0	+	+	+	1031	31.94	36.16	773	26.82	29.60	—	—	—	—	—	—
1.14	7.0	8.0	1531	11.69	16.18	1015	9.28	12.09	761	7.61	9.67	15.2	19.7	23.7	27.2	30.2	32.3
1.14	10.5	12.0	1531	23.98	29.44	1015	19.22	22.41	761	15.66	17.92	—	—	17.8	21.3	24.3	26.3
1.14	14.0	16.0	1531	32.29	39.40	1015	27.79	31.56	761	23.00	25.56	—	—	—	—	—	20.4
1.16	9.5	11.0	1511	20.94	26.05	1002	16.58	19.64	751	13.49	15.67	—	15.3	19.3	22.8	25.8	27.8
ARC-LENGTH CORRECTION FACTOR												0.77	0.80	0.83	0.85	0.87	0.88
1.17	6.0	7.0	1500	7.73	12.01	994	6.31	9.03	746	5.26	7.26	16.7	21.2	25.2	28.7	31.7	33.7
1.17	9.0	10.5	1500	19.30	24.26	994	15.22	18.21	746	12.37	14.52	—	16.1	20.1	23.6	26.6	28.6
1.17	12.0	14.0	1500	28.24	34.29	994	23.18	26.57	746	18.97	21.33	—	—	—	18.5	21.5	23.5
1.18	8.5	10.0	1488	17.59	22.40	986	13.83	16.76	740	11.25	13.36	12.4	16.9	20.9	24.4	27.4	29.4
1.18	11.0	13.0	1481	25.63	31.26	982	20.67	23.91	736	16.86	19.13	—	—	16.6	20.1	23.1	25.1
ARC-LENGTH CORRECTION FACTOR												0.77	0.80	0.83	0.85	0.87	0.88
1.19	8.0	9.5	1474	15.81	20.48	977	12.41	15.29	733	10.11	12.19	13.2	17.7	21.7	25.2	28.2	30.2
1.20	5.0	6.0	1458	3.51	7.61	967	3.22	5.87	725	2.83	4.78	18.3	22.8	26.8	30.3	33.3	35.3
1.20	7.5	9.0	1458	13.95	18.50	967	10.97	13.80	725	8.95	11.00	14.0	18.5	22.5	26.0	29.0	31.0
1.20	10.0	12.0	1458	22.74	27.98	967	18.07	21.17	725	14.70	16.90	—	—	18.1	21.6	24.7	26.7
1.21	7.0	8.5	1441	12.03	16.46	955	9.50	12.28	716	7.77	9.80	14.8	19.3	23.3	26.8	29.8	31.8
ARC-LENGTH CORRECTION FACTOR												0.76	0.80	0.83	0.85	0.87	0.88

C = STANDARD V-BELT
 CX = COGGED/NOTCHED V-BELT
 + IF RIM SPEED EXCEEDS 6500 FEET PER MINUTE, CONSULT *Martin*.



Stock Drive Selection **C**

Nominal Center Distances And Arc-Length Correction Factor															Sheave Combination		Speed Ratio
C/CX Belt Length Designation															DriveR P.D.	DriveN P.D.	
90	96	105	112	120	128	144	158	173	180	210	240	300	360	420			
38.6	41.6	46.1	49.6	53.6	57.6	65.6	72.6	80.1	83.6	98.6	112.6	142.6	172.6	202.6	5.0	5.0	1.00
37.8	40.8	45.3	48.8	52.8	56.8	64.8	71.8	79.3	82.8	97.8	111.8	141.8	171.8	201.8	5.5	5.5	1.00
37.0	40.0	44.5	48.0	52.0	56.0	64.0	71.0	78.5	82.0	97.0	111.0	141.0	171.0	201.0	6.0	6.0	1.00
35.5	38.5	43.0	46.5	50.5	54.5	62.5	69.5	77.0	80.5	95.5	109.5	139.5	169.5	199.5	7.0	7.0	1.00
34.7	37.7	42.2	45.7	49.7	53.7	61.7	68.7	76.2	79.7	94.7	108.7	138.7	168.7	198.7	7.5	7.5	1.00
0.90	0.91	0.93	0.94	0.96	0.97	1.00	1.02	1.04	1.05	1.08	1.11	1.16	1.20	1.24			
33.9	36.9	41.4	44.9	48.9	52.9	60.9	67.9	75.4	78.9	93.9	107.9	137.9	167.9	197.9	8.0	8.0	1.00
33.1	36.1	40.6	44.1	48.1	52.1	60.1	67.1	74.6	78.1	93.1	107.1	137.1	167.1	197.1	8.5	8.5	1.00
32.3	35.3	39.8	43.3	47.3	51.3	59.3	66.3	73.8	77.3	92.3	106.3	136.3	166.3	196.3	9.0	9.0	1.00
31.5	34.5	39.0	42.5	46.5	50.5	58.5	65.5	73.0	76.5	91.5	105.5	135.5	165.5	195.5	9.5	9.5	1.00
30.7	33.7	38.2	41.7	45.7	49.7	57.7	64.7	72.2	75.7	90.7	104.7	134.7	164.7	194.7	10.0	10.0	1.00
0.90	0.91	0.93	0.94	0.96	0.97	1.00	1.02	1.04	1.05	1.08	1.11	1.16	1.20	1.24			
30.0	33.0	37.5	41.0	45.0	49.0	57.0	64.0	71.5	75.0	90.0	104.0	134.0	164.0	194.0	10.5	10.5	1.00
29.2	32.2	36.7	40.2	44.2	48.2	56.2	63.2	70.7	74.2	89.2	103.2	133.2	163.2	193.2	11.0	11.0	1.00
27.6	30.6	35.1	38.6	42.6	46.6	54.6	61.6	69.1	72.6	87.6	101.6	131.6	161.6	191.6	12.0	12.0	1.00
26.0	29.0	33.5	37.0	41.0	45.0	53.0	60.0	67.5	71.0	86.0	100.0	130.0	160.0	190.0	13.0	13.0	1.00
24.5	27.5	32.0	35.5	39.5	43.5	51.5	58.5	66.0	69.5	84.5	98.5	128.5	158.5	188.5	14.0	14.0	1.00
0.90	0.91	0.93	0.94	0.96	0.97	1.00	1.02	1.04	1.05	1.08	1.11	1.16	1.20	1.24			
21.3	24.3	28.8	32.3	36.3	40.3	48.3	55.3	62.8	66.3	81.3	95.3	125.3	155.3	185.3	16.0	16.0	1.00
31.1	34.1	38.6	42.1	46.1	50.1	58.1	65.1	72.6	76.1	91.1	105.1	135.1	165.1	195.1	9.5	10.0	1.05
30.3	33.3	37.8	41.3	45.3	49.3	57.3	64.3	71.8	75.3	90.3	104.3	134.3	164.3	194.3	10.0	10.5	1.05
29.6	32.6	37.1	40.6	44.6	48.6	56.6	63.6	71.1	74.6	89.6	103.6	133.6	163.6	193.6	10.5	11.0	1.05
33.5	36.5	41.0	44.5	48.5	52.5	60.5	67.5	75.0	78.5	93.5	107.5	137.5	167.5	197.5	8.0	8.5	1.06
0.89	0.91	0.93	0.94	0.96	0.97	1.00	1.02	1.04	1.05	1.08	1.11	1.16	1.20	1.24			
32.7	35.7	40.2	43.7	47.7	51.7	59.7	66.7	74.2	77.7	92.7	106.7	136.7	166.7	196.7	8.5	9.0	1.06
31.9	34.9	39.4	42.9	46.9	50.9	58.9	65.9	73.4	76.9	91.9	105.9	135.9	165.9	195.9	9.0	9.5	1.06
35.1	38.1	42.6	46.1	50.1	54.1	62.1	69.1	76.6	80.1	95.1	109.1	139.1	169.1	199.1	7.0	7.5	1.07
34.3	37.3	41.8	45.3	49.3	53.3	61.3	68.3	75.8	79.3	94.3	108.3	138.3	168.3	198.3	7.5	8.0	1.07
26.8	29.8	34.3	37.8	41.8	45.8	53.8	60.8	68.3	71.8	86.8	100.8	130.8	160.8	190.8	12.0	13.0	1.08
0.89	0.91	0.93	0.94	0.96	0.97	1.00	1.02	1.04	1.05	1.08	1.11	1.16	1.20	1.24			
25.2	28.2	32.7	36.2	40.2	44.2	52.2	59.2	66.7	70.2	85.2	99.2	129.2	159.2	189.2	13.0	14.0	1.08
37.4	40.4	44.9	48.4	52.4	56.4	64.4	71.4	78.9	82.4	97.4	111.4	141.4	171.4	201.4	5.5	6.0	1.09
28.4	31.4	35.9	39.4	43.4	47.4	55.4	62.4	69.9	73.4	88.4	102.4	132.4	162.4	192.4	11.0	12.0	1.09
38.2	41.2	45.7	49.2	53.2	57.2	65.2	72.2	79.7	83.2	98.2	112.2	142.2	172.2	202.2	5.0	5.5	1.10
30.0	33.0	37.5	41.0	45.0	49.0	57.0	64.0	71.5	75.0	90.0	104.0	134.0	164.0	194.0	10.0	11.0	1.10
0.89	0.91	0.93	0.94	0.96	0.97	1.00	1.02	1.04	1.05	1.08	1.11	1.16	1.20	1.24			
31.5	34.5	39.0	42.5	46.5	50.5	58.5	65.5	73.0	76.5	91.5	105.5	135.5	165.5	195.5	9.0	10.0	1.11
30.7	33.7	38.2	41.7	45.7	49.7	57.7	64.7	72.2	75.7	90.7	104.7	134.7	164.7	194.7	9.5	10.5	1.11
32.3	35.3	39.8	43.3	47.3	51.3	59.3	66.3	73.8	77.3	92.3	106.3	136.3	166.3	196.3	8.5	9.5	1.12
33.9	36.9	41.4	44.9	48.9	52.9	60.9	67.9	75.4	78.9	93.9	107.9	137.9	167.9	197.9	7.5	8.5	1.13
33.1	36.1	40.6	44.1	48.1	52.1	60.1	67.1	74.6	78.1	93.1	107.1	137.1	167.1	197.1	8.0	9.0	1.13
0.89	0.91	0.93	0.94	0.96	0.97	1.00	1.02	1.04	1.05	1.08	1.11	1.16	1.20	1.24			
—	22.7	27.2	30.7	34.7	38.7	46.7	53.7	61.2	64.7	79.7	93.7	123.7	153.7	183.7	16.0	18.0	1.13
24.7	37.7	42.2	45.7	49.7	53.7	61.7	68.7	76.2	79.7	94.7	108.7	138.7	168.7	198.7	7.0	8.0	1.14
28.8	31.8	36.3	39.8	43.8	47.8	55.8	62.8	70.3	73.8	88.8	102.8	132.8	162.8	192.8	10.5	12.0	1.14
22.9	25.9	30.4	33.9	37.9	41.9	49.9	56.9	64.4	67.9	82.9	96.9	126.9	156.9	186.9	14.0	16.0	1.14
30.3	33.3	37.8	41.3	45.3	49.3	57.3	64.3	71.8	75.3	90.3	104.3	134.3	164.3	194.3	9.5	11.0	1.16
0.89	0.91	0.93	0.94	0.96	0.97	1.00	1.02	1.04	1.05	1.08	1.11	1.16	1.20	1.24			
36.2	39.2	43.7	47.2	51.2	55.2	63.2	70.2	77.7	81.2	96.2	110.2	140.2	170.2	200.2	6.0	7.0	1.17
31.1	34.1	38.6	42.1	46.1	50.1	58.1	65.1	72.6	76.1	91.1	105.1	135.1	165.1	195.1	9.0	10.5	1.17
26.0	29.0	33.5	37.0	41.0	45.0	53.0	60.0	67.5	71.0	86.0	100.0	130.0	160.0	190.0	12.0	14.0	1.17
31.9	34.9	39.4	42.9	46.9	50.9	58.9	65.9	73.4	76.9	91.9	105.9	135.9	165.9	195.9	8.5	10.0	1.18
27.6	30.6	35.1	38.6	42.6	46.6	54.6	61.6	69.1	72.6	87.6	101.6	131.6	161.6	191.6	11.0	13.0	1.18
0.90	0.91	0.93	0.94	0.96	0.97	1.00	1.02	1.04	1.05	1.08	1.11	1.16	1.20	1.24			
32.7	35.7	40.2	43.7	47.7	51.7	59.7	66.7	74.2	77.7	92.7	106.7	136.7	166.7	196.7	8.0	9.5	1.19
37.8	40.8	45.3	48.8	52.8	56.8	64.8	71.8	79.3	82.8	97.8	111.8	141.8	171.8	201.8	5.0	6.0	1.20
33.5	36.5	41.0	44.5	48.5	52.5	60.5	67.5	75.0	78.5	93.5	107.5	137.5	167.5	197.5	7.5	9.0	1.20
29.2	32.2	36.7	40.2	44.2	48.2	56.2	63.2	70.7	74.2	89.2	103.2	133.2	163.2	193.2	10.0	12.0	1.20
34.3	37.3	41.8	45.3	49.3	53.3	61.3	68.3	75.8	79.3	94.3	108.3	138.3	168.3	198.3	7.0	8.5	1.21
0.90	0.91	0.93	0.94	0.96	0.97	1.00	1.02	1.04	1.05	1.08	1.11	1.16	1.20	1.24			

FOR BELT SIZES NOT SHOWN, INTERPOLATE FOR ADDITIONAL CENTER DISTANCE.

V-BELT DRIVES

C Stock Drive Selection



V-BELT DRIVES

Speed Ratio	Sheave Combination		DriveN Speeds and HP Per Belt									Nominal Center Distance And Arc-Length Correction Factors					
			1750 RPM DriveR			1160 RPM DriveR			870 RPM DriveR			C/CX Belt Length Designation					
	DriveR P.D.	DriveN P.D.	DriveN RPM	HP Per Belt C	HP Per Belt CX	DriveN RPM	HP Per Belt C	HP Per Belt CX	DriveN RPM	HP Per Belt C	HP Per Belt CX	51	60	68	75	81	85
1.22	9.0	11.0	1432	19.52	24.43	949	15.36	18.33	712	12.48	14.61	—	15.7	19.7	23.2	26.2	28.2
1.23	13.0	16.0	1422	30.78	37.28	943	25.76	29.30	707	21.18	23.61	—	—	—	—	19.1	21.1
1.24	8.5	10.5	1417	17.83	22.60	939	13.99	16.90	704	11.37	13.46	12.0	16.5	20.5	24.0	27.0	29.0
1.24	10.5	13.0	1413	24.42	29.81	937	19.52	22.66	703	15.88	18.10	—	—	16.9	20.5	23.5	25.5
1.25	6.0	7.5	1400	8.05	12.28	928	6.52	9.21	696	5.41	7.39	16.3	20.8	24.8	28.3	31.3	33.3
ARC-LENGTH CORRECTION FACTOR												0.76	0.80	0.82	0.85	0.87	0.88
1.25	8.0	10.0	1400	16.03	20.67	928	12.56	15.42	696	10.22	12.28	12.8	17.3	21.3	24.8	27.8	29.8
1.25	16.0	20.0	+	+	+	928	32.29	36.46	696	27.09	29.82	—	—	—	—	—	—
1.26	9.5	12.0	1385	21.34	26.38	918	16.85	19.86	689	13.68	15.83	—	—	18.5	22.0	25.0	27.0
1.27	5.5	7.0	1375	5.96	10.10	911	4.98	7.63	684	4.21	6.16	17.1	21.6	25.6	29.1	32.1	34.1
1.27	7.5	9.5	1382	14.20	18.70	916	11.13	13.93	687	9.07	11.11	13.6	18.1	22.1	25.6	28.6	30.6
ARC-LENGTH CORRECTION FACTOR												0.76	0.80	0.82	0.85	0.86	0.88
1.27	11.0	14.0	1375	25.97	31.53	911	20.89	24.09	684	17.02	19.27	—	—	—	19.3	22.3	24.3
1.29	7.0	9.0	1361	12.29	16.68	902	9.67	12.42	677	7.90	9.91	14.3	18.9	22.9	26.4	29.4	31.4
1.29	8.5	11.0	1352	17.98	22.72	896	14.09	16.98	672	11.44	13.53	—	16.1	20.1	23.6	26.6	28.6
1.29	14.0	18.0	1361	32.89	39.90	902	28.18	31.88	677	23.30	25.80	—	—	—	—	—	—
1.30	10.0	13.0	1346	23.06	28.25	892	18.29	21.35	669	14.86	17.04	—	—	17.3	20.8	23.8	25.8
ARC-LENGTH CORRECTION FACTOR												0.76	0.80	0.83	0.85	0.87	0.88
1.31	8.0	10.5	1333	16.20	20.81	884	12.68	15.51	663	10.30	12.35	12.4	16.9	20.9	24.4	27.4	29.4
1.33	6.0	8.0	1313	8.27	12.46	870	6.66	9.33	653	5.52	7.48	15.9	20.4	24.4	27.9	30.9	32.9
1.33	7.5	10.0	1313	14.35	18.83	870	11.23	14.02	653	9.15	11.17	13.1	17.7	21.7	25.2	28.2	30.2
1.33	9.0	12.0	1313	19.84	24.70	870	15.58	18.51	653	12.64	14.74	—	—	18.9	22.4	25.4	27.4
1.33	10.5	14.0	1313	24.67	30.02	870	19.68	22.79	653	16.01	18.21	—	—	—	19.6	22.6	24.6
ARC-LENGTH CORRECTION FACTOR												0.75	0.79	0.82	0.86	0.86	0.87
1.33	12.0	16.0	1313	28.77	34.74	870	23.53	26.86	653	19.24	21.56	—	—	—	—	19.9	21.9
1.36	5.5	7.5	1283	6.18	10.28	851	5.13	7.75	638	4.31	6.25	16.7	21.2	25.2	28.7	31.7	33.7
1.36	7.0	9.5	1289	12.45	16.81	855	9.78	12.51	641	7.98	9.98	13.9	18.4	22.5	26.0	29.0	31.0
1.37	9.5	13.0	1279	21.61	26.61	848	17.03	20.00	636	13.82	15.94	—	—	17.7	21.2	24.2	26.2
1.38	8.0	11.0	1273	16.35	20.93	844	12.77	15.59	633	10.37	12.41	11.9	16.5	20.5	24.0	27.0	29.0
ARC-LENGTH CORRECTION FACTOR												0.76	0.80	0.83	0.85	0.87	0.88
1.38	13.0	18.0	1264	31.17	37.60	838	26.02	29.51	628	21.37	23.77	—	—	—	—	—	—
1.40	5.0	7.0	1250	4.04	8.06	829	3.57	6.16	621	3.10	5.00	17.5	22.0	26.0	29.5	32.5	34.5
1.40	7.5	10.5	1250	14.48	18.94	829	11.32	14.09	621	9.21	11.22	12.7	17.2	21.3	24.8	27.8	29.8
1.40	10.0	14.0	1250	23.27	28.42	829	18.43	21.46	621	14.96	17.12	—	—	16.5	20.0	23.0	25.0
1.41	8.5	12.0	1240	18.23	22.93	822	14.25	17.12	616	11.56	13.63	—	—	15.2	19.3	22.8	25.8
ARC-LENGTH CORRECTION FACTOR												0.76	0.80	0.83	0.85	0.87	0.88
1.42	6.0	8.5	1235	8.43	12.59	819	6.77	9.42	614	5.60	7.55	15.5	20.0	24.0	27.5	30.5	32.5
1.43	7.0	10.0	1225	12.57	16.91	812	9.85	12.57	609	8.04	10.03	13.5	18.0	22.0	25.6	28.6	30.6
1.43	14.0	20.0	1225	33.16	40.13	812	28.36	32.04	609	23.43	25.92	—	—	—	—	—	—
1.44	9.0	13.0	1212	20.03	24.86	803	15.70	18.61	602	12.74	14.82	—	—	18.1	21.6	24.6	26.6
1.45	5.5	8.0	1203	6.32	10.40	798	5.22	7.83	598	4.39	6.31	16.3	20.8	24.8	28.3	31.3	33.3
ARC-LENGTH CORRECTION FACTOR												0.76	0.79	0.82	0.85	0.86	0.87
1.45	11.0	16.0	1203	26.33	31.83	798	21.13	24.29	598	17.20	19.42	—	—	—	—	20.6	22.6
1.47	7.5	11.0	1193	14.58	19.02	791	11.39	14.14	593	9.26	11.27	12.3	16.8	20.8	24.4	27.4	29.4
1.47	9.5	14.0	1188	21.76	26.73	787	17.13	20.09	590	13.89	16.01	—	—	16.8	20.4	23.4	25.4
1.50	5.0	7.5	1167	4.17	8.17	773	3.66	6.23	580	3.16	5.06	17.1	21.6	25.6	29.1	32.1	34.1
1.50	6.0	9.0	1167	8.53	12.68	773	6.84	9.47	580	5.65	7.59	15.1	19.6	23.6	27.1	30.1	32.1
ARC-LENGTH CORRECTION FACTOR												0.74	0.79	0.82	0.84	0.86	0.87
1.50	7.0	10.5	1167	12.65	16.98	773	9.91	12.62	580	8.08	10.06	13.1	17.6	21.6	25.1	28.2	30.2
1.50	8.0	12.0	1167	16.51	21.07	773	12.88	15.68	580	10.46	12.48	—	15.6	19.6	23.2	26.2	28.2
1.50	12.0	18.0	1167	29.04	34.96	773	23.71	27.01	580	19.37	21.67	—	—	—	—	—	20.2
1.50	16.0	24.0	+	+	+	773	32.61	36.72	580	27.33	30.02	—	—	—	—	—	—
1.52	10.5	16.0	1148	24.95	30.26	761	19.87	22.95	571	16.15	18.32	—	—	—	17.9	21.0	23.0
ARC-LENGTH CORRECTION FACTOR												0.74	0.79	0.82	0.84	0.86	0.87
1.53	8.5	13.0	1144	18.37	23.05	758	14.35	17.20	569	11.64	13.69	—	—	18.4	21.9	25.0	27.0
1.54	13.0	20.0	1138	31.37	37.77	754	26.15	29.62	566	21.47	23.85	—	—	—	—	—	—
1.55	5.5	8.5	1132	6.43	10.49	751	5.29	7.89	563	4.44	6.35	15.9	20.4	24.4	27.9	30.9	32.9
1.56	9.0	14.0	1125	20.16	24.97	746	15.79	18.69	559	12.80	14.88	—	—	17.2	20.7	23.8	25.8
1.57	7.0	11.0	1114	12.72	17.04	738	9.95	12.66	554	8.12	10.09	12.7	17.2	21.2	24.7	27.7	29.7
ARC-LENGTH CORRECTION FACTOR												0.75	0.79	0.82	0.84	0.86	0.87

C = STANDARD V-BELT
 CX = COGGED/NOTCHED V-BELT
 + IF RIM SPEED EXCEEDS 6500 FEET PER MINUTE, CONSULT *Martin*.



Stock Drive Selection C

Nominal Center Distances And Arc-Length Correction Factor														Sheave Combination		Speed Ratio	
C/CX Belt Length Designation														DriveR P.D.	DriveN P.D.		
90	96	105	112	120	128	144	158	173	180	210	240	300	360	420			
30.7	33.7	38.2	41.7	45.7	49.7	57.7	64.7	72.2	75.7	90.7	104.7	134.7	164.7	194.7	9.0	11.0	1.22
23.6	26.6	31.1	34.6	38.6	42.6	50.7	57.7	65.2	68.7	83.7	97.7	127.7	157.7	187.7	13.0	16.0	1.23
31.5	34.5	39.0	42.5	46.5	50.5	58.5	65.5	73.0	76.5	91.5	105.5	135.5	165.5	195.5	8.5	10.5	1.24
28.0	31.0	35.5	39.0	43.0	47.0	55.0	62.0	69.5	73.0	88.0	102.0	132.0	162.0	192.0	10.5	13.0	1.24
35.8	38.8	43.3	46.8	50.8	54.8	62.8	69.8	77.3	80.8	95.8	109.8	139.8	169.8	199.8	6.0	7.5	1.25
0.89	0.90	0.92	0.94	0.95	0.97	1.00	1.02	1.04	1.05	1.08	1.11	1.16	1.20	1.24			
32.3	35.3	39.8	43.3	47.3	51.3	59.3	66.3	73.8	77.3	92.3	106.3	136.3	166.3	196.3	8.0	10.0	1.25
—	—	25.6	29.1	33.1	37.1	45.1	52.1	59.6	63.1	78.2	92.2	122.2	152.2	182.2	16.0	20.0	1.25
29.5	32.5	37.0	40.5	44.5	48.5	56.6	63.6	71.1	74.6	89.6	103.6	133.6	163.6	193.6	9.5	12.0	1.26
36.6	39.6	44.1	47.6	51.6	55.6	63.6	70.6	78.1	81.6	96.6	110.6	140.6	170.6	200.6	5.5	7.0	1.27
33.1	36.1	40.6	44.1	48.1	52.1	60.1	67.1	74.6	78.1	93.1	107.1	137.1	167.1	197.1	7.5	9.5	1.27
0.89	0.90	0.92	0.94	0.95	0.97	1.00	1.02	1.04	1.05	1.08	1.11	1.16	1.20	1.24			
26.8	29.8	34.3	37.8	41.8	45.8	53.8	60.8	68.3	71.8	86.8	100.8	130.8	160.8	190.8	11.0	14.0	1.27
33.9	36.9	41.4	44.9	48.9	52.9	60.9	67.9	75.4	78.9	93.9	107.9	137.9	167.9	197.9	7.0	9.0	1.29
31.1	34.1	38.6	42.1	46.1	50.1	58.1	65.1	72.6	76.1	91.1	105.1	135.1	165.1	195.1	8.5	11.0	1.29
21.2	24.2	28.7	32.3	36.3	40.3	48.3	55.3	62.8	66.3	81.3	95.3	125.3	155.3	185.3	14.0	18.0	1.29
28.3	31.3	35.9	39.4	43.4	47.4	55.4	62.4	69.9	73.4	88.4	102.4	132.4	162.4	192.4	10.0	13.0	1.30
0.89	0.90	0.92	0.94	0.95	0.97	1.00	1.02	1.04	1.05	1.08	1.11	1.16	1.20	1.24			
31.9	34.9	39.4	42.9	46.9	50.9	58.9	65.9	73.4	76.9	91.9	105.9	135.9	165.9	195.9	8.0	10.5	1.31
35.4	38.4	42.9	46.4	50.4	54.4	62.4	69.4	76.9	80.4	95.4	109.4	139.4	169.4	199.4	6.0	8.0	1.33
32.7	35.7	40.2	43.7	47.7	51.7	59.7	66.7	74.2	77.7	92.7	106.7	136.7	166.7	196.7	7.5	10.0	1.33
29.9	32.9	37.4	40.9	44.9	48.9	56.9	63.9	71.4	74.9	89.9	103.9	133.9	163.9	193.9	9.0	12.0	1.33
27.2	30.2	34.7	38.2	42.2	46.2	54.2	61.2	68.7	72.2	87.2	101.2	131.2	161.2	191.2	10.5	14.0	1.33
0.89	0.90	0.92	0.94	0.95	0.97	1.00	1.02	1.04	1.05	1.08	1.11	1.16	1.20	1.24			
24.4	27.4	31.9	35.4	39.4	43.4	51.4	58.4	65.9	69.4	84.4	98.4	128.4	158.4	188.4	12.0	16.0	1.33
36.2	39.2	43.7	47.2	51.2	55.2	63.2	70.2	77.7	81.2	96.2	110.2	140.2	170.2	200.2	5.5	7.5	1.36
33.5	36.5	41.0	44.5	48.5	52.5	60.5	67.5	75.0	78.5	93.5	107.5	137.5	167.5	197.5	7.0	9.5	1.36
28.7	31.7	36.2	39.7	43.7	47.7	55.7	62.7	70.2	73.7	88.7	102.7	132.7	162.7	192.7	9.5	13.0	1.37
31.5	34.5	39.0	42.5	46.5	50.5	58.5	65.5	73.0	76.5	91.5	105.5	135.5	165.5	195.5	8.0	11.0	1.38
0.89	0.90	0.92	0.94	0.95	0.97	1.00	1.02	1.04	1.05	1.08	1.11	1.16	1.20	1.24			
22.0	25.0	29.5	33.0	37.0	41.0	49.0	56.0	63.6	67.1	82.1	96.1	126.1	156.1	186.1	13.0	18.0	1.38
37.0	40.0	44.5	48.0	52.0	56.0	64.0	71.0	78.5	82.0	97.0	111.0	141.0	171.0	201.0	5.0	7.0	1.40
32.3	35.3	39.8	43.3	47.3	51.3	59.3	66.3	73.8	77.3	92.3	106.3	136.3	166.3	196.3	7.5	10.5	1.40
27.5	30.5	35.0	38.5	42.6	46.6	54.6	61.6	69.1	72.6	87.6	101.6	131.6	161.6	191.6	10.0	14.0	1.40
30.3	33.3	37.8	41.3	45.3	49.3	57.3	64.3	71.8	75.3	90.3	104.3	134.3	164.3	194.3	8.5	12.0	1.41
0.89	0.90	0.92	0.94	0.95	0.97	1.00	1.02	1.04	1.05	1.08	1.11	1.16	1.20	1.24			
35.0	38.0	42.5	46.0	50.0	54.0	62.0	69.1	76.6	80.1	95.1	109.1	139.1	169.1	199.1	6.0	8.5	1.42
33.1	36.1	40.6	44.1	48.1	52.1	60.1	67.1	74.6	78.1	93.1	107.1	137.1	167.1	197.1	7.0	10.0	1.43
—	22.5	27.1	30.6	34.6	38.6	46.6	53.6	61.2	64.7	79.7	93.7	123.7	153.7	183.7	14.0	20.0	1.43
29.1	32.1	36.6	40.1	44.1	48.1	56.1	63.1	70.6	74.1	89.1	103.2	133.2	163.2	193.2	9.0	13.0	1.44
35.8	38.8	43.3	46.8	50.8	54.8	62.8	69.8	77.3	80.8	95.8	109.8	139.8	169.8	199.8	5.5	8.0	1.45
0.89	0.90	0.92	0.94	0.95	0.97	1.00	1.02	1.04	1.05	1.08	1.11	1.16	1.20	1.24			
25.1	28.1	32.6	36.2	40.2	44.2	52.2	59.2	66.7	70.2	85.2	99.2	129.2	159.2	189.2	11.0	16.0	1.45
31.9	34.9	39.4	42.9	46.9	50.9	58.9	65.9	73.4	76.9	91.9	105.9	135.9	165.9	195.9	7.5	11.0	1.47
27.9	30.9	35.4	38.9	42.9	46.9	54.9	62.0	69.5	73.0	88.0	102.0	132.0	162.0	192.0	9.5	14.0	1.47
36.6	39.6	44.1	47.6	51.6	55.6	63.6	70.6	78.1	81.6	96.6	110.6	140.6	170.6	200.6	5.0	7.5	1.50
34.6	37.6	42.1	45.6	49.6	53.6	61.7	68.7	76.2	79.7	94.7	108.7	138.7	168.7	198.7	6.0	9.0	1.50
0.88	0.90	0.92	0.93	0.95	0.97	0.99	1.01	1.03	1.04	1.08	1.11	1.16	1.20	1.24			
32.7	35.7	40.2	43.7	47.7	51.7	59.7	66.7	74.2	77.7	92.7	106.7	136.7	166.7	196.7	7.0	10.5	1.50
30.7	33.7	38.2	41.7	45.7	49.7	57.7	64.7	72.2	75.7	90.7	104.7	134.7	164.7	194.7	8.0	12.0	1.50
22.7	25.7	30.2	33.8	37.8	41.8	49.8	56.8	64.3	67.8	82.8	96.8	126.8	156.8	186.8	12.0	18.0	1.50
—	—	—	25.7	29.8	33.8	41.8	48.9	56.4	59.9	74.9	88.9	119.0	149.0	179.0	16.0	24.0	1.50
25.5	28.5	33.0	36.5	40.5	44.6	52.6	59.6	67.1	70.6	85.6	99.6	129.6	159.6	189.6	10.5	16.0	1.52
0.88	0.90	0.92	0.93	0.95	0.97	0.99	1.01	1.03	1.04	1.08	1.11	1.16	1.20	1.24			
29.5	32.5	37.0	40.5	44.5	48.5	56.5	63.5	71.0	74.5	89.5	103.5	133.5	163.5	193.5	8.5	13.0	1.53
—	23.3	27.8	31.3	35.4	39.4	47.4	54.4	61.9	65.4	80.5	94.5	124.5	154.5	184.5	13.0	20.0	1.54
35.4	38.4	42.9	46.4	50.4	54.4	62.4	69.4	76.9	80.4	95.4	109.4	139.4	169.4	199.4	5.5	8.5	1.55
28.3	31.3	35.8	39.3	43.3	47.3	55.3	62.3	69.8	73.3	88.4	102.4	132.4	162.4	192.4	9.0	14.0	1.56
32.3	35.3	39.8	43.3	47.3	51.3	59.3	66.3	73.8	77.3	92.3	106.3	136.3	166.3	196.3	7.0	11.0	1.57
0.88	0.90	0.92	0.94	0.95	0.97	0.99	1.02	1.04	1.04	1.08	1.11	1.16	1.20	1.24			

FOR BELT SIZES NOT SHOWN, INTERPOLATE FOR ADDITIONAL CENTER DISTANCE.

V-BELT DRIVES

C Stock Drive Selection

V-BELT DRIVES

Speed Ratio	Sheave Combination		DriveN Speeds and HP Per Belt									Nominal Center Distance And Arc-Length Correction Factors					
			1750 RPM DriveR			1160 RPM DriveR			870 RPM DriveR			C/CX Belt Length Designation					
	DriveR P.D.	DriveN P.D.	DriveN RPM	HP Per Belt C	HP Per Belt CX	DriveN RPM	HP Per Belt C	HP Per Belt CX	DriveN RPM	HP Per Belt C	HP Per Belt CX	51	60	68	75	81	85
1.58	6.0	9.5	1105	8.61	12.74	733	6.89	9.51	549	5.69	7.62	14.7	19.2	23.2	26.7	29.7	31.7
1.60	5.0	8.0	1094	4.26	8.24	725	3.72	6.28	544	3.21	5.10	16.7	21.2	25.2	28.7	31.7	33.7
1.60	7.5	12.0	1094	14.70	19.13	725	11.47	14.21	544	9.32	11.32	—	16.0	20.0	23.5	26.5	28.5
1.60	10.0	16.0	1094	23.49	28.61	725	18.57	21.58	544	15.07	17.21	—	—	—	18.3	21.3	23.3
1.63	8.0	13.0	1077	16.62	21.16	714	12.96	15.74	535	10.51	12.53	—	—	18.8	22.3	25.3	27.3
ARC-LENGTH CORRECTION FACTOR												0.75	0.79	0.82	0.84	0.86	0.87
1.64	5.5	9.0	1069	6.50	10.55	709	5.34	7.93	532	4.47	6.38	15.5	20.0	24.0	27.5	30.5	32.5
1.64	11.0	18.0	1069	26.50	31.98	709	21.25	24.39	532	17.29	19.49	—	—	—	—	—	20.9
1.65	8.5	14.0	1063	18.47	23.13	704	14.41	17.25	528	11.68	13.73	—	—	17.6	21.1	24.1	26.1
1.67	6.0	10.0	1050	8.67	12.79	696	6.93	9.55	522	5.72	7.64	14.2	18.8	22.8	26.3	29.3	31.3
1.67	12.0	20.0	1050	29.17	35.07	696	23.80	27.09	522	19.44	21.72	—	—	—	—	—	—
ARC-LENGTH CORRECTION FACTOR												0.75	0.79	0.82	0.84	0.86	0.87
1.68	9.5	16.0	1039	21.93	26.87	689	17.24	20.18	517	13.98	16.08	—	—	—	18.6	21.7	23.7
1.69	16.0	27.0	+	+	+	687	32.71	36.80	516	27.40	30.08	—	—	—	—	—	—
1.70	5.0	8.5	1029	4.32	8.29	682	3.76	6.32	512	3.24	5.12	16.3	20.8	24.8	28.3	31.3	33.3
1.71	7.0	12.0	1021	12.81	17.11	677	10.01	12.71	508	8.16	10.13	—	16.3	20.4	23.9	26.9	28.9
1.71	10.5	18.0	1021	25.09	30.37	677	19.96	23.03	508	16.21	18.38	—	—	—	—	19.2	21.2
ARC-LENGTH CORRECTION FACTOR												0.75	0.79	0.82	0.84	0.86	0.87
1.71	14.0	24.0	1021	33.40	40.33	677	28.52	32.17	508	23.55	26.02	—	—	—	—	—	—
1.73	5.5	9.5	1013	6.55	10.59	672	5.37	7.95	504	4.50	6.40	15.0	19.6	23.6	27.1	30.1	32.1
1.73	7.5	13.0	1010	14.78	19.19	669	11.52	14.25	502	9.36	11.35	—	15.1	19.2	22.7	25.7	27.7
1.75	6.0	10.5	1000	8.71	12.82	663	6.95	9.57	497	5.74	7.66	13.8	18.4	22.4	25.9	28.9	30.9
1.75	8.0	14.0	1000	16.69	21.21	663	13.00	15.78	497	10.54	12.56	—	—	17.9	21.5	24.5	26.5
ARC-LENGTH CORRECTION FACTOR												0.75	0.79	0.82	0.84	0.86	0.87
1.78	9.0	16.0	984	20.29	25.08	653	15.88	18.76	489	12.86	14.93	—	—	—	19.0	22.0	24.1
1.80	5.0	9.0	972	4.37	8.33	644	3.79	6.34	483	3.26	5.14	15.8	20.4	24.4	27.9	30.9	32.9
1.80	10.0	18.0	972	23.60	28.69	644	18.64	21.64	483	15.13	17.26	—	—	—	—	19.5	21.6
1.82	5.5	10.0	963	6.59	10.62	638	5.40	7.98	479	4.52	6.41	14.6	19.1	23.2	26.7	29.7	31.7
1.82	11.0	20.0	963	26.59	32.05	638	21.30	24.43	479	17.33	19.53	—	—	—	—	—	—
ARC-LENGTH CORRECTION FACTOR												0.75	0.79	0.82	0.84	0.86	0.87
1.83	6.0	11.0	955	8.74	12.85	633	6.97	9.59	475	5.76	7.67	13.4	17.9	22.0	25.5	28.5	30.5
1.85	13.0	24.0	948	31.54	37.91	628	26.27	29.72	471	21.56	23.92	—	—	—	—	—	—
1.86	7.0	13.0	942	12.87	17.16	625	10.05	12.74	468	8.19	10.15	—	15.5	19.5	23.0	26.1	28.1
1.87	7.5	14.0	938	14.83	19.23	621	11.55	14.28	466	9.39	11.37	—	—	18.3	21.8	24.9	26.9
1.88	8.5	16.0	930	18.57	23.21	616	14.48	17.30	462	11.73	13.77	—	—	—	19.3	22.4	24.4
ARC-LENGTH CORRECTION FACTOR												0.73	0.78	0.81	0.83	0.85	0.86
1.88	16.0	30.0	+	+	+	619	32.76	36.84	464	27.44	30.11	—	—	—	—	—	—
1.89	9.5	18.0	924	22.01	26.95	612	17.30	20.23	459	14.02	16.11	—	—	—	—	19.9	21.9
1.90	5.0	9.5	921	4.40	8.36	611	3.81	6.36	458	3.27	5.15	15.4	19.9	24.0	27.5	30.5	32.5
1.90	10.5	20.0	919	25.16	30.43	609	20.01	23.07	457	16.25	18.41	—	—	—	—	—	—
1.91	5.5	10.5	917	6.61	10.64	608	5.41	7.99	456	4.53	6.43	14.2	18.7	22.7	26.3	29.3	31.3
ARC-LENGTH CORRECTION FACTOR												0.74	0.78	0.81	0.84	0.86	0.87
1.93	14.0	27.0	907	33.48	40.40	601	28.58	32.21	451	23.59	26.05	—	—	—	—	—	—
2.00	5.0	10.0	875	4.43	8.38	580	3.83	6.37	435	3.29	5.16	15.0	19.5	23.5	27.1	30.1	32.1
2.00	5.5	11.0	875	6.64	10.66	580	5.43	8.00	435	4.54	6.44	13.7	18.3	22.3	25.8	28.9	30.9
2.00	6.0	12.0	875	8.79	12.89	580	7.00	9.61	435	5.78	7.69	12.5	17.0	21.1	24.6	27.7	29.7
2.00	7.0	14.0	875	12.90	17.19	580	10.08	12.76	435	8.21	10.17	—	—	18.6	22.2	25.2	27.2
ARC-LENGTH CORRECTION FACTOR												0.74	0.78	0.81	0.84	0.85	0.87
2.00	8.0	16.0	875	16.77	21.28	580	13.05	15.82	435	10.58	12.59	—	—	—	19.7	22.7	24.8
2.00	9.0	18.0	875	20.36	25.13	580	15.92	18.79	435	12.90	14.96	—	—	—	—	20.2	22.3
2.00	10.0	20.0	875	23.65	28.74	580	18.68	21.67	435	15.16	17.28	—	—	—	—	—	19.8
2.00	12.0	24.0	875	29.29	35.17	580	23.88	27.15	435	19.50	21.77	—	—	—	—	—	—
2.08	13.0	27.0	843	31.60	37.96	559	26.30	27.95	419	21.59	23.95	—	—	—	—	—	—
ARC-LENGTH CORRECTION FACTOR												0.0	0.0	0.0	0.81	0.83	0.84
2.10	5.0	10.5	833	4.44	8.39	552	3.84	6.38	414	3.30	5.17	14.5	19.1	23.1	26.6	29.6	31.7
2.11	9.5	20.0	831	22.06	26.99	551	17.33	20.26	413	14.04	16.13	—	—	—	—	—	20.1
2.12	8.5	18.0	826	18.62	23.25	548	14.51	17.33	411	11.76	13.79	—	—	—	—	20.6	22.6
2.13	7.5	16.0	820	14.89	19.28	544	11.59	14.32	408	9.42	11.39	—	—	16.4	20.0	23.1	25.1
2.14	14.0	30.0	817	33.53	40.43	541	28.61	32.24	406	23.61	26.07	—	—	—	—	—	—
ARC-LENGTH CORRECTION FACTOR												0.0	0.0	0.0	0.81	0.83	0.84

C = STANDARD V-BELT
 CX = COGGED/NOTCHED V-BELT
 + IF RIM SPEED EXCEEDS 6500 FEET PER MINUTE, CONSULT *Martin*.



Stock Drive Selection C

Nominal Center Distances And Arc-Length Correction Factor															Sheave Combination		Speed Ratio
C/CX Belt Length Designation															DriveR P.D.	DriveN P.D.	
90	96	105	112	120	128	144	158	173	180	210	240	300	360	420			
34.2	37.2	41.7	45.2	49.2	53.2	61.3	68.3	75.8	79.3	94.3	108.3	138.3	168.3	198.3	6.0	9.5	1.58
36.2	39.2	43.7	47.2	51.2	55.2	63.2	70.2	77.7	81.2	96.2	110.2	140.2	170.2	200.2	5.0	8.0	1.60
31.1	34.1	38.6	42.1	46.1	50.1	58.1	65.1	72.6	76.1	91.1	105.1	135.1	165.1	195.1	7.5	12.0	1.60
25.9	28.9	33.4	36.9	40.9	44.9	52.9	60.0	67.5	71.0	86.0	100.0	130.0	160.0	190.0	10.0	16.0	1.60
29.9	32.9	37.4	40.9	44.9	48.9	56.9	63.9	71.4	74.9	89.9	103.9	133.9	163.9	193.9	8.0	13.0	1.63
0.88	0.90	0.92	0.93	0.95	0.97	0.99	1.01	1.03	1.04	1.08	1.11	1.16	1.20	1.24			
35.0	38.0	42.5	46.0	50.0	54.0	62.0	69.0	76.5	80.0	95.0	109.0	139.1	169.1	199.1	5.5	9.0	1.64
23.4	26.4	31.0	34.5	38.5	42.5	50.6	57.6	65.1	68.6	83.6	97.6	127.6	157.6	187.6	11.0	18.0	1.64
28.6	31.7	36.2	39.7	43.7	47.7	55.7	62.7	70.2	73.7	88.7	102.7	132.7	162.8	192.8	8.5	14.0	1.65
33.8	36.8	41.3	44.8	48.8	52.8	60.9	67.9	75.4	78.9	93.9	107.9	137.9	167.9	197.9	6.0	10.0	1.67
20.9	24.0	28.5	32.1	36.1	40.1	48.2	55.2	62.7	66.2	81.2	95.2	125.3	155.3	185.3	12.0	20.0	1.67
0.88	0.90	0.92	0.94	0.95	0.97	0.99	1.01	1.03	1.04	1.08	1.11	1.16	1.20	1.24			
26.2	29.2	33.8	37.3	41.3	45.3	53.3	60.3	67.8	71.3	86.4	100.4	130.4	160.4	190.4	9.5	16.0	1.68
—	—	—	—	27.1	31.2	39.3	46.4	53.9	57.4	72.5	86.5	116.5	146.6	176.6	16.0	27.0	1.69
35.8	38.8	43.3	46.8	50.8	54.8	62.8	69.8	77.3	80.8	95.8	109.8	139.8	169.8	199.8	5.0	8.5	1.70
31.4	34.4	38.9	42.5	46.5	50.5	58.5	65.5	73.0	76.5	91.5	105.5	135.5	165.5	195.5	7.0	12.0	1.71
23.8	26.8	31.3	34.9	38.9	42.9	50.9	57.9	65.5	69.0	84.0	98.0	128.0	158.0	188.0	10.5	18.0	1.71
0.88	0.90	0.92	0.94	0.95	0.97	0.99	1.01	1.03	1.04	1.08	1.11	1.16	1.20	1.24			
—	—	23.6	27.1	31.2	35.3	43.3	50.4	57.9	61.4	76.4	90.5	120.5	150.5	180.5	14.0	24.0	1.71
34.6	37.6	42.1	45.6	49.6	53.6	61.6	68.6	76.1	79.6	94.6	108.7	138.7	168.7	198.7	5.5	9.5	1.73
30.2	33.2	37.7	41.3	45.3	49.3	57.3	64.3	71.8	75.3	90.3	104.3	134.3	164.3	194.3	7.5	13.0	1.73
33.4	36.4	40.9	44.4	48.4	52.4	60.4	67.5	75.0	78.5	93.5	107.5	137.5	167.5	197.5	6.0	10.5	1.75
29.0	32.0	36.5	40.1	44.1	48.1	56.1	63.1	70.6	74.1	89.1	103.1	133.1	163.1	193.1	8.0	14.0	1.75
0.88	0.90	0.92	0.93	0.95	0.96	0.99	1.01	1.03	1.04	1.08	1.11	1.16	1.20	1.24			
26.6	29.6	34.1	37.7	41.7	45.7	53.7	60.7	68.2	71.7	86.7	100.8	130.8	160.8	190.8	9.0	16.0	1.78
35.4	38.4	42.9	46.4	50.4	54.4	62.4	69.4	76.9	80.4	95.4	109.4	139.4	169.4	199.4	5.0	9.0	1.80
24.1	27.2	31.7	35.2	39.3	43.3	51.3	58.3	65.8	69.3	84.4	98.4	128.4	158.4	188.4	10.0	18.0	1.80
34.2	37.2	41.7	45.2	49.2	53.2	61.2	68.2	75.7	79.2	94.2	108.3	138.3	168.3	198.3	5.5	10.0	1.82
21.6	24.7	29.3	32.8	36.8	40.9	48.9	55.9	63.4	67.0	82.0	96.0	126.0	156.0	186.0	11.0	20.0	1.82
0.88	0.90	0.92	0.93	0.95	0.96	0.99	1.01	1.03	1.04	1.08	1.11	1.16	1.20	1.24			
33.0	36.0	40.5	44.0	48.0	52.0	60.0	67.1	74.6	78.1	93.1	107.1	137.1	167.1	197.1	6.0	11.0	1.83
—	—	24.3	27.8	31.9	36.0	44.0	51.1	58.6	62.1	77.2	91.2	121.3	151.3	181.3	13.0	24.0	1.85
30.6	33.6	38.1	41.6	45.6	49.7	57.7	64.7	72.2	75.7	90.7	104.7	134.7	164.7	194.7	7.0	13.0	1.86
29.4	32.4	36.9	40.4	44.4	48.5	56.5	63.5	71.0	74.5	89.5	103.5	133.5	163.5	193.5	7.5	14.0	1.87
26.9	30.0	34.5	38.0	42.0	46.1	54.1	61.1	68.6	72.1	87.1	101.1	131.2	161.2	191.2	8.5	16.0	1.88
0.88	0.90	0.92	0.93	0.95	0.96	0.99	1.01	1.03	1.04	1.08	1.11	1.16	1.20	1.23			
—	—	—	—	—	28.5	36.7	43.8	51.3	54.9	70.0	84.0	114.1	144.2	174.2	16.0	30.0	1.88
24.5	27.5	32.1	35.6	39.6	43.6	51.7	58.7	66.2	69.7	84.7	98.8	128.8	158.8	188.8	9.5	18.0	1.89
35.0	38.0	42.5	46.0	50.0	54.0	62.0	69.0	76.5	80.0	95.0	109.0	139.0	169.0	199.0	5.0	9.5	1.90
22.0	25.0	29.6	33.2	37.2	41.2	49.3	56.3	63.8	67.3	82.4	96.4	126.4	156.4	186.4	10.5	20.0	1.90
33.8	36.8	41.3	44.8	48.8	52.8	60.8	67.8	75.3	78.8	93.9	107.9	137.9	167.9	197.9	5.5	10.5	1.91
0.88	0.90	0.92	0.93	0.95	0.96	0.99	1.01	1.03	1.04	1.08	1.11	1.16	1.20	1.24			
—	—	—	—	28.5	32.6	40.7	47.8	55.4	58.9	74.0	88.0	118.1	148.1	178.1	14.0	27.0	1.93
34.6	37.6	42.1	45.6	49.6	53.6	61.6	68.6	76.1	79.6	94.6	108.6	138.6	168.6	198.6	5.0	10.0	2.00
33.4	36.4	40.9	44.4	48.4	52.4	60.4	67.4	74.9	78.4	93.5	107.5	137.5	167.5	197.5	5.5	11.0	2.00
32.2	35.2	39.7	43.2	47.2	51.2	59.2	66.2	73.8	77.3	92.3	106.3	136.3	166.3	196.3	6.0	12.0	2.00
29.8	32.8	37.3	40.8	44.8	48.8	56.8	63.9	71.4	74.9	89.9	103.9	133.9	163.9	193.9	7.0	14.0	2.00
0.88	0.89	0.92	0.93	0.95	0.96	0.99	1.01	1.03	1.04	1.08	1.11	1.16	1.20	1.23			
27.3	30.3	34.9	38.4	42.4	46.4	54.5	61.5	69.0	72.5	87.5	101.5	131.5	161.6	191.6	8.0	16.0	2.00
24.8	27.9	32.4	36.0	40.0	44.0	52.0	59.1	66.6	70.1	85.1	99.1	129.2	159.2	189.2	9.0	18.0	2.00
22.3	25.4	30.0	33.5	37.6	41.6	49.6	56.7	64.2	67.7	82.7	96.8	126.8	156.8	186.8	10.0	20.0	2.00
—	—	25.0	28.5	32.6	36.7	44.8	51.8	59.4	62.9	77.9	92.0	122.0	152.1	182.1	12.0	24.0	2.00
—	—	—	25.1	29.2	33.3	41.4	48.5	56.1	59.6	74.7	88.8	118.8	148.9	178.9	13.0	27.0	2.08
0.86	0.88	0.90	0.92	0.94	0.95	0.98	1.00	1.03	1.03	1.07	1.10	1.15	1.20	1.23			
34.2	37.2	41.7	45.2	49.2	53.2	61.2	68.2	75.7	79.2	94.2	108.2	138.2	168.3	198.3	5.0	10.5	2.10
22.7	25.7	30.3	33.9	37.9	42.0	50.0	57.0	64.6	68.1	83.1	97.1	127.2	157.2	187.2	9.5	20.0	2.11
25.2	28.2	32.8	36.3	40.4	44.4	52.4	59.4	67.0	70.5	85.5	99.5	129.5	159.6	189.6	8.5	18.0	2.12
27.7	30.7	35.2	38.8	42.8	46.8	54.8	61.8	69.4	72.9	87.9	101.9	131.9	161.9	191.9	7.5	16.0	2.13
—	—	—	—	—	29.8	38.1	45.2	52.8	56.3	71.4	85.5	115.6	145.7	175.7	14.0	30.0	2.14
0.88	0.89	0.91	0.93	0.95	0.96	0.99	1.01	1.03	1.04	1.08	1.10	1.16	1.20	1.23			

FOR BELT SIZES NOT SHOWN, INTERPOLATE FOR ADDITIONAL CENTER DISTANCE.

V-BELT DRIVES

C Stock Drive Selection



V-BELT DRIVES

Speed Ratio	Sheave Combination		DriveN Speeds and HP Per Belt									Nominal Center Distance And Arc-Length Correction Factors					
			1750 RPM DriveR			1160 RPM DriveR			870 RPM DriveR			C/CX Belt Length Designation					
	DriveR P.D.	DriveN P.D.	DriveN RPM	HP Per Belt C	HP Per Belt CX	DriveN RPM	HP Per Belt C	HP Per Belt CX	DriveN RPM	HP Per Belt C	HP Per Belt CX	51	60	68	75	81	85
2.17	6.0	13.0	808	8.82	12.91	535	7.02	9.63	402	5.79	7.71	—	—	—	23.8	26.8	28.8
2.18	5.5	12.0	802	6.67	10.68	532	5.45	8.02	399	4.56	6.45	12.8	16.1	20.2	25.0	28.0	30.0
2.18	11.0	24.0	802	26.67	32.12	532	21.36	24.48	399	17.37	19.56	—	—	—	—	—	—
2.20	5.0	11.0	795	4.46	8.41	527	3.85	6.39	395	3.30	5.18	14.1	18.6	22.7	26.2	29.2	31.2
2.22	9.0	20.0	788	20.39	25.16	522	15.94	18.81	392	12.92	14.97	—	—	—	—	—	20.4
ARC-LENGTH CORRECTION FACTOR												0.71	0.77	0.80	0.83	0.85	0.86
2.25	8.0	18.0	778	16.81	21.31	516	13.08	15.84	387	10.60	12.60	—	—	—	17.8	20.9	23.0
2.25	12.0	27.0	778	29.33	35.20	516	23.90	27.17	387	19.52	21.79	—	—	—	—	—	—
2.25	16.0	36.0	+	+	+	516	32.81	36.88	387	27.47	30.14	—	—	—	—	—	—
2.29	7.0	16.0	766	12.95	17.23	508	10.11	12.79	381	8.23	10.19	—	—	16.8	20.4	23.5	25.5
2.29	10.5	24.0	766	25.23	30.49	508	20.05	23.10	381	16.29	18.44	—	—	—	—	—	—
ARC-LENGTH CORRECTION FACTOR												0.0	0.0	0.77	0.80	0.83	0.84
2.31	13.0	30.0	758	31.63	37.98	503	26.33	29.77	377	21.60	23.96	—	—	—	—	—	—
2.33	6.0	14.0	750	8.83	12.93	497	7.04	9.64	373	5.80	7.71	—	15.2	19.3	22.9	25.9	28.0
2.35	8.5	20.0	744	18.65	23.28	493	14.53	17.35	370	11.77	13.80	—	—	—	—	—	20.8
2.36	5.5	13.0	740	6.69	10.70	491	5.46	8.03	368	4.57	6.46	11.8	16.5	20.6	24.1	27.2	29.2
2.40	5.0	12.0	729	4.48	8.42	483	3.87	6.40	363	3.31	5.19	13.1	17.8	21.8	25.4	28.4	30.4
ARC-LENGTH CORRECTION FACTOR												0.70	0.75	0.79	0.82	0.84	0.85
2.40	7.5	18.0	729	14.92	19.31	483	11.61	14.33	363	9.43	11.41	—	—	—	18.2	21.3	23.3
2.40	10.0	24.0	729	23.71	28.79	483	18.72	21.70	363	15.18	17.30	—	—	—	—	—	—
2.45	11.0	27.0	713	26.70	32.14	473	21.38	24.49	354	17.39	19.57	—	—	—	—	—	—
2.50	8.0	20.0	700	16.83	21.33	464	13.09	15.86	348	10.61	12.61	—	—	—	—	19.0	21.1
2.50	12.0	30.0	700	29.35	35.22	464	23.92	27.19	348	19.53	21.80	—	—	—	—	—	—
ARC-LENGTH CORRECTION FACTOR												0.0	0.0	0.0	0.78	0.81	0.83
2.53	9.5	24.0	693	22.11	27.02	459	17.36	20.28	344	14.07	16.15	—	—	—	—	—	—
2.55	5.5	14.0	688	6.70	10.71	456	5.47	8.04	342	4.57	6.46	—	15.6	19.7	23.2	26.3	28.3
2.57	7.0	18.0	681	12.97	17.25	451	10.12	12.80	338	8.24	10.19	—	—	—	18.5	21.6	23.7
2.57	10.5	27.0	681	25.25	30.51	451	20.07	23.12	338	16.30	18.45	—	—	—	—	—	—
2.57	14.0	36.0	681	33.57	40.47	451	28.63	32.26	338	23.64	26.08	—	—	—	—	—	—
ARC-LENGTH CORRECTION FACTOR												0.0	0.74	0.78	0.81	0.83	0.85
2.60	5.0	13.0	673	4.50	8.44	446	3.87	6.41	335	3.32	5.19	12.2	16.8	20.9	24.5	27.5	29.5
2.67	6.0	16.0	656	8.86	12.95	435	7.05	9.65	326	5.82	7.72	—	—	17.5	21.1	24.2	26.2
2.67	7.5	20.0	656	14.94	19.32	435	11.63	14.34	326	9.44	11.41	—	—	—	—	19.3	21.4
2.67	9.0	24.0	656	20.43	25.19	435	15.97	18.83	326	12.93	14.99	—	—	—	—	—	—
2.70	10.0	27.0	648	23.73	28.81	430	18.73	21.72	322	15.19	17.31	—	—	—	—	—	—
ARC-LENGTH CORRECTION FACTOR												0.69	0.75	0.79	0.82	0.84	0.85
2.73	11.0	30.0	642	26.72	32.16	425	21.39	24.50	319	17.39	19.58	—	—	—	—	—	—
2.75	16.0	44.0	+	+	+	422	32.83	36.90	316	27.49	30.16	—	—	—	—	—	—
2.77	13.0	36.0	632	31.66	38.01	419	26.35	29.78	314	21.62	23.97	—	—	—	—	—	—
2.80	5.0	14.0	625	4.51	8.44	414	3.88	6.42	311	3.33	5.20	—	15.9	20.0	23.6	26.6	28.7
2.82	8.5	24.0	620	18.68	23.30	411	14.55	17.36	308	11.79	13.81	—	—	—	—	—	—
ARC-LENGTH CORRECTION FACTOR												0.0	0.74	0.78	0.81	0.83	0.85
2.84	9.5	27.0	616	22.12	27.04	408	17.37	20.29	306	14.07	16.16	—	—	—	—	—	—
2.86	7.0	20.0	613	12.99	17.26	406	10.13	12.81	305	8.25	10.20	—	—	—	—	19.7	21.8
2.86	10.5	30.0	613	25.27	30.52	406	20.08	23.12	305	16.30	18.46	—	—	—	—	—	—
2.91	5.5	16.0	602	6.72	10.73	399	5.49	8.05	299	4.58	6.47	—	—	17.8	21.4	24.5	26.5
3.00	6.0	18.0	583	8.87	12.96	387	7.06	9.66	290	5.82	7.73	—	—	—	19.2	22.3	24.4
ARC-LENGTH CORRECTION FACTOR												0.0	0.0	0.76	0.79	0.82	0.83
3.00	8.0	24.0	583	16.85	21.35	387	13.11	15.87	290	10.63	12.62	—	—	—	—	—	—
3.00	9.0	27.0	583	20.44	25.20	387	15.98	18.84	290	12.94	15.00	—	—	—	—	—	—
3.00	10.0	30.0	583	23.74	28.82	387	18.74	21.72	290	15.20	17.32	—	—	—	—	—	—
3.00	12.0	36.0	583	29.38	35.24	387	23.93	27.20	290	19.54	21.81	—	—	—	—	—	—
3.13	16.0	50.0	+	+	+	371	32.84	36.91	278	27.50	30.17	—	—	—	—	—	—
ARC-LENGTH CORRECTION FACTOR												0.0	0.0	0.0	0.0	0.0	0.0
3.14	14.0	44.0	557	33.59	40.49	369	28.65	32.27	277	23.65	26.09	—	—	—	—	—	—
3.16	9.5	30.0	554	22.14	27.05	367	17.38	20.30	276	14.08	16.16	—	—	—	—	—	—
3.18	8.5	27.0	551	18.69	23.31	365	14.56	17.37	274	11.79	13.82	—	—	—	—	—	—
3.20	5.0	16.0	547	4.52	8.46	363	3.89	6.42	272	3.33	5.20	—	—	18.1	21.8	24.8	26.9
3.20	7.5	24.0	547	14.96	19.34	363	11.64	14.35	272	9.45	11.42	—	—	—	—	—	—
ARC-LENGTH CORRECTION FACTOR												0.0	0.0	0.76	0.79	0.82	0.83

C = STANDARD V-BELT
 CX = COGGED/NOTCHED V-BELT
 + IF RIM SPEED EXCEEDS 6500 FEET PER MINUTE, CONSULT *Martin*.



Stock Drive Selection C

Nominal Center Distances And Arc-Length Correction Factor															Sheave Combination		Speed Ratio
C/CX Belt Length Designation															DriveR P.D.	DriveN P.D.	
90	96	105	112	120	128	144	158	173	180	210	240	300	360	420			
31.3	34.3	38.9	42.4	46.4	50.4	58.4	65.4	72.9	76.4	91.5	105.5	135.5	165.5	195.5	6.0	13.0	2.17
32.5	35.6	40.1	43.6	47.6	51.6	59.6	66.6	74.1	77.6	92.6	106.7	136.7	166.7	196.7	5.5	12.0	2.18
—	—	25.6	29.2	33.3	37.4	45.5	52.6	60.1	63.6	78.7	92.7	122.8	152.8	182.8	11.0	24.0	2.18
33.8	36.8	41.3	44.8	48.8	52.8	60.8	67.8	75.3	78.8	93.8	107.8	137.9	167.9	197.9	5.0	11.0	2.20
23.0	26.1	30.7	34.2	38.3	42.3	50.4	57.4	64.9	68.5	83.5	97.5	127.6	157.6	187.6	9.0	20.0	2.22
0.87	0.89	0.91	0.93	0.94	0.96	0.99	1.01	1.03	1.04	1.07	1.10	1.16	1.20	1.23			
25.5	28.6	33.2	36.7	40.7	44.8	52.8	59.8	67.3	70.9	85.9	99.9	129.9	160.0	190.0	8.0	18.0	2.25
—	—	—	25.7	29.9	34.0	42.2	49.2	56.8	60.4	75.4	89.5	119.6	149.6	179.7	12.0	27.0	2.25
—	—	—	—	—	—	31.0	38.3	46.0	49.6	64.8	79.0	109.2	139.3	169.3	16.0	36.0	2.25
28.0	31.1	35.6	39.1	43.2	47.2	55.2	62.2	69.7	73.2	88.3	102.3	132.3	162.3	192.3	7.0	16.0	2.29
—	—	26.0	29.6	33.7	37.8	45.9	52.9	60.5	64.0	79.1	93.1	123.2	153.2	183.2	10.5	24.0	2.29
0.86	0.87	0.90	0.91	0.93	0.95	0.98	1.00	1.02	1.03	1.07	1.10	1.15	1.20	1.23			
—	—	—	—	26.3	30.5	38.7	45.9	53.5	57.0	72.2	86.3	116.4	146.4	176.5	13.0	30.0	2.31
30.5	33.5	38.0	41.5	45.6	49.6	57.6	64.6	72.1	75.6	90.7	104.7	134.7	164.7	194.7	6.0	14.0	2.33
23.4	26.4	31.0	34.6	38.6	42.7	50.7	57.8	65.3	68.8	83.9	97.9	127.9	158.0	188.0	8.5	20.0	2.35
31.7	34.7	39.2	42.8	46.8	50.8	58.8	65.8	73.3	76.8	91.8	105.9	135.9	165.9	195.9	5.5	13.0	2.36
32.9	35.9	40.4	44.0	48.0	52.0	60.0	67.0	74.5	78.0	93.0	107.0	137.1	167.1	197.1	5.0	12.0	2.40
0.87	0.88	0.91	0.92	0.94	0.95	0.98	1.01	1.03	1.04	1.07	1.10	1.15	1.20	1.23			
25.9	28.9	33.5	37.1	41.1	45.1	53.2	60.2	67.7	71.2	86.3	100.3	130.3	160.3	190.3	7.5	18.0	2.40
—	21.6	26.3	29.9	34.0	38.1	46.2	53.3	60.8	64.4	79.4	93.5	123.5	153.6	183.6	10.0	24.0	2.40
—	—	—	26.4	30.6	34.7	42.9	50.0	57.5	61.1	76.2	90.3	120.3	150.4	180.4	11.0	27.0	2.45
23.7	26.8	31.4	34.9	39.0	43.0	51.1	58.1	65.7	69.2	84.2	98.3	128.3	158.3	188.4	8.0	20.0	2.50
—	—	—	—	27.0	31.2	39.4	46.6	54.2	57.8	72.9	87.0	117.1	147.2	177.2	12.0	30.0	2.50
0.84	0.86	0.89	0.91	0.93	0.94	0.97	1.00	1.02	1.03	1.07	1.10	1.15	1.19	1.23			
—	21.9	26.7	30.3	34.4	38.5	46.6	53.6	61.2	64.7	79.8	93.9	123.9	154.0	184.0	9.5	24.0	2.53
30.8	33.9	38.4	41.9	45.9	50.0	58.0	65.0	72.5	76.0	91.0	105.0	135.1	165.1	195.1	5.5	14.0	2.55
26.2	29.3	33.9	37.4	41.5	45.5	53.5	60.6	68.1	71.6	86.6	100.7	130.7	160.7	190.7	7.0	18.0	2.57
—	—	—	26.7	30.9	35.0	43.2	50.3	57.9	61.4	76.6	90.6	120.7	150.8	180.8	10.5	27.0	2.57
—	—	—	—	—	—	32.3	39.7	47.4	51.0	66.3	80.4	110.6	140.8	170.8	14.0	36.0	2.57
0.86	0.88	0.90	0.92	0.94	0.95	0.98	1.00	1.02	1.03	1.07	1.10	1.15	1.20	1.23			
32.1	35.1	39.6	43.1	47.1	51.2	59.2	66.2	73.7	77.2	92.2	106.2	136.3	166.3	196.3	5.0	13.0	2.60
28.7	31.8	36.3	39.9	43.9	47.9	55.9	63.0	70.5	74.0	89.0	103.0	133.1	163.1	193.1	6.0	16.0	2.67
24.0	27.1	31.7	35.3	39.4	43.4	51.5	58.5	66.1	69.6	84.6	98.7	128.7	158.7	188.7	7.5	20.0	2.67
—	22.3	27.0	30.6	34.7	38.8	46.9	54.0	61.6	65.1	80.2	94.2	124.3	154.3	184.4	9.0	24.0	2.67
—	—	23.3	27.1	31.2	35.4	43.6	50.7	58.3	61.8	76.9	91.0	121.1	151.2	181.2	10.0	27.0	2.70
0.87	0.88	0.90	0.92	0.94	0.95	0.98	1.00	1.03	1.04	1.07	1.10	1.15	1.20	1.23			
—	—	—	—	27.6	31.8	40.1	47.3	54.9	58.5	73.6	87.7	117.9	147.9	178.0	11.0	30.0	2.73
—	—	—	—	—	—	—	—	38.3	42.0	57.6	72.0	102.4	132.6	162.7	16.0	44.0	2.75
—	—	—	—	—	—	33.0	40.3	48.1	51.7	67.0	81.2	111.4	141.5	171.6	13.0	36.0	2.77
31.2	34.2	38.8	42.3	46.3	50.3	58.4	65.4	72.9	76.4	91.4	105.4	135.5	165.5	195.5	5.0	14.0	2.80
—	22.6	27.3	31.0	35.1	39.2	47.3	54.4	61.9	65.5	80.6	94.6	124.7	154.7	184.8	8.5	24.0	2.82
0.86	0.88	0.90	0.92	0.93	0.95	0.98	1.00	1.02	1.03	1.07	1.10	1.15	1.20	1.23			
—	—	23.7	27.4	31.6	35.7	43.9	51.0	58.6	62.2	77.3	91.4	121.5	151.5	181.6	9.5	27.0	2.84
24.4	27.5	32.1	35.7	39.7	43.8	51.8	58.9	66.4	69.9	85.0	99.0	129.1	159.1	189.1	7.0	20.0	2.86
—	—	—	—	27.9	32.2	40.5	47.6	55.3	58.8	74.0	88.1	118.2	148.3	178.4	10.5	30.0	2.86
29.1	32.1	36.7	40.2	44.3	48.3	56.3	63.3	70.9	74.4	89.4	103.4	133.5	163.5	193.5	5.5	16.0	2.91
26.9	30.0	34.6	38.1	42.2	46.2	54.3	61.3	68.8	72.4	87.4	101.4	131.5	161.5	191.5	6.0	18.0	3.00
0.85	0.87	0.89	0.91	0.93	0.95	0.98	1.00	1.02	1.03	1.07	1.10	1.15	1.19	1.23			
—	22.9	27.7	31.3	35.4	39.5	47.6	54.7	62.3	65.8	80.9	95.0	125.1	155.1	185.1	8.0	24.0	3.00
—	—	24.0	27.7	31.9	36.1	44.3	51.4	59.0	62.5	77.7	91.7	121.8	151.9	182.0	9.0	27.0	3.00
—	—	—	—	28.3	32.5	40.8	48.0	55.6	59.2	74.4	88.5	118.6	148.7	178.8	10.0	30.0	3.00
—	—	—	—	—	—	33.6	41.0	48.8	52.4	67.7	81.9	112.1	142.2	172.3	12.0	36.0	3.00
—	—	—	—	—	—	—	—	—	—	51.8	66.4	97.1	127.5	157.7	16.0	50.0	3.13
0.0	0.81	0.85	0.87	0.90	0.92	0.95	0.98	1.00	1.01	1.06	1.09	1.14	1.19	1.22			
—	—	—	—	—	—	—	—	39.6	43.3	59.0	73.4	103.8	134.1	164.2	14.0	44.0	3.14
—	—	—	24.3	28.6	32.8	41.2	48.3	56.0	59.5	74.7	88.8	119.0	149.1	179.1	9.5	30.0	3.16
—	—	24.3	28.0	32.2	36.4	44.6	51.7	59.3	62.9	78.0	92.1	122.2	152.3	182.3	8.5	27.0	3.18
29.4	32.5	37.0	40.6	44.6	48.6	56.7	63.7	71.2	74.8	89.8	103.8	133.8	163.9	193.9	5.0	16.0	3.20
—	23.2	28.0	31.6	35.8	39.9	48.0	55.1	62.7	66.2	81.3	95.4	125.4	155.5	185.5	7.5	24.0	3.20
0.85	0.87	0.89	0.91	0.93	0.94	0.97	1.00	1.02	1.03	1.07	1.10	1.15	1.19	1.23			

FOR BELT SIZES NOT SHOWN, INTERPOLATE FOR ADDITIONAL CENTER DISTANCE.

V-BELT DRIVES

C Stock Drive Selection



V-BELT DRIVES

Speed Ratio	Sheave Combination		DriveN Speeds and HP Per Belt									Nominal Center Distance And Arc-Length Correction Factors					
			1750 RPM DriveR			1160 RPM DriveR			870 RPM DriveR			C/CX Belt Length Designation					
	DriveR P.D.	DriveN P.D.	DriveN RPM	HP Per Belt C	HP Per Belt CX	DriveN RPM	HP Per Belt C	HP Per Belt CX	DriveN RPM	HP Per Belt C	HP Per Belt CX	51	60	68	75	81	85
3.27	5.5	18.0	535	6.73	10.74	354	5.49	8.06	266	4.59	6.48	—	—	—	19.5	22.6	24.7
3.27	11.0	36.0	535	26.73	32.17	354	21.40	24.51	266	17.40	19.59	—	—	—	—	—	—
3.33	6.0	20.0	525	8.88	12.97	348	7.07	9.66	261	5.83	7.73	—	—	—	—	20.3	22.4
3.33	9.0	30.0	525	20.45	25.21	348	15.98	18.85	261	12.95	15.00	—	—	—	—	—	—
3.38	8.0	27.0	519	16.86	21.36	344	13.12	15.88	258	10.63	12.63	—	—	—	—	—	—
ARC-LENGTH CORRECTION FACTOR												0.0	0.0	0.0	0.77	0.80	0.82
3.38	13.0	44.0	517	31.68	38.03	343	26.36	29.79	257	21.63	23.98	—	—	—	—	—	—
3.43	7.0	24.0	510	13.00	17.27	338	10.14	12.82	254	8.26	10.21	—	—	—	—	—	—
3.43	10.5	36.0	510	25.29	30.53	338	20.09	23.13	254	16.31	18.46	—	—	—	—	—	—
3.53	8.5	30.0	496	18.70	23.32	329	14.57	17.37	247	11.80	13.82	—	—	—	—	—	—
3.57	14.0	50.0	490	33.60	40.50	325	28.66	32.28	244	23.65	26.10	—	—	—	—	—	—
ARC-LENGTH CORRECTION FACTOR												0.0	0.0	0.0	0.0	0.0	0.0
3.60	5.0	18.0	486	4.53	8.46	322	3.90	6.43	242	3.34	5.21	—	—	16.1	19.8	23.0	25.0
3.60	7.5	27.0	486	14.97	19.35	322	11.64	14.36	242	9.45	11.43	—	—	—	—	—	—
3.60	10.0	36.0	486	23.76	28.83	322	18.75	21.73	242	15.21	17.32	—	—	—	—	—	—
3.64	5.5	20.0	481	6.74	10.74	319	5.50	8.06	239	4.59	6.48	—	—	—	17.4	20.6	22.8
3.67	12.0	44.0	477	29.39	35.25	316	23.94	27.21	237	19.55	21.81	—	—	—	—	—	—
ARC-LENGTH CORRECTION FACTOR												0.0	0.0	0.72	0.77	0.80	0.82
3.75	8.0	30.0	467	16.87	21.36	309	13.12	15.88	232	10.63	12.63	—	—	—	—	—	—
3.79	9.5	36.0	462	22.15	27.06	306	17.38	20.30	230	14.09	16.17	—	—	—	—	—	—
3.85	13.0	50.0	455	31.69	38.03	302	26.36	29.80	226	21.63	23.98	—	—	—	—	—	—
3.86	7.0	27.0	454	13.01	17.28	301	10.15	12.82	226	8.26	10.21	—	—	—	—	—	—
4.00	5.0	20.0	438	4.53	8.47	290	3.90	6.43	218	3.34	5.21	—	—	—	17.7	21.0	23.1
ARC-LENGTH CORRECTION FACTOR												0.0	0.0	0.0	0.74	0.77	0.79
4.00	6.0	24.0	438	8.89	12.98	290	7.08	9.67	218	5.83	7.74	—	—	—	—	—	—
4.00	7.5	30.0	438	14.98	19.35	290	11.65	14.36	218	9.46	11.43	—	—	—	—	—	—
4.00	9.0	36.0	438	20.46	25.22	290	15.99	18.85	218	12.95	15.00	—	—	—	—	—	—
4.00	11.0	44.0	438	26.75	32.18	290	21.41	24.52	218	17.41	19.59	—	—	—	—	—	—
4.17	12.0	50.0	420	29.40	35.26	278	23.95	27.21	209	19.55	21.82	—	—	—	—	—	—
ARC-LENGTH CORRECTION FACTOR												0.0	0.0	0.0	0.0	0.0	0.0
4.19	10.5	44.0	418	25.30	30.54	277	20.10	23.14	208	16.32	18.47	—	—	—	—	—	—
4.24	8.5	36.0	413	18.71	23.32	274	14.57	17.38	205	11.80	13.82	—	—	—	—	—	—
4.29	7.0	30.0	408	13.01	17.28	271	10.15	12.82	203	8.26	10.21	—	—	—	—	—	—
4.36	5.5	24.0	401	6.75	10.75	266	5.50	8.06	199	4.60	6.48	—	—	—	—	—	—
4.40	10.0	44.0	398	23.76	28.83	264	18.76	21.73	198	15.21	17.32	—	—	—	—	—	—
ARC-LENGTH CORRECTION FACTOR												0.0	0.0	0.0	0.0	0.0	0.0
4.50	6.0	27.0	389	8.90	12.98	258	7.08	9.67	193	5.83	7.74	—	—	—	—	—	—
4.50	8.0	36.0	389	16.88	21.37	258	13.12	15.88	193	10.64	12.63	—	—	—	—	—	—
4.55	11.0	50.0	385	26.75	32.19	255	21.41	24.52	191	17.41	19.60	—	—	—	—	—	—
4.63	9.5	44.0	378	22.15	27.06	250	17.39	20.31	188	14.09	16.17	—	—	—	—	—	—
4.76	10.5	50.0	368	25.30	30.55	244	20.10	23.14	183	16.32	18.47	—	—	—	—	—	—
ARC-LENGTH CORRECTION FACTOR												0.0	0.0	0.0	0.0	0.0	0.0
4.80	5.0	24.0	365	4.54	8.47	242	3.90	6.43	181	3.34	5.21	—	—	—	—	—	—
4.80	7.5	36.0	365	14.98	19.36	242	11.65	14.36	181	9.46	11.43	—	—	—	—	—	—
4.89	9.0	44.0	358	20.47	25.23	237	16.00	18.86	178	12.95	15.01	—	—	—	—	—	—
4.91	5.5	27.0	356	6.75	10.75	236	5.50	8.07	177	4.60	6.48	—	—	—	—	—	—
5.00	6.0	30.0	350	8.90	12.98	232	7.08	9.67	174	5.84	7.74	—	—	—	—	—	—
ARC-LENGTH CORRECTION FACTOR												0.0	0.0	0.0	0.0	0.0	0.0
5.00	10.0	50.0	350	23.77	28.84	232	18.76	21.74	174	15.21	17.33	—	—	—	—	—	—
5.14	7.0	36.0	340	13.02	17.29	226	10.15	12.82	169	8.27	10.21	—	—	—	—	—	—
5.18	8.5	44.0	338	18.71	23.33	224	14.57	17.38	168	11.80	13.83	—	—	—	—	—	—
5.26	9.5	50.0	333	22.16	27.06	220	17.39	20.31	165	14.09	16.17	—	—	—	—	—	—
5.40	5.0	27.0	324	4.54	8.47	215	3.91	6.44	161	3.34	5.21	—	—	—	—	—	—
ARC-LENGTH CORRECTION FACTOR												0.0	0.0	0.0	0.0	0.0	0.0
5.45	5.5	30.0	321	6.75	10.76	213	5.51	8.07	160	4.60	6.48	—	—	—	—	—	—
5.50	8.0	44.0	318	16.88	21.37	211	13.13	15.89	158	10.64	12.64	—	—	—	—	—	—
5.56	9.0	50.0	315	20.47	25.23	209	16.00	18.86	157	12.96	15.01	—	—	—	—	—	—
5.87	7.5	44.0	298	14.99	19.36	198	11.66	14.37	148	9.46	11.43	—	—	—	—	—	—
5.88	8.5	50.0	298	18.71	23.33	197	14.58	17.38	148	11.81	13.83	—	—	—	—	—	—
ARC-LENGTH CORRECTION FACTOR												0.0	0.0	0.0	0.0	0.0	0.0

C = STANDARD V-BELT
 CX = COGGED/NOTCHED V-BELT
 + IF RIM SPEED EXCEEDS 6500 FEET PER MINUTE, CONSULT *Martin*.



Stock Drive Selection C

V-BELT DRIVES

Nominal Center Distances And Arc-Length Correction Factor															Sheave Combination		Speed Ratio
C/CX Belt Length Designation															DriveR P.D.	DriveN P.D.	
90	96	105	112	120	128	144	158	173	180	210	240	300	360	420			
27.3	30.3	34.9	38.5	42.5	46.6	54.6	61.7	69.2	72.7	87.8	101.8	131.8	161.9	191.9	5.5	18.0	3.27
—	—	—	—	—	—	34.3	41.7	49.5	53.1	68.4	82.6	112.8	143.0	173.1	11.0	36.0	3.27
25.1	28.2	32.8	36.4	40.4	44.5	52.6	59.6	67.2	70.7	85.7	99.8	129.8	159.9	189.9	6.0	20.0	3.33
—	—	—	24.6	28.9	33.2	41.5	48.7	56.3	59.9	75.1	89.2	119.4	149.5	179.5	9.0	30.0	3.33
—	—	24.6	28.4	32.6	36.7	45.0	52.1	59.7	63.2	78.4	92.5	122.6	152.7	182.7	8.0	27.0	3.39
0.84	0.86	0.88	0.90	0.92	0.94	0.97	0.99	1.02	1.03	1.06	1.09	1.15	1.19	1.23			
—	—	—	—	—	—	—	31.9	40.2	43.9	59.7	74.1	104.5	134.8	165.0	13.0	44.0	3.38
20.3	23.6	28.3	32.0	36.1	40.2	48.4	55.5	63.0	66.6	81.7	95.7	125.8	155.9	185.9	7.0	24.0	3.43
—	—	—	—	—	—	34.6	42.0	49.8	53.4	68.7	82.9	113.2	143.4	173.5	10.5	36.0	3.43
—	—	—	24.9	29.2	33.5	41.8	49.0	56.7	60.3	75.4	89.6	119.7	149.8	179.9	8.5	30.0	3.53
—	—	—	—	—	—	—	—	—	36.8	53.1	67.8	98.5	128.9	159.2	14.0	50.0	3.57
0.77	0.81	0.85	0.87	0.89	0.91	0.95	0.98	1.00	1.01	1.05	1.09	1.14	1.19	1.22			
27.6	30.7	35.3	38.8	42.9	46.9	55.0	62.0	69.6	73.1	88.1	102.2	132.2	162.3	192.3	5.0	18.0	3.60
—	—	24.9	28.7	32.9	37.1	45.3	52.4	60.1	63.6	78.8	92.8	123.0	153.0	183.1	7.5	27.0	3.60
—	—	—	—	—	—	34.9	42.3	50.1	53.7	69.1	83.3	113.6	143.7	173.8	10.0	36.0	3.60
25.4	28.5	33.1	36.7	40.8	44.8	52.9	60.0	67.5	71.1	86.1	100.2	130.2	160.3	190.3	5.5	20.0	3.64
—	—	—	—	—	—	—	32.5	40.8	44.6	60.3	74.8	105.3	135.5	165.7	12.0	44.0	3.67
0.83	0.85	0.88	0.90	0.92	0.94	0.97	0.99	1.01	1.02	1.06	1.09	1.15	1.19	1.23			
—	—	—	25.2	29.6	33.8	42.2	49.4	57.0	60.6	75.8	89.9	120.1	150.2	180.3	8.0	30.0	3.75
—	—	—	—	—	—	35.2	42.7	50.5	54.1	69.5	83.7	113.9	144.1	174.2	9.5	36.0	3.79
—	—	—	—	—	—	—	—	—	37.4	53.8	68.5	99.2	129.7	159.9	13.0	50.0	3.85
—	—	25.3	29.0	33.2	37.4	45.7	52.8	60.4	64.0	79.1	93.2	123.3	153.4	183.5	7.0	27.0	3.86
25.7	28.8	33.5	37.1	41.1	45.2	53.3	60.3	67.9	71.4	86.5	100.5	130.6	160.6	190.7	5.0	20.0	4.00
0.82	0.84	0.87	0.89	0.91	0.93	0.96	0.99	1.01	1.02	1.06	1.09	1.15	1.19	1.23			
21.0	24.2	29.0	32.6	36.8	40.9	49.1	56.2	63.8	67.3	82.4	96.5	126.6	156.6	186.7	6.0	24.0	4.00
—	—	—	25.5	29.9	34.1	42.5	49.7	57.4	61.0	76.2	90.3	120.5	150.6	180.6	7.5	30.0	4.00
—	—	—	—	—	—	35.5	43.0	50.8	54.4	69.8	84.0	114.3	144.5	174.6	9.0	36.0	4.00
—	—	—	—	—	—	—	33.1	41.5	45.2	61.0	75.4	106.0	136.3	166.4	11.0	44.0	4.00
—	—	—	—	—	—	—	—	33.9	38.0	54.4	69.1	99.9	130.4	160.6	12.0	50.0	4.17
0.77	0.80	0.84	0.87	0.89	0.91	0.95	0.98	1.00	1.01	1.05	1.08	1.14	1.19	1.22			
—	—	—	—	—	—	—	33.5	41.8	45.6	61.4	75.8	106.3	136.6	166.8	10.5	44.0	4.19
—	—	—	—	—	27.0	35.9	43.3	51.2	54.8	70.2	84.4	114.7	144.8	175.0	8.5	36.0	4.24
—	—	—	25.8	30.2	34.5	42.8	50.1	57.7	61.3	76.5	90.7	120.8	151.0	181.0	7.0	30.0	4.29
21.3	24.5	29.3	33.0	37.1	41.2	49.4	56.5	64.1	67.6	82.8	96.8	126.9	157.0	187.1	5.5	24.0	4.36
—	—	—	—	—	—	—	33.8	42.1	45.9	61.7	76.1	106.7	137.0	167.2	10.0	44.0	4.40
0.77	0.80	0.84	0.86	0.89	0.91	0.95	0.97	1.00	1.01	1.05	1.08	1.14	1.19	1.22			
—	—	25.9	29.7	33.9	38.1	46.3	53.5	61.1	64.7	79.8	93.9	124.1	154.2	184.2	6.0	27.0	4.50
—	—	—	—	—	27.3	36.2	43.6	51.5	55.1	70.5	84.7	115.0	145.2	175.3	8.0	36.0	4.50
—	—	—	—	—	—	—	—	34.5	38.6	55.1	69.8	100.7	131.1	161.4	11.0	50.0	4.55
—	—	—	—	—	—	—	34.1	42.4	46.2	62.0	76.5	107.0	137.3	167.5	9.5	44.0	4.63
—	—	—	—	—	—	—	—	34.8	38.9	55.4	70.2	101.0	131.4	161.7	10.5	50.0	4.76
0.0	0.0	0.81	0.84	0.87	0.89	0.93	0.96	0.99	1.00	1.05	1.08	1.14	1.18	1.22			
21.6	24.9	29.7	33.3	37.5	41.6	49.8	56.9	64.5	68.0	83.1	97.2	127.3	157.4	187.4	5.0	24.0	4.80
—	—	—	—	—	27.6	36.5	44.0	51.8	55.5	70.9	85.1	115.4	145.6	175.7	7.5	36.0	4.80
—	—	—	—	—	—	—	34.4	42.7	46.5	62.4	76.8	107.4	137.7	167.9	9.0	44.0	4.89
—	21.2	26.2	30.0	34.2	38.4	46.7	53.9	61.5	65.0	80.2	94.3	124.5	154.6	184.6	5.5	27.0	4.91
—	—	—	26.5	30.8	35.1	43.5	50.8	58.4	62.0	77.2	91.4	121.6	151.7	181.8	6.0	30.0	5.00
0.76	0.80	0.84	0.86	0.89	0.91	0.95	0.98	1.00	1.01	1.05	1.08	1.14	1.18	1.22			
—	—	—	—	—	—	—	—	35.1	39.2	55.7	70.5	101.4	131.8	162.1	10.0	50.0	5.00
—	—	—	—	—	27.9	36.8	44.3	52.2	55.8	71.2	85.4	115.8	146.0	176.1	7.0	36.0	5.14
—	—	—	—	—	—	—	34.7	43.1	46.9	62.7	77.2	107.8	138.1	168.3	8.5	44.0	5.18
—	—	—	—	—	—	—	—	35.4	39.5	56.1	70.8	101.7	132.2	162.5	9.5	50.0	5.26
—	21.5	26.5	30.3	34.6	38.8	47.0	54.2	61.8	65.4	80.6	94.7	124.8	154.9	185.0	5.0	27.0	5.40
0.0	0.74	0.80	0.84	0.87	0.89	0.93	0.96	0.99	1.00	1.04	1.08	1.14	1.18	1.22			
—	—	22.8	26.8	31.2	35.5	43.9	51.1	58.8	62.4	77.6	91.8	122.0	152.1	182.2	5.5	30.0	5.45
—	—	—	—	—	—	—	35.0	43.4	47.2	63.0	77.5	108.1	138.4	168.6	8.0	44.0	5.50
—	—	—	—	—	—	—	—	35.7	39.8	56.4	71.2	102.1	132.5	162.8	9.0	50.0	5.56
—	—	—	—	—	—	—	35.3	43.7	47.5	63.4	77.9	108.5	138.8	169.0	7.5	44.0	5.87
—	—	—	—	—	—	—	—	36.0	40.1	56.7	71.5	102.4	132.9	163.2	8.5	50.0	5.88
0.0	0.0	0.75	0.80	0.84	0.87	0.92	0.95	0.98	0.99	1.04	1.07	1.13	1.18	1.22			

FOR BELT SIZES NOT SHOWN, INTERPOLATE FOR ADDITIONAL CENTER DISTANCE.

C Stock Drive Selection



V-BELT DRIVES

Speed Ratio	Sheave Combination		DriveN Speeds and HP Per Belt									Nominal Center Distance And Arc-Length Correction Factors					
			1750 RPM DriveR			1160 RPM DriveR			870 RPM DriveR			C/CX Belt Length Designation					
	DriveR P.D.	DriveN P.D.	DriveN RPM	HP Per Belt C	HP Per Belt CX	DriveN RPM	HP Per Belt C	HP Per Belt CX	DriveN RPM	HP Per Belt C	HP Per Belt CX	51	60	68	75	81	85
												—	—	—	—	—	—
6.00	5.0	30.0	292	4.54	8.48	193	3.91	6.44	145	3.35	5.21	—	—	—	—	—	—
6.00	6.0	36.0	292	8.90	12.99	193	7.08	9.68	145	5.84	7.74	—	—	—	—	—	—
6.25	8.0	50.0	280	16.89	21.37	186	13.13	15.89	139	10.64	12.64	—	—	—	—	—	—
6.29	7.0	44.0	278	13.02	17.29	185	10.16	12.83	138	8.27	10.22	—	—	—	—	—	—
6.55	5.5	36.0	267	6.75	10.76	177	5.51	8.07	133	4.60	6.48	—	—	—	—	—	—
ARC-LENGTH CORRECTION FACTOR												0.0	0.0	0.0	0.0	0.0	0.0
6.67	7.5	50.0	263	14.99	19.36	174	11.66	14.37	131	9.46	11.43	—	—	—	—	—	—
7.14	7.0	50.0	245	13.02	17.29	162	10.16	12.83	122	8.27	10.22	—	—	—	—	—	—
7.20	5.0	36.0	243	4.55	8.48	161	3.91	6.44	121	3.35	5.21	—	—	—	—	—	—
7.33	6.0	44.0	239	8.91	12.99	158	7.08	9.68	119	5.84	7.74	—	—	—	—	—	—
8.00	5.5	44.0	219	6.76	10.76	145	5.51	8.07	109	4.60	6.49	—	—	—	—	—	—
ARC-LENGTH CORRECTION FACTOR												0.0	0.0	0.0	0.0	0.0	0.0
8.33	6.0	50.0	210	8.91	12.99	139	7.09	9.68	104	5.84	7.74	—	—	—	—	—	—
8.80	5.0	44.0	199	4.55	8.48	132	3.91	6.44	99	3.35	5.21	—	—	—	—	—	—
9.09	5.5	50.0	193	6.76	10.76	128	5.51	8.07	96	4.60	6.49	—	—	—	—	—	—
10.00	5.0	50.0	175	4.55	8.48	116	3.91	6.44	87	3.35	5.21	—	—	—	—	—	—
ARC-LENGTH CORRECTION FACTOR												0.0	0.0	0.0	0.0	0.0	0.0

C = STANDARD V-BELT
 CX = COGGED/NOTCHED V-BELT
 + IF RIM SPEED EXCEEDS 6500 FEET PER MINUTE, CONSULT *Martin*.



Stock Drive Selection **C**

Nominal Center Distances And Arc-Length Correction Factor															Sheave Combination		Speed Ratio
C/CX Belt Length Designation															DriveR P.D.	DriveN P.D.	
90	96	105	112	120	128	144	158	173	180	210	240	300	360	420			
—	—	23.1	27.1	31.5	35.8	44.2	51.4	59.1	62.7	78.0	92.1	122.3	152.4	182.5	5.0	30.0	6.00
—	—	—	—	—	28.5	37.5	45.0	52.8	56.5	71.9	86.2	116.5	146.7	176.8	6.0	36.0	6.00
—	—	—	—	—	—	—	—	36.3	40.4	57.0	71.8	102.8	133.2	163.5	8.0	50.0	6.25
—	—	—	—	—	—	—	35.6	44.0	47.8	63.7	78.2	108.8	139.2	169.4	7.0	44.0	6.29
—	—	—	—	—	28.8	37.8	45.3	53.2	56.8	72.2	86.5	116.9	147.1	177.2	5.5	36.0	6.55
0.0	0.0	0.74	0.79	0.84	0.87	0.91	0.95	0.98	0.99	1.04	1.07	1.13	1.18	1.22			
—	—	—	—	—	—	—	—	36.6	40.7	57.4	72.2	103.1	133.6	163.9	7.5	50.0	6.67
—	—	—	—	—	—	—	—	36.9	41.1	57.7	72.5	103.4	134.0	164.3	7.0	50.0	7.14
—	—	—	—	—	29.1	38.1	45.6	53.5	57.1	72.6	86.9	117.2	147.4	177.6	5.0	36.0	7.20
—	—	—	—	—	—	—	36.2	44.6	48.5	64.4	78.9	109.5	133.9	170.1	6.0	44.0	7.33
—	—	—	—	—	—	—	36.5	45.0	48.8	64.7	79.2	109.9	140.3	170.5	5.5	44.0	8.00
0.0	0.0	0.0	0.0	0.0	0.78	0.87	0.91	0.95	0.96	1.02	1.06	1.12	1.17	1.21			
—	—	—	—	—	—	—	—	37.5	41.7	58.3	73.2	104.1	134.7	165.0	6.0	50.0	8.33
—	—	—	—	—	—	—	36.8	45.3	49.1	65.0	79.6	110.2	140.6	170.9	5.0	44.0	8.80
—	—	—	—	—	—	—	—	37.8	42.0	58.6	73.5	104.5	135.0	165.4	5.5	50.0	9.09
—	—	—	—	—	—	—	—	38.1	42.3	59.0	73.8	104.8	135.4	165.7	5.0	50.0	10.00
0.0	0.0	0.0	0.0	0.0	0.0	0.0	0.0	0.82	0.91	0.99	1.03	1.10	1.16	1.20			

FOR BELT SIZES NOT SHOWN, INTERPOLATE FOR ADDITIONAL CENTER DISTANCE.

V-BELT DRIVES

D Stock Drive Selection



V-BELT DRIVES

Speed Ratio	Sheave Combination		DriveN Speeds and HP Per Belt						Nominal Center Distance And Arc-Length Correction Factors								
			1160 RPM DriveR		870 RPM DriveR		700 RPM DriveR		D Belt Length Designation								
	DriveR P.D.	DriveN P.D.	DriveN RPM	HP Per Belt D	DriveN RPM	HP Per Belt D	DriveN RPM	HP Per Belt D	120	128	144	158	162	173	180	195	210
1.00	12.0	12.0	1160	25.69	870	22.20	700	19.32	42.8	46.8	54.8	61.8	63.8	69.3	72.8	80.3	87.8
1.00	13.0	13.0	1160	30.21	870	26.10	700	22.67	41.2	45.2	53.2	60.2	62.2	67.7	71.2	78.7	86.2
1.00	13.5	13.5	1160	32.39	870	28.01	700	24.32	40.4	44.4	52.4	59.4	61.4	66.9	70.4	77.9	85.4
1.00	14.0	14.0	1160	34.50	870	29.89	700	25.95	39.7	43.7	51.7	58.7	60.7	66.2	69.7	77.2	84.7
1.00	14.5	14.5	1160	36.55	870	31.74	700	27.57	38.9	42.9	50.9	57.9	59.9	65.4	68.9	76.4	83.9
ARC-LENGTH CORRECTION FACTOR									0.86	0.88	0.90	0.92	0.92	0.94	0.94	0.96	0.98
1.00	15.0	15.0	1160	38.54	870	33.56	700	29.17	38.1	42.1	50.1	57.1	59.1	64.6	68.1	75.6	83.1
1.00	15.5	15.5	1160	40.46	870	35.34	700	30.75	37.3	41.3	49.3	56.3	58.3	63.8	67.3	74.8	82.3
1.00	16.0	16.0	1160	42.32	870	37.10	700	32.31	36.5	40.5	48.5	55.5	57.5	63.0	66.5	74.0	81.5
1.00	18.0	18.0	1160	49.05	870	43.80	700	38.36	33.4	37.4	45.4	52.4	54.4	59.9	63.4	70.9	78.4
1.00	20.0	20.0	1160	54.59	870	49.95	700	44.11	30.2	34.2	42.2	49.2	51.2	56.7	60.2	67.7	75.2
ARC-LENGTH CORRECTION FACTOR									0.86	0.88	0.90	0.92	0.92	0.94	0.94	0.96	0.98
1.00	22.0	22.0	+	+	870	55.52	700	49.52	27.1	31.1	39.1	46.1	48.1	53.6	57.1	64.6	72.1
1.03	14.5	15.0	1121	37.19	841	32.21	677	27.95	38.5	42.5	50.5	57.5	59.5	65.0	68.5	76.0	83.5
1.03	15.0	15.5	1123	39.17	842	34.03	677	29.55	37.7	41.7	49.7	56.7	58.7	64.2	67.7	75.2	82.7
1.03	15.5	16.0	1124	41.10	843	35.82	678	31.13	36.9	40.9	48.9	55.9	57.9	63.4	66.9	74.4	81.9
1.04	13.0	13.5	1117	31.03	838	26.72	674	23.17	40.8	44.8	52.8	59.8	61.8	67.3	70.8	78.3	85.8
ARC-LENGTH CORRECTION FACTOR									0.86	0.88	0.90	0.92	0.92	0.94	0.94	0.96	0.98
1.04	13.5	14.0	1119	33.21	839	28.63	675	24.82	40.1	44.1	52.1	59.1	61.1	66.6	70.1	77.6	85.1
1.04	14.0	14.5	1120	35.32	840	30.51	676	26.45	39.3	43.3	51.3	58.3	60.3	65.8	69.3	76.8	84.3
1.07	13.5	14.5	1080	33.72	810	29.01	652	25.13	39.7	43.7	51.7	58.7	60.7	66.2	69.7	77.2	84.7
1.07	14.0	15.0	1083	35.83	812	30.89	653	26.76	38.9	42.9	50.9	57.9	59.9	65.4	68.9	76.4	83.9
1.07	14.5	15.5	1085	37.89	814	32.74	655	28.37	38.1	42.1	50.1	57.1	59.1	64.6	68.1	75.6	83.1
ARC-LENGTH CORRECTION FACTOR									0.86	0.88	0.90	0.92	0.92	0.94	0.94	0.96	0.97
1.07	15.0	16.0	1088	39.88	816	34.56	656	29.97	37.3	41.3	49.3	56.3	58.3	63.8	67.3	74.8	82.3
1.08	12.0	13.0	1071	27.17	803	23.32	646	20.21	42.0	46.0	54.0	61.0	63.0	68.5	72.0	79.5	87.0
1.08	13.0	14.0	1077	31.70	808	27.22	650	23.57	40.4	44.4	52.4	59.4	61.4	66.9	70.4	77.9	85.4
1.10	14.5	16.0	1051	38.32	788	33.06	634	28.64	37.7	41.7	49.7	56.7	58.7	64.2	67.7	75.2	82.7
1.10	20.0	22.0	1055	56.36	791	51.28	636	45.18	28.6	32.6	40.6	47.6	49.6	55.1	58.6	66.1	73.6
ARC-LENGTH CORRECTION FACTOR									0.86	0.87	0.90	0.92	0.92	0.93	0.94	0.96	0.97
1.11	13.5	15.0	1044	34.29	783	29.44	630	25.47	39.3	43.3	51.3	58.3	60.3	65.8	69.3	76.8	84.3
1.11	14.0	15.5	1048	36.40	786	31.31	632	27.10	38.5	42.5	50.5	57.5	59.5	65.0	68.5	76.0	83.5
1.11	18.0	20.0	1044	50.95	783	45.22	630	39.51	31.8	35.8	43.8	50.8	52.8	58.3	61.8	69.3	76.8
1.12	13.0	14.5	1040	32.24	780	27.62	628	23.89	40.0	44.0	52.0	59.0	61.0	66.5	70.0	77.5	85.0
1.13	12.0	13.5	1031	27.83	773	23.81	622	20.61	41.6	45.6	53.6	60.6	62.6	68.1	71.6	79.1	86.6
ARC-LENGTH CORRECTION FACTOR									0.86	0.87	0.90	0.92	0.92	0.93	0.94	0.96	0.97
1.13	16.0	18.0	1031	44.46	773	38.70	622	33.60	34.9	38.9	46.9	53.9	55.9	61.4	64.9	72.4	79.9
1.14	14.0	16.0	1015	36.75	761	31.58	613	27.31	38.1	42.1	50.1	57.1	59.1	64.6	68.1	75.6	83.1
1.15	13.0	15.0	1005	32.57	754	27.87	607	24.09	39.6	43.6	51.6	58.6	60.6	66.1	69.6	77.1	84.6
1.15	13.5	15.5	1010	34.74	758	29.78	610	25.74	38.9	42.9	50.9	57.9	59.9	65.4	68.9	76.4	83.9
1.16	15.5	18.0	999	42.92	749	37.19	603	32.23	35.3	39.3	47.3	54.3	56.3	61.8	65.3	72.8	80.3
ARC-LENGTH CORRECTION FACTOR									0.86	0.87	0.90	0.91	0.92	0.93	0.94	0.96	0.97
1.17	12.0	14.0	994	28.24	746	24.12	600	20.86	41.2	45.2	53.2	60.2	62.2	67.7	71.2	78.7	86.2
1.19	13.0	15.5	973	32.94	730	28.15	587	24.32	39.2	43.2	51.2	58.2	60.2	65.7	69.2	76.7	84.2
1.19	13.5	16.0	979	35.12	734	30.06	591	25.97	38.5	42.5	50.5	57.5	59.5	65.0	68.5	76.0	83.5
1.20	15.0	18.0	967	41.35	725	35.66	583	30.86	35.7	39.7	47.7	54.7	56.7	62.2	65.7	73.2	80.7
1.21	12.0	14.5	960	28.57	720	24.37	579	21.06	40.8	44.8	52.8	59.8	61.8	67.3	70.8	78.3	85.8
ARC-LENGTH CORRECTION FACTOR									0.86	0.87	0.90	0.91	0.92	0.93	0.94	0.96	0.97
1.22	18.0	22.0	949	52.01	712	46.02	573	40.15	30.2	34.2	42.2	49.2	51.2	56.7	60.2	67.7	75.2
1.23	13.0	16.0	943	33.24	707	28.38	569	24.50	38.8	42.8	50.8	57.8	59.8	65.3	68.8	76.3	83.8
1.23	22.0	27.0	+	+	709	57.80	570	51.35	-	-	35.1	42.1	44.1	49.6	53.1	60.6	68.1
1.24	14.5	18.0	934	39.65	701	34.06	564	29.44	36.1	40.1	48.1	55.1	57.1	62.6	66.1	73.6	81.1
1.25	12.0	15.0	928	28.85	696	24.57	560	21.22	40.4	44.4	52.4	59.4	61.4	66.9	70.4	77.9	85.4
ARC-LENGTH CORRECTION FACTOR									0.85	0.86	0.89	0.91	0.91	0.93	0.94	0.95	0.97
1.25	16.0	20.0	928	45.48	696	39.47	560	34.21	33.3	37.3	45.3	52.3	54.3	59.8	63.3	70.8	78.3
1.29	12.0	15.5	898	29.07	674	24.74	542	21.36	40.0	44.0	52.0	59.0	61.0	66.5	70.0	77.5	85.0
1.29	14.0	18.0	902	37.89	677	32.43	544	28.00	36.5	40.5	48.5	55.5	57.5	63.0	66.5	74.0	81.5
1.29	15.5	20.0	899	43.85	674	37.88	543	32.79	33.7	37.7	45.7	52.7	54.7	60.2	63.7	71.2	78.7
1.33	12.0	16.0	870	29.26	653	24.88	525	21.47	39.6	43.6	51.6	58.6	60.6	66.1	69.6	77.1	84.6
ARC-LENGTH CORRECTION FACTOR									0.85	0.86	0.89	0.91	0.91	0.93	0.94	0.95	0.97

D = STANDARD V-BELT
 + IF RIM SPEED EXCEEDS 6500 FEET PER MINUTE, CONSULT *Martin*.



Stock Drive Selection **D**

V-BELT DRIVES

Nominal Center Distances And Arc-Length Correction Factor										Sheave Combination		Speed Ratio
D Belt Length Designation										DriveR P.D.	DriveN P.D.	
240	270	300	330	360	390	420	480	540	600			
101.6	116.6	131.6	146.6	161.6	176.6	191.6	221.6	251.6	281.6	12.0	12.0	1.00
100.0	115.0	130.0	145.0	160.0	175.0	190.0	220.0	250.0	280.0	13.0	13.0	1.00
99.2	114.2	129.2	144.2	159.2	174.2	189.2	219.2	249.2	279.2	13.5	13.5	1.00
98.4	113.4	128.4	143.4	158.4	173.4	188.4	218.4	248.4	278.4	14.0	14.0	1.00
97.6	112.6	127.6	142.6	157.6	172.6	187.6	217.6	247.6	277.6	14.5	14.5	1.00
1.00	1.02	1.05	1.06	1.08	1.10	1.11	1.14	1.17	1.19			
96.8	111.8	126.8	141.8	156.8	171.8	186.8	216.8	246.8	276.8	15.0	15.0	1.00
96.1	111.1	126.1	141.1	156.1	171.1	186.1	216.1	246.1	276.1	15.5	15.5	1.00
95.3	110.3	125.3	140.3	155.3	170.3	185.3	215.3	245.3	275.3	16.0	16.0	1.00
92.1	107.1	122.1	137.1	152.1	167.1	182.1	212.1	242.1	272.1	18.0	18.0	1.00
89.0	104.0	119.0	134.0	149.0	164.0	179.0	209.0	239.0	269.0	20.0	20.0	1.00
1.00	1.02	1.05	1.06	1.08	1.10	1.11	1.14	1.17	1.19			
85.8	100.8	115.8	130.8	145.8	160.8	175.8	205.8	235.8	265.8	22.0	22.0	1.00
97.2	112.2	127.2	142.2	157.2	172.2	187.2	217.2	247.2	277.2	14.5	15.0	1.03
96.4	111.4	126.4	141.4	156.4	171.4	186.4	216.4	246.4	276.4	15.0	15.5	1.03
95.7	110.7	125.7	140.7	155.7	170.7	185.7	215.7	245.7	275.7	15.5	16.0	1.03
99.6	114.6	129.6	144.6	159.6	174.6	189.6	219.6	249.6	279.6	13.0	13.5	1.04
1.00	1.02	1.05	1.06	1.08	1.10	1.11	1.14	1.17	1.19			
98.8	113.8	128.8	143.8	158.8	173.8	188.8	218.8	248.8	278.8	13.5	14.0	1.04
98.0	113.0	128.0	143.0	158.0	173.0	188.0	218.0	248.0	278.0	14.0	14.5	1.04
98.4	113.4	128.4	143.4	158.4	173.4	188.4	218.4	248.4	278.4	13.5	14.5	1.07
97.6	112.6	127.6	142.6	157.6	172.6	187.6	217.6	247.6	277.6	14.0	15.0	1.07
96.8	111.8	126.8	141.8	156.8	171.8	186.8	216.8	246.8	276.8	14.5	15.5	1.07
1.00	1.02	1.04	1.06	1.08	1.10	1.11	1.14	1.16	1.19			
96.1	111.1	126.1	141.1	156.1	171.1	186.1	216.1	246.1	276.1	15.0	16.0	1.07
100.8	115.8	130.8	145.8	160.8	175.8	190.8	220.8	250.8	280.8	12.0	13.0	1.08
99.2	114.2	129.2	144.2	159.2	174.2	189.2	219.2	249.2	279.2	13.0	14.0	1.08
96.4	111.4	126.4	141.4	156.4	171.4	186.4	216.4	246.4	276.4	14.5	16.0	1.10
87.4	102.4	117.4	132.4	147.4	162.4	177.4	207.4	237.4	267.4	20.0	22.0	1.10
1.00	1.02	1.04	1.06	1.08	1.10	1.11	1.14	1.16	1.19			
98.0	113.0	128.0	143.0	158.0	173.0	188.0	218.0	248.0	278.0	13.5	15.0	1.11
97.2	112.2	127.2	142.2	157.2	172.2	187.2	217.2	247.2	277.2	14.0	15.5	1.11
90.5	105.6	120.6	135.6	150.6	165.6	180.6	210.6	240.6	270.6	18.0	20.0	1.11
98.8	113.8	128.8	143.8	158.8	173.8	188.8	218.8	248.8	278.8	13.0	14.5	1.12
100.4	115.4	130.4	145.4	160.4	175.4	190.4	220.4	250.4	280.4	12.0	13.5	1.13
1.00	1.02	1.04	1.06	1.08	1.10	1.11	1.14	1.16	1.19			
93.7	108.7	123.7	138.7	153.7	168.7	183.7	213.7	243.7	273.7	16.0	18.0	1.13
96.8	111.8	126.8	141.8	156.8	171.8	186.8	216.8	246.8	276.8	14.0	16.0	1.14
98.4	113.4	128.4	143.4	158.4	173.4	188.4	218.4	248.4	278.4	13.0	15.0	1.15
97.6	112.6	127.6	142.6	157.6	172.6	187.6	217.6	247.6	277.6	13.5	15.5	1.15
94.1	109.1	124.1	139.1	154.1	169.1	184.1	214.1	244.1	274.1	15.5	18.0	1.16
1.00	1.02	1.04	1.06	1.08	1.10	1.11	1.14	1.16	1.19			
100.0	115.0	130.0	145.0	160.0	175.0	190.0	220.0	250.0	280.0	12.0	14.0	1.17
98.0	113.0	128.0	143.0	158.0	173.0	188.0	218.0	248.0	278.0	13.0	15.5	1.19
97.2	112.2	127.2	142.2	157.2	172.2	187.2	217.2	247.2	277.2	13.5	16.0	1.19
94.5	109.5	124.5	139.5	154.5	169.5	184.5	214.5	244.5	274.5	15.0	18.0	1.20
99.6	114.6	129.6	144.6	159.6	174.6	189.6	219.6	249.6	279.6	12.0	14.5	1.21
1.00	1.02	1.04	1.06	1.08	1.10	1.11	1.14	1.16	1.19			
89.0	104.0	119.0	134.0	149.0	164.0	179.0	209.0	239.0	269.0	18.0	22.0	1.22
97.6	112.6	127.6	142.6	157.6	172.6	187.6	217.6	247.6	277.6	13.0	16.0	1.23
81.9	96.9	111.9	126.9	141.9	156.9	171.9	201.9	231.9	261.9	22.0	27.0	1.23
94.9	109.9	124.9	139.9	154.9	169.9	184.9	214.9	244.9	274.9	14.5	18.0	1.24
99.2	114.2	129.2	144.2	159.2	174.2	189.2	219.2	249.2	279.2	12.0	15.0	1.25
0.99	1.02	1.04	1.06	1.08	1.10	1.11	1.14	1.16	1.18			
92.1	107.1	122.1	137.1	152.1	167.1	182.1	212.1	242.1	272.1	16.0	20.0	1.25
98.8	113.8	128.8	143.8	158.8	173.8	188.8	218.8	248.8	278.8	12.0	15.5	1.29
95.2	110.2	125.2	140.2	155.2	170.2	185.2	215.2	245.2	275.2	14.0	18.0	1.29
92.5	107.5	122.5	137.5	152.5	167.5	182.5	212.5	242.5	272.5	15.5	20.0	1.29
98.4	113.4	128.4	143.4	158.4	173.4	188.4	218.4	248.4	278.4	12.0	16.0	1.33
0.99	1.02	1.04	1.06	1.08	1.10	1.11	1.14	1.16	1.18			

FOR BELT SIZES NOT SHOWN, INTERPOLATE FOR ADDITIONAL CENTER DISTANCE.

D Stock Drive Selection



V-BELT DRIVES

Speed Ratio	Sheave Combination		DriveN Speeds and HP Per Belt						Nominal Center Distance And Arc-Length Correction Factors								
			1160 RPM DriveR		870 RPM DriveR		700 RPM DriveR		D Belt Length Designation								
	DriveR P.D.	DriveN P.D.	DriveN RPM	HP Per Belt D	DriveN RPM	HP Per Belt D	DriveN RPM	HP Per Belt D	120	128	144	158	162	173	180	195	210
1.33	13.5	18.0	870	35.96	653	30.96	525	26.48	36.8	40.8	48.9	55.9	57.9	63.4	66.9	74.4	81.9
1.33	15.0	20.0	870	42.11	653	36.23	525	31.32	34.1	38.1	46.1	53.1	55.1	60.6	64.1	71.6	79.1
1.35	20.0	27.0	859	58.24	644	52.69	519	46.31	—	28.5	36.6	43.6	45.6	51.1	54.6	62.1	69.6
1.38	13.0	18.0	838	33.97	628	28.92	506	24.94	37.2	41.2	49.2	56.2	58.2	63.8	67.3	74.8	82.3
1.38	14.5	20.0	841	40.31	631	34.56	508	29.84	34.4	38.5	46.5	53.5	55.5	61.0	64.5	72.0	79.5
ARC-LENGTH CORRECTION FACTOR									0.85	0.86	0.89	0.91	0.91	0.93	0.94	0.95	0.97
1.38	16.0	22.0	844	46.08	633	39.92	509	34.58	31.7	35.7	43.7	50.7	52.7	58.2	61.7	69.2	76.7
1.42	15.5	22.0	817	44.35	613	38.26	493	33.06	32.0	36.1	44.1	51.1	53.1	58.6	62.1	69.6	77.1
1.43	14.0	20.0	812	38.41	609	32.82	490	28.31	34.8	38.8	46.9	53.9	55.9	61.4	64.9	72.4	79.9
1.47	15.0	22.0	791	42.55	593	36.56	477	31.59	32.4	36.4	44.5	51.5	53.5	59.0	62.5	70.0	77.5
1.48	13.5	20.0	783	36.42	587	31.04	473	26.75	35.2	39.2	47.2	54.2	56.2	61.8	65.3	72.8	80.3
ARC-LENGTH CORRECTION FACTOR									0.84	0.86	0.88	0.90	0.91	0.92	0.93	0.95	0.97
1.50	12.0	18.0	773	29.76	580	25.26	467	21.77	38.0	42.0	50.0	57.0	59.0	64.5	68.0	75.5	83.0
1.50	18.0	27.0	773	53.13	580	46.86	467	40.82	25.9	30.0	38.0	45.1	47.1	52.6	56.1	63.6	71.2
1.50	22.0	33.0	+	+	580	58.58	467	51.98	—	—	—	37.0	39.1	44.6	48.1	55.7	63.2
1.52	14.5	22.0	765	40.67	573	34.82	461	30.05	32.8	36.8	44.8	51.8	53.9	59.4	62.9	70.4	77.9
1.54	13.0	20.0	754	34.36	566	29.22	455	25.17	35.6	39.6	47.6	54.6	56.6	62.1	65.6	73.1	80.7
ARC-LENGTH CORRECTION FACTOR									0.85	0.86	0.89	0.91	0.91	0.93	0.93	0.95	0.97
1.57	14.0	22.0	738	38.70	554	33.04	445	28.49	33.1	37.2	45.2	52.2	54.2	59.7	63.2	70.8	78.3
1.63	13.5	22.0	712	36.67	534	31.22	430	26.91	33.5	37.5	45.6	52.6	54.6	60.1	63.6	71.1	78.7
1.65	20.0	33.0	703	58.90	527	53.18	424	46.71	—	—	31.4	38.5	40.5	46.1	49.6	57.2	64.7
1.67	12.0	20.0	696	30.02	522	25.45	420	21.93	36.3	40.3	48.4	55.4	57.4	62.9	66.4	73.9	81.4
1.69	13.0	22.0	685	34.56	514	29.37	414	25.30	33.9	37.9	45.9	53.0	55.0	60.5	64.0	71.5	79.0
ARC-LENGTH CORRECTION FACTOR									0.84	0.85	0.88	0.90	0.91	0.92	0.93	0.95	0.96
1.69	16.0	27.0	687	46.67	516	40.36	415	34.93	27.3	31.4	39.5	46.6	48.6	54.1	57.6	65.1	72.7
1.74	15.5	27.0	666	44.86	499	38.64	402	33.40	27.7	31.7	39.9	46.9	48.9	54.5	58.0	65.5	73.0
1.80	15.0	27.0	644	42.99	483	36.89	389	31.85	28.0	32.1	40.2	47.3	49.3	54.8	58.4	65.9	73.4
1.82	22.0	40.0	+	+	479	58.87	385	52.21	—	—	—	—	—	38.4	42.0	49.6	57.2
1.83	12.0	22.0	633	30.15	475	25.55	382	22.01	34.6	38.6	46.7	53.7	55.7	61.2	64.8	72.3	79.8
ARC-LENGTH CORRECTION FACTOR									0.81	0.83	0.87	0.89	0.90	0.91	0.92	0.94	0.96
1.83	18.0	33.0	633	53.52	475	47.15	382	41.06	—	—	32.7	39.9	41.9	47.5	51.0	58.6	66.2
1.86	14.5	27.0	623	41.04	467	35.10	376	30.28	28.4	32.5	40.6	47.6	49.7	55.2	58.7	66.3	73.8
1.93	14.0	27.0	601	39.03	451	33.28	363	28.68	28.7	32.8	40.9	48.0	50.0	55.6	59.1	66.6	74.2
2.00	13.5	27.0	580	36.94	435	31.43	350	27.07	29.1	33.2	41.3	48.4	50.4	55.9	59.5	67.0	74.5
2.00	20.0	40.0	580	59.15	435	53.37	350	46.86	—	—	—	—	34.1	39.8	43.4	51.0	58.7
ARC-LENGTH CORRECTION FACTOR									0.81	0.83	0.86	0.89	0.89	0.91	0.92	0.94	0.95
2.06	16.0	33.0	562	46.90	422	40.53	339	35.07	—	—	34.1	41.3	43.3	48.9	52.5	60.1	67.6
2.08	13.0	27.0	559	34.80	419	29.54	337	25.44	29.4	33.5	41.6	48.7	50.8	56.3	59.8	67.4	74.9
2.13	15.5	33.0	545	45.07	409	38.79	329	33.52	—	—	34.4	41.6	43.7	49.3	52.8	60.4	68.0
2.18	22.0	48.0	+	+	399	58.98	321	52.31	—	—	—	—	—	—	—	42.2	50.0
2.20	15.0	33.0	527	43.16	395	37.02	318	31.95	—	—	34.8	42.0	44.0	49.6	53.2	60.8	68.4
ARC-LENGTH CORRECTION FACTOR									0.80	0.82	0.86	0.88	0.89	0.90	0.91	0.93	0.95
2.22	18.0	40.0	522	53.68	392	47.27	315	41.46	—	—	—	33.3	35.4	41.1	44.7	52.4	60.1
2.25	12.0	27.0	516	30.32	387	25.68	311	22.11	30.1	34.2	42.4	49.5	51.5	57.0	60.6	68.1	75.6
2.28	14.5	33.0	510	41.19	382	35.22	308	30.37	—	—	35.1	42.3	44.4	50.0	53.5	61.1	68.7
2.36	14.0	33.0	492	39.16	369	33.38	297	28.76	—	27.1	35.5	42.7	44.7	50.3	53.9	61.5	69.1
2.40	20.0	48.0	483	59.25	363	53.45	292	46.92	—	—	—	—	—	—	—	43.5	51.3
ARC-LENGTH CORRECTION FACTOR									0.80	0.82	0.86	0.88	0.89	0.90	0.91	0.93	0.95
2.44	13.5	33.0	475	37.06	356	31.51	286	27.14	—	27.4	35.8	43.0	45.1	50.7	54.3	61.9	69.4
2.50	16.0	40.0	464	47.00	348	40.61	280	35.13	—	—	—	34.6	36.7	42.5	46.1	53.8	61.5
2.54	13.0	33.0	457	34.89	343	29.62	276	25.49	—	27.7	36.1	43.4	45.4	51.0	54.6	62.2	69.8
2.58	15.5	40.0	450	45.15	337	38.86	271	33.57	—	—	—	34.9	37.0	42.8	46.4	54.2	61.8
2.64	22.0	58.0	+	+	330	59.04	266	52.35	—	—	—	—	—	—	—	—	—
ARC-LENGTH CORRECTION FACTOR									0.0	0.78	0.83	0.86	0.87	0.89	0.90	0.92	0.94
2.67	15.0	40.0	435	43.24	326	37.08	263	32.00	—	—	—	35.2	37.4	43.1	46.8	54.5	62.2
2.67	18.0	48.0	435	53.75	326	47.32	263	41.20	—	—	—	—	—	—	36.8	44.8	52.7
2.75	12.0	33.0	422	30.39	316	25.73	255	22.15	—	28.4	36.8	44.1	46.1	51.7	55.3	62.9	70.5
2.76	14.5	40.0	421	41.26	315	35.27	254	30.41	—	—	—	35.6	37.7	43.5	47.1	54.9	62.5
2.86	14.0	40.0	406	39.22	305	33.43	245	28.80	—	—	—	35.9	38.0	43.8	47.5	55.2	62.9
ARC-LENGTH CORRECTION FACTOR									0.0	0.77	0.82	0.85	0.86	0.88	0.89	0.92	0.94

D = STANDARD V-BELT
 + IF RIM SPEED EXCEEDS 6500 FEET PER MINUTE, CONSULT *Martin*.



Stock Drive Selection **D**

Nominal Center Distances And Arc-Length Correction Factor										Sheave Combination		Speed Ratio
D Belt Length Designation										DriveR P.D	DriveN P.D	
240	270	300	330	360	390	420	480	540	600			
95.6	110.6	125.6	140.6	155.6	170.6	185.6	215.6	245.6	275.7	13.5	18.0	1.33
92.9	107.9	122.9	137.9	152.9	167.9	182.9	212.9	242.9	272.9	15.0	20.0	1.33
83.4	98.4	113.4	128.4	143.4	158.4	173.5	203.5	233.5	263.5	20.0	27.0	1.35
96.0	111.0	126.0	141.0	156.0	171.0	186.0	216.0	246.0	276.0	13.0	18.0	1.38
93.3	108.3	123.3	138.3	153.3	168.3	183.3	213.3	243.3	273.3	14.5	20.0	1.38
0.99	1.02	1.04	1.06	1.08	1.10	1.11	1.14	1.14	1.16	1.18		
90.5	105.5	120.5	135.5	150.5	165.5	180.5	210.5	240.5	270.5	16.0	22.0	1.38
90.9	105.9	120.9	135.9	150.9	165.9	180.9	210.9	240.9	270.9	15.5	22.0	1.42
93.6	108.7	123.7	138.7	153.7	168.7	183.7	213.7	243.7	273.7	14.0	20.0	1.43
91.3	106.3	121.3	136.3	151.3	166.3	181.3	211.3	241.3	271.3	15.0	22.0	1.47
94.0	109.0	124.0	139.1	154.1	169.1	184.1	214.1	244.1	274.1	13.5	20.0	1.48
0.99	1.02	1.04	1.06	1.08	1.09	1.11	1.14	1.14	1.16	1.18		
96.8	111.8	126.8	141.8	156.8	171.8	186.8	216.8	246.8	276.8	12.0	18.0	1.50
84.9	100.0	115.0	130.0	145.0	160.0	175.0	205.0	235.0	265.0	18.0	27.0	1.50
77.0	92.0	107.1	122.1	137.1	152.1	167.1	197.1	227.1	257.1	22.0	33.0	1.50
91.7	106.7	121.7	136.7	151.7	166.7	181.7	211.7	241.7	271.7	14.5	22.0	1.52
94.4	109.4	124.4	139.4	154.4	169.4	184.4	214.5	244.5	274.5	13.0	20.0	1.54
0.99	1.02	1.04	1.06	1.08	1.09	1.11	1.14	1.14	1.16	1.18		
92.0	107.1	122.1	137.1	152.1	167.1	182.1	212.1	242.1	272.1	14.0	22.0	1.57
92.4	107.4	122.4	137.5	152.5	167.5	182.5	212.5	242.5	272.5	13.5	22.0	1.63
78.5	93.5	108.6	123.6	138.6	153.6	168.6	198.7	228.7	258.7	20.0	33.0	1.65
95.2	110.2	125.2	140.2	155.2	170.2	185.2	215.2	245.2	275.2	12.0	20.0	1.67
92.8	107.8	122.8	137.8	152.8	167.9	182.9	212.9	242.9	272.9	13.0	22.0	1.69
0.99	1.01	1.04	1.06	1.08	1.09	1.11	1.14	1.14	1.16	1.18		
86.5	101.5	116.5	131.5	146.5	161.5	176.5	206.6	236.6	266.6	16.0	27.0	1.69
86.8	101.9	116.9	131.9	146.9	161.9	176.9	206.9	237.0	267.0	15.5	27.0	1.74
87.2	102.2	117.3	132.3	147.3	162.3	177.3	207.3	237.3	267.3	15.0	27.0	1.80
71.1	86.2	101.3	116.4	131.4	146.4	161.5	191.5	221.5	251.5	22.0	40.0	1.82
93.6	108.6	123.6	138.6	153.6	168.6	183.6	213.6	243.6	273.7	12.0	22.0	1.83
0.99	1.01	1.03	1.05	1.07	1.09	1.10	1.13	1.16	1.18			
80.0	95.0	110.1	125.1	140.1	155.2	170.2	200.2	230.2	260.2	18.0	33.0	1.83
87.6	102.6	117.6	132.7	147.7	162.7	177.7	207.7	237.7	267.7	14.5	27.0	1.86
88.0	103.0	118.0	133.0	148.1	163.1	178.1	208.1	238.1	268.1	14.0	27.0	1.93
88.3	103.4	118.4	133.4	148.4	163.5	178.5	208.5	238.5	268.5	13.5	27.0	2.00
72.6	87.7	102.8	117.9	132.9	147.9	163.0	193.0	223.1	253.1	20.0	40.0	2.00
0.98	1.01	1.03	1.05	1.07	1.09	1.10	1.13	1.16	1.18			
81.5	96.5	111.6	126.6	141.7	156.7	171.7	201.7	231.8	261.8	16.0	33.0	2.06
88.7	103.7	118.8	133.8	148.8	163.8	178.8	208.9	238.9	268.9	13.0	27.0	2.08
81.8	96.9	112.0	127.0	142.0	157.1	172.1	202.1	232.1	262.2	15.5	33.0	2.13
64.1	79.4	94.5	109.7	124.7	139.8	154.9	185.0	215.0	245.1	22.0	48.0	2.18
82.2	97.3	112.3	127.4	142.4	157.4	172.5	202.5	232.5	262.5	15.0	33.0	2.20
0.98	1.01	1.03	1.05	1.07	1.09	1.10	1.13	1.16	1.18			
74.0	89.2	104.3	119.3	134.4	149.4	164.5	194.5	224.6	254.6	18.0	40.0	2.22
89.5	104.5	119.5	134.6	149.6	164.6	179.6	209.6	239.7	269.7	12.0	27.0	2.25
82.6	97.7	112.7	127.8	142.8	157.8	172.8	202.9	232.9	262.9	14.5	33.0	2.28
82.9	98.0	113.1	128.1	143.2	158.2	173.2	203.3	233.3	263.3	14.0	33.0	2.36
65.5	80.8	96.0	111.1	126.2	141.3	156.4	186.5	216.5	246.6	20.0	48.0	2.40
0.98	1.00	1.03	1.05	1.07	1.09	1.10	1.13	1.16	1.18			
83.3	98.4	113.5	128.5	143.5	158.6	173.6	203.6	233.7	263.7	13.5	33.0	2.44
75.5	90.6	105.7	120.8	135.9	150.9	166.0	196.1	226.1	256.1	16.0	40.0	2.50
83.7	98.8	113.8	128.9	143.9	159.0	174.0	204.0	234.1	264.1	13.0	33.0	2.54
75.8	91.0	106.1	121.2	136.3	151.3	166.4	196.4	226.5	256.5	15.5	40.0	2.58
54.6	70.3	85.7	101.0	116.2	131.3	146.5	176.7	206.8	236.9	22.0	58.0	2.64
0.97	1.00	1.02	1.04	1.06	1.08	1.10	1.13	1.15	1.18			
76.2	91.3	106.5	121.6	136.6	151.7	166.7	196.8	226.9	256.9	15.0	40.0	2.67
66.9	82.2	97.4	112.6	127.7	142.8	157.9	188.0	218.0	248.1	18.0	48.0	2.67
84.4	99.5	114.6	129.6	144.7	159.7	174.7	204.8	234.8	264.8	12.0	33.0	2.75
76.5	91.7	106.8	121.9	137.0	152.1	167.1	197.2	227.2	257.3	14.5	40.0	2.76
76.9	92.1	107.2	122.3	137.4	152.4	167.5	197.6	227.6	257.7	14.0	40.0	2.86
0.97	0.99	1.02	1.04	1.06	1.08	1.10	1.13	1.15	1.17			

FOR BELT SIZES NOT SHOWN, INTERPOLATE FOR ADDITIONAL CENTER DISTANCE.

V-BELT DRIVES

D Stock Drive Selection



V-BELT DRIVES

Speed Ratio	Sheave Combination		DriveN Speeds and HP Per Belt						Nominal Center Distance And Arc-Length Correction Factors								
			1160 RPM DriveR		870 RPM DriveR		700 RPM DriveR		D/DX Belt Length Designation								
	DriveR P.D.	DriveN P.D.	DriveN RPM	HP Per Belt D	DriveN RPM	HP Per Belt D	DriveN RPM	HP Per Belt D	120	128	144	158	162	173	180	195	210
2.90	20.0	58.0	400	59.31	300	53.49	241	46.95	—	—	—	—	—	—	—	—	—
2.96	13.5	40.0	392	37.11	294	31.55	236	27.17	—	—	—	36.2	38.3	44.1	47.8	55.6	63.2
3.00	16.0	48.0	387	47.05	290	40.64	233	35.16	—	—	—	—	—	—	38.0	46.1	54.0
3.08	13.0	40.0	377	34.94	283	29.65	228	25.52	—	—	—	36.5	38.7	44.5	48.1	55.9	63.6
3.10	15.5	48.0	375	45.19	281	38.89	226	33.60	—	—	—	—	—	—	38.3	46.4	54.3
ARC-LENGTH CORRECTION FACTOR									0.0	0.0	0.0	0.81	0.82	0.85	0.87	0.89	0.92
3.20	15.0	48.0	363	43.28	272	37.11	219	32.02	—	—	—	—	—	—	38.6	46.8	54.7
3.22	18.0	58.0	360	53.79	270	47.35	217	41.22	—	—	—	—	—	—	—	—	42.2
3.31	14.5	48.0	350	41.29	263	35.29	211	30.43	—	—	—	—	—	35.1	39.0	47.1	55.0
3.33	12.0	40.0	348	30.43	261	25.76	210	22.18	—	—	29.5	37.2	39.3	45.1	48.8	56.6	64.3
3.43	14.0	48.0	338	39.25	254	33.45	204	28.82	—	—	—	—	—	35.4	39.3	47.4	55.3
ARC-LENGTH CORRECTION FACTOR									0.0	0.0	0.75	0.81	0.82	0.85	0.86	0.89	0.91
3.56	13.5	48.0	326	37.14	245	31.57	197	27.19	—	—	—	—	—	35.7	39.6	47.7	55.7
3.63	16.0	58.0	320	47.07	240	40.66	193	35.17	—	—	—	—	—	—	—	—	43.5
3.69	13.0	48.0	314	34.96	236	29.67	190	25.54	—	—	—	—	—	36.0	39.9	48.1	56.0
3.74	15.5	58.0	310	45.22	233	38.91	187	33.62	—	—	—	—	—	—	—	—	43.8
3.87	15.0	58.0	300	43.30	225	37.12	181	32.04	—	—	—	—	—	—	—	—	44.1
ARC-LENGTH CORRECTION FACTOR									0.0	0.0	0.0	0.0	0.0	0.78	0.81	0.85	0.88
4.00	12.0	48.0	290	30.45	218	25.77	175	22.19	—	—	—	—	—	36.6	40.5	48.7	56.7
4.00	14.5	58.0	290	41.31	218	35.31	175	30.44	—	—	—	—	—	—	—	—	44.4
4.14	14.0	58.0	280	39.26	210	33.46	169	28.83	—	—	—	—	—	—	—	—	44.7
4.30	13.5	58.0	270	37.15	203	31.59	163	27.20	—	—	—	—	—	—	—	—	45.0
4.46	13.0	58.0	260	34.98	195	29.68	157	25.55	—	—	—	—	—	—	—	—	45.3
ARC-LENGTH CORRECTION FACTOR									0.0	0.0	0.0	0.0	0.0	0.77	0.80	0.85	0.88
4.83	12.0	58.0	240	30.46	180	25.78	145	22.20	—	—	—	—	—	—	—	—	45.9
ARC-LENGTH CORRECTION FACTOR									0.0	0.0	0.0	0.0	0.0	0.0	0.0	0.0	0.80

D = STANDARD V-BELT
 + IF RIM SPEED EXCEEDS 6500 FEET PER MINUTE, CONSULT *Martin*.



Stock Drive Selection **D**

Nominal Center Distances And Arc-Length Correction Factor										Sheave Combination		Speed Ratio
D Belt Length Designation										DriveR P.D.	DriveN P.D.	
240	270	300	330	360	390	420	480	540	600			
55.9	71.6	87.1	102.4	117.6	132.8	147.9	178.1	208.3	238.4	20.0	58.0	2.90
77.2	92.4	107.6	122.7	137.7	152.8	167.9	197.9	228.0	258.0	13.5	40.0	2.96
68.3	83.6	98.8	114.0	129.1	144.2	159.3	189.5	219.6	249.6	16.0	48.0	3.00
77.6	92.8	107.9	123.0	138.1	153.2	168.2	198.3	228.4	258.4	13.0	40.0	3.08
68.6	84.0	99.2	114.4	129.5	144.6	159.7	189.8	219.9	250.0	15.5	48.0	3.10
0.95	0.98	1.01	1.03	1.05	1.07	1.09	1.12	1.15	1.17			
68.9	84.3	99.6	114.7	129.9	145.0	160.1	190.2	220.3	250.4	15.0	48.0	3.20
57.2	73.0	88.4	103.8	119.0	134.2	149.4	179.6	209.8	239.9	18.0	58.0	3.22
69.3	84.7	99.9	115.1	130.2	145.3	160.4	190.6	220.7	250.8	14.5	48.0	3.31
78.3	93.5	108.7	123.8	138.9	153.9	169.0	199.1	229.1	259.2	12.0	40.0	3.33
69.6	85.0	100.3	115.5	130.6	145.7	160.8	190.9	221.1	251.1	14.0	48.0	3.43
0.95	0.98	1.01	1.03	1.05	1.07	1.09	1.12	1.15	1.17			
70.0	85.4	100.6	115.8	131.0	146.1	161.2	191.3	221.4	251.5	13.5	48.0	3.56
58.5	74.3	89.8	105.2	120.4	135.7	150.8	181.1	211.2	241.4	16.0	58.0	3.63
70.3	85.7	101.0	116.2	131.3	146.4	161.5	191.7	221.8	251.9	13.0	48.0	3.69
58.8	74.6	90.2	105.5	120.8	136.0	151.2	181.4	211.6	241.7	15.5	58.0	3.74
59.2	75.0	90.5	105.9	121.2	136.4	151.5	181.8	212.0	242.1	15.0	58.0	3.87
0.93	0.96	1.00	1.02	1.04	1.06	1.08	1.11	1.14	1.16			
71.0	86.4	101.7	116.9	132.0	147.2	162.3	192.4	222.5	252.6	12.0	48.0	4.00
59.5	75.3	90.9	106.2	121.5	136.7	151.9	182.2	212.3	242.5	14.5	58.0	4.00
59.8	75.7	91.2	106.6	121.9	137.1	152.3	182.5	212.7	242.9	14.0	58.0	4.14
60.1	76.0	91.5	106.9	122.2	137.4	152.6	182.9	213.1	243.2	13.5	58.0	4.30
60.4	76.3	91.9	107.3	122.6	137.8	153.0	183.3	213.5	243.6	13.0	58.0	4.46
0.93	0.96	0.99	1.02	1.04	1.06	1.08	1.11	1.14	1.16			
61.1	77.0	92.6	108.0	123.3	138.5	153.7	184.0	214.2	244.3	12.0	58.0	4.83
0.88	0.93	0.97	1.00	1.03	1.05	1.07	1.10	1.13	1.16			

FOR BELT SIZES NOT SHOWN, INTERPOLATE FOR ADDITIONAL CENTER DISTANCE.

V-BELT DRIVES

Non-Stock Drive Selection



The majority of V-belt drives may be selected from the pre-engineered tables by determining the necessary components from the steps outlined in the stock drive selection procedures. If one or more non-stock components are required for your drive, or other problems are encountered in selecting stock drives, the steps outlined below in the **NON STOCK DRIVE SELECTION** can be used.

NOTE: ON CRUSHERS, WOOD CHIPPERS, ETC. SPECIAL CONSTRUCTION REQUIRED. CONSULT FACTORY.

V-BELT DRIVES

TABLE 5 – SERVICE FACTORS																
<p>THE CORRECT SERVICE FACTOR IS DETERMINED BY:</p> <ol style="list-style-type: none"> 1. The extent and frequency of peak loads. 2. The number of operating hours per year, broken down into average hours per day of continuous service. 3. The proper service category (intermittent, normal or continuous). Select the one that most closely approximates your application conditions. 			<p>INTERMITTENT SERVICE – SERVICE FACTOR 1.0 TO 1.5 a Light Duty – Not more than 6 hours per day. b Never exceeding rated load.</p> <p>NORMAL SERVICE – SERVICE FACTOR 1.1 TO 1.6 a Daily service 6 to 16 hours per day. b Where occasional starting or peak load does not exceed 200% of the full load.</p> <p>CONTINUOUS SERVICE – SERVICE FACTOR 1.2 TO 1.8 a Where starting or peak load is in excess of 200% of the full load or where starting or peak loads and overloads occur frequently. b Continuous service 16 to 24 hours per day.</p>													
TYPICAL SERVICE FACTORS																
DRIVEN MACHINE TYPES			DRIVER TYPES													
<p>Driven machine types noted below are representative samples only. Select a category most closely approximating your application from those listed below.</p> <p>IF IDLERS ARE USED, ADD THE FOLLOWING TO THE SERVICE FACTOR.</p> <table style="width: 100%; border: none;"> <tr> <td style="padding: 2px;">Idler on slack side (inside)</td> <td style="padding: 2px;">None</td> </tr> <tr> <td style="padding: 2px;">Idler on slack side (outside)</td> <td style="padding: 2px;">0.1</td> </tr> <tr> <td style="padding: 2px;">Idler on tight side (inside)</td> <td style="padding: 2px;">0.1</td> </tr> <tr> <td style="padding: 2px;">Idler on tight side (outside)</td> <td style="padding: 2px;">0.2</td> </tr> </table>			Idler on slack side (inside)	None	Idler on slack side (outside)	0.1	Idler on tight side (inside)	0.1	Idler on tight side (outside)	0.2	<p>ELECTRIC MOTORS: AC Normal Torque Squirrel Cage and Synchronous AC Split Phase DC Shunt Wound Internal Combustion Engines</p>			<p>ELECTRIC MOTORS: AC Hi-Torque AC Hi-Slip AC Repulsion-Induction AC Single Phase Series Wound AC Slip Ring DC Compound Wound</p>		
Idler on slack side (inside)	None															
Idler on slack side (outside)	0.1															
Idler on tight side (inside)	0.1															
Idler on tight side (outside)	0.2															
	INTERMITTENT SERVICE	NORMAL SERVICE	CONTINUOUS SERVICE	INTERMITTENT SERVICE	NORMAL SERVICE	CONTINUOUS SERVICE										
Agitators for Liquids Blowers and Exhausters Centrifugal Pumps and Compressors 1.0 Fans up to 10 HP Light Duty Conveyors	1.0	1.1	1.2	1.1	1.2	1.3										
Belt Conveyors For Sand, Grain, etc. Dough Mixers Fans Over 10 HP Generators Line Shafts Laundry Machinery Machine Tools Punches-Presses-Shears Printing Machinery Positive Displacement Rotary Pumps Revolving and Vibrating Screens	1.1	1.2	1.3	1.2	1.3	1.4										
Brick Machinery Bucket Elevators Exciters Piston Compressors Conveyors (Drag-Pan-Screw) Hammer Mills Paper Mill Beaters Piston Pumps Positive Displacement Blowers Pulverizers Saw Mill and Woodworking Machinery Textile Machinery	1.2	1.3	1.4	1.4	1.5	1.6										
Crushers (Gyratory-Jaw-Roll) Mills (Ball-Rod-Tube) Hoists Rubber Calenders-Extruders-Mills	1.3	1.4	1.5	1.5	1.6	1.8										
Chokable Equipment	2.0	2.0	2.0	2.0	2.0	2.0										

FOR A GOOD COMMERCIAL DRIVE SELECTION, USE CONTINUOUS SERVICE FACTOR

BEFORE SELECTING A DRIVE, YOU NEED TO KNOW THESE FACTS:

1. Horsepower and type of driver
2. RPM of driver
3. RPM and type of driven machine
4. Approximate shaft center distance
5. Shaft size of both units
6. Average hours of operation per day

TYPICAL EXAMPLE

1. The driver is a 75HP squirrel cage, normal torque, electric motor
2. The driver speed is 1160 RPM
3. A piston pump is to be driven at 395 RPM
4. The desired center distance is 36" to 48"
5. The driver shaft diameter is 2⁷/₈" and the driven shaft diameter is 2¹/₂" (both have standard keyseats)
6. The drive operates 20 hours per day.

TABLE 6 — Hi-Cap Cross Section Selection Chart

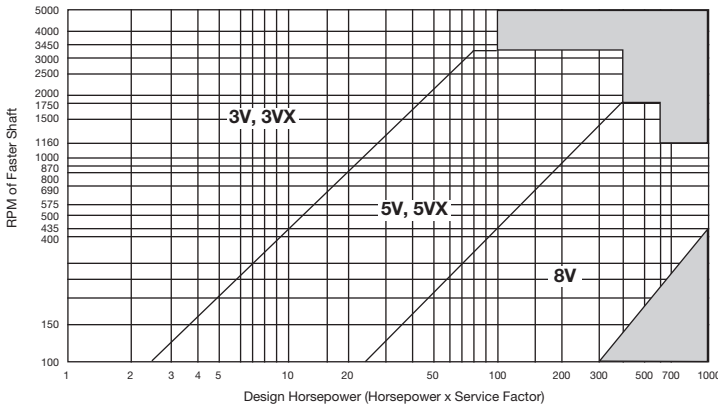

Shaded area refer to factory.

TABLE 8 — Minimum Recommended Sheave Diameters For Electric Motors

MOTOR HORSE-POWER	MOTOR RPM					
	575	695	870	1160	1750	3450
.50	2.50	2.50	2.50	—	—	—
.75	3.00	2.50	2.50	2.50	—	—
1.00	3.00	3.00	2.50	2.50	2.25	—
1.50	3.00	3.00	3.00	2.50	2.50	2.25
2.00	3.75	3.00	3.00	2.50	2.50	2.50
3.00	4.50	3.75	3.00	3.00	2.50	2.50
5.00	4.50	4.50	3.75	3.00	3.00	2.50
7.50	4.25	4.50	4.50	3.75	3.00	3.00
10.00	6.00	5.25	4.50	4.50	3.75	3.00
15.00	6.75	6.00	5.25	4.50	4.50	3.75
20.00	8.25	6.75	6.00	5.25	4.50	4.50
25.00	9.00	8.25	6.75	6.00	4.50	4.50★
★30.00	10.00	9.00	6.75	6.75	5.25	—
40.00	10.00	10.00	8.25	6.75	6.00	—
50.00	11.00	10.00	9.00	8.25	6.75	—
60.00	12.00	11.00	10.00	9.00	7.50	—
75.00	14.00	13.00	10.00	10.00	9.00	—
100.00	18.00	15.00	13.00	13.00	10.00	—
125.00	20.00	18.00	15.00	13.00	11.00	—
150.00	22.00	20.00	18.00	13.00	—	—
200.00	22.00	22.00	22.00	—	—	—
250.00	22.00	22.00	—	—	—	—
300.00	27.00	27.00	—	—	—	—

★Note: Data above the line are from National Electrical Manufacturers Association Standard MG1-3.16 and MG1-3.16a. Data below the line are a composite of Electrical Motor Manufacturers data. They are generally conservative, and specific motors and bearings may permit the use of a smaller motor sheave. Consult the motor manufacturer.

TABLE 7 — Conventional Cross Section Selection Chart

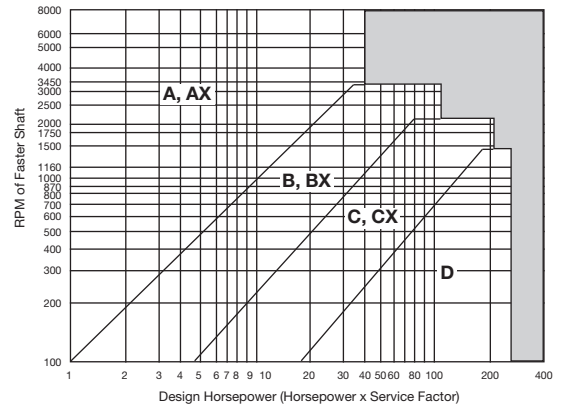

NON-STOCK DRIVE SELECTION PROCEDURE

STEP 1. Determine Design Horsepower

- A. Refer to Table 5, "Typical Service Factors." Locate the type of driven equipment and extend to the type of driver.

Example: Service factor is 1.3

- B. Check the list of additions for effect of idlers or other drive conditions under notes of Table 5 and correct the service factor, if applicable.

Example: No additional factor

- C. Multiply the horsepower requirement of your drive by the corrected service factor.

Example: 75 x 1.3 = 97.5 Design HP

STEP 2. Choose the Belt Cross Section

- A. Refer to Table 6 "Hi-Cap Wedge Cross Section Selection Chart", or to Table 7, "Conventional Cross Section Selection Chart." Locate the design horsepower along the horizontal axis. Read up to the intersection with the RPM of the faster shaft. The point at which the lines intersect indicates the recommended belt section. Example: For 97.5 design horsepower and 1160 RPM, 5V section belts are recommended. (The decision to use Hi-Cap Wedge belts was arbitrary, conventional belts could also have been used)

- B. If the driver is an electric motor, check the HP and RPM against the minimum recommended sheave diameter on Table 8. Be sure to use a motor sheave that will conform to the NEMA standard for minimum sheave diameter. (If it will not, choose a larger diameter range, or a larger cross section.)

Example: From Table 8, the minimum small sheave to be used for this drive is 10"

Non-Stock Drive Selection

V-BELT DRIVES

STEP 3. Determine Speed Ratio

Divide the RPM of faster shaft by the RPM of the slower shaft to determine your speed ratio.

Example: $\frac{1160}{395} = 2.94$ Ratio

NOTE:

If replacing a chain or gear drive, divide the number of teeth on the larger sprocket or gear by the number of teeth on the smaller. If replacing a flat belt or conventional V-belt drive, divide the diameter of the larger pulley or sheave, by the diameter of the smaller.

STEP 4. Choose the Sheave Diameters

Stock sheave pitch diameters are given in Table 9. If it is necessary to obtain a speed ratio not possible with two stock sheaves, it is most economical to select a standard sheave diameter for the **largest** sheave.

- A. If the diameter of one sheave is dictated by the drive, start with that diameter. If nothing limits the sheave diameters, start with "the small sheave diameter" in the **upper end** of the recommended driver range as given in Table 9. (If the driver is an electric motor, it is important that the motor sheave diameter is larger than given in Table 8.)

Example: The largest diameter stock 5V sheave that is normally used as a driver (small) sheave has an O.D. of 16". This is larger than the minimum 10" as recommended for this application by Table 8. Thus 16" is a good starting point.

- B. Calculate the belt speed by using this formula: Belt Speed = 0.262 x (PD of either sheave) x (RPM of same sheave). For cast iron statically balanced sheaves, the belt speed should not exceed 5000 feet per minute. Consult factory when speed exceeds 5000 fpm.

Example: Belt speed = 0.262 x 15.90 x 1160
Belt speed = 4832.33

- C. To determine the size of the driven sheave, multiply the O.D. of the small sheave by the speed ratio.

Example: 16.0" x 2.94 = 47.0"

NOTE:

If working with the large sheave as your base, divide the O.D. of the large sheave by the speed ratio to get the small sheave O.D.

- D. If the large sheave is **not** a **stock** diameter (See Table 9) choose the next smaller **stock** diameter and divide by the speed ratio to determine a new small sheave diameter. This way only the small sheave will be made to order thus the cost of the drive may be reduced.

Example: The 47.0" O.D. is non stock, the next smaller size is 37.5" O.D., therefore, $37.5/2.94 = 12.8$ " O.D. for small sheave. (**Now sheave sizes are 12.8" O.D. driver and 37.5" O.D. Driven.**)

NOTE:

If small sheave O.D. is reduced by above procedure, recheck minimum electric motor driver sheave size. Also, it's a good idea to recheck belt speed using large sheave as your base. Minimum = 10" Belt speed = 0.262 x 37.4 x 395 = 3870.53.

STEP 5. Determine Center Distance and Belt Length

- A. When the required center distance is not specified, use:

$$\frac{(D + 3d)}{2}, \text{ where } D = \text{O.D. of large sheave, and } d = \text{O.D. of small sheave or, use the large sheave O.D. (whichever is larger) as the preferred center distance. To calculate the belt length required when the center distance is known:}$$

$$\text{Belt Length} = 2C + 1.57(D + d) + \frac{(D-d)^2}{4C}$$

Where C = Center Distance

Example: The required center distance specified in the original data is 36" to 48". So use a mean center of 42". If there was not a C.D. specified, you could have used: $\frac{D + 3d}{2} = 37.95$ " as the preferred.

$$\text{Belt Length} = 2 \times 42 + 1.57(37.5 + 12.8) + \frac{(37.5 - 12.8)^2}{4 \times 42} = 166.6 \text{ inches}$$

Table 10 indicates the nearest stock belt length for 5V belts is 160 inches. Use the next step to determine the correct center distance now that the belt length is known.

- B. To calculate the center distance when belt length is known:

$$\text{Center Distance} = \frac{L - 1.57(D + d) - \frac{(D-d)^2}{2}}{1.57(L - R)}$$

Where D = O.D. large sheave
d = O.D. small sheave
C = center distance
L = belt length
R = speed ratio

Example: Using the stock 5V1600 belt length of 160 inches:

$$\text{Center distance} = \frac{160 - 1.57(37.5 + 12.8) - 1.57(160 - 2.94)}{2} = 39.3 \text{ inches}$$

STEP 6. Determine Required Number of Belts

- A. Refer to Table 11, "Arc Correction Factor 'G' ". The value representing the difference in sheave outside diameters divided by the center distance is found in the first column. Read across the column showing centers approximating those found in STEP 5 above, interpolating as necessary. This figure is your arc of contact correction factor.

Example: Arc of contact correction factor is:

$$\frac{(37.5 - 12.8)}{39.3} = .628 \quad \text{Factor} = .90 \quad \text{By Interpretation}$$

- B. Referring to the basic horsepower rating tables read down the first column of the appropriate cross section table to the RPM of the faster shaft, interpolating if the exact speed is not shown. Read across the column headed "Sheave Outside Diameter" to the diameter of your small sheave (again interpolate, if necessary) for the basic horsepower per belt.

Example: The basic horsepower rating table for 5V belts indicates horsepower per belt of 27.19 (By Interpolation between 12.5 and 13.2 O.D. — where 13.20" has HP of 28.20 and 12.50" has HP of 26.43 then $28.20 - 26.43 = 1.77 \div 7 \times 3 + 26.43 = 27.19$.)

- C. Continue on the same line as your horsepower per belt to the column headed "Add On HP for Speed Ratio." Under the appropriate speed ratio column you will find the additional horsepower per belt to add for your particular speed ratio. Example: The additional HP per belt for speed ratio 2.94 is 1.26.

Therefore, rated HP per belt = 27.19 + 1.26 = 28.45

- D. Multiply the rated HP per belt by the belt length correction factor also found in Table 10; then by the arc correction factor found in STEP 6A.

Example: Table 10 also shows the length correction factor as 1.04; therefore: corrected HP per belt = 28.45 x 1.04 x .90 = 26.63

- E. Divide the design HP by the corrected HP per belt for the number of belts required. When your answer contains a fraction, round up to the next whole number.

Example: $\frac{97.5}{26.63} = 3.66 = 4$ Belts

STEP 7. Order *Martin*

- (1) Made to order 4 5V 1280E
(1) E 2 $\frac{1}{8}$ bushing
(1) 4 5V 3750 F
(1) F 2 $\frac{1}{8}$ bushing

NOTE:

The choice of QD bushings was arbitrary. Also available in Taper Bushed.



Non-Stock Drive Selection

Table 9 — Stock Sheave Diameters

A		B		C		D		3V		5V		8V	
Outside Diam.	Pitch Diam.	Outside Diam.	Pitch Diam.	Outside Diam.	Pitch Diam.	Outside Diam.	Pitch Diam.	Outside Diam.	Pitch Diam.	Outside Diam.	Pitch Diam.	Outside Diam.	Pitch Diam.
3.25	3.0	3.75	3.4	5.4	5.0	12.6	12.0	2.20	2.15	4.40	4.30	12.5	12.3
3.45	3.2	3.95	3.6	5.9	5.5	13.6	13.0	2.35	2.30	4.65	4.55	13.2	13.0
3.65	3.4	4.15	3.8	6.4	6.0	14.1	13.5	2.50	2.45	4.90	4.80	14.0	13.8
3.85	3.6	4.35	4.0	7.4	7.0	14.6	14.0	2.65	2.60	5.20	5.10	15.0	14.8
4.05	3.8	4.55	4.2	7.9	7.5	15.1	14.5	2.80	2.75	5.50	5.40	16.0	15.8
4.25	4.0	4.75	4.4	8.4	8.0	15.6	15.0	3.00	2.95	5.90	5.80	17.0	16.8
4.45	4.2	4.95	4.6	8.9	8.5	16.1	15.5	3.15	3.10	6.30	6.20	18.0	17.8
4.65	4.4	5.15	4.8	9.4	9.0	16.6	16.0	3.35	3.30	6.70	6.60	19.0	18.8
4.85	4.6	5.35	5.0	9.9	9.5	18.6	18.0	3.65	3.60	7.10	7.00	20.0	19.8
5.05	4.8	5.55	5.2	10.4	10.0	20.6	20.0	4.12	4.07	7.50	7.40	21.2	21.0
5.25	5.0	5.75	5.4	10.9	10.5	22.6	22.0	4.50	4.45	8.00	7.90	22.4	22.2
5.45	5.2	5.95	5.6	11.4	11.0	27.6	27.0	4.75	4.70	8.50	8.40	24.8	24.6
5.65	5.4	6.15	5.8	12.4	12.0	33.6	33.0	5.00	4.95	9.00	8.90	30.0	29.8
5.85	5.6	6.35	6.0	13.4	13.0	40.6	40.0	5.30	5.25	9.25	9.15	35.5	35.3
6.05	5.8	6.55	6.2	14.4	14.0	48.6	48.0	5.60	5.55	9.75	9.65	40.0	39.8
6.25	6.0	6.75	6.4	16.4	16.0	58.6	58.0	6.00	5.95	10.30	10.20	44.5	44.3
6.45	6.2	6.95	6.6	18.4	18.0			6.50	6.45	10.90	10.80	53.0	52.8
6.65	6.4	7.15	6.8	20.4	20.0			6.90	6.85	11.30	11.20	63.0	62.8
6.85	6.6	7.35	7.0	24.4	24.0			8.00	7.95	11.80	11.70	71.0	70.8
7.25	7.0	7.75	7.4	27.4	27.0			10.60	10.55	12.50	12.40	95.0	94.8
7.85	7.6	8.35	8.0	30.4	30.0			14.00	13.95	13.20	13.10		
8.45	8.2	8.95	8.6	36.4	36.0			19.00	18.95	14.00	13.90		
9.25	9.0	9.75	9.4	44.4	44.0			25.00	24.95	15.00	14.90		
10.85	10.6	11.35	11.0	50.4	50.0			33.50	33.45	16.00	15.90		
12.25	12.0	12.75	12.4							18.70	18.60		
13.45	13.2	13.95	13.6							21.20	21.10		
15.25	15.0	15.75	15.4							23.60	23.50		
15.85	15.6	16.35	16.0							28.00	27.90		
18.25	18.0	18.75	18.4							31.50	31.40		
19.85	19.6	20.35	20.0							37.50	37.40		
24.85	24.6	25.35	25.0							50.00	49.90		
29.85	29.6	30.35	30.0										
37.85	37.6	38.35	38.0										

Sizes shown above bold lines are normally recommended for driver sheaves.

Table 11 — Arc Correction Factor "G"

D-d C	Approximate Arc of Contact on Small Sheave	Factor "G"
.00	180	1.00
.10	174	.99
.20	169	.97
.30	163	.96
.40	157	.94
.50	151	.93
.60	145	.91
.70	139	.89
.80	133	.87
.90	127	.85
1.00	120	.82
1.10	113	.80
1.20	106	.77
1.30	99	.73
1.40	91	.70
1.50	83	.65

V-BELT DRIVES

Table 10 — Effective Outside Belt Length and Correction Factors

A			B			C			D			3V			5V			8V		
Belt No.	Eff. Length	Corr. Factor	Belt No.	Eff. Length	Corr. Factor	Belt No.	Eff. Length	Corr. Factor	Belt No.	Eff. Length	Corr. Factor	Belt No.	Eff. Length	Corr. Factor	Belt No.	Eff. Length	Corr. Factor	Belt No.	Eff. Length	Corr. Factor
A 26	28.1	0.81	B 35	37.9	0.81	C 51	55.2	0.80	D 120	125.2	.86	3VX250	25.0	0.83	5VX 500	50.0	0.85	8V1000	100.0	0.87
A 31	33.1	0.84	B 38	40.9	0.83	C 60	64.2	0.82	D 128	133.2	0.87	3VX 265	26.5	0.84	5VX 530	53.0	0.86	8V1060	106.0	0.88
A 35	37.1	0.87	B 42	44.9	0.85	C 68	72.2	0.85	D144	149.2	0.90	3VX 280	28.0	0.85	5VX 560	56.0	0.87	8V1120	112.0	0.88
A 38	40.1	0.88	B 46	48.9	0.87	C 75	79.2	0.87	D 158	163.2	0.92	3VX 300	30.0	0.86	5VX 600	60.0	0.88	8V1180	118.0	0.89
A 42	44.1	0.90	B 51	53.9	0.89	C 81	85.2	0.89	D173	178.2	0.93	3VX 315	31.5	0.87	5VX 630	63.0	0.89	8V1250	125.0	0.90
A 46	48.1	0.92	B 55	57.9	0.90	C 85	89.2	0.90	D180	185.2	0.94	3VX 335	33.5	0.88	5VX 670	67.0	0.90	8V1320	132.0	0.91
A 51	53.1	0.94	B 60	62.9	0.92	C 90	94.2	0.91	D195	200.2	0.96	3VX 355	35.5	0.89	5VX710	71.0	0.91	8V1400	140.0	0.92
A 55	55.1	0.96	B 68	70.9	0.95	C 96	100.2	0.92	D210	212.7	0.96	3VX 375	37.5	0.90	5VX 750	75.0	0.92	8V1500	150.0	0.93
A 60	62.1	0.98	B 75	77.9	0.97	C105	109.2	0.94	D240	242.7	1.00	3VX 400	40.0	0.92	5VX 800	80.0	0.93	8V1600	160.0	0.94
A 68	70.1	1.00	B 81	83.9	0.98	C112	116.2	0.95	D270	272.7	1.03	3VX 425	42.5	0.93	5VX 850	85.0	0.94	8V1700	170.0	0.95
A 75	77.1	1.02	B 85	87.9	0.99	C120	124.2	0.97	D300	302.7	1.05	3VX 450	45.0	0.94	5VX 900	90.0	0.95	8V1800	180.0	0.95
A 80	82.1	1.04	B 90	92.9	1.00	C128	132.2	0.98	D330	332.7	1.07	3VX 475	47.5	0.95	5VX 950	95.0	0.96	8V1900	190.0	0.96
A 85	87.1	1.05	B 97	99.9	1.02	C144	148.2	1.00	D360	362.7	1.09	3VX 500	50.0	0.96	5VX1000	100.0	0.96	8V2000	200.0	0.97
A 90	92.1	1.06	B105	107.9	1.04	C158	162.2	1.02	D390	392.7	1.11	3VX 530	53.0	0.97	5VX1060	106.0	0.97	8V2120	212.0	0.98
A 96	98.1	1.08	B112	114.9	1.05	C173	177.2	1.04	D420	422.7	1.12	3VX 560	56.0	0.98	5VX1120	112.0	0.98	8V2240	224.0	0.98
A105	107.1	1.10	B120	122.9	1.07	C180	184.2	1.05	D480	482.7	1.16	3VX 600	60.0	0.99	5VX1180	118.0	0.99	8V2360	236.0	0.99
A112	114.1	1.11	B128	130.9	1.08	C195	199.2	1.07	D540	542.7	1.18	3VX 630	63.0	1.00	5VX1250	125.0	1.00	8V2500	250.0	1.00
A120	122.1	1.13	B144	146.9	1.11	C210	212.2	1.08	D600	602.7	1.20	3VX 670	67.0	1.01	5VX1320	132.0	1.01	8V2650	265.0	1.01
A128	130.1	1.14	B158	160.9	1.13	C240	242.2	1.11				3VX 710	71.0	1.02	5VX1400	140.0	1.02	8V2800	280.0	1.00
			B173	175.9	1.15	C270	272.2	1.14				3VX 750	75.0	1.03	5VX1500	150.0	1.03	8V3000	300.0	1.00
			B180	182.9	1.16	C300	302.2	1.16				3VX 800	80.0	1.04	5VX1600	160.0	1.04	8V3150	315.0	1.03
			B195	197.9	1.18	C330	332.2	1.19				3VX 850	85.0	1.05	5VX1700	170.0	1.05	8V3350	335.0	1.04
			B210	211.4	1.19	C360	362.2	1.21				3VX900	90.0	1.07	5VX1800	180.0	1.06	8V3550	355.0	1.05
			B240	241.4	1.22	C390	392.2	1.23				3VX 950	95.0	1.08	5VX1900	190.0	1.07	8V3750	375.0	1.06
			B270	271.4	1.25	C420	422.2	1.24				3VX1000	100.0	1.09	5VX2000	200.0	1.08	8V4000	400.0	1.07
			B300	301.4	1.27							3VX1060	106.0	1.10	5V 2120	212.0	1.08	8V4250	425.0	1.08
												3VX1120	112.0	1.11	5V 2240	224.0	1.09	8V4500	450.0	1.09
												3VX1180	118.0	1.12	5V 2360	236.0	1.10	8V4750	475.0	1.10
												3VX1250	125.0	1.13	5V 2500	250.0	1.11	8V5000	500.0	1.11
												3VX1320	132.0	1.15	5V 2650	265.0	1.12			
												3VX1400	140.0	1.16	5V 2800	280.0	1.13			
															5V 3000	300.0	1.14			
															5V 3150	315.0	1.15			
															5V 3350	335.0	1.16			
															5V 3550	355.0	1.17			

3V Basic Belt HP Ratings



V-BELT DRIVES

RPM of Faster Shaft	Sheave Outside Diameter (in inches)													
	2.20	2.35	2.50	2.65	2.80	3.00	3.15	3.35	3.65	4.12	4.50	4.75	5.00	5.30
575	0.37	0.47	0.56	0.66	0.75	0.88	0.97	1.09	1.28	1.57	1.80	1.95	2.10	2.28
690	0.43	0.54	0.65	0.76	0.88	1.02	1.13	1.28	1.50	1.84	2.11	2.29	2.47	2.68
725	0.44	0.56	0.68	0.80	0.91	1.07	1.18	1.34	1.57	1.92	2.21	2.39	2.58	2.80
870	0.50	0.64	0.78	0.92	1.06	1.24	1.38	1.56	1.83	2.25	2.59	2.81	3.03	3.29
950	0.54	0.69	0.84	0.99	1.14	1.34	1.49	1.68	1.98	2.43	2.80	3.04	3.27	3.55
1160	0.62	0.80	0.98	1.16	1.34	1.58	1.76	1.99	2.35	2.89	3.33	3.61	3.89	4.23
1425	0.71	0.93	1.15	1.36	1.58	1.87	2.08	2.37	2.79	3.45	3.97	4.31	4.65	5.05
1750	0.80	1.07	1.33	1.60	1.86	2.20	2.46	2.80	3.31	4.09	4.72	5.13	5.53	6.01
2850	1.05	1.46	1.87	2.27	2.67	3.20	3.59	4.11	4.87	6.03	6.95	7.54	8.11	8.79
3450	1.14	1.62	2.10	2.57	3.04	3.65	4.11	4.71	5.59	6.92	7.95	8.61	9.24	9.98
100	0.09	0.11	0.13	0.15	0.17	0.19	0.21	0.23	0.27	0.33	0.37	0.40	0.43	0.47
200	0.16	0.20	0.24	0.27	0.31	0.35	0.39	0.43	0.50	0.61	0.70	0.75	0.81	0.88
300	0.23	0.28	0.33	0.38	0.43	0.50	0.55	0.62	0.72	0.88	1.01	1.09	1.17	1.27
400	0.28	0.35	0.42	0.49	0.55	0.64	0.71	0.80	0.93	1.14	1.30	1.41	1.52	1.64
500	0.34	0.42	0.50	0.59	0.67	0.78	0.86	0.97	1.13	1.38	1.59	1.72	1.85	2.01
600	0.38	0.48	0.58	0.68	0.78	0.91	1.01	1.14	1.33	1.63	1.87	2.02	2.18	2.37
700	0.43	0.55	0.66	0.77	0.89	1.04	1.15	1.30	1.52	1.86	2.14	2.32	2.50	2.71
800	0.47	0.60	0.73	0.86	0.99	1.16	1.29	1.45	1.70	2.09	2.41	2.61	2.81	3.05
900	0.52	0.66	0.80	0.95	1.09	1.28	1.42	1.61	1.89	2.32	2.67	2.89	3.12	3.39
1000	0.56	0.72	0.87	1.03	1.19	1.40	1.55	1.76	2.07	2.54	2.93	3.17	3.42	3.72
1100	0.59	0.77	0.94	1.11	1.28	1.51	1.68	1.91	2.24	2.76	3.18	3.45	3.72	4.04
1200	0.63	0.82	1.01	1.19	1.38	1.62	1.81	2.05	2.41	2.98	3.43	3.72	4.01	4.36
1300	0.66	0.87	1.07	1.27	1.47	1.73	1.93	2.19	2.58	3.19	3.67	3.98	4.30	4.67
1400	0.70	0.91	1.13	1.35	1.56	1.84	2.05	2.33	2.75	3.39	3.91	4.25	4.58	4.98
1500	0.73	0.96	1.19	1.42	1.65	1.95	2.17	2.47	2.91	3.60	4.15	4.50	4.86	5.28
1600	0.76	1.01	1.25	1.49	1.73	2.05	2.29	2.61	3.07	3.80	4.38	4.75	5.13	5.57
1700	0.79	1.05	1.31	1.56	1.82	2.15	2.41	2.74	3.23	4.00	4.61	5.00	5.40	5.86
1800	0.82	1.09	1.36	1.63	1.90	2.25	2.52	2.87	3.39	4.19	4.83	5.25	5.66	6.15
1900	0.84	1.13	1.42	1.70	1.98	2.35	2.63	3.00	3.54	4.38	5.05	5.49	5.92	6.43
2000	0.87	1.17	1.47	1.77	2.06	2.45	2.74	3.12	3.69	4.57	5.27	5.72	6.17	6.70
2100	0.90	1.21	1.52	1.83	2.14	2.54	2.85	3.25	3.84	4.76	5.48	5.95	6.42	6.97
2200	0.92	1.25	1.57	1.89	2.21	2.64	2.95	3.37	3.99	4.94	5.69	6.18	6.66	7.23
2300	0.94	1.28	1.62	1.96	2.29	2.73	3.05	3.49	4.13	5.11	5.89	6.40	6.90	7.49
2400	0.96	1.32	1.67	2.02	2.36	2.82	3.16	3.60	4.27	5.29	6.10	6.62	7.13	7.74
2500	0.98	1.35	1.71	2.07	2.43	2.91	3.26	3.72	4.41	5.46	6.29	6.83	7.36	7.98
2600	1.00	1.38	1.76	2.13	2.50	2.99	3.35	3.83	4.54	5.63	6.49	7.04	7.58	8.22
2700	1.02	1.42	1.80	2.19	2.57	3.08	3.45	3.94	4.68	5.79	6.67	7.24	7.80	8.45
2800	1.04	1.45	1.85	2.24	2.64	3.16	3.54	4.05	4.81	5.96	6.86	7.44	8.01	8.68
2900	1.06	1.48	1.89	2.30	2.70	3.24	3.64	4.16	4.93	6.11	7.04	7.63	8.22	8.90
3000	1.07	1.50	1.93	2.35	2.77	3.32	3.73	4.26	5.06	6.27	7.21	7.82	8.42	9.11
3200	1.10	1.56	2.01	2.45	2.89	3.47	3.90	4.47	5.30	6.57	7.55	8.18	8.80	9.52
3400	1.13	1.61	2.08	2.55	3.01	3.62	4.07	4.66	5.53	6.85	7.87	8.52	9.16	9.89
3600	1.15	1.65	2.15	2.64	3.12	3.76	4.23	4.85	5.75	7.12	8.17	8.84	9.49	10.24
3800	1.17	1.70	2.21	2.72	3.23	3.89	4.38	5.02	5.96	7.37	8.46	9.14	9.80	10.56
4000	1.19	1.73	2.27	2.80	3.33	4.02	4.52	5.19	6.16	7.61	8.72	9.41	10.08	10.85
4200	1.20	1.77	2.33	2.88	3.42	4.13	4.66	5.34	6.34	7.83	8.96	9.66	10.34	11.10
4400	1.21	1.79	2.38	2.95	3.51	4.24	4.78	5.49	6.51	8.03	9.18	9.89	10.56	11.32
4600	1.21	1.82	2.42	3.01	3.59	4.35	4.90	5.63	6.67	8.22	9.37	10.08	10.75	11.51
4800	1.21	1.84	2.46	3.07	3.66	4.44	5.01	5.75	6.82	8.38	9.55	10.25	10.92	11.65
5000	1.21	1.86	2.49	3.12	3.73	4.53	5.11	5.87	6.95	8.53	9.69	10.40	11.05	11.76
5200	1.20	1.87	2.52	3.16	3.79	4.61	5.20	5.97	7.07	8.66	9.82	10.51	11.15	11.83
5400	1.19	1.87	2.55	3.20	3.85	4.68	5.28	6.06	7.18	8.77	9.92	10.60	11.21	11.86
5600	1.17	1.88	2.56	3.24	3.89	4.74	5.36	6.15	7.27	8.86	9.99	10.65	11.24	11.85
5800	1.15	1.87	2.58	3.26	3.93	4.79	5.42	6.22	7.35	8.93	10.04	10.68	11.23	11.80
6000	1.13	1.87	2.59	3.28	3.96	4.84	5.47	6.27	7.41	8.98	10.06	10.67	11.19	11.70
6200	1.11	1.86	2.59	3.30	3.99	4.87	5.51	6.32	7.45	9.00	10.05	10.62	11.11	11.56
6400	1.07	1.84	2.58	3.31	4.00	4.90	5.54	6.35	7.48	9.01	10.01	10.55	10.98	11.36
6600	1.04	1.82	2.57	3.31	4.01	4.91	5.56	6.37	7.49	8.98	9.94	10.43	10.82	11.12
6800	1.00	1.79	2.56	3.30	4.01	4.92	5.57	6.38	7.49	8.94	9.84	10.29	10.61	10.83
7000	0.96	1.76	2.54	3.29	4.01	4.92	5.56	6.37	7.46	8.87	9.71	10.10	10.36	10.49

■ RIM SPEEDS EXCEED 6500 FEET PER MINUTE.



Basic Belt 3V HP Ratings

V-BELT DRIVES

Sheave Outside Diameter (in inches)						"Add-On" HP for Speed Ratio										RPM of Faster Shaft
5.60	6.00	6.50	6.90	8.00	10.60	1.02- 1.05	1.06- 1.11	1.12- 1.18	1.19- 1.26	1.27- 1.38	1.39- 1.57	1.58- 1.94	1.95- 3.38	3.39 & Up		
2.46	2.69	2.99	3.22	3.86	5.32	0.01	0.03	0.05	0.07	0.08	0.10	0.11	0.12	0.12	575	
2.89	3.17	3.52	3.79	4.54	6.26	0.01	0.03	0.06	0.08	0.10	0.11	0.13	0.14	0.15	690	
3.02	3.31	3.67	3.96	4.74	6.54	0.01	0.04	0.06	0.08	0.10	0.12	0.14	0.15	0.16	725	
3.55	3.89	4.32	4.66	5.58	7.67	0.02	0.04	0.07	0.10	0.12	0.14	0.16	0.18	0.19	870	
3.84	4.21	4.67	5.03	6.02	8.28	0.02	0.05	0.08	0.11	0.13	0.16	0.18	0.19	0.21	950	
4.57	5.01	5.56	5.99	7.16	9.79	0.02	0.06	0.10	0.14	0.16	0.19	0.22	0.24	0.25	1160	
5.45	5.98	6.63	7.14	8.52	11.56	0.03	0.07	0.12	0.17	0.20	0.24	0.27	0.29	0.31	1425	
6.48	7.10	7.86	8.46	10.05	13.46	0.03	0.09	0.15	0.20	0.25	0.29	0.33	0.36	0.38	1750	
9.45	10.30	11.31	12.09	14.02	17.30	0.05	0.14	0.24	0.33	0.40	0.47	0.53	0.58	0.62	2850	
10.70	11.60	12.65	13.42	15.22	17.24	0.06	0.17	0.30	0.40	0.49	0.57	0.65	0.70	0.75	3450	
0.50	0.55	0.61	0.65	0.78	1.07	0.00	0.00	0.01	0.01	0.01	0.02	0.02	0.02	0.02	100	
0.95	1.04	1.15	1.23	1.48	2.04	0.00	0.01	0.02	0.02	0.03	0.03	0.04	0.04	0.04	200	
1.37	1.50	1.66	1.79	2.14	2.95	0.01	0.01	0.03	0.04	0.04	0.05	0.06	0.06	0.06	300	
1.77	1.94	2.15	2.32	2.78	3.84	0.01	0.02	0.03	0.05	0.06	0.07	0.07	0.08	0.09	400	
2.17	2.37	2.63	2.84	3.40	4.69	0.01	0.02	0.04	0.06	0.07	0.08	0.09	0.10	0.11	500	
2.55	2.80	3.10	3.35	4.01	5.53	0.01	0.03	0.05	0.07	0.09	0.10	0.11	0.12	0.13	600	
2.93	3.21	3.56	3.84	4.60	6.34	0.01	0.03	0.06	0.08	0.10	0.12	0.13	0.14	0.15	700	
3.30	3.61	4.01	4.32	5.18	7.13	0.01	0.04	0.07	0.09	0.11	0.13	0.15	0.16	0.17	800	
3.66	4.01	4.45	4.80	5.74	7.90	0.02	0.04	0.08	0.11	0.13	0.15	0.17	0.18	0.19	900	
4.01	4.40	4.88	5.26	6.30	8.65	0.02	0.05	0.09	0.12	0.14	0.17	0.19	0.20	0.22	1000	
4.36	4.78	5.31	5.72	6.84	9.37	0.02	0.05	0.09	0.13	0.16	0.18	0.21	0.22	0.24	1100	
4.70	5.16	5.72	6.17	7.37	10.07	0.02	0.06	0.10	0.14	0.17	0.20	0.22	0.24	0.26	1200	
5.04	5.53	6.13	6.61	7.89	10.75	0.02	0.06	0.11	0.15	0.18	0.22	0.24	0.26	0.28	1300	
5.37	5.89	6.53	7.03	8.39	11.40	0.03	0.07	0.12	0.16	0.20	0.23	0.26	0.29	0.30	1400	
5.69	6.24	6.92	7.45	8.88	12.02	0.03	0.07	0.13	0.18	0.21	0.25	0.28	0.31	0.32	1500	
6.01	6.59	7.30	7.86	9.36	12.62	0.03	0.08	0.14	0.19	0.23	0.27	0.30	0.33	0.35	1600	
6.32	6.93	7.68	8.26	9.82	13.19	0.03	0.08	0.15	0.20	0.24	0.28	0.32	0.35	0.37	1700	
6.63	7.26	8.04	8.65	10.27	13.73	0.03	0.09	0.15	0.21	0.26	0.30	0.34	0.37	0.39	1800	
6.93	7.59	8.40	9.03	10.71	14.24	0.03	0.09	0.16	0.22	0.27	0.32	0.36	0.39	0.41	1900	
7.22	7.91	8.75	9.40	11.13	14.72	0.04	0.10	0.17	0.23	0.28	0.33	0.37	0.41	0.43	2000	
7.51	8.22	9.09	9.76	11.53	15.16	0.04	0.10	0.18	0.25	0.30	0.35	0.39	0.43	0.45	2100	
7.79	8.52	9.42	10.11	11.92	15.57	0.04	0.11	0.19	0.26	0.31	0.37	0.41	0.45	0.48	2200	
8.06	8.82	9.74	10.45	12.29	15.94	0.04	0.11	0.20	0.27	0.33	0.38	0.43	0.47	0.50	2300	
8.33	9.11	10.05	10.77	12.65	16.28	0.04	0.12	0.21	0.28	0.34	0.40	0.45	0.49	0.52	2400	
8.59	9.39	10.35	11.09	12.99	16.58	0.05	0.12	0.21	0.29	0.35	0.42	0.47	0.51	0.54	2500	
8.85	9.66	10.64	11.39	13.31	16.84	0.05	0.13	0.22	0.30	0.37	0.43	0.49	0.53	0.56	2600	
9.09	9.92	10.92	11.68	13.61	17.06	0.05	0.13	0.23	0.32	0.38	0.45	0.51	0.55	0.58	2700	
9.33	10.17	11.18	11.96	13.89	17.23	0.05	0.14	0.24	0.33	0.40	0.47	0.52	0.57	0.60	2800	
9.56	10.42	11.44	12.22	14.15	17.36	0.05	0.14	0.25	0.34	0.41	0.48	0.54	0.59	0.63	2900	
9.79	10.66	11.69	12.47	14.39	17.45	0.05	0.15	0.26	0.35	0.43	0.50	0.56	0.61	0.65	3000	
10.21	11.10	12.15	12.93	14.81	17.48	0.06	0.16	0.27	0.37	0.45	0.53	0.60	0.65	0.69	3200	
10.60	11.50	12.55	13.33	15.15	17.32	0.06	0.17	0.29	0.40	0.48	0.56	0.64	0.69	0.73	3400	
10.96	11.87	12.91	13.67	15.39	16.94	0.07	0.18	0.31	0.42	0.51	0.60	0.67	0.73	0.78	3600	
11.28	12.19	13.21	13.95	15.54	—	0.07	0.19	0.33	0.44	0.54	0.63	0.71	0.77	0.82	3800	
11.57	12.46	13.46	14.16	15.58	—	0.07	0.20	0.34	0.47	0.57	0.66	0.75	0.82	0.86	4000	
11.82	12.69	13.65	14.30	15.52	—	0.08	0.21	0.36	0.49	0.60	0.70	0.79	0.86	0.91	4200	
12.03	12.87	13.78	14.37	15.35	—	0.08	0.22	0.38	0.51	0.62	0.73	0.82	0.90	0.95	4400	
12.19	13.01	13.85	14.37	15.06	—	0.08	0.23	0.40	0.54	0.65	0.76	0.86	0.94	0.99	4600	
12.32	13.08	13.85	14.29	14.65	—	0.09	0.24	0.41	0.56	0.68	0.80	0.90	0.98	1.04	4800	
12.40	13.11	13.78	14.12	—	—	0.09	0.25	0.43	0.59	0.71	0.83	0.94	1.02	1.08	5000	
12.43	13.08	13.64	13.87	—	—	0.09	0.26	0.45	0.61	0.74	0.86	0.97	1.06	1.12	5200	
12.42	12.99	13.43	13.54	—	—	0.10	0.27	0.46	0.63	0.77	0.90	1.01	1.10	1.17	5400	
12.35	12.84	13.14	—	—	—	0.10	0.28	0.48	0.66	0.80	0.93	1.05	1.14	1.21	5600	
12.24	12.63	12.77	—	—	—	0.11	0.29	0.50	0.68	0.82	0.96	1.08	1.18	1.25	5800	
12.08	12.36	—	—	—	—	0.11	0.30	0.52	0.70	0.85	1.00	1.12	1.22	1.30	6000	
11.86	12.02	—	—	—	—	0.11	0.31	0.53	0.73	0.88	1.03	1.16	1.26	1.34	6200	
11.58	11.61	—	—	—	—	0.12	0.32	0.55	0.75	0.91	1.06	1.20	1.30	1.38	6400	
11.25	—	—	—	—	—	0.12	0.33	0.57	0.77	0.94	1.10	1.23	1.35	1.43	6600	
10.86	—	—	—	—	—	0.12	0.34	0.58	0.80	0.97	1.13	1.27	1.39	1.47	6800	
—	—	—	—	—	—	0.13	0.35	0.60	0.82	0.99	1.16	1.31	1.43	1.51	7000	

3VX Basic Belt HP Ratings

V-BELT DRIVES

RPM of Faster Shaft	Sheave Outside Diameter (in inches)													
	2.20	2.35	2.50	2.65	2.80	3.00	3.15	3.35	3.65	4.12	4.50	4.75	5.00	5.30
575	0.55	0.64	0.73	0.83	0.92	1.04	1.13	1.25	1.43	1.72	1.94	2.09	2.24	2.41
690	0.64	0.75	0.86	0.97	1.08	1.22	1.33	1.48	1.69	2.02	2.29	2.47	2.64	2.85
725	0.66	0.78	0.90	1.01	1.13	1.28	1.39	1.54	1.77	2.12	2.40	2.58	2.76	2.98
870	0.77	0.91	1.05	1.18	1.32	1.50	1.63	1.81	2.08	2.49	2.82	3.04	3.26	3.51
950	0.83	0.98	1.13	1.28	1.42	1.62	1.77	1.96	2.25	2.70	3.06	3.29	3.52	3.80
1160	0.98	1.16	1.34	1.52	1.69	1.93	2.10	2.34	2.68	3.22	3.65	3.93	4.21	4.55
1425	1.16	1.38	1.59	1.81	2.02	2.31	2.52	2.80	3.22	3.86	4.38	4.72	5.06	5.46
1750	1.37	1.63	1.89	2.15	2.41	2.75	3.01	3.34	3.85	4.63	5.25	5.65	6.06	6.53
2850	2.00	2.41	2.81	3.21	3.61	4.14	4.53	5.05	5.82	6.99	7.92	8.53	9.12	9.82
3450	2.30	2.78	3.26	3.74	4.21	4.82	5.28	5.89	6.78	8.15	9.21	9.90	10.57	11.36
100	0.12	0.14	0.16	0.18	0.19	0.22	0.23	0.26	0.29	0.35	0.39	0.42	0.45	0.48
200	0.22	0.26	0.29	0.33	0.36	0.41	0.44	0.48	0.55	0.66	0.74	0.80	0.85	0.92
300	0.31	0.37	0.42	0.47	0.52	0.58	0.63	0.70	0.80	0.95	1.07	1.16	1.24	1.33
400	0.40	0.47	0.54	0.60	0.67	0.75	0.82	0.91	1.03	1.24	1.40	1.50	1.61	1.73
500	0.49	0.57	0.65	0.73	0.81	0.92	1.00	1.11	1.27	1.51	1.71	1.84	1.97	2.13
600	0.57	0.66	0.76	0.86	0.95	1.08	1.18	1.30	1.49	1.78	2.02	2.17	2.33	2.51
700	0.65	0.76	0.87	0.98	1.09	1.24	1.35	1.49	1.71	2.05	2.32	2.50	2.68	2.89
800	0.72	0.85	0.98	1.10	1.23	1.39	1.52	1.68	1.93	2.31	2.62	2.82	3.02	3.26
900	0.80	0.94	1.08	1.22	1.36	1.54	1.68	1.87	2.14	2.57	2.91	3.13	3.36	3.62
1000	0.87	1.02	1.18	1.34	1.49	1.69	1.85	2.05	2.35	2.82	3.20	3.45	3.69	3.98
1100	0.94	1.11	1.28	1.45	1.62	1.84	2.01	2.23	2.56	3.07	3.48	3.75	4.02	4.34
1200	1.01	1.19	1.38	1.56	1.74	1.99	2.17	2.41	2.76	3.32	3.76	4.05	4.34	4.69
1300	1.08	1.28	1.47	1.67	1.87	2.13	2.32	2.58	2.97	3.56	4.04	4.35	4.66	5.03
1400	1.14	1.36	1.57	1.78	1.99	2.27	2.48	2.75	3.17	3.80	4.32	4.65	4.98	5.37
1500	1.21	1.44	1.66	1.89	2.11	2.41	2.63	2.93	3.36	4.04	4.59	4.94	5.29	5.71
1600	1.27	1.52	1.76	1.99	2.23	2.55	2.78	3.09	3.56	4.28	4.85	5.23	5.60	6.04
1700	1.34	1.59	1.85	2.10	2.35	2.68	2.93	3.26	3.75	4.51	5.12	5.51	5.90	6.37
1800	1.40	1.67	1.94	2.20	2.47	2.82	3.08	3.43	3.94	4.74	5.38	5.79	6.21	6.70
1900	1.46	1.74	2.02	2.30	2.58	2.95	3.22	3.59	4.13	4.97	5.64	6.07	6.50	7.01
2000	1.52	1.82	2.11	2.40	2.70	3.08	3.37	3.75	4.32	5.19	5.89	6.34	6.79	7.33
2100	1.58	1.89	2.20	2.50	2.81	3.21	3.51	3.91	4.50	5.41	6.14	6.61	7.08	7.64
2200	1.64	1.96	2.28	2.60	2.92	3.34	3.65	4.07	4.68	5.63	6.39	6.88	7.37	7.94
2300	1.70	2.03	2.37	2.70	3.03	3.47	3.79	4.22	4.86	5.85	6.63	7.14	7.65	8.25
2400	1.75	2.10	2.45	2.80	3.14	3.59	3.93	4.38	5.04	6.06	6.88	7.40	7.92	8.54
2500	1.81	2.17	2.53	2.89	3.25	3.72	4.07	4.53	5.22	6.28	7.12	7.66	8.20	8.83
2600	1.87	2.24	2.61	2.98	3.35	3.84	4.20	4.68	5.39	6.48	7.35	7.91	8.47	9.12
2700	1.92	2.31	2.69	3.08	3.46	3.96	4.33	4.83	5.56	6.69	7.58	8.16	8.73	9.40
2800	1.97	2.37	2.77	3.17	3.56	4.08	4.47	4.98	5.73	6.89	7.81	8.40	8.99	9.68
2900	2.03	2.44	2.85	3.26	3.66	4.20	4.60	5.12	5.90	7.09	8.04	8.65	9.25	9.95
3000	2.08	2.50	2.93	3.35	3.76	4.31	4.72	5.26	6.06	7.29	8.26	8.88	9.50	10.22
3200	2.18	2.63	3.08	3.52	3.96	4.54	4.98	5.55	6.39	7.68	8.69	9.34	9.99	10.74
3400	2.28	2.75	3.23	3.69	4.16	4.77	5.22	5.82	6.71	8.05	9.11	9.79	10.46	11.24
3600	2.37	2.87	3.37	3.86	4.35	4.99	5.46	6.09	7.01	8.42	9.52	10.22	10.91	11.71
3800	2.47	2.99	3.51	4.02	4.53	5.20	5.70	6.35	7.31	8.77	9.91	10.63	11.34	12.16
4000	2.56	3.10	3.65	4.18	4.71	5.41	5.92	6.60	7.60	9.11	10.28	11.03	11.75	12.59
4200	2.64	3.21	3.78	4.33	4.89	5.61	6.15	6.85	7.88	9.44	10.64	11.40	12.14	12.99
4400	2.73	3.32	3.91	4.48	5.06	5.81	6.36	7.09	8.15	9.75	10.98	11.76	12.51	13.37
4600	2.81	3.42	4.03	4.63	5.22	6.00	6.57	7.32	8.41	10.05	11.31	12.10	12.85	13.72
4800	2.89	3.52	4.15	4.77	5.38	6.18	6.77	7.54	8.66	10.34	11.61	12.41	13.18	14.05
5000	2.96	3.62	4.27	4.90	5.53	6.36	6.96	7.75	8.90	10.61	11.90	12.71	13.47	14.34
5200	3.03	3.71	4.38	5.04	5.68	6.53	7.15	7.96	9.13	10.87	12.17	12.98	13.75	14.61
5400	3.10	3.80	4.49	5.16	5.83	6.69	7.33	8.15	9.35	11.11	12.43	13.23	13.99	14.84
5600	3.17	3.89	4.59	5.28	5.96	6.85	7.50	8.34	9.56	11.34	12.66	13.46	14.22	15.05
5800	3.23	3.97	4.69	5.40	6.10	7.00	7.66	8.52	9.76	11.55	12.87	13.67	14.41	15.22
6000	3.29	4.05	4.79	5.51	6.22	7.15	7.82	8.69	9.94	11.75	13.06	13.85	14.57	15.36
6200	3.35	4.12	4.88	5.62	6.34	7.28	7.97	8.85	10.11	11.92	13.23	14.01	14.71	15.46
6400	3.40	4.19	4.96	5.72	6.46	7.41	8.11	9.00	10.27	12.09	13.38	14.14	14.82	15.53
6600	3.45	4.26	5.05	5.82	6.57	7.54	8.24	9.14	10.42	12.23	13.50	14.24	14.89	15.56
6800	3.50	4.32	5.12	5.91	6.67	7.65	8.36	9.27	10.56	12.36	13.60	14.32	14.94	15.56
7000	3.54	4.38	5.20	5.99	6.77	7.76	8.48	9.40	10.68	12.46	13.68	14.37	14.95	15.52

RIM SPEEDS EXCEED 6500 FEET PER MINUTE.



Basic Belt 3VX HP Ratings

Sheave Outside Diameter (in inches)						"Add-On" HP for Speed Ratio										RPM of Faster Shaft
5.60	6.00	6.50	6.90	8.00	10.60	1.02- 1.05	1.06- 1.11	1.12- 1.18	1.19- 1.26	1.27- 1.38	1.39- 1.57	1.58- 1.94	1.95- 3.38	3.39 & Up		
2.59	2.82	3.11	3.34	3.97	5.42	0.01	0.02	0.04	0.05	0.07	0.08	0.09	0.09	0.10	575	
3.06	3.33	3.67	3.95	4.69	6.39	0.01	0.03	0.05	0.06	0.08	0.09	0.10	0.11	0.12	690	
3.20	3.49	3.84	4.13	4.90	6.69	0.01	0.03	0.05	0.07	0.08	0.10	0.11	0.12	0.13	725	
3.77	4.11	4.53	4.87	5.78	7.87	0.01	0.03	0.06	0.08	0.10	0.12	0.13	0.14	0.15	870	
4.08	4.45	4.91	5.27	6.25	8.51	0.01	0.04	0.07	0.09	0.11	0.13	0.14	0.16	0.16	950	
4.88	5.32	5.87	6.30	7.47	10.13	0.02	0.05	0.08	0.11	0.13	0.15	0.17	0.19	0.20	1160	
5.86	6.38	7.03	7.55	8.94	12.05	0.02	0.06	0.10	0.13	0.16	0.19	0.21	0.23	0.25	1425	
7.01	7.63	8.40	9.01	10.64	14.22	0.03	0.07	0.12	0.16	0.20	0.23	0.26	0.29	0.30	1750	
10.50	11.40	12.48	13.31	15.46	19.56	0.04	0.11	0.20	0.27	0.33	0.38	0.43	0.47	0.49	2850	
12.12	13.11	14.28	15.16	17.35	20.86	0.05	0.14	0.24	0.32	0.39	0.46	0.52	0.56	0.60	3450	
0.52	0.56	0.62	0.67	0.79	1.08	0.00	0.00	0.01	0.01	0.01	0.01	0.02	0.02	0.02	100	
0.98	1.07	1.18	1.27	1.50	2.05	0.00	0.01	0.01	0.02	0.02	0.03	0.03	0.03	0.03	200	
1.43	1.56	1.71	1.84	2.18	2.98	0.00	0.01	0.02	0.03	0.03	0.04	0.05	0.05	0.05	300	
1.86	2.03	2.23	2.40	2.85	3.89	0.01	0.02	0.03	0.04	0.05	0.05	0.06	0.07	0.07	400	
2.28	2.48	2.74	2.94	3.49	4.77	0.01	0.02	0.03	0.05	0.06	0.07	0.08	0.08	0.09	500	
2.69	2.93	3.23	3.47	4.13	5.63	0.01	0.02	0.04	0.06	0.07	0.08	0.09	0.10	0.10	600	
3.10	3.38	3.72	4.00	4.75	6.48	0.01	0.03	0.05	0.07	0.08	0.09	0.11	0.11	0.12	700	
3.50	3.81	4.20	4.51	5.36	7.30	0.01	0.03	0.06	0.08	0.09	0.11	0.12	0.13	0.14	800	
3.89	4.24	4.67	5.02	5.96	8.11	0.01	0.04	0.06	0.08	0.10	0.12	0.14	0.15	0.16	900	
4.27	4.66	5.14	5.52	6.55	8.90	0.01	0.04	0.07	0.09	0.11	0.13	0.15	0.16	0.17	1000	
4.65	5.07	5.59	6.01	7.13	9.68	0.02	0.04	0.08	0.10	0.13	0.15	0.17	0.18	0.19	1100	
5.03	5.48	6.04	6.49	7.69	10.43	0.02	0.05	0.08	0.11	0.14	0.16	0.18	0.20	0.21	1200	
5.40	5.89	6.49	6.97	8.25	11.16	0.02	0.05	0.09	0.12	0.15	0.17	0.20	0.21	0.23	1300	
5.77	6.29	6.93	7.43	8.80	11.88	0.02	0.06	0.10	0.13	0.16	0.19	0.21	0.23	0.24	1400	
6.13	6.68	7.36	7.89	9.34	12.57	0.02	0.06	0.10	0.14	0.17	0.20	0.23	0.25	0.26	1500	
6.48	7.06	7.78	8.35	9.87	13.25	0.02	0.06	0.11	0.15	0.18	0.21	0.24	0.26	0.28	1600	
6.83	7.45	8.20	8.79	10.39	13.90	0.02	0.07	0.12	0.16	0.19	0.23	0.26	0.28	0.29	1700	
7.18	7.82	8.61	9.23	10.89	14.53	0.03	0.07	0.12	0.17	0.21	0.24	0.27	0.29	0.31	1800	
7.52	8.19	9.01	9.66	11.39	15.14	0.03	0.08	0.13	0.18	0.22	0.25	0.29	0.31	0.33	1900	
7.86	8.55	9.41	10.08	11.87	15.72	0.03	0.08	0.14	0.19	0.23	0.27	0.30	0.33	0.35	2000	
8.19	8.91	9.80	10.49	12.34	16.28	0.03	0.08	0.14	0.20	0.24	0.28	0.32	0.34	0.36	2100	
8.51	9.26	10.18	10.90	12.80	16.81	0.03	0.09	0.15	0.21	0.25	0.29	0.33	0.36	0.38	2200	
8.84	9.61	10.56	11.29	13.24	17.31	0.03	0.09	0.16	0.22	0.26	0.31	0.35	0.38	0.40	2300	
9.15	9.95	10.92	11.68	13.68	17.79	0.03	0.10	0.17	0.23	0.27	0.32	0.36	0.39	0.42	2400	
9.46	10.28	11.28	12.06	14.10	18.23	0.04	0.10	0.17	0.23	0.29	0.33	0.38	0.41	0.43	2500	
9.77	10.61	11.63	12.43	14.50	18.65	0.04	0.10	0.18	0.24	0.30	0.35	0.39	0.43	0.45	2600	
10.07	10.93	11.98	12.79	14.90	19.04	0.04	0.10	0.19	0.25	0.31	0.36	0.41	0.44	0.47	2700	
10.36	11.24	12.31	13.14	15.27	19.39	0.04	0.10	0.19	0.26	0.32	0.37	0.42	0.46	0.49	2800	
10.65	11.55	12.64	13.48	15.64	19.72	0.04	0.10	0.20	0.27	0.33	0.39	0.44	0.47	0.50	2900	
10.93	11.85	12.96	13.81	15.98	20.01	0.04	0.12	0.21	0.28	0.34	0.40	0.45	0.49	0.52	3000	
11.47	12.43	13.57	14.44	16.63	20.48	0.05	0.13	0.22	0.30	0.36	0.43	0.48	0.52	0.56	3200	
12.00	12.97	14.14	15.02	17.22	20.81	0.05	0.13	0.23	0.32	0.39	0.45	0.51	0.56	0.59	3400	
12.49	13.49	14.67	15.56	17.73	20.98	0.05	0.14	0.25	0.34	0.41	0.48	0.54	0.59	0.62	3600	
12.96	13.97	15.17	16.05	18.17	—	0.06	0.15	0.26	0.36	0.43	0.51	0.57	0.62	0.66	3800	
13.40	14.42	15.62	16.50	18.54	—	0.06	0.16	0.28	0.38	0.46	0.53	0.60	0.65	0.69	4000	
13.81	14.84	16.02	16.89	18.82	—	0.06	0.17	0.29	0.39	0.48	0.56	0.63	0.69	0.73	4200	
14.19	15.22	16.39	17.22	19.03	—	0.06	0.17	0.30	0.41	0.50	0.59	0.66	0.72	0.76	4400	
14.54	15.56	16.70	17.50	19.15	—	0.07	0.18	0.32	0.43	0.52	0.61	0.69	0.75	0.80	4600	
14.86	15.86	16.97	17.72	19.18	—	0.07	0.19	0.33	0.45	0.55	0.64	0.72	0.79	0.83	4800	
15.15	16.13	17.18	17.89	—	—	0.07	0.20	0.35	0.47	0.57	0.67	0.75	0.82	0.87	5000	
15.40	16.35	17.35	17.99	—	—	0.08	0.21	0.36	0.49	0.59	0.69	0.78	0.85	0.90	5200	
15.62	16.52	17.45	18.02	—	—	0.08	0.21	0.37	0.51	0.62	0.72	0.81	0.88	0.94	5400	
15.79	16.66	17.51	—	—	—	0.08	0.22	0.39	0.53	0.64	0.75	0.84	0.92	0.97	5600	
15.94	16.74	17.50	—	—	—	0.08	0.23	0.40	0.55	0.66	0.77	0.87	0.95	1.01	5800	
16.04	16.78	—	—	—	—	0.09	0.24	0.41	0.56	0.68	0.80	0.90	0.98	1.04	6000	
16.10	16.77	—	—	—	—	0.09	0.25	0.43	0.58	0.71	0.83	0.93	1.02	1.08	6200	
16.12	16.71	—	—	—	—	0.09	0.25	0.44	0.60	0.73	0.85	0.96	1.05	1.11	6400	
16.10	—	—	—	—	—	0.10	0.26	0.46	0.62	0.75	0.88	0.99	1.08	1.15	6600	
16.04	—	—	—	—	—	0.10	0.27	0.47	0.64	0.78	0.91	1.02	1.11	1.18	6800	
—	—	—	—	—	—	0.10	0.28	0.48	0.66	0.80	0.93	1.05	1.15	1.21	7000	

V-BELT DRIVES

5V Basic Belt HP Ratings



V-BELT DRIVES

RPM of Faster Shaft	Sheave Outside Diameter (in inches)															
	4.40	4.65	4.90	5.20	5.50	5.90	6.30	6.70	7.10	7.50	8.00	8.50	9.00	9.25	9.75	10.30
435	1.55	1.88	2.20	2.58	2.97	3.48	3.98	4.48	4.99	5.48	6.10	6.72	7.33	7.64	8.25	8.91
485	1.69	2.04	2.40	2.83	3.25	3.81	4.37	4.93	5.48	6.03	6.71	7.39	8.07	8.41	9.08	9.81
575	1.91	2.33	2.75	3.24	3.74	4.40	5.05	5.70	6.35	6.99	7.79	8.58	9.37	9.76	10.55	11.40
585	1.94	2.36	2.78	3.29	3.79	4.46	5.12	5.78	6.44	7.09	7.91	8.71	9.51	9.91	10.71	11.57
690	2.18	2.67	3.17	3.76	4.34	5.12	5.89	6.66	7.42	8.17	9.12	10.05	10.98	11.44	12.36	13.36
725	2.26	2.78	3.29	3.91	4.52	5.33	6.14	6.94	7.74	8.53	9.51	10.49	11.45	11.94	12.89	13.94
870	2.56	3.17	3.78	4.51	5.23	6.19	7.14	8.08	9.02	9.95	11.10	12.24	13.38	13.94	15.06	16.27
950	2.72	3.38	4.04	4.83	5.61	6.64	7.67	8.69	9.70	10.70	11.95	13.18	14.40	15.00	16.21	17.51
1160	3.09	3.89	4.67	5.61	6.55	7.78	9.00	10.21	11.41	12.60	14.07	15.52	16.95	17.66	19.06	20.59
1425	3.50	4.45	5.39	6.52	7.63	9.10	10.56	11.99	13.41	14.81	16.53	18.23	19.89	20.71	22.33	24.08
1750	3.90	5.04	6.16	7.49	8.81	10.55	12.26	13.94	15.60	17.22	19.21	21.15	23.04	23.96	25.77	27.70
2850	4.47	6.12	7.75	9.65	11.50	13.90	16.21	18.42	20.53	22.53	24.88	27.06	29.04	29.96	31.65	33.25
3450	4.23	6.09	7.89	9.98	12.00	14.56	16.97	19.21	21.29	23.19	25.29	27.09	28.57	29.18	30.14	30.76
100	0.49	0.57	0.65	0.75	0.84	0.97	1.10	1.23	1.36	1.48	1.64	1.80	1.96	2.04	2.19	2.36
200	0.85	1.01	1.16	1.35	1.54	1.78	2.03	2.27	2.52	2.76	3.06	3.36	3.66	3.81	4.11	4.44
300	1.17	1.40	1.63	1.90	2.17	2.53	2.89	3.25	3.60	3.96	4.40	4.83	5.27	5.49	5.92	6.39
400	1.46	1.76	2.06	2.41	2.77	3.24	3.70	4.17	4.63	5.10	5.67	6.24	6.81	7.09	7.65	8.27
500	1.72	2.09	2.46	2.90	3.33	3.91	4.48	5.06	5.63	6.19	6.90	7.59	8.29	8.64	9.33	10.08
600	1.97	2.41	2.84	3.36	3.87	4.56	5.24	5.91	6.58	7.25	8.08	8.91	9.72	10.13	10.94	11.83
700	2.20	2.70	3.20	3.80	4.39	5.18	5.96	6.74	7.51	8.28	9.23	10.17	11.11	11.58	12.51	13.52
800	2.42	2.98	3.55	4.22	4.89	5.78	6.66	7.54	8.41	9.27	10.34	11.41	12.46	12.98	14.03	15.16
900	2.62	3.25	3.88	4.63	5.37	6.36	7.34	8.31	9.28	10.23	11.42	12.60	13.76	14.34	15.49	16.74
1000	2.81	3.51	4.20	5.02	5.84	6.92	8.00	9.06	10.12	11.17	12.47	13.75	15.02	15.66	16.91	18.27
1100	2.99	3.75	4.50	5.40	6.29	7.46	8.63	9.79	10.94	12.07	13.48	14.87	16.24	16.92	18.27	19.73
1200	3.16	3.98	4.79	5.76	6.72	7.99	9.25	10.49	11.73	12.95	14.46	15.95	17.42	18.14	19.58	21.14
1300	3.32	4.19	5.07	6.10	7.13	8.50	9.84	11.17	12.49	13.79	15.40	16.99	18.55	19.32	20.84	22.49
1400	3.46	4.40	5.33	6.44	7.54	8.98	10.42	11.83	13.23	14.61	16.31	17.99	19.63	20.44	22.04	23.77
1500	3.60	4.60	5.58	6.76	7.92	9.46	10.97	12.47	13.94	15.40	17.19	18.94	20.67	21.51	23.18	24.98
1600	3.73	4.78	5.82	7.06	8.29	9.91	11.50	13.08	14.62	16.15	18.02	19.86	21.65	22.53	24.27	26.12
1700	3.85	4.95	6.05	7.35	8.64	10.34	12.01	13.66	15.28	16.87	18.82	20.73	22.59	23.50	25.29	27.19
1800	3.95	5.11	6.27	7.63	8.98	10.76	12.50	14.22	15.91	17.56	19.58	21.55	23.47	24.41	26.24	28.19
1900	4.05	5.27	6.47	7.89	9.30	11.15	12.97	14.75	16.50	18.22	20.30	22.33	24.30	25.26	27.13	29.10
2000	4.14	5.41	6.66	8.14	9.61	11.53	13.42	15.26	17.07	18.83	20.98	23.06	25.07	26.05	27.94	29.94
2100	4.22	5.53	6.84	8.38	9.90	11.89	13.84	15.74	17.60	19.42	21.62	23.74	25.78	26.77	28.68	30.69
2200	4.28	5.65	7.00	8.60	10.17	12.23	14.24	16.20	18.11	19.96	22.21	24.37	26.43	27.43	29.35	31.35
2300	4.34	5.76	7.15	8.80	10.43	12.54	14.61	16.62	18.58	20.47	22.76	24.94	27.02	28.02	29.94	31.91
2400	4.39	5.85	7.29	8.99	10.66	12.84	14.96	17.02	19.01	20.94	23.26	25.46	27.55	28.55	30.45	32.39
2500	4.43	5.93	7.42	9.17	10.88	13.12	15.28	17.38	19.41	21.37	23.71	25.92	28.00	28.99	30.87	32.76
2600	4.45	6.00	7.53	9.32	11.08	13.37	15.58	17.72	19.78	21.76	24.11	26.32	28.39	29.37	31.21	33.04
2700	4.47	6.06	7.63	9.47	11.27	13.60	15.85	18.02	20.11	22.10	24.46	26.66	28.71	29.67	31.45	33.21
2800	4.47	6.11	7.71	9.59	11.43	13.81	16.10	18.29	20.40	22.40	24.76	26.94	28.95	29.88	31.60	33.27
2900	4.47	6.14	7.78	9.70	11.57	13.99	16.31	18.53	20.65	22.65	25.00	27.16	29.12	30.02	31.66	33.21
3000	4.45	6.16	7.83	9.79	11.70	14.15	16.50	18.74	20.86	22.86	25.19	27.30	29.20	30.07	31.62	33.04
3100	4.42	6.17	7.87	9.87	11.80	14.29	16.66	18.91	21.03	23.02	25.32	27.38	29.21	30.03	31.48	32.76
3200	4.38	6.16	7.90	9.92	11.89	14.40	16.78	19.04	21.16	23.13	25.39	27.39	29.14	29.91	31.23	32.35
3300	4.33	6.14	7.91	9.96	11.95	14.48	16.88	19.14	21.24	23.19	25.40	27.33	28.98	29.69	30.88	31.81
3400	4.27	6.11	7.90	9.98	11.99	14.54	16.95	19.20	21.28	23.20	25.34	27.19	28.73	29.37	30.41	31.15
3500	4.19	6.06	7.88	9.98	12.01	14.57	16.98	19.22	21.28	23.16	25.23	26.98	28.39	28.96	29.83	30.35
3600	4.10	6.00	7.84	9.96	12.00	14.58	16.98	19.20	21.23	23.06	25.05	26.69	27.96	28.45	29.14	29.41
3700	4.00	5.92	7.78	9.93	11.98	14.55	16.95	19.14	21.13	22.90	24.80	26.31	27.43	27.84	28.32	28.34
3800	3.89	5.83	7.71	9.87	11.93	14.50	16.88	19.04	20.99	22.69	24.48	25.86	26.81	27.12	27.39	—
3900	3.76	5.73	7.62	9.79	11.85	14.42	16.78	18.90	20.79	22.42	24.09	25.32	26.09	26.30	26.32	—
4000	3.63	5.60	7.51	9.69	11.75	14.31	16.64	18.72	20.54	22.09	23.63	24.70	25.27	25.36	—	—
4200	3.31	5.32	7.24	9.43	11.48	14.00	16.25	18.22	19.89	21.25	22.49	23.19	23.31	—	—	—
4400	2.93	4.96	6.89	9.07	11.10	13.55	15.70	17.53	19.02	20.16	21.04	21.31	—	—	—	—
4600	2.50	4.54	6.47	8.63	10.62	12.98	15.00	16.66	17.93	18.80	19.28	—	—	—	—	—
4800	2.01	4.05	5.97	8.09	10.02	12.27	14.13	15.59	16.60	17.16	17.17	—	—	—	—	—
5000	1.46	3.49	5.38	7.45	9.31	11.42	13.10	14.31	15.03	15.23	—	—	—	—	—	—

■ RIM SPEEDS EXCEED 6500 FEET PER MINUTE.



Basic Belt HP Ratings 5V

Sheave Outside Diameter (in inches)								"Add-On" HP for Speed Ratio									RPM of Faster Shaft
10.90	11.30	11.80	12.50	13.20	14.00	15.00	16.00	1.02- 1.05	1.06- 1.11	1.12- 1.18	1.19- 1.26	1.27- 1.38	1.39- 1.57	1.58- 1.94	1.95- 3.38	3.39- & Up	
9.64	10.11	10.71	11.54	12.37	13.31	14.47	15.62	0.04	0.11	0.20	0.27	0.33	0.38	0.43	0.47	0.50	435
10.61	11.14	11.80	12.71	13.62	14.65	15.93	17.19	0.05	0.13	0.22	0.30	0.37	0.43	0.48	0.53	0.56	485
12.33	12.94	13.70	14.76	15.82	17.01	18.48	19.94	0.06	0.15	0.26	0.36	0.43	0.51	0.57	0.62	0.66	575
12.51	13.14	13.91	14.99	16.06	17.27	18.76	20.24	0.06	0.15	0.27	0.36	0.44	0.52	0.58	0.63	0.67	585
14.44	15.16	16.05	17.29	18.51	19.90	21.61	23.29	0.07	0.18	0.32	0.43	0.52	0.61	0.69	0.75	0.79	690
15.07	15.82	16.75	18.04	19.31	20.75	22.52	24.27	0.07	0.19	0.33	0.45	0.55	0.64	0.72	0.79	0.83	725
17.59	18.46	19.53	21.02	22.49	24.14	26.16	28.14	0.08	0.23	0.40	0.54	0.66	0.77	0.87	0.94	1.00	870
18.92	19.85	21.00	22.59	24.15	25.90	28.04	30.13	0.09	0.25	0.43	0.59	0.72	0.84	0.94	1.03	1.09	950
22.22	23.29	24.61	26.43	28.20	30.17	32.55	34.83	0.11	0.30	0.53	0.72	0.88	1.02	1.15	1.26	1.33	1160
25.93	27.14	28.62	30.63	32.57	34.70	37.20	39.54	0.14	0.37	0.65	0.89	1.08	1.26	1.42	1.54	1.64	1425
29.72	31.03	32.60	34.70	36.67	38.75	41.09	43.13	0.17	0.46	0.80	1.09	1.32	1.55	1.74	1.90	2.01	1750
34.70	35.48	36.23	36.87	36.98	—	—	—	0.27	0.75	1.30	1.77	2.15	2.52	2.83	3.09	3.27	2850
30.91	—	—	—	—	—	—	—	0.33	0.91	1.58	2.15	2.60	3.05	3.43	3.74	3.96	3450
2.55	2.67	2.83	3.04	3.26	3.50	3.80	4.11	0.01	0.03	0.05	0.06	0.08	0.09	0.10	0.11	0.11	100
4.79	5.03	5.32	5.73	6.14	6.60	7.18	7.75	0.02	0.05	0.09	0.12	0.15	0.18	0.20	0.22	0.23	200
6.91	7.25	7.68	8.27	8.86	9.54	10.37	11.20	0.03	0.08	0.14	0.19	0.23	0.27	0.30	0.33	0.34	300
8.94	9.39	9.94	10.71	11.48	12.35	13.43	14.50	0.04	0.10	0.18	0.25	0.30	0.35	0.40	0.43	0.46	400
10.90	11.44	12.12	13.06	13.99	15.05	16.36	17.66	0.05	0.13	0.23	0.31	0.38	0.44	0.50	0.54	0.57	500
12.79	13.43	14.22	15.32	16.41	17.65	19.17	20.68	0.06	0.16	0.27	0.37	0.45	0.53	0.60	0.65	0.69	600
14.62	15.35	16.25	17.50	18.74	20.14	21.87	23.57	0.07	0.18	0.32	0.44	0.53	0.62	0.70	0.76	0.80	700
16.39	17.20	18.21	19.60	20.98	22.53	24.44	26.31	0.08	0.21	0.37	0.50	0.60	0.71	0.80	0.87	0.92	800
18.09	18.98	20.09	21.61	23.12	24.81	26.88	28.89	0.09	0.24	0.41	0.56	0.68	0.80	0.90	0.98	1.03	900
19.73	20.70	21.89	23.54	25.16	26.97	29.18	31.32	0.10	0.26	0.46	0.62	0.75	0.88	0.99	1.08	1.15	1000
21.31	22.34	23.62	25.37	27.09	29.01	31.33	33.57	0.11	0.29	0.50	0.68	0.83	0.97	1.09	1.19	1.26	1100
22.81	23.91	25.26	27.11	28.91	30.92	33.33	35.63	0.12	0.31	0.55	0.75	0.91	1.06	1.19	1.30	1.38	1200
24.24	25.40	26.81	28.74	30.62	32.69	35.16	37.50	0.13	0.34	0.59	0.81	0.98	1.15	1.29	1.41	1.49	1300
25.60	26.80	28.27	30.27	32.20	34.31	36.82	39.16	0.13	0.37	0.64	0.87	1.06	1.24	1.39	1.52	1.61	1400
26.88	28.12	29.64	31.69	33.65	35.79	38.29	40.59	0.14	0.39	0.69	0.93	1.13	1.33	1.49	1.63	1.72	1500
28.08	29.36	30.90	32.98	34.96	37.10	39.57	41.80	0.15	0.42	0.73	1.00	1.21	1.41	1.59	1.73	1.84	1600
29.20	30.49	32.06	34.16	36.14	38.24	40.64	42.75	0.16	0.45	0.78	1.06	1.28	1.50	1.69	1.84	1.95	1700
30.23	31.53	33.11	35.20	37.16	39.21	41.49	43.45	0.17	0.47	0.82	1.12	1.36	1.59	1.79	1.95	2.07	1800
31.16	32.47	34.05	36.11	38.02	39.99	42.12	43.87	0.18	0.50	0.87	1.18	1.43	1.68	1.89	2.06	2.18	1900
32.00	33.31	34.86	36.88	38.72	40.58	42.52	44.01	0.19	0.52	0.91	1.24	1.51	1.77	1.99	2.17	2.30	2000
32.74	34.03	35.55	37.51	39.25	40.96	42.66	43.85	0.20	0.55	0.96	1.31	1.59	1.86	2.09	2.28	2.41	2100
33.37	34.64	36.11	37.98	39.60	41.13	42.54	43.37	0.21	0.58	1.01	1.37	1.66	1.94	2.19	2.38	2.53	2200
33.90	35.13	36.54	38.29	39.76	41.08	42.16	42.57	0.22	0.60	1.05	1.43	1.74	2.03	2.29	2.49	2.64	2300
34.32	35.49	36.82	38.43	39.73	40.80	41.49	41.43	0.23	0.63	1.10	1.49	1.81	2.12	2.39	2.60	2.76	2400
34.62	35.73	36.96	38.41	39.49	40.28	40.53	—	0.24	0.66	1.14	1.56	1.89	2.21	2.49	2.71	2.87	2500
34.80	35.83	36.95	38.20	39.05	39.51	—	—	0.25	0.68	1.19	1.62	1.96	2.30	2.59	2.82	2.99	2600
34.86	35.80	36.79	37.81	38.39	38.48	—	—	0.26	0.71	1.23	1.68	2.04	2.39	2.69	2.93	3.10	2700
34.79	35.62	36.46	37.23	37.51	—	—	—	0.27	0.73	1.28	1.74	2.11	2.47	2.79	3.03	3.22	2800
34.58	35.30	35.97	36.45	36.40	—	—	—	0.28	0.79	1.33	1.80	2.19	2.56	2.88	3.14	3.33	2900
34.24	34.82	35.30	35.47	—	—	—	—	0.29	0.79	1.37	1.87	2.26	2.65	2.98	3.25	3.45	3000
33.76	34.19	34.46	—	—	—	—	—	0.30	0.81	1.42	1.93	2.34	2.74	3.08	3.36	3.56	3100
33.14	33.40	33.43	—	—	—	—	—	0.31	0.84	1.46	1.99	2.42	2.83	3.18	3.47	3.68	3200
32.36	32.45	—	—	—	—	—	—	0.32	0.87	1.51	2.05	2.49	2.92	3.28	3.58	3.79	3300
31.44	31.32	—	—	—	—	—	—	0.33	0.89	1.55	2.12	2.57	3.00	3.38	3.69	3.91	3400
30.35	—	—	—	—	—	—	—	0.34	0.92	1.60	2.18	2.64	3.09	3.48	3.79	4.02	3500
—	—	—	—	—	—	—	—	0.35	0.94	1.64	2.24	2.72	3.18	3.58	3.90	4.13	3600
—	—	—	—	—	—	—	—	0.36	0.97	1.69	2.30	2.79	3.27	3.68	4.01	4.25	3700
—	—	—	—	—	—	—	—	0.37	1.00	1.74	2.36	2.87	3.36	3.78	4.12	4.36	3800
—	—	—	—	—	—	—	—	0.38	1.02	1.78	2.43	2.94	3.45	3.88	4.23	4.48	3900
—	—	—	—	—	—	—	—	0.39	1.05	1.83	2.49	3.02	3.53	3.98	4.34	4.59	4000
—	—	—	—	—	—	—	—	0.40	1.10	1.92	2.61	3.17	3.71	4.18	4.55	4.82	4200
—	—	—	—	—	—	—	—	0.42	1.15	2.01	2.74	3.32	3.89	4.38	4.77	5.05	4400
—	—	—	—	—	—	—	—	0.44	1.21	2.10	2.86	3.47	4.06	4.58	4.99	5.28	4600
—	—	—	—	—	—	—	—	0.46	1.26	2.19	2.99	3.62	4.24	4.77	5.20	5.51	4800
—	—	—	—	—	—	—	—	0.48	1.31	2.28	3.11	3.77	4.42	4.97	5.42	5.74	5000

V-BELT DRIVES

5VX Basic Belt HP Ratings

V-BELT DRIVES

RPM of Faster Shaft	Sheave Outside Diameter (in inches)															
	4.40	4.65	4.90	5.20	5.50	5.90	6.30	6.70	7.10	7.50	8.00	8.50	9.00	9.25	9.75	10.30
435	2.57	2.90	3.22	3.61	3.99	4.51	5.01	5.52	6.03	6.53	7.16	7.78	8.40	8.71	9.32	10.00
485	2.82	3.18	3.54	3.97	4.40	4.96	5.53	6.09	6.65	7.20	7.90	8.58	9.27	9.61	10.29	11.04
575	3.27	3.69	4.11	4.61	5.11	5.77	6.43	7.09	7.74	8.40	9.21	10.01	10.81	11.21	12.01	12.88
585	3.32	3.74	4.17	4.68	5.19	5.86	6.53	7.20	7.87	8.53	9.35	10.17	10.98	11.39	12.19	13.08
690	3.82	4.32	4.81	5.41	6.00	6.78	7.57	8.34	9.12	9.88	10.84	11.79	12.74	13.21	14.15	15.17
725	3.98	4.50	5.02	5.65	6.27	7.09	7.90	8.72	9.53	10.33	11.33	12.33	13.31	13.81	14.79	15.86
870	4.64	5.26	5.88	6.61	7.35	8.32	9.28	10.24	11.20	12.15	13.33	14.50	15.66	16.24	17.39	18.65
950	5.00	5.67	6.34	7.13	7.93	8.98	10.03	11.07	12.10	13.13	14.40	15.67	16.92	17.55	18.79	20.15
1160	5.90	6.71	7.51	8.46	9.42	10.68	11.93	13.17	14.40	15.63	17.15	18.65	20.14	20.89	22.36	23.96
1425	6.98	7.95	8.92	10.07	11.21	12.73	14.23	15.71	17.19	18.65	20.45	22.24	24.01	24.88	26.61	28.49
1750	8.23	9.40	10.55	11.93	13.30	15.11	16.89	18.66	20.41	22.13	24.26	26.35	28.41	29.43	31.44	33.60
2850	11.86	13.62	15.35	17.40	19.42	22.06	24.64	27.15	29.60	31.98	34.85	37.61	40.24	41.51	43.95	46.48
3450	13.45	15.47	17.46	19.80	22.09	25.06	27.93	30.69	33.34	35.87	38.87	41.67	44.26	45.48	47.74	49.95
100	0.71	0.79	0.87	0.97	1.07	1.20	1.33	1.45	1.58	1.71	1.87	2.02	2.18	2.26	2.42	2.59
200	1.31	1.47	1.62	1.81	2.00	2.24	2.49	2.73	2.98	3.22	3.53	3.83	4.13	4.28	4.58	4.91
300	1.86	2.09	2.32	2.60	2.87	3.23	3.59	3.95	4.31	4.66	5.11	5.55	5.99	6.21	6.64	7.12
400	2.39	2.69	2.99	3.35	3.71	4.18	4.65	5.12	5.59	6.05	6.63	7.21	7.78	8.07	8.64	9.26
500	2.90	3.27	3.64	4.08	4.52	5.10	5.68	6.26	6.83	7.40	8.12	8.82	9.53	9.88	10.58	11.35
600	3.39	3.83	4.26	4.79	5.31	6.00	6.68	7.37	8.05	8.72	9.56	10.40	11.23	11.65	12.48	13.38
700	3.86	4.37	4.87	5.48	6.08	6.87	7.66	8.45	9.23	10.01	10.98	11.94	12.90	13.38	14.33	15.37
800	4.33	4.90	5.47	6.15	6.83	7.73	8.62	9.51	10.40	11.28	12.37	13.46	14.54	15.07	16.14	17.31
900	4.78	5.41	6.05	6.81	7.57	8.57	9.56	10.55	11.54	12.52	13.73	14.94	16.14	16.73	17.92	19.21
1000	5.22	5.92	6.62	7.46	8.29	9.39	10.49	11.57	12.66	13.73	15.07	16.39	17.70	18.36	19.66	21.07
1100	5.65	6.41	7.18	8.09	9.00	10.20	11.39	12.58	13.76	14.92	16.38	17.81	19.24	19.95	21.35	22.89
1200	6.07	6.90	7.72	8.71	9.69	10.99	12.28	13.56	14.83	16.10	17.66	19.21	20.74	21.50	23.02	24.66
1300	6.48	7.37	8.26	9.32	10.38	11.77	13.16	14.53	15.89	17.24	18.92	20.57	22.21	23.03	24.64	26.39
1400	6.88	7.84	8.79	9.92	11.05	12.54	14.01	15.48	16.93	18.37	20.15	21.91	23.65	24.51	26.22	28.08
1500	7.28	8.29	9.30	10.51	11.71	13.29	14.86	16.41	17.95	19.47	21.36	23.22	25.06	25.96	27.76	29.72
1600	7.66	8.74	9.81	11.09	12.35	14.03	15.68	17.32	18.95	20.55	22.54	24.50	26.43	27.38	29.27	31.31
1700	8.04	9.18	10.31	11.65	12.99	14.75	16.50	18.22	19.93	21.61	23.69	25.74	27.76	28.76	30.72	32.85
1800	8.42	9.61	10.80	12.21	13.61	15.46	17.29	19.10	20.88	22.65	24.82	26.96	29.06	30.09	32.14	34.34
1900	8.78	10.03	11.28	12.76	14.22	16.16	18.07	19.96	21.82	23.66	25.92	28.14	30.32	31.39	33.51	35.78
2000	9.14	10.45	11.74	13.29	14.82	16.84	18.83	20.80	22.74	24.65	26.99	29.29	31.54	32.65	34.83	37.16
2100	9.48	10.85	12.20	13.82	15.41	17.51	19.58	21.62	23.63	25.61	28.04	30.41	32.73	33.87	36.10	38.49
2200	9.83	11.25	12.66	14.33	15.99	18.17	20.31	22.43	24.50	26.55	29.05	31.49	33.87	35.04	37.33	39.76
2300	10.16	11.64	13.10	14.83	16.55	18.81	21.03	23.21	25.35	27.46	30.03	32.54	34.98	36.17	38.50	40.97
2400	10.49	12.01	13.53	15.33	17.10	19.43	21.72	23.97	26.18	28.34	30.98	33.55	36.03	37.25	39.62	42.12
2500	10.81	12.39	13.95	15.81	17.64	20.04	22.40	24.72	26.98	29.20	31.90	34.52	37.05	38.28	40.68	43.21
2600	11.12	12.75	14.36	16.28	18.16	20.64	23.06	25.44	27.76	30.03	32.79	35.45	38.02	39.27	41.69	44.23
2700	11.42	13.10	14.77	16.74	18.68	21.22	23.71	26.14	28.52	30.83	33.64	36.35	38.95	40.20	42.64	45.18
2800	11.72	13.45	15.16	17.18	19.18	21.79	24.33	26.82	29.25	31.61	34.46	37.20	39.82	41.09	43.53	46.06
2900	12.00	13.78	15.54	17.62	19.66	22.33	24.94	27.48	29.95	32.35	35.24	38.01	40.65	41.92	44.36	46.87
3000	12.28	14.11	15.91	18.04	20.14	22.87	25.53	28.12	30.63	33.06	35.99	38.78	41.43	42.70	45.12	47.61
3100	12.56	14.43	16.28	18.46	20.60	23.38	26.10	28.73	31.28	33.74	36.69	39.50	42.15	43.42	45.82	48.27
3200	12.82	14.74	16.63	18.86	21.04	23.89	26.65	29.32	31.90	34.39	37.36	40.18	42.82	44.08	46.46	48.85
3300	13.08	15.04	16.97	19.25	21.47	24.37	27.17	29.88	32.50	35.01	38.00	40.81	43.44	44.68	47.02	49.36
3400	13.33	15.33	17.30	19.62	21.89	24.83	27.68	30.43	33.06	35.59	38.59	41.39	44.00	45.23	47.52	49.78
3500	13.57	15.61	17.62	19.98	22.29	25.28	28.17	30.94	33.60	36.14	39.14	41.93	44.50	45.71	47.94	50.11
3600	13.80	15.88	17.93	20.33	22.68	25.71	28.63	31.43	34.11	36.65	39.65	42.42	44.95	46.13	48.29	50.36
3700	14.02	16.14	18.23	20.67	23.05	26.12	29.07	31.90	34.58	37.13	40.11	42.85	45.34	46.48	48.56	50.52
3800	14.23	16.40	18.51	20.99	23.41	26.52	29.49	32.33	35.03	37.57	40.53	43.23	45.66	46.77	48.76	
3900	14.44	16.64	18.79	21.30	23.75	26.89	29.89	32.74	35.44	37.98	40.91	43.56	45.92	46.98	48.87	
4000	14.64	16.87	19.05	21.60	24.07	27.24	30.26	33.13	35.82	38.34	41.24	43.84	46.12	47.13		
4200	15.00	17.30	19.54	22.15	24.67	27.89	30.94	33.81	36.48	38.96	41.76	44.22	46.31			
4400	15.33	17.69	19.98	22.64	25.21	28.46	31.52	34.37	37.00	39.41	42.09	44.36				
4600	15.62	18.08	20.37	23.08	25.67	28.94	31.99	34.81	37.38	39.70	42.21					
4800	15.88	18.33	20.71	23.45	26.06	29.34	32.36	35.13	37.61	39.81	42.12					
5000	16.09	18.59	20.99	23.76	26.38	29.64	32.62	35.31	37.68	39.73						

■ RIM SPEEDS EXCEED 6500 FEET PER MINUTE.



Basic Belt 5VX HP Ratings

Sheave Outside Diameter (in inches)								"Add-On" HP for Speed Ratio									RPM of Faster Shaft
10.90	11.30	11.80	12.50	13.20	14.00	15.00	16.00	1.02 - 1.05	1.06 - 1.11	1.12 - 1.18	1.19 - 1.26	1.27 - 1.38	1.39 - 1.57	1.58 - 1.94	1.95 - 3.38	3.39 - & Up	
10.73	11.22	11.82	12.67	13.51	14.46	15.65	16.83	0.03	0.09	0.15	0.21	0.25	0.30	0.33	0.36	0.38	435
11.85	12.38	13.05	13.99	14.91	15.97	17.27	18.57	0.04	0.10	0.17	0.23	0.28	0.33	0.37	0.40	0.43	485
13.82	14.45	15.23	16.31	17.39	18.62	20.14	21.64	0.04	0.12	0.20	0.27	0.33	0.39	0.44	0.48	0.51	575
14.04	14.67	15.47	16.57	17.67	18.91	20.45	21.98	0.04	0.12	0.21	0.28	0.34	0.40	0.45	0.49	0.52	585
16.28	17.02	17.94	19.21	20.48	21.91	23.69	25.45	0.05	0.14	0.24	0.33	0.40	0.47	0.53	0.57	0.61	690
17.02	17.79	18.75	20.08	21.40	22.90	24.75	26.58	0.05	0.15	0.25	0.35	0.42	0.49	0.55	0.60	0.64	725
20.01	20.91	22.03	23.58	25.12	26.87	29.01	31.13	0.06	0.18	0.31	0.42	0.50	0.59	0.67	0.72	0.77	870
21.61	22.59	23.79	25.46	27.12	28.98	31.28	33.54	0.07	0.19	0.33	0.45	0.55	0.65	0.73	0.79	0.84	950
25.69	26.83	28.24	30.19	32.12	34.28	36.92	39.50	0.09	0.23	0.41	0.55	0.67	0.79	0.89	0.97	1.02	1160
30.51	31.84	33.48	35.73	37.93	40.39	43.36	46.22	0.11	0.29	0.50	0.68	0.83	0.97	1.09	1.19	1.26	1425
35.91	37.42	39.27	41.78	44.22	46.89	50.07	53.04	0.13	0.35	0.61	0.84	1.02	1.19	1.34	1.46	1.54	1750
49.04	50.62	52.47	54.79	56.77	—	—	—	0.21	0.57	1.00	1.36	1.65	1.94	2.18	2.37	2.52	2850
52.04	—	—	—	—	—	—	—	0.26	0.70	1.21	1.65	2.00	2.34	2.64	2.87	3.05	3450
2.77	2.90	3.05	3.27	3.48	3.73	4.03	4.33	0.01	0.02	0.04	0.05	0.06	0.07	0.08	0.08	0.09	100
5.26	5.50	5.80	6.21	6.62	7.09	7.67	8.25	0.01	0.04	0.07	0.10	0.12	0.14	0.15	0.17	0.18	200
7.64	7.99	8.42	9.02	9.62	10.30	11.14	11.98	0.02	0.06	0.11	0.14	0.17	0.20	0.23	0.25	0.26	300
9.94	10.39	10.95	11.73	12.51	13.40	14.50	15.59	0.03	0.08	0.14	0.19	0.23	0.27	0.31	0.33	0.35	400
12.18	12.73	13.42	14.38	15.33	16.41	17.76	19.09	0.04	0.10	0.18	0.24	0.29	0.34	0.38	0.42	0.44	500
14.36	15.01	15.82	16.95	18.07	19.34	20.92	22.48	0.04	0.12	0.21	0.29	0.35	0.41	0.46	0.50	0.53	600
16.49	17.24	18.17	19.46	20.74	22.20	24.00	25.77	0.05	0.14	0.25	0.33	0.41	0.48	0.54	0.58	0.62	700
18.58	19.42	20.46	21.91	23.34	24.97	26.98	28.96	0.06	0.16	0.28	0.38	0.46	0.54	0.61	0.67	0.71	800
20.61	21.54	22.69	24.29	25.88	27.66	29.87	32.04	0.07	0.18	0.32	0.43	0.52	0.61	0.69	0.75	0.79	900
22.60	23.62	24.87	26.61	28.34	30.28	32.66	35.01	0.07	0.20	0.35	0.48	0.58	0.68	0.76	0.83	0.88	1000
24.54	25.64	26.99	28.87	30.72	32.80	35.36	37.85	0.08	0.22	0.39	0.53	0.64	0.75	0.84	0.92	0.97	1100
26.44	27.61	29.06	31.06	33.03	35.24	37.95	40.58	0.09	0.24	0.42	0.57	0.70	0.81	0.92	1.00	1.06	1200
28.28	29.52	31.06	33.18	35.26	37.59	40.43	43.17	0.10	0.26	0.46	0.62	0.75	0.88	0.99	1.08	1.15	1300
30.07	31.38	33.00	35.23	37.41	39.84	42.79	45.63	0.10	0.28	0.49	0.67	0.81	0.95	1.07	1.17	1.24	1400
31.81	33.18	34.88	37.20	39.47	41.99	45.03	47.94	0.11	0.30	0.53	0.72	0.87	1.02	1.15	1.25	1.32	1500
33.49	34.92	36.68	39.09	41.44	44.03	47.15	50.10	0.12	0.32	0.56	0.77	0.93	1.09	1.22	1.33	1.41	1600
35.12	36.60	38.42	40.91	43.32	45.97	49.13	52.10	0.13	0.34	0.60	0.81	0.99	1.15	1.30	1.42	1.50	1700
36.69	38.22	40.09	42.64	45.09	47.79	50.97	53.94	0.13	0.36	0.63	0.86	1.04	1.22	1.38	1.50	1.59	1800
38.19	39.76	41.68	44.28	46.77	49.48	52.67	55.60	0.14	0.38	0.67	0.91	1.10	1.29	1.45	1.58	1.68	1900
39.64	41.24	43.19	45.83	48.34	51.06	54.21	57.08	0.15	0.40	0.70	0.96	1.16	1.36	1.53	1.67	1.77	2000
41.01	42.64	44.62	47.28	49.80	52.50	55.59	58.36	0.16	0.42	0.74	1.00	1.22	1.43	1.61	1.75	1.85	2100
42.32	43.98	45.97	48.64	51.14	53.81	56.82	59.45	0.16	0.44	0.77	1.05	1.28	1.49	1.68	1.83	1.94	2200
43.57	45.23	47.23	49.89	52.37	54.97	57.86	60.33	0.17	0.46	0.81	1.10	1.33	1.56	1.76	1.92	2.03	2300
44.73	46.40	48.40	51.04	53.47	55.99	58.73	61.00	0.18	0.48	0.84	1.15	1.39	1.63	1.83	2.00	2.12	2400
45.83	47.49	49.48	52.07	54.44	56.86	59.42	—	0.19	0.50	0.88	1.20	1.45	1.70	1.91	2.08	2.21	2500
46.85	48.50	50.46	53.00	55.28	57.57	—	—	0.19	0.52	0.91	1.24	1.51	1.77	1.99	2.17	2.30	2600
47.78	49.42	51.34	53.80	55.99	58.12	—	—	0.20	0.54	0.95	1.29	1.57	1.83	2.06	2.25	2.38	2700
48.64	50.25	52.12	54.49	56.55	—	—	—	0.21	0.56	0.98	1.34	1.62	1.90	2.14	2.33	2.47	2800
49.41	50.98	52.79	55.05	56.96	—	—	—	0.21	0.58	1.02	1.39	1.68	1.97	2.22	2.42	2.56	2900
50.10	51.62	53.36	55.48	—	—	—	—	0.22	0.60	1.05	1.43	1.74	2.04	2.29	2.50	2.65	3000
50.69	52.16	53.81	—	—	—	—	—	0.23	0.63	1.09	1.48	1.80	2.11	2.37	2.58	2.74	3100
51.20	52.59	54.14	—	—	—	—	—	0.24	0.65	1.12	1.53	1.86	2.17	2.45	2.67	2.82	3200
51.60	52.92	—	—	—	—	—	—	0.24	0.67	1.16	1.58	1.91	2.24	2.52	2.75	2.91	3300
51.92	53.15	—	—	—	—	—	—	0.25	0.69	1.19	1.63	1.97	2.31	2.60	2.83	3.00	3400
52.13	—	—	—	—	—	—	—	0.26	0.71	1.23	1.67	2.03	2.38	2.68	2.92	3.09	3500
—	—	—	—	—	—	—	—	0.27	0.73	1.26	1.72	2.09	2.44	2.75	3.00	3.18	3600
—	—	—	—	—	—	—	—	0.27	0.75	1.30	1.77	2.15	2.51	2.83	3.08	3.27	3700
—	—	—	—	—	—	—	—	0.28	0.77	1.33	1.82	2.20	2.58	2.91	3.17	3.35	3800
—	—	—	—	—	—	—	—	0.29	0.79	1.37	1.86	2.26	2.65	2.98	3.25	3.44	3900
—	—	—	—	—	—	—	—	0.30	0.81	1.40	1.91	2.32	2.72	3.06	3.33	3.53	4000
—	—	—	—	—	—	—	—	0.31	0.85	1.47	2.01	2.44	2.85	3.21	3.50	3.71	4200
—	—	—	—	—	—	—	—	0.33	0.89	1.55	2.10	2.55	2.99	3.36	3.67	3.88	4400
—	—	—	—	—	—	—	—	0.34	0.93	1.62	2.20	2.67	3.12	3.52	3.83	4.06	4600
—	—	—	—	—	—	—	—	0.36	0.97	1.69	2.30	2.78	3.26	3.67	4.00	4.24	4800
—	—	—	—	—	—	—	—	0.37	1.01	1.76	2.39	2.90	3.40	3.82	4.17	4.41	5000

V-BELT DRIVES

8V Basic Belt HP Ratings

V-BELT DRIVES

RPM of Faster Shaft	Sheave Outside Diameter (in inches)											
	12.50	13.20	14.00	15.00	16.00	17.00	18.00	19.00	20.00	21.20	22.40	24.80
435	20.10	22.28	24.75	27.82	30.86	33.87	36.85	39.81	42.75	46.23	49.68	56.45
485	22.02	24.42	27.14	30.51	33.84	37.15	40.42	43.65	46.86	50.66	54.41	61.76
585	25.69	28.51	31.70	35.65	39.55	43.40	47.20	50.95	54.65	59.02	63.31	71.65
690	29.32	32.56	36.21	40.72	45.16	49.53	53.82	58.04	62.18	67.05	71.80	80.92
725	30.48	33.85	37.65	42.34	46.94	51.47	55.91	60.27	64.54	69.54	74.41	83.73
870	35.00	38.87	43.24	48.58	53.81	58.90	63.87	68.70	73.39	78.82	84.03	93.77
950	37.29	41.42	46.05	51.71	57.22	62.57	67.75	72.77	77.60	83.15	88.43	98.09
1160	42.57	47.26	52.48	58.77	64.81	70.58	76.06	81.25	86.12	91.55	96.48	104.80
1425	47.60	52.74	58.36	65.00	71.18	76.89	82.09	86.76	90.88	95.05	98.34	102.11
1750	50.91	56.13	61.66	67.88	73.28	77.83	81.47	84.16	85.84	86.47	—	—
50	3.01	3.31	3.64	4.06	4.47	4.88	5.30	5.70	6.11	6.60	7.09	8.06
100	5.59	6.15	6.79	7.59	8.38	9.17	9.96	10.74	11.52	12.46	13.38	15.23
150	8.00	8.82	9.76	10.92	12.07	13.23	14.37	15.51	16.65	18.01	19.36	22.05
200	10.30	11.37	12.59	14.11	15.62	17.12	18.61	20.10	21.58	23.35	25.11	28.60
250	12.51	13.83	15.33	17.19	19.04	20.88	22.71	24.53	26.35	28.51	30.66	34.92
300	14.65	16.20	17.97	20.17	22.36	24.53	26.69	28.83	30.97	33.51	36.03	41.02
350	16.72	18.51	20.55	23.07	25.58	28.07	30.55	33.01	35.45	38.35	41.23	46.92
400	18.73	20.75	23.04	25.89	28.72	31.52	34.30	37.05	39.79	43.04	46.26	52.60
450	20.69	22.93	25.47	28.63	31.76	34.86	37.93	40.98	44.00	47.58	51.12	58.07
500	22.59	25.05	27.84	31.30	34.72	38.11	41.46	44.78	48.06	51.96	55.79	63.31
550	24.43	27.11	30.14	33.88	37.59	41.26	44.88	48.46	51.99	56.17	60.28	68.30
600	26.23	29.11	32.37	36.40	40.38	44.30	48.18	52.00	55.77	60.22	64.58	73.05
650	27.97	31.05	34.53	38.83	43.07	47.25	51.36	55.41	59.40	64.09	68.67	77.53
700	29.66	32.93	36.63	41.19	45.67	50.09	54.43	58.69	62.87	67.77	72.56	81.74
750	31.29	34.75	38.66	43.46	48.18	52.82	57.36	61.81	66.17	71.27	76.22	85.65
800	32.88	36.51	40.62	45.66	50.60	55.43	60.17	64.79	69.30	74.56	79.64	89.26
850	34.40	38.21	42.50	47.76	52.91	57.94	62.84	67.61	72.26	77.65	82.83	92.55
900	35.87	39.85	44.32	49.78	55.12	60.32	65.37	70.27	75.02	80.51	85.76	95.50
950	37.29	41.42	46.05	51.71	57.22	62.57	67.75	72.77	77.60	83.15	88.43	98.09
1000	38.64	42.92	47.71	53.55	59.21	64.70	69.99	75.08	79.97	85.56	90.82	100.32
1050	39.94	44.36	49.29	55.29	61.09	66.69	72.07	77.22	82.14	87.71	92.92	102.17
1100	41.18	45.72	50.79	56.94	62.86	68.54	73.98	79.17	84.08	89.62	94.73	103.61
1150	42.35	47.01	52.21	58.48	64.50	70.25	75.73	80.92	85.80	91.25	96.22	104.64
1200	43.46	48.23	53.53	59.92	66.01	71.82	77.31	82.47	87.29	92.61	97.39	105.24
1250	44.50	49.37	54.77	61.24	67.40	73.23	78.70	83.81	88.54	93.69	98.23	105.38
1300	45.47	50.44	55.92	62.46	68.66	74.48	79.91	84.94	89.54	94.46	98.72	105.06
1350	46.38	51.42	56.97	63.57	69.77	75.57	80.93	85.84	90.27	94.94	98.85	104.26
1400	47.21	52.32	57.92	64.55	70.75	76.49	81.75	86.51	90.75	95.09	98.61	102.96
1450	47.97	53.14	58.78	65.42	71.58	77.24	82.37	86.95	90.94	94.92	97.98	101.14
1500	48.66	53.87	59.53	66.16	72.26	77.81	82.78	87.14	90.85	94.42	96.96	98.79
1550	49.27	54.51	60.18	66.77	72.79	78.20	82.98	87.08	90.47	93.57	95.54	95.89
1600	49.80	55.05	60.71	67.25	73.16	78.41	82.95	86.75	89.79	92.35	93.69	—
1650	50.25	55.51	61.14	67.60	73.37	78.41	82.69	86.17	88.79	90.78	91.41	—
1700	50.62	55.87	61.46	67.81	73.41	78.22	82.20	85.30	87.48	88.82	88.69	—
1750	50.91	56.13	61.66	67.88	73.28	77.83	81.47	84.16	85.84	86.47	—	—
1800	51.11	56.29	61.74	67.80	72.98	77.23	80.49	82.72	83.87	83.73	—	—
1850	51.22	56.35	61.70	67.57	72.50	76.41	79.26	80.99	81.55	—	—	—
1900	51.24	56.30	61.53	67.19	71.83	75.38	77.77	78.96	78.87	—	—	—
1950	51.17	56.14	61.23	66.66	70.97	74.12	76.02	76.61	—	—	—	—
2000	51.00	55.88	60.81	65.96	69.93	72.62	73.99	73.95	—	—	—	—
2100	50.38	55.01	59.56	64.08	67.23	68.93	69.09	—	—	—	—	—
2200	49.36	53.67	57.75	61.52	63.72	64.25	—	—	—	—	—	—
2300	47.92	51.84	55.36	58.24	59.34	—	—	—	—	—	—	—
2400	46.05	49.50	52.37	54.23	54.07	—	—	—	—	—	—	—
2500	43.73	46.64	48.75	49.45	—	—	—	—	—	—	—	—
2600	40.94	43.23	44.48	—	—	—	—	—	—	—	—	—
2700	37.67	39.25	39.53	—	—	—	—	—	—	—	—	—
2800	33.91	34.69	—	—	—	—	—	—	—	—	—	—

■ RIM SPEEDS EXCEED 6500 FEET PER MINUTE.



Basic Belt 8V HP Ratings

V-BELT DRIVES

"Add-On" HP for Speed Ratio									RPM of Faster Shaft
1.02- 1.05	1.06- 1.11	1.12- 1.18	1.19- 1.26	1.27- 1.38	1.39- 1.57	1.58- 1.94	1.95- 3.38	3.39 & Up	
0.20	0.56	0.97	1.32	1.60	1.87	2.11	2.30	2.43	435
0.23	0.62	1.08	1.47	1.78	2.09	2.35	2.56	2.71	485
0.27	0.75	1.30	1.77	2.15	2.52	2.83	3.09	3.27	585
0.32	0.88	1.54	2.09	2.54	2.97	3.34	3.64	3.86	690
0.34	0.93	1.61	2.20	2.67	3.12	3.51	3.83	4.06	725
0.41	1.11	1.94	2.64	3.20	3.74	4.22	4.59	4.87	870
0.45	1.21	2.11	2.88	3.49	4.09	4.60	5.02	5.32	950
0.54	1.48	2.58	3.52	4.27	4.99	5.62	6.13	6.49	1160
0.67	1.82	3.17	4.32	5.24	6.13	6.91	7.52	7.97	1425
0.82	2.24	3.90	5.30	6.44	7.53	8.48	9.24	9.79	1750
0.02	0.06	0.11	0.15	0.18	0.22	0.24	0.26	0.28	50
0.05	0.13	0.22	0.30	0.37	0.43	0.48	0.53	0.56	100
0.07	0.19	0.33	0.45	0.55	0.65	0.73	0.79	0.84	150
0.09	0.26	0.45	0.61	0.74	0.86	0.97	1.06	1.12	200
0.12	0.32	0.56	0.76	0.92	1.08	1.21	1.32	1.40	250
0.14	0.38	0.67	0.91	1.10	1.29	1.45	1.58	1.68	300
0.16	0.45	0.78	1.06	1.29	1.51	1.70	1.85	1.96	350
0.19	0.51	0.89	1.21	1.47	1.72	1.94	2.11	2.24	400
0.21	0.58	1.00	1.36	1.66	1.94	2.18	2.38	2.52	450
0.23	0.64	1.11	1.52	1.84	2.15	2.42	2.64	2.80	500
0.26	0.70	1.22	1.67	2.02	2.37	2.67	2.90	3.08	550
0.28	0.77	1.34	1.82	2.21	2.58	2.91	3.17	3.36	600
0.31	0.83	1.45	1.97	2.39	2.80	3.15	3.43	3.64	650
0.33	0.89	1.56	2.12	2.57	3.01	3.39	3.70	3.92	700
0.35	0.96	1.67	2.27	2.76	3.23	3.63	3.96	4.20	750
0.38	1.02	1.78	2.43	2.94	3.44	3.88	4.22	4.48	800
0.40	1.09	1.89	2.58	3.13	3.66	4.12	4.49	4.76	850
0.42	1.15	2.00	2.73	3.31	3.87	4.36	4.75	5.04	900
0.45	1.21	2.11	2.88	3.49	4.09	4.60	5.02	5.32	950
0.47	1.28	2.23	3.03	3.68	4.30	4.85	5.28	5.60	1000
0.49	1.34	2.34	3.18	3.86	4.52	5.09	5.54	5.88	1050
0.52	1.41	2.45	3.33	4.05	4.73	5.33	5.81	6.16	1100
0.54	1.47	2.56	3.49	4.23	4.95	5.57	6.07	6.44	1150
0.56	1.53	2.67	3.64	4.41	5.17	5.82	6.34	6.71	1200
0.59	1.60	2.78	3.79	4.60	5.38	6.06	6.60	6.99	1250
0.61	1.66	2.89	3.94	4.78	5.60	6.30	6.86	7.27	1300
0.63	1.73	3.01	4.09	4.97	5.81	6.54	7.13	7.55	1350
0.66	1.79	3.12	4.24	5.15	6.03	6.78	7.39	7.83	1400
0.68	1.85	3.23	4.40	5.33	6.24	7.03	7.66	8.11	1450
0.70	1.92	3.34	4.55	5.52	6.46	7.27	7.92	8.39	1500
0.73	1.98	3.45	4.70	5.70	6.67	7.51	8.18	8.67	1550
0.75	2.05	3.56	4.85	5.88	6.89	7.75	8.45	8.95	1600
0.77	2.11	3.67	5.00	6.07	7.10	8.00	8.71	9.23	1650
0.80	2.17	3.78	5.15	6.25	7.32	8.24	8.98	9.51	1700
0.82	2.24	3.90	5.30	6.44	7.53	8.48	9.24	9.79	1750
0.84	2.30	4.01	5.46	6.62	7.75	8.72	9.51	10.07	1800
0.87	2.36	4.12	5.61	6.80	7.96	8.97	9.77	10.35	1850
0.89	2.43	4.23	5.76	6.99	8.18	9.21	10.03	10.63	1900
0.92	2.49	4.34	5.91	7.17	8.39	9.45	10.30	10.91	1950
0.94	2.56	4.45	6.06	7.36	8.61	9.69	10.56	11.19	2000
0.99	2.68	4.67	6.37	7.72	9.04	10.18	11.09	11.75	2100
1.03	2.81	4.90	6.67	8.09	9.47	10.66	11.62	12.31	2200
1.08	2.94	5.12	6.97	8.46	9.90	11.15	12.15	12.87	2300
1.13	3.07	5.34	7.28	8.83	10.33	11.63	12.67	13.43	2400
1.17	3.20	5.57	7.58	9.19	10.76	12.12	13.20	13.99	2500
1.22	3.32	5.79	7.88	9.56	11.19	12.60	13.73	14.55	2600
1.27	3.45	6.01	8.18	9.93	11.62	13.08	14.26	15.11	2700
1.31	3.58	6.23	8.49	10.30	12.05	13.57	14.79	15.67	2800

A Basic Belt HP Ratings



V-BELT DRIVES

RPM of Faster Shaft	Sheave Pitch Diameter (in inches)													
	3.0	3.2	3.4	3.6	3.8	4.0	4.2	4.4	4.6	4.8	5.0	5.2	5.4	5.6
1160	1.29	1.55	1.81	2.06	2.32	2.57	2.82	3.06	3.31	3.55	3.80	4.04	4.28	4.51
1750	1.67	2.04	2.41	2.77	3.13	3.48	3.83	4.18	4.52	4.86	5.20	5.53	5.86	6.18
3500	2.24	2.87	3.48	4.08	4.66	5.22	5.77	6.30	6.82	7.32	7.80	8.26	8.71	9.13
50	0.11	0.13	0.14	0.16	0.17	0.19	0.20	0.21	0.23	0.24	0.26	0.27	0.29	0.30
100	0.20	0.23	0.26	0.28	0.31	0.34	0.37	0.39	0.42	0.45	0.48	0.50	0.53	0.56
500	0.71	0.83	0.95	1.07	1.20	1.31	1.43	1.55	1.67	1.79	1.90	2.02	2.14	2.25
600	0.81	0.96	1.10	1.24	1.38	1.52	1.66	1.80	1.94	2.08	2.22	2.35	2.49	2.63
700	0.91	1.08	1.24	1.40	1.57	1.73	1.89	2.05	2.21	2.36	2.52	2.68	2.83	2.99
800	1.00	1.19	1.37	1.56	1.74	1.92	2.10	2.28	2.46	2.64	2.81	2.99	3.16	3.34
900	1.09	1.29	1.50	1.70	1.91	2.11	2.31	2.51	2.71	2.90	3.10	3.29	3.49	3.68
1000	1.17	1.40	1.62	1.85	2.07	2.29	2.51	2.73	2.94	3.16	3.37	3.59	3.80	4.01
1100	1.25	1.50	1.74	1.98	2.23	2.47	2.70	2.94	3.17	3.41	3.64	3.87	4.10	4.33
1200	1.32	1.59	1.85	2.12	2.38	2.63	2.89	3.15	3.40	3.65	3.90	4.15	4.39	4.64
1300	1.39	1.68	1.96	2.24	2.52	2.80	3.07	3.35	3.62	3.89	4.15	4.42	4.68	4.94
1400	1.46	1.77	2.07	2.37	2.66	2.96	3.25	3.54	3.83	4.11	4.40	4.68	4.96	5.23
1500	1.53	1.85	2.17	2.49	2.80	3.11	3.42	3.73	4.03	4.34	4.63	4.93	5.22	5.52
1600	1.59	1.93	2.27	2.60	2.93	3.26	3.59	3.91	4.23	4.55	4.86	5.18	5.48	5.79
1700	1.65	2.01	2.36	2.71	3.06	3.41	3.75	4.09	4.43	4.76	5.09	5.41	5.74	6.05
1800	1.70	2.08	2.45	2.82	3.19	3.55	3.91	4.26	4.61	4.96	5.30	5.64	5.98	6.31
1900	1.75	2.15	2.54	2.93	3.31	3.69	4.06	4.43	4.79	5.16	5.51	5.87	6.21	6.56
2000	1.80	2.22	2.62	3.03	3.42	3.82	4.21	4.59	4.97	5.34	5.71	6.08	6.44	6.80
2100	1.85	2.28	2.70	3.12	3.53	3.94	4.35	4.74	5.14	5.53	5.91	6.29	6.66	7.03
2200	1.90	2.34	2.78	3.21	3.64	4.07	4.48	4.89	5.30	5.70	6.10	6.48	6.87	7.24
2300	1.94	2.40	2.85	3.30	3.75	4.18	4.61	5.04	5.46	5.87	6.27	6.67	7.07	7.45
2400	1.98	2.45	2.92	3.39	3.85	4.30	4.74	5.18	5.61	6.03	6.45	6.86	7.26	7.65
2600	2.05	2.56	3.06	3.55	4.03	4.51	4.98	5.44	5.89	6.33	6.77	7.19	7.61	8.02
2800	2.11	2.65	3.17	3.69	4.20	4.70	5.19	5.67	6.14	6.60	7.06	7.50	7.93	8.35
3000	2.16	2.72	3.28	3.82	4.35	4.87	5.39	5.88	6.37	6.85	7.31	7.76	8.20	8.63
3200	2.20	2.79	3.37	3.93	4.49	5.03	5.56	6.07	6.57	7.06	7.53	7.99	8.44	8.87
3400	2.23	2.84	3.45	4.03	4.60	5.16	5.71	6.23	6.75	7.24	7.72	8.18	8.63	9.06
3600	2.25	2.89	3.51	4.11	4.70	5.28	5.83	6.37	6.89	7.39	7.87	8.33	8.78	9.20
3800	2.26	2.92	3.56	4.18	4.78	5.37	5.93	6.48	7.00	7.50	7.98	8.44	8.88	9.29
4000	2.25	2.93	3.59	4.23	4.84	5.44	6.01	6.56	7.08	7.58	8.06	8.51	8.93	9.32
4200	2.24	2.94	3.61	4.26	4.89	5.49	6.06	6.61	7.13	7.63	8.09	8.52	8.93	9.30
4400	2.22	2.93	3.61	4.27	4.91	5.51	6.09	6.63	7.15	7.63	8.08	8.50	8.88	9.22
4600	2.18	2.91	3.60	4.27	4.91	5.51	6.08	6.62	7.13	7.60	8.03	8.42	8.77	9.09
4800	2.13	2.87	3.57	4.25	4.88	5.49	6.05	6.58	7.07	7.52	7.93	8.29	8.61	8.89
5000	2.07	2.82	3.53	4.20	4.84	5.44	5.99	6.51	6.98	7.40	7.78	8.11	8.39	8.62

RIM SPEEDS EXCEED 6500 FEET PER MINUTE.



Basic Belt HP Ratings **A**

Sheave Pitch Diameter (in inches)						"Add-On" HP for Speed Ratio										RPM of Faster Shaft
5.8	6.0	6.2	6.4	6.6	7.0	1.02- 1.04	1.05- 1.08	1.09- 1.12	1.13- 1.18	1.19- 1.24	1.25- 1.34	1.35- 1.51	1.52- 1.99	2.00 & Up		
4.75	4.99	5.22	5.45	5.68	6.13	0.03	0.07	0.11	0.14	0.18	0.21	0.24	0.27	0.30	1160	
6.51	6.83	7.14	7.45	7.76	8.36	0.04	0.10	0.16	0.21	0.27	0.32	0.37	0.41	0.46	1750	
9.54	9.92	10.29	10.63	10.95	11.53	0.09	0.20	0.33	0.43	0.55	0.63	0.73	0.83	0.92	3500	
0.32	0.33	0.34	0.36	0.37	0.40	0.00	0.00	0.00	0.01	0.01	0.01	0.01	0.01	0.01	50	
0.58	0.61	0.64	0.66	0.69	0.74	0.00	0.01	0.01	0.01	0.02	0.02	0.02	0.02	0.03	100	
2.37	2.48	2.59	2.71	2.82	3.04	0.01	0.03	0.05	0.06	0.08	0.09	0.10	0.12	0.13	500	
2.76	2.89	3.03	3.16	3.29	3.56	0.01	0.03	0.06	0.07	0.09	0.11	0.13	0.14	0.16	600	
3.14	3.29	3.45	3.60	3.75	4.05	0.02	0.04	0.07	0.09	0.11	0.13	0.15	0.17	0.18	700	
3.51	3.68	3.85	4.02	4.19	4.53	0.02	0.05	0.07	0.10	0.13	0.15	0.17	0.19	0.21	800	
3.87	4.06	4.25	4.44	4.62	5.00	0.02	0.05	0.08	0.11	0.14	0.16	0.19	0.21	0.24	900	
4.22	4.42	4.63	4.84	5.04	5.44	0.02	0.06	0.09	0.12	0.16	0.18	0.21	0.24	0.26	1000	
4.55	4.78	5.00	5.22	5.44	5.88	0.03	0.06	0.10	0.14	0.17	0.20	0.23	0.26	0.29	1100	
4.88	5.12	5.36	5.60	5.83	6.30	0.03	0.07	0.11	0.15	0.19	0.22	0.25	0.28	0.31	1200	
5.20	5.45	5.71	5.96	6.21	6.71	0.03	0.07	0.12	0.16	0.20	0.24	0.27	0.31	0.34	1300	
5.51	5.78	6.05	6.31	6.58	7.10	0.03	0.08	0.13	0.17	0.22	0.25	0.29	0.33	0.37	1400	
5.80	6.09	6.37	6.65	6.93	7.48	0.04	0.09	0.14	0.18	0.23	0.27	0.31	0.35	0.39	1500	
6.09	6.39	6.69	6.98	7.27	7.84	0.04	0.09	0.15	0.20	0.25	0.29	0.34	0.38	0.42	1600	
6.37	6.68	6.99	7.30	7.60	8.19	0.04	0.10	0.16	0.21	0.27	0.31	0.36	0.40	0.44	1700	
6.64	6.96	7.29	7.60	7.91	8.53	0.04	0.10	0.17	0.22	0.28	0.33	0.38	0.43	0.47	1800	
6.90	7.23	7.57	7.89	8.22	8.85	0.05	0.11	0.18	0.23	0.30	0.34	0.40	0.45	0.50	1900	
7.15	7.49	7.84	8.17	8.50	9.15	0.05	0.12	0.19	0.25	0.31	0.36	0.42	0.47	0.52	2000	
7.39	7.74	8.09	8.44	8.78	9.44	0.05	0.12	0.20	0.26	0.33	0.38	0.44	0.50	0.55	2100	
7.62	7.98	8.34	8.69	9.04	9.71	0.05	0.13	0.21	0.27	0.34	0.40	0.46	0.52	0.58	2200	
7.83	8.21	8.57	8.93	9.28	9.96	0.06	0.13	0.22	0.28	0.36	0.42	0.48	0.54	0.60	2300	
8.04	8.42	8.79	9.16	9.51	10.20	0.06	0.14	0.22	0.29	0.38	0.44	0.50	0.57	0.63	2400	
8.42	8.81	9.19	9.57	9.93	10.62	0.06	0.15	0.24	0.32	0.41	0.47	0.54	0.61	0.68	2600	
8.76	9.15	9.54	9.91	10.28	10.97	0.07	0.16	0.26	0.34	0.44	0.51	0.59	0.66	0.73	2800	
9.04	9.44	9.83	10.20	10.56	11.23	0.07	0.17	0.28	0.37	0.47	0.54	0.63	0.71	0.78	3000	
9.28	9.68	10.06	10.43	10.77	11.42	0.08	0.18	0.30	0.39	0.50	0.58	0.67	0.76	0.84	3200	
9.47	9.86	10.23	10.58	10.91	11.51	0.08	0.20	0.32	0.42	0.53	0.62	0.71	0.80	0.89	3400	
9.60	9.98	10.33	10.66	10.97	11.52	0.09	0.21	0.34	0.44	0.56	0.65	0.75	0.85	0.94	3600	
9.67	10.03	10.37	10.67	10.96	11.43	0.09	0.22	0.36	0.47	0.59	0.69	0.80	0.90	0.99	3800	
9.69	10.02	10.33	10.61	10.85	11.24	0.10	0.23	0.37	0.49	0.63	0.73	0.84	0.94	1.05	4000	
9.64	9.95	10.22	10.46	10.66	10.95	0.10	0.24	0.39	0.52	0.66	0.76	0.88	0.99	1.10	4200	
9.53	9.80	10.04	10.23	10.38	10.55	0.11	0.25	0.41	0.54	0.69	0.80	0.92	1.04	1.15	4400	
9.36	9.59	9.77	9.91	10.00	10.04	0.11	0.26	0.43	0.57	0.72	0.83	0.96	1.09	1.20	4600	
9.11	9.29	9.42	9.50	9.52	9.41	0.12	0.28	0.45	0.59	0.75	0.87	1.01	1.13	1.25	4800	
8.80	8.92	8.99	8.99	8.94	8.65	0.12	0.29	0.47	0.61	0.78	0.91	1.05	1.18	1.31	5000	

V-BELT DRIVES

Call *Martin* for your made-to-order and large quantity requirements.

AX Basic Belt HP Ratings



V-BELT DRIVES

RPM of Faster Shaft	Sheave Pitch Diameter (in inches)													
	3.0	3.2	3.4	3.6	3.8	4.0	4.2	4.4	4.6	4.8	5.0	5.2	5.4	5.6
1160	1.57	1.83	2.09	2.34	2.60	2.85	3.10	3.35	3.60	3.84	4.09	4.33	4.57	4.81
1750	2.10	2.47	2.84	3.21	3.57	3.92	4.28	4.63	4.98	5.33	5.67	6.01	6.34	6.68
3500	3.17	3.82	4.45	5.07	5.68	6.27	6.86	7.43	7.98	8.52	9.05	9.56	10.06	10.54
50	0.12	0.14	0.15	0.17	0.18	0.20	0.21	0.23	0.24	0.25	0.27	0.28	0.30	0.31
100	0.22	0.25	0.28	0.31	0.33	0.36	0.39	0.42	0.44	0.47	0.50	0.52	0.55	0.58
600	0.95	1.10	1.24	1.38	1.52	1.67	1.81	1.94	2.08	2.22	2.36	2.50	2.63	2.77
700	1.07	1.24	1.40	1.57	1.73	1.89	2.05	2.21	2.37	2.53	2.69	2.84	3.00	3.16
800	1.19	1.38	1.56	1.75	1.93	2.11	2.29	2.47	2.65	2.83	3.01	3.18	3.36	3.53
900	1.30	1.51	1.71	1.92	2.12	2.32	2.52	2.72	2.92	3.12	3.32	3.51	3.71	3.90
1000	1.41	1.63	1.86	2.09	2.31	2.53	2.75	2.97	3.19	3.40	3.62	3.83	4.05	4.26
1100	1.51	1.76	2.00	2.25	2.49	2.73	2.97	3.21	3.45	3.68	3.91	4.15	4.38	4.61
1200	1.61	1.88	2.14	2.41	2.67	2.93	3.19	3.44	3.70	3.95	4.20	4.45	4.70	4.95
1300	1.71	1.99	2.28	2.56	2.84	3.12	3.40	3.67	3.94	4.21	4.48	4.75	5.02	5.28
1400	1.80	2.11	2.41	2.71	3.01	3.31	3.60	3.89	4.18	4.47	4.76	5.04	5.32	5.60
1500	1.89	2.21	2.54	2.86	3.17	3.49	3.80	4.11	4.42	4.72	5.03	5.33	5.62	5.92
1600	1.98	2.32	2.66	3.00	3.33	3.67	4.00	4.32	4.65	4.97	5.29	5.60	5.92	6.23
1700	2.06	2.42	2.78	3.14	3.49	3.84	4.19	4.53	4.87	5.21	5.54	5.87	6.20	6.53
1800	2.14	2.52	2.90	3.27	3.64	4.01	4.37	4.73	5.09	5.44	5.79	6.14	6.48	6.82
1900	2.22	2.62	3.01	3.40	3.79	4.17	4.55	4.93	5.30	5.67	6.03	6.40	6.75	7.11
2000	2.30	2.71	3.13	3.53	3.94	4.34	4.73	5.12	5.51	5.89	6.27	6.65	7.02	7.39
2100	2.37	2.81	3.23	3.66	4.08	4.49	4.90	5.31	5.71	6.11	6.50	6.89	7.28	7.66
2200	2.44	2.89	3.34	3.78	4.22	4.65	5.07	5.49	5.91	6.32	6.73	7.13	7.53	7.92
2300	2.51	2.98	3.44	3.90	4.35	4.80	5.24	5.67	6.10	6.53	6.94	7.36	7.77	8.17
2400	2.58	3.06	3.54	4.01	4.48	4.94	5.40	5.84	6.29	6.73	7.16	7.58	8.00	8.42
2600	2.71	3.22	3.73	4.24	4.73	5.22	5.70	6.18	6.65	7.11	7.56	8.01	8.45	8.88
2800	2.83	3.37	3.91	4.44	4.97	5.48	5.99	6.49	6.98	7.46	7.94	8.41	8.87	9.32
3000	2.94	3.51	4.08	4.64	5.19	5.73	6.26	6.78	7.30	7.80	8.29	8.78	9.25	9.71
3200	3.04	3.64	4.24	4.82	5.40	5.96	6.51	7.06	7.59	8.11	8.62	9.11	9.60	10.07
3400	3.13	3.76	4.38	4.99	5.59	6.17	6.75	7.31	7.86	8.39	8.91	9.42	9.91	10.40
3600	3.21	3.87	4.52	5.15	5.77	6.37	6.96	7.54	8.10	8.65	9.18	9.70	10.20	10.68
3800	3.29	3.97	4.64	5.29	5.93	6.55	7.16	7.75	8.32	8.88	9.42	9.94	10.44	10.92
4000	3.35	4.06	4.75	5.42	6.08	6.71	7.33	7.93	8.52	9.08	9.62	10.14	10.64	11.12
4200	3.41	4.13	4.84	5.53	6.21	6.86	7.49	8.10	8.69	9.25	9.79	10.31	10.81	11.28
4400	3.45	4.20	4.93	5.64	6.32	6.98	7.62	8.24	8.83	9.39	9.93	10.45	10.93	11.39
4600	3.49	4.26	5.00	5.72	6.42	7.09	7.73	8.35	8.94	9.51	10.04	10.54	11.02	11.46
4800	3.52	4.30	5.06	5.79	6.50	7.18	7.82	8.44	9.03	9.59	10.11	10.60	11.06	11.48
5000	3.53	4.33	5.11	5.85	6.56	7.24	7.89	8.51	9.09	9.63	10.14	10.62	11.05	11.44

■ RIM SPEEDS EXCEED 6500 FEET PER MINUTE.



Basic Belt HP Ratings **AX**

Sheave Pitch Diameter (in inches)						"Add-On" HP for Speed Ratio										RPM of Faster Shaft
5.8	6.0	6.2	6.4	6.6	7.0	1.02- 1.04	1.05- 1.08	1.09- 1.12	1.13- 1.18	1.19- 1.24	1.25- 1.34	1.35- 1.51	1.52- 1.99	2.00 & Up		
5.05	5.29	5.52	5.76	5.99	6.45	0.03	0.06	0.10	0.13	0.16	0.19	0.22	0.25	0.28	1160	
7.01	7.34	7.66	7.98	8.30	8.93	0.04	0.09	0.15	0.20	0.25	0.29	0.33	0.38	0.42	1750	
11.01	11.46	11.89	12.31	12.71	13.46	0.08	0.18	0.30	0.39	0.50	0.58	0.67	0.75	0.83	3500	
0.33	0.34	0.35	0.37	0.38	0.41	0.00	0.00	0.00	0.01	0.01	0.01	0.01	0.01	0.01	50	
0.61	0.63	0.66	0.69	0.71	0.76	0.00	0.01	0.01	0.01	0.01	0.02	0.02	0.02	0.02	100	
2.90	3.04	3.17	3.30	3.44	3.70	0.01	0.03	0.05	0.07	0.09	0.10	0.11	0.13	0.14	600	
3.31	3.46	3.62	3.77	3.92	4.23	0.02	0.04	0.06	0.08	0.10	0.12	0.13	0.15	0.17	700	
3.71	3.88	4.05	4.22	4.39	4.73	0.02	0.04	0.07	0.09	0.11	0.13	0.15	0.17	0.19	800	
4.09	4.28	4.47	4.66	4.85	5.23	0.02	0.05	0.08	0.10	0.13	0.15	0.17	0.19	0.21	900	
4.47	4.68	4.89	5.09	5.30	5.71	0.02	0.05	0.09	0.11	0.14	0.16	0.19	0.21	0.24	1000	
4.83	5.06	5.29	5.51	5.73	6.18	0.02	0.06	0.09	0.12	0.16	0.18	0.21	0.24	0.26	1100	
5.19	5.44	5.68	5.92	6.16	6.63	0.03	0.06	0.10	0.13	0.17	0.20	0.23	0.26	0.28	1200	
5.54	5.80	6.06	6.32	6.57	7.08	0.03	0.07	0.11	0.15	0.18	0.21	0.25	0.28	0.31	1300	
5.88	6.16	6.43	6.70	6.97	7.51	0.03	0.07	0.12	0.16	0.20	0.23	0.27	0.30	0.33	1400	
6.21	6.51	6.79	7.08	7.37	7.93	0.03	0.08	0.13	0.17	0.21	0.25	0.29	0.32	0.36	1500	
6.54	6.84	7.15	7.45	7.75	8.34	0.04	0.08	0.14	0.18	0.23	0.26	0.30	0.34	0.38	1600	
6.85	7.17	7.49	7.81	8.12	8.73	0.04	0.09	0.14	0.19	0.24	0.28	0.32	0.36	0.40	1700	
7.16	7.49	7.83	8.15	8.48	9.12	0.04	0.09	0.15	0.20	0.26	0.30	0.34	0.39	0.43	1800	
7.46	7.81	8.15	8.49	8.83	9.49	0.04	0.10	0.16	0.21	0.27	0.31	0.36	0.41	0.45	1900	
7.75	8.11	8.46	8.82	9.16	9.84	0.05	0.10	0.17	0.22	0.28	0.33	0.38	0.43	0.47	2000	
8.03	8.40	8.77	9.13	9.49	10.19	0.05	0.11	0.18	0.23	0.30	0.35	0.40	0.45	0.50	2100	
8.30	8.69	9.06	9.43	9.80	10.52	0.05	0.11	0.19	0.25	0.31	0.36	0.42	0.47	0.52	2200	
8.57	8.96	9.35	9.73	10.10	10.84	0.05	0.12	0.20	0.26	0.33	0.38	0.44	0.49	0.55	2300	
8.82	9.23	9.62	10.01	10.39	11.14	0.05	0.13	0.20	0.27	0.34	0.40	0.46	0.51	0.57	2400	
9.31	9.73	10.14	10.54	10.94	11.70	0.06	0.14	0.22	0.29	0.37	0.43	0.49	0.56	0.62	2600	
9.76	10.19	10.61	11.02	11.43	12.21	0.06	0.15	0.24	0.31	0.40	0.46	0.53	0.60	0.66	2800	
10.16	10.61	11.04	11.46	11.87	12.65	0.07	0.16	0.26	0.33	0.43	0.49	0.57	0.64	0.71	3000	
10.53	10.98	11.42	11.84	12.25	13.03	0.07	0.17	0.27	0.36	0.46	0.53	0.61	0.69	0.76	3200	
10.86	11.31	11.75	12.17	12.57	13.33	0.08	0.18	0.29	0.38	0.48	0.56	0.65	0.73	0.81	3400	
11.15	11.60	12.03	12.44	12.84	13.57	0.08	0.19	0.31	0.40	0.51	0.59	0.69	0.77	0.85	3600	
11.39	11.83	12.25	12.66	13.04	13.74	0.09	0.20	0.32	0.42	0.54	0.63	0.72	0.81	0.90	3800	
11.58	12.01	12.42	12.81	13.17	13.82	0.09	0.21	0.34	0.45	0.57	0.66	0.76	0.86	0.95	4000	
11.73	12.15	12.54	12.90	13.24	13.83	0.09	0.22	0.36	0.47	0.60	0.69	0.80	0.90	1.00	4200	
11.82	12.22	12.59	12.93	13.24	13.75	0.10	0.23	0.37	0.49	0.63	0.72	0.84	0.94	1.04	4400	
11.87	12.24	12.58	12.89	13.16	13.58	0.10	0.24	0.39	0.51	0.65	0.76	0.88	0.99	1.09	4600	
11.86	12.20	12.51	12.78	13.00	13.33	0.11	0.25	0.41	0.54	0.68	0.79	0.91	1.03	1.14	4800	
11.80	12.11	12.37	12.59	12.77	12.98	0.11	0.26	0.43	0.56	0.71	0.82	0.95	1.07	1.19	5000	

V-BELT DRIVES

B Basic Belt HP Ratings

V-BELT DRIVES

RPM of Faster Shaft	Sheave Pitch Diameter (in inches)															
	3.4	3.6	3.8	4.0	4.2	4.4	4.6	4.8	5.0	5.2	5.4	5.6	5.8	6.0	6.2	6.4
870	0.87	1.18	1.50	1.81	2.12	2.43	2.73	3.04	3.34	3.64	3.94	4.24	4.54	4.83	5.13	5.42
1160	0.94	1.34	1.75	2.15	2.55	2.94	3.33	3.72	4.11	4.50	4.88	5.26	5.64	6.01	6.38	6.75
1750	0.91	1.49	2.06	2.62	3.18	3.74	4.29	4.83	5.37	5.90	6.43	6.95	7.46	7.97	8.47	8.97
3500	0.0	0.67	1.59	2.50	3.37	4.22	5.04	5.84	6.60	7.34	8.04	8.72	9.36	9.96	10.54	11.08
400	0.60	0.75	0.91	1.07	1.22	1.38	1.53	1.68	1.83	1.99	2.14	2.29	2.44	2.59	2.74	2.88
500	0.67	0.87	1.06	1.25	1.44	1.63	1.82	2.00	2.19	2.37	2.56	2.74	2.93	3.11	3.29	3.47
600	0.74	0.97	1.19	1.42	1.64	1.86	2.08	2.30	2.52	2.74	2.96	3.17	3.39	3.60	3.82	4.03
700	0.80	1.06	1.32	1.57	1.83	2.08	2.34	2.59	2.84	3.09	3.34	3.58	3.83	4.08	4.32	4.56
800	0.84	1.13	1.43	1.72	2.00	2.29	2.58	2.86	3.14	3.42	3.70	3.98	4.25	4.53	4.80	5.07
900	0.88	1.20	1.53	1.85	2.17	2.49	2.80	3.12	3.43	3.74	4.05	4.35	4.66	4.96	5.27	5.57
1000	0.91	1.26	1.62	1.97	2.32	2.67	3.02	3.36	3.70	4.04	4.38	4.71	5.05	5.38	5.71	6.04
1100	0.93	1.32	1.70	2.08	2.46	2.84	3.22	3.59	3.96	4.33	4.70	5.06	5.42	5.78	6.14	6.49
1200	0.94	1.36	1.78	2.19	2.60	3.01	3.41	3.81	4.21	4.61	5.00	5.39	5.78	6.16	6.54	6.92
1300	0.95	1.40	1.84	2.29	2.72	3.16	3.59	4.02	4.45	4.87	5.29	5.70	6.12	6.53	6.93	7.34
1400	0.95	1.43	1.90	2.37	2.84	3.30	3.76	4.22	4.67	5.12	5.56	6.01	6.44	6.88	7.31	7.73
1500	0.95	1.45	1.96	2.46	2.95	3.44	3.93	4.41	4.89	5.36	5.83	6.29	6.75	7.21	7.66	8.11
1600	0.94	1.47	2.00	2.53	3.05	3.57	4.08	4.58	5.09	5.58	6.08	6.57	7.05	7.53	8.00	8.47
1700	0.92	1.48	2.04	2.59	3.14	3.68	4.22	4.75	5.28	5.80	6.31	6.82	7.33	7.83	8.32	8.81
1800	0.90	1.49	2.07	2.65	3.23	3.79	4.35	4.91	5.46	6.00	6.54	7.07	7.59	8.11	8.62	9.13
1900	0.87	1.49	2.10	2.70	3.30	3.89	4.48	5.05	5.62	6.19	6.75	7.30	7.84	8.38	8.91	9.43
2000	0.84	1.48	2.12	2.75	3.37	3.98	4.59	5.19	5.78	6.36	6.94	7.51	8.07	8.62	9.17	9.71
2100	0.80	1.47	2.13	2.78	3.43	4.06	4.69	5.31	5.92	6.53	7.12	7.71	8.29	8.85	9.41	9.96
2200	0.76	1.45	2.14	2.81	3.48	4.14	4.79	5.43	6.06	6.68	7.29	7.89	8.48	9.07	9.64	10.20
2300	0.71	1.43	2.14	2.83	3.52	4.20	4.87	5.53	6.18	6.81	7.44	8.06	8.66	9.26	9.84	10.42
2400	0.66	1.40	2.13	2.85	3.56	4.26	4.94	5.62	6.28	6.94	7.58	8.21	8.83	9.43	10.03	10.61
2600	0.54	1.32	2.09	2.86	3.60	4.34	5.06	5.77	6.46	7.14	7.81	8.46	9.10	9.72	10.33	10.92
2800	0.39	1.22	2.03	2.83	3.61	4.38	5.13	5.87	6.59	7.29	7.98	8.65	9.30	9.93	10.55	11.14
3000	0.23	1.09	1.94	2.78	3.59	4.39	5.17	5.92	6.66	7.38	8.08	8.76	9.42	10.05	10.67	11.26
3200	0.04	0.94	1.83	2.69	3.53	4.35	5.15	5.93	6.68	7.41	8.12	8.80	9.46	10.09	10.69	11.27
3400	0.0	0.76	1.68	2.57	3.44	4.28	5.09	5.88	6.64	7.38	8.09	8.76	9.41	10.03	10.62	11.17
3600	0.0	0.56	1.50	2.42	3.30	4.16	4.98	5.78	6.55	7.28	7.98	8.65	9.28	9.87	10.43	10.96
3800	0.0	0.33	1.30	2.23	3.13	3.99	4.83	5.62	6.39	7.11	7.80	8.44	9.05	9.62	10.14	10.62
4000	0.0	0.08	1.06	2.00	2.91	3.79	4.62	5.41	6.16	6.87	7.54	8.15	8.73	9.25	9.73	10.16
4200	0.0	0.0	0.79	1.74	2.66	3.53	4.36	5.14	5.87	6.56	7.19	7.77	8.30	8.78	9.20	9.56
4400	0.0	0.0	0.49	1.45	2.36	3.23	4.04	4.80	5.51	6.17	6.76	7.30	7.78	8.19	8.54	8.83
4600	0.0	0.0	0.15	1.11	2.02	2.87	3.67	4.40	5.08	5.69	6.24	6.73	7.14	7.48	7.76	7.95
4800	0.0	0.0	0.0	0.73	1.63	2.46	3.23	3.94	4.58	5.14	5.63	6.05	6.39	6.65	6.83	6.93
5000	0.0	0.0	0.0	0.31	1.19	2.00	2.74	3.41	3.99	4.50	4.93	5.27	5.53	5.69	5.77	5.75

RIM SPEEDS EXCEED 6500 FEET PER MINUTE.



Basic Belt HP Ratings **B**

Sheave Pitch Diameter (in inches)							"Add-On" HP for Speed Ratio									RPM of Faster Shaft
6.6	6.8	7.0	7.4	8.0	8.6	9.4	1.02- 1.04	1.05- 1.08	1.09- 1.12	1.13- 1.18	1.19- 1.24	1.25- 1.34	1.35- 1.51	1.52- 1.99	2.00 & Up	
5.71	6.00	6.29	6.86	7.71	8.54	9.63	0.05	0.11	0.18	0.24	0.30	0.35	0.41	0.46	0.51	870
7.12	7.48	7.85	8.56	9.62	10.66	12.00	0.06	0.15	0.24	0.32	0.41	0.47	0.54	0.61	0.68	1160
9.46	9.95	10.43	11.37	12.73	14.03	15.68	0.10	0.22	0.37	0.48	0.61	0.71	0.82	0.92	1.02	1750
11.58	12.05	12.48	13.23	14.04	14.48	14.42	0.19	0.45	0.73	0.96	1.22	1.42	1.64	1.84	2.04	3500
3.03	3.18	3.33	3.62	4.05	4.49	5.06	0.02	0.05	0.08	0.11	0.14	0.16	0.19	0.21	0.23	400
3.65	3.83	4.01	4.37	4.89	5.42	6.11	0.03	0.06	0.10	0.14	0.17	0.20	0.23	0.26	0.29	500
4.24	4.45	4.66	5.08	5.70	6.31	7.12	0.03	0.08	0.13	0.16	0.21	0.24	0.28	0.32	0.35	600
4.80	5.04	5.28	5.76	6.47	7.17	8.09	0.04	0.09	0.15	0.19	0.24	0.28	0.33	0.37	0.41	700
5.35	5.62	5.88	6.42	7.21	7.99	9.01	0.04	0.10	0.17	0.22	0.28	0.32	0.37	0.42	0.47	800
5.87	6.16	6.46	7.05	7.92	8.77	9.89	0.05	0.12	0.19	0.25	0.31	0.36	0.42	0.47	0.53	900
6.36	6.69	7.01	7.65	8.60	9.52	10.74	0.06	0.13	0.21	0.27	0.35	0.40	0.47	0.53	0.58	1000
6.84	7.19	7.54	8.23	9.25	10.24	11.54	0.06	0.14	0.23	0.30	0.38	0.45	0.51	0.58	0.64	1100
7.30	7.68	8.05	8.78	9.87	10.93	12.30	0.07	0.15	0.25	0.33	0.42	0.49	0.56	0.63	0.70	1200
7.74	8.14	8.53	9.31	10.46	11.57	13.02	0.07	0.17	0.27	0.36	0.45	0.53	0.61	0.69	0.76	1300
8.16	8.58	8.99	9.81	11.02	12.19	13.69	0.08	0.18	0.29	0.38	0.49	0.57	0.65	0.74	0.82	1400
8.56	9.00	9.43	10.29	11.55	12.76	14.32	0.08	0.19	0.31	0.41	0.52	0.61	0.70	0.79	0.88	1500
8.93	9.39	9.85	10.74	12.05	13.30	14.90	0.09	0.21	0.33	0.44	0.56	0.65	0.75	0.84	0.93	1600
9.29	9.77	10.24	11.17	12.51	13.80	15.43	0.09	0.22	0.36	0.47	0.59	0.69	0.80	0.90	0.99	1700
9.63	10.12	10.61	11.56	12.94	14.26	15.91	0.10	0.23	0.38	0.49	0.63	0.73	0.84	0.95	1.05	1800
9.94	10.45	10.95	11.93	13.34	14.68	16.34	0.11	0.24	0.40	0.52	0.66	0.77	0.89	1.00	1.11	1900
10.24	10.76	11.27	12.27	13.70	15.05	16.72	0.11	0.26	0.42	0.55	0.70	0.81	0.94	1.05	1.17	2000
10.51	11.04	11.56	12.58	14.03	15.38	17.03	0.12	0.27	0.44	0.58	0.73	0.85	0.98	1.11	1.23	2100
10.75	11.29	11.82	12.85	14.31	15.66	17.29	0.12	0.28	0.46	0.60	0.77	0.89	1.03	1.16	1.28	2200
10.98	11.52	12.06	13.10	14.56	15.90	17.49	0.13	0.30	0.48	0.63	0.80	0.93	1.08	1.21	1.34	2300
11.17	11.73	12.27	13.31	14.77	16.09	17.63	0.13	0.31	0.50	0.66	0.84	0.97	1.12	1.27	1.40	2400
11.50	12.06	12.60	13.64	15.06	16.31	17.71	0.14	0.33	0.54	0.71	0.91	1.05	1.22	1.37	1.52	2600
11.72	12.27	12.81	13.82	15.17	16.32	17.51	0.16	0.36	0.59	0.77	0.98	1.13	1.31	1.48	1.63	2800
11.83	12.37	12.89	13.85	15.10	16.10	17.03	0.17	0.39	0.63	0.82	1.05	1.21	1.40	1.58	1.75	3000
11.82	12.34	12.83	13.73	14.83	15.64	16.23	0.18	0.41	0.67	0.88	1.12	1.30	1.50	1.69	1.87	3200
11.69	12.18	12.64	13.44	14.36	14.93	15.11	0.19	0.44	0.71	0.93	1.19	1.38	1.59	1.79	1.98	3400
11.44	11.88	12.29	12.97	13.67	13.95	13.64	0.20	0.46	0.75	0.99	1.26	1.46	1.68	1.90	2.10	3600
11.05	11.44	11.79	12.32	12.75	12.70	11.81	0.21	0.49	0.79	1.04	1.33	1.54	1.78	2.00	2.22	3800
10.53	10.85	11.12	11.49	11.60	11.14	9.60	0.22	0.51	0.84	1.10	1.40	1.62	1.87	2.11	2.33	4000
9.86	10.10	10.28	10.45	10.19	9.28	—	0.23	0.54	0.88	1.15	1.47	1.70	1.96	2.21	2.45	4200
9.05	9.19	9.27	9.20	8.52	7.10	—	0.24	0.56	0.92	1.21	1.54	1.78	2.06	2.32	2.57	4400
8.07	8.11	8.07	7.74	6.58	—	—	0.26	0.59	0.96	1.26	1.61	1.86	2.15	2.42	2.68	4600
6.93	6.85	6.68	6.05	—	—	—	0.27	0.62	1.00	1.32	1.68	1.94	2.25	2.53	2.80	4800
5.63	5.41	5.09	4.13	—	—	—	0.28	0.64	1.05	1.37	1.75	2.02	2.34	2.64	2.92	5000

V-BELT DRIVES

Call *Martin* for your made-to-order and large quantity requirements.

BX Basic Belt HP Ratings

V-BELT DRIVES

RPM of Faster Shaft	Sheave Outside Diameter (in inches)															
	3.4	3.6	3.8	4.0	4.2	4.4	4.6	4.8	5.0	5.2	5.4	5.6	5.8	6.0	6.2	6.4
870	1.64	1.97	2.29	2.61	2.93	3.24	3.56	3.87	4.18	4.49	4.80	5.11	5.42	5.72	6.03	6.33
1160	2.00	2.42	2.83	3.25	3.66	4.06	4.47	4.88	5.28	5.68	6.07	6.47	6.86	7.25	7.64	8.03
1750	2.57	3.17	3.77	4.36	4.95	5.53	6.10	6.67	7.24	7.80	8.36	8.91	9.46	10.00	10.54	11.07
3500	3.34	4.38	5.39	6.38	7.35	8.30	9.22	10.12	11.00	11.86	12.69	13.49	14.27	15.03	15.75	16.45
400	0.93	1.09	1.25	1.40	1.56	1.72	1.87	2.03	2.18	2.34	2.49	2.65	2.80	2.95	3.10	3.25
500	1.10	1.29	1.49	1.68	1.88	2.07	2.26	2.45	2.64	2.83	3.02	3.20	3.39	3.58	3.76	3.95
600	1.26	1.49	1.72	1.95	2.17	2.40	2.63	2.85	3.08	3.30	3.52	3.74	3.96	4.18	4.40	4.62
700	1.41	1.67	1.94	2.20	2.46	2.72	2.98	3.24	3.50	3.75	4.01	4.26	4.52	4.77	5.02	5.27
800	1.55	1.85	2.15	2.44	2.74	3.03	3.32	3.62	3.91	4.19	4.48	4.77	5.05	5.34	5.62	5.90
900	1.68	2.02	2.35	2.68	3.00	3.33	3.66	3.98	4.30	4.62	4.94	5.26	5.57	5.89	6.20	6.51
1000	1.81	2.17	2.54	2.90	3.26	3.62	3.98	4.33	4.69	5.04	5.39	5.73	6.08	6.42	6.77	7.11
1100	1.93	2.33	2.72	3.12	3.51	3.90	4.29	4.67	5.06	5.44	5.82	6.20	6.57	6.95	7.32	7.69
1200	2.04	2.47	2.90	3.33	3.75	4.17	4.59	5.01	5.42	5.83	6.24	6.65	7.05	7.46	7.86	8.25
1300	2.15	2.61	3.07	3.53	3.98	4.44	4.88	5.33	5.77	6.21	6.65	7.09	7.52	7.95	8.38	8.80
1400	2.25	2.75	3.24	3.73	4.21	4.69	5.17	5.64	6.12	6.59	7.05	7.51	7.97	8.43	8.88	9.33
1500	2.35	2.88	3.40	3.92	4.43	4.94	5.45	5.95	6.45	6.95	7.44	7.93	8.41	8.90	9.38	9.85
1600	2.44	3.00	3.55	4.10	4.64	5.18	5.71	6.25	6.77	7.30	7.82	8.33	8.84	9.35	9.85	10.35
1700	2.53	3.12	3.70	4.27	4.85	5.41	5.98	6.53	7.09	7.64	8.18	8.72	9.26	9.79	10.32	10.84
1800	2.62	3.23	3.84	4.44	5.04	5.64	6.23	6.81	7.39	7.97	8.53	9.10	9.66	10.21	10.76	11.31
1900	2.69	3.34	3.98	4.61	5.23	5.86	6.47	7.08	7.69	8.28	8.88	9.47	10.05	10.62	11.19	11.76
2000	2.77	3.44	4.11	4.77	5.42	6.07	6.71	7.34	7.97	8.59	9.21	9.82	10.42	11.02	11.61	12.19
2100	2.84	3.54	4.23	4.92	5.60	6.27	6.93	7.59	8.25	8.89	9.53	10.16	10.78	11.40	12.01	12.61
2200	2.90	3.63	4.35	5.06	5.77	6.46	7.15	7.84	8.51	9.18	9.84	10.49	11.13	11.77	12.39	13.01
2300	2.96	3.72	4.46	5.20	5.93	6.65	7.37	8.07	8.77	9.45	10.13	10.80	11.47	12.12	12.76	13.40
2400	3.02	3.80	4.57	5.33	6.09	6.83	7.57	8.30	9.01	9.72	10.42	11.11	11.79	12.45	13.11	13.76
2600	3.12	3.95	4.77	5.58	6.38	7.17	7.95	8.72	9.47	10.22	10.95	11.67	12.38	13.08	13.76	14.44
2800	3.20	4.08	4.95	5.80	6.65	7.48	8.30	9.10	9.89	10.67	11.43	12.18	12.92	13.64	14.34	15.03
3000	3.26	4.19	5.10	6.00	6.88	7.75	8.61	9.44	10.27	11.07	11.86	12.63	13.39	14.13	14.84	15.55
3200	3.31	4.28	5.23	6.17	7.09	8.00	8.88	9.75	10.60	11.42	12.23	13.02	13.79	14.54	15.27	15.97
3400	3.34	4.35	5.34	6.32	7.27	8.20	9.12	10.01	10.88	11.73	12.55	13.35	14.13	14.88	15.61	16.31
3600	3.34	4.40	5.43	6.43	7.42	8.38	9.31	10.23	11.11	11.97	12.81	13.62	14.40	15.15	15.87	16.56
3800	3.33	4.42	5.48	6.52	7.53	8.52	9.47	10.40	11.30	12.17	13.01	13.81	14.59	15.33	16.04	16.71
4000	3.30	4.43	5.52	6.58	7.61	8.62	9.59	10.53	11.43	12.30	13.14	13.94	14.70	15.43	16.11	16.75
4200	3.26	4.41	5.52	6.61	7.66	8.68	9.66	10.61	11.51	12.38	13.21	13.99	14.73	15.43	16.09	16.69
4400	3.19	4.36	5.50	6.61	7.68	8.70	9.69	10.63	11.54	12.39	13.20	13.97	14.68	15.35	15.96	16.53
4600	3.09	4.30	5.46	6.58	7.65	8.69	9.67	10.61	11.50	12.34	13.13	13.87	14.55	15.17	15.74	16.24
4800	2.98	4.20	5.38	6.51	7.59	8.63	9.61	10.54	11.41	12.23	12.99	13.68	14.32	14.89	15.40	15.84
5000	2.85	4.09	5.28	6.41	7.50	8.53	9.50	10.41	11.26	12.04	12.76	13.42	14.00	14.51	14.95	15.31

RIM SPEEDS EXCEED 6500 FEET PER MINUTE.



Basic Belt HP Ratings BX

Sheave Pitch Diameter (in inches)							"Add-On" HP for Speed Ratio									RPM of Faster Shaft
6.6	6.8	7.0	7.4	8.0	8.6	9.4	1.02- 1.04	1.05- 1.08	1.09- 1.12	1.13- 1.18	1.19- 1.24	1.25- 1.34	1.35- 1.51	1.52- 1.99	2.00 & Up	
6.63	6.93	7.23	7.83	8.71	9.58	10.73	0.04	0.10	0.16	0.20	0.26	0.30	0.35	0.39	0.44	870
8.41	8.80	9.18	9.93	11.05	12.15	13.58	0.06	0.13	0.21	0.27	0.35	0.40	0.47	0.52	0.58	1160
11.60	12.13	12.64	13.67	15.16	16.61	18.46	0.08	0.19	0.31	0.41	0.52	0.61	0.70	0.79	0.88	1750
17.12	17.76	18.37	19.49	20.94	22.09	23.10	1.17	0.39	0.63	0.82	1.05	1.22	1.41	1.58	1.75	3500
3.41	3.56	3.71	4.00	4.45	4.89	5.48	0.02	0.04	0.07	0.09	0.12	0.14	0.16	0.18	0.20	400
4.13	4.32	4.50	4.87	5.41	5.95	6.66	0.02	0.06	0.09	0.12	0.15	0.17	0.20	0.23	0.25	500
4.84	5.05	5.27	5.70	6.34	6.97	7.81	0.03	0.07	0.11	0.14	0.18	0.21	0.24	0.27	0.30	600
5.52	5.77	6.01	6.51	7.24	7.96	8.92	0.03	0.08	0.13	0.16	0.21	0.24	0.28	0.32	0.35	700
6.18	6.46	6.74	7.29	8.11	8.93	10.00	0.04	0.09	0.14	0.19	0.24	0.28	0.32	0.36	0.40	800
6.82	7.13	7.44	8.05	8.96	9.86	11.04	0.04	0.10	0.16	0.21	0.27	0.31	0.36	0.41	0.45	900
7.45	7.79	8.12	8.79	9.78	10.76	12.04	0.05	0.11	0.18	0.24	0.30	0.35	0.40	0.45	0.50	1000
8.06	8.42	8.79	9.51	10.58	11.64	13.02	0.05	0.12	0.20	0.26	0.33	0.38	0.44	0.50	0.55	1100
8.65	9.04	9.43	10.21	11.36	12.48	13.96	0.06	0.13	0.22	0.28	0.36	0.42	0.48	0.54	0.60	1200
9.22	9.64	10.06	10.89	12.11	13.30	14.86	0.06	0.14	0.23	0.31	0.39	0.45	0.52	0.59	0.65	1300
9.78	10.23	10.67	11.54	12.83	14.09	15.73	0.07	0.15	0.25	0.33	0.42	0.49	0.56	0.63	0.70	1400
10.32	10.79	11.26	12.18	13.53	14.85	16.55	0.07	0.17	0.27	0.35	0.45	0.52	0.60	0.68	0.75	1500
10.85	11.34	11.83	12.79	14.20	15.58	17.35	0.08	0.18	0.29	0.38	0.48	0.56	0.64	0.72	0.80	1600
11.36	11.87	12.38	13.38	14.85	16.27	18.10	0.08	0.19	0.30	0.40	0.51	0.59	0.68	0.77	0.85	1700
11.85	12.38	12.91	13.95	15.47	16.93	18.81	0.09	0.20	0.32	0.42	0.54	0.63	0.72	0.81	0.90	1800
12.32	12.87	13.42	14.49	16.06	17.56	19.48	0.09	0.21	0.34	0.45	0.57	0.66	0.76	0.86	0.95	1900
12.77	13.34	13.91	15.01	16.62	18.16	20.10	0.10	0.22	0.36	0.47	0.60	0.69	0.80	0.90	1.00	2000
13.21	13.79	14.37	15.51	17.15	18.71	20.68	0.10	0.23	0.38	0.49	0.63	0.73	0.84	0.95	1.05	2100
13.62	14.23	14.82	15.98	17.65	19.24	21.21	0.10	0.24	0.39	0.52	0.66	0.76	0.88	1.00	1.10	2200
14.02	14.64	15.24	16.42	18.12	19.72	21.69	0.11	0.25	0.41	0.54	0.69	0.80	0.92	1.04	1.15	2300
14.40	15.03	15.64	16.84	18.56	20.16	22.12	0.11	0.26	0.43	0.56	0.72	0.83	0.96	1.09	1.20	2400
15.10	15.74	16.37	17.60	19.33	20.93	22.83	0.12	0.29	0.47	0.61	0.78	0.90	1.04	1.18	1.30	2600
15.71	16.36	17.01	18.24	19.96	21.52	23.32	0.13	0.31	0.50	0.66	0.84	0.97	1.12	1.27	1.40	2800
16.23	16.89	17.53	18.76	20.44	21.93	23.58	0.14	0.33	0.54	0.71	0.90	1.04	1.20	1.36	1.50	3000
16.66	17.32	17.95	19.16	20.77	22.14	23.58	0.15	0.35	0.57	0.75	0.96	1.11	1.28	1.45	1.60	3200
16.99	17.64	18.26	19.42	20.93	22.16	23.33	0.16	0.37	0.61	0.80	1.02	1.18	1.36	1.54	1.70	3400
17.22	17.85	18.44	19.54	20.91	21.96	22.80	0.17	0.40	0.65	0.85	1.08	1.25	1.45	1.63	1.80	3600
17.34	17.94	18.51	19.51	20.72	21.54	21.98	0.18	0.42	0.68	0.89	1.14	1.32	1.53	1.72	1.90	3800
17.36	17.92	18.43	19.33	20.33	20.88	20.86	0.19	0.44	0.72	0.94	1.20	1.39	1.61	1.81	2.00	4000
17.26	17.77	18.23	19.00	19.74	19.97	—	0.20	0.46	0.75	0.99	1.26	1.46	1.69	1.90	2.10	4200
17.03	17.48	17.88	18.49	18.95	18.81	—	0.21	0.48	0.79	1.04	1.32	1.53	1.77	1.99	2.20	4400
16.69	17.07	17.38	17.81	17.94	—	—	0.22	0.51	0.83	1.08	1.38	1.60	1.85	2.08	2.30	4600
16.21	16.51	16.73	16.96	—	—	—	0.23	0.53	0.86	1.13	1.44	1.67	1.93	2.17	2.40	4800
15.60	15.80	15.92	15.91	—	—	—	0.24	0.55	0.90	1.18	1.50	1.74	2.01	2.26	2.50	5000

V-BELT DRIVES

C Basic Belt HP Ratings



V-BELT DRIVES

RPM of Faster Shaft	Sheave Pitch Diameter (in inches)												
	5.0	5.5	6.0	7.0	7.5	8.0	8.5	9.0	9.5	10.0	10.5	11.0	12.0
700	1.93	2.96	3.99	6.01	7.00	7.99	8.96	9.93	10.88	11.83	12.77	13.70	15.52
870	2.10	3.35	4.59	7.02	8.21	9.39	10.56	11.71	12.84	13.97	15.07	16.17	18.31
1160	2.24	3.84	5.42	8.49	9.99	11.46	12.91	14.33	15.73	17.10	18.44	19.75	22.29
1750	2.03	4.24	6.39	10.51	12.47	14.37	16.20	17.96	19.65	21.26	22.79	24.24	26.90
3500	0.0	0.26	2.91	7.12	8.63	9.72	10.36	10.52	10.18	9.32	7.92	—	—
50	0.33	0.43	0.52	0.70	0.80	0.89	0.98	1.07	1.16	1.25	1.34	1.43	1.60
100	0.56	0.74	0.92	1.27	1.44	1.61	1.78	1.96	2.12	2.29	2.46	2.63	2.96
150	0.76	1.01	1.27	1.78	2.03	2.28	2.53	2.77	3.02	3.26	3.51	3.75	4.23
200	0.92	1.26	1.59	2.25	2.58	2.90	3.22	3.54	3.86	4.18	4.50	4.81	5.43
300	1.21	1.69	2.17	3.13	3.60	4.06	4.53	4.99	5.45	5.91	6.36	6.81	7.71
400	1.44	2.07	2.69	3.93	4.53	5.14	5.74	6.34	6.93	7.52	8.10	8.68	9.84
500	1.63	2.40	3.16	4.67	5.41	6.15	6.88	7.60	8.32	9.04	9.75	10.45	11.84
600	1.79	2.70	3.60	5.36	6.23	7.09	7.95	8.80	9.64	10.47	11.30	12.12	13.74
700	1.93	2.96	3.99	6.01	7.00	7.99	8.96	9.93	10.88	11.83	12.77	13.70	15.52
800	2.03	3.20	4.35	6.62	7.73	8.83	9.92	11.00	12.06	13.11	14.15	15.18	17.20
900	2.12	3.41	4.69	7.19	8.41	9.63	10.82	12.00	13.17	14.32	15.45	16.57	18.77
1000	2.18	3.60	4.99	7.72	9.05	10.37	11.67	12.95	14.21	15.45	16.67	17.87	20.22
1100	2.23	3.76	5.27	8.21	9.65	11.07	12.46	13.83	15.18	16.50	17.80	19.08	21.55
1200	2.25	3.89	5.51	8.67	10.21	11.72	13.20	14.65	16.08	17.48	18.84	20.18	22.76
1300	2.25	4.01	5.73	9.09	10.72	12.32	13.88	15.41	16.91	18.37	19.79	21.18	23.83
1400	2.24	4.10	5.93	9.47	11.19	12.87	14.50	16.10	17.66	19.17	20.64	22.06	24.77
1500	2.20	4.17	6.10	9.82	11.61	13.36	15.07	16.72	18.33	19.88	21.39	22.84	25.57
1600	2.15	4.22	6.24	10.13	11.99	13.81	15.57	17.27	18.92	20.51	22.03	23.49	26.22
1700	2.08	4.24	6.35	10.39	12.33	14.20	16.01	17.75	19.43	21.03	22.57	24.03	26.71
1800	1.98	4.24	6.43	10.62	12.61	14.53	16.38	18.15	19.85	21.46	22.99	24.43	27.04
1900	1.87	4.21	6.49	10.80	12.85	14.81	16.69	18.48	20.18	21.78	23.29	24.70	27.19
2000	1.74	4.17	6.51	10.95	13.03	15.02	16.92	18.72	20.41	22.00	23.47	24.83	27.17
2100	1.60	4.10	6.51	11.05	13.16	15.18	17.09	18.88	20.55	22.10	23.52	24.81	26.96
2200	1.43	4.00	6.47	11.10	13.24	15.27	17.17	18.95	20.59	22.08	23.44	24.64	26.56
2300	1.24	3.88	6.41	11.11	13.27	15.30	17.19	18.93	20.52	21.95	23.22	24.31	25.96
2400	1.03	3.73	6.31	11.07	13.24	15.25	17.12	18.81	20.34	21.69	22.85	23.82	25.15
2600	0.55	3.36	6.02	10.84	12.99	14.96	16.73	18.30	19.65	20.78	21.67	22.33	22.86
2800	0.0	2.88	5.59	10.41	12.50	14.37	16.00	17.37	18.48	19.32	19.86	20.11	19.65
3000	0.0	2.28	5.01	9.76	11.75	13.47	14.89	16.01	16.80	17.26	17.37	17.12	15.44
3200	0.0	1.57	4.29	8.89	10.73	12.23	13.39	14.18	14.59	14.59	14.17	13.30	—
3400	0.0	0.73	3.41	7.77	9.41	10.65	11.48	11.87	11.80	11.25	10.20	8.62	—
3600	0.0	0.0	2.37	6.41	7.78	8.70	9.13	9.04	8.41	7.22	5.43	—	—
3800	0.0	0.0	1.15	4.77	5.84	6.36	6.32	5.67	4.39	2.45	—	—	—

■ RIM SPEEDS EXCEED 6500 FEET PER MINUTE.



Basic Belt HP Ratings **C**

Sheave Pitch Diameter			"Add-On" HP for Speed Ratio										RPM of Faster Shaft
13.0	14.0	16.0	1.00- 1.01	1.02- 1.04	1.05- 1.08	1.09- 1.12	1.13- 1.18	1.19- 1.24	1.25- 1.34	1.35- 1.51	1.52- 1.99	2.00 & Up	
17.31	19.07	22.46	0.0	0.09	0.21	0.34	0.45	0.57	0.66	0.77	0.86	0.96	700
20.39	22.41	26.26	0.0	0.11	0.26	0.43	0.56	0.71	0.83	0.95	1.07	1.19	870
24.71	27.00	31.19	0.0	0.15	0.35	0.57	0.75	0.95	1.10	1.27	1.43	1.59	1160
29.19	31.11	33.71	0.0	0.23	0.53	0.86	1.12	1.43	1.66	1.92	2.16	2.39	1750
—	—	—	0.0	0.46	1.05	1.71	2.25	2.87	3.32	3.84	4.32	4.79	3500
1.78	1.95	2.30	0.0	0.01	0.02	0.02	0.03	0.04	0.05	0.05	0.06	0.07	50
3.29	3.62	4.27	0.0	0.01	0.03	0.05	0.06	0.08	0.09	0.11	0.12	0.14	100
4.71	5.18	6.12	0.0	0.02	0.05	0.07	0.10	0.12	0.14	0.16	0.19	0.21	150
6.05	6.67	7.88	0.0	0.03	0.06	0.10	0.13	0.16	0.19	0.22	0.25	0.27	200
8.59	9.47	11.21	0.0	0.04	0.09	0.15	0.19	0.25	0.28	0.33	0.37	0.41	300
10.97	12.10	14.31	0.0	0.05	0.12	0.20	0.26	0.33	0.38	0.44	0.49	0.55	400
13.22	14.57	17.22	0.0	0.07	0.15	0.24	0.32	0.41	0.47	0.55	0.62	0.68	500
15.33	16.89	19.94	0.0	0.08	0.18	0.29	0.39	0.49	0.57	0.66	0.74	0.82	600
17.31	19.07	22.46	0.0	0.09	0.21	0.34	0.45	0.57	0.66	0.77	0.86	0.96	700
19.17	21.09	24.77	0.0	0.10	0.24	0.39	0.51	0.66	0.76	0.88	0.99	1.09	800
20.89	22.95	26.87	0.0	0.12	0.27	0.44	0.58	0.74	0.85	0.99	1.11	1.23	900
22.48	24.65	28.73	0.0	0.13	0.30	0.49	0.64	0.82	0.95	1.10	1.24	1.37	1000
23.92	26.18	30.35	0.0	0.14	0.33	0.54	0.71	0.90	1.04	1.21	1.36	1.50	1100
25.20	27.52	31.70	0.0	0.16	0.36	0.59	0.77	0.98	1.14	1.32	1.48	1.64	1200
26.33	28.66	32.78	0.0	0.17	0.39	0.64	0.84	1.06	1.23	1.43	1.61	1.78	1300
27.29	29.60	33.56	0.0	0.18	0.42	0.69	0.90	1.15	1.33	1.53	1.73	1.91	1400
28.07	30.32	34.03	0.0	0.20	0.45	0.73	0.96	1.23	1.42	1.64	1.85	2.05	1500
28.67	30.82	34.16	0.0	0.21	0.48	0.78	1.03	1.31	1.52	1.75	1.98	2.19	1600
29.07	31.07	33.95	0.0	0.22	0.51	0.83	1.09	1.39	1.61	1.86	2.10	2.33	1700
29.26	31.08	33.37	0.0	0.23	0.54	0.88	1.16	1.47	1.71	1.97	2.22	2.46	1800
29.24	30.82	32.41	0.0	0.25	0.57	0.93	1.22	1.56	1.80	2.08	2.35	2.60	1900
29.00	30.28	31.04	0.0	0.26	0.60	0.98	1.29	1.64	1.90	2.19	2.47	2.74	2000
28.53	29.46	29.24	0.0	0.27	0.63	1.03	1.35	1.72	1.99	2.30	2.59	2.87	2100
27.81	28.33	27.01	0.0	0.29	0.66	1.08	1.41	1.80	2.09	2.41	2.72	3.01	2200
26.84	26.89	24.31	0.0	0.30	0.69	1.13	1.48	1.88	2.18	2.52	2.84	3.15	2300
25.60	25.13	—	0.0	0.31	0.72	1.18	1.54	1.97	2.28	2.63	2.97	3.28	2400
22.31	20.58	—	0.0	0.34	0.78	1.27	1.67	2.13	2.47	2.85	3.21	3.56	2600
17.84	—	—	0.0	0.36	0.84	1.37	1.80	2.29	2.66	3.07	3.46	3.83	2800
—	—	—	0.0	0.39	0.90	1.47	1.93	2.46	2.85	3.29	3.71	4.10	3000
—	—	—	0.0	0.42	0.96	1.57	2.06	2.62	3.04	3.51	3.95	4.38	3200
—	—	—	0.0	0.44	1.02	1.67	2.18	2.79	3.23	3.73	4.20	4.65	3400
—	—	—	0.0	0.47	1.08	1.76	2.31	2.95	3.42	3.95	4.45	4.92	3600
—	—	—	0.0	0.49	1.14	1.86	2.44	3.11	3.61	4.17	4.69	5.20	3800

V-BELT DRIVES

CX Basic Belt HP Ratings

V-BELT DRIVES

RPM of Faster Shaft	Sheave Pitch Diameter (in inches)												
	5.0	5.5	6.0	7.0	7.5	8.0	8.5	9.0	9.5	10.0	10.5	11.0	12.0
700	3.58	4.63	5.67	7.72	8.73	9.73	10.72	11.70	12.68	13.65	14.61	15.56	17.43
870	4.17	5.45	6.70	9.18	10.39	11.60	12.79	13.97	15.14	16.29	17.43	18.56	20.78
1160	5.05	6.68	8.29	11.44	12.98	14.50	16.00	17.47	18.92	20.35	21.76	23.14	25.83
1750	6.39	8.67	10.90	15.20	17.27	19.28	21.24	23.14	24.98	26.75	28.46	30.10	33.18
3500	6.80	10.15	13.22	18.46	20.60	22.38	23.80	24.82	25.44	25.63	25.37	—	—
50	0.44	0.53	0.63	0.81	0.90	0.99	1.08	1.17	1.26	1.35	1.44	1.53	1.71
100	0.78	0.96	1.14	1.49	1.66	1.83	2.00	2.18	2.35	2.51	2.68	2.85	3.19
150	1.09	1.35	1.60	2.11	2.36	2.61	2.86	3.11	3.36	3.60	3.85	4.09	4.58
200	1.37	1.71	2.04	2.71	3.03	3.36	3.68	4.01	4.33	4.65	4.96	5.28	5.91
300	1.89	2.38	2.87	3.82	4.30	4.77	5.24	5.70	6.16	6.62	7.08	7.54	8.44
400	2.36	3.00	3.63	4.87	5.48	6.09	6.70	7.30	7.90	8.50	9.09	9.68	10.85
500	2.80	3.57	4.34	5.86	6.61	7.36	8.10	8.83	9.56	10.29	11.01	11.72	13.14
600	3.20	4.12	5.02	6.81	7.69	8.57	9.44	10.30	11.15	12.00	12.84	13.68	15.34
700	3.58	4.63	5.67	7.72	8.73	9.73	10.72	11.70	12.68	13.65	14.61	15.56	17.43
800	3.94	5.12	6.29	8.59	9.72	10.84	11.95	13.06	14.14	15.22	16.29	17.35	19.44
900	4.27	5.58	6.88	9.42	10.68	11.91	13.14	14.35	15.55	16.74	17.91	19.07	21.34
1000	4.59	6.02	7.44	10.23	11.59	12.94	14.28	15.60	16.90	18.18	19.45	20.70	23.15
1100	4.88	6.44	7.98	10.99	12.47	13.93	15.37	16.79	18.18	19.56	20.92	22.25	24.86
1200	5.16	6.84	8.49	11.73	13.31	14.87	16.41	17.92	19.41	20.87	22.31	23.72	26.46
1300	5.42	7.22	8.98	12.44	14.12	15.78	17.40	19.00	20.57	22.11	23.62	25.09	27.95
1400	5.66	7.57	9.45	13.11	14.89	16.63	18.35	20.02	21.67	23.28	24.85	26.38	29.33
1500	5.89	7.91	9.89	13.75	15.62	17.45	19.24	20.99	22.70	24.37	25.99	27.57	30.59
1600	6.10	8.23	10.31	14.35	16.31	18.22	20.08	21.90	23.66	25.38	27.05	28.66	31.72
1700	6.30	8.53	10.71	14.93	16.96	18.94	20.87	22.74	24.56	26.32	28.01	29.65	32.72
1800	6.47	8.80	11.08	15.46	17.57	19.62	21.60	23.52	25.38	27.17	28.88	30.53	33.59
1900	6.63	9.06	11.43	15.97	18.14	20.24	22.28	24.24	26.12	27.93	29.65	31.30	34.32
2000	6.78	9.30	11.75	16.43	18.67	20.82	22.89	24.88	26.79	28.60	30.32	31.95	34.90
2100	6.91	9.51	12.04	16.86	19.15	21.35	23.45	25.46	27.37	29.18	30.89	32.48	35.32
2200	7.02	9.71	12.31	17.26	19.59	21.82	23.95	25.97	27.88	29.67	31.34	32.89	35.59
2300	7.11	9.88	12.56	17.61	19.98	22.24	24.38	26.40	28.29	30.05	31.68	33.17	35.69
2400	7.19	10.03	12.77	17.92	20.32	22.60	24.74	26.75	28.62	30.34	31.90	33.31	35.62
2600	7.28	10.27	13.13	18.43	20.87	23.15	25.26	27.22	28.99	30.58	31.98	33.17	34.94
2800	7.31	10.41	13.36	18.77	21.20	23.45	25.50	27.34	28.97	30.37	31.53	32.44	33.50
3000	7.26	10.46	13.48	18.92	21.32	23.49	25.43	27.11	28.53	29.67	30.53	31.08	31.24
3200	7.14	10.42	13.48	18.89	21.21	23.27	25.03	26.50	27.65	28.46	28.94	29.04	—
3400	6.93	10.26	13.34	18.66	20.87	22.75	24.30	25.49	26.30	26.72	26.72	26.30	—
3600	6.64	10.00	13.07	18.22	20.27	21.94	23.21	24.05	24.46	24.40	23.85	—	—
3800	6.26	9.63	12.65	17.56	19.41	20.81	21.74	22.18	22.10	21.48	—	—	—

RIM SPEEDS EXCEED 6500 FEET PER MINUTE.



Basic Belt CX HP Ratings

Sheave Pitch Diameter			"Add-On" HP for Speed Ratio										RPM of Faster Shaft
13.0	14.0	16.0	1.00- 1.01	1.02- 1.04	1.05- 1.08	1.09- 1.12	1.13- 1.18	1.19- 1.24	1.25- 1.34	1.35- 1.51	1.52- 1.99	2.00 & Up	
19.28	21.09	24.62	0.0	0.08	0.18	0.29	0.37	0.48	0.55	0.64	0.72	0.80	700
22.95	25.07	29.14	0.0	0.09	0.22	0.35	0.47	0.59	0.69	0.79	0.89	0.99	870
28.42	30.90	35.54	0.0	0.13	0.29	0.47	0.62	0.79	0.92	1.06	1.19	1.32	1160
35.95	38.42	42.34	0.0	0.19	0.44	0.71	0.94	1.19	1.38	1.60	1.80	1.99	1750
—	—	—	0.0	0.38	0.88	1.43	1.87	2.39	2.76	3.19	3.60	3.98	3500
1.88	2.06	2.40	0.0	0.01	0.01	0.02	0.03	0.03	0.04	0.05	0.05	0.06	50
3.52	3.85	4.50	0.0	0.01	0.03	0.04	0.05	0.07	0.08	0.09	0.10	0.11	100
5.06	5.53	6.48	0.0	0.02	0.04	0.06	0.08	0.10	0.12	0.14	0.15	0.17	150
6.53	7.15	8.38	0.0	0.02	0.05	0.08	0.11	0.14	0.16	0.18	0.21	0.23	200
9.34	10.23	11.99	0.0	0.03	0.08	0.12	0.16	0.20	0.24	0.27	0.31	0.34	300
12.00	13.15	15.40	0.0	0.04	0.10	0.16	0.21	0.27	0.32	0.36	0.41	0.46	400
14.54	15.93	18.64	0.0	0.05	0.13	0.20	0.27	0.34	0.39	0.46	0.51	0.57	500
16.97	18.57	21.72	0.0	0.06	0.15	0.24	0.32	0.41	0.47	0.55	0.62	0.68	600
19.28	21.09	24.62	0.0	0.08	0.18	0.29	0.37	0.48	0.55	0.64	0.72	0.80	700
21.48	23.48	27.34	0.0	0.09	0.20	0.33	0.43	0.55	0.63	0.73	0.82	0.91	800
23.56	25.73	29.88	0.0	0.10	0.23	0.37	0.48	0.61	0.71	0.82	0.93	1.02	900
25.53	27.84	32.22	0.0	0.11	0.25	0.41	0.53	0.68	0.79	0.91	1.03	1.14	1000
27.37	29.80	34.36	0.0	0.12	0.28	0.45	0.59	0.75	0.87	1.00	1.13	1.25	1100
29.09	31.61	36.28	0.0	0.13	0.30	0.49	0.64	0.82	0.95	1.09	1.23	1.37	1200
30.67	33.25	37.97	0.0	0.14	0.33	0.53	0.70	0.89	1.03	1.19	1.34	1.48	1300
32.11	34.73	39.41	0.0	0.15	0.35	0.57	0.75	0.95	1.11	1.28	1.44	1.59	1400
33.41	36.03	40.60	0.0	0.16	0.38	0.61	0.80	1.02	1.18	1.37	1.54	1.71	1500
34.55	37.13	41.51	0.0	0.17	0.40	0.65	0.86	1.09	1.26	1.46	1.64	1.82	1600
35.53	38.04	42.14	0.0	0.18	0.43	0.69	0.91	1.16	1.34	1.55	1.75	1.93	1700
36.34	38.74	42.46	0.0	0.19	0.45	0.73	0.96	1.23	1.42	1.64	1.85	2.05	1800
36.97	39.23	42.47	0.0	0.21	0.48	0.77	1.02	1.29	1.50	1.73	1.95	2.16	1900
37.42	39.49	42.15	0.0	0.22	0.50	0.82	1.07	1.36	1.58	1.82	2.06	2.28	2000
37.68	39.51	41.48	0.0	0.23	0.53	0.86	1.12	1.43	1.66	1.92	2.16	2.39	2100
37.74	39.29	40.45	0.0	0.24	0.55	0.90	1.18	1.50	1.74	2.01	2.26	2.50	2200
37.59	38.81	39.04	0.0	0.25	0.58	0.94	1.23	1.57	1.82	2.10	2.36	2.62	2300
37.22	38.06	—	0.0	0.26	0.60	0.98	1.28	1.64	1.89	2.19	2.47	2.73	2400
35.81	35.72	—	0.0	0.28	0.65	1.06	1.39	1.77	2.05	2.37	2.67	2.96	2600
33.44	—	—	0.0	0.30	0.70	1.14	1.50	1.91	2.21	2.55	2.88	3.19	2800
—	—	—	0.0	0.32	0.75	1.22	1.60	2.04	2.37	2.74	3.08	3.41	3000
—	—	—	0.0	0.35	0.80	1.30	1.71	2.18	2.53	2.92	3.29	3.64	3200
—	—	—	0.0	0.37	0.85	1.39	1.82	2.32	2.68	3.10	3.49	3.87	3400
—	—	—	0.0	0.39	0.90	1.47	1.92	2.45	2.84	3.28	3.70	4.10	3600
—	—	—	0.0	0.41	0.95	1.55	2.03	2.59	3.00	3.47	3.91	4.32	3800

V-BELT DRIVES

D Basic Belt HP Ratings

V-BELT DRIVES

RPM of Faster Shaft	Sheave Pitch Diameter (in inches)										
	12.0	13.0	13.5	14.0	14.5	15.0	15.5	16.0	18.0	20.0	22.0
430	13.52	15.78	16.91	18.02	19.13	20.23	21.33	22.42	26.71	30.91	34.99
580	16.92	19.82	21.26	22.68	24.09	25.48	26.87	28.24	33.62	38.79	43.76
700	19.32	22.67	24.32	25.95	27.57	29.17	30.75	32.31	38.36	44.11	49.52
870	22.20	26.10	28.01	29.89	31.74	33.56	35.34	37.10	43.80	49.95	55.52
1160	25.69	30.21	32.39	34.50	36.55	38.54	40.46	42.32	49.05	54.59	58.84
1750	26.15	30.40	32.25	33.92	35.39	36.67	37.74	38.61	39.84	37.24	—
3500	—	—	—	—	—	—	—	—	—	—	—
50	2.26	2.59	2.75	2.91	3.07	3.24	3.40	3.56	4.19	4.82	5.44
100	4.10	4.71	5.02	5.32	5.63	5.93	6.23	6.53	7.73	8.91	10.09
150	5.76	6.65	7.09	7.53	7.97	8.41	8.85	9.28	11.01	12.72	14.41
200	7.32	8.47	9.04	9.61	10.18	10.75	11.32	11.88	14.11	16.32	18.50
300	10.18	11.84	12.66	13.48	14.29	15.11	15.91	16.72	19.90	23.04	26.12
400	12.78	14.91	15.97	17.02	18.06	19.10	20.13	21.16	25.21	29.17	33.05
500	15.16	17.74	19.01	20.27	21.53	22.77	24.01	25.24	30.06	34.75	39.29
600	17.34	20.32	21.79	23.25	24.70	26.13	27.55	28.96	34.46	39.74	44.80
700	19.32	22.67	24.32	25.95	27.57	29.17	30.75	32.31	38.36	44.11	49.52
800	21.09	24.78	26.59	28.37	30.13	31.87	33.58	35.27	41.75	47.80	53.38
900	22.65	26.64	28.58	30.49	32.38	34.22	36.04	37.82	44.59	50.76	56.29
1000	24.00	28.23	30.29	32.30	34.27	36.20	38.09	39.93	46.83	52.93	58.18
1100	25.12	29.56	31.69	33.78	35.81	37.79	39.71	41.57	48.42	54.24	58.95
1200	26.01	30.59	32.78	34.91	36.97	38.96	40.87	42.72	49.33	54.63	58.51
1300	26.66	31.32	33.54	35.67	37.72	39.68	41.55	43.33	49.50	54.04	56.78
1400	27.04	31.73	33.93	36.03	38.03	39.92	41.71	43.38	48.89	52.38	53.66
1500	27.15	31.81	33.96	35.99	37.89	39.67	41.32	42.83	47.44	49.60	49.06
1600	26.98	31.52	33.59	35.51	37.28	38.89	40.35	41.64	45.11	45.61	42.87
1700	26.50	30.87	32.81	34.57	36.15	37.56	38.77	39.79	41.84	40.36	35.02
1800	25.72	29.83	31.59	33.15	34.50	35.64	36.55	37.24	37.58	33.78	—

■ RIM SPEEDS EXCEED 6500 FEET PER MINUTE.



Basic Belt HP Ratings **D**

"Add-On" HP for Speed Ratio									RPM of Faster Shaft
1.02- 1.04	1.05- 1.08	1.09- 1.12	1.13- 1.18	1.19- 1.24	1.25- 1.34	1.35- 1.51	1.52- 1.99	2.00 & Up	
0.16	0.37	0.60	0.79	1.01	1.17	1.35	1.53	1.69	430
0.22	0.50	0.82	1.07	1.36	1.58	1.83	2.06	2.28	580
0.26	0.60	0.98	1.29	1.65	1.91	2.20	2.48	2.75	700
0.32	0.75	1.22	1.61	2.05	2.37	2.74	3.09	3.42	870
0.43	1.00	1.63	2.14	2.73	3.16	3.65	4.11	4.56	1160
0.65	1.51	2.46	3.23	4.12	4.77	5.51	6.21	6.87	1750
1.31	3.02	4.92	6.46	8.23	9.54	11.02	12.41	13.75	3500
0.02	0.04	0.07	0.09	0.12	0.14	0.16	0.18	0.20	50
0.04	0.09	0.14	0.18	0.24	0.27	0.31	0.35	0.39	100
0.06	0.13	0.21	0.28	0.35	0.41	0.47	0.53	0.59	150
0.07	0.17	0.28	0.37	0.47	0.54	0.63	0.71	0.79	200
0.11	0.26	0.42	0.55	0.71	0.82	0.94	1.06	1.18	300
0.15	0.35	0.56	0.74	0.94	1.09	1.26	1.42	1.57	400
0.19	0.43	0.70	0.92	1.18	1.36	1.57	1.77	1.96	500
0.22	0.52	0.84	1.11	1.41	1.63	1.89	2.13	2.36	600
0.26	0.60	0.98	1.29	1.65	1.91	2.20	2.48	2.75	700
0.30	0.69	1.13	1.48	1.88	2.18	2.52	2.84	3.14	800
0.34	0.78	1.27	1.66	2.12	2.45	2.83	3.19	3.53	900
0.37	0.86	1.41	1.85	2.35	2.72	3.15	3.55	3.93	1000
0.41	0.95	1.55	2.03	2.59	3.00	3.46	3.90	4.32	1100
0.45	1.04	1.69	2.21	2.82	3.27	3.78	4.26	4.71	1200
0.49	1.12	1.83	2.40	3.06	3.54	4.09	4.61	5.11	1300
0.52	1.21	1.97	2.58	3.29	3.81	4.41	4.97	5.50	1400
0.56	1.30	2.11	2.77	3.53	4.09	4.72	5.32	5.89	1500
0.60	1.38	2.25	2.95	3.76	4.36	5.04	5.68	6.28	1600
0.63	1.47	2.39	3.14	4.00	4.63	5.35	6.03	6.68	1700
0.67	1.55	2.53	3.32	4.23	4.90	5.67	6.38	7.07	1800

V-BELT DRIVES

Call *Martin* for your made-to-order and large quantity requirements.

Other Driver Speeds/ Speed-Up Drives

FOR SPEEDS OTHER THAN STANDARD MOTOR SPEEDS AND SPEED-UP DRIVES THE FOLLOWING PROCEDURES CAN BE USED:

SPEEDS OTHER THAN STANDARD MOTOR SPEEDS:

EXAMPLE

A 10 HP 3000 RPM single cylinder engine with an output shaft of 1¼" is to drive a rotary pump with an input shaft of 1½" at 2025 RPM. Approximate center distance is 40", service is intermittent.

STEP 1. DETERMINE THE SERVICE FACTOR, DESIGN HORSEPOWER AND BELT CROSS SECTION as detailed in stock drive selection.

Example: The **Service Factor is 1.2**. The **Design HP is 12** (10 HP x 1.2). The **Belt Cross Section is 3VX**. (The decision to use Hi-Cap wedge was arbitrary.)

STEP 2. DETERMINE SPEED RATIO.

Speed ratio = DriveR RPM ÷ DriveN RPM

Example: 3000/2025 = 1.48.

STEP 3. SELECT SHEAVE COMBINATION

- Turn to **Stock Drive Selection** chart for applicable belt cross section
- Find **Speed Ratio**
- Read across to find **Sheave Diameter, Approximate Center Distance, Belt Number and Arc & Length Correction Factor**. (If ratios given aren't close enough to desired, turn to non stock drive design.)
- Determine **Belt Speed** to insure 5000 FPM (for static balancing) or 6500 FPM (for dynamically balanced) is not exceeded. Use formula:
 $FPM = .262 \times RPM \times O.D.$

Example:

From 3V drive selection chart, a **1.48 Speed Ratio** utilizes a **2.80" DriveR Sheave** and a **4.12" DriveN Sheave**. A standard 3VX900 has a **center distance of 39.6"** and a **correction factor of 1.06**.

$FPM = .262 \times 4.12 \times 2025 = 2186$

STEP 4. DETERMINE BELT HORSEPOWER

- Turn to **Basic Belt Horsepower rating** table for applicable belt.
- Find the **RPM of the faster shaft**.
- Read across to the intersection of the **smaller sheave diameter for the rated HP per belt**.
- Continue across to the "Add-On" HP** for the **speed ratio**. Add this value to the **HP per belt**. Basic HP per belt + "Add on" = Rated HP per belt.
- Multiply the **HP per Belt** by the Arc & Length correction factor to reach corrected HP per belt.

Rated HP x Arc & Length correction factor = corrected HP per Belt.

Example: from **Basic Belt Horsepower Ratings for 3VX at 3000 RPM and 2.80" small sheave diameter** for a **1.48 speed ratio**, the **Rated HP per Belt is 4.16**.

(Rated HP = 3.76 + .40 = 4.16)

$4.16 \times 1.06 = 4.41 = \text{corrected HP per Belt}$.

STEP 5. DETERMINE NUMBER OF BELTS REQUIRED.

Design HP ÷ corrected HP per belt = # of belts required.

Example: 12 ÷ 4.41 = 2.72. Use 3 belts.

STEP 6. ORDER *Martin*

(1) 3 3V 280 JA DriveR sheave

(1) JA 1¼" bushing

(1) 3 3V 412 SH DriveN sheave

(1) SH 1½" bushing

NOTE: The choice of QD bushings was arbitrary.

SPEED-UP DRIVES

NOTE: In a Speed-Up Drive, the motor (driver) sheave is the larger sheave.

Example: A 10 HP 1160 RPM, normal torque electric motor with a 1¼" shaft is to drive an exhauster with a 1½" shaft at 1800 RPM. Approx. center distance is 30". The drive will run 10 hours per day.

STEP 1. SERVICE FACTOR = 1.1 (FROM TABLE 1.)

Design HP = 10 x 1.1 = 11

Belt cross section = B

(Decision to use B was arbitrary)

STEP 2. SPEED RATIO = FASTER RPM ÷ SLOWER

RPM = 1800 ÷ 1160 = 1.55.

STEP 3. FROM STOCK DRIVE SELECTION for B Belts at

1.55 speed ratio, the sheave combination of **4.0" DriveR and 6.2" DriveN** is listed. (Remember, on a speed-up drive the larger sheave now becomes the driveR.) Approximate **center distance** is 30.4" with a **correction factor of .95** for a B75 belt. **Belt speed is 1886** (.262 x 4.0 x 1800).

STEP 4. FROM BASIC BELT HP RATINGS for B Belts, a 4.0 sheave at 1800 RPM has a **Rated HP Per Belt of 3.6**, and a corrected HP of $(2.65 + .95) \times .95 = 3.42$.

STEP 5. NUMBER OF BELTS REQUIRED = Design HP ÷

Corrected HP. $11 \div 3.42 = 3.22$. Use 4 belts.

STEP 6. Order *Martin*

(1) 4 B 62 2517 DriveR sheave

(1) 2517 1¼" bushing

(1) 4 B 40 1610 DriveN sheave

(1) 2517 1½" bushing

NOTE: The choice of Tapered bushings was arbitrary.

QUARTER TURN DRIVES are used to transmit power from a horizontal shaft to a vertical shaft or vice versa. On a V-Belt quarter turn drive, made to order sheaves with deeper and wider grooves are required. See Table 15 below for sheave face width.

To design a quarter turn drive, proceed as you would to select any conventional V-belt drive. Taking the following special points into consideration:

1. Maximum speed ratio 2.5 to 1.
2. Center distance should be equal to 5.5 times the sum of the diameter of the large sheave plus its face width. Long centers are necessary to insure the angle of entry of the belts in the sheave grooves is not more than 5 degrees.
3. The center line of the horizontal shaft on the quarter turn drives should be above the center of the vertical shaft sheave (see sketches below).

4. Use 90% of the horsepower rating given in the basic horsepower tables.
5. Arc of contact correction factor can be disregarded on Quarter Turn Drives.

ALIGNING THE DRIVE

When looking down on the drive (Top View), sheaves should be installed so that a line from the center of the Vertical Shaft will pass through the center of the face of the sheave on the horizontal shaft. Both shafts should be at right angles to this line.

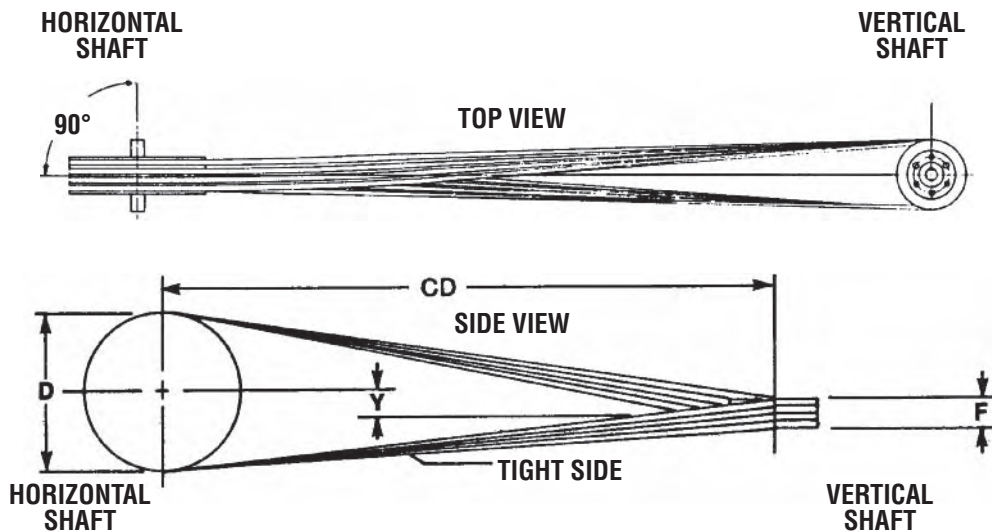

Minimum $CD = 5.5 (D + F)$
 $D =$ Pitch Diameter
 $F =$ Face Width (from Table 15)

When looking at the drive from the side (Side View) the center of the horizontal shaft should be above the center of the sheave on the Vertical Shaft by the amount shown under value "Y" from Table 14.

Table 14 — Quarter-Turn Drive Y Dimensions

Drive Center Distance (CD)	Y	Drive Center Distance (CD)	Y
60"	2.50"	160"	6.50"
80"	2.75"	180"	7.75"
100"	3.00"	200"	9.00"
120"	4.00"	220"	10.50"
140"	5.25"	240"	12.00"

Table 15 — Face Width "F" of Sheaves Used on Quarter-Turn Drives

Section	No. of Grooves												Add To P.D. to Get O.D.
	1	2	3	4	5	6	7	8	9	10	11	12	
A	.87	1.62	2.37	3.12	3.87	4.62	5.37	6.12	6.87	7.62	8.37	9.12	.560
B	1.12	2.00	2.87	3.75	4.62	5.50	6.37	7.25	8.12	9.00	9.87	10.75	.710
C	1.62	2.87	4.12	5.37	6.62	7.87	9.12	10.37	11.62	12.87	14.12	15.37	1.010
D	2.12	3.87	5.62	7.37	9.12	10.87	12.62	14.37	16.12	17.87	19.62	21.37	1.430
E	2.62	4.68	6.75	8.81	10.87	12.93	15.00	17.06	19.12	21.18	23.25	25.31	1.690

Installation/ Tensioning V-Drives

Martin

Installing A Drive

Here are a few suggestions to keep in mind when installing the drive:

1. Use a matched set of belts.
2. Clean oil and grease from the sheaves; remove any rust or burrs from the sheave grooves.
3. Shorten the center distance of the drive until the belts can be put on the sheaves without forcing.
4. Make sure that the sheaves are correctly aligned, that the shafts are parallel, that there is clearance for the drive to run and that the bearings have oil.
5. Work belts around in the groove by hand, so that the slack of **all** belts is on the top, or slack of **all** belts is on the bottom.

LIKE THIS:
(all slack at top)



OR LIKE THIS:
(all slack at bottom)

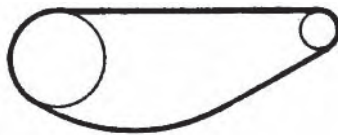

DO NOT APPLY THIS WAY:
(with slack at top and bottom)

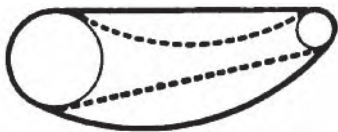

Do not apply with the slack of some belts on the bottom (see solid line) and the slack of others on the top (see dotted line). Since V-belts will not slide in the groove, belts thus applied will be injured when tightened for operation.

Now tension the drive until only a slight bow appears on the slack side of the belts when they are operating.

6. In a day or so, when the belts have had time to seat in the grooves, re-tension the belts.

All V-belt drives should be guarded in such a manner as to comply with the Williams-Steiger Occupational Safety and Health Act and with all state and local laws and the American National Standard Institute (ANSI) safety code.

Tensioning The Drive

General Rules of Tensioning:

1. Ideal tension is the lowest tension at which the belt will not slip under peak load conditions.
2. Check tension frequently during the first 24-48 hours of run-in operation.
3. Overtensioning shortens belt and bearing life.
4. Keep belts free from foreign material which may cause slip.
5. Make V-drive inspection on a periodic basis. Tension when slipping.

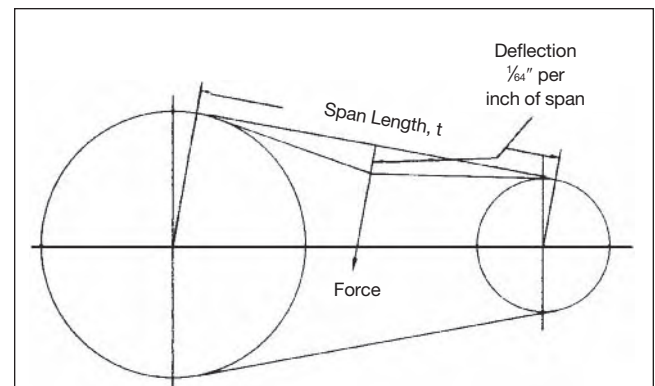

Test The Tension

If you want to check the tension in a conventional V-belt drive, use the procedure below:

1. Measure the span length, t .
2. At the center of the span (t) apply a force (perpendicular to the span) large enough to deflect the belt $\frac{1}{64}$ " for every inch of span length. For example, the deflection of a 100 inch span would be $\frac{100}{64}$ or $1\frac{1}{16}$ inches.
3. Compare the force you have applied with the values given in Table 12. If the force is between the values for normal tension, and $1\frac{1}{2}$ times normal tension, the drive tension should be satisfactory. A force below the value for normal tension indicates an under-tensioned drive. If the force exceeds the value for $1\frac{1}{2}$ times normal tension, the drive is tighter than it needs to be. A new drive can be tightened initially to two times normal tension to allow for the normal drop in tension during run in.

Installation and Take-up Allowances

After calculating a center distance from a standard pitch length, make provision for adjusting the center distance as in Table 13, to allow for installation of the belts without injury, for tensioning, and for maintenance of proper tension throughout the life of the belt.

Table 12 — Belt Deflection Force

V-Belt Cross Section	Smallest Sheave Diameter Range	RPM Range	Belt Deflection Force			
			A, B, C, D		AX, BX, CX	
			Normal	1½ × Normal	Normal	1½ × Normal
A	3.0-3.6	1000-2500 2501-4000	3.7 2.8	5.5 4.2	4.1 3.4	6.1 5.0
	3.8-4.8	1000-2500 2501-4000	4.5 3.8	6.8 5.7	5.0 4.3	7.4 6.4
	5.0-7.0	1000-2500 2501-4000	5.4 4.7	8.0 7.0	5.7 5.1	9.4 7.6
B	3.4-4.2	860-2500 2501-4000			4.9 4.2	7.2 6.2
	4.4-5.6	860-2500 2501-4000	5.3 4.5	7.9 6.7	7.1 7.1	10.5 9.1
	5.8-8.6	860-2500 2501-4000	6.3 6.0	9.4 8.9	8.5 7.3	12.6 10.9
C	7.0-9.0	500-1740 1741-3000	11.5 9.4	17.0 13.8	14.7 11.9	21.8 17.5
	9.5-16.0	500-1740 1741-3000	14.1 12.5	21.0 18.5	15.9 14.6	23.5 21.6
D	12.0-16.0	200-850 851-1500	24.9 21.2	37.0 31.3		
	18.0-20.0	200-850 851-1500	30.4 25.6	45.2 38.0		

V-Belt Cross Section	Smallest Sheave Diameter Range	RPM Range	Belt Deflection Force			
			3V, 5V, 8V		3VX, 5VX	
			Normal	1½ × Normal	Normal	1½ × Normal
3V	2.2-2.4	1000-2500 2501-4000			3.3 2.9	4.9 4.3
	2.65-3.65	1000-2500 2501-4000	3.6 3.0	5.1 4.4	4.2 3.8	6.2 5.6
	4.12-6.90	1000-2500 2501-4000	4.9 4.4	7.3 6.6	5.3 4.9	7.9 7.3
5V	4.4-6.7	500-1749 1750-3000 3001-4000			10.2 8.8 5.6	15.2 13.2 8.5
	7.1-10.9	500-1740 1741-3000	12.7 11.2	18.9 16.7	14.8 13.7	22.1 20.1
	11.8-16.0	500-1740 1741-3000	15.5 14.6	23.4 21.8	17.1 16.8	25.5 25.0
8V	12.5-17.0	200-850 851-1500	33.0 26.8	49.3 39.9		
	18.0-22.4	200-850 851-1500	39.6 35.3	59.2 52.7		

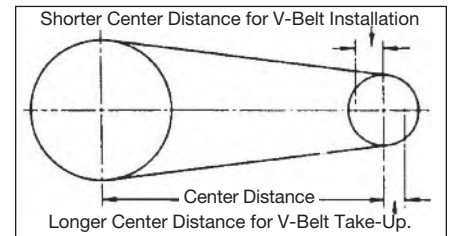

Table 13 — Center distance allowance for installation and take-up

Standard Length Designation	Minimum Allowance Below Standard Center Distance for Installation of Belts (Inches)								Minimum Allowance Above Standard Center Distance for Maintaining Tension (Inches) All Sections
	A, AX	A, AX Joined	B, BX	B, BX Joined	C, CX	C, CX Joined	D	D Joined	
26 to 37	0.75	1.20	1.00	1.50					1.00
38 to 59	0.75	1.20	1.00	1.50	1.50	2.00			1.50
60 to 89	0.75	1.30	1.25	1.60	1.50	2.00			2.00
90 to 119	1.00	1.30	1.25	1.60	1.50	2.00			2.50
120 to 157	1.00	1.50	1.25	1.80	1.50	2.10	2.00	2.90	3.00
158 to 194			1.25	1.80	2.00	2.20	2.00	3.00	3.50
195 to 239			1.50	1.90	2.00	2.30	2.00	3.20	4.00
240 to 269			1.50	2.00	2.00	2.50	2.50	3.20	4.50
270 to 329			1.50	2.20	2.00	2.50	2.50	3.50	5.00
330 to 419					2.00	2.70	2.50	3.60	6.00
420 and over					2.50	2.90	3.00	4.10	1.5% of belt length

Standard Length Designation	Minimum Allowance Below Standard Center Distance for Installation of Belts (Inches)						Minimum Allowance Above Standard Center Distance for Maintaining Tension (Inches) All Cross Sections
	3V, 3VX	3V, 3VX Joined	5V, 5VX	5V, 5VX Joined	8V	8V Joined	
Up to and incl. 475	0.5	1.2					1.0
Over 475 to and incl. 710	0.8	1.4	1.0	2.1			1.2
Over 710 to and incl. 1060	0.8	1.4	1.0	2.1	1.5	3.4	1.5
Over 1060 to and incl. 1250	0.8	1.4	1.0	2.1	1.5	3.4	1.8
Over 1250 to and incl. 1700	0.8	1.4	1.0	2.1	1.5	3.4	2.2
Over 1700 to and incl. 2000			1.0	2.1	1.8	3.6	2.5
Over 2000 to and incl. 2360			1.2	2.4	1.8	3.6	3.0
Over 2360 to and incl. 2650			1.2	2.4	1.8	3.6	3.2
Over 2650 to and incl. 3000			1.2	2.4	1.8	3.6	3.5
Over 3000 to and incl. 3550					2.0	4.0	4.0
Over 3550 to and incl. 3750			1.2	2.4	2.0	4.0	4.5
Over 3750 to and incl. 5000					2.0	4.0	5.5

V-BELT DRIVES



To Determine the Need for Dynamic Balance

STATIC BALANCING – Both stock and Made-to-Order sheaves and pulleys are given a careful static balance for normal speeds. they will operate safely at belt speeds up to 6,500 feet per minute, but at speeds over 5,000 feet per minute and at any speed where vibration is a problem, dynamic balancing is recommended

This chart shows the maximum speed limit (in rpm) for a standard statically balanced sheave by a given diameter and face width. To exceed this speed limit it is recommended the sheave be dynamically balanced. This information can also be used for pulleys.

V-BELT DRIVES

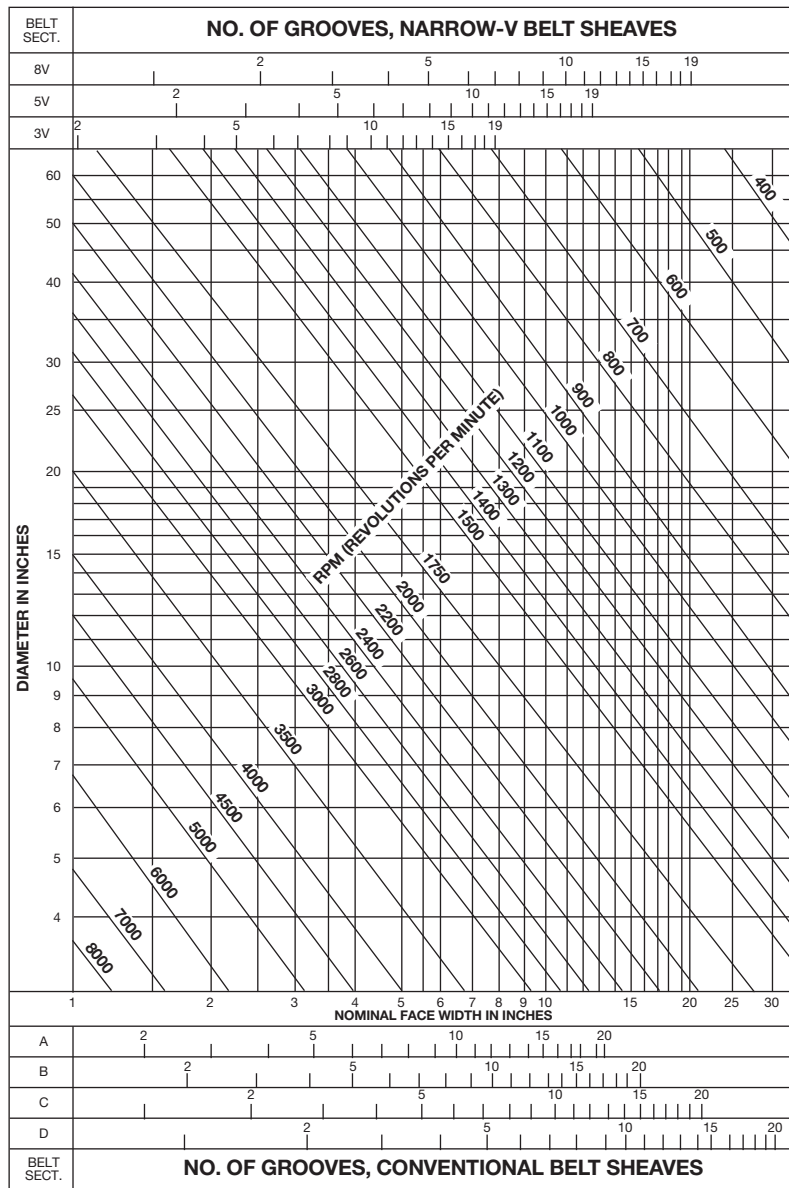

EXAMPLE: A 10" diameter 2" wide sheave or pulley is recommended to be dynamically balanced (balanced in two planes) at 3450 rpm and above. Below 3450 rpm a static balance (balanced in one plane) is sufficient.

WARNING: When belt speeds exceed 6500 feet per minute special materials must be used; consult *Martin* for special design requirements.

Made-To-Order Sheaves

Martin has the capacity to produce a wide range of Made-To-Order Sheaves. These sheaves meet the same quality standards as our stock line of QD and Taper Bushed Sheaves.

Since Made-To-Order Sheaves can be manufactured to meet most customer requirements, the following pages give standard dimensions for Made-To-Order Sheaves. *Martin* can alter these dimensions such as hub location, length through bore, to meet desired requirements. These sheaves are normally Bored-To-Size and are furnished with standard keyway and two set screws as indicated. However, most Made-To-Order Sheaves can be furnished in QD or Taper Bushed style hubs. Also, *Martin* can furnish Made-To-Order Sheaves in a split construction. Consult factory with specific requirements.



Made-To-Order Sheaves

V-BELT DRIVES

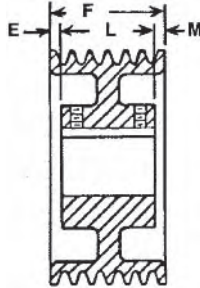

TYPE A

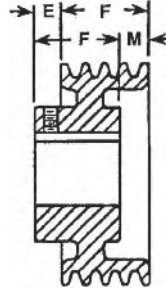

TYPE D

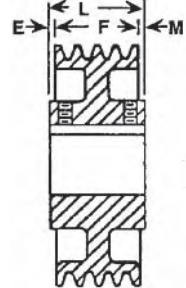

TYPE C

O.D. ■ Range	1 — Groove, F = ◆				2 — Groove, F = ○				3 — Groove, F = 1½			
	Type	L	E	M	Type	L	E	M	Type	L	E	M
2.65-4.9	D	1⅙	⅝	—	D	1⅝	⅝	¾	D	1⅝	⅝	½
5.0-10.9	D	1½	⅝	⅙	C	1¾	⅝	⅙	D	1¾	⅝	⅝
11.0-13.9	C	1¾	⅝	⅙	C	2¼	⅝	⅙	C	2¼	⅝	⅝
14.0-16.9	C	1¾	⅝	⅙	C	2¼	⅝	⅙	C	2½	⅝	⅝
17.0-24.9	C	1¾	⅝	⅙	C	2½	⅝	⅝	C	3	¾	⅝
25.0-33.5	C	1¾	¼	¼	C	2½	⅝	⅝	C	3¼	¾	⅝

O.D. ■ Range	4 — Groove, F = 1⅞				5 — Groove, F = 2⅝				6 — Groove, F = 2⅞			
	Type	L	E	M	Type	L	E	M	Type	L	E	M
2.65-4.9	D	1⅝	⅝	⅞	D	2¼	⅝	⅞	D	2¼	⅝	1⅞
5.0-6.9	D	1¾	⅝	⅞	D	2¼	⅝	⅞	D	2¼	⅝	1⅞
7.0-10.9	D	2¼	⅝	⅞	D	2¼	⅝	⅞	D	2½	⅝	⅞
11.0-20.9	D	2½	⅝	⅞	C	3	⅝	⅞	D	3	⅝	⅞
21.0-29.9	C	3	⅝	⅞	C	3¼	⅝	⅞	C	3½	⅝	⅞
30.0-33.5	C	3½	⅝	⅞	C	3½	⅝	⅞	C	4	⅝	⅞

O.D. ■ Range	8 — Groove, F = 3⅞				10 — Groove, F = 4⅞				12 — Groove, F = 5⅞			
	Type	L	E	M	Type	L	E	M	Type	L	E	M
4.0-4.9	D	2¼	⅝	1⅞	D	2½	⅝	2⅞	D	3½	⅝	2⅞
5.0-6.9	D	2½	⅝	1⅞	D	2½	⅝	2⅞	D	3½	⅝	2⅞
7.0-13.9	D	3	⅝	1⅞	D	3¼	⅝	2⅞	D	3½	⅝	2⅞
14.0-16.9	D	3½	⅝	2⅞	D	3½	⅝	2⅞	D	3½	⅝	2⅞
17.0-20.9	C	4	⅝	⅞	D	4	⅝	3⅞	D	4	⅝	1⅞
21.0-33.5	C	4½	⅝	⅞	C	4½	⅝	⅞	A	4½	⅝	2⅞

O.D. ■ Range	14 — Groove, F = 5⅞				16 — Groove, F = 6⅞				18 — Groove, F = 7⅞			
	Type	L	E	M	Type	L	E	M	Type	L	E	M
4.0-8.9	D	3	⅝	3⅞	D	4	⅝	3⅞	D	4	⅝	4⅞
9.0-16.9	D	3	⅝	3⅞	D	4	⅝	3⅞	D	4	⅝	4⅞
17.0-20.9	D	4	⅝	2⅞	D	4½	⅝	2⅞	D	4½	⅝	2⅞
21.0-24.9	A	4	⅝	⅞	A	4½	⅝	⅞	A	4½	⅝	⅞
25.0-29.9	A	4	⅝	⅞	A	4½	⅝	⅞	A	4½	⅝	⅞
30.0-33.5	A	5	⅝	⅞	A	5	⅝	⅞	A	5	⅝	⅞

■ P.D. = O.D. - .05"
 ◆ 1/16" for 2.65-10.9 O.D., 1/16" for 11.0-16.9 O.D., 1" for 17.0-24.9 O.D., 1 1/4" for 25.0-33.5 O.D.
 ○ 1/32" for 2.65-16.9 O.D., 1/4" for 17.0-33.5 O.D.

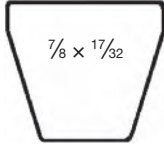

MTO — 5V

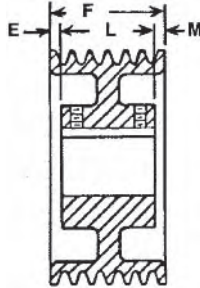

TYPE A

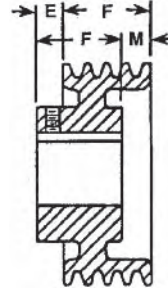

TYPE D

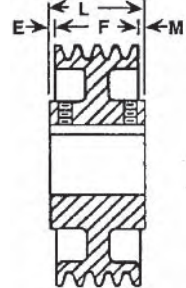

TYPE C

O.D. ■ Range	2 — Groove, F = 1 ¹ / ₁₆				3 — Groove, F = 2%				4 — Groove, F = 3 ¹ / ₁₆			
	Type	L	E	M	Type	L	E	M	Type	L	E	M
7.0-10.9	D	2 ¹ / ₄	⁷ / ₁₆	⁵ / ₁₆	D	2 ¹ / ₂	⁷ / ₁₆	³ / ₁₆	D	3	⁷ / ₁₆	¹ / ₁₆
11.0-23.9	D	2 ¹ / ₄	⁷ / ₁₆	⁵ / ₁₆	D	3 ¹ / ₄	⁷ / ₁₆	—	D	3 ¹ / ₂	⁷ / ₁₆	⁷ / ₁₆
24.0-29.9	C	2 ¹ / ₂	¹³ / ₃₂	¹³ / ₃₂	C	3 ¹ / ₂	⁹ / ₁₆	⁹ / ₁₆	C	4	¹⁵ / ₃₂	¹⁵ / ₃₂
30.0-44.9	C	3 ¹ / ₂	²⁹ / ₃₂	²⁹ / ₃₂	C	4 ¹ / ₂	1 ¹ / ₁₆	1 ¹ / ₁₆	C	5 ¹ / ₄	1 ³ / ₃₂	1 ³ / ₃₂
45.0-75.0	C	5	1 ² / ₃₂	1 ² / ₃₂	C	5 ¹ / ₄	1 ¹ / ₁₆	1 ¹ / ₁₆	C	6	1 ¹ / ₃₂	1 ¹ / ₃₂

O.D. ■ Range	5 — Groove, F = 3 ³ / ₄				6 — Groove, F = 4 ⁷ / ₁₆				8 — Groove, F = 5 ¹⁵ / ₁₆			
	Type	L	E	M	Type	L	E	M	Type	L	E	M
7.0-11.9	D	3 ³ / ₄	⁷ / ₁₆	1 ³ / ₁₆	D	3 ¹ / ₂	⁷ / ₁₆	1 ¹³ / ₁₆	D	4	⁷ / ₁₆	2 ¹ / ₁₆
12.0-23.9	D	4	⁷ / ₁₆	⁵ / ₁₆	D	4	⁷ / ₁₆	1 ¹ / ₁₆	D	4 ¹ / ₂	⁷ / ₁₆	2 ² / ₁₆
24.0-44.9	C	4 ¹ / ₂	³ / ₈	³ / ₈	C	5 ¹ / ₄	¹³ / ₃₂	¹³ / ₃₂	A	5 ¹ / ₂	⁵ / ₃₂	⁵ / ₃₂
45.0-52.9	C	5 ¹ / ₄	³ / ₄	³ / ₄	C	6	²⁵ / ₃₂	²⁵ / ₃₂	C	6	⁹ / ₃₂	⁹ / ₃₂
53.0-75.9	C	6 ¹ / ₄	1%	1%	C	6 ¹ / ₂	1 ¹ / ₃₂	1 ¹ / ₃₂	C	6 ¹ / ₂	¹¹ / ₃₂	¹¹ / ₃₂

O.D. ■ Range	10 — Groove, F = 7 ⁷ / ₁₆				12 — Groove, F = 8 ⁸ / ₁₆				14 — Groove, F = 9 ¹⁵ / ₁₆			
	Type	L	E	M	Type	L	E	M	Type	L	E	M
9.0-23.9	D	4 ¹ / ₄	⁷ / ₁₆	3 ¹³ / ₃₂	D	5	⁷ / ₁₆	4 ¹³ / ₁₆	D	6	⁷ / ₁₆	4 ¹³ / ₁₆
24.0-36.9	A	4 ¹ / ₂	1 ¹ / ₃₂	1 ¹ / ₃₂	A	5 ¹ / ₂	1 ¹ / ₃₂	1 ¹ / ₃₂	A	6 ¹ / ₂	1 ²³ / ₃₂	1 ²³ / ₃₂
37.0-44.9	A	5 ¹ / ₂	²⁷ / ₃₂	²⁷ / ₃₂	A	6	1 ¹ / ₃₂	1 ¹ / ₃₂	A	7	1 ¹ / ₃₂	1 ¹ / ₃₂
45.0-52.9	A	6	¹⁹ / ₃₂	¹⁹ / ₃₂	A	6	1 ¹ / ₃₂	1 ¹ / ₃₂	A	7 ¹ / ₂	1 ¹ / ₃₂	1 ¹ / ₃₂
53.0-75.9	A	7	³ / ₃₂	³ / ₃₂	A	7	²⁵ / ₃₂	²⁵ / ₃₂	A	8	³¹ / ₃₂	³¹ / ₃₂

O.D. ■ Range	16 — Groove, F = 11 ¹ / ₁₆				18 — Groove, F = 12 ¹¹ / ₁₆				20 — Groove, F = 14 ¹ / ₁₆			
	Type	L	E	M	Type	L	E	M	Type	L	E	M
9.0-23.9	D	6 ¹ / ₂	⁷ / ₁₆	5 ¹³ / ₁₆	D	7	⁷ / ₁₆	6 ¹³ / ₁₆	D	8	⁷ / ₁₆	6 ¹³ / ₁₆
24.0-36.9	A	7	2 ²³ / ₃₂	1 ¹¹ / ₃₂	A	8	2 ¹ / ₃₂	2 ¹ / ₃₂	A	8 ¹ / ₂	2 ²³ / ₃₂	2 ²³ / ₃₂
37.0-44.9	A	7 ¹ / ₂	1 ² / ₃₂	1 ² / ₃₂	A	8 ¹ / ₂	2 ² / ₃₂	2 ² / ₃₂	A	9	2 ¹ / ₃₂	2 ¹ / ₃₂
45.0-52.9	A	8	1 ² / ₃₂	1 ² / ₃₂	A	9	1 ² / ₃₂	1 ² / ₃₂	A	9 ¹ / ₂	2 ² / ₃₂	2 ² / ₃₂
53.0-62.9	A	8 ¹ / ₂	1 ¹ / ₃₂	1 ¹ / ₃₂	A	9 ¹ / ₂	1 ¹ / ₃₂	1 ¹ / ₃₂	A	10	2 ¹ / ₃₂	2 ¹ / ₃₂
63.0-75.0	A	9	1 ¹ / ₃₂	1 ¹ / ₃₂	A	10 ¹ / ₂	1 ¹ / ₃₂	1 ¹ / ₃₂	A	12	1 ¹ / ₃₂	1 ¹ / ₃₂

■ P.D. = O.D. - .10"

Made-To-Order Sheaves

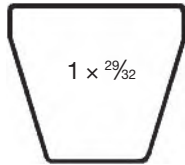

MTO — 8V

V-BELT DRIVES

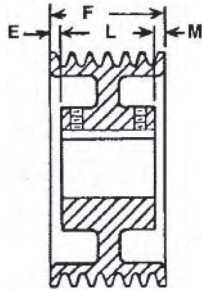

TYPE A

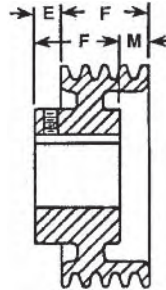

TYPE D

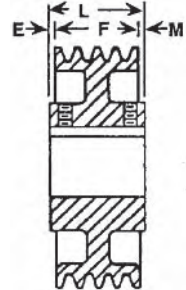

TYPE C

O.D. ■ Range	4 — Groove, F = 4%				5 — Groove, F = 6				7 — Groove, F = 7%			
	Type	L	E	M	Type	L	E	M	Type	L	E	M
13.0-26.9	D	5	1 1/8	1	D	5 1/2	1 1/8	1 1/8	D	6	1 1/8	2 1/4
27.0-39.9	D	5 1/2	3/16	3/16	C	6	0	0	A	7	3/16	3/16
40.0-57.9	C	6	3/16	3/16	C	7	1/2	1/2	C	7 1/2	3/16	3/16
58.0-69.9	C	7	1 1/16	1 1/16	C	8	0	0	C	8	3/16	3/16
70.0-81.9	C	8	1 1/16	1 1/16	C	8 1/4	1 1/4	1 1/4	C	9	15/16	15/16
82.0-85.0	C	8 1/2	1 1/16	1 1/16	C	9	1 1/2	1 1/2	C	10	1 1/16	1 1/16

O.D. ■ Range	8 — Groove, F = 9%				10 — Groove, F = 11 1/2%				12 — Groove, F = 13 3/8%			
	Type	L	E	M	Type	L	E	M	Type	L	E	M
13.0-29.9	D	6 1/2	1 1/8	4	D	7	1 1/8	5 1/4	D	8	1 1/8	7
30.0-39.9	A	7 1/2	1 1/16	1 1/16	A	8	1 13/16	1 13/16	A	8 1/2	2 11/16	2 11/16
40.0-57.9	A	8	1 1/16	1 1/16	A	9	1 1/16	1 1/16	A	9 1/2	2 3/16	2 3/16
58.0-69.9	A	9	3/16	3/16	A	9 1/2	1 1/16	1 1/16	A	10	1 13/16	1 13/16
70.0-81.9	C	9 1/2	1/16	1/16	A	10	1 3/16	1 3/16	A	11	1 1/16	1 1/16
82.0-85.0	C	10	3/16	3/16	A	11	3/16	3/16	A	12	1 1/16	1 1/16

O.D. ■ Range	14 — Groove, F = 16%				16 — Groove, F = 18%				18 — Groove, F = 20%			
	Type	L	E	M	Type	L	E	M	Type	L	E	M
13.0-29.9	D	9 1/4	1 1/8	7 3/4	D	10 1/2	1 1/8	9	D	16 1/2	1 1/8	5 1/4
30.0-39.9	A	9	3 3/16	3 3/16	A	10	4 3/16	4 3/16	A	12	4 3/16	4 3/16
40.0-57.9	A	10	3 3/16	3 3/16	A	10 1/2	3 3/16	3 3/16	A	12 1/2	4 3/16	4 3/16
58.0-69.9	A	11	2 3/16	2 3/16	A	11	3 1/16	3 1/16	A	13	3 3/16	3 3/16
70.0-81.9	A	12	2 3/16	2 3/16	A	12	3 3/16	3 3/16	A	14	3 3/16	3 3/16
82.0-85.0	A	13	1 3/16	1 3/16	A	13	2 11/16	2 11/16	A	15	2 3/16	2 3/16

O.D. ■ Range	20 — Groove, F = 22 3/8%				22 — Groove, F = 25 1/2%				24 — Groove, F = 27 3/8%			
	Type	L	E	M	Type	L	E	M	Type	L	E	M
13.0-29.9	D	18	1 1/8	6	D	19	1 1/8	7 1/4	D	22	1 1/8	6 1/2
30.0-39.9	A	13 1/2	4 11/16	4 11/16	A	20 1/2	2 13/16	2 13/16	A	22	2 11/16	2 11/16
40.0-57.9	A	14	4 3/16	4 3/16	A	15	5 3/16	5 3/16	A	23	2 3/16	2 3/16
58.0-69.9	A	14 1/2	4 3/16	4 3/16	A	16	4 3/16	4 3/16	A	17	5 3/16	5 3/16
70.0-81.9	A	15	3 3/16	3 3/16	A	16 1/2	4 3/16	4 3/16	A	17 1/2	4 3/16	4 3/16
82.0-85.0	A	16	3 3/16	3 3/16	A	17	4 3/16	4 3/16	A	18	4 3/16	4 3/16

■ P.D. = O.D. - .20"

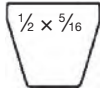

MTO — A

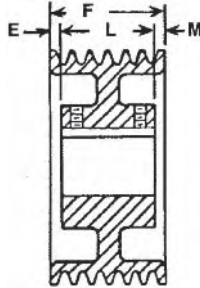

TYPE A

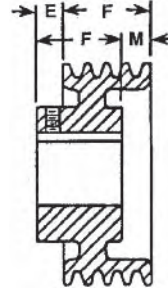

TYPE D

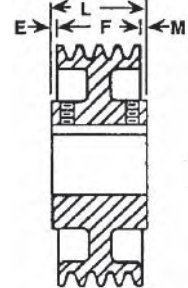

TYPE C

O.D. ■ Range	1 — Groove, F = ◆				2 — Groove, F = 1%				3 — Groove, F = 2			
	Type	L	E	M	Type	L	E	M	Type	L	E	M
3.0-6.9	D	1%	5/8	—	D	1%	5/8	5/8	D	1 1/2	5/8	1 1/4
7.0-11.9	D	1%	5/8	1/4	D	2	5/8	—	D	2	5/8	5/8
12.0-20.9	C	2	5/8	3/8	D	2	5/8	—	D	2	5/8	5/8
21.0-25.0	C	2	1/2	1/2	C	2	5/8	5/8	C	2 1/2	1/4	1/4

O.D. ■ Range	4 — Groove, F = 2 1/2%				5 — Groove, F = 3 1/4%				6 — Groove, F = 3 3/8%			
	Type	L	E	M	Type	L	E	M	Type	L	E	M
3.0-6.9	D	2	5/8	1 1/4	D	2 1/2	5/8	1%	D	2 3/4	5/8	1 1/4
7.0-14.9	A	2	5/8	1 1/4	D	2 1/2	5/8	1%	D	2 3/4	5/8	1 1/4
15.0-20.9	A	2 1/2	5/8	3/4	D	3	5/8	7/8	D	3 1/2	5/8	1
21.0-25.0	A	2 1/2	1/2	1/2	A	3	1/2	1/2	A	3 1/2	5/8	3/8

O.D. ■ Range	7 — Groove, F = 4 1/2%				8 — Groove, F = 5%				10 — Groove, F = 6 1/2%			
	Type	L	E	M	Type	L	E	M	Type	L	E	M
3.0-6.9	D	3	5/8	2 1/2	D	3 1/2	5/8	2 1/4	D	3 3/2	5/8	3 1/2
7.0-14.9	D	3	5/8	2 1/2	D	3 1/2	5/8	2 1/4	D	3 3/2	5/8	3 1/2
15.0-20.9	D	3 1/2	5/8	1 1/2	D	4	5/8	1 1/4	D	4	5/8	3
21.0-25.0	A	3 1/2	1/2	1/2	A	4	5/8	1 1/4	A	4	1 1/8	1 1/8

■ P.D. = O.D. + .25"

◆ 3/4" for 3.0-6.9 P.D., 7/8" for 7.0-11.9 P.D., 1" for 12.0-25.0 P.D.

Made-To-Order Sheaves



V-BELT DRIVES

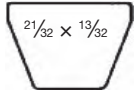

MTO — B

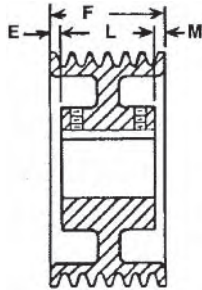

TYPE A

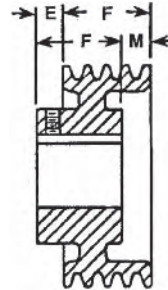

TYPE D

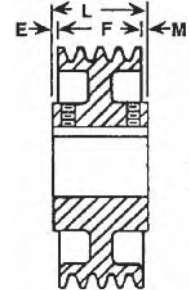

TYPE C

O.D. ■ Range	2 — Groove, F = 1%				3 — Groove, F = 2%				4 — Groove, F = 3%			
	Type	L	E	M	Type	L	E	M	Type	L	E	M
5.0-6.9	D	2 1/4	7/8	3/8	D	2 1/2	7/8	7/8	D	3	7/8	1 1/8
7.0-20.9	D	2 1/4	7/8	3/8	D	2 1/2	7/8	7/8	D	3	7/8	1 1/8
21.0-39.0	C	3	3/4	3/8	C	3	3/4	3/4	C	3 1/2	1 1/8	1 1/8

O.D. ■ Range	5 — Groove, F = 4				6 — Groove, F = 4%				7 — Groove, F = 5 1/2			
	Type	L	E	M	Type	L	E	M	Type	L	E	M
5.0-8.9	D	3	7/8	1 1/8	D	3	7/8	2%	D	3	7/8	3%
9.0-20.9	D	3	7/8	1 1/8	D	3 1/2	7/8	2 1/2%	D	3 1/2	7/8	2%
21.0-29.9	A	3 1/2	1/2	1/2	A	3 1/2	3/4	5/8%	A	4	3/4	3/4
30.0-38.0	A	4	—	—	A	4	3/8	3/8%	A	4 1/2	1/2	1/2

O.D. ■ Range	8 — Groove, F = 6%				9 — Groove, F = 7				10 — Groove, F = 7%			
	Type	L	E	M	Type	L	E	M	Type	L	E	M
5.0-8.9	D	3 1/2	7/8	3%	D	3 1/2	7/8	4%	D	4	7/8	4%
9.0-20.9	D	4	7/8	3%	D	4	7/8	3%	D	4 1/2	7/8	4%
21.0-24.9	A	4 1/2	7/8	7/8	A	5	1	1	A	5 1/2	1 1/8	1 1/8
25.0-38.0	A	5	3/4	3/4	A	5 1/2	3/4	3/4	A	6	7/8	7/8

O.D. ■ Range	12 — Groove, F = 9%				13 — Groove, F = 10				14 — Groove, F = 10 3/4			
	Type	L	E	M	Type	L	E	M	Type	L	E	M
5.0-8.9	D	5 1/2	7/8	4%	D	6	7/8	4%	D	6 1/2	7/8	5%
9.0-20.9	D	5 1/2	7/8	4%	D	6	7/8	4%	D	6 1/2	7/8	5%
21.0-24.9	A	5 1/2	1 1/8	1 1/8	A	6	2	2	A	6 1/2	2%	2%
25.0-29.9	A	6	1 1/8	1 1/8	A	6 1/2	1 1/8	1 1/8	A	7	1 1/8	1 1/8
30.0-38.0	A	6 1/2	1 1/8	1 1/8	A	7	1 1/2	1 1/2	A	7 1/2	1 1/8	1 1/8

■ P.D. = O.D. + .35"

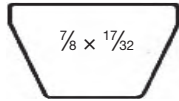

MTO — C

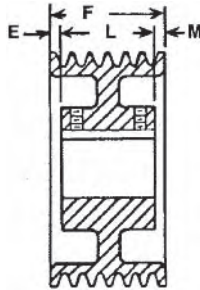

TYPE A

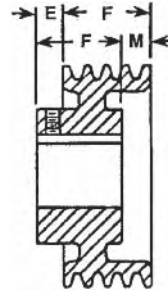

TYPE D

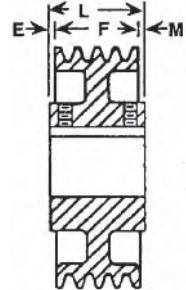

TYPE C

O.D. ■ Range	3 — Groove, F = 3%				4 — Groove, F = 4%				5 — Groove, F = 5%			
	Type	L	E	M	Type	L	E	M	Type	L	E	M
9.0-15.9	D	2½	⅞	1¾	D	3	⅞	2¼	D	3½	⅞	2¾
16.0-23.9	D	3	⅞	1¾	D	3½	⅞	1¾	D	4	⅞	2¼
24.0-35.9	A	3½	⅞	⅞	A	3½	⅞	⅞	A	4	⅞	⅞
36.0-43.9	A	4	⅞	⅞	C	4½	⅞	⅞	A	5	⅞	⅞
44.0-55.0	A	4½	⅞	⅞	C	5	⅞	⅞	C	5½	⅞	⅞
56.0-64.0	A	5	⅞	⅞	C	5½	⅞	⅞	C	6	⅞	⅞

O.D. ■ Range	6 — Groove, F = 6%				7 — Groove, F = 7%				8 — Groove, F = 8%			
	Type	L	E	M	Type	L	E	M	Type	L	E	M
9.0-15.9	D	3½	⅞	3¼	D	4	⅞	4¼	D	5	⅞	5¼
16.0-23.9	D	4	⅞	3¼	D	4½	⅞	3¾	D	5½	⅞	4¾
24.0-35.9	A	4½	⅞	⅞	A	5	⅞	⅞	A	5½	⅞	⅞
36.0-43.9	A	5	⅞	⅞	A	5½	⅞	⅞	A	6½	⅞	⅞
44.0-55.0	A	5½	⅞	⅞	A	6	⅞	⅞	A	7	⅞	⅞
56.0-64.0	A	6	⅞	⅞	A	6½	⅞	⅞	A	7½	⅞	⅞

O.D. ■ Range	9 — Groove, F = 9%				10 — Groove, F = 10%				11 — Groove, F = 11%			
	Type	L	E	M	Type	L	E	M	Type	L	E	M
9.0-15.9	D	5	⅞	5¼	D	6	⅞	5¼	D	7	⅞	5¼
16.0-23.9	D	5½	⅞	4¾	D	6½	⅞	4¾	D	7½	⅞	4¾
24.0-35.9	A	6	1⅞	1⅞	A	7	1⅞	1⅞	A	8	1⅞	1⅞
36.0-43.9	A	6½	1⅞	1⅞	A	7½	1⅞	1⅞	A	8½	1⅞	1⅞
44.0-55.0	A	7	1⅞	1⅞	A	8	1⅞	1⅞	A	9	1⅞	1⅞
56.0-64.0	A	7½	1⅞	1⅞	A	8½	1⅞	1⅞	A	9½	1⅞	1⅞

O.D. ■ Range	12 — Groove, F = 12%				13 — Groove, F = 13%				14 — Groove, F = 14%			
	Type	L	E	M	Type	L	E	M	Type	L	E	M
9.0-15.9	D	7	⅞	6¾	D	8	⅞	6¾	D	8	⅞	7¼
16.0-23.9	D	7½	⅞	5¾	D	8	⅞	6¾	D	8	⅞	7¼
24.0-35.9	A	8	2⅞	2⅞	A	8½	2⅞	2⅞	A	8½	2⅞	2⅞
36.0-43.9	A	8½	1⅞	1⅞	A	9	2⅞	2⅞	A	9	2⅞	2⅞
44.0-55.0	A	9	1⅞	1⅞	A	9½	1⅞	1⅞	A	9½	2⅞	2⅞
56.0-64.0	A	9½	1⅞	1⅞	A	10	1⅞	1⅞	A	10	2⅞	2⅞

■ P.D. = O.D. + .40"

Made-To-Order Sheaves



V-BELT DRIVES

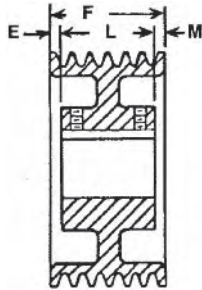
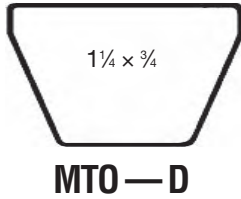

TYPE A

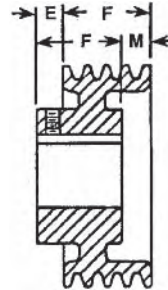

TYPE D

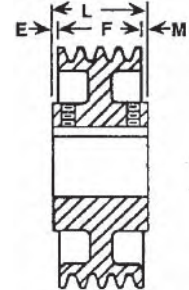

TYPE C

O.D. ■ Range	3 — Groove, F = 4%				4 — Groove, F = 6 ¹ / ₁₆				5 — Groove, F = 7 ¹ / ₂			
	Type	L	E	M	Type	L	E	M	Type	L	E	M
13.0-26.9	D	4	1	1 ⁵ / ₁₆	D	4	1	3 ¹ / ₁₆	D	4 ¹ / ₂	1	4
27.0-39.9	A	4	⁵ / ₁₆	⁵ / ₁₆	A	4 ¹ / ₂	²⁵ / ₃₂	²⁵ / ₃₂	D	5 ¹ / ₂	1	1
40.0-57.9	C	5	³ / ₁₆	³ / ₁₆	A	5 ¹ / ₂	⁷ / ₃₂	⁷ / ₃₂	A	6 ¹ / ₂	¹ / ₂	¹ / ₂
58.0-69.9	C	5 ¹ / ₂	⁷ / ₁₆	⁷ / ₁₆	A	6	¹ / ₃₂	¹ / ₃₂	A	7	¹ / ₄	¹ / ₄
70.0-81.9	C	6	¹ / ₁₆	¹ / ₁₆	C	6 ¹ / ₂	⁷ / ₃₂	⁷ / ₃₂	A	7 ¹ / ₂	—	—
82.0-85.0	C	6 ¹ / ₂	¹⁵ / ₁₆	¹⁵ / ₁₆	C	7	¹⁵ / ₃₂	¹⁵ / ₃₂	C	8	¹ / ₄	¹ / ₄

O.D. ■ Range	6 — Groove, F = 8 ¹⁵ / ₁₆				7 — Groove, F = 10%				8 — Groove, F = 11 ¹³ / ₁₆			
	Type	L	E	M	Type	L	E	M	Type	L	E	M
13.0-26.9	D	5	1	4 ¹⁵ / ₁₆	D	5 ¹ / ₂	1	5 ⁵ / ₁₆	D	6	1	6 ¹⁵ / ₁₆
27.0-39.9	A	6	1 ¹⁵ / ₃₂	1 ¹⁵ / ₃₂	A	7	1 ¹ / ₁₆	1 ¹ / ₁₆	A	7 ¹ / ₂	2 ²⁵ / ₃₂	2 ²⁵ / ₃₂
40.0-57.9	C	7	³ / ₃₂	³ / ₃₂	A	8	1 ¹ / ₁₆	1 ¹ / ₁₆	A	8 ¹ / ₂	1 ² / ₃₂	1 ⁴ / ₃₂
58.0-69.9	C	7 ¹ / ₂	²⁹ / ₃₂	²⁹ / ₃₂	A	8 ¹ / ₂	¹⁵ / ₁₆	¹⁵ / ₁₆	A	9	1 ¹ / ₃₂	1 ¹ / ₃₂
70.0-81.9	C	8	¹⁵ / ₃₂	¹⁵ / ₃₂	A	9	¹ / ₁₆	¹ / ₁₆	A	9 ¹ / ₂	1 ¹ / ₃₂	1 ¹ / ₃₂
82.0-85.0	C	8 ¹ / ₂	⁷ / ₃₂	⁷ / ₃₂	A	9 ¹ / ₂	⁷ / ₁₆	⁷ / ₁₆	A	10	²⁹ / ₃₂	²⁹ / ₃₂

O.D. ■ Range	9 — Groove, F = 13%				10 — Groove, F = 14 ¹ / ₁₆				11 — Groove, F = 16%			
	Type	L	E	M	Type	L	E	M	Type	L	E	M
13.0-17.9	D	7	1	7 ¹ / ₄	D	8	1	7 ¹ / ₁₆	D	13	1	4 ¹ / ₈
18.0-26.9	D	7	1	7 ¹ / ₄	D	8	1	7 ¹ / ₁₆	D	9	1	8 ¹ / ₈
27.0-39.9	A	8	2 ³ / ₃₂	2 ³ / ₃₂	A	9	2 ²⁷ / ₃₂	2 ²⁷ / ₃₂	A	9 ¹ / ₂	3 ³ / ₁₆	3 ³ / ₁₆
40.0-57.9	A	9	2 ¹ / ₂	2 ¹ / ₂	A	10	2 ¹ / ₃₂	2 ¹ / ₃₂	A	10 ¹ / ₂	2 ³ / ₁₆	2 ³ / ₁₆
58.0-69.9	A	10	1 ⁷ / ₈	1 ⁷ / ₈	A	10 ¹ / ₂	2 ²⁷ / ₃₂	2 ²⁷ / ₃₂	A	11 ¹ / ₂	2 ³ / ₁₆	2 ³ / ₁₆
70.0-85.0	A	10 ¹ / ₂	1 ³ / ₈	1 ³ / ₈	A	11 ¹ / ₂	1 ¹ / ₃₂	1 ¹ / ₃₂	A	12	2 ¹ / ₁₆	2 ¹ / ₁₆

O.D. ■ Range	12 — Groove, F = 17 ¹ / ₁₆				13 — Groove, F = 19				14 — Groove, F = 20 ¹ / ₁₆			
	Type	L	E	M	Type	L	E	M	Type	L	E	M
13.0-17.9	D	14	1	4 ¹ / ₁₆	D	15 ¹ / ₂	1	4 ¹ / ₂	D	16 ¹ / ₂	1	4 ¹⁵ / ₁₆
18.0-26.9	D	10	1	8 ¹ / ₁₆	A	10 ¹ / ₂	1	9 ¹ / ₂	D	16 ¹ / ₂	1	4 ¹⁵ / ₁₆
27.0-39.9	A	10 ¹ / ₂	3 ¹ / ₃₂	3 ¹ / ₃₂	A	11	4	4	A	12	4 ¹ / ₃₂	4 ¹ / ₃₂
40.0-57.9	A	11 ¹ / ₂	3 ³ / ₃₂	3 ³ / ₃₂	A	12 ¹ / ₂	3 ¹ / ₄	3 ¹ / ₄	A	13	3 ³ / ₃₂	3 ³ / ₃₂
58.0-69.9	A	12	2 ²⁹ / ₃₂	2 ²⁹ / ₃₂	A	13	3	3	A	13 ¹ / ₂	3 ¹ / ₃₂	3 ¹ / ₃₂
70.0-85.0	A	13	2 ³ / ₃₂	2 ³ / ₃₂	A	13 ¹ / ₂	2 ³ / ₄	2 ³ / ₄	A	14 ¹ / ₂	2 ³ / ₃₂	2 ³ / ₃₂

■ P.D. = O.D. + .60"

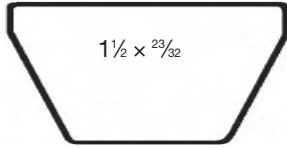

MTO—E

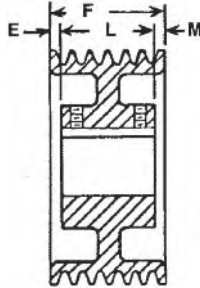

TYPE A

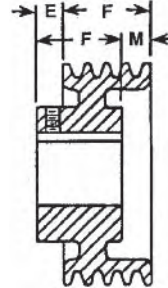

TYPE D

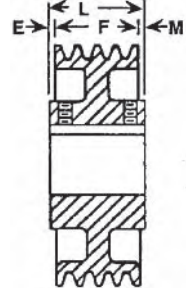

TYPE C

O.D. ■ Range	4 — Groove, F = 7 1/2				6 — Groove, F = 11				8 — Groove, F = 14 1/2			
	Type	L	E	M	Type	L	E	M	Type	L	E	M
21.0-26.9	D	5	1 1/2	3 3/4	D	7	1 1/2	5 1/2	D	9	1 1/2	6 3/4
27.0-45.9	A	6	3/4	3/4	A	7 1/2	1 1/4	1 1/4	A	9 1/2	2 1/4	2 1/4
46.0-57.9	A	6 1/2	1/2	1/2	A	8	1 1/2	1 1/2	A	10	2 1/4	2 1/4
58.0-73.9	A	7 1/2	0	0	A	8 1/2	1 1/2	1 1/2	A	10 1/2	2	2
74.0-83.9	A	7 1/2	0	0	A	9	1	1	A	11	1 1/4	1 1/4
84.0-85.0	C	8	1/4	1/4	A	9 1/2	3/4	3/4	A	11 1/2	1 1/2	1 1/2

O.D. ■ Range	10 — Groove, F = 18				12 — Groove, F = 21 1/2				14 — Groove, F = 25			
	Type	L	E	M	Type	L	E	M	Type	L	E	M
21.0-26.9	D	11	1 1/2	8 3/4	D	17	1 1/2	5 1/2	D	19	1 1/2	7 1/2
27.0-45.9	A	11	3 1/2	3 1/2	A	13	4 1/4	4 1/4	A	20 1/2	2 1/4	2 1/4
46.0-57.9	A	11 1/2	3 3/4	3 3/4	A	13 1/2	4	4	A	15	5	5
58.0-73.9	A	12	3	3	A	14	3 3/4	3 3/4	A	15 1/2	4 3/4	4 3/4
74.0-83.9	A	12 1/2	2 3/4	2 3/4	A	14 1/2	3 1/2	3 1/2	A	16 1/2	4 1/4	4 1/4
84.0-85.0	A	13	2 1/2	2 1/2	A	15	3 3/4	3 3/4	A	16 1/2	4 1/4	4 1/4

■ P.D. = O.D. + .80"

V-Belt Drive Selection

PRIME MOVER: _____
 Type & Description Rated (Nameplate) HP Shaft Size RPM

DRIVEN COMPONENTS: _____
 Type & Description Expected Hours Service Shaft Size RPM

CENTER DISTANCE: _____
 Maximum — Inches Minimum — Inches Nominal — Inches

Step 1: _____

$$\frac{\text{Design HP}}{\text{Prime Mover HP}} \times \text{Service Factor} = \text{Design HP}$$

Step 2: Belt Cross Section NOTE: If Prime Mover is electric motor, check minimum sheave diameter

Minimum Sheave Diameter = _____

Step 3: _____

$$\frac{\text{Speed Ratio}}{\text{RPM Faster Shaft}} \div \text{RPM Slower Shaft} = \text{Speed Ratio}$$

Step 4: From Rating Tables, determined by Belt Cross Section in Step 2, refer to proper Speed Ratio, then, reading across table determine:

- | | |
|---------------------------------------|---|
| A. _____
Prime Mover Sheave — Inch | D. _____
Center Distance — Inch |
| B. _____
Driven Sheave — Inch | E. _____
Belt Size (Cross Section & No.) |
| C. _____
Rated HP Per Belt | F. _____
Correction Factor |

Step 5: Number of Belts Required

- A. _____ × _____ = _____
 Rated HP Per Belt Correction Factor Corr. HP Per Belt
- B. _____ ÷ _____ = _____
 Design HP Corr. HP Per Belt Number Of Belts*

*If number contains a fraction, round off to next largest whole number

V-Belt Drive Selection

PRIME MOVER: _____
 Type & Description Rated (Nameplate) HP Shaft Size RPM

DRIVEN COMPONENTS: _____
 Type & Description Expected Hours Service Shaft Size RPM

CENTER DISTANCE: _____
 Maximum — Inches Minimum — Inches Nominal — Inches

Step 1: _____

$$\frac{\text{Design HP}}{\text{Prime Mover HP}} \times \text{Service Factor} = \text{Design HP}$$

Step 2: _____
 Belt Cross Section NOTE: If Prime Mover is electric motor, check Minimum Sheave Diameter
 Minimum Sheave Diameter = _____

Step 3: _____

$$\frac{\text{Speed Ratio}}{\text{RPM Faster Shaft}} \div \text{RPM Slower Shaft} = \text{Speed Ratio}$$

Step 4: From Rating Tables, determined by Belt Cross Section in Step 2, refer to proper Speed Ratio, then, reading across table determine:

- | | |
|---------------------------------------|---|
| A. _____
Prime Mover Sheave — Inch | D. _____
Center Distance — Inch |
| B. _____
Driven Sheave — Inch | E. _____
Belt Size (Cross Section & No.) |
| C. _____
Rated HP Per Belt | F. _____
Correction Factor |

Step 5: Number of Belts Required

- | | | | | |
|-------------------------------|---|----------------------------|---|----------------------------|
| A. _____
Rated HP Per Belt | × | _____
Correction Factor | = | _____
Corr. HP Per Belt |
| B. _____
Design HP | ÷ | _____
Corr. HP Per Belt | = | _____
Number Of Belts* |

*If number contains a fraction, round off to next largest whole number

V-Belt Drive Selection

PRIME MOVER: _____
 Type & Description Rated (Nameplate) HP Shaft Size RPM

DRIVEN COMPONENTS: _____
 Type & Description Expected Hours Service Shaft Size RPM

CENTER DISTANCE: _____
 Maximum — Inches Minimum — Inches Nominal — Inches

Step 1: _____

$$\frac{\text{Design HP}}{\text{Prime Mover HP}} \times \text{Service Factor} = \text{Design HP}$$

Step 2: Belt Cross Section NOTE: If Prime Mover is electric motor, check Minimum Sheave Diameter

Minimum Sheave Diameter = _____

Step 3: _____

$$\frac{\text{Speed Ratio}}{\text{RPM Faster Shaft}} \div \text{RPM Slower Shaft} = \text{Speed Ratio}$$

Step 4: From Rating Tables, determined by Belt Cross Section in Step 2, refer to proper Speed Ratio, then, reading across table determine:

- | | |
|---------------------------------------|---|
| A. _____
Prime Mover Sheave — Inch | D. _____
Center Distance — Inch |
| B. _____
Driven Sheave — Inch | E. _____
Belt Size (Cross Section & No.) |
| C. _____
Rated HP Per Belt | F. _____
Correction Factor |

Step 5: Number of Belts Required

- A. _____ × _____ = _____
 Rated HP Per Belt Correction Factor Corr. HP Per Belt
- B. _____ ÷ _____ = _____
 Design HP Corr. HP Per Belt Number Of Belts*

*If number contains a fraction, round off to next largest whole number



AK / BK
Bored-To-Size



AK / BK
MST® (*Martin* Split Taper) Bushed



2AK / 2BK
Bored-To-Size



2AK / 2BK
MST® (*Martin* Split Taper) Bushed

- Fractional Horsepower Sheaves for light duty applications.
- Single and double groove designs.
- Both Bored-To-Size and MST Bushed.
- Precision machined grooves.
- Statically balanced.

Call *Martin* for your made-to-order and large quantity requirements.

AK

Single Groove FHP Sheaves Bored-To-Size



V-BELT DRIVES

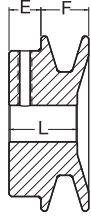

TYPE A
Solid

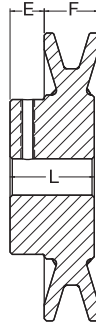

TYPE B
Web



TYPE C
Arm / Spoke

Dimensions in inches

Part Number	Diameter			Type	Stock Finished Bores Includes Keyway and Setscrew	F	E	L Thru Bore	Weight Lbs. (Approx.)
	OD	Datum A(4L) Belts	Pitch 3L Belts						
AK15	1.55	1.30	-	A	1/2 - 5/8	21/32	7/16	13/32	0.3
AK17	1.75	1.50	1.16	A	1/2 - 5/8	21/32	7/16	15/16	0.3
AK19	1.95	1.70	1.36	A	1/2 - 5/8 - 3/4 - 7/8	21/32	7/16	15/16	0.5
AK20	2.00	1.80	1.46	A	1/2 - 5/8 - 3/4 -	21/32	7/16	15/16	0.5
AK21	2.10	1.90	1.56	A	1/2 - 5/8 - 3/4 -	21/32	7/16	15/16	0.5
AK22	2.20	2.00	1.66	A	1/2 - 5/8 - 3/4 - 7/8	21/32	7/16	15/16	0.6
AK23	2.30	2.10	1.76	A	1/2 - 5/8 - 3/4 -	21/32	7/16	15/16	0.6
AK24	2.40	2.20	1.86	A	1/2 - 5/8 - 3/4 - 7/8 - - 1	21/32	7/16	15/16	0.6
AK25	2.50	2.30	1.96	B	1/2 - 5/8 - 3/4 - 7/8 - -	21/32	7/16	15/16	0.7
AK26	2.60	2.40	2.06	B	1/2 - 5/8 - 3/4 - - -	21/32	7/16	15/16	0.7
AK27	2.70	2.50	2.16	B	1/2 - 5/8 - 3/4 - - - 1	21/32	7/16	15/16	0.8
AK28	2.80	2.60	2.26	B	1/2 - 5/8 - 3/4 - 7/8 - -	21/32	7/16	15/16	0.8
AK30	3.05	2.80	2.46	B	1/2 - 5/8 - 3/4 - 7/8 - - 1	21/32	7/16	15/16	0.9
AK32	3.25	3.00	2.66	B	1/2 - 5/8 - 3/4 - 7/8 - - 1	21/32	7/16	15/16	1.0
AK34	3.45	3.20	2.86	B	1/2 - 5/8 - 3/4 - 7/8 - - 1	21/32	7/16	15/16	1.1
AK35	3.55	3.30	2.96	B	1/2 - 5/8 - 3/4 - 7/8 - - 1	21/32	7/16	15/16	1.2
AK39	3.75	3.50	3.16	B	1/2 - 5/8 - 3/4 - 7/8 - 15/16 - 1	3/4	15/32	15/32	1.6
AK41	3.95	3.70	3.36	B	1/2 - 5/8 - 3/4 - 7/8 - 15/16 - 1 - 1 1/8	3/4	15/32	15/32	1.6
AK44	4.25	4.00	3.66	B	1/2 - 5/8 - 3/4 - 7/8 - 15/16 - 1 - 1 1/8	3/4	15/32	15/32	1.9
AK46	4.45	4.20	3.86	B	1/2 - 5/8 - 3/4 - 7/8 - 15/16 - 1 - 1 1/8	3/4	15/32	15/32	2.0
AK49	4.75	4.50	4.16	B	1/2 - 5/8 - 3/4 - 7/8 - 15/16 - 1 - 1 1/8	3/4	15/32	15/32	2.1
AK51	4.95	4.70	4.36	B	1/2 - 5/8 - 3/4 - 7/8 - 15/16 - 1 - 1 1/8	3/4	15/32	15/32	2.2
AK54	5.25	5.00	4.66	B	1/2 - 5/8 - 3/4 - 7/8 - 15/16 - 1 - 1 1/8 - 1 1/16	3/4	15/32	15/32	2.4
AK56	5.45	5.20	4.86	B	1/2 - 5/8 - 3/4 - 7/8 - 15/16 - 1 - 1 1/8 - 1 1/16	3/4	15/32	15/32	2.5
AK59	5.75	5.50	5.16	C	1/2 - 5/8 - 3/4 - 7/8 - 15/16 - 1 - 1 1/8 - 1 1/16	3/4	15/32	15/32	2.7
AK61	5.95	5.70	5.36	C	1/2 - 5/8 - 3/4 - 7/8 - 15/16 - 1 - 1 1/8 - 1 1/16	3/4	15/32	15/32	2.8
AK64	6.25	6.00	5.66	C	1/2 - 5/8 - 3/4 - 7/8 - 15/16 - 1 - 1 1/8 - 1 1/16	3/4	15/32	15/32	3.0
AK66	6.45	6.20	5.86	C	- 5/8 - 3/4 - - - - 1 - 1 1/8 -	3/4	15/32	15/32	3.0
AK69	6.75	6.50	6.16	C	- - 3/4 - - - - - 1 - 1 1/8 -	3/4	23/32	11 15/32	3.7
AK71	6.95	6.70	6.36	C	1/2 - 5/8 - 3/4 - - - - 1 - 1 1/8 - - - - 1 1/16	3/4	23/32	11 15/32	4.3
AK74	7.25	7.00	6.66	C	1/2 - 5/8 - 3/4 - - - 15/16 - 1 - 1 1/8 - 1 1/16 - 1 1/4 - - - 1 1/16	3/4	23/32 *	11 15/32	4.5
AK79	7.75	7.50	7.16	C	- - - 3/4 - - - - 1 - 1 1/8 - - - - - 1 1/16	3/4	23/32	11 15/32	4.7
AK81	7.95	7.70	7.36	C	- - 5/8 - 3/4 - - - - 1 - - - 1 1/16 - - - - - 1 1/16	3/4	23/32	11 15/32	4.7
AK84	8.25	8.00	7.66	C	1/2 - 5/8 - 3/4 - - - 15/16 - 1 - - - 1 1/16 - - - - - 1 1/16	3/4	23/32 *	11 15/32	5.0
AK89	8.75	8.50	8.16	C	- - - 3/4 - - - - 1 - 1 1/8 - - - - - 1 1/16	3/4	23/32	11 15/32	5.2
AK91	8.95	8.70	8.36	C	- - - 3/4 - - - - 1 - - - - - - - - - - -	3/4	23/32	11 15/32	5.2
AK94	9.25	9.00	8.66	C	1/2 - 5/8 - 3/4 - - - 15/16 - 1 - - - 1 1/16 - 1 1/4 - - - 1 1/16	3/4	23/32 *	11 15/32	5.5
AK99	9.75	9.50	9.16	C	- - - 3/4 - - - - 1 - - - - - - - - - - 1 1/16	3/4	23/32 *	11 15/32	5.7
AK104	10.25	10.00	9.66	C	- 5/8 - 3/4 - - - - 1 - - - 1 1/16 - 1 1/4 - 1 3/8 - 1 1/16	3/4	23/32	11 15/32	5.9
AK109	10.75	10.50	10.16	C	- - 3/4 - - - - 1 - - - - 1 1/8 - 1 1/16	3/4	23/32	11 15/32	6.1
AK114	11.25	11.00	10.66	C	- - 3/4 - - - - 1 - - - 1 1/16 - - - - - 1 1/16	3/4	23/32 *	11 15/32	6.7
AK124	12.25	12.00	11.66	C	5/8 - 3/4 - - - - 1 - - - 1 1/16 - 1 1/4 - - - 1 1/16	3/4	23/32 *	11 15/32	7.3
AK134	13.25	13.00	12.66	C	- 3/4 - - - - 1 - - - 1 1/16 - - - 1 3/8 - 1 1/16	3/4	23/32	11 15/32	8.2
AK144	14.25	14.00	13.66	C	- 3/4 - - - - 1 - - - 1 1/16 - - - - - 1 1/16	3/4	23/32	11 15/32	8.7
AK154	15.25	15.00	14.66	C	- 3/4 - - - - 1 - - - - - - - - - - 1 1/16	3/4	23/32	11 15/32	9.7
AK184	18.25	18.00	17.66	C	- 3/4 - - - - 1 - - - 1 1/16 - - - - - 1 1/16	3/4	23/32	11 15/32	11.8

* E = 25/32 FOR BORE SIZES <= 1
1/2" Bore - setscrew only - no keyway



Two Groove FHP Sheaves Bored-To-Size

2AK

Keyway Dimensions Inch Bore

Diameter Of Shaft	Keyway Width X Depth
1/2	NONE
5/8 - 7/8	3/16 X 3/32
15/16 - 1-1/4	1/4 X 1/8
1-5/16 - 1-3/8	5/16 X 5/32
1-7/16 - 1-3/4	3/8 X 3/16

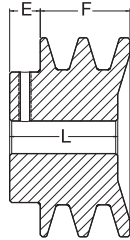

TYPE A
Solid

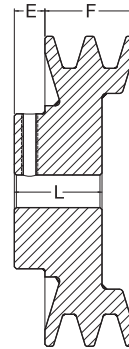

TYPE B
Web

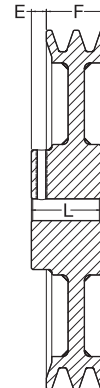

TYPE C
Arm / Spoke

Dimensions in inches

Part Number	Diameter			Type	Stock Finished Bores Includes Keyway and Setscrew	F	E	L Thru Bore	Weight Lbs. (Approx.)
	OD	Datum A(4L) Belts	Pitch 3L Belts						
2AK20	2.00	1.80	1.46	A	1/2 - 5/8 - 3/4	1 3/8	1 5/32	1 21/32	0.8
2AK21	2.15	1.90	1.56	A	1/2 - 5/8 - 3/4	1 3/8	1 5/32	1 21/32	0.9
2AK22	2.25	2.00	1.66	A	1/2 - 5/8 - 3/4 - 7/8 - - 1	1 3/8	1 5/32	1 21/32	1.1
2AK23	2.35	2.10	1.76	A	- 5/8 - 3/4 - 7/8 - - 1	1 3/8	1 5/32	1 21/32	1.2
2AK25	2.55	2.30	1.96	A	- 5/8 - 3/4 - 7/8 - - 1	1 3/8	1 5/32	1 21/32	1.4
2AK26	2.65	2.40	2.06	A	- 5/8 - 3/4 - 7/8 - -	1 3/8	1 5/32	1 21/32	1.5
2AK27	2.75	2.50	2.16	A	- 5/8 - 3/4 - 7/8 - - 1	1 3/8	1 5/32	1 21/32	1.6
2AK28	2.85	2.60	2.26	A	- 5/8 - 3/4 - 7/8 - - 1	1 3/8	1 5/32	1 21/32	1.7
2AK30	3.05	2.80	2.46	A	1/2 - 5/8 - 3/4 - 7/8 - - 1 - 1 1/8	1 3/8	1 5/32	1 21/32	2.0
2AK32	3.25	3.00	2.66	A	5/8 - 3/4 - 7/8 - - 1 - 1 1/8	1 3/8	1 5/32	1 21/32	2.2
2AK34	3.45	3.20	2.86	A	5/8 - 3/4 - 7/8 - - 1 - 1 1/8	1 3/8	1 5/32	1 21/32	2.5
2AK39	3.75	3.50	3.16	B	5/8 - 3/4 - 7/8 - - 1 - 1 1/8	1 3/8	1 5/32	1 11/32	2.6
2AK41	3.95	3.70	3.36	B	5/8 - 3/4 - 7/8 - - 1 - 1 1/8	1 3/8	1 5/32	1 11/32	2.9
2AK44	4.25	4.00	3.66	B	5/8 - 3/4 - 7/8 - - 1 - 1 1/8	1 3/8	1 5/32	1 11/32	3.3
2AK46	4.45	4.20	3.86	B	5/8 - - - 7/8 - - 1 - 1 1/8	1 3/8	1 5/32	1 11/32	3.6
2AK49	4.75	4.50	4.16	B	- 3/4 - 7/8 - - 1 - 1 1/8 - - 1 3/8	1 3/8	1 5/32	1 11/32	4.1
2AK51	4.95	4.70	4.36	B	- 3/4 - 7/8 - - 1 - 1 1/8 - - 1 3/8	1 3/8	1 5/32	1 11/32	4.5
2AK54	5.25	5.00	4.66	B	5/8 - 3/4 - 7/8 - - 1 - 1 1/8 - - 1 3/8	1 3/8	1 5/32	1 11/32	4.1
2AK56	5.45	5.20	4.86	B	5/8 - 3/4 - - - 1 - 1 1/8 - - 1 3/8	1 3/8	1 5/32	1 11/32	4.1
2AK59	5.75	5.50	5.16	B	- - - - 1 - 1 1/8 - - 1 3/8	1 3/8	1 5/32	1 11/32	4.3
2AK61	5.95	5.70	5.36	B	3/4 - 7/8 - - 1 - 1 1/8 - - 1 3/8	1 3/8	1 5/32	1 11/32	4.5
2AK64	6.25	6.00	5.66	C	3/4 - - - 1 - 1 1/8 - 1 3/16 - 1 3/8 - 1 7/16	1 3/8	1 11/32	1 19/32	5.6
2AK74	7.25	7.00	6.66	C	3/4 - - - 1 - 1 1/8 - 1 3/16 - 1 3/8 - 1 7/16	1 3/8	1 11/32	1 19/32	6.5
2AK84	8.25	8.00	7.66	C	3/4 - - - 1 5/16 - 1 - 1 1/8 - - 1 3/8 - 1 7/16	1 3/8	1 11/32	1 19/32	7.2
2AK94	9.25	9.00	8.66	C	3/4 - 7/8 - - 1 - 1 1/8 - 1 3/16 - 1 3/8 - 1 7/16	1 3/8	1 11/32	1 19/32	8.0
2AK104	10.25	10.00	9.66	C	3/4 - - - 1 5/16 - 1 - - 1 3/16 - - 1 7/16	1 3/8	1 11/32	1 19/32	9.0
2AK114	11.25	11.00	10.66	C	1 - - - 1 3/16 - 1 3/8 - 1 7/16	1 3/8	1 11/32	1 19/32	9.7
2AK124	12.25	12.00	11.66	C	1 - - - 1 3/16 - - 1 7/16	1 3/8	1 11/32	1 19/32	10.5
2AK134	13.25	13.00	12.66	C	- - - 1 3/16 - - 1 7/16	1 3/8	1 11/32	1 19/32	12.7
2AK144	14.25	14.00	13.66	C	1 - - - - 1 7/16	1 3/8	1 11/32	1 19/32	13.1
2AK154	15.25	15.00	14.66	C	1 3/16 - - - 1 7/16	1 3/8	1 11/32	1 19/32	14.3
2AK184	18.25	18.00	17.66	C	1 3/16 - - - 1 7/16	1 3/8	1 11/32	1 19/32	17.1

1/2" Bore - setscrew only - no keyway

V-BELT DRIVES

AK-H Single Groove FHP Sheaves MST® Bushed



V-BELT DRIVES

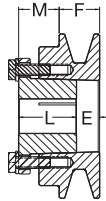

TYPE A
Solid

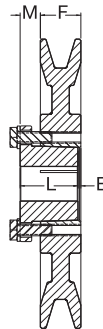

TYPE B
Web

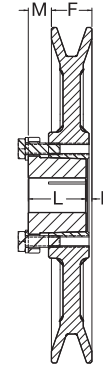

TYPE C
Arm / Spoke

Dimensions in inches, weight in pounds

Part Number	Diameter			Type	Bush	Bush Max. Bore	F	E	L Thru Bore	M	Weight Less Bush
	OD	Datum A(4L) Belts	Pitch 3L Belts								
AK30-H	3.05	2.80	2.46	A	H	1-1/2	3/4	3/8	1-1/4	7/8	1.3
AK32-H	3.25	3.00	2.66	A	H	1-1/2	3/4	3/8	1-1/4	7/8	1.4
AK34-H	3.45	3.20	2.86	A	H	1-1/2	3/4	1/16	1-1/4	9/16	1.2
AK39-H	3.75	3.50	3.16	A	H	1-1/2	3/4	1/16	1-1/4	9/16	1.4
AK41-H	3.95	3.70	3.36	A	H	1-1/2	3/4	1/16	1-1/4	9/16	1.6
AK44-H	4.25	4.00	3.66	A	H	1-1/2	3/4	1/16	1-1/4	9/16	2.0
AK46-H	4.45	4.20	3.86	A	H	1-1/2	3/4	1/16	1-1/4	9/16	2.2
AK49-H	4.75	4.50	4.16	B	H	1-1/2	3/4	1/16	1-1/4	9/16	2.1
AK51-H	4.95	4.70	4.36	B	H	1-1/2	3/4	1/16	1-1/4	9/16	2.3
AK54-H	5.25	5.00	4.66	B	H	1-1/2	3/4	1/16	1-1/4	9/16	2.3
AK56-H	5.45	5.20	4.86	B	H	1-1/2	3/4	1/16	1-1/4	9/16	2.4
AK59-H	5.75	5.50	5.16	B	H	1-1/2	3/4	1/16	1-1/4	9/16	2.5
AK61-H	5.95	5.70	5.36	C	H	1-1/2	3/4	1/16	1-1/4	9/16	2.6
AK64-H	6.25	6.00	5.66	C	H	1-1/2	3/4	1/16	1-1/4	9/16	2.8
AK66-H	6.45	6.20	5.86	C	H	1-1/2	3/4	1/16	1-1/4	9/16	2.8
AK69-H	6.75	6.50	6.16	C	H	1-1/2	3/4	1/16	1-1/4	9/16	3.0
AK71-H	6.95	6.70	6.36	C	H	1-1/2	3/4	1/16	1-1/4	9/16	3.0
AK74-H	7.25	7.00	6.66	C	H	1-1/2	3/4	1/16	1-1/4	9/16	3.3
AK79-H	7.75	7.50	7.16	C	H	1-1/2	3/4	1/16	1-1/4	9/16	3.5
AK84-H	8.25	8.00	7.66	C	H	1-1/2	3/4	1/16	1-1/4	9/16	3.8
AK89-H	8.75	8.50	8.16	C	H	1-1/2	3/4	1/16	1-1/4	9/16	4.0
AK94-H	9.25	9.00	8.66	C	H	1-1/2	3/4	1/16	1-1/4	9/16	4.4
AK99-H	9.75	9.50	9.16	C	H	1-1/2	3/4	1/16	1-1/4	9/16	4.7
AK104-H	10.25	10.00	9.66	C	H	1-1/2	3/4	1/16	1-1/4	9/16	5.0
AK109-H	10.75	10.50	10.16	C	H	1-1/2	3/4	1/16	1-1/4	9/16	5.2
AK114-H	11.25	11.00	10.66	C	H	1-1/2	3/4	1/16	1-1/4	9/16	5.5
AK124-H	12.25	12.00	11.66	C	H	1-1/2	3/4	1/16	1-1/4	9/16	6.0
AK134-H	13.25	13.00	12.66	C	H	1-1/2	3/4	1/16	1-1/4	9/16	7.3
AK144-H	14.25	14.00	13.66	C	H	1-1/2	3/4	1/16	1-1/4	9/16	7.9
AK154-H	15.25	15.00	14.66	C	H	1-1/2	3/4	1/16	1-1/4	9/16	8.9
AK184-H	18.25	18.00	17.66	C	H	1-1/2	3/4	1/16	1-1/4	9/16	11.4

Weights do not include bushings. See page D-202 for additional bushing information.



Two Groove FHP Sheaves MST® Bushed

2AK-H

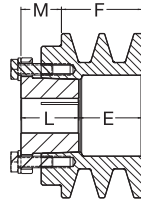

TYPE A
Solid

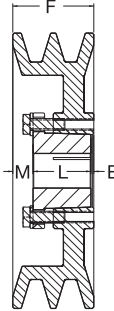

TYPE B
Web

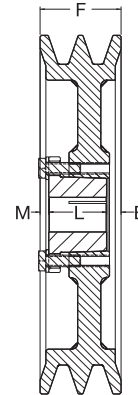

TYPE C
Arm / Spoke

Dimensions in inches, weight in pounds

Part Number	Diameter			Type	Bush	Bush Max. Bore	F	E	L Thru Bore	M	Weight Less Bush
	OD	Datum A(4L) Belts	Pitch 3L Belts								
2AK30-H	3.05	2.80	2.46	A	H	1-1/2	1-3/8	1	1-1/4	7/8	1.7
2AK32-H	3.25	3.00	2.66	A	H	1-1/2	1-3/8	1	1-1/4	7/8	1.9
2AK34-H	3.45	3.20	2.86	A	H	1-1/2	1-3/8	9/16	1-1/4	7/16	1.7
2AK39-H	3.75	3.50	3.16	A	H	1-1/2	1-3/8	9/16	1-1/4	7/16	2.0
2AK41-H	3.95	3.70	3.36	B	H	1-1/2	1-3/8	1/16	1-1/4	1/16	2.2
2AK44-H	4.25	4.00	3.66	B	H	1-1/2	1-3/8	1/16	1-1/4	1/16	2.7
2AK46-H	4.45	4.20	3.86	B	H	1-1/2	1-3/8	1/16	1-1/4	1/16	3.0
2AK49-H	4.75	4.50	4.16	B	H	1-1/2	1-3/8	1/16	1-1/4	1/16	3.1
2AK51-H	4.95	4.70	4.36	B	H	1-1/2	1-3/8	1/16	1-1/4	1/16	3.5
2AK54-H	5.25	5.00	4.66	B	H	1-1/2	1-3/8	1/16	1-1/4	1/16	3.4
2AK56-H	5.45	5.20	4.86	B	H	1-1/2	1-3/8	1/16	1-1/4	1/16	3.6
2AK59-H	5.75	5.50	5.16	C	H	1-1/2	1-3/8	1/16	1-1/4	1/16	3.4
2AK61-H	5.95	5.70	5.36	C	H	1-1/2	1-3/8	1/16	1-1/4	1/16	3.7
2AK64-H	6.25	6.00	5.66	C	H	1-1/2	1-3/8	1/16	1-1/4	1/16	3.9
2AK74-H	7.25	7.00	6.66	C	H	1-1/2	1-3/8	1/16	1-1/4	1/16	5.0
2AK84-H	8.25	8.00	7.66	C	H	1-1/2	1-3/8	1/16	1-1/4	1/16	5.6
2AK94-H	9.25	9.00	8.66	C	H	1-1/2	1-3/8	1/16	1-1/4	1/16	6.3
2AK104-H	10.25	10.00	9.66	C	H	1-1/2	1-3/8	1/16	1-1/4	1/16	7.6
2AK114-H	11.25	11.00	10.66	C	H	1-1/2	1-3/8	1/16	1-1/4	1/16	8.4
2AK124-H	12.25	12.00	11.66	C	H	1-1/2	1-3/8	1/16	1-1/4	1/16	9.2
2AK134-H	13.25	13.00	12.66	C	H	1-1/2	1-3/8	1/16	1-1/4	1/16	11.5
2AK144-H	14.25	14.00	13.66	C	H	1-1/2	1-3/8	1/16	1-1/4	1/16	11.8
2AK154-H	15.25	15.00	14.66	C	H	1-1/2	1-3/8	1/16	1-1/4	1/16	13.3
2AK184-H	18.25	18.00	17.66	C	H	1-1/2	1-3/8	1/16	1-1/4	1/16	16.9

Weights do not include bushings. See page D-202 for additional bushing information.

MST "H" Bushings – Inch Bore

Diameter Of Shaft	Keyway Width X Depth	Diameter Of Shaft	Keyway Width X Depth
3/8	NONE	1	1/4 X 1/8
7/16	NONE	1-1/16	1/4 X 1/8
1/2	1/8 X 1/16	1-1/8	1/4 X 1/8
9/16	1/8 X 1/16	1-3/16	1/4 X 1/8
19/32	1/8 X 1/16	1-1/4	1/4 X 1/8
5/8	3/16 X 3/32	1-5/16	5/16 X 1/16
21/32	3/16 X 3/32	1-3/8	5/16 X 1/16
11/16	3/16 X 3/32	1-3/8W	3/8 X 1/16
3/4	3/16 X 3/32	1-7/16	3/8 X 1/16
25/32	3/16 X 3/32	1-1/2	3/8 X 1/32
13/16	3/16 X 3/32		
7/8	3/16 X 3/32		
15/16	1/4 X 1/8		
31/32	1/4 X 1/8		

MST "H" Bushings – Millimeter Bore

Diameter Of Shaft	Keyway Width X Depth	Diameter Of Shaft	Keyway Width X Depth
10	NONE	22	6 X 2.8
11	NONE	24	8 X 3.3
12	NONE	25	8 X 3.3
14	5 X 2.3	28	8 X 3.3
16	5 X 2.3	30	8 X 3.3
18	6 X 2.8	32	10 X 1.3
19	6 X 2.8	35	10 X 0.3
20	6 X 2.8	36	10 X 1.3
		38	10 X 0.3

V-BELT DRIVES

BK

Single Groove FHP Sheaves Bored-To-Size



V-BELT DRIVES

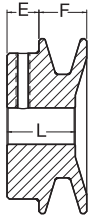

TYPE A
Solid

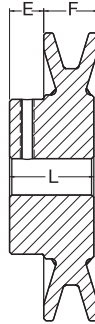

TYPE B
Web



TYPE C
Arm / Spoke

Dimensions in inches

Part Number	Diameter			Type	Stock Finished Bores Includes Keyway and Setscrew	F	E	L Thru Bore	Weight Lbs. (Approx.)
	OD	Datum A(4L) Belts	Datum B(5L) Belts						
BK23	2.30	-	2.10	A	5/8 - - - - 1	13/16	13/32	1 1/16	0.4
BK24	2.40	1.80	2.20	A	1/2 - 5/8 - 3/4 - 7/8 - -	13/16	13/32	1 1/16	0.4
BK25	2.50	1.90	2.30	A	1/2 - 5/8 - 3/4 - 7/8 - -	13/16	13/32	1 1/16	0.5
BK26	2.60	2.00	2.40	A	1/2 - 5/8 - 3/4 - 7/8 - -	13/16	13/32	1 1/16	0.6
BK27	2.70	2.10	2.50	B	1/2 - 5/8 - 3/4 - 7/8 - - 1 1/8	13/16	13/32	1 1/16	0.6
BK28	2.95	2.20	2.60	B	1/2 - 5/8 - 3/4 - 7/8 - - 1 - 1 1/8	13/16	13/32	1 1/16	0.8
BK30	3.15	2.40	2.80	B	1/2 - 5/8 - 3/4 - 7/8 - - 1 - 1 1/8	13/16	13/32	1 1/16	0.8
BK32	3.35	2.60	3.00	B	1/2 - 5/8 - 3/4 - 7/8 - - 1 -	13/16	13/32	1 1/16	0.8
BK34	3.55	2.80	3.20	B	1/2 - 5/8 - 3/4 - 7/8 - - 1 - 1 1/8	7/8	13/32	1 5/32	1.3
BK36	3.75	3.00	3.40	B	1/2 - 5/8 - 3/4 - 7/8 - - 1 - 1 1/8	7/8	13/32	1 5/32	1.5
BK40	3.95	3.20	3.60	B	1/2 - 5/8 - 3/4 - 7/8 - - 1 - 1 1/8	7/8	13/32	1 5/32	1.5
BK45	4.25	3.50	3.90	B	1/2 - 5/8 - 3/4 - 7/8 - - 1 - 1 1/8	7/8	13/32	1 5/32	1.8
BK46	4.35	3.60	4.00	B	- - - - 7/8 - - - -	7/8	13/32	1 5/32	1.8
BK47	4.45	3.70	4.10	B	1/2 - 5/8 - 3/4 - 7/8 - - 1 - 1 1/8	7/8	13/32	1 5/32	1.8
BK48	4.55	3.80	4.20	B	1/2 - 5/8 - 3/4 - 7/8 - - - - 1 1/8	7/8	13/32	1 5/32	2.0
BK50	4.75	4.00	4.40	B	1/2 - 5/8 - 3/4 - 7/8 - 15/16 - 1 - 1 1/8	7/8	13/32	1 5/32	2.0
BK52	4.95	4.20	4.60	B	1/2 - 5/8 - 3/4 - 7/8 - - 1 - 1 1/8	7/8	13/32	1 5/32	2.0
BK55	5.25	4.50	4.90	B	1/2 - 5/8 - 3/4 - 7/8 - - 1 - 1 1/8 - 1 3/16	7/8	13/32	1 5/32	2.2
BK57	5.45	4.70	5.10	B	- 5/8 - 3/4 - 7/8 - 15/16 - 1 - 1 1/8 -	7/8	13/32	1 5/32	2.3
BK60	5.75	5.00	5.40	B	1/2 - 5/8 - 3/4 - 7/8 - - 1 - 1 1/8 - 1 3/16	7/8	13/32	1 5/32	2.3
BK62	5.95	5.20	5.60	B	1/2 - 5/8 - 3/4 - 7/8 - 15/16 - 1 - 1 1/8 - 1 3/16	7/8	13/32	1 5/32	2.4
BK65	6.25	5.50	5.90	B	5/8 - 3/4 - 7/8 - - 1 - 1 1/8 -	7/8	13/32	1 5/32	2.7
BK67	6.45	5.70	6.10	C	5/8 - 3/4 - 7/8 - - 1 - 1 1/8 -	7/8	13/32	1 5/32	2.8
BK70	6.75	6.00	6.40	C	5/8 - 3/4 - 7/8 - 15/16 - 1 - 1 1/8 - 1 3/16 - - - 1 7/16	7/8	2 1/32 *	1 15/32	3.3
BK72	6.95	6.20	6.60	C	- 3/4 - - - - 1 - 1 1/8 - - - - 1 3/8 - 1 7/16	7/8	2 1/32	1 15/32	3.9
BK75	7.25	6.50	6.90	C	- 3/4 - - - - 1 - 1 1/8 - - - - 1 7/16	7/8	2 1/32	1 15/32	3.9
BK77	7.45	6.70	7.10	C	- 3/4 - - - - 1 - 1 1/8 - - - - 1 3/8 - 1 7/16	7/8	2 1/32	1 15/32	4.1
BK80	7.75	7.00	7.40	C	5/8 - 3/4 - 7/8 - - 1 - 1 1/8 - 1 3/16 - 1 1/4 - 1 3/8 - 1 7/16	7/8	2 1/32	1 15/32	4.4
BK85	8.25	7.50	7.90	C	3/4 - - - - 1 - 1 1/8 - 1 3/16 - - - 1 3/8 - 1 7/16	7/8	2 1/32	1 15/32	5.0
BK90	8.75	8.00	8.40	C	3/4 - 7/8 - 15/16 - 1 - 1 1/8 - 1 3/16 - - - 1 3/8 - 1 7/16	7/8	2 1/32	1 15/32	5.0
BK95	9.25	8.50	8.90	C	3/4 - - - - 1 - 1 1/8 - - - - 1 3/8 - 1 7/16	7/8	2 1/32	1 15/32	5.4
BK100	9.75	9.00	9.40	C	3/4 - 7/8 - - - 1 - 1 1/8 - 1 3/16 - 1 1/4 - 1 3/8 - 1 7/16	7/8	2 1/32	1 15/32	5.6
BK105	10.25	9.50	9.90	C	- - - - 1 - - - - - 1 3/8 - 1 7/16	7/8	2 1/32	1 15/32	5.8
BK110	10.75	10.00	10.40	C	3/4 - - - - 1 - 1 1/8 - 1 3/16 - - - 1 3/8 - 1 7/16	7/8	2 1/32	1 15/32	6.4
BK115	11.25	10.50	10.90	C	- - - - 1 - - - - - 1 3/8 - 1 7/16	7/8	2 1/32	1 15/32	6.9
BK120	11.75	11.00	11.40	C	3/4 - - - - 1 - - - 1 3/16 - - - 1 3/8 - 1 7/16	7/8	2 1/32	1 15/32	7.4
BK130	12.75	12.00	12.40	C	3/4 - 7/8 - - - 1 - - 1 1/8 - 1 3/16 - - - 1 7/16	7/8	2 1/32	1 15/32	8.4
BK140	13.75	13.00	13.40	C	3/4 - - - - 1 - - - 1 3/16 - - - 1 7/16	7/8	2 1/32	1 15/32	9.4
BK160	15.75	15.00	15.40	C	1 - 1 1/8 - 1 3/16 - 1 1/4 - - 1 7/16	7/8	2 1/32	1 15/32	11.4
BK190	18.75	18.00	18.40	C	1 - - - 1 3/16 - 1 1/4 - - 1 7/16	7/8	2 1/32	1 15/32	13.4

* E = 13/32 FOR BORE SIZES <= 1
1/2" Bore - setscrew only - no keyway



Two Groove FHP Sheaves Bored-To-Size **2BK**

Keyway Dimensions Inch Bore

Diameter Of Shaft	Keyway Width X Depth
1/2	NONE
5/8 - 7/8	3/16 X 3/32
15/16 - 1-1/4	1/4 X 1/8
1-5/16 - 1-3/8	5/16 X 5/32
1-7/16 - 1-3/4	3/8 X 3/16

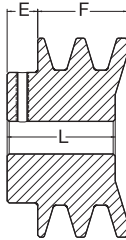

TYPE A
Solid

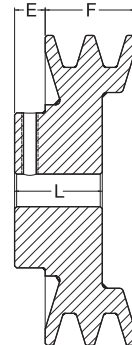

TYPE B
Web

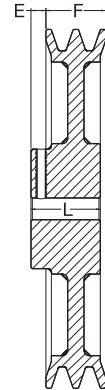

TYPE C
Arm / Spoke

Dimensions in inches

Part Number	Diameter			Type	Stock Finished Bores Includes Keyway and Setscrew	F	E	L Thru Bore	Weight Lbs. (Approx.)
	OD	Datum A(4L) Belts	Datum B(5L) Belts						
2BK25	2.50	1.90	2.30	A	1/2 - 5/8 - 3/4 - 7/8 - 1 - 1 1/8	1 3/4	1 5/32	1 31/32	1.3
2BK26	2.60	2.00	2.40	A	- 5/8 - - - 7/8 - - - 1 1/8	1 3/4	1 5/32	1 31/32	1.5
2BK27	2.70	2.10	2.50	A	1/2 - 5/8 - 3/4 - 7/8 - 1 - -	1 3/4	1 5/32	1 31/32	1.6
2BK28	2.95	2.20	2.60	A	1/2 - 5/8 - 3/4 - 7/8 - 1 - 1 1/8	1 3/4	1 5/32	1 31/32	1.9
2BK30	3.15	2.40	2.80	A	1/2 - 5/8 - 3/4 - 7/8 - 1 - 1 1/8	1 3/4	1 5/32	1 31/32	2.3
2BK32	3.35	2.60	3.00	A	5/8 - - - 7/8 - 1 - 1 1/8	1 3/4	1 5/32	1 31/32	2.6
2BK34	3.55	2.80	3.20	A	5/8 - 3/4 - 7/8 - 1 - 1 1/8	1 3/4	1 5/32	1 31/32	2.8
2BK36	3.75	3.00	3.40	A	- 3/4 - 7/8 - 1 - 1 1/8 - - 1 3/8	1 3/4	1 5/32	1 31/32	3.3
2BK40	3.95	3.20	3.60	B	5/8 - 3/4 - 7/8 - 1 - 1 1/8 - -	1 3/4	1 5/32	1 15/32	3.3
2BK45	4.25	3.50	3.90	B	- - - 1 - 1 1/8 - - - 1 3/8	1 3/4	1 5/32	1 15/32	3.3
2BK47	4.45	3.70	4.10	B	- - - 7/8 - 1 - 1 1/8 - -	1 3/4	1 5/32	1 15/32	3.7
2BK50	4.75	4.00	4.40	B	3/4 - - - 1 - 1 1/8 - - - 1 3/8	1 3/4	1 5/32	1 15/32	4.1
2BK52	4.95	4.20	4.60	B	- - 7/8 - 1 - 1 1/8 - - - 1 3/8	1 3/4	1 5/32	1 15/32	4.5
2BK55	5.25	4.50	4.90	B	- - - - - 1 1/8 - - - 1 3/8	1 3/4	1 5/32	1 15/32	4.5
2BK57	5.45	4.70	5.10	B	- - - - - 1 - 1 1/8 - - - 1 3/8	1 3/4	1 5/32	1 15/32	5.1
2BK60	5.75	5.00	5.40	B	3/4 - 7/8 - 1 - 1 1/8 - - - 1 3/8	1 3/4	1 5/32	1 15/32	4.9
2BK62	5.95	5.20	5.60	B	- - - 1 - 1 1/8 - - - 1 3/8	1 3/4	1 5/32	1 15/32	4.8
2BK65	6.25	5.50	5.90	B	- - - 1 - 1 1/8 - - - 1 3/8	1 3/4	1 5/32	1 15/32	5.0
2BK67	6.45	5.70	6.10	C	- - - 1 - 1 1/8 - - - 1 3/8	1 3/4	1 5/32	1 15/32	5.0
2BK70	6.75	6.00	6.40	C	3/4 - - - 1 - 1 1/8 - 1 3/16 - 1 3/8 - 1 7/16	1 3/4	1 11/32	1 19/32	6.6
2BK80	7.75	7.00	7.40	C	3/4 - - - 1 - 1 1/8 - 1 3/16 - 1 3/8 - 1 7/16	1 3/4	1 11/32	1 19/32	7.2
2BK90	8.75	8.00	8.40	C	3/4 - - - 1 - 1 1/8 - 1 3/16 - 1 3/8 - 1 7/16	1 3/4	1 11/32	1 19/32	8.4
2BK100	9.75	9.00	9.40	C	3/4 - - - 1 - - - 1 3/16 - 1 3/8 - 1 7/16	1 3/4	1 11/32	1 19/32	9.4
2BK110	10.75	10.00	10.40	C	- - - 1 - - - 1 3/16 - - - 1 7/16	1 3/4	1 11/32	1 19/32	10.4
2BK120	11.75	11.00	11.40	C	- - - 1 - - - 1 3/16 - - - 1 7/16	1 3/4	1 11/32	1 19/32	11.8
2BK130	12.75	12.00	12.40	C	- - - 1 - - - 1 3/16 - - - 1 7/16	1 3/4	1 11/32	1 19/32	14.9
2BK140	13.75	13.00	13.40	C	- - - 1 - - - 1 3/16 - - - 1 7/16	1 3/4	1 11/32	1 19/32	16.3
2BK160	15.75	15.00	15.40	C	- - - 1 - - - 1 3/16 - - - 1 7/16	1 3/4	1 11/32	1 19/32	18.0
2BK190	18.75	18.00	18.40	C	- - - 1 - - - 1 3/16 - - - 1 7/16	1 3/4	1 11/32	1 19/32	23.3

1/2" Bore - setscrew only - no keyway

V-BELT DRIVES

BK-H Single Groove FHP Sheaves MST® Bushed



V-BELT DRIVES

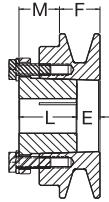

TYPE A
Solid

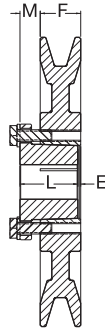

TYPE B
Web

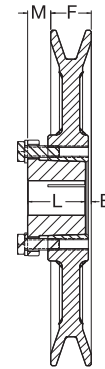

TYPE C
Arm / Spoke

Dimensions in inches, weight in pounds

Part Number	Diameter			Type	Bush	Bush Max. Bore	F	E	L Thru Bore	M	Weight Less Bush
	OD	Datum A(4L) Belts	Datum B(5L) Belts								
BK30-H	3.15	2.40	2.80	A	H	1-1/2	7/8	1/2	1-1/4	7/8	1.3
BK32-H	3.35	2.60	3.00	A	H	1-1/2	7/8	1/2	1-1/4	7/8	1.5
BK34-H	3.55	2.80	3.20	A	H	1-1/2	7/8	1/2	1-1/4	7/8	1.7
BK36-H	3.75	3.00	3.40	B	H	1-1/2	7/8	1/16	1-1/4	7/16	1.3
BK40-H	3.95	3.20	3.60	B	H	1-1/2	7/8	1/16	1-1/4	7/16	1.5
BK45-H	4.25	3.50	3.90	B	H	1-1/2	7/8	1/16	1-1/4	7/16	1.9
BK47-H	4.45	3.70	4.10	B	H	1-1/2	7/8	1/16	1-1/4	7/16	2.2
BK50-H	4.75	4.00	4.40	B	H	1-1/2	7/8	1/16	1-1/4	7/16	2.2
BK52-H	4.95	4.20	4.60	B	H	1-1/2	7/8	1/16	1-1/4	7/16	2.5
BK55-H	5.25	4.50	4.90	B	H	1-1/2	7/8	1/16	1-1/4	7/16	3.0
BK57-H	5.45	4.70	5.10	B	H	1-1/2	7/8	1/16	1-1/4	7/16	3.2
BK60-H	5.75	5.00	5.40	B	H	1-1/2	7/8	1/16	1-1/4	7/16	3.2
BK62-H	5.95	5.20	5.60	B	H	1-1/2	7/8	1/16	1-1/4	7/16	3.6
BK65-H	6.25	5.50	5.90	B	H	1-1/2	7/8	1/16	1-1/4	7/16	4.0
BK67-H	6.45	5.70	6.10	B	H	1-1/2	7/8	1/16	1-1/4	7/16	4.2
BK70-H	6.75	6.00	6.40	C	H	1-1/2	7/8	1/8	1-1/4	1/2	3.3
BK72-H	6.95	6.20	6.60	C	H	1-1/2	7/8	1/8	1-1/4	1/2	3.6
BK75-H	7.25	6.50	6.90	C	H	1-1/2	7/8	1/8	1-1/4	1/2	3.4
BK77-H	7.45	6.70	7.10	C	H	1-1/2	7/8	1/8	1-1/4	1/2	3.7
BK80-H	7.75	7.00	7.40	C	H	1-1/2	7/8	1/8	1-1/4	1/2	4.0
BK85-H	8.25	7.50	7.90	C	H	1-1/2	7/8	1/8	1-1/4	1/2	4.1
BK90-H	8.75	8.00	8.40	C	H	1-1/2	7/8	1/8	1-1/4	1/2	4.5
BK95-H	9.25	8.50	8.90	C	H	1-1/2	7/8	1/8	1-1/4	1/2	4.8
BK100-H	9.75	9.00	9.40	C	H	1-1/2	7/8	1/8	1-1/4	1/2	5.1
BK105-H	10.25	9.50	9.90	C	H	1-1/2	7/8	1/8	1-1/4	1/2	5.4
BK110-H	10.75	10.00	10.40	C	H	1-1/2	7/8	1/8	1-1/4	1/2	6.0
BK115-H	11.25	10.50	10.90	C	H	1-1/2	7/8	1/8	1-1/4	1/2	6.3
BK120-H	11.75	11.00	11.40	C	H	1-1/2	7/8	1/8	1-1/4	1/2	6.6
BK130-H	12.75	12.00	12.40	C	H	1-1/2	7/8	1/8	1-1/4	1/2	7.2
BK140-H	13.75	13.00	13.40	C	H	1-1/2	7/8	1/8	1-1/4	1/2	8.6
BK150-H	14.75	14.00	14.40	C	H	1-1/2	7/8	1/8	1-1/4	1/2	9.4
BK160-H	15.75	15.00	15.40	C	H	1-1/2	7/8	1/8	1-1/4	1/2	10.1
BK190-H	18.75	18.00	18.40	C	H	1-1/2	7/8	1/8	1-1/4	1/2	12.3

Weights do not include bushings. See page D-202 for additional bushing information.



Two Groove FHP Sheaves MST® Bushed

2BK-H

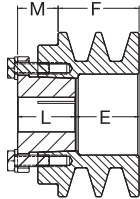

TYPE A
Solid

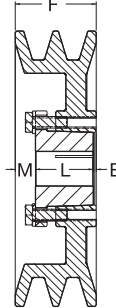

TYPE B
Web

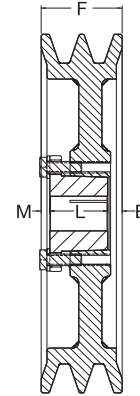

TYPE C
Arm / Spoke

Dimensions in inches, weight in pounds

Part Number	Diameter			Type	Bush	Bush Max. Bore	F	E	L Thru Bore	M	Weight Less Bush
	OD	Datum A(4L) Belts	Datum B(5L) Belts								
2BK32-H	3.35	2.60	3.00	A	H	1 1/2	1 3/4	1 3/8	1 1/4	7/8	2.2
2BK34-H	3.55	2.80	3.20	A	H	1 1/2	1 3/4	1 3/8	1 1/4	7/8	2.6
2BK36-H	3.75	3.00	3.40	A	H	1 1/2	1 3/4	15/16	1 1/4	7/16	2.4
2BK40-H	3.95	3.20	3.60	A	H	1 1/2	1 3/4	15/16	1 1/4	7/16	2.6
2BK45-H	4.25	3.50	3.90	A	H	1 1/2	1 3/4	15/16	1 1/4	7/16	3.1
2BK47-H	4.45	3.70	4.10	B	H	1 1/2	1 3/4	1/16	1 1/4	7/16	3.2
2BK50-H	4.75	4.00	4.40	B	H	1 1/2	1 3/4	1/16	1 1/4	7/16	3.7
2BK52-H	4.95	4.20	4.60	B	H	1 1/2	1 3/4	1/16	1 1/4	7/16	4.1
2BK55-H	5.25	4.50	4.90	B	H	1 1/2	1 3/4	1/16	1 1/4	7/16	4.2
2BK57-H	5.45	4.70	5.10	B	H	1 1/2	1 3/4	1/16	1 1/4	7/16	4.5
2BK60-H	5.75	5.00	5.40	B	H	1 1/2	1 3/4	1/16	1 1/4	7/16	4.9
2BK62-H	5.95	5.20	5.60	B	H	1 1/2	1 3/4	1/16	1 1/4	7/16	5.2
2BK65-H	6.25	5.50	5.90	C	H	1 1/2	1 3/4	5/16	1 1/4	3/16	5.7
2BK67-H	6.45	5.70	6.10	C	H	1 1/2	1 3/4	5/16	1 1/4	3/16	5.8
2BK70-H	6.75	6.00	6.40	C	H	1 1/2	1 3/4	5/16	1 1/4	3/16	6.1
2BK72-H	6.95	6.20	6.60	C	H	1 1/2	1 3/4	5/16	1 1/4	3/16	6.1
2BK80-H	7.75	7.00	7.40	C	H	1 1/2	1 3/4	5/16	1 1/4	3/16	7.4
2BK90-H	8.75	8.00	8.40	C	H	1 1/2	1 3/4	5/16	1 1/4	3/16	8.5
2BK100-H	9.75	9.00	9.40	C	H	1 1/2	1 3/4	5/16	1 1/4	3/16	9.7
2BK110-H	10.75	10.00	10.40	C	H	1 1/2	1 3/4	5/16	1 1/4	3/16	10.9
2BK120-H	11.75	11.00	11.40	C	H	1 1/2	1 3/4	5/16	1 1/4	3/16	12.0
2BK130-H	12.75	12.00	12.40	C	H	1 1/2	1 3/4	5/16	1 1/4	3/16	13.4
2BK140-H	13.75	13.00	13.40	C	H	1 1/2	1 3/4	5/16	1 1/4	3/16	15.3
2BK160-H	15.75	15.00	15.40	C	H	1 1/2	1 3/4	5/16	1 1/4	3/16	17.8
2BK190-H	18.75	18.00	18.40	C	H	1 1/2	1 3/4	5/16	1 1/4	3/16	22.8

Weights do not include bushings. See page D-202 for additional bushing information.

MST "H" Bushings – Inch Bore

Diameter Of Shaft	Keyway Width X Depth	Diameter Of Shaft	Keyway Width X Depth
3/8	NONE	1	1/4 X 1/8
7/16	NONE	1-1/16	1/4 X 1/8
1/2	1/8 X 1/16	1-1/8	1/4 X 1/8
9/16	1/8 X 1/16	1-3/16	1/4 X 1/8
19/32	1/8 X 1/16	1-1/4	1/4 X 1/8
5/8	3/16 X 3/32	1-5/16	5/16 X 1/16
21/32	3/16 X 3/32	1-3/8	5/16 X 1/16
11/16	3/16 X 3/32	1-3/8W	3/8 X 1/16
3/4	3/16 X 3/32	1-7/16	3/8 X 1/16
25/32	3/16 X 3/32	1-1/2	3/8 X 1/32
13/16	3/16 X 3/32		
7/8	3/16 X 3/32		
15/16	1/4 X 1/8		
31/32	1/4 X 1/8		

MST "H" Bushings – Millimeter Bore

Diameter Of Shaft	Keyway Width X Depth	Diameter Of Shaft	Keyway Width X Depth
10	NONE	22	6 X 2.8
11	NONE	24	8 X 3.3
12	NONE	25	8 X 3.3
14	5 X 2.3	28	8 X 3.3
16	5 X 2.3	30	8 X 3.3
18	6 X 2.8	32	10 X 1.3
19	6 X 2.8	35	10 X 0.3
20	6 X 2.8	36	10 X 1.3
		38	10 X 0.3

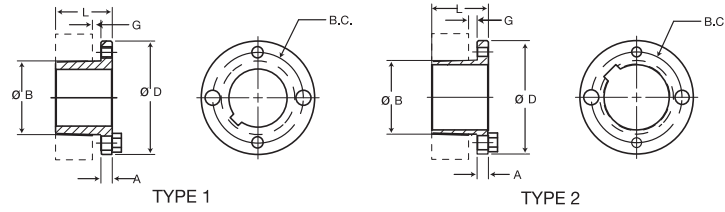

"H" BUSHING

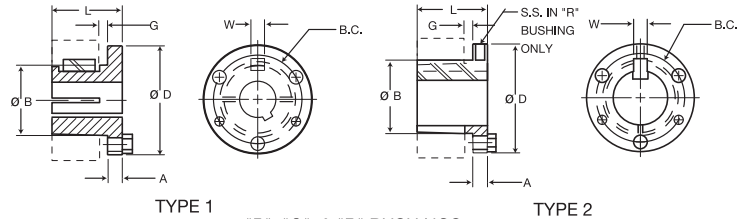

"P", "Q", & "R" BUSHINGS

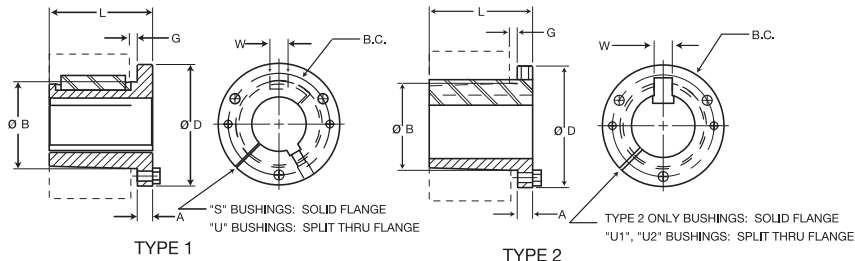

"S" & "U" BUSHINGS

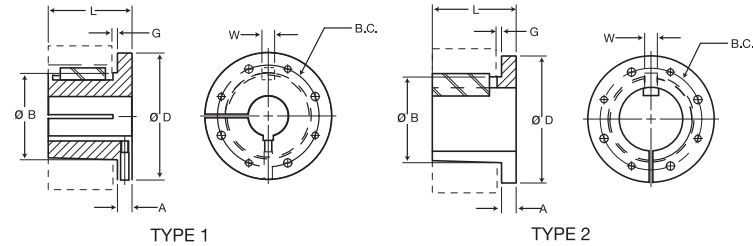

"W" BUSHINGS

Bushing Specifications

Part No.	Dimensions							Stock Bore Range		Cap Screws		Av. Wt. Lbs.	Wrench Torque In. / lbs.
	D	L	A	B Large End	G	B.C.	W	Type 1	Type 2	No.	Size		
H	2.50	1.25	0.25	1.6250	0.19	2.00	—	3/8 - 1-3/8	1-7/16 - 1-1/2	2	1/4X3/4	0.8	95
P1	3.00	1.94	0.41	1.9375	0.22	2.44	0.375	1/2 - 1-7/16	1-1/2 - 1-3/4	3	5/16X1	1.3	192
P2	3.00	2.94	0.41	1.9375	0.22	2.44	0.375	3/4 - 1-7/16	1-1/2 - 1-3/4	3	5/16X1	1.5	192
P3	3.00	4.44	0.41	1.9375	0.22	2.44	0.375	1-1/8 - 1-3/8	1-5/8	3	5/16X1	2	192
Q1	4.12	2.50	0.53	2.8750	0.22	3.38	0.500	3/4 - 2-1/16	2-1/8 - 2-11/16	3	3/8X1-1/4	3.5	348
Q2	4.12	3.50	0.53	2.8750	0.22	3.38	0.500	1 - 2-1/16	2-1/8 - 2-5/8	3	3/8X1-1/4	4.5	348
Q3	4.12	5.00	0.53	2.8750	0.22	3.38	0.500	1-3/8 - 2-1/16	2-1/8 - 2-1/2	3	3/8X1-1/4	5.5	348
R1	5.38	2.88	0.62	4.0000	0.25	4.62	0.750	1-1/8 - 2-13/16	2-7/8 - 3-3/4	3	3/8X1-3/4	7.5	348
R2	5.38	4.88	0.62	4.0000	0.25	4.62	0.750	1-3/8 - 2-13/16	2-7/8 - 3-5/8	3	3/8X1-3/4	11	348
S1	6.38	4.38	0.75	4.6250	0.31	5.38	0.750	1-11/16 - 3-3/16	3-1/4 - 4-1/4	3	1/2X2-1/4	13.5	840
S2	6.38	6.75	0.75	4.6250	0.31	5.38	0.750	1-7/8 - 3-3/16	3-1/4 - 4-3/16	3	1/2X2-1/4	19	840
UO	8.38	5.25	1.06	6.0000	0.44	7.00	1.250	2-3/8 - 3-1/16	—	3	5/8X2-3/4	30	1680
UO	8.38	4.94	0.75	6.0000	0.44	7.00	1.250	3-1/4 - 4-1/4	4-3/8 - 5-1/2	3	5/8X2-3/4	27	1680
U1	8.38	7.12	1.06	6.0000	0.44	7.00	1.250	2-3/8 - 4-1/4	4-3/8 - 5-1/2	3	5/8X2-3/4	40	1680
U2	8.38	10.12	1.06	6.0000	0.44	7.00	1.250	2-7/16 - 4-1/4	4-3/8 - 5	3	5/8X2-3/4	50	1680
W1	12.50	8.25	1.44	8.5000	0.44	10.00	1.250	3-3/8 - 6-3/16	6-1/4 - 7-7/16	4	3/4X3	104	3000
W2	12.50	11.25	1.44	8.5000	0.44	10.00	1.250	3-3/8 - 6-3/16	6-1/4 - 7-7/16	4	3/4X3	133	3000

All tapers are 3/4" per 12" on Dia.

All dimensions are in inches except, as noted.

All bushings are cast iron, ductile iron, sintered steel, or steel. Consult manufacturer for clarification.

Metric bushings also available.

Martin MST BUSHING

INSTALLATION & REMOVAL INSTRUCTIONS

The MST bushings are easy to install and remove. They are split through the barrel and have a taper to provide a true clamp on the shaft. They are keyed to both the shaft and the hub to help during "blind" installations.

INSTALLATION

1. Be sure the tapered cone surfaces of the bushing and the inside of the driven product are clean and free of anti-seize lubricants.
2. Place bushing in sprocket or other *Martin* MST part.
3. Place cap screws loosely in pull-up holes. Bushing remains loose to assure sliding fit on shaft.
4. With key on shaft, slide sprocket to desired position on shaft. Be sure heads of capscrews are accessible.
5. Align sprocket. Tighten screws alternately and progressively - until they are pulled up tight (see table below). Do not use extensions on wrench handles. Do not allow sprocket to be drawn in contact with flange of bushing. There should be a gap between bushing flange and sprocket.

CAUTION: THIS GAP MUST NOT BE CLOSED.

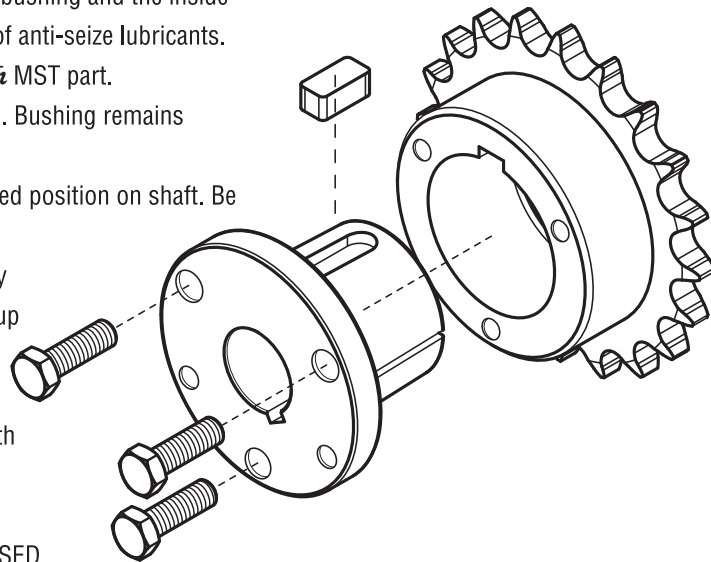

REMOVAL

1. Loosen and remove capscrews.
2. Insert capscrews in tapped removal holes.
3. Tighten inserted screws until sprocket is loose on shaft.
4. Remove sprocket from shaft.

CAUTION

WARNING: USE OF ANTI-SEIZE LUBRICANT ON TAPERED CONE SURFACES OR ON BOLT THREADS WHEN MOUNTING MAY RESULT IN DAMAGE TO SHEAVES AND SPROCKETS. THIS VOIDS ALL MANUFACTURER'S WARRANTIES.

WRENCH TORQUE VALUES FOR TIGHTENING BUSHINGS

MST Bushing Size	Size of Cap Screw	Wrench Torque in. / lbs.
G	1/4 x 5/8	95
H	1/4 x 3/4	95
P	5/16 x 1	192
Q	3/8 x 1-1/4	348
R	3/8 x 1-3/4	348
S	1/2 x 2-1/4	840
U	5/8 x 2-3/4	1680
W	3/4 x 3	3000

WARNING: Because of the possible danger to person(s) or property from accidents which may result from the improper use of products, it is important that correct procedures be followed: Products must be used in accordance with the engineering information specified in the catalog. Proper installation, maintenance and operation procedures must be observed. The instructions given above must be followed. Inspections should be made as necessary to assure safe operation under prevailing conditions. All rotating power transmission products when used in a drive are potentially dangerous and must be guarded by the user as required by applicable laws, regulations, standards, and good safety practice. (Refer to ANSI Standard B15.1.)

Stock Variable Pitch Sheaves

Martin

V-BELT DRIVES



1VP
Bored-To-Size



2VP
Bored-To-Size

- Stationary adjustable speed sheaves.
- Single and double groove designs.
- Full range of popular bore sizes including keyway and setscrew.
- Positive locking system.
- Precision machined grooves.
- Statically balanced.

Call *Martin* for your made-to-order and large quantity requirements.



Single Groove Variable Pitch Sheaves – Bored-To-Size 1VP

V-BELT DRIVES

Keyway Dimensions Inch Bore

Diameter Of Shaft	Keyway Width X Depth
1/2	NONE
5/8 - 7/8	3/16 X 3/32
15/16 - 1-1/4	1/4 X 1/8
1-5/16 - 1-3/8	5/16 X 5/32
1-7/16 - 1-3/4	3/8 X 3/16

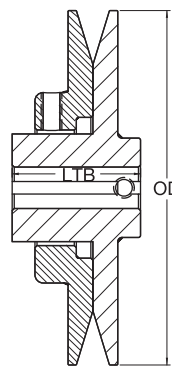

TYPE A

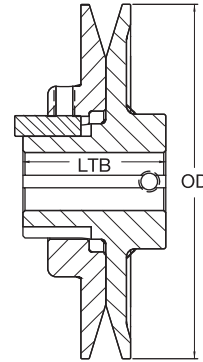

TYPE B

Dimensions in inches

Part Number	Diameters And Turns															
	3L Belts				A or 4L Belts				B or 5L Belts				5V Belts			
	Min. Pitch	Turns Open	Max. Pitch	Turns Open	Min. Datum	Turns Open	Max. Datum	Turns Open	Min. Datum	Turns Open	Max. Datum	Turns Open	Min. Pitch	Turns Open	Max. Pitch	Turns Open
1VP25	1.6	4	2.4	0	-	-	-	-	-	-	-	-	-	-	-	-
1VP30	1.8	4	2.7	0	-	-	-	-	-	-	-	-	-	-	-	-
1VP34	1.9	4	2.8	0	2.0	5	3.0	0	2.3	5	3.2	1	-	-	-	-
1VP40	2.4	4	3.2	0	2.5	5	3.5	0	2.6	6	3.6	1	-	-	-	-
1VP44	2.8	4	3.7	0	2.9	5	3.9	0	3.0	6	4.0	1	-	-	-	-
1VP50	3.4	4	4.2	0	3.5	5	4.5	0	3.6	6	4.6	1	-	-	-	-
1VP56	4.0	4	4.8	0	4.1	5	5.1	0	4.2	6	5.2	1	-	-	-	-
1VP60	-	-	-	-	4.2	5	5.2	0	4.4	6	5.6	0	-	-	-	-
1VP62	4.6	4	5.4	0	4.7	5	5.7	0	4.8	6	5.8	1	5.1	6	6.1	1
1VP65	-	-	-	-	4.7	5	5.7	0	4.9	6	6.1	0	5.1	6	6.3	0
1VP68	5.2	4	6.0	0	5.3	5	6.3	0	5.4	6	6.4	1	5.7	6	6.7	1
1VP71	-	-	-	-	5.3	5	6.3	0	5.5	6	6.7	0	5.7	6	6.9	0
1VP75	-	-	-	-	5.7	5	6.7	0	5.9	6	7.1	0	6.1	6	7.3	0

Dimensions in inches

Part Number	OD	Type	L Thru Bore	Stock Finished Bores Includes Keyway and Setscrew												Wt. Lbs. (Approx.)	
				1/2	5/8	3/4	7/8	1	1-1/8	1-1/4	1-3/8	1-1/2	1-5/8	1-3/4			
1VP25	2.50	A	1-23/32	1/2	-	5/8	-	3/4	-	-	-	-	-	-	-	-	0.8
1VP30	2.87	A	1-11/16	1/2	-	5/8	-	3/4	-	-	-	-	-	-	-	-	1.1
1VP34	3.15	A	1-29/32	1/2	-	5/8	-	3/4	-	7/8	-	-	-	-	-	-	1.4
1VP40	3.75	A	1-7/8	1/2	-	5/8	-	3/4	-	7/8	-	-	-	-	-	-	1.7
1VP44	4.15	A	1-7/8	1/2	-	5/8	-	3/4	-	-	-	-	-	-	-	-	2.4
1VP44	4.15	B	2-3/16	-	-	-	-	-	7/8	-	1	-	1-1/8	-	-	-	3.0
1VP50	4.75	A	2	1/2	-	5/8	-	3/4	-	-	-	-	-	-	-	-	2.7
1VP50	4.75	B	2-5/32	-	-	-	-	-	7/8	-	1	-	1-1/8	-	-	-	3.5
1VP56	5.35	A	1-15/16	1/2	-	5/8	-	3/4	-	-	-	-	-	-	-	-	4.1
1VP56	5.35	B	2-5/32	-	-	-	-	-	7/8	-	1	-	1-1/8	-	-	-	4.4
1VP60	6.00	B	2-7/32	-	5/8	-	3/4	-	7/8	-	1	-	1-1/8	-	-	1-3/8	6.3
1VP62	5.95	B	1-29/32	-	5/8	-	3/4	-	7/8	-	1	-	1-1/8	-	1-1/4	1-3/8	6.1
1VP65	6.50	B	2-7/32	-	-	-	3/4	-	7/8	-	-	-	1-1/8	-	-	1-3/8	7.1
1VP68	6.55	B	1-29/32	-	5/8	-	3/4	-	7/8	-	1	-	1-1/8	-	1-1/4	1-3/8	7.3
1VP71	7.10	B	2-7/32	-	-	-	3/4	-	7/8	-	-	-	1-1/8	-	-	1-3/8	8.2
1VP75	7.50	B	2-7/32	-	-	-	3/4	-	7/8	-	1	-	1-1/8	-	-	1-3/8	9.0

1/2" Bore - setscrew only - no keyway

2VP Two Groove Variable Pitch Sheaves – Bored-To-Size



V-BELT DRIVES

Keyway Dimensions Inch Bore

Diameter Of Shaft	Keyway Width X Depth
1/2	NONE
5/8 - 7/8	3/16 X 3/32
15/16 - 1-1/4	1/4 X 1/8
1-5/16 - 1-3/8	5/16 X 5/32
1-7/16 - 1-3/4	3/8 X 3/16

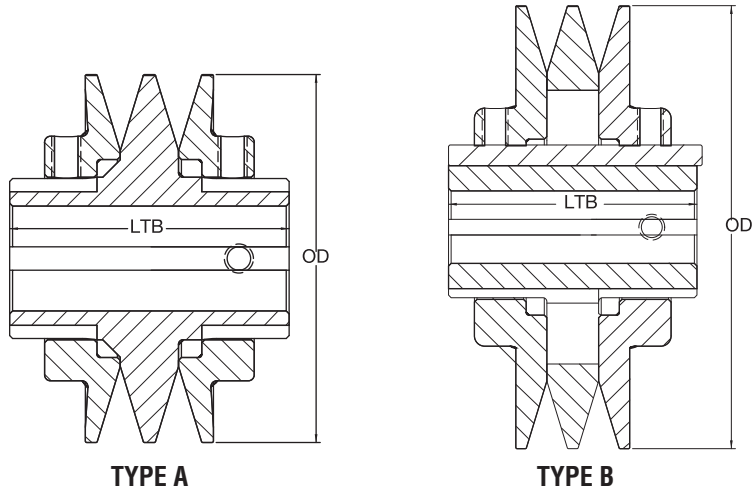

Dimensions in inches

Part Number	Diameters And Turns															
	3L Belts				A or 4L Belts				B or 5L Belts				5V Belts			
	Min. Pitch	Turns Open	Max. Pitch	Turns Open	Min. Datum	Turns Open	Max. Datum	Turns Open	Min. Datum	Turns Open	Max. Datum	Turns Open	Min. Pitch	Turns Open	Max. Pitch	Turns Open
2VP36	2.0	4	2.8	0	2.1	5	3.1	0	2.4	5	3.2	1	-	-	-	-
2VP42	2.6	4	3.4	0	2.7	5	3.7	0	2.8	6	3.8	1	-	-	-	-
2VP50	3.4	4	4.2	0	3.5	5	4.5	0	3.6	6	4.6	1	-	-	-	-
2VP56	4.0	4	4.8	0	4.1	5	5.1	0	4.2	6	5.2	1	-	-	-	-
2VP60	-	-	-	-	4.2	5	5.2	0	4.4	6	5.6	0	-	-	-	-
2VP62	4.6	4	5.4	0	4.7	5	5.7	0	4.8	6	5.8	1	5.1	6	6.1	1
2VP65	-	-	-	-	4.7	5	5.7	0	4.9	6	6.1	0	5.1	6	6.3	0
2VP68	5.2	4	6.0	0	5.3	5	6.3	0	5.4	6	6.4	1	5.7	6	6.7	1
2VP71	-	-	-	-	5.3	5	6.3	0	5.5	6	6.7	0	5.7	6	6.9	0
2VP75	-	-	-	-	5.7	5	6.7	0	5.9	6	7.1	0	6.1	6	7.3	0

Dimensions in inches

Part Number	OD	Type	L Thru Bore	Stock Finished Bores Includes Keyway and Setscrew												Wt. Lbs. (Approx.)	
				1/2	5/8	3/4	7/8	1	1-1/8	1-1/4	1-3/8	1-3/4	1-7/8	2			
2VP36	3.35	A	3	1/2	-	5/8	-	3/4	-	7/8	-	1	-	-	-	-	3.6
2VP42	3.95	A	3	-	5/8	-	3/4	-	7/8	-	1	-	1-1/8	-	-	-	4.5
2VP50	4.75	B	3	-	5/8	-	3/4	-	7/8	-	1	-	1-1/8	-	-	-	6.1
2VP56	5.35	B	3	-	5/8	-	3/4	-	7/8	-	1	-	1-1/8	-	-	-	7.5
2VP60	6.00	B	3-1/4	-	-	-	3/4	-	7/8	-	1	-	1-1/8	-	-	1-3/8	10.9
2VP62	5.95	B	3	-	-	-	3/4	-	7/8	-	1	-	1-1/8	-	-	1-3/8	10.0
2VP65	6.50	B	3-1/4	-	-	-	3/4	-	7/8	-	-	-	1-1/8	-	-	1-3/8	12.5
2VP68	6.55	B	3	-	-	-	3/4	-	7/8	-	1	-	1-1/8	-	1-1/4	-	11.7
2VP71	7.10	B	3-1/4	-	-	-	3/4	-	7/8	-	-	-	1-1/8	-	-	1-3/8	14.7
2VP75	7.50	B	3-1/4	-	-	-	3/4	-	7/8	-	1	-	1-1/8	-	-	1-3/8	16.3

1/2" Bore - setscrew only - no keyway

Mounting and Adjusting Procedure

Single Groove Sheaves Without External Key:

Mounting:

1. Make sure that the shaft, sheave bore, key and keyway are free of burrs and paint.
2. All sheaves should be mounted on the motor or driving shaft with the end containing the setscrew "R" toward the motor. Be sure setscrew "R" is well over the shaft.
3. Fit shaft key "C" between sheave and shaft. Lock setscrew "R" in place. Wrench torque 110 in.-lb. minimum – 130 in.-lb. maximum.
4. Be sure both driving and driven sheaves are in alignment and that shafts are parallel.
5. Total axial and parallel misalignment must not exceed $\frac{1}{4}^\circ$.

Adjusting:

1. Loosen setscrew "V" in movable flange of sheave.
2. Adjust sheave pitch diameter for desired speed by opening rotating parts by half or full turn increments from closed position. **Do not open more than five full turns for "A" belts or six full turns for "B" belts.**
3. Tighten setscrew "V" over a flat in the hub to 110 to 130 in.-lb.
4. Put on belts and adjust belt tension. (Do not force belts over grooves.)
5. Future adjustments should be made by loosening the belt tension and increasing or decreasing the pitch diameter of the sheave by half or full turns as required. Readjust belt tension before starting drive.
6. Be sure that key is in place and that all setscrews are torqued properly before starting drive. Check setscrews and belt tension after 24 hours of service.

Do not operate sheave with flange projecting beyond the hub end.

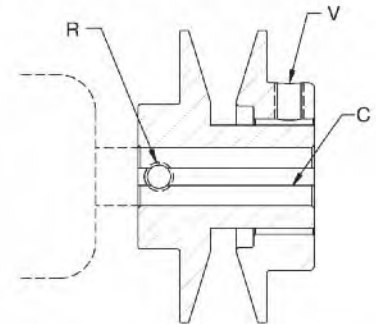

Single Groove Sheaves With External Key:

Key "H" projects to provide a grip for removal.

Do not operate sheave with flange projecting beyond the hub end.

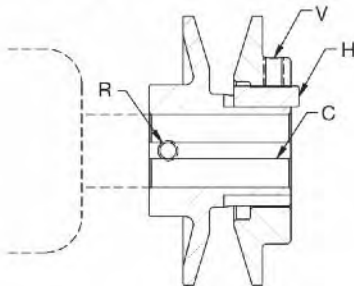

Mounting:

1. Make sure that the shaft, sheave bore, keys and keyways are free of burrs and paint.
2. All sheaves should be mounted on the motor or driving shaft with the end containing the setscrew "R" toward the motor. Be sure setscrew "R" is well over the shaft.
3. Fit shaft key "C" between sheave and shaft. Lock setscrew "R" in place. Wrench torque 110 in.-lb. minimum – 130 in.-lb. maximum.
4. Be sure both driving and driven sheaves are in alignment and that shafts are parallel.
5. Total axial and parallel misalignment must not exceed $\frac{1}{4}^\circ$.

Adjusting:

1. Loosen setscrew "V" in movable flange of sheave and pull out external key "H". (This key projects a small amount to provide a grip for removal.)
2. Adjust sheave pitch diameter for desired speed by opening rotating parts by half or full turn increments from closed position. **Do not open more than five full turns for "A" belts or six full turns for "B" belts. (Except 1VP34 - 5 turns.)**
3. Replace key "H" and tighten setscrew "V" to 110 to 130 in.-lb.
4. Put on belts and adjust belt tension. (Do not force belts over grooves.)
5. Future adjustments should be made by loosening the belt tension and increasing or decreasing the pitch diameter of the sheave by half or full turns as required. Readjust belt tension before starting drive.
6. Be sure that all keys are in place and that all setscrews are torqued properly before starting drive. Check setscrews and belt tension after 24 hours service.

WARNING: Because of the possible danger to person(s) or property from accidents which may result from the improper use of products, it is important that correct procedures be followed: Products must be used in accordance with the engineering information specified in the catalog. Proper installation, maintenance and operation procedures must be observed. The instructions given above must be followed. Inspections should be made as necessary to assure safe operation under prevailing conditions. All rotating power transmission products when used in a drive are potentially dangerous and must be guarded by the user as required by applicable laws, regulations, standards, and good safety practice. (Refer to ANSI Standard B15.1.)

Variable Pitch Sheaves Instructions

Martin

Mounting and Adjusting Procedure

Double Groove Sheaves With External Key:

Mounting:

1. Make sure that the shaft, sheave bore, keys and keyways are free of burrs and paint.
2. Remove key "H" from sheave. Unscrew flanges until setscrew "R" is visible. If setscrew "R" is at an angle, flange may have to be removed in order to tighten it.
3. All sheaves should be mounted on the motor or driving shaft with the end containing the setscrew "R" toward the motor. If setscrew "R" is at an angle, mount away from motor.
4. Fit shaft key "C" between sheave and shaft, and lock setscrew "R" in place. Wrench torque 110 in.-lb. minimum - 130 in.-lb. maximum. Replace outboard flange.
5. Be sure the center flange of both the driving and driven sheaves are in alignment and shafts are parallel.
6. Total axial and parallel misalignment must not exceed $\frac{1}{4}^{\circ}$.

Adjusting:

Each flange of the sheave has a small notch on the O.D. of the flange. This mark is located directly over the keyway on the two adjustable flanges and over one of the keyways on the non-adjustable (center) flange. To obtain proper adjustments:

1. Loosen setscrews "V" in moving flanges and pull out key "H". (This key projects a small amount to provide a grip for removal.)
2. Rotate both movable flanges inward until they touch the center flange.
3. Locate the notch over the keyway on the center flange.
4. Open each movable flange until its notch is adjacent to the notch on the center flange. Be certain that neither movable flange is opened more than one full turn.
5. From the position obtained in Step 4, open each movable flange the same number of full or half turns until the desired number of turns is obtained. **Do not open more than five full turns for "A" belts or six full turns for "B" belts. (Except 2VP36 - 5 turns.)**
6. Replace key "H" and tighten setscrews "V". Wrench torque 110 in.-lb. minimum to 130 in.-lb. maximum.
7. Put on belts and adjust belt tension. (Do not force belts over flanges.)
8. Future adjustments should be made by loosening the belt tension and increasing or decreasing the pitch diameter of the sheave by half or full turns as required. Readjust belt tension before starting drive.
9. Two groove sheaves must have both halves adjusted by the same number of turns from the position established in Step 4 to ensure the same pitch diameter.
10. Be sure that all keys are in place and that all setscrews are torqued properly before starting drive. Check setscrews and belt tension after 24 hours service.

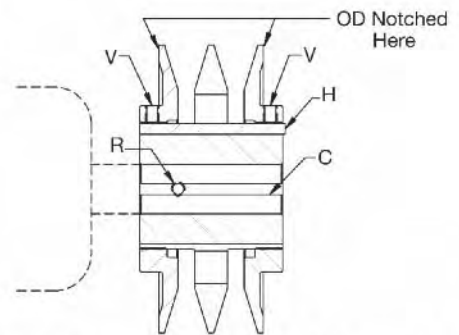

Key "H" projects to provide a grip for removal.
Do not operate sheave with flange projecting beyond the hub end.

WARNING: Because of the possible danger to person(s) or property from accidents which may result from the improper use of products, it is important that correct procedures be followed: Products must be used in accordance with the engineering information specified in the catalog. Proper installation, maintenance and operation procedures must be observed. The instructions given above must be followed. Inspections should be made as necessary to assure safe operation under prevailing conditions. All rotating power transmission products when used in a drive are potentially dangerous and must be guarded by the user as required by applicable laws, regulations, standards, and good safety practice. (Refer to ANSI Standard B15.1.)

ROLLER CHAIN SPROCKETS

PRODUCT	PAGE
INDEX.....	E-1 - E-2
MADE-TO-ORDER CAPABILITIES.....	E-3
SECTION I – STANDARD SPROCKETS.....	E-4 - E-112
Shear Pin Sprockets, Bolt-On.....	E-4 - E-6
Type D Sprockets, Detachable Hubs Split and Solid	E-7
Instant Split® Sprockets.....	E-8
Torque Limiter.....	E-9 - E-10
Double Pitch Sprockets.....	E-11 - E-15
Double Single Sprockets.....	(See Pitch Below)
Sprockets, Stock.....	E-16 - E-112
No. 25 – ¼" pitch	E-16 - E-17
No. 35 – ⅜" pitch	E-18 - E-26
No. 41 – ½" pitch	E-27 - E-29
No. 40 – ½" pitch	E-30 - E-42
No. 50 – ⅝" pitch	E-43 - E-55
No. 60 – ¾" pitch	E-56 - E-68
No. 80 – 1" pitch	E-69 - E-81
No. 100 – 1¼" pitch	E-82 - E-91
No. 120 – 1½" pitch	E-92 - E-97
No. 140 – 1¾" pitch	E-98 - E-102
No. 160 – 2" pitch	E-103 - E-107
No. 180 – 2¼" pitch	E-108
No. 200 – 2½" pitch	E-109 - E-111
No. 240 – 3" pitch	E-112
SECTION II – METRIC SPROCKETS.....	E-113 - E-151
ISO - 06B-1, Metric 35 - 0.375 in. (9.525mm) Pitch, Simplex	E-114 – E-115
ISO - 06B-2, Metric 35-2 - 0.375 in. (9.525mm) Pitch, Duplex.....	E-116 – E-117
ISO - 06B-3, Metric 35-3 - 0.375 in. (9.525mm) Pitch, Triplex	E-118
ISO - 08B-1, Metric 40 - 0.500 in. (12.70mm) Pitch, Simplex	E-119 – E-120
ISO - 08B-2, Metric 40-2 - 0.500 in. (12.70mm) Pitch, Duplex	E-121 – E122
ISO - 08B-3, Metric 40-3 - 0.500 in. (12.70mm) Pitch, Triplex	E-123
ISO - 10B-1, Metric 50 - 0.625 in. (15.88mm) Pitch, Simplex	E-124 – E-125
ISO - 10B-2, Metric 50-2 - 0.625 in. (15.88mm) Pitch, Duplex.....	E-126 – E-127
ISO - 10B-3, Metric 50-3 -0.625 in. (15.88mm) Pitch, Triplex	E-128
ISO - 12B-1, Metric 60 - 0.750 in. (19.05mm) Pitch, Simplex	E-129 – E-130
ISO - 12B-2, Metric 60-2 - 0.750 in. (19.05mm) Pitch, Duplex	E-131 – E-132
ISO - 12B-3, Metric 60-3 - 0.750 in. (19.05mm) Pitch, Triplex	E-133
ISO - 16B-1, Metric 80 - 1.000 in. (25.40mm) Pitch, Simplex	E-134 – E-135

ROLLER CHAIN SPROCKETS

PRODUCT	PAGE
SECTION II – METRIC SPROCKETS (continued)	
ISO - 16B-2, Metric 80-2 - 1.000 in. (25.40mm) Pitch, Duplex.....	E-136 – E-137
ISO - 16B-3, Metric 80-3 - 1.000 in. (25.40mm) Pitch, Triplex	E-138
ISO - 20B-1, Metric 100 - 1.250 in. (31.75mm) Pitch, Simplex	E-139 – E-140
ISO - 20B-2, Metric 100-2 - 1.250 in. (31.75mm) Pitch, Duplex	E-141
ISO - 20B-3, Metric 100-3 - 1.250 in. (31.75mm) Pitch, Triplex	E-142
ISO - 24B-1, Metric 120 - 1.500 in. (38.10mm) Pitch, Simplex	E-143 – E-144
ISO - 24B-2, Metric 120-2 - 1.500 in. (38.10mm) Pitch, Duplex	E-145
ISO - 28B-1, Metric 140 - 1.750 in. (44.45mm) Pitch, Simplex	E-146 – E-147
ISO - 28B-2, Metric 140-2 - 1.750 in. (44.45mm) Pitch, Duplex	E-148
ISO - 32B-1, Metric 160 - 2.00 in. (50.80mm) Pitch, Simplex	E-149 – E-150
ISO - 32B-2, Metric 160-2 - 2.00 in. (50.80mm) Pitch, Simplex.....	E-151
 SECTION III – ENGINEERING	 E-152 – E-192
Sprocket Nomenclature.....	E-153 – E-155
Roller Chain Dimensions.....	E-156
Sprocket Tooth Dimensions.....	E-157
Maximum Bore and Hub Size	E-158 – E-159
Sprocket Selection	E-160– E-163
Sprocket Engineering	E-164 – E-166
Hardening.....	E-167
Chain Drive Engineering	E-168 – E-169
Roller Chain Lengths.....	E-169
Speed Ratios.....	E-170
Sprocket Diameters.....	E-171 – E-183
Horsepower Ratings.....	E-184 – E-192



Multi-Strand Oil Field Sprocket with Clutch Jaws



Triple 160 Shaft Sprocket



Quadruple 160 Sprocket



Triple 200 Sprocket



Double 200 Sprocket and Pinion



Large Triple Strand Sprocket with Mounting Flange



Sprocket with Mud Relief



Standard RC Sprocket with Spline Bore



Special Dryer Sprocket



Special Plastic Sprocket



Block Chain

Martin manufactures numerous Made-To-Order (MTO) sprockets. If you do not see the sprocket you need in this section, call us. Chances are if chain runs on it, we have made the sprocket before. Special materials, special bores, duplex, triplex, double-single-doubles, etc. are all familiar to *Martin*.

Bolt-On Shear Pin Sprockets



Shear Pin sprockets provide simple, dependable protection against expensive machinery damage caused by overloads or jamming. Torque is transmitted by a single pin, necked to shear when the safe load is exceeded. When an overload occurs, the pin shears, disconnecting the drive immediately.

The Bolt-on Shear Pin Adapter converts any plate sprocket into a stock Shear Pin sprocket allowing immediate delivery of stock Shear Pin sprockets.

Selection guide on page E-6 gives complete procedure to select the proper Shear Pin assembly.



SPROCKETS

Stock Shear Pin Assemblies

Shear Pin Assembly Number	Hub Bore Range	Shear Pin Hub	Shear Pin Adapter
		Catalog Number	Catalog Number
SP-17	1" & UNDER	SPH-17	SPA-17
SP-18	1 ¹ / ₆ -1 ¹ / ₄	SPH-18	SPA-18
SP-19	1 ¹ / ₆ -1 ¹ / ₂	SPH-19	SPA-19
SP-20	1 ¹ / ₆ -1 ³ / ₄	SPH-20	SPA-20
SP-21	1 ¹ / ₆ -2	SPH-21	SPA-21
SP-22	2 ¹ / ₆ -2 ¹ / ₄	SPH-22	SPA-22
SP-23	2 ¹ / ₆ -2 ¹ / ₂	SPH-23	SPA-23
SP-24	2 ¹ / ₆ -2 ³ / ₄	SPH-24	SPA-24
SP-25	2 ³ / ₆ -3	SPH-25	SPA-25
SP-26	3 ¹ / ₆ -3 ¹ / ₄	SPH-26	SPA-26
SP-27	3 ¹ / ₆ -4	SPH-27	SPA-27
SP-28	4 ¹ / ₆ -4 ¹ / ₂	SPH-28	SPA-28
SP-29	4 ¹ / ₆ -5	SPH-29	SPA-29
SP-30	4 ¹ / ₆ -5 ¹ / ₂	SPH-30	SPA-30
SP-31	5 ¹ / ₆ -6	SPH-31	SPA-31

Notes on Pricing:

Shear Pin Hub List Price includes any finished bore within the stated range, standard keyway, setscrew, and hardened steel shear pin bushing.

Shear Pin Adapter List Price includes the Shear Pin bushin and grease fitting.

Complete Assembly List Price includes all components of the Shear Pin assembly as described above. Total list price of any Shear Pin sprocket is the complete assembly list price plus the list price of the desired plate sprocket (from tables of stock sprocket list prices).

Replacement Sprockets should be priced as altered stock sprockets directly from List Price and Alteration Charge tables.

Shear Pin Components may be ordered separately and will be treated as stock items when conforming to standard specifications and descriptions above.

Pricing Examples:

1. Stock Shear Pin Sprocket

To price a 35 tooth shear pin sprocket for 160 chain (160SP35) using SP-26 shear pin assembly with 3¹/₆" bore, standard keyway and setscrew:

SP-26 Assembly List Price.....
160A35 List Price
Total List Price

**See List
Price Sheet**

2. Shear Pin Adapter and Sprocket for Existing Hub

To price a "Bolt-on" shear pin adapter and sprocket to replace the sprocket part of existing 50SP40 using SP-19 hub:

SPA-19 Adapter List Price.....
50A40 List Price
Total List Price

**See List
Price Sheet**

Shear Pin Sprockets can also be furnished in other standard styles or made to customer's specifications. Price on application.

It is important that the torque requirement for the selected hub be checked in the torque rating table on page E-6 and the neck diameter of Shear Pin be specified.

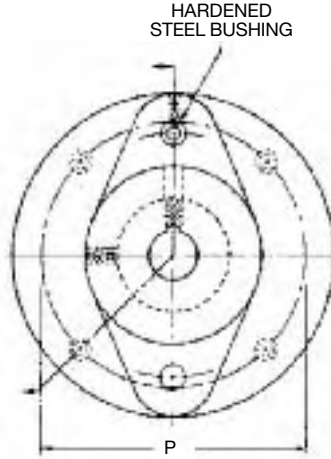
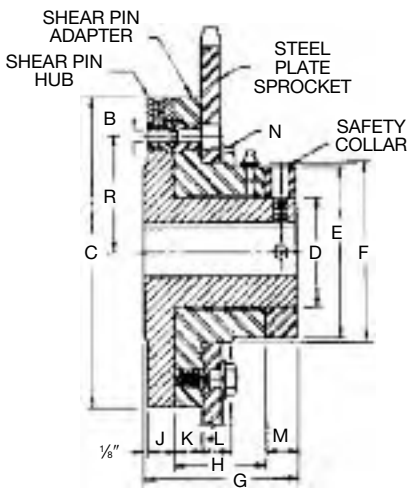

SPROCKETS

Shear Pin Assembly Dimensions (Inches)

Table I

Shear Pin Assembly Number	Shear Pin		Diameters				Length Thru			Hub Flange Thickness	Adapt. Flange Thickness	Sprocket Seat Width	Bolts		Weights (lbs.)	
	Radius	Pin Dia.	Flange	Shear Pin Hub	Adapt. Hub & Collar	Sprocket Seat	Shear Pin Hub	Adapt.	Collar				Number & Size	Bolt Circle	Shear Pin Hub	Shear Pin Adapt.
	R	B	C	D	E	F	G	H	M				J	K	L	N
SP-17	1 ¹ / ₁₆	¼	5¼	1¼	2½	2¾	2 ¹ / ₁₆	1¼	¾	¾	¾	7 ₁₆	4-¾"	4	2.7	3.2
SP-18	2 ¹ / ₁₆	¼	6	2¼	3¼	3¾	2 ¹ / ₁₆	1¼	½	¾	¾	¾	4-¾"	4¼	4.6	4.7
SP-19	2 ¹ / ₁₆	¾	6¾	2¼	4	4¾	3 ¹ / ₁₆	2¼	¾	1 ¹ / ₁₆	1 ¹ / ₁₆	1 ¹ / ₁₆	4-½"	5½	7.2	7.6
SP-20	3	¾	7¾	3¼	4¾	4¾	4 ³ / ₁₆	2½	¾	1 ³ / ₁₆	1 ³ / ₁₆	1 ¹ / ₁₆	4-½"	6¼	11.0	11.9
SP-21	3 ³ / ₁₆	7 ₁₆	8¾	3¾	5¼	5¾	4 ¹ / ₁₆	2¾	¾	1 ³ / ₁₆	1 ³ / ₁₆	1 ³ / ₁₆	4-¾"	7	16.2	16.9
SP-22	3 ³ / ₁₆	½	9¾	4¼	6¼	6¾	5 ¹ / ₁₆	3	1	1 ¹ / ₁₆	1 ¹ / ₁₆	1 ¹ / ₁₆	4-¾"	8	23.3	24.5
SP-23	4	½	10	4½	6½	6¾	5 ¹ / ₁₆	3½	1	1 ¹ / ₁₆	1 ¹ / ₁₆	1¾	4-¾"	8¼	26.3	27.7
SP-24	4¾	¾	11½	5	7	7¾	6 ¹ / ₁₆	3¾	1¼	1 ³ / ₁₆	1 ³ / ₁₆	1¾	4-¾"	9¼	40.4	38.6
SP-25	4¾	¾	12½	5½	8	8¾	6 ⁵ / ₁₆	4¼	1¼	1 ³ / ₁₆	1 ³ / ₁₆	1¾	6-¾"	10¼	52.6	53.6
SP-26	5 ⁵ / ₁₆	1 ¹ / ₁₆	13½	6¼	8¾	8¾	7 ¹ / ₁₆	4¾	1¾	1 ¹ / ₁₆	1 ¹ / ₁₆	1¾	6-¾"	11¼	66.7	66.8
SP-27	6 ¹ / ₁₆	¾	15½	7	10	10¾	8 ¹ / ₁₆	5½	1½	1 ¹ / ₁₆	1 ¹ / ₁₆	1¾	6-¾"	12¼	96.5	100.0
SP-28	6 ¹ / ₁₆	¾	16¼	7¾	10¾	10¾	9 ¹ / ₁₆	6¾	1½	1 ¹ / ₁₆	1 ¹ / ₁₆	1¾	6-¾"	13½	125.0	115.0
SP-29	7¾	¾	17½	8½	12	12½	10 ¹ / ₁₆	7	1¾	1 ¹ / ₁₆	1 ¹ / ₁₆	1¾	6-1"	14¾	160.0	150.0
SP-30	8¼	1	20¼	9¾	13¾	13¾	11 ¹ / ₁₆	7¾	2	2 ¹ / ₁₆	1 ¹ / ₁₆	1¾	6-1"	17	215.0	207.0
SP-31	8¾	1¼	22½	10¾	15	15¾	12 ¹ / ₁₆	8¾	2¼	2 ¹ / ₁₆	1 ¹ / ₁₆	1¾	6-1"	18¾	318.0	265.0

NOTE: Shear Pin "Pin" length equals 2 x "J" dimension.

Sprocket Sizes For Stock Shear Pin Assemblies

Table II

Shear Pin Assembly Number	Hub Bore Range	Minimum Number of Teeth for Single Sprockets													
		Chain Number													
		35	41	40	50	60	80	100	120	140	160	180	200	240	
SP-17	1" & UNDER	48	37	37	30	26	—	—	—	—	—	—	—	—	
SP-18	1 ¹ / ₁₆ -1¼	55	42	42	34	29	23	—	—	—	—	—	—	—	
SP-19	1 ¹ / ₁₆ -1½	61	46	47	38	32	25	21	—	—	—	—	—	—	
SP-20	1 ¹ / ₁₆ -1¾	69	53	53	43	36	28	23	—	—	—	—	—	—	
SP-21	1 ¹ / ₁₆ -2	78	59	59	48	41	31	26	22	19	—	—	—	—	
SP-22	2 ¹ / ₁₆ -2¼	86	65	66	53	45	34	28	24	21	19	17	—	14	
SP-23	2 ¹ / ₁₆ -2½	89	67	67	55	46	35	29	25	22	19	18	16	14	
SP-24	2 ¹ / ₁₆ -2¾	101	76	77	62	52	40	33	28	24	22	20	18	16	
SP-25	2 ¹ / ₁₆ -3	110	83	83	67	56	43	35	30	26	23	21	19	17	
SP-26	3 ¹ / ₁₆ -3½	—	98	98	72	61	46	38	32	28	25	23	20	18	
SP-27	3 ¹ / ₁₆ -4	—	102	102	82	69	53	43	36	32	28	25	23	20	
SP-28	4 ¹ / ₁₆ -4½	—	107	107	86	72	55	45	38	33	29	26	24	21	
SP-29	4 ¹ / ₁₆ -5	—	—	—	92	77	59	48	40	35	31	28	26	22	
SP-30	5 ¹ / ₁₆ -5½	—	—	—	106	89	68	55	46	40	35	32	29	25	
SP-31	5 ¹ / ₁₆ -6	—	—	—	—	98	75	61	51	44	39	35	32	27	

Bolt-On Shear Pin Sprockets



Shear Pin Sprocket Selection

1. The shear pin assembly required is determined by the shaft size. Select the smallest shear pin assembly which will accommodate the required bore. Table on page E-5 contains the bore ranges and minimum sprocket sizes which allow chain clearance over the shear pin assembly flange.
2. Using one of the following formulas, compute the torque load the pin must transmit and find the value in the torque rating table below to obtain the proper shear pin neck diameter.

$$T = \frac{HP \times 63,025 \times 1.5}{RPM} \quad \text{or} \quad T = \frac{D \times CP \times 1.5}{2}$$

or T = Output of reducer x speed ratio of chain drive x 1.5

Where: T = Torque in pound inches
 HP = Horsepower at Sprocket
 RPM = Sprocket Speed
 D = Pitch Diameter of Sprocket
 CP = Chain pull in pounds
 1.5 = Safety factor for starting load

Example:

1. Determine the shear pin assembly and pin neck diameter to transmit 20 horsepower at 67 RPM with a 45 tooth, No. 100 sprocket on a 2^{15/16}" shaft.

(1) Referring to Table I (page E-5), shear pin assembly SP-25 is required for a 2^{15/16}" bore. The 45 tooth sprocket is well above the minimum size.

(2) Torque and neck diameter:

$$T = \frac{HP \times 63,025 \times 1.5}{RPM}$$

$$T = \frac{20 \times 63,025 \times 1.5}{67} = 28,200 \text{ lb. in.}$$

Referring to Table II (page E-5) under SP-25, a pin necked to 3/8" shows a torque rating of 29,810 lb. in., which exceeds the 28,200 lb. in. required.

(3) Order: 100SP45, SP-25 assembly with 2^{15/16}" bore and 3/8" pin neck diameter.

Shear Pin Torque Ratings

Shear Pin Neck Diameter (inches)	TORQUE RATING — POUND INCHES															
	Shear Pin Hub Number															
	SP17	SP18	SP19	SP20	SP21	SP22	SP23	SP24	SP25	SP26	SP27	SP28	SP29	SP30	SP31	
1/32	728	875	1022	1204	1323	1556	1603									
1/16	1248	1500	1752	2064	2268	2616	2748									
3/32	1976	2375	2774	3268	3591	4142	4351	4750								
1/8	2808	3375	3942	4944	5103	5886	6183	6750	7317							
5/32	3848	4625	5402	6364	6993	8066	8473	9250	10027							
3/16	5200	6250	7300	8600	9450	10900	11450	12500	13550	15200	17300	18400				
7/32			9052	10664	11718	13516	14198	15500	16802	18848	21452	22816				
1/4			11096	13072	14364	16568	17403	19000	20596	23140	26296	27968	30932			
5/16				15824	17388	20056	21068	23000	24932	27968	31832	33856	37440			
3/8				18920	20790	23980	25190	27500	29810	33440	38060	40480	44770	51040		
7/16					24570	28340	29170	32500	35230	39520	44980	47840	52910	60320		
1/2					28350	32700	34350	37500	41650	45600	51900	55200	61050	69600		
5/8						37060	38930	42500	46070	51680	58820	62560	69190	78880		
3/4						42728	44884	49000	53116	59584	67816	72128	79772	90944		
7/8								55000	59620	66880	76120	80960	89540	102080		
1 1/8								62000	67280	75392	85808	91264	100936	115072		
1 1/4									73220	82080	93420	99360	109890	125280	136890	
1 1/2									82800	92720	105530	112240	124135	141520	154635	
1 3/4										103360	117640	126120	138380	157760	172380	
2										112480	128020	136160	150590	171680	187590	
2 1/4											138400	147200	162800	185600	202800	
2 1/2											152240	161920	179080	204160	223080	
2 3/4													195360	222720	243360	
3													211640	241280	263640	
3 1/4													227920	259840	283920	
3 1/2													244200	278400	304200	
3 3/4														296960	324480	
4														301600	329550	
4 1/4														338720	370110	
4 1/2														371200	405600	
4 3/4															446160	
5															507000	

Type D Sprockets — Stock Detachable Hubs

Type D sprockets consist of a Type A plate sprocket bolted to a detachable hub. A solid or split plate sprocket may be assembled to a solid or split hub. When ordering a Type D sprocket, be sure to select a plate sprocket large enough to allow chain clearance over the hub flange diameter, dimension D.

Bolt holes of Type D hubs are drilled for interchangeability. Speed ratios may be changed simply by removing the plate sprocket and substituting another with a different number of teeth. When worn, the sprocket may be reversed to use the unworn tooth surfaces, increasing the life of the sprocket.

Split Hubs-Cast Iron — Dimensions (Inches)

Hub Number	Bore Range A		Hub Diameter B	Bolt Circle C	Flange Diameter D	Bolt Holes		E	F	L	Wt. Lbs.
	Stock	*Maximum				Number	Bolt Size				
102S	1 ¹ / ₁₆	1 ¹ / ₂	3	4	5	4	7 ¹ / ₁₆	1 ¹ / ₂	1 ¹ / ₂	3 ¹ / ₂	7.7
103S	1 ¹ / ₁₆	2 ¹ / ₄	4	5 ¹ / ₁₆	6	4	1/2	2	1 ¹ / ₂	3 ¹ / ₂	14.5
104S	2 ¹ / ₁₆	2 ¹ / ₂	4 ¹ / ₂	5 ¹ / ₂	7	4	3/8	2 ¹ / ₄	1 ¹ / ₂	4	18.3
105S	2 ¹ / ₁₆	2 ³ / ₄	5	6 ¹ / ₄	7 ¹ / ₂	4	3/8	2 ¹ / ₄	1 ¹ / ₂	4 ¹ / ₂	23.6
106S	2 ¹ / ₁₆	3 ¹ / ₄	5 ¹ / ₂	7	8 ¹ / ₂	4	3/8	2 ¹ / ₂	2	4 ¹ / ₂	28.2
107S	3 ¹ / ₁₆	3 ¹ / ₂	6	7 ¹ / ₂	9	4	3/8	3	1 ¹ / ₂	4 ¹ / ₂	37.4
108S	3 ¹ / ₁₆	4	7	8 ¹ / ₂	10 ¹ / ₂	4	3/4	3 ¹ / ₂	1 ¹ / ₂	5 ¹ / ₂	55.1
109S	4 ¹ / ₁₆	6	10 ¹ / ₂	13	15 ¹ / ₂	4	1	4 ¹ / ₂	1 ¹ / ₂	5 ¹ / ₂	155.0

*Maximum bores shown are maximum bores with standard keyseat and setscrew.

To obtain the price of a complete Type D sprocket, add the list price of hub, plus alteration charges and the list price of the desired Type A plate sprocket, including rebore, bolt hole drilling, and splitting charge if desired. These hubs may also be used with Accu-Torch Sprockets.

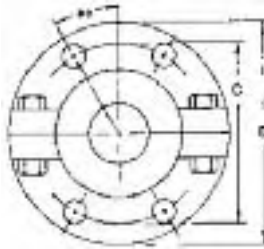
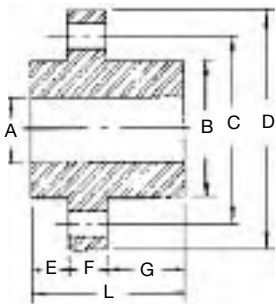

Alteration Charges

See current discount sheet for alteration charges.

Solid Hubs-Steel — Dimensions (Inches)

Hub Number	Bore Range A		Hub Diameter B	Bolt Circle C	Flange Diameter D	Bolt Holes		E	F	G	L	Wt. Lbs.
	Stock	*Maximum				Number	Bolt Size					
101	3/8	1 ¹ / ₂	2 ¹ / ₂	3 ³ / ₈	4 ¹ / ₄	6	3/8	1/2	3/8	1 ¹ / ₂	2	3.4
102	1 ¹ / ₁₆	2	3	4	5	6	7 ¹ / ₁₆	1/2	1/2	1 ¹ / ₂	2 ¹ / ₂	5.4
103	1 ¹ / ₁₆	2 ¹ / ₂	4	5 ¹ / ₁₆	6	6	1/2	1/2	3/8	1 ¹ / ₂	2 ¹ / ₂	10.2
104	2 ¹ / ₁₆	3	4 ¹ / ₂	5 ¹ / ₂	7	6	3/8	1/2	3/8	2	3 ¹ / ₄	14.2
105	2 ¹ / ₁₆	3 ¹ / ₄	5	6 ¹ / ₄	7 ¹ / ₂	6	3/8	3/8	1 ¹ / ₁₆	2 ¹ / ₂	4	22.2
106	2 ¹ / ₁₆	3 ¹ / ₄	5 ¹ / ₂	7	8 ¹ / ₂	6	3/8	3/8	1	2 ¹ / ₂	4	28.4
107	3 ¹ / ₁₆	4	6	7 ¹ / ₂	9	6	3/8	3/8	1 ¹ / ₂	2 ¹ / ₂	4 ¹ / ₂	34.7
108	3 ¹ / ₁₆	4 ¹ / ₂	7	8 ¹ / ₂	10 ¹ / ₂	6	3/4	3/8	1 ¹ / ₂	2 ¹ / ₂	4 ¹ / ₂	52.4
109	4 ¹ / ₁₆	7	10 ¹ / ₂	13	15 ¹ / ₂	6	1	3/4	1 ¹ / ₂	2 ¹ / ₂	5	143.0

*Maximum bores shown are maximum bores with standard keyseat and setscrew.

All Steel Instant Split[®] Sprocket



Manufactured from stock plate sprockets, *Martin's* Instant Split-Sprocket offers unlimited design and is simply installed with a hand wrench . . . greatly reducing costly downtime.



Single-Style B and C — Steel-Instant Split-Sprocket

Hub Number	Bore	Hub O.D.	Hub* Length	Bolts	Wt. Lbs.
S-1	3/4"-1 1/2"	3 3/8"	1"	3/8" x 2 1/4"	1.8
S-2	1 3/8"-2 1/4"	4 5/8"	1 1/4"	1/2" x 3"	4.1
S-3	2"-3"	6"	1 3/8"	5/8" x 4 1/2"	8.4
S-4	2 3/4"-4"	7 5/8"	1 1/2"	3/4" x 5 1/2"	14.4
S-5	3 3/4"-5"	9 1/4"	2"	1" x 6"	27.8
S-6	4 3/4"-6"	10 1/4"	2 1/4"	1" x 6"	35.4
S-7	5 3/4"-7"	12 1/2"	2 1/2"	1" x 7"	64.4
S-8	6 3/4"-8"	14 1/2"	3"	1" x 8"	98.5

*Add hub length to plate thickness to determine length thru bore.

For style C, add hub length x 2.

SPROCKETS

TOTAL LIST PRICE OF *Martin* SPLIT-SPROCKET IS SIMPLY THE HUB PRICE PLUS THE PLATE PRICE.

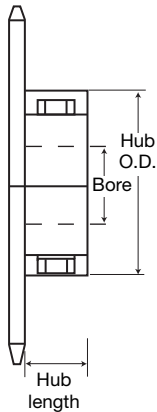

PRICING EXAMPLE STYLE B

**120B45 Split with S-3 Hub,
2 15/16" Bore, KW & SS**

**S-3 Hub
120A45 Plate**

SEE HUB LIST
+ SEE PLATE LIST
TOTAL LIST PRICE

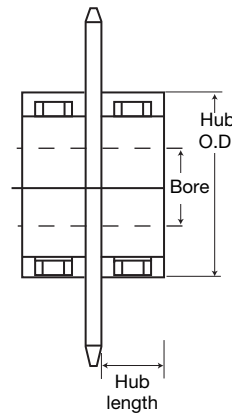

PRICING EXAMPLE STYLE C

**120C45 Split with S-3 Hubs,
2 15/16" Bore, KW & SS**

**Two S-3 Hubs
120A45 Plate**

SEE HUB LIST
+ SEE PLATE LIST
TOTAL LIST PRICE

Instant Split Hubs are for use with plate sprockets only. For multiple strand split sprockets, consult *Martin*.

Sprocket Size For Instant Split Hubs

Split Hub No.	Bore	Minimum Number of Teeth for Single Sprockets										
		Chain Number										
		40	50	60	80	100	120	140	160	180	200	240
S-1	3/4"-1 1/2"	28	23	20	16	—	—	—	—	—	—	—
S-2	1 3/8"-2 1/4"	38	30	26	20	17	15	14	—	—	—	—
S-3	2"-3"	46	37	32	25	20	18	16	15	14	—	—
S-4	2 3/4"-4"	—	48	40	30	25	21	19	17	16	15	12
S-5	3 3/4"-5"	—	—	—	—	30	25	22	20	18	17	14
S-6	4 3/4"-6"	—	—	—	—	32	27	24	22	19	18	15
S-7	5 3/4"-7"	—	—	—	—	—	32	28	25	22	21	18
S-8	6 3/4"-8"	—	—	—	—	—	—	—	28	25	23	20

Martin TORQUE-LIMITER clutch offers thrifty overload protection that's easy to adjust.



Here is low cost protection for your machinery . . . a torque limiting clutch that is easy to install.

Torque-Limiter clutches feature an exclusive "Easy-Set Adjustment." With "Easy-Set," torque adjustment is accomplished quickly! The need for hammer and block, brute strength, and spanner wrenches is eliminated.

These simple steps and the job is done:

1. Snug up the adjusting nut, finger tight, locate set screw over nearest spline notch, and tighten. See table at right.
2. Tighten three cap screws until heads bottom — with a small wrench; this gives maximum torque.
3. For less torque — back off the cap screws, loosen the set screw, back off adjusting nut to one of the six spline notches as required, and retighten set screw and cap screws.

"Easy-Set Adjustment" not only simplifies installation, it provides solid support for pressure plates by compression at their peripheries.

The Torque-Limiter clutch gives machinery permanent protection against overloads during starting, reversing, or driving — by slipping at any desired load. It resumes driving without resetting when the overload is relieved. It is simple in design, compact, efficient, and built for long life. It provides low cost torque limiting service for a wide variety of applications. No lubrication . . . minimum maintenance.

Starting shock from electric motors is a major cause of maintenance of moving parts. Torque-Limiter clutches provide a cushion by slipping until the torque drops to a pre-set level. They can be set to reduce shock loads on motors and driven equipment during reversing or inching. They provide mechanical protection against breakage due to sudden overload — by slipping when the pre-set torque limit is reached.

Torque-Limiter clutches may be used with a sprocket, gear, sheave, flange, or other driven member. It is recommended that the rubbing sides of the driven member be ground to provide a smooth rubbing surface of 63 to 125 micro-inches. See torque rating table on following page.

The driven member is mounted on an oil-impregnated bushing and clamped between two, high quality friction discs by spring pressure. Each Torque-Limiter unit, completely assembled, contains one spring. Higher torque ratings can be obtained by the use of a second spring nested within the original spring. See rating table on following page.

When an overload occurs, the driven member slips between long-life, clutch-type friction discs. After slipping has started, it will continue at approximately 90% of the torque setting, due to the lower coefficient of friction when slipping, until the overload condition has been corrected.

TORQUE-LIMITER CLUTCH CALIBRATION

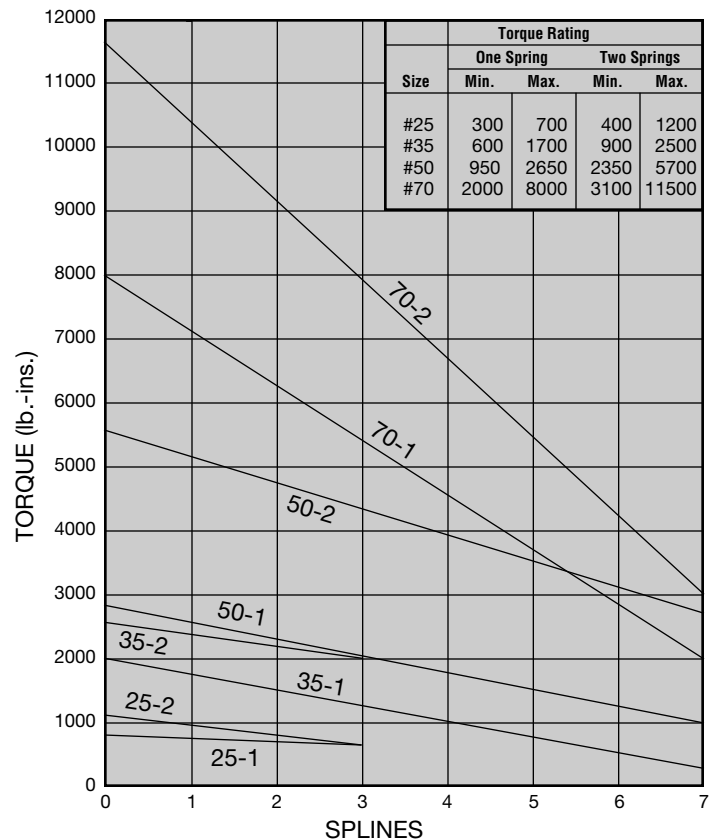

Note:

Graph indicates approximate rated torque vs number of splines adjusting nut is backed off from finger tight.

Torque-Limiter Clutches



TORQUE-LIMITER CLUTCHES



Each assembled unit contains one spring. Higher ratings can be obtained by ordering a second spring to nest in the original one. Bushings need to be ordered separately, if required.

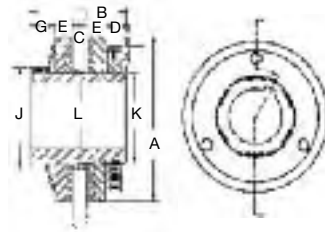

The rubbing sides of the center member should be ground parallel — 63 to 125 micro-inches.

Stock Plate Sprockets with Ground Face and Bored to Fit the *Martin* Torque Limiter

UNIT TT25

Sprocket Size
35TTA25-25
35TTA26-25
40TTA20-25
40TTA22-25
40TTA24-25
40TTA28-25
40TTA30-25
50TTA28-25
50TTA24-35
50TTA17-25
50TTA21-25
50TTA22-25

UNIT TT35

Sprocket Size
35TTA35-35
35TTA40-35
40TTA28-35
40TTA30-35
40TTA32-35
50TTA28-35
50TTA24-35
50TTA25-35
50TTA26-35
60TTA18-35
60TTA20-35

Torque-Limiter Clutch Ratings

Size No.	Avg. Wt.	Torque Rating ▲ (Pound-Inches)				A		B		C		D	E	G	H	J	K +.000 - .002 Spline O. D.	L +.003 - .000 Spkt. Bore
		With One Spring		With Two Springs**		Min.	Max.	Min.	Max.	Min.	Max.							
		Min.	Max.	Min.	Max.													
TT25	1	300	700	400	1200	2½	1¼	¼	½	⅝	⅜	⅜	⅜	2½	1½	1.368	1.631/1.628	
TT35	2.5	600	1700	900	2500	3½	2⅞	¼	¾	⅝	⅝	⅝	⅝	3⅞	1⅞	1.675	2.006/2.003	
TT50	6	950	2650	2350	5700	5	2⅞	¼	¾	⅝	⅝	⅝	⅝	4⅞	2⅞	2.625	3.008/3.005	
TT70	18	2100	8000	3100	11500	7	3⅞	¼	1¼	⅝	⅝	⅝	⅝	6	4	3.811	4.197/4.194	

▲ Using a center member with rubbing sides ground parallel — 63 to 125 micro-inches. Center member must be clean and free from oil, rust, etc.

** Second spring may be nested in one originally furnished. Order if required.

◆ Nominal for maximum torque setting. For minimum torque setting, add ⅜" for No. 25; ⅝" for No. 35; ¾" for Nos. 50 and 70. When two springs are used this dimension is increased approximately ⅛" on Nos. 25, 35 and 50 — ⅜" on No. 70.

UNIT TT50

Sprocket Size
40TTA35-50
50TTA30-50
50TTA32-50
60TTA25-50
60TTA26-50
60TTA28-50
60TTA30-50
80TTA20-50
80TTA22-50
80TTA24-50

UNIT TT70

Sprocket Size
60TTA36-70
80TTA26-70
80TTA28-70
80TTA30-70
80TTA36-70
100TTA22-70
100TTA24-70

Stock Bores — Torque Limiters (No KW 1-SS†)

Size No.	Stock Bore	Max. Bore	
		Std. KW*	Shallow KW*
TT25	½	¾	1
TT35	¾	1⅞	1¼
TT50	1	1¼	2
TT70	1¼	2¼	3

† Additional SS See List Price Alterations

* KW To Be Cut Central w/Threaded Spline

Standard Keyways

Torque-Limiter Bore	Keyway	Torque-Limiter Bore	Keyway
½-¾	⅜ x ⅜	1⅞-1¼	¾ x ¾
¾-1	⅝ x ⅝	1⅞-2¼	⅞ x ⅞
1⅞-1¼	¾ x ¾	2⅞-2¼	¾ x ¾
1⅞-1¼	⅝ x ⅝	2⅞-3	¾ x ¾

Bored to Size Torque Limiters w/Std. KW & 1-SS†

Size No.	Finished Bores												
	½	¾	¾	¾	1	1¼	1⅞	1¼	1¼	1⅞	1½	1¼	
TT25													
TT35					1								
TT50					1	1¼	1⅞	1¼	1¼	1⅞	1½	1¼	
TT70									1⅞	1½		1¼	1⅞

† KW Same as Std. Listed in Tables Above. Additional S.S. See List Price

Unit Size	Min. Allowable Sprocket Teeth and Length of Bushing Req'd for Chain Number											
	Sprocket Pitch	35	41	40	50	60	80	100	120	140	160	
TT25	Min. Teeth	STK. ★	25	19	19	16	
		MTO ●	25	19	19	16	
	Bush. Lght. Req'd.		½	½	¼	¼	¼	¼	¼	¼	¼	
TT35	Min. Teeth	STK. ★	35	25	26	21	18	15	
		MTO ●	33	25	26	21	18	15	
	Bush. Lght. Req'd.		½	½	¼	¼	¾	¾	
TT50	Min. Teeth	STK. ★	48	35	35	29	25	19	
		MTO ●	46	35	35	29	25	19	
	Bush. Lght. Req'd.		½	½	¼	¼	¾	¾	
TT70	Min. Teeth	STK. ★	48	38	33	26	21	18	16	14
		MTO ●	48	38	33	26	21	18	16	14
	Bush. Lght. Req'd.		¼	¼	¾	¾	½	¾	¾	1◆

★ Min. number of teeth on sprocket stocked by *Martin* which can be used w/Torque-Limiter clutch.

● Min. number of teeth on made-to-order sprocket which will permit chain to clear friction disc.

* Use one ⅝" long bushing and one ¼" long.

◆ Use two ½" long bushings.

SPARE PARTS

TT25 TT50 TT35 TT70	QTY. REQ.*
PRESSURE PLATE	2
FRICTION DISC	2
ADJ. NUT ASSY. & S.S.	1
ADJ. TENSION NUT	3
HUB	1

* PER UNIT





**Standard Roller
Double Duty**



**Carrier
Roller**

Double-Pitch Sprockets



Standard Rollers

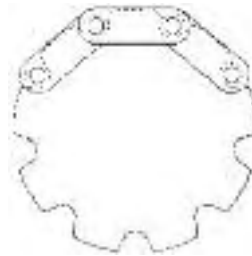

**Double Pitch
Single Duty
Made-To-Order**

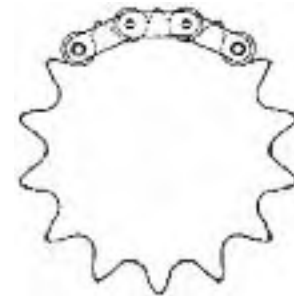

Carrier Rollers

Series C-2000 chains have rollers of the same diameters and widths as American Standard Roller Chains of one half the conveyor chain pitch. Engaged by every other tooth, double duty sprockets have two teeth per chain pitch. During each revolution only half the teeth function effectively. Sprockets with odd numbers of teeth will allow any given tooth to engage only on every other revolution, automatically increasing sprocket life. Double duty sprockets with even number of teeth may be manually advanced one tooth periodically to increase sprocket life. *Martin* Stock C-2000 series sprockets are furnished double duty only.

Sprockets for the C-2002 series chain with carrier rollers are cut with space cutters or standard hobs for the American Standard roller Chain of the same diameter. Each sprocket tooth meshes with these chains. Double-duty sprockets cannot be made for double pitch chain with Carrier Rollers.

NOTE: For drives of 31 teeth or more we recommend using Standard sprockets with series C-2000 chains.

All altered double pitch sprockets requiring a keyway will be furnished with keyway on center line of tooth, unless otherwise specified.

Double Pitch All Steel Stock Sprockets

1-Inch Double-Pitch

Conveyor or Drive Series — Standard Roller Double Pitch — 2040/C2040

No. Teeth Actual	Eff. No. Teeth	Outside Diameter	Pitch Diameter	Catalog Number	Type	Bore		Hub		Wt. Lbs. (Approx.)
						Stock	Rec. Max.	Diameter	Length Thru	
11	5.5	2.000	1.852	2040B11	B	1/2	1/16	1 1/8*	3/8	.34
12	6	2.170	2.000	2040B12	B	1/2	1/16	1 1/8*	3/8	.44
13	6.5	2.330	2.152	2040B13	B	1/2	3/32	1 1/8*	3/8	.48
14	7	2.490	2.305	2040B14	B	1/2	1 1/2	1 1/8*	3/8	.60
15	7.5	2.650	2.458	2040B15	B	5/8	1 1/2	1 3/8	3/8	.66
16	8	2.810	2.613	2040B16	B	5/8	1 1/2	1 3/8	3/8	.76
17	8.5	2.980	2.768	2040B17	B	5/8	1 1/2	2 3/4	1	1.00
18	9	3.140	2.924	2040B18	B	5/8	1 1/2	2 3/4	1	1.16
19	9.5	3.300	3.080	2040B19	B	5/8	1 1/2	2 3/4	1	1.36
20	10	3.460	3.236	2040B20	B	5/8	1 1/2	2 3/4	1	1.54
21	10.5	3.620	3.392	2040B21	B	5/8	1 1/2	2 3/4	1	1.74
22	11	3.780	3.549	2040B22	B	5/8	1 1/2	2 3/4	1	1.92
23	11.5	3.940	3.706	2040B23	B	5/8	2	3	1	2.16
24	12	4.100	3.864	2040B24	B	5/8	2 1/4	3 1/4	1	2.44
25	12.5	4.260	4.021	2040B25	B	5/8	2 1/4	3 1/4	1	2.48
26	13	4.420	4.179	2040B26	B	5/8	2 1/4	3 1/4	1	2.60
28	14	4.740	4.494	2040B28	B	5/8	2 1/4	3 1/4	1	2.74
30	15	5.060	4.810	2040B30	B	5/8	2 1/4	3 1/4	1	2.92

* Has recessed groove in hub for chain clearance.

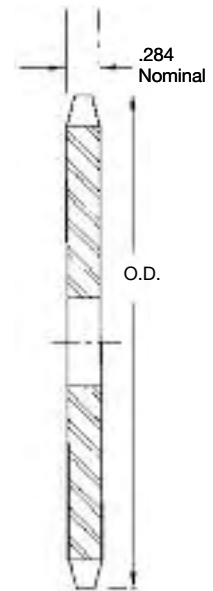

TYPE A

Conveyor Series — Carrier Roller Double Pitch — 2042/C2042

No. Teeth Actual	Outside Diameter	Pitch Diameter	Catalog Number	Type	Bore		Hub		Wt. Lbs. (Approx.)	Type	Catalog Number	Stock Bore	Wt. Lbs. (Approx.)
					Stock	Rec. Max.	Dia.	Length Thru					
8	3.010	2.613	2042B8	B	5/8	1 1/2	1 1/8	3/8	.72				
9	3.350	2.924	2042B9	B	5/8	1 1/2	2 1/2	3/8	1.02				
10	3.680	3.236	2042B10	B	5/8	1 1/2	2 3/4	1	1.50				
11	4.000	3.549	2042B11	B	5/8	1 1/2	2 3/4	1	1.68				
12	4.330	3.864	2042B12	B	5/8	2 1/4	3 1/8	1	2.22				
13	4.660	4.179	2042B13	B	5/8	2 1/4	3 1/4	1	2.56				
14	4.980	4.494	2042B14	B	5/8	2 1/4	3 1/4	1	2.72				
15	5.300	4.810	2042B15	B	5/8	2 1/4	3 1/4	1	2.90				
16	5.630	5.126	2042B16	B	5/8	2 1/4	3 1/4	1	3.10	A	2042A16	1 1/2	1.38
17	5.950	5.442	2042B17	B	5/8	2 1/4	3 1/4	1	3.40	A	2042A17	1 1/2	1.66
18	6.270	5.759	2042B18	B	5/8	2 1/4	3 1/4	1	3.56	A	2042A18	1 1/2	1.88
19	6.590	6.076	2042B19	B	5/8	2 1/4	3 1/4	1	3.72	A	2042A19	1 1/2	2.06
20	6.910	6.392	2042B20	B	5/8	2 3/4	3 1/2	1 1/8	4.72	A	2042A20	2 1/2	2.40
21	7.240	6.710	2042B21	B	5/8	2 3/4	3 1/2	1 1/8	4.84	A	2042A21	2 1/2	2.62
22	7.560	7.027	2042B22	B	5/8	2 3/4	3 1/2	1 1/8	5.18	A	2042A22	2 1/2	2.88
23	7.880	7.344	2042B23	B	5/8	2 3/4	3 1/2	1 1/8	5.04	A	2042A23	2 1/2	3.14
24	8.200	7.661	2042B24	B	5/8	2 3/4	3 1/2	1 1/8	5.58	A	2042A24	2 1/2	3.22
25	8.520	7.979	2042B25	B	5/8	2 3/4	3 1/2	1 1/8	5.96	A	2042A25	2 1/2	3.50
26	8.840	8.296	2042B26	B	5/8	2 3/4	3 1/2	1 1/8	6.22	A	2042A26	2 1/2	3.74
28	9.480	8.931	2042B28	B	5/8	2 3/4	3 1/2	1 1/8	6.78	A	2042A28	2 1/2	4.76
30	10.110	9.567	2042B30	B	5/8	2 3/4	3 1/2	1 1/8	7.56	A	2042A30	2 1/2	5.08

* Has recessed groove in hub for chain clearance.

Maximum bores shown will accommodate standard keyseat and setscrew over keyseat.
Slightly larger bores are possible with no keyseat, shallow keyseat, or setscrew at angle to keyseat.

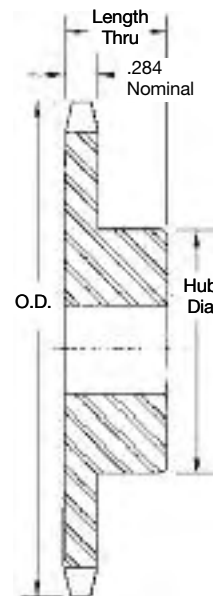

TYPE B

SPROCKETS

1¼-Inch Double-Pitch

Conveyor or Drive Series — Standard Roller Double Pitch — 2050/C2050

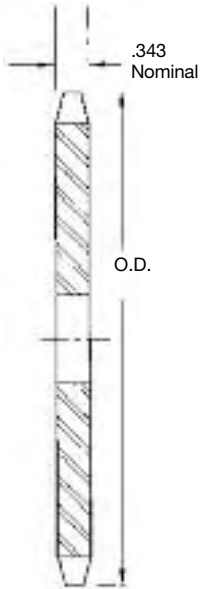

TYPE A

No. Teeth	Eff. No. Teeth	Outside Diameter	Pitch Diameter	Catalog Number	Type	Bore		Hub		Wt. Lbs. (Approx.)	Type	Catalog Number	Stock Bore	Wt. Lbs. (Approx.)
						Stock	Rec. Max.	Dia.	Length Thru					
11	5.5	2.500	2.315	2050B11	B	5/8	13/16	1 1/4*	1	.62				
12	6	2.710	2.500	2050B12	B	5/8	1	1 5/8	1	.80				
13	6.5	2.910	2.690	2050B13	B	5/8	1 1/32	1 7/8	1	.82				
14	7	3.110	2.881	2050B14	B	5/8	1 1/8	1 15/16	1	1.00				
15	7.5	3.320	3.073	2050B15	B	5/8	1 1/8	2 1/8	1	1.22				
16	8	3.520	3.266	2050B16	B	5/8	1 1/8	2 3/8	1	1.44				
17	8.5	3.720	3.460	2050B17	B	5/8	1 1/8	2 1/2	1	1.68				
18	9	3.920	3.655	2050B18	B	5/8	1 1/8	2 5/8	1	1.94				
19	9.5	4.120	3.850	2050B19	B	5/8	1 1/8	2 3/4	1	2.24				
20	10	4.320	4.045	2050B20	B	5/8	2	3	1	2.30				
21	10.5	4.520	4.241	2050B21	B	5/8	2	3	1	2.40				
22	11	4.720	4.437	2050B22	B	5/8	2	3	1	2.54				
23	11.5	4.920	4.633	2050B23	B	5/8	2	3	1	2.66				
24	12	5.120	4.830	2050B24	B	5/8	2	3	1 1/4	3.30	A	2050A24	3/32	1.58
25	12.5	5.320	5.026	2050B25	B	5/8	2	3	1 1/4	3.42	A	2050A25	3/32	1.68
26	13	5.520	5.223	2050B26	B	5/8	2	3	1 1/4	3.62	A	2050A26	3/32	1.88
28	14	5.920	5.617	2050B28	B	5/8	2	3	1 1/4	3.78	A	2050A28	3/32	2.22
30	15	6.320	6.012	2050B30	B	5/8	2 1/4	3 1/4	1 1/4	4.58	A	2050A30	3/32	2.54

* Has recessed groove in hub for chain clearance.

SPROCKETS

Conveyor Series — Carrier Roller Double Pitch — 2052/C2052

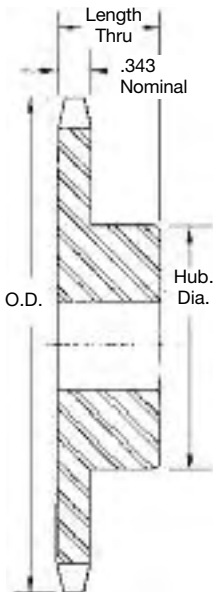

TYPE B

No. Teeth	Outside Diameter	Pitch Diameter	Catalog Number	Type	Bore		Hub		Wt. Lbs. (Approx.)	Type	Catalog Number	Stock Bore	Wt. Lbs. (Approx.)
					Stock	Rec. Max.	Dia.	Length Thru					
8	3.770	3.266	2052B8	B	5/8	1 1/32	2 3/8	1	1.38				
9	4.190	3.655	2052B9	B	5/8	1 1/32	2 5/8	1	1.92				
10	4.600	4.045	2052B10	B	5/8	2	3	1	2.30				
11	5.010	4.437	2052B11	B	5/8	2	3	1	2.54				
12	5.420	4.830	2052B12	B	5/8	2	3	1 1/4	3.20	A	2052A12	3/32	1.58
13	5.820	5.223	2052B13	B	5/8	2	3	1 1/4	3.48	A	2052A13	3/32	1.82
14	6.230	5.617	2052B14	B	5/8	2	3	1 1/4	3.88	A	2052A14	3/32	2.28
15	6.630	6.012	2052B15	B	5/8	2 1/4	3 1/4	1 1/4	4.46	A	2052A15	3/32	2.46
16	7.030	6.407	2052B16	B	5/8	2 1/4	3 1/4	1 1/4	4.80	A	2052A16	3/32	2.88
17	7.440	6.803	2052B17	B	5/8	2 1/4	3 1/4	1 1/4	5.34	A	2052A17	3/32	3.28
18	7.840	7.198	2052B18	B	5/8	2 1/4	3 1/4	1 1/4	5.64	A	2052A18	3/32	3.64
19	8.240	7.595	2052B19	B	5/8	2 1/4	3 1/4	1 1/4	6.04	A	2052A19	3/32	4.12
20	8.640	7.991	2052B20	B	5/8	2 1/4	3 1/4	1 1/4	6.48	A	2052A20	3/32	4.72
21	9.040	8.387	2052B21	B	5/8	2 1/4	3 1/4	1 1/4	7.00	A	2052A21	3/32	5.08
22	9.440	8.783	2052B22	B	5/8	2 1/4	3 1/4	1 1/4	7.30	A	2052A22	3/32	5.20
23	9.850	9.180	2052B23	B	1	2 3/4	3 3/4	1 1/4	8.66	A	2052A23	1/16	5.84
24	10.250	9.577	2052B24	B	1 5/16	2 3/4	3 3/4	1 1/4	9.32	A	2052A24	1/16	6.70
25	10.650	9.973	2052B25	B	1 5/16	2 3/4	3 3/4	1 1/4	10.30	A	2052A25	1/16	7.54
26	11.050	10.370	2052B26	B	1 5/16	2 3/4	3 3/4	1 1/4	11.00	A	2052A26	1/16	8.24
28	11.840	11.164	2052B28	B	1 5/16	2 3/4	3 3/4	1 1/4	11.70	A	2052A28	1/16	8.70
30	12.640	11.958	2052B30	B	1 5/16	2 3/4	3 3/4	1 1/4	12.90	A	2052A30	1/16	9.92

* Has recessed groove in hub for chain clearance.

Maximum bores shown will accommodate standard keyseat and setscrew over keyseat.
Slightly larger bores are possible with no keyseat, shallow keyseat, or setscrew at angle to keyseat.

Double Pitch All Steel Stock Sprockets

1½-Inch Double-Pitch

Conveyor Series — Standard Roller Double Pitch — 2060/C2060

No. Teeth	Eff. No. Teeth	Outside Diameter	Pitch Diameter	Catalog Number	Type	Bore		Hub		Wt. Lbs. (Approx.)	Type	Catalog Number	Stock Bore	Wt. Lbs. (Approx.)
						Stock	Rec. Max.	Dia.	Length Thru					
11	5.5	3.000	2.773	2060B11	B	¾	1	2 ¹ / ₁₆ ★	1 ¹ / ₄	1.14				
12	6	3.250	3.000	2060B12	B	¾	1 ¹ / ₄	2 ⁷ / ₁₆ ★	1 ¹ / ₄	1.46				
13	6.5	3.490	3.228	2060B13	B	¾	1 ¹ / ₁₆	2 ³ / ₄	1 ¹ / ₄	1.52				
14	7	3.740	3.457	2060B14	B	¾	1 ¹ / ₁₆	2 ³ / ₄	1 ¹ / ₄	1.86				
15	7.5	3.980	3.688	2060B15	B	¾	1 ¹ / ₂	2 ⁷ / ₁₆	1 ¹ / ₄	2.24				
16	8	4.220	3.920	2060B16	B	¾	1 ⁷ / ₁₆	2 ⁷ / ₁₆	1 ¹ / ₄	2.64				
17	8.5	4.460	4.152	2060B17	B	¾	2 ¹ / ₁₆	3 ¹ / ₁₆	1 ¹ / ₄	3.08				
18	9	4.700	4.386	2060B18	B	¾	2 ¹ / ₁₆	3 ¹ / ₁₆	1 ¹ / ₄	3.56				
19	9.5	4.940	4.620	2060B19	B	¾	2 ¹ / ₁₆	3 ¹ / ₁₆	1 ¹ / ₄	3.94				
20	10	5.190	4.854	2060B20	B	¾	2 ¹ / ₁₆	3 ¹ / ₁₆	1 ¹ / ₄	4.50				
21	10.5	5.430	5.089	2060B21	B	¾	2 ¹ / ₁₆	4	1 ¹ / ₄	5.02				
22	11	5.670	5.324	2060B22	B	¾	2 ¹ / ₁₆	4	1 ¹ / ₄	5.26				
23	11.5	5.910	5.560	2060B23	B	¾	2 ¹ / ₁₆	4	1 ¹ / ₄	5.54	A	2060A24	2 ³ / ₁₆	3.02
24	12	6.150	5.796	2060B24	B	¾	2 ¹ / ₁₆	4	1 ¹ / ₄	5.90	A	2060A25	2 ³ / ₁₆	3.36
25	12.5	6.390	6.032	2060B25	B	¾	2 ¹ / ₁₆	4	1 ¹ / ₄	6.08	A	2060A26	2 ³ / ₁₆	3.58
26	13	6.630	6.268	2060B26	B	¾	2 ¹ / ₁₆	4	1 ¹ / ₄	6.36	A	2060A26	2 ³ / ₁₆	3.58
28	14	7.110	6.741	2060B28	B	¾	2 ¹ / ₁₆	4	1 ¹ / ₄	7.02	A	2060A28	2 ³ / ₁₆	4.12
30	15	7.590	7.215	2060B30	B	¾	2 ¹ / ₁₆	4	1 ¹ / ₄	7.54	A	2060A30	2 ³ / ₁₆	4.88

★ Has recessed groove in hub for chain clearance.

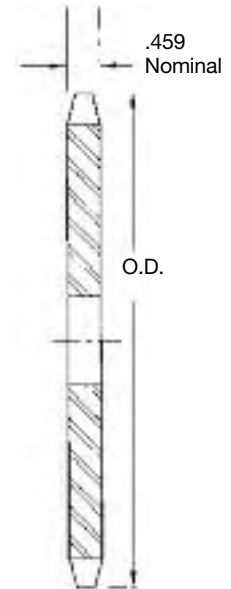

TYPE A

Conveyor Series — Carrier Roller Double Pitch — 2062/C2062

No. Teeth	Outside Diameter	Pitch Diameter	Catalog Number	Type	Bore		Hub		Wt. Lbs. (Approx.)	Type	Catalog Number	Stock Bore	Wt. Lbs. (Approx.)
					Stock	Rec. Max.	Dia.	Length Thru					
8	4.520	3.920	2062B8	B	¾	1 ⁷ / ₁₆	2 ⁷ / ₁₆	1 ¹ / ₄	2.60				
9	5.020	4.386	2062B9	B	¾	2 ¹ / ₁₆	3 ¹ / ₁₆	1 ¹ / ₄	3.48				
10	5.520	4.854	2062B10	B	¾	2 ¹ / ₁₆	3 ³ / ₁₆	1 ¹ / ₄	4.54				
11	6.010	5.324	2062B11	B	¾	2 ¹ / ₁₆	4	1 ¹ / ₄	5.20				
12	6.500	5.796	2062B12	B	¾	2 ¹ / ₁₆	4	1 ¹ / ₄	5.70	A	2062A12	2 ³ / ₁₆	2.98
13	6.990	6.268	2062B13	B	¾	2 ¹ / ₁₆	4	1 ¹ / ₄	6.28	A	2062A13	2 ³ / ₁₆	3.60
14	7.470	6.741	2062B14	B	¾	2 ¹ / ₁₆	4	1 ¹ / ₄	6.82	A	2062A14	2 ³ / ₁₆	4.02
15	7.960	7.215	2062B15	B	¾	2 ¹ / ₁₆	4	1 ¹ / ₄	7.48	A	2062A15	2 ³ / ₁₆	4.76
16	8.440	7.689	2062B16	B	¾	2 ¹ / ₁₆	4	1 ¹ / ₄	8.18	A	2062A16	2 ³ / ₁₆	5.70
17	8.920	8.163	2062B17	B	1	2 ¹ / ₁₆	4	1 ¹ / ₄	8.82	A	2062A17	1 ⁵ / ₁₆	6.16
18	9.410	8.638	2062B18	B	1	2 ¹ / ₁₆	4	1 ¹ / ₄	9.36	A	2062A18	1 ⁵ / ₁₆	6.96
19	9.890	9.113	2062B19	B	1	2 ¹ / ₁₆	4 ¹ / ₁₆	1 ¹ / ₄	11.10	A	2062A19	1 ⁵ / ₁₆	8.00
20	10.370	9.589	2062B20	B	1 ¹ / ₁₆	2 ¹ / ₁₆	4 ¹ / ₁₆	1 ¹ / ₄	11.66	A	2062A20	1 ⁵ / ₁₆	8.46
21	10.850	10.064	2062B21	B	1 ¹ / ₁₆	2 ¹ / ₁₆	4 ¹ / ₁₆	1 ¹ / ₄	13.24	A	2062A21	1 ⁵ / ₁₆	8.93
22	11.330	10.540	2062B22	B	1 ¹ / ₁₆	2 ¹ / ₁₆	4 ¹ / ₁₆	1 ¹ / ₄	13.78	A	2062A22	1 ⁵ / ₁₆	10.74
23	11.810	11.016	2062B23	B	1 ¹ / ₁₆	2 ¹ / ₁₆	4 ¹ / ₁₆	1 ¹ / ₄	14.90	A	2062A23	1 ⁵ / ₁₆	11.64
24	12.290	11.492	2062B24	B	1 ¹ / ₁₆	2 ¹ / ₁₆	4 ¹ / ₁₆	1 ¹ / ₄	15.66	A	2062A24	1 ⁵ / ₁₆	12.64
25	12.770	11.968	2062B25	B	1 ¹ / ₁₆	2 ¹ / ₁₆	4 ¹ / ₁₆	1 ¹ / ₄	16.80	A	2062A25	1 ⁵ / ₁₆	13.78
26	13.250	12.444	2062B26	B	1 ¹ / ₁₆	2 ¹ / ₁₆	4 ¹ / ₁₆	1 ¹ / ₄	20.20	A	2062A26	1 ⁵ / ₁₆	15.00
28	14.210	13.397	2062B28	B	1 ¹ / ₁₆	2 ¹ / ₁₆	4 ¹ / ₁₆	1 ¹ / ₄	21.86	A	2062A28	1 ⁵ / ₁₆	17.32
30	15.170	14.350	2062B30	B	1 ¹ / ₁₆	2 ¹ / ₁₆	4 ¹ / ₁₆	1 ¹ / ₄	26.00	A	2062A30	1 ⁵ / ₁₆	19.50

★ Has recessed groove in hub for chain clearance.

Maximum bores shown will accommodate standard keyseat and setscrew over keyseat.
Slightly larger bores are possible with no keyseat, shallow keyseat, or setscrew at angle to keyseat.

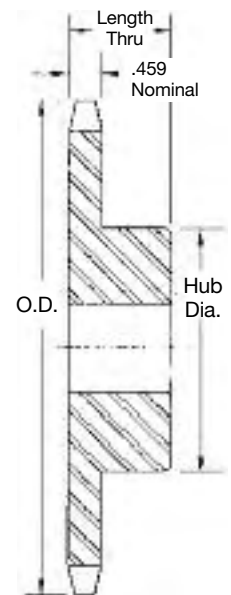

TYPE B

SPROCKETS

2-Inch Double-Pitch

Conveyor or Drive Series — Standard Roller Double Pitch — 2080/C2080

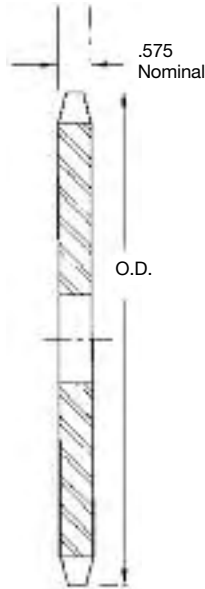

TYPE A

No. Teeth	Eff. No. Teeth	Outside Diameter	Pitch Diameter	Catalog Number	Type	Bore		Hub		Wt. Lbs. (Approx.)	Type	Catalog Number	Stock Bore	Wt. Lbs. (Approx.)
						Actual	Rec. Max.	Dia.	Length Thru					
11	5.5	4.010	3.694	2080B11	B	1	1 1/2	2 1/16*	1 1/2	2.5				
12	6	4.330	4.000	2080B12	B	1	1 1/16	3 1/8*	1 1/2	3.2				
13	6.5	4.660	4.304	2080B13	B	1	1 3/16	2 3/8	1 1/2	3.3				
14	7	4.980	4.610	2080B14	B	1	2 1/8	3 1/8	1 1/2	4.0				
15	7.5	5.300	4.917	2080B15	B	1	2 1/2	3 3/8	1 1/2	4.8				
16	8	5.630	5.226	2080B16	B	1	2 1/2	3 3/8	1 1/2	5.7				
17	8.5	5.950	5.536	2080B17	B	1	2 3/4	4	1 1/2	6.4	A	2080A17	1 5/16	3.4
18	9	6.270	5.848	2080B18	B	1	2 3/4	4 1/4	1 1/2	7.4	A	2080A18	1 5/16	3.8
19	9.5	6.590	6.160	2080B19	B	1	2 3/4	4 1/4	1 1/2	7.7	A	2080A19	1 5/16	4.3
20	10	6.910	6.472	2080B20	B	1	2 3/4	4 1/4	1 1/2	8.3	A	2080A20	1 5/16	4.8
21	10.5	7.230	6.785	2080B21	B	1	2 3/4	4 1/4	1 1/2	9.4	A	2080A21	1 5/16	5.3
22	11	7.560	7.099	2080B22	B	1	2 3/4	4 1/4	1 1/2	10.0	A	2080A22	1 5/16	5.8
23	11.5	7.880	7.413	2080B23	B	1	2 3/4	4 1/4	1 1/2	10.5	A	2080A23	1 5/16	6.4
24	12	8.200	7.727	2080B24	B	1	2 3/4	4 1/4	1 1/2	11.1	A	2080A24	1 5/16	7.1
25	12.5	8.520	8.042	2080B25	B	1	2 3/4	4 1/4	1 1/2	12.0	A	2080A25	1 5/16	7.5
26	13	8.840	8.357	2080B26	B	1 1/4	3 1/4	4 1/4	2	14.8	A	2080A26	1 3/8	8.3
28	14	9.480	8.988	2080B28	B	1 1/8	3 3/4	4 1/4	2	16.6	A	2080A28	1 1/8	9.2
30	15	10.110	9.620	2080B30	B	1 1/8	3 3/4	4 1/4	2	17.8	A	2080A30	1 1/8	10.7

* Has recessed groove in hub for chain clearance.

SPROCKETS

Conveyor Series — Carrier Roller Double Pitch — 2082/C2082

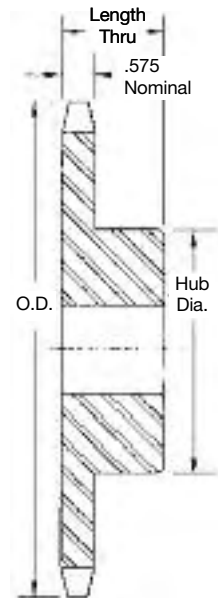

TYPE B

No. Teeth	Outside Diameter	Pitch Diameter	Catalog Number	Type	Bore		Hub		Wt. Lbs. (Approx.)	Type	Catalog Number	Stock Bore	Wt. Lbs. (Approx.)
					Actual	Rec. Max.	Dia.	Length Thru					
8	6.030	5.226	2082B8	B	1	2 1/16	3 3/8	1 1/2	6.4				
9	6.700	5.848	2082B9	B	1	2 1/4	4 1/4	1 1/2	8.2				
10	7.360	6.472	2082B10	B	1	2 1/4	4 1/4	1 1/2	9.2				
11	8.010	7.099	2082B11	B	1	2 3/4	4 1/4	1 1/2	10.1	A	2082A11	1 5/16	5.7
12	8.660	7.727	2082B12	B	1	2 3/4	4 1/4	1 1/2	11.2	A	2082A12	1 5/16	6.8
13	9.310	8.357	2082B13	B	1 1/4	3 1/4	4 1/4	2	15.0	A	2082A13	1 1/8	7.7
14	9.960	8.988	2082B14	B	1 1/4	3 1/4	4 1/4	2	15.8	A	2082A14	1 1/8	9.1
15	10.610	9.620	2082B15	B	1 1/8	3 3/4	4 1/4	2	17.8	A	2082A15	1 1/8	10.7
16	11.250	10.252	2082B16	B	1 1/8	3 3/4	4 1/4	2	19.3	A	2082A16	1 1/8	12.4
17	11.900	10.885	2082B17	B	1 1/8	3 3/4	4 1/4	2	21.4	A	2082A17	1 1/8	14.1
18	12.540	11.518	2082B18	B	1 1/8	3 3/4	4 1/4	2	22.9	A	2082A18	1 1/8	15.4
19	13.190	12.151	2082B19	B	1 1/8	3 3/4	4 1/4	2	24.4	A	2082A19	1 1/8	18.0
20	13.830	12.785	2082B20	B	1 1/8	3 3/4	4 1/4	2	26.7	A	2082A20	1 1/8	19.2
21	14.470	13.419	2082B21	B	1 1/4	3 3/4	4 1/4	2	28.4	A	2082A21	1 1/4	20.8
22	15.110	14.053	2082B22	B	1 1/4	3 3/4	4 1/4	2	39.6	A	2082A22	1 1/4	23.7
23	15.750	14.688	2082B23	B	1 1/4	3 3/4	4 1/4	2	32.2	A	2082A23	1 1/4	24.9
24	16.390	15.323	2082B24	B	1 1/4	3 3/4	4 1/4	2	34.9	A	2082A24	1 1/4	27.6
25	17.030	15.958	2082B25	B	1 1/4	3 3/4	4 1/4	2	37.8	A	2082A25	1 1/4	30.2
26	17.670	16.593	2082B26	B	1 1/4	3 1/2	5 1/4	2	41.5	A	2082A26	1 1/4	32.8
28	18.950	17.863	2082B28	B	1 1/4	3 1/2	5 1/4	2	47.7	A	2082A28	1 1/4	38.6
30	20.230	19.134	2082B30	B	1 1/4	3 1/2	5 1/4	2	54.5	A	2082A30	1 1/4	43.8

* Has recessed groove in hub for chain clearance.

Maximum bores shown will accommodate standard keyseat and setscrew over keyseat.
Slightly larger bores are possible with no keyseat, shallow keyseat, or setscrew at angle to keyseat.

No. 25

1/4" Pitch

All Steel Stock Sprockets



Single-Type B

Single-Type A

No. Teeth	Catalog Number	Outside Diameter	Type	Bore (inches)		Hub (inches)		Weight Lbs. (Approx.)	Type	Catalog Number	Stock Bore	Weight Lbs. (Approx.)
				Stock	Rec. Max.	Diameter	Length Thru					
9	25B9	.837	B	1/4	1/4	3/16	1/2	.03				
10	25B10	.919	B	1/4	1/4	1/2	1/2	.03				
11	25B11	1.002	B	1/4	5/16	5/16	1/2	.04				
12	25B12	1.083	B	1/4	3/8	5/8	1/2	.06				
13	25B13	1.167	B	1/4	7/16	23/32	1/2	.07				
14	25B14	1.246	B	1/4	9/16	13/16	1/2	.08				
15	25B15	1.326	B	1/4	5/8	7/8	1/2	.10				
16	25B16	1.407	B	1/4	9/16	1	1/2	.12				
17	25B17	1.487	B	1/4	3/4	1 1/32	1/2	.14				
18	25B18	1.568	B	1/4	3/4	1 1/8	1/2	.16	A	25A18	1/4	.04
19	25B19	1.648	B	1/4	7/8	1 1/2	1/2	.19	A	25A19	1/4	.04
20	25B20	1.729	B	1/4	7/8	1 5/8	3/4	.25	A	25A20	1/4	.04
21	25B21	1.809	B	1/4	7/8	1 3/4	3/4	.28	A	25A21	3/8	.04
22	25B22	1.889	B	1/4	1 1/16	2	3/4	.31	A	25A22	3/8	.06
23	25B23	1.969	B	1/4	1	2 1/8	3/4	.32	A	25A23	3/8	.06
24	25B24	2.049	B	3/8	1	2 1/4	3/4	.33	A	25A24	3/8	.08
25	25B25	2.129	B	3/8	1	2 1/2	3/4	.34	A	25A25	3/8	.08
26	25B26	2.209	B	3/8	1	2 3/4	3/4	.35	A	25A26	3/8	.09
28	25B28	2.369	B	3/8	1	3	3/4	.36	A	25A28	3/8	.10
30	25B30	2.529	B	3/8	1	3 1/2	3/4	.38	A	25A30	3/8	.12
32	25B32	2.688	B	3/8	1	4	3/4	.40	A	25A32	3/8	.14
35		2.928							A	25A35	3/8	.16
36	25B36	3.008	B	3/8	1	4 1/2	3/4	.50	A	25A36	3/8	.18
40	25B40	3.327	B	1/2	1 1/8	6	3/4	.53	A	25A40	1/2	.20
42		3.486							A	25A42	1/2	.24
45	25B45	3.725	B	1/2	1 1/4	7	3/4	.56	A	25A45	1/2	.25
48	25B48	3.964	B	1/2	1 1/4	8	3/4	.56	A	25A48	1/2	.32
54	25B54	4.442	B	1/2	1 1/4	10	3/4	1.00	A	25A54	1/2	.38
60	25B60	4.920	B	1/2	1 1/4	12	3/4	1.10	A	25A60	1/2	.54
70	25B70	5.717	B	1/2	1 1/4	16	3/4	1.25				
72	25B72	5.876	B	1/2	1 1/4	18	3/4	1.30	A	25A72	1/2	.74

Maximum bores shown will accommodate standard keyseat and setscrew over keyseat. Slightly larger bores are possible with no keyseat, shallow keyseat, or setscrew at angle to keyseat.

SPROCKETS

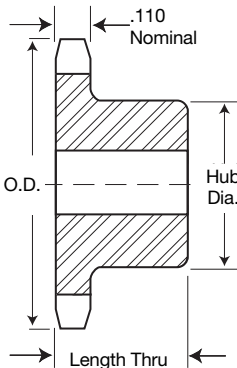

TYPE B



Alteration Charges

See current discount sheet for alteration charges.

Single-Type B — Stainless

No. Teeth	Catalog Number	Outside Diameter	Type	Bore (inches)		Hub (inches)		Weight Lbs. (Approx.)
				Stock	Rec. Max.	Diameter	Length Thru	
9	25B9SS	.837	B	1/4	1/4	7/16	1/2	.03
10	25B10SS	.919	B	1/4	1/4	1/2	1/2	.03
11	25B11SS	1.001	B	1/4	5/16	9/16	1/2	.03
12	25B12SS	1.083	B	1/4	3/8	5/8	1/2	.06
13	25B13SS	1.164	B	1/4	7/16	23/32	1/2	.07
14	25B14SS	1.245	B	1/4	9/16	13/16	1/2	.08
15	25B15SS	1.326	B	1/4	5/8	57/64	1/2	.10
16	25B16SS	1.407	B	1/4	9/16	31/32	1/2	.12
17	25B17SS	1.487	B	1/4	3/4	1 1/32	1/2	.14
18	25B18SS	1.568	B	1/4	3/4	1 1/8	1/2	.16
19	25B19SS	1.648	B	1/4	7/8	1 7/32	1/2	.19
20	25B20SS	1.728	B	1/4	7/8	1 7/32	5/8	.25
21	25B21SS	1.809	B	1/4	7/8	1 3/8	5/8	.28
22	25B22SS	1.889	B	1/4	1 1/16	1 7/16	5/8	.31
23	25B23SS	1.969	B	1/4	1	1 1/2	5/8	.32
24	25B24SS	2.049	B	3/8	1	1 1/2	5/8	.33
25	25B25SS	2.129	B	3/8	1	1 1/2	5/8	.34
26	25B26SS	2.209	B	3/8	1	1 1/2	5/8	.35
28	25B28SS	2.369	B	3/8	1	1 1/2	5/8	.36
30	25B30SS	2.529	B	3/8	1	1 1/2	5/8	.38
36	25B36SS	3.008	B	3/8	1	1 1/2	3/4	.50
40	25B40SS	3.327	B	1/2	1 1/8	2	3/4	.53
45	25B45SS	3.725	B	1/2	1 1/8	2	3/4	.56
60	25B60SS	4.920	B	1/2	1 1/8	2	3/4	1.10

Maximum bores shown will accommodate standard keyseat and setscrew over keyseat. Slightly larger bores are possible with no keyseat, shallow keyseat, or setscrew at angle to keyseat.

Sprockets altered at factory (rebored with key way and setscrew added) will be supplied with stainless setscrew.

SPROCKETS

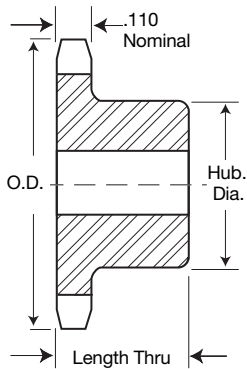

TYPE B



STAINLESS STEEL

Alteration Charges

See current discount sheet for alteration charges.

No. 35

3/8" Pitch

All Steel Stock Sprockets



Single-Type "BS" — 2 Setscrews — Bored-To-Size

No. Teeth	Catalog Number	Outside Diameter	Length Thru Bore	Weight Lbs. (Approx.)	Stock Finished Bores Includes Keyway and 2 Setscrews
9	35BS9	1.260	3/4	.10	*3/8
10	35BS10	1.380	3/4	.11	*3/8 — *1/2 — † 3/8
11	35BS11	1.500	3/4	.15	*3/8 — *1/2 — † 3/8 — † 3/4
12	35BS12	1.630	3/4	.18	— *1/2 — 3/8 — † 3/4
13	35BS13	1.750	3/4	.20	— *1/2 — 3/8 — 3/4
14	35BS14	1.870	3/4	.22	— *1/2 — 3/8 — 3/4
15	35BS15	1.990	3/4	.24	— *1/2 — 3/8 — 3/4 — 7/8 — 1
16	35BS16	2.110	3/4	.29	— *1/2 — 3/8 — 3/4 — 7/8 — 1
17	35BS17	2.230	3/4	.36	— *1/2 — 3/8 — 3/4 — 7/8 — 1
18	35BS18	2.350	3/4	.39	— *1/2 — 3/8 — 3/4 — 7/8 — 1
19	35BS19	2.470	3/4	.44	— *1/2 — 3/8 — 3/4 — 1
20	35BS20	2.590	3/4	.51	— *1/2 — 3/8 — 3/4 — 1
21	35BS21	2.710	3/4	.75	— *1/2 — 3/8 — 3/4 — 1
22	35BS22	2.830	7/8	.78	— *1/2 — 3/8 — 3/4 — 1
23	35BS23	2.950	7/8	.78	— *1/2 — 3/8 — 3/4 — 1
24	35BS24	3.070	7/8	.79	— *1/2 — 3/8 — 3/4 — 1
25	35BS25	3.190	7/8	.80	— *1/2 — 3/8 — 3/4 — 1
26	35BS26	3.310	7/8	.84	— 3/8 — 3/4 — 7/8 — 1 — 1 1/8 — 1 1/8 — 1 1/8 — 1 1/8
27	35BS27	3.430	7/8	.88	— 3/8 — 3/4 — 7/8 — 1 — 1 1/8 — 1 1/8 — 1 1/8 — 1 1/8
28	35BS28	3.550	7/8	.86	— 3/8 — 3/4 — 7/8 — 1 — 1 1/8 — 1 1/8 — 1 1/8 — 1 1/8
30	35BS30	3.790	7/8	.96	— 3/8 — 3/4 — 7/8 — 1 — 1 1/8 — 1 1/8 — 1 1/8 — 1 1/8
32	35BS32	4.030	7/8	1.14	— 3/8 — 3/4 — 7/8 — 1 — 1 1/8 — 1 1/8 — 1 1/8 — 1 1/8
35	35BS35	4.390	1	1.38	— 3/8 — 3/4 — 7/8 — 1 — 1 1/8 — 1 1/8 — 1 1/8 — 1 1/8
36	35BS36	4.510	1	1.41	— 3/8 — 3/4 — 7/8 — 1 — 1 1/8 — 1 1/8 — 1 1/8 — 1 1/8
40	35BS40	4.990	1	1.56	— 3/8 — 3/4 — 7/8 — 1 — 1 1/8 — 1 1/8 — 1 1/8 — 1 1/8
42	35BS42	5.230	1	1.64	— 3/8 — 3/4 — 7/8 — 1 — 1 1/8 — 1 1/8 — 1 1/8 — 1 1/8
45	35BS45	5.590	1	1.74	— 3/8 — 3/4 — 7/8 — 1 — 1 1/8 — 1 1/8 — 1 1/8 — 1 1/8
48	35BS48	5.950	1	1.86	— 3/8 — 3/4 — 7/8 — 1 — 1 1/8 — 1 1/8 — 1 1/8 — 1 1/8
54	35BS54	6.660	1	1.98	— 3/8 — 3/4 — 7/8 — 1 — 1 1/8 — 1 1/8 — 1 1/8 — 1 1/8
60	35BS60	7.380	1	2.34	— 3/8 — 3/4 — 7/8 — 1 — 1 1/8 — 1 1/8 — 1 1/8 — 1 1/8
70	35BS70	8.580	1	3.14	— 3/8 — 7/8 — 1 — 1 1/8 — 1 1/8 — 1 1/8 — 1 1/8
72	35BS72	8.810	1	3.30	— 3/8 — 7/8 — 1 — 1 1/8 — 1 1/8 — 1 1/8 — 1 1/8
80	35BS80	9.770	1	3.94	— 3/8 — 7/8 — 1 — 1 1/8 — 1 1/8 — 1 1/8 — 1 1/8
84	35BS84	10.250	1	4.26	— 3/8 — 7/8 — 1 — 1 1/8 — 1 1/8 — 1 1/8 — 1 1/8
96	35BS96	11.680	1	5.22	— 3/8 — 7/8 — 1 — 1 1/8 — 1 1/8 — 1 1/8 — 1 1/8
112	35BS112	13.590	1	6.50	— 3/8 — 7/8 — 1 — 1 1/8 — 1 1/8 — 1 1/8 — 1 1/8

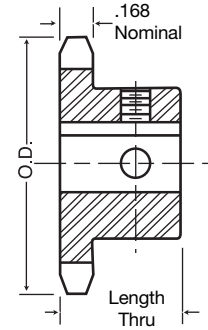

TYPE BS



BORED-TO-SIZE

*Indicates no keyway.

2 1/4" setscrews only in 1/2" & 3/8" bore.

† Keyway with Setscrew at 90°.

Hub diameters vary to suit different bore sizes.

NOTE: KEYWAY IS ON CENTER LINE OF TOOTH.

SPROCKETS

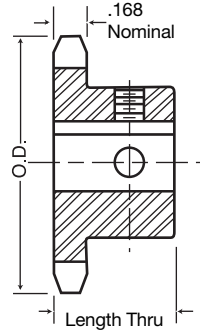

TYPE BS



BORED-TO-SIZE



No. 35-Hardened Teeth — 2 Setscrews — Bored-To-Size

No. Teeth	Catalog Number	Outside Diameter	Length Thru Bore	Weight Lbs. (Approx.)	Stock Finished Bores Includes Keyway and 2 Setscrews
9	35BS9HT	1.260	3/4"	.10	*3/8"
10	35BS10HT	1.380	3/4"	.11	*3/8" — *1/2" — † 3/8"
11	35BS11HT	1.500	3/4"	.15	*3/8" — *1/2" — † 3/8" — † 3/8"
12	35BS12HT	1.630	3/4"	.18	— *1/2" — 3/8" — † 3/8"
13	35BS13HT	1.750	3/4"	.20	— *1/2" — 3/8" — 3/8"
14	35BS14HT	1.870	3/4"	.22	— *1/2" — 3/8" — 3/8"
15	35BS15HT	1.990	3/4"	.24	— *1/2" — 3/8" — 3/8" — 7/8" — 1"
16	35BS16HT	2.110	3/4"	.29	— *1/2" — 3/8" — 3/8" — 7/8" — 1"
17	35BS17HT	2.230	3/4"	.36	— *1/2" — 3/8" — 3/8" — 7/8" — 1"
18	35BS18HT	2.350	3/4"	.39	— *1/2" — 3/8" — 3/8" — 7/8" — 1"
19	35BS19HT	2.470	3/4"	.44	3/8" — 3/8" — — 1"
20	35BS20HT	2.590	3/4"	.51	3/8" — 3/8" — — 1"
21	35BS21HT	2.710	3/4"	.75	3/8" — 3/8" — — 1"
22	35BS22HT	2.830	3/4"	.76	3/8" — 3/8" — — 1"
23	35BS23HT	2.950	3/4"	.78	3/8" — 3/8" — — 1"
24	35BS24HT	3.070	3/4"	.79	3/8" — 3/8" — — 1"
25	35BS25HT	3.190	3/4"	.80	3/8" — 3/8" — — 1"
26	35BS26HT	3.310	3/4"	.84	3/8" — 3/8" — — 1"
28	35BS28HT	3.550	3/4"	.88	3/8" — 3/8" — — 1"
30	35BS30HT	3.790	3/4"	.96	3/8" — 3/8" — — 1"

*Indicates no keyway.
 (2) 1/4" setscrews only in 1/2" & 3/8" bore at 90°.
 †Setscrews at 90° and 180° to key.

NOTE: KEYWAY IS ON CENTER LINE OF TOOTH.

Martin stock hardened teeth sprockets afford longer chain and sprocket life. Hardened teeth on the smaller sprocket of a roller chain drive are recommended if the drive ratio is four to one or greater or if the smaller sprocket has 24 teeth or less and is running at a speed of over 600 R.P.M.

No. 35
3/8" Pitch

Stainless Steel
Stock Sprockets



Single-Type B — Stainless

Single-Type A

No. Teeth	Catalog Number	Outside Diameter	Type	Bore (inches)		Hub (inches)		Weight Lbs. (Approx.)	Type	Catalog Number	Stock Bore	Weight Lbs. (Approx.)
				Stock	Rec. Max.	Diameter	Length Thru					
9	35B9SS	1.260	B	3/8	3/8	27/32★	3/4	.10				
10	35B10SS	1.380	B	3/8	3/8	27/32★	3/4	.15				
11	35B11SS	1.500	B	3/8	3/8	1 1/16★	3/4	.20				
12	35B12SS	1.630	B	1/2	3/8	1 1/32★	3/4	.22				
13	35B13SS	1.750	B	1/2	3/8	1 1/4★	3/4	.25				
14	35B14SS	1.870	B	1/2	7/8	1 1/4	3/4	.26				
15	35B15SS	1.990	B	1/2	7/8	1 1/32	3/4	.30				
16	35B16SS	2.110	B	1/2	15/16	1 1/32	3/4	.40				
17	35B17SS	2.230	B	1/2	1 1/16	1 1/32	3/4	.43				
18	35B18SS	2.350	B	1/2	1 1/16	1 2/32	3/4	.50				
19	35B19SS	2.470	B	1/2	1 1/4	1 2/32	3/4	.56				
20	35B20SS	2.590	B	1/2	1 1/4	1 15/16	3/4	.68				
21	35B21SS	2.710	B	1/2	1 1/2	2	7/8	.80				
22	35B22SS	2.830	B	1/2	1 1/2	2	7/8	.82				
23	35B23SS	2.950	B	1/2	1 1/2	2	7/8	.87				
24	35B24SS	3.070	B	1/2	1 1/2	2	7/8	.89				
25	35B25SS	3.190	B	1/2	1 1/2	2	7/8	.91				
26	35B26SS	3.310	B	1/2	1 1/2	2	7/8	.93				
28	35B28SS	3.550	B	1/2	1 1/2	2	7/8	1.00				
30	35B30SS	3.790	B	1/2	1 1/2	2	7/8	1.06				
35	35B35SS	4.390	B	3/4	1 1/2	2 1/4	7/8	1.56				
40	35B40SS	4.990	B	3/4	1 1/2	2 1/4	1	1.70	A	35A40SS	19/32	1.04
45	35B45SS	5.590	B	3/4	1 1/2	2 1/4	1	2.18	A	35A45SS	1 1/32	1.26
60	35B60SS	7.380	B	3/4	1 1/2	2 1/4	1	3.00	A	35A60SS	23/32	2.10

★ Has recessed groove in hub for chain clearance.

Maximum bores shown will accommodate standard keyseat and setscrew over keyseat. Slightly larger bores are possible with no keyseat, shallow keyseat, or setscrew at angle to keyseat.

Sprockets altered at factory (rebored with keyway and setscrew added) will be supplied with stainless setscrew.

SPROCKETS

Alteration Charges

See current discount sheet for alteration charges.



STAINLESS STEEL

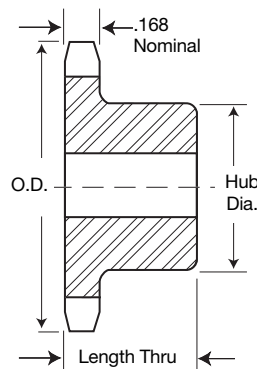

TYPE B

Single-Type B — Steel

Single-Type A

No. Teeth	Catalog Number	Outside Diameter	Type	Bore (inches)		Hub (inches)		Weight Lbs. (Approx.)	Type	Catalog Number	Stock Bore	Weight Lbs. (Approx.)
				Stock	Rec. Max.	Diameter	Length Thru					
8	35B8	1.130	B	3/8	3/8	3/4*	3/4	.07				
9	35B9	1.260	B	3/8	3/8	7/8*	3/4	.09				
10	35B10	1.380	B	3/8	3/8	1 1/8*	3/4	.14				
11	35B11	1.500	B	3/8	3/8	1 1/4*	3/4	.17				
12	35B12	1.630	B	1/2	1/2	1 1/2*	3/4	.20				
13	35B13	1.750	B	1/2	1/2	1 3/4*	3/4	.23				
14	35B14	1.870	B	1/2	1/2	1 7/8	3/4	.25				
15	35B15	1.990	B	1/2	1/2	1 1/2	3/4	.29	A	35A15	1/2	.10
16	35B16	2.110	B	1/2	1/2	1 5/8	3/4	.35	A	35A16	1/2	.12
17	35B17	2.230	B	1/2	1/2	1 3/4	3/4	.42	A	35A17	1/2	.12
18	35B18	2.350	B	1/2	1/2	1 7/8	3/4	.48	A	35A18	1/2	.14
19	35B19	2.470	B	1/2	1/2	1 1/2	3/4	.54	A	35A19	1/2	.16
20	35B20	2.590	B	1/2	1/2	1 5/8	3/4	.59	A	35A20	1/2	.20
21	35B21	2.710	B	1/2	1/2	2	7/8	.80	A	35A21	1/2	.20
22	35B22	2.830	B	1/2	1/2	2	7/8	.80	A	35A22	1/2	.22
23	35B23	2.950	B	1/2	1/2	2	7/8	.82	A	35A23	1/2	.24
24	35B24	3.070	B	1/2	1/2	2	7/8	.88	A	35A24	1/2	.26
25	35B25	3.190	B	1/2	1/2	2	7/8	.88	A	35A25	1/2	.28
26	35B26	3.310	B	1/2	1/2	2	7/8	.90	A	35A26	1/2	.28
27	35B27	3.430	B	1/2	1/2	2	7/8	.94	A	35A27	1/2	.34
28	35B28	3.550	B	1/2	1/2	2	7/8	.94	A	35A28	1/2	.34
30	35B30	3.790	B	1/2	1/2	2	7/8	1.02	A	35A30	1/2	.46
32	35B32	4.030	B	1/2	1/2	2	7/8	1.24	A	35A32	5/8	.46
35	35B35	4.390	B	3/4	1 1/2	2 1/4	7/8	1.50	A	35A35	3/4	.60
36	35B36	4.510	B	3/4	1 1/2	2 1/4	7/8	1.56	A	35A36	3/4	.62
40	35B40	4.990	B	3/4	1 1/2	2 1/4	1	1.62	A	35A40	1 1/2	.70
42	35B42	5.230	B	3/4	1 1/2	2 1/4	1	1.68	A	35A42	1 1/2	.78
45	35B45	5.590	B	3/4	1 1/2	2 1/4	1	1.78	A	35A45	1 1/2	.88
48	35B48	5.950	B	3/4	1 1/2	2 1/4	1	1.88	A	35A48	1 1/2	1.21
54	35B54	6.660	B	3/4	1 1/2	2 1/4	1	2.20	A	35A54	1 1/2	1.32
60	35B60	7.380	B	3/4	1 1/2	2 1/4	1	2.48	A	35A60	2 1/2	1.66
70	35B70	8.580	B	3/4	1 1/2	2 1/4	1	3.12	A	35A70	2 1/2	2.30
72	35B72	8.810	B	3/4	1 1/2	2 1/4	1	3.42	A	35A72	2 1/2	2.56
80	35B80	9.770	B	3/4	1 1/2	2 1/4	1	3.82	A	35A80	2 1/2	3.16
84	35B84	10.250	B	3/4	1 1/2	2 1/4	1	4.24	A	35A84	2 1/2	3.26
96	35B96	11.680	B	3/4	1 1/2	2 1/4	1	5.16	A	35A96	2 1/2	4.64
112	35B112	13.590	B	3/4	1 1/2	2 1/4	1	6.70	A	35A112	2 1/2	5.05

* Has recessed groove in hub for chain clearance.

Maximum bores shown will accommodate standard keyseat and setscrew over keyseat. Slightly larger bores are possible with no keyseat, shallow keyseat, or setscrew at angle to keyseat.

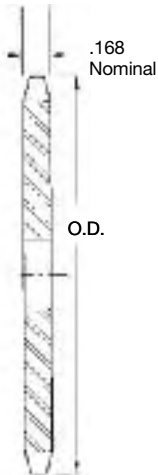

TYPE A



TYPE A

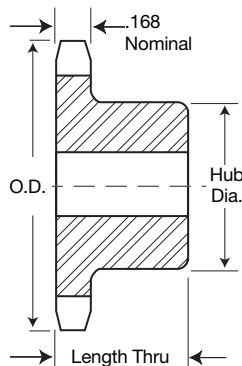

TYPE B



TYPE B

Alteration Charges

See current discount sheet for alteration charges.

No. 35
3/8" Pitch

All Steel
Stock Sprockets

Martin

Single-Taper Bushed

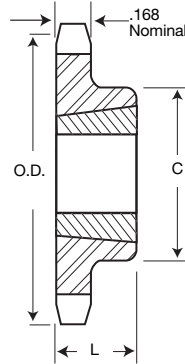

TYPE B

SPROCKETS

Single-Taper Bushed

No. Teeth	Catalog Number	Bushing	Diameter		Max. Bore	Dimensions		Type	Weight (Approx.)	
			Outside Diameter	Pitch Diameter		L	C		Rim Only	Bushing Only
18	35BTB18	1008	2.352	2.159	1	3/8	1 1/8*	B	.4	.3
19	35BTB19	1008	2.472	2.278	1	3/8	1 1/16	B	.5	.3
20	35BTB20	1008	2.593	2.397	1	3/8	1 1/16	B	.6	.3
21	35BTB21	1008	2.713	2.516	1	3/8	2 1/16	B	.7	.3
22	35BTB22	1210	2.883	2.635	1 1/4	1	2 3/8*	B	.8	.6
23	35BTB23	1210	2.954	2.754	1 1/4	1	2 3/8	B	.9	.6
24	35BTB24	1210	3.074	2.873	1 1/4	1	2 3/8	B	.9	.6
25	35BTB25	1210	3.194	2.992	1 1/4	1	2 3/8	B	1.2	.6
26	35BTB26	1610	3.314	3.111	1 1/2	1	2 7/8*	B	1.1	.9
28	35BTB28	1610	3.553	3.349	1 1/2	1	2 7/8	B	1.2	.9
30	35BTB30	1610	3.793	3.588	1 1/2	1	3 1/8	B	1.2	.9
32	35BTB32	1610	4.032	3.826	1 1/2	1	3 1/8	B	1.3	.9
35	35BTB35	1610	4.392	4.183	1 1/2	1	3 3/8	B	1.4	.9
36	35BTB36	1610	4.511	4.303	1 1/2	1	3 3/8	B	1.4	.9
40	35BTB40	1610	4.990	4.786	1 1/2	1	3 3/8	B	1.9	.9
42	35BTB42	1610	5.229	5.018	1 1/2	1	3 3/8	B	2.0	.9
45	35BTB45	1610	5.588	5.376	1 1/2	1	3 3/8	B	2.1	.9
48	35BTB48	1610	5.946	5.734	1 1/2	1	3 3/8	B	2.3	.9
54	35BTB54	1610	6.663	6.449	1 1/2	1	3 3/8	B	2.6	.9
60	35BTB60	1610	7.380	7.165	1 1/2	1	3 3/8	B	3.0	.9
70	35BTB70	1610	8.575	8.358	1 1/2	1	3 3/8	B	3.7	.9
72	35BTB72	1610	8.814	8.597	1 1/2	1	3 3/8	B	3.9	.9
80	35BTB80	1610	9.770	9.552	1 1/2	1	3 3/8	B	4.5	.9
84	35BTB84	1610	10.247	10.029	1 1/2	1	3 3/8	B	4.9	.9
96	35BTB96	1610	11.680	11.461	1 1/2	1	3 3/8	B	6.0	.9
112	35BTB112	1610	13.590	13.371	1 1/2	1	3 3/8	B	7.8	.9

* Has recessed groove in hub for chain clearance.

Single-Type QD

No. Teeth	Catalog Number	Bushing	Diameters		Type	Max. Bore	Dimensions							Weight (Approx.)	
			Outside Diameter	Pitch Diameter			L ₁	L ₂	C	Y	G	X	T	With Hub	Rim Only
19	35JA19	JA	2.470	2.278	B	1 1/4	1 1/8	1 1/8	2 1/16	53/64	29/64	5/8	.168	1.18	.28
20	35JA20	JA	2.590	2.397	B	1 1/4	1 1/8	1 1/8	2 1/16	53/64	29/64	5/8	.168	1.22	.32
21	35JA21	JA	2.710	2.516	B	1 1/4	1 1/8	1 1/8	2 1/16	53/64	29/64	5/8	.168	1.24	.34
22	35JA22	JA	2.830	2.635	B	1 1/4	1 1/8	1 1/8	2 1/16	53/64	29/64	5/8	.168	1.26	.36
23	35JA23	JA	2.950	2.754	B	1 1/4	1 1/8	1 1/8	2 1/16	53/64	29/64	5/8	.168	1.28	.38
24	35JA24	JA	3.070	3.873	B	1 1/4	1 1/8	1 1/8	2 1/16	53/64	29/64	5/8	.168	1.30	.40
25	35JA25	JA	3.190	2.992	B	1 1/4	1 1/8	1 1/8	2 1/16	53/64	29/64	5/8	.168	1.34	.44
26	35JA26	JA	3.310	3.111	B	1 1/4	1 1/8	1 1/8	2 1/16	53/64	29/64	5/8	.168	1.36	.46
27	35JA27	JA	3.430	3.230	B	1 1/4	1 1/8	1 1/8	2 1/16	53/64	29/64	5/8	.168	1.38	.48
28	35JA28	JA	3.550	3.349	B	1 1/4	1 1/8	1 1/8	2 1/16	53/64	29/64	5/8	.168	1.42	.52
30	35JA30	JA	3.790	3.588	B	1 1/4	1 1/8	1 1/8	2 1/16	53/64	29/64	5/8	.168	1.46	.56
32	35JA32	JA	4.030	3.826	B	1 1/4	1 1/8	1 1/8	2 1/16	53/64	29/64	5/8	.168	1.68	.78
35	35JA35	JA	4.390	4.183	B	1 1/4	1 1/8	1 1/8	2 1/16	53/64	29/64	5/8	.168	1.94	1.04
36	35SH36	SH	4.510	4.303	B	1 1/2	1 1/16	1 1/16	2 1/16	1 3/4	4 1/4	1 3/16	.168	2.06	1.06
40	35SH40	SH	4.990	4.780	B	1 1/2	1 1/16	1 1/16	2 1/16	1 3/4	4 1/4	1 3/16	.168	2.18	1.18
42	35SH42	SH	5.230	5.018	B	1 1/2	1 1/16	1 1/16	2 1/16	1 3/4	4 1/4	1 3/16	.168	2.26	1.26
45	35SH45	SH	5.590	5.376	B	1 1/2	1 1/16	1 1/16	2 1/16	1 3/4	4 1/4	1 3/16	.168	2.40	1.40
48	35SH48	SH	5.950	5.734	B	1 1/2	1 1/16	1 1/16	2 1/16	1 3/4	4 1/4	1 3/16	.168	2.58	1.58
54	35SH54	SH	6.660	6.449	B	1 1/2	1 1/16	1 1/16	2 1/16	1 3/4	4 1/4	1 3/16	.168	2.88	1.88
60	35SH60	SH	7.380	7.165	B	1 1/2	1 1/16	1 1/16	2 1/16	1 3/4	4 1/4	1 3/16	.168	3.28	2.28
70	35SH70	SH	8.580	8.358	B	1 1/2	1 1/16	1 1/16	2 1/16	1 3/4	4 1/4	1 3/16	.168	3.94	2.94
72	35SH72	SH	8.810	8.597	B	1 1/2	1 1/16	1 1/16	2 1/16	1 3/4	4 1/4	1 3/16	.168	4.14	3.14
80	35SH80	SH	9.770	9.552	B	1 1/2	1 1/16	1 1/16	2 1/16	1 3/4	4 1/4	1 3/16	.168	4.68	3.68
84	35SH84	SH	10.250	10.029	B	1 1/2	1 1/16	1 1/16	2 1/16	1 3/4	4 1/4	1 3/16	.168	4.86	3.96
96	35SH96	SH	11.680	11.461	B	1 1/2	1 1/16	1 1/16	2 1/16	1 3/4	4 1/4	1 3/16	.168	6.38	5.38
112	35SH112	SH	13.590	13.371	B	1 1/2	1 1/16	1 1/16	2 1/16	1 3/4	4 1/4	1 3/16	.168	7.60	6.60

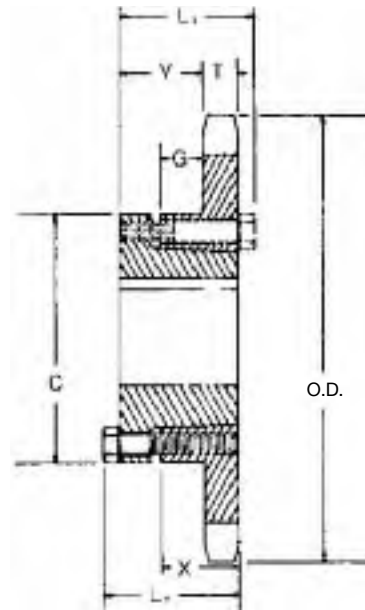

“QD” — TYPE B

No. 35
3/8" Pitch

MST®
Sprockets

Martin

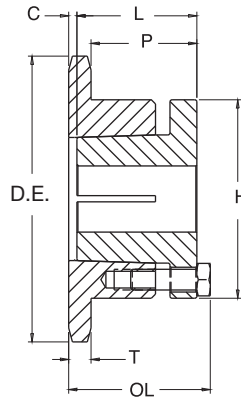

TIPO 3

SPROCKETS

Single - MST® Sprockets

No. Teeth	Catalog Number	Bush-ing	Diameters		Type	Max. Bore	Dimensions						Weight (Approx.)	
			Outside Dia.	Pitch Dia.			OL	L	C	H	P	T(nom)	With Hub	Rim Only
19	35H19	H	2.470	2.278	3	1-1/2	1-1/2	1-1/4	1/16	2-1/2	1-5/32	.168	1.3	.5
20	35H20	H	2.590	2.397	3	1-1/2	1-1/2	1-1/4	1/16	2-1/2	1-5/32	.168	1.3	.5
21	35H21	H	2.710	2.516	3	1-1/2	1-1/2	1-1/4	1/16	2-1/2	1-5/32	.168	1.4	.6
22	35H22	H	2.830	2.635	3	1-1/2	1-1/2	1-1/4	1/16	2-1/2	1-5/32	.168	1.5	.7
23	35H23	H	2.950	2.754	3	1-1/2	1-1/2	1-1/4	1/16	2-1/2	1-5/32	.168	1.5	.7
24	35H24	H	3.070	2.873	3	1-1/2	1-1/2	1-1/4	1/16	2-1/2	1-5/32	.168	1.6	.8
25	35H25	H	3.190	2.992	3	1-1/2	1-1/2	1-1/4	1/16	2-1/2	1-5/32	.168	1.6	.8
26	35H26	H	3.310	3.111	3	1-1/2	1-1/2	1-1/4	1/16	2-1/2	1-5/32	.168	1.6	.8
28	35H28	H	3.550	3.349	3	1-1/2	1-1/2	1-1/4	1/16	2-1/2	1-5/32	.168	1.7	.9
30	35H30	H	3.790	3.588	3	1-1/2	1-1/2	1-1/4	1/16	2-1/2	1-5/32	.168	1.7	.9
32	35H32	H	4.030	3.826	3	1-1/2	1-1/2	1-1/4	1/16	2-1/2	1-5/32	.168	1.7	.9
35	35H35	H	4.390	4.183	3	1-1/2	1-1/2	1-1/4	1/16	2-1/2	1-5/32	.168	1.8	1.0
36	35H36	H	4.510	4.303	3	1-1/2	1-1/2	1-1/4	1/16	2-1/2	1-5/32	.168	1.8	1.0
40	35H40	H	4.990	4.780	3	1-1/2	1-1/2	1-1/4	1/16	2-1/2	1-5/32	.168	2.0	1.2
42	35H42	H	5.230	5.018	3	1-1/2	1-1/2	1-1/4	1/16	2-1/2	1-5/32	.168	2.0	1.2
45	35H45	H	5.590	5.376	3	1-1/2	1-1/2	1-1/4	1/16	2-1/2	1-5/32	.168	2.2	1.4
48	35H48	H	5.950	5.734	3	1-1/2	1-1/2	1-1/4	1/16	2-1/2	1-5/32	.168	2.3	1.5
54	35H54	H	6.660	6.449	3	1-1/2	1-1/2	1-1/4	1/16	2-1/2	1-5/32	.168	2.6	1.8
60	35H60	H	7.380	7.165	3	1-1/2	1-1/2	1-1/4	1/16	2-1/2	1-5/32	.168	3.1	2.3
70	35H70	H	8.580	8.358	3	1-1/2	1-1/2	1-1/4	1/16	2-1/2	1-5/32	.168	3.6	2.8
72	35H72	H	8.810	8.597	3	1-1/2	1-1/2	1-1/4	1/16	2-1/2	1-5/32	.168	3.8	3.0
80	35H80	H	9.770	9.552	3	1-1/2	1-1/2	1-1/4	1/16	2-1/2	1-5/32	.168	4.6	3.8
84	35H84	H	10.250	10.029	3	1-1/2	1-1/2	1-1/4	1/16	2-1/2	1-5/32	.168	4.8	4.0
96	35H96	H	11.680	11.461	3	1-1/2	1-1/2	1-1/4	1/16	2-1/2	1-5/32	.168	6.1	5.3
112	35H112	H	13.590	13.371	3	1-1/2	1-1/2	1-1/4	1/16	2-1/2	1-5/32	.168	7.6	6.8

Double-Type B

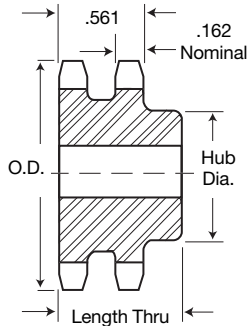

TYPE B

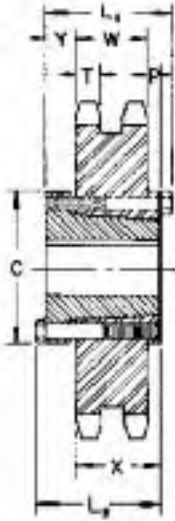

"QD" — TYPE C

No. Teeth	Catalog Number	Outside Diameter	Type	Bore (inches)		Hub (inches)		Weight Lbs. (Approx.)
				Stock	Rec. Max.	Dia.	Length Thru	
12	D35B12H	1.630	B	1/2	5/16	3/4	1 1/4	.32
13	D35B13H	1.750	B	1/2	11/16	1 1/4	1 1/4	.36
14	D35B14H	1.870	B	1/2	3/8	1 1/4	1 1/4	.44
15	D35B15H	1.990	B	1/2	5/16	1 1/2	1 1/4	.56
16	D35B16H	2.110	B	1/2	5/16	1 5/16	1 1/4	.64
17	D35B17H	2.230	B	1/2	1 1/16	1 5/16	1 1/4	.74
18	D35B18H	2.350	B	1/2	1 1/16	1 7/16	1 1/4	.84
19	D35B19H	2.470	B	1/2	1 1/16	1 7/8	1 1/4	.96
20	D35B20H	2.590	B	3/4	1 1/16	1 5/8	1 1/4	1.08
21	D35B21H	2.710	B	3/4	1 1/8	2 1/16	1 1/4	1.24
22	D35B22H	2.830	B	3/4	1 1/8	2 1/8	1 1/4	1.42
23	D35B23H	2.950	B	3/4	1 1/8	2 1/4	1 1/4	1.54
24	D35B24H	3.070	B	3/4	1 1/2	2 1/4	1 1/4	1.62
25	D35B25H	3.190	B	3/4	1 1/2	2 1/2	1 1/4	1.66
26	D35B26	3.310	B	3/4	1 3/4	2 1/2	1 1/4	1.98
30	D35B30	3.790	B	3/4	1 3/4	2 1/2	1 1/4	2.34
36	D35B36	4.510	B	3/4	1 3/4	2 1/2	1 1/4	3.00
42	D35B42	5.230	B	3/4	1 3/4	2 1/2	1 1/4	3.80
48	D35B48	5.950	B	3/4	1 3/4	2 1/2	1 1/4	4.66
52	D35B52	6.430	B	3/4	1 3/4	2 1/2	1 1/4	5.40
60	D35B60	7.380	B	3/4	1 3/4	2 1/2	1 1/4	6.84
68	D35B68	8.340	B	3/4	2 1/8	3 1/2	1 1/2	10.01
72	D35B72	8.810	B	3/4	2 1/8	3 1/2	1 1/2	11.04
76	D35B76	9.290	B	3/4	2 1/8	3 1/2	1 1/2	11.94
84	D35B84	10.250	B	3/4	2 1/8	3 1/2	1 1/2	14.98
95	D35B95	11.560	B	1	2 3/8	3 1/2	1 1/2	17.42
96	D35B96	11.680	B	1	2 3/8	3 1/2	1 1/2	18.14
102	D35B102	12.400	B	1	2 3/8	3 1/2	1 1/2	19.92

Maximum bores shown will accommodate standard keyseat and setscrew over keyseat. Slightly larger bores are possible with no keyseat, shallow keyseat, or setscrew at angle to keyseat. Sprockets with "H" suffix have hardened teeth.

Double-Taper Bushed

No. Teeth	Catalog Number	Bushing	Diameters		Max. Bore	Dimensions			Weight (Approx.)	
			Outside Diameter	Pitch Diameter		L	C	Type	Rim Only	Bushing Only
19	D35BTB19H	1008	2.472	2.278	1	3/8	1 5/16	B	.6	.3
20	D35BTB20H	1008	2.593	2.397	1	3/8	1 15/16	B	.8	.3
21	D35BTB21H	1008	2.713	2.516	1	3/8	2 1/16	B	1.4	.3
22	D35BTB22H	1008	2.833	2.635	1	3/8	2 3/16	B	1.7	.3
24	D35BTB24H	1210	3.074	2.873	1 1/4	1	2 1/16	B	1.8	.6
26	D35BTB26	1210	3.314	3.111	1 1/4	1	2 1/8	B	2.0	.6
30	D35BTB30	1610	3.793	3.588	1 1/2	1	3 1/8	B	1.8	.9
32	D35BTB32	1610	4.032	3.826	1 1/2	1	3 1/4	B	2.0	.9
35	D35BTB35	1610	4.392	4.183	1 1/2	1	3 1/4	B	2.3	.9
40	D35BTB40	1610	4.990	4.780	1 1/2	1	3 1/4	B	2.9	.9
45	D35BTB45	1610	5.588	5.376	1 1/2	1	3 1/4	B	3.2	.9
48	D35BTB48	1610	5.946	5.734	1 1/2	1	3 3/8	B	3.5	.9
54	D35BTB54	1610	6.663	6.449	1 1/2	1	3 3/8	B	3.9	.9
60	D35BTB60	1610	7.380	7.165	1 1/2	1	3 3/8	B	4.9	.9
70	D35BTB70	1610	8.575	8.358	1 1/2	1	3 3/8	B	6.3	.9
80	D35BTB80	1610	9.770	9.552	1 1/2	1	3 3/8	B	7.9	.9
96	D35BTB96	1610	11.680	11.461	1 1/2	1	3 3/8	B	9.9	.9
112	D35BTB112	1610	13.590	13.371	1 1/2	1	3 3/8	B	10.9	.9

Sprockets with "H" suffix have hardened teeth.

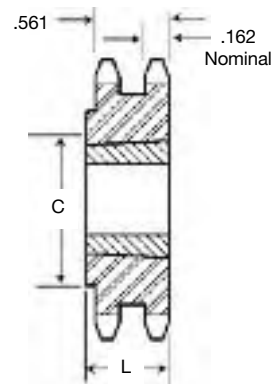

TAPER BUSHED
TYPE B

Double-Type QD

No. Teeth	Catalog Number	Bush-ing	Diameters		Type	Max. Bore	Dimensions								Weight (Approx.)	
			Outside Diameter	Pitch Diameter			L ₁	L ₂	C	Y	P	X	T	W	With Hub	Rim Only
68	D35SDS68	SDS	8.340	8.120	C	2	1 1/2	1 1/2	3 3/16	3/16	3/16	3/8	.162	.561	8.40	7.40
72	D35SDS72	SDS	8.810	8.597	C	2	1 1/2	1 1/2	3 3/16	3/16	3/16	3/8	.162	.561	9.28	8.28
76	D35SDS76	SDS	9.290	9.074	C	2	1 1/2	1 1/2	3 3/16	3/16	3/16	3/8	.162	.561	10.32	9.32
84	D35SK84	SK	10.250	10.029	C	2 1/2	2 1/2	2 1/2	3 3/8	3/8	1 1/16	1 1/4	.162	.561	13.94	11.94
95	D35SK95	SK	11.560	11.342	C	2 1/2	2 1/2	2 1/2	3 3/8	3/8	1 1/16	1 1/4	.162	.561	17.22	15.22
96	D35SK96	SK	11.680	11.461	C	2 1/2	2 1/2	2 1/2	3 3/8	3/8	1 1/16	1 1/4	.162	.561	17.74	15.74
102	D35SK102	SK	12.400	12.177	C	2 1/2	2 1/2	2 1/2	3 3/8	3/8	1 1/16	1 1/4	.162	.561	19.76	17.76

No. 35-3

3/8" Pitch

All Steel Stock Sprockets

Martin

Triple-Type B

No. Teeth	Catalog Number	Outside Diameter	Type	Bore (inches)		Hub (inches)		Weight Lbs. (Approx.)
				Stock	Rec. Max.	Dia.	Length Thru	
13	E35B13H	1.750	B	1/2	11/16	1 1/4	1 1/4	.50
14	E35B14H	1.870	B	1/2	7/8	1 1/4	1 1/4	.62
15	E35B15H	1.990	B	1/2	15/16	1 13/32	1 1/4	.78
16	E35B16H	2.110	B	1/2	15/16	1 15/32	1 1/4	.82
17	E35B17H	2.230	B	1/2	1 1/8	1 19/32	1 1/4	1.04
18	E35B18H	2.350	B	1/2	1 1/8	1 21/32	1 1/4	1.22
19	E35B19H	2.470	B	1/2	1 1/8	1 1/4	1 1/4	1.40
20	E35B20H	2.590	B	3/4	1 1/8	1 15/16	1 1/4	1.50
21	E35B21H	2.710	B	3/4	1 1/8	2 1/16	1 1/4	1.72
22	E35B22H	2.830	B	3/4	1 1/8	2 3/16	1 1/4	1.96
23	E35B23H	2.950	B	3/4	1 1/2	2 1/4	1 1/4	2.12
24	E35B24H	3.070	B	3/4	1 1/2	2 1/4	1 1/4	2.26
25	E35B25H	3.190	B	3/4	1 1/2	2 1/4	1 1/4	2.42
26	E35B26	3.310	B	3/4	1 1/2	2 1/2	1 1/4	2.78
30	E35B30	3.790	B	3/4	1 1/2	2 1/2	1 1/4	3.42
36	E35B36	4.510	B	3/4	1 1/2	2 1/2	1 1/4	4.52
42	E35B42	5.230	B	3/4	1 1/2	2 1/2	1 1/4	5.88
48	E35B48	5.950	B	3/4	1 1/2	2 1/2	1 1/4	7.42
52	E35B52	6.430	B	3/4	1 1/2	2 1/2	1 1/4	8.52
60	E35B60	7.380	B	3/4	1 1/2	2 1/2	1 1/4	11.22
68	E35B68	8.340	B	3/4	2 1/8	3 1/2	1 1/4	15.38
72	E35B72	8.810	B	3/4	2 1/8	3 1/2	1 1/4	17.34
76	E35B76	9.290	B	3/4	2 1/8	3 1/2	1 1/4	18.90
84	E35B84	10.250	B	3/4	2 1/8	3 1/2	1 1/4	22.82
95	E35B95	11.560	B	1	2 1/2	3 3/4	2 1/4	29.32
96	E35B96	11.680	B	1	2 1/2	3 3/4	2 1/4	30.06
102	E35B102	12.400	B	1	2 1/2	3 3/4	2 1/4	33.36

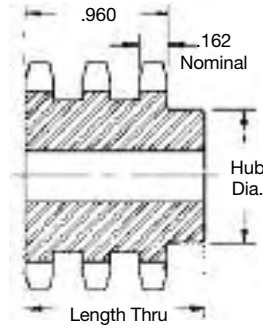

TYPE B

Alteration Charges

See current discount sheet for alteration charges.

Maximum bores shown will accommodate standard keyseat and setscrew over keyseat. Slightly larger bores are possible with no keyseat, shallow keyseat, or setscrew at angle to keyseat.

NOTE: Triple 35 stock sprockets with 25 teeth or less have hardened teeth. Sprockets with "H" suffix have hardened teeth.

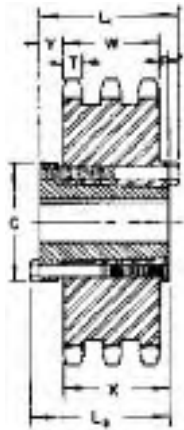

"QD" — TYPE C

Triple-Type QD

No. Teeth	Catalog Number	Bush-ing	Diameters		Type	Max. Bore	Dimensions								Weight (Approx.)	
			Outside Diameter	Pitch Diameter			L ₁	L ₂	C	Y	P	X	T	W	With Hub	Rim Only
68	E35SK68	SK	8.340	8.120	C	2 1/8	2 1/2	2 1/2	3 3/8	5/8	1 1/4	1 1/4	.162	.960	13.90	11.90
72	E35SK72	SK	8.810	8.597	C	2 1/8	2 1/2	2 1/2	3 3/8	5/8	1 1/4	1 1/4	.162	.960	15.56	13.56
76	E35SK76	SK	9.290	9.074	C	2 1/8	2 1/2	2 1/2	3 3/8	5/8	1 1/4	1 1/4	.162	.960	17.42	15.42
84	E35SK84	SK	10.250	10.029	C	2 1/8	2 1/2	2 1/2	3 3/8	5/8	1 1/4	1 1/4	.162	.960	20.92	18.92
95	E35SK95	SK	11.560	11.342	C	2 1/2	2 1/2	2 1/2	3 3/8	5/8	1 1/4	1 1/4	.162	.960	26.76	24.76
96	E35SK96	SK	11.680	11.461	C	2 1/2	2 1/2	2 1/2	3 3/8	5/8	1 1/4	1 1/4	.162	.960	27.58	25.58
102	E35SK102	SK	12.400	12.177	C	2 1/2	2 1/2	2 1/2	3 3/8	5/8	1 1/4	1 1/4	.162	.960	31.18	29.18

Single-Type "BS" — 2 Setscrews — Bored-To-Size

No. Teeth	Catalog Number	Outside Diameter	Length Thru Bore	Weight Lbs. (Approx.)	Stock Finished Bores Includes Keyway and 2 Setscrews
9	41BS9	1.670	3/8	.20	— 1/2 — 3/8
10	41BS10	1.840	3/8	.25	— 1/2 — 3/8
11	41BS11	2.000	3/8	.32	— 1/2 — 3/8 — 1/2
12	41BS12	2.170	3/8	.33	— 1/2 — 3/8 — 3/4 — 1/2
13	41BS13	2.330	3/8	.43	— 1/2 — 3/8 — 3/4 — 7/8 — 1
14	41BS14	2.490	3/8	.48	— 1/2 — 3/8 — 3/4 — 7/8 — 1
15	41BS15	2.650	3/8	.59	— 1/2 — 3/8 — 3/4 — 7/8 — 1
16	41BS16	2.810	3/8	.72	— 3/4 — 3/4 — 7/8 — 1
17	41BS17	2.970	1	1.00	— 3/4 — 3/4 — 7/8 — 1
18	41BS18	3.140	1	1.10	— 3/4 — 3/4 — 7/8 — 1
19	41BS19	3.300	1	1.21	— 3/4 — 3/4 — 7/8 — 1
20	41BS20	3.460	1	1.39	— 3/4 — 3/4 — 7/8 — 1
21	41BS21	3.620	1	1.77	— 3/4 — 3/4 — 7/8 — 1
22	41BS22	3.780	1	1.92	— 3/4 — 3/4 — 7/8 — 1
23	41BS23	3.940	1	2.18	— 3/4 — 3/4 — 7/8 — 1
24	41BS24	4.100	1	2.24	— 3/4 — 3/4 — 7/8 — 1
25	41BS25	4.260	1	2.42	— 3/4 — 3/4 — 7/8 — 1
26	41BS26	4.420	1	2.46	— 3/4 — 3/4 — 7/8 — 1
27	41BS27	4.580	1	2.52	— 3/4 — 3/4 — 7/8 — 1
28	41BS28	4.740	1	2.60	— 3/4 — 3/4 — 7/8 — 1
30	41BS30	5.060	1	2.76	— 3/4 — 3/4 — 7/8 — 1
32	41BS32	5.380	1	2.92	— 3/4 — 3/4 — 7/8 — 1
35	41BS35	5.860	1	3.08	— 3/4 — 3/4 — 7/8 — 1
36	41BS36	6.020	1	3.28	— 3/4 — 3/4 — 7/8 — 1
40	41BS40	6.650	1 1/8	3.82	— 3/4 — 7/8 — 1 — 1 1/8 — 1 1/8 — 1 1/4 — 1 1/4 — 1 1/2 — 1 1/2
42	41BS42	6.970	1 1/8	3.68	— 3/4 — 7/8 — 1 — 1 1/8 — 1 1/8 — 1 1/4 — 1 1/4 — 1 1/2 — 1 1/2
45	41BS45	7.450	1 1/8	3.94	— 3/4 — 7/8 — 1 — 1 1/8 — 1 1/8 — 1 1/4 — 1 1/4 — 1 1/2 — 1 1/2
48	41BS48	7.930	1 1/8	4.68	— 3/4 — 7/8 — 1 — 1 1/8 — 1 1/8 — 1 1/4 — 1 1/4 — 1 1/2 — 1 1/2
54	41BS54	8.880	1 1/8	5.44	— 3/4 — 7/8 — 1 — 1 1/8 — 1 1/8 — 1 1/4 — 1 1/4 — 1 1/2 — 1 1/2
60	41BS60	9.840	1 1/8	6.54	— 3/4 — 7/8 — 1 — 1 1/8 — 1 1/8 — 1 1/4 — 1 1/4 — 1 1/2 — 1 1/2
70	41BS70	11.430	1 3/8	9.28	— 3/4 — 7/8 — 1 — 1 1/8 — 1 1/8 — 1 1/4 — 1 1/4 — 1 1/2 — 1 1/2
72	41BS72	11.750	1 3/8	9.38	— 3/4 — 7/8 — 1 — 1 1/8 — 1 1/8 — 1 1/4 — 1 1/4 — 1 1/2 — 1 1/2
80	41BS80	13.030	1 3/8	11.28	— 3/4 — 7/8 — 1 — 1 1/8 — 1 1/8 — 1 1/4 — 1 1/4 — 1 1/2 — 1 1/2
84	41BS84	13.660	1 3/8	11.94	— 3/4 — 7/8 — 1 — 1 1/8 — 1 1/8 — 1 1/4 — 1 1/4 — 1 1/2 — 1 1/2
96	41BS96	15.570	1 3/8	14.51	1 — 1 1/8 — 1 1/8 — 1 1/4 — 1 1/4 — 1 1/2 — 1 1/2
112	41BS112	18.120	1 3/8	18.81	1 — 1 1/8 — 1 1/8 — 1 1/4 — 1 1/4 — 1 1/2 — 1 1/2

*Indicates no keyway. (2) 1/4" Setscrews only in 1/2" bore.
Hub diameters vary to suit different bore sizes.

NOTE: KEYWAY IS ON CENTER LINE OF TOOTH.



BORED-TO-SIZE

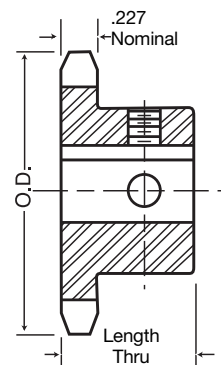

TYPE BS

No. 41

1/2" Pitch

All Steel Stock Sprockets



Single-Type B

Single-Type A

No. Teeth	Catalog Number	Outside Diameter	Type	Bore (inches)		Hub (inches)		Weight Lbs. (Approx.)	Type	Catalog Number	Stock Bore	Weight Lbs. (Approx.)
				Stock	Rec. Max.	Diameter	Length Thru					
6	41B6	1.170	B	3/8	3/8	2 1/32*	3/8	.07				
7	41B7	1.340	B	3/8	3/8	3/4*	3/8	.10				
8	41B8	1.510	B	1/2	1/2	63/64*	3/8	.19				
9	41B9	1.670	B	1/2	3/4	1 1/8*	3/8	.20				
10	41B10	1.840	B	1/2	3/4	1 1/4*	3/8	.27				
11	41B11	2.000	B	1/2	3/4	1 1/2*	3/8	.35				
12	41B12	2.170	B	1/2	5/8	1 5/8*	3/8	.44				
13	41B13	2.330	B	1/2	1	1 3/4	3/8	.50				
14	41B14	2.490	B	1/2	1 1/4	1 3/4	3/8	.57				
15	41B15	2.650	B	1/2	1 1/2	1 7/8	3/8	.72	A	41A15	5/8	.28
16	41B16	2.810	B	3/4	1 1/2	2 1/8	3/8	.91	A	41A16	5/8	.34
17	41B17	2.970	B	3/4	1 3/4	2 1/4	1	1.09	A	41A17	5/8	.36
18	41B18	3.140	B	3/4	1 3/4	2 3/8	1	1.25	A	41A18	5/8	.44
19	41B19	3.300	B	3/4	1 3/4	2 1/2	1	1.49	A	41A19	5/8	.46
20	41B20	3.460	B	3/4	1 3/4	2 3/4	1	1.64	A	41A20	5/8	.52
21	41B21	3.620	B	3/4	1 3/4	2 3/4	1	1.81	A	41A21	5/8	.60
22	41B22	3.780	B	3/4	2	3	1	1.93	A	41A22	5/8	.66
23	41B23	3.940	B	3/4	2 1/4	3 3/8	1	2.25	A	41A23	5/8	.72
24	41B24	4.100	B	3/4	2 1/4	3 1/2	1	2.33	A	41A24	5/8	.82
25	41B25	4.260	B	3/4	2 1/4	3 1/2	1	2.46	A	41A25	5/8	.88
26	41B26	4.420	B	3/4	2 1/2	3 3/4	1	2.50	A	41A26	5/8	.94
27	41B27	4.580	B	3/4	2 1/2	3 3/4	1	2.56	A	41A27	5/8	1.00
28	41B28	4.740	B	3/4	2 1/2	3 3/4	1	2.64	A	41A28	5/8	1.08
30	41B30	5.060	B	3/4	2 1/2	3 3/4	1	2.80	A	41A30	19/32	1.20
32	41B32	5.380	B	3/4	2 1/2	3 3/4	1	2.96	A	41A32	19/32	1.44
35	41B35	5.860	B	3/4	2 3/4	3 3/4	1	3.12	A	41A35	19/32	1.70
36	41B36	6.020	B	3/4	2 3/4	3 3/4	1	3.32	A	41A36	19/32	1.84
40	41B40	6.650	B	3/4	2 3/4	3 3/4	1 1/8	4.06	A	41A40	23/32	2.22
42	41B42	6.970	B	3/4	2 3/4	3 1/2	1 1/8	4.10	A	41A42	23/32	2.50
45	41B45	7.450	B	3/4	2 3/4	3 1/2	1 1/8	4.18	A	41A45	23/32	2.52
48	41B48	7.930	B	3/4	2 3/4	3 1/2	1 1/8	4.92	A	41A48	23/32	2.92
54	41B54	8.880	B	3/4	2 3/4	3 1/2	1 1/8	5.68	A	41A54	23/32	3.54
60	41B60	9.840	B	3/4	2 3/4	3 1/2	1 1/8	6.78	A	41A60	23/32	4.60
70	41B70	11.430	B	3/4	2 3/4	4	1 1/8	9.54	A	41A70	23/32	6.22
72	41B72	11.750	B	3/4	2 3/4	4	1 1/8	9.64	A	41A72	23/32	6.32
80	41B80	13.030	B	3/4	2 3/4	4	1 1/8	11.54	A	41A80	23/32	8.46
84	41B84	13.660	B	3/4	2 3/4	4	1 1/8	12.20	A	41A84	23/32	9.12
96	41B96	15.570	B	1	2 3/4	4	1 1/8	14.86	A	41A96	15/16	11.84
112	41B112	18.120	B	1	2 3/4	4	1 1/8	19.16	A	41A112	15/16	15.84

* Has recessed groove in hub for chain clearance.

Maximum bores shown will accommodate standard keyseat and setscrew over keyseat.
Slightly larger bores are possible with no keyseat, shallow keyseat, or setscrew at angle to keyseat.

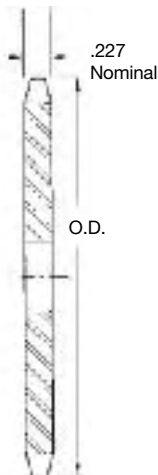

TYPE A

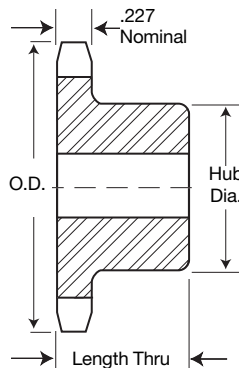

TYPE B

SPROCKETS

Single-Taper Bushed

No. Teeth	Catalog Number	Bushing	Diameters		Max. Bore	Dimensions		Type	Weight (Approx.)	
			Outside Diameter	Pitch Diameter		L	C		Rim Only	Bushing Only
14	41BTB14	1008	2.49	2.247	1	3/8	1 1/8*	B	.4	.3
15	41BTB15	1008	2.65	2.405	1	3/8	1 1/8	B	.5	.3
16	41BTB16	1008	2.81	2.503	1	3/8	2	B	.6	.3
17	41BTB17	1210	2.97	2.721	1 1/4	1	2 3/8*	B	.7	.6
18	41BTB18	1210	3.14	2.879	1 1/4	1	2 3/8	B	.9	.6
19	41BTB19	1210	3.30	3.038	1 1/4	1	2 1/2	B	1.1	.6
20	41BTB20	1610	3.46	3.196	1 1/2	1	2 7/8*	B	1.1	.9
21	41BTB21	1610	3.62	3.355	1 1/2	1	3*	B	1.2	.9
22	41BTB22	1610	3.78	3.513	1 1/2	1	3	B	1.3	.9
23	41BTB23	1610	3.94	3.672	1 1/2	1	3	B	1.4	.9
24	41BTB24	1610	4.10	3.831	1 1/2	1	3	B	1.4	.9
25	41BTB25	1610	4.26	3.989	1 1/2	1	3	B	1.5	.9
26	41BTB26	1610	4.42	4.148	1 1/2	1	3	B	1.5	.9
28	41BTB28	1610	4.74	4.466	1 1/2	1	3	B	1.7	.9
30	41BTB30	1610	5.06	4.783	1 1/2	1	3	B	1.8	.9
32	41BTB32	1610	5.38	5.101	1 1/2	1	3	B	1.9	.9
35	41BTB35	1610	5.86	5.578	1 1/2	1	3	B	2.3	.9
36	41BTB36	1610	6.02	5.737	1 1/2	1	3	B	2.4	.9
40	41BTB40	1610	6.65	6.373	1 1/2	1	3	B	2.7	.9
45	41BTB45	1610	7.45	7.168	1 1/2	1	3	B	3.5	.9
48	41BTB48	1610	7.93	7.645	1 1/2	1	3	B	4.1	.9
54	41BTB54	1610	8.88	8.599	1 1/2	1	3	B	4.9	.9
60	41BTB60	1610	9.84	9.554	1 1/2	1	3	B	5.7	.9
70	41BTB70	1610	11.43	11.145	1 1/2	1	3	B	7.4	.9
72	41BTB72	1610	11.75	11.463	1 1/2	1	3	B	8.2	.9
80	41BTB80	1610	13.03	12.736	1 1/2	1	3	B	9.6	.9
96	41BTB96	1610	15.57	15.282	1 1/2	1	3	B	13.1	.9

* Has recessed groove in hub for chain clearance.

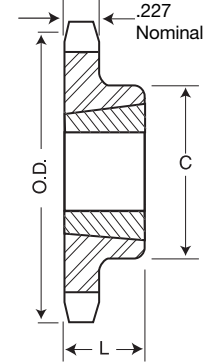

TAPER BUSHED
TYPE B



Single-Type QD

No. Teeth	Catalog Number	Bushing	Diameters		Type	Max. Bore	Dimensions							Weight (Approx.)	
			Outside Diameter	Pitch Diameter			L ₁	L ₂	C	Y	G	X	T	With Hub	Rim Only
15	41JA15	JA	2.650	2.405	B	1 1/4	1 1/8	1 1/8	2 1/16	9/64	3/64	5/16	.227	1.22	.32
16	41JA16	JA	2.810	2.563	B									1.30	.40
17	41JA17	JA	2.980	2.721	B									1.40	.50
18	41JA18	JA	3.140	2.879	B									1.50	.60
19	41JA19	JA	3.300	3.038	B	1 1/4	1 1/8	1 1/8	2 1/16	9/64	3/64	5/16	.227	1.58	.68
20	41SH20	SH	3.460	3.196	B	1 1/2	1 1/16	1 1/16	2 1/16	1 1/32	3/64	1/16	.227	1.78	.78
21	41SH21	SH	3.620	3.355	B									1.82	.82
22	41SH22	SH	3.780	3.513	B									2.06	1.06
23	41SH23	SH	3.940	3.672	B									2.14	1.14
24	41SH24	SH	4.100	3.831	B									2.16	1.16
25	41SH25	SH	4.260	3.989	B									2.22	1.22
26	41SH26	SH	4.420	4.148	B									2.26	1.26
27	41SH27	SH	4.580	4.307	B									2.40	1.40
28	41SH28	SH	4.740	4.466	B									2.54	1.54
30	41SH30	SH	5.060	4.783	B									2.58	1.58
32	41SH32	SH	5.380	5.101	B									2.68	1.68
35	41SH35	SH	5.860	5.578	B	1 1/2	1 1/16	1 1/16	2 1/16	1 1/32	3/64	1/16	.227	3.46	2.47
36	41SDS36	SDS	6.020	5.737	B	2	1 1/2	1 1/2	3 1/16	1 1/32	1/2	5/16	.227	2.92	1.92
40	41SDS40	SDS	6.650	6.373	B									3.32	2.32
42	41SDS42	SDS	6.970	6.691	B									3.44	2.44
45	41SDS45	SDS	7.450	7.168	B									3.76	2.76
48	41SDS48	SDS	7.930	7.645	B									4.36	3.36
54	41SDS54	SDS	8.890	8.599	B									4.98	3.98
60	41SDS60	SDS	9.840	9.554	B	2	1 1/2	1 1/2	3 3/16	1 1/32	1/2	5/16	.227	6.54	5.54
70	41SK70	SK	11.430	11.145	B	2 1/2	2 1/2	2 1/2	3 3/8	1 3/4	1 1/2	1 1/4	.227	9.42	7.42
72	41SK72	SK	11.750	11.463	B									10.02	8.02
80	41SK80	SK	13.030	12.736	B									11.64	9.64
84	41SK84	SK	13.660	13.372	B									12.40	10.40
96	41SK96	SK	15.570	15.281	B									14.82	12.82
112	41SK112	SK	18.120	17.828	B	2 1/2	2 1/2	2 1/2	3 3/8	1 3/4	1 1/2	1 1/4	.227	19.28	17.28

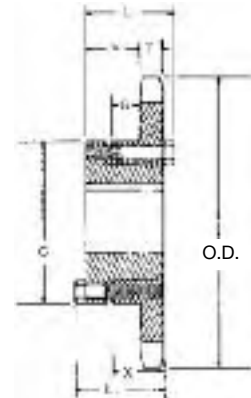

"QD" — TYPE B



SPROCKETS

No. 40

1/2" Pitch

All Steel Stock Sprockets



Single-Type "BS" — 2 Setscrews — Bored-To-Size

No. Teeth	Catalog Number	Outside Diameter	Length Thru Bore	Weight Lbs. (Approx.)	Stock Finished Bores Includes Keyway and 2 Setscrews
9	40BS9	1.670	7/8	.16	*1/2 - 3/8
10	40BS10	1.840	7/8	.24	*1/2 - 3/8 - 3/8
11	40BS11	2.000	7/8	.28	*1/2 - 3/8 - 3/8 - 3/8
12	40BS12	2.170	7/8	.34	*1/2 - 3/8 - 3/8 - 3/8 - 1
13	40BS13	2.330	7/8	.45	*1/2 - 3/8 - 3/8 - 3/8 - 1
14	40BS14	2.490	7/8	.51	*1/2 - 3/8 - 3/8 - 3/8 - 1 - 1/8
15	40BS15	2.650	7/8	.53	*1/2 - 3/8 - 3/8 - 3/8 - 1 - 1/8 - 1/8 - 1/8
16	40BS16	2.810	7/8	.66	3/8 - 3/8 - 3/8 - 1 - 1/8 - 1/8 - 1/8 - 1/8
17	40BS17	2.970	1	.88	3/8 - 3/8 - 3/8 - 1 - 1/8 - 1/8 - 1/8 - 1/8
18	40BS18	3.140	1	1.03	3/8 - 3/8 - 3/8 - 1 - 1/8 - 1/8 - 1/8 - 1/8 - 1/8 - 1/8 - 1/8
19	40BS19	3.300	1	1.17	3/8 - 3/8 - 3/8 - 1 - 1/8 - 1/8 - 1/8 - 1/8 - 1/8 - 1/8 - 1/8
20	40BS20	3.460	1	1.33	3/8 - 3/8 - 3/8 - 1 - 1/8 - 1/8 - 1/8 - 1/8 - 1/8 - 1/8 - 1/8
21	40BS21	3.620	1	1.53	3/8 - 3/8 - 3/8 - 1 - 1/8 - 1/8 - 1/8 - 1/8 - 1/8 - 1/8 - 1/8
22	40BS22	3.780	1	1.66	3/8 - 3/8 - 3/8 - 1 - 1/8 - 1/8 - 1/8 - 1/8 - 1/8 - 1/8 - 1/8
23	40BS23	3.940	1	1.92	3/8 - 3/8 - 3/8 - 1 - 1/8 - 1/8 - 1/8 - 1/8 - 1/8 - 1/8 - 1/8
24	40BS24	4.100	1	2.10	3/8 - 3/8 - 3/8 - 1 - 1/8 - 1/8 - 1/8 - 1/8 - 1/8 - 1/8 - 1/8
25	40BS25	4.260	1	2.22	3/8 - 3/8 - 3/8 - 1 - 1/8 - 1/8 - 1/8 - 1/8 - 1/8 - 1/8 - 1/8
26	40BS26	4.420	1	2.34	3/8 - 3/8 - 3/8 - 1 - 1/8 - 1/8 - 1/8 - 1/8 - 1/8 - 1/8 - 1/8
27	40BS27	4.580	1	2.42	3/8 - 3/8 - 3/8 - 1 - 1/8 - 1/8 - 1/8 - 1/8 - 1/8 - 1/8 - 1/8
28	40BS28	4.740	1	2.50	3/8 - 3/8 - 3/8 - 1 - 1/8 - 1/8 - 1/8 - 1/8 - 1/8 - 1/8 - 1/8
29	40BS29	4.900	1	2.60	3/8 - 3/8 - 3/8 - 1 - 1/8 - 1/8 - 1/8 - 1/8 - 1/8 - 1/8 - 1/8
30	40BS30	5.060	1	2.70	3/8 - 3/8 - 3/8 - 1 - 1/8 - 1/8 - 1/8 - 1/8 - 1/8 - 1/8 - 1/8
31	40BS31	5.220	1	2.88	3/8 - 3/8 - 3/8 - 1 - 1/8 - 1/8 - 1/8 - 1/8 - 1/8 - 1/8 - 1/8
32	40BS32	5.380	1	3.00	3/8 - 3/8 - 3/8 - 1 - 1/8 - 1/8 - 1/8 - 1/8 - 1/8 - 1/8 - 1/8
33	40BS33	5.540	1	3.03	3/8 - 3/8 - 3/8 - 1 - 1/8 - 1/8 - 1/8 - 1/8 - 1/8 - 1/8 - 1/8
34	40BS34	5.700	1	3.11	3/8 - 3/8 - 3/8 - 1 - 1/8 - 1/8 - 1/8 - 1/8 - 1/8 - 1/8 - 1/8
35	40BS35	5.860	1	3.20	3/8 - 3/8 - 3/8 - 1 - 1/8 - 1/8 - 1/8 - 1/8 - 1/8 - 1/8 - 1/8
36	40BS36	6.020	1	3.39	3/8 - 3/8 - 3/8 - 1 - 1/8 - 1/8 - 1/8 - 1/8 - 1/8 - 1/8 - 1/8
37	40BS37	6.170	1	3.45	3/8 - 3/8 - 3/8 - 1 - 1/8 - 1/8 - 1/8 - 1/8 - 1/8 - 1/8 - 1/8
38	40BS38	6.330	1	3.50	3/8 - 3/8 - 3/8 - 1 - 1/8 - 1/8 - 1/8 - 1/8 - 1/8 - 1/8 - 1/8
39	40BS39	6.490	1	4.00	3/8 - 3/8 - 3/8 - 1 - 1/8 - 1/8 - 1/8 - 1/8 - 1/8 - 1/8 - 1/8
40	40BS40	6.650	1 1/8	4.28	3/8 - 3/8 - 3/8 - 1 - 1/8 - 1/8 - 1/8 - 1/8 - 1/8 - 1/8 - 1/8
41	40BS41	6.810	1 1/8	4.58	3/8 - 3/8 - 3/8 - 1 - 1/8 - 1/8 - 1/8 - 1/8 - 1/8 - 1/8 - 1/8
42	40BS42	6.970	1 1/8	4.64	3/8 - 3/8 - 3/8 - 1 - 1/8 - 1/8 - 1/8 - 1/8 - 1/8 - 1/8 - 1/8
43	40BS43	7.130	1 1/8	4.80	3/8 - 3/8 - 3/8 - 1 - 1/8 - 1/8 - 1/8 - 1/8 - 1/8 - 1/8 - 1/8
44	40BS44	7.290	1 1/8	4.96	3/8 - 3/8 - 3/8 - 1 - 1/8 - 1/8 - 1/8 - 1/8 - 1/8 - 1/8 - 1/8
45	40BS45	7.450	1 1/8	5.06	3/8 - 3/8 - 3/8 - 1 - 1/8 - 1/8 - 1/8 - 1/8 - 1/8 - 1/8 - 1/8
46	40BS46	7.610	1 1/8	5.19	3/8 - 3/8 - 3/8 - 1 - 1/8 - 1/8 - 1/8 - 1/8 - 1/8 - 1/8 - 1/8
47	40BS47	7.770	1 1/8	5.26	3/8 - 3/8 - 3/8 - 1 - 1/8 - 1/8 - 1/8 - 1/8 - 1/8 - 1/8 - 1/8
48	40BS48	7.930	1 1/8	5.66	3/8 - 3/8 - 3/8 - 1 - 1/8 - 1/8 - 1/8 - 1/8 - 1/8 - 1/8 - 1/8
49	40BS49	8.090	1 1/8	5.72	3/8 - 3/8 - 3/8 - 1 - 1/8 - 1/8 - 1/8 - 1/8 - 1/8 - 1/8 - 1/8
50	40BS50	8.250	1 1/8	5.78	3/8 - 3/8 - 3/8 - 1 - 1/8 - 1/8 - 1/8 - 1/8 - 1/8 - 1/8 - 1/8
51	40BS51	8.410	1 1/8	5.90	3/8 - 3/8 - 3/8 - 1 - 1/8 - 1/8 - 1/8 - 1/8 - 1/8 - 1/8 - 1/8
52	40BS52	8.570	1 1/8	5.94	3/8 - 3/8 - 3/8 - 1 - 1/8 - 1/8 - 1/8 - 1/8 - 1/8 - 1/8 - 1/8
53	40BS53	8.730	1 1/8	6.12	3/8 - 3/8 - 3/8 - 1 - 1/8 - 1/8 - 1/8 - 1/8 - 1/8 - 1/8 - 1/8
54	40BS54	8.880	1 1/8	6.24	3/8 - 3/8 - 3/8 - 1 - 1/8 - 1/8 - 1/8 - 1/8 - 1/8 - 1/8 - 1/8
55	40BS55	9.040	1 1/8	6.66	3/8 - 3/8 - 3/8 - 1 - 1/8 - 1/8 - 1/8 - 1/8 - 1/8 - 1/8 - 1/8
56	40BS56	9.200	1 1/8	6.71	3/8 - 3/8 - 3/8 - 1 - 1/8 - 1/8 - 1/8 - 1/8 - 1/8 - 1/8 - 1/8
57	40BS57	9.360	1 1/8	6.94	3/8 - 3/8 - 3/8 - 1 - 1/8 - 1/8 - 1/8 - 1/8 - 1/8 - 1/8 - 1/8
58	40BS58	9.520	1 1/8	7.17	3/8 - 3/8 - 3/8 - 1 - 1/8 - 1/8 - 1/8 - 1/8 - 1/8 - 1/8 - 1/8
59	40BS59	9.680	1 1/8	7.38	3/8 - 3/8 - 3/8 - 1 - 1/8 - 1/8 - 1/8 - 1/8 - 1/8 - 1/8 - 1/8
60	40BS60	9.840	1 1/8	7.68	3/8 - 3/8 - 3/8 - 1 - 1/8 - 1/8 - 1/8 - 1/8 - 1/8 - 1/8 - 1/8
70	40BS70	11.430	1 1/4	10.80	3/8 - 3/8 - 3/8 - 1 - 1/8 - 1/8 - 1/8 - 1/8 - 1/8 - 1/8 - 1/8
72	40BS72	11.750	1 1/4	11.30	3/8 - 3/8 - 3/8 - 1 - 1/8 - 1/8 - 1/8 - 1/8 - 1/8 - 1/8 - 1/8
80	40BS80	13.030	1 1/4	13.20	3/8 - 3/8 - 3/8 - 1 - 1/8 - 1/8 - 1/8 - 1/8 - 1/8 - 1/8 - 1/8
84	40BS84	13.660	1 1/4	13.84	3/8 - 3/8 - 3/8 - 1 - 1/8 - 1/8 - 1/8 - 1/8 - 1/8 - 1/8 - 1/8
96	40BS96	15.570	1 1/4	17.44	3/8 - 3/8 - 3/8 - 1 - 1/8 - 1/8 - 1/8 - 1/8 - 1/8 - 1/8 - 1/8
112	40BS112	18.120	1 1/4	22.45	3/8 - 3/8 - 3/8 - 1 - 1/8 - 1/8 - 1/8 - 1/8 - 1/8 - 1/8 - 1/8



BORED-TO-SIZE

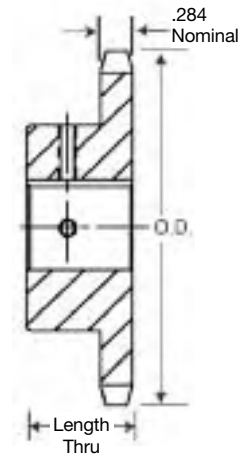

TYPE BS

*Indicates no keyway.
 (2) 1/4" setscrews only.
 Hub diameters vary to suit different bore sizes.

NOTE: KEYWAY IS ON CENTER LINE OF TOOTH.

SPROCKETS

Martin

All Steel Stock Sprockets

No. 40 1/2" Pitch



No. 40-Hardened Teeth — 2 Setscrews — Bored-To-Size

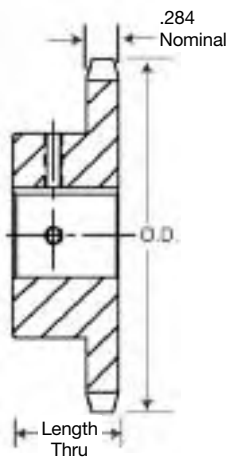

TYPE BS

No. Teeth	Catalog Number	Outside Diameter	Length Thru Bore	Weight Lbs. (Approx.)	Stock Finished Bores Includes Keyway and 2 Setscrews
9	40BS9HT	1.670	7/8	.16	1/2 - 3/8
10	40BS10HT	1.840	7/8	.24	1/2 - 3/8 - 3/8
11	40BS11HT	2.000	7/8	.28	1/2 - 3/8 - 3/8 - 3/8
12	40BS12HT	2.170	7/8	.34	1/2 - 3/8 - 3/8 - 3/8 - 1
13	40BS13HT	2.330	7/8	.45	1/2 - 3/8 - 3/8 - 3/8 - 1
14	40BS14HT	2.490	7/8	.51	1/2 - 3/8 - 3/8 - 3/8 - 1 - 1 1/8
15	40BS15HT	2.650	7/8	.53	1/2 - 3/8 - 3/8 - 3/8 - 1 - 1 1/8 - 1 1/8 - 1 1/8 - 1 1/8
16	40BS16HT	2.810	7/8	.66	3/8 - 3/8 - 3/8 - 1 - 1 1/8 - 1 1/8 - 1 1/8 - 1 1/8
17	40BS17HT	2.970	1	.88	3/8 - 3/8 - 3/8 - 1 - 1 1/8 - 1 1/8 - 1 1/8
18	40BS18HT	3.140	1	1.03	3/8 - 3/8 - 3/8 - 1 - 1 1/8 - 1 1/8 - 1 1/8 - 1 1/8 - 1 1/8 - 1 1/8
19	40BS19HT	2.300	1	1.17	3/8 - 3/8 - 3/8 - 1 - 1 1/8 - 1 1/8 - 1 1/8 - 1 1/8 - 1 1/8 - 1 1/8
20	40BS20HT	3.460	1	1.33	3/8 - 3/8 - 3/8 - 1 - 1 1/8 - 1 1/8 - 1 1/8 - 1 1/8 - 1 1/8 - 1 1/8
21	40BS21HT	3.620	1	1.53	3/8 - 3/8 - 3/8 - 1 - 1 1/8 - 1 1/8 - 1 1/8 - 1 1/8 - 1 1/8 - 1 1/8
22	40BS22HT	3.780	1	1.66	3/8 - 3/8 - 3/8 - 1 - 1 1/8 - 1 1/8 - 1 1/8 - 1 1/8 - 1 1/8 - 1 1/8
23	40BS23HT	3.940	1	1.92	3/8 - 3/8 - 3/8 - 1 - 1 1/8 - 1 1/8 - 1 1/8 - 1 1/8 - 1 1/8 - 1 1/8
24	40BS24HT	4.100	1	2.10	3/8 - 3/8 - 3/8 - 1 - 1 1/8 - 1 1/8 - 1 1/8 - 1 1/8 - 1 1/8 - 1 1/8
25	40BS25HT	4.260	1	2.22	3/8 - 3/8 - 1 - 1 1/8 - 1 1/8 - 1 1/8 - 1 1/8 - 1 1/8 - 1 1/8
26	40BS26HT	4.420	1	2.34	3/8 - 3/8 - 1 - 1 1/8 - 1 1/8 - 1 1/8 - 1 1/8 - 1 1/8 - 1 1/8
28	40BS28HT	4.740	1	2.50	3/8 - 3/8 - 1 - 1 1/8 - 1 1/8 - 1 1/8 - 1 1/8 - 1 1/8 - 1 1/8
30	40BS30HT	5.060	1	2.70	3/8 - 3/8 - 1 - 1 1/8 - 1 1/8 - 1 1/8 - 1 1/8 - 1 1/8 - 1 1/8

*Indicates no keyway. (2) 1/4" setscrews only in 1/2" & 3/8" bore at 90°.
NOTE: KEYWAY IS ON CENTER LINE OF TOOTH.

Martin stock hardened teeth sprockets afford longer chain and sprocket life. Hardened teeth on the smaller sprocket of a roller chain drive are recommended if the drive ratio is four to one or greater or if the smaller sprocket has 24 teeth or less and is running at a speed of over 600 R.P.M.

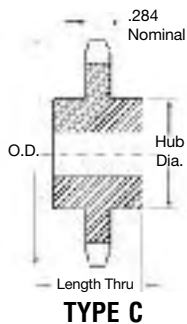

TYPE C

Single-Type C — Steel

No. Teeth	Catalog Number	Outside Diameter	Bore (inches)		Hub (inches)		Weight Lbs. (Approx.)
			Stock	Rec. Max.	Diameter	Length	
12	40C12	2.170	1/2	1	1 3/8*	1 1/2	.75
13	40C13	2.330	1/2	1 1/8	1 1/2	1 1/2	.94
14	40C14	2.490	1/2	1 1/8	1 1/2	1 1/2	.91
15	40C15	2.650	1/2	1 1/8	1 1/2	1 1/2	1.19
16	40C16	2.810	1/2	1 3/8	2	1 1/2	1.34
17	40C17	2.970	3/8	1 1/8	2 1/2	1 1/2	1.5
18	40C18	3.140	3/8	1 1/2	2 5/8	1 1/2	1.8

* Has recessed groove in hub for chain clearance.

SPROCKETS

No. 40

1/2" Pitch

All Steel Stock Sprockets

Martin



SPROCKETS

Double Single-Type A — Steel

No. Teeth	Catalog Number	Diameters		Type	Min. Bore	Max. Bore	Dimensions					Wt. (Approx.)
		Outside Diameter	Pitch Diameter				L	C	E	w Nom.		
15	DS40A15	2.650	2.405	A	1/2	1 1/4	1 1/2	1 1/8	1 1/16	.284	1.2	
16	DS40A16	2.810	2.563	A	1/2	1 1/4	1 1/2	1 1/8	2	.284	1.4	
17	DS40A17	2.980	2.721	A	1/2	1 1/4	1 1/2	1 1/8	2 1/8	.284	1.6	
18	DS40A18	3.140	2.879	A	1/2	1 1/2	1 1/2	1 1/8	2 5/16	.284	1.8	
19	DS40A19	3.300	3.038	A	3/4	1 1/2	1 1/2	1 1/8	2 1/2	.284	2.2	
20	DS40A20	3.460	3.196	A	3/4	1 1/2	1 1/2	1 1/8	2 3/8	.284	2.6	
21	DS40A21	3.620	3.355	A	3/4	1 1/2	1 1/2	1 1/8	2 5/8	.284	2.9	
22	DS40A22	3.780	3.513	A	3/4	1 1/2	1 1/2	1 1/8	2 7/8	.284	3.0	
23	DS40A23	3.940	3.672	A	3/4	2 1/8	1 1/2	1 1/8	3 1/2	.284	3.5	
24	DS40A24	4.100	3.831	A	3/4	2 1/4	1 1/2	1 1/8	3 3/4	.284	4.0	
25	DS40A25	4.260	3.989	A	3/4	2 1/2	1 1/2	1 1/8	3 5/8	.284	4.5	

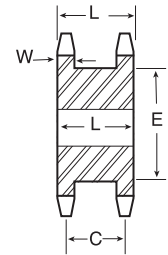

TYPE A

Double Single-Taper Bushed — Steel

No. Teeth	Catalog Number	Bushing Size	Diameters		Min. Bore	Max. Bore	Type	Dimensions					Wt. Rim Only
			Outside Diameter	Pitch Diameter				L ₁	C	E	L ₂	w Nom.	
18	DS40ATB18H	1215	3.140	2.879	1/2	1 1/4	A	1 1/2	1 1/8	2 5/16	1 1/2	.284	1.0
19	DS40ATB19H	1215	3.300	3.038	1/2	1 1/4	A	1 1/2	1 1/8	2 1/2	1 1/2	.284	1.1
20	DS40ATB20H	1215	3.460	3.196	1/2	1 1/4	A	1 1/2	1 1/8	2 3/8	1 1/2	.284	1.3
21	DS40ATB21H	1615	3.620	3.355	1/2	1 1/4	A	1 1/2	1 1/8	2 5/8	1 1/2	.284	1.3
23	DS40ATB23H	1615	3.940	3.672	1/2	1 1/4	A	1 1/2	1 1/8	3 1/2	1 1/2	.284	1.5
24	DS40ATB24H	1615	4.100	3.831	1/2	1 1/4	A	1 1/2	1 1/8	3 3/4	1 1/2	.284	1.7

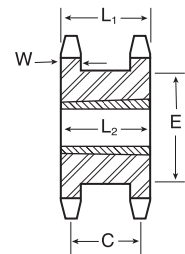

TAPER BUSH TYPE A

Double Single - MST® — Steel

No. Teeth	Catalog Number	Bushing Size	Diameters		Min. Bore	Max. Bore	Type	Dimensions					Wt. Rim Only
			Outside Diameter	Pitch Diameter				L ₁	C	E	L ₂	w Nom.	
19	DS40H19H	H	3.300	3.038	3/4	1 1/2	BH	1 1/2	1 1/8	2 1/2	2 1/2	.284	1.5
21	DS40H21H	H	3.620	3.355	3/4	1 1/2	BH	1 1/2	1 1/8	2 5/8	2 1/2	.284	2
23	DS40P23H	P1	3.940	3.672	1/2	1 1/4	B	1 1/2	1 1/8	3 1/2	2 3/4	.284	2.3
24	DS40P24H	P1	4.100	3.831	1/2	1 1/4	B	1 1/2	1 1/8	3 3/4	2 3/4	.284	2.5

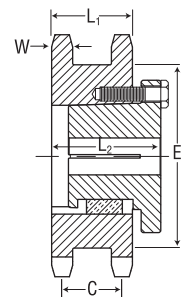

MST TYPE B

Single-Type B — Stainless

Single-Type A

No. Teeth	Catalog Number	Outside Diameter	Type	Bore (inches)		Hub (inches)		Weight Lbs. (Approx.)	Type	Catalog Number	Stock Bore	Weight Lbs. (Approx.)
				Stock	Rec. Max.	Diameter	Length Thru					
10	40B10SS	1.840	B	1/2	3/4	1 1/4*	7/8	.28				
11	40B11SS	2.000	B	1/2	7/8	1 1/2*	7/8	.36				
12	40B12SS	2.170	B	1/2	7/8	1 1/2*	7/8	.44				
13	40B13SS	2.33	B	1/2	1 1/8	1 1/2	7/8	.50				
14	40B14SS	2.490	B	1/2	1 1/8	1 1/2	7/8	.60				
15	40B15SS	2.650	B	1/2	1 1/4	1 3/8	7/8	.68				
16	40B16SS	2.810	B	5/8	1 1/2	2	1	.82				
17	40B17SS	2.980	B	5/8	1 1/2	2 1/8	1	1.06				
18	40B18SS	3.140	B	5/8	1 1/2	2 1/8	1	1.24				
19	40B19SS	3.300	B	5/8	1 3/4	2 1/2	1	1.42				
20	40B20SS	3.460	B	5/8	1 3/4	2 1/2	1	1.60				
21	40B21SS	3.620	B	5/8	1 3/4	2 1/2	1	1.68				
22	40B22SS	3.780	B	5/8	1 3/4	2 1/2	1	1.81				
23	40B23SS	3.940	B	5/8	2	3	1	2.18				
24	40B24SS	4.100	B	5/8	2 1/4	3 1/4	1	2.20				
25	40B25SS	4.260	B	5/8	2 1/4	3 1/4	1	1.84	A	40A26SS	1 1/32	1.31
26	40B26SS	4.420	B	5/8	2 1/4	3 1/4	1	2.40	A	40A28SS	1 1/32	1.35
28	40B28SS	4.740	B	5/8	2 1/4	3 1/4	1	2.75	A	40A30SS	1 1/32	1.39
30	40B30SS	5.060	B	5/8	2 1/4	3 1/4	1	2.88	A	40A35SS	1 1/32	1.92
35	40B35SS	5.860	B	5/8	2 1/2	3 1/2	1	3.32	A	40A40SS	2 1/32	2.36
40	40B40SS	6.650	B	3/4	2 1/2	3 1/2	1	4.28	A	40A45SS	2 1/32	3.13
45	40B45SS	7.450	B	3/4	2 1/2	3 1/2	1	4.68	A	40A60SS	2 1/32	5.50
60	40B60SS	9.840	B	3/4	2 1/2	3 1/2	1	7.00	A			

* Has recessed groove in hub for chain clearance.

Maximum bores shown will accommodate standard keyseat and setscrew over keyseat. Slightly larger bores are possible with no keyseat, shallow keyseat, or setscrew at angle to keyseat.

Sprockets altered at factory (rebored with keyway and setscrew added) will be supplied with stainless setscrew.



STAINLESS STEEL

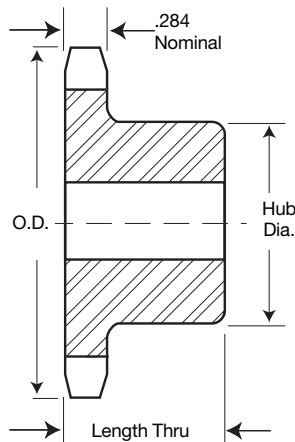

TYPE B

Alteration Charges

See current discount sheet for alteration charges.

No. 40

1/2" Pitch

All Steel Stock Sprockets

Martin

Single-Type B

Single-Type A

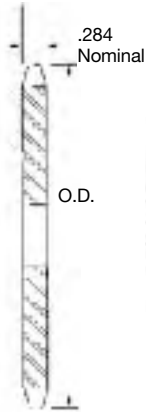

TYPE A

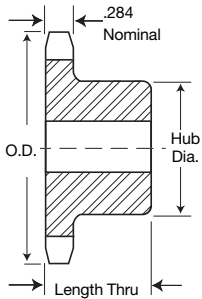

TYPE B



No. Teeth	Catalog Number	Outside Diameter	Type	Bore (inches)		Hub (inches)		Weight Lbs (Approx.)	Type	Catalog Number	Stock Bore	Weight Lbs. (Approx.)
				Stock	Rec. Max.	Diameter	Length Thru					
8	40B8	1.510	B	1/2	1/2	5/16*	3/8	.18				
9	40B9	1.670	B	1/2	1/2	1/8*	3/8	.20				
10	40B10	1.840	B	1/2	3/4	1/4*	3/8	.27				
11	40B11	2.000	B	1/2	3/4	1/4*	3/8	.35				
12	40B12	2.170	B	1/2	1	1/8*	3/8	.45	A	40A12	1/2	.18
13	40B13	2.330	B	1/2	1 1/16	1/8	3/8	.50	A	40A13	1/2	.22
14	40B14	2.490	B	1/2	1 1/8	1 1/16	3/8	.59	A	40A14	1/2	.26
15	40B15	2.650	B	1/2	1 1/4	1 1/8	3/8	.70	A	40A15	3/8	.30
16	40B16	2.810	B	5/8	1 1/8	2	3/8	.79	A	40A16	5/8	.34
17	40B17	2.980	B	5/8	1 1/8	2 1/8	1	1.04	A	40A17	5/8	.36
18	40B18	3.140	B	5/8	1 1/2	2 3/8	1	1.22	A	40A18	5/8	.44
19	40B19	3.300	B	5/8	1 1/2	2 1/2	1	1.43	A	40A19	5/8	.46
20	40B20	3.460	B	5/8	1 3/4	2 3/4	1	1.56	A	40A20	5/8	.56
21	40B21	3.620	B	5/8	1 3/4	2 3/4	1	1.73	A	40A21	5/8	.58
22	40B22	3.780	B	5/8	1 3/4	2 3/4	1	1.96	A	40A22	5/8	.66
23	40B23	3.940	B	5/8	2	3	1	2.13	A	40A23	5/8	.72
24	40B24	4.100	B	5/8	2 1/4	3 1/4	1	2.41	A	40A24	5/8	.82
25	40B25	4.260	B	5/8	2 1/4	3 1/4	1	2.54	A	40A25	5/8	.88
26	40B26	4.420	B	5/8	2 1/4	3 1/4	1	2.58	A	40A26	5/8	.94
27	40B27	4.580	B	5/8	2 1/4	3 1/4	1	2.66	A	40A27	5/8	.98
28	40B28	4.740	B	5/8	2 1/2	3 1/2	1	2.73	A	40A28	5/8	1.10
29	40B29	4.900	B	5/8	2 1/2	3 1/2	1	2.80	A	40A29	19/32	1.22
30	40B30	5.060	B	5/8	2 1/2	3 1/2	1	2.98	A	40A30	19/32	1.26
31	40B31	5.220	B	5/8	2 1/2	3 1/2	1	3.10	A	40A31	19/32	1.40
32	40B32	5.380	B	5/8	2 1/2	3 1/2	1	3.16	A	40A32	19/32	1.48
33	40B33	5.540	B	5/8	2 1/2	3 1/2	1	3.22	A	40A33	19/32	1.56
34	40B34	5.700	B	5/8	2 1/2	3 1/2	1	3.30	A	40A34	19/32	1.64
35	40B35	5.860	B	5/8	2 1/2	3 1/2	1	3.46	A	40A35	19/32	1.70
36	40B36	6.020	B	5/8	2 1/2	3 1/2	1	3.58	A	40A36	19/32	1.84
37	40B37	6.180	B	5/8	2 1/2	3 1/2	1	3.62	A	40A37	19/32	1.92
38	40B38	6.330	B	5/8	2 1/2	3 1/2	1	3.70	A	40A38	19/32	2.00
39	40B39	6.490	B	5/8	2 1/2	3 1/2	1	3.76	A	40A39	19/32	2.02
40	40B40	6.650	B	3/4	2 3/4	3 3/4	1 1/8	4.69	A	40A40	23/32	2.22
41	40B41	6.810	B	3/4	2 3/4	3 3/4	1 1/8	4.76	A	40A41	23/32	2.42
42	40B42	6.970	B	3/4	2 3/4	3 3/4	1 1/8	4.82	A	40A42	23/32	2.50
43	40B43	7.130	B	3/4	2 3/4	3 3/4	1 1/8	5.12	A	40A43	23/32	2.80
44	40B44	7.290	B	3/4	2 3/4	3 3/4	1 1/8	5.15	A	40A44	23/32	2.85
45	40B45	7.450	B	3/4	2 3/4	3 3/4	1 1/8	5.30	A	40A45	23/32	3.15
46	40B46	7.610	B	3/4	2 3/4	3 3/4	1 1/8	5.57	A	40A46	23/32	3.26
47	40B47	7.770	B	3/4	2 3/4	3 3/4	1 1/8	5.44	A	40A47	23/32	3.32
48	40B48	7.930	B	3/4	2 3/4	3 3/4	1 1/8	5.84	A	40A48	23/32	3.22
49	40B49	8.090	B	3/4	2 3/4	3 3/4	1 1/8	5.90	A	40A49	23/32	3.44
50	40B50	8.250	B	3/4	2 3/4	3 3/4	1 1/8	5.96	A	40A50	23/32	3.62
51	40B51	8.410	B	3/4	2 3/4	3 3/4	1 1/8	6.08	A	40A51	23/32	3.94
52	40B52	8.570	B	3/4	2 3/4	3 3/4	1 1/8	6.28	A	40A52	23/32	4.08
53	40B53	8.730	B	3/4	2 3/4	3 3/4	1 1/8	6.33	A	40A53	23/32	4.04
54	40B54	8.890	B	3/4	2 3/4	3 3/4	1 1/8	6.42	A	40A54	23/32	4.44
55	40B55	9.040	B	3/4	2 3/4	3 3/4	1 1/8	6.46	A	40A55	23/32	4.54
56	40B56	9.200	B	3/4	2 3/4	3 3/4	1 1/8	6.89	A	40A56	23/32	4.84
57	40B57	9.360	B	3/4	2 3/4	3 3/4	1 1/8	7.02	A	40A57	23/32	5.00
58	40B58	9.520	B	3/4	2 3/4	3 3/4	1 1/8	7.36	A	40A58	23/32	5.12
59	40B59	9.680	B	3/4	2 3/4	3 3/4	1 1/8	7.45	A	40A59	23/32	5.30
60	40B60	9.840	B	3/4	2 3/4	3 3/4	1 1/8	7.86	A	40A60	23/32	5.48
70	40B70	11.430	B	3/4	2 3/4	4	1 1/4	11.00	A	40A70	23/32	7.24
72	40B72	11.750	B	3/4	2 3/4	4	1 1/4	11.50	A	40A72	23/32	7.74
80	40B80	13.030	B	3/4	2 3/4	4	1 1/4	13.40	A	40A80	23/32	10.20
84	40B84	13.660	B	3/4	2 3/4	4	1 1/4	14.04	A	40A84	23/32	10.07
96	40B96	15.570	B	1	2 3/4	4	1 1/4	17.56	A	40A96	15/16	12.15
112	40B112	18.120	B	1	2 3/4	4	1 1/4	22.56	A	40A112	15/16	20.00

* Has recessed groove in hub for chain clearance.

Maximum bores shown will accommodate standard keyseat and setscrew over keyseat. Slightly larger bores are possible with no keyseat, shallow keyseat, or setscrew at angle to keyseat.

Alteration Charges

See current discount sheet for alteration charges.

Single-Type QD With Hardened Teeth

No. Teeth	Catalog Number
15	40JA15H
16	40JA16H
17	40JA17H
18	40JA18H
19	40JA19H
20	40SH20H
21	40SH21H
22	40SH22H
23	40SH23H
24	40SH24H
25	40SH25H
26	40SH26H
27	40SH27H
28	40SH28H
30	40SH30H

**SABER
TOOTH®**

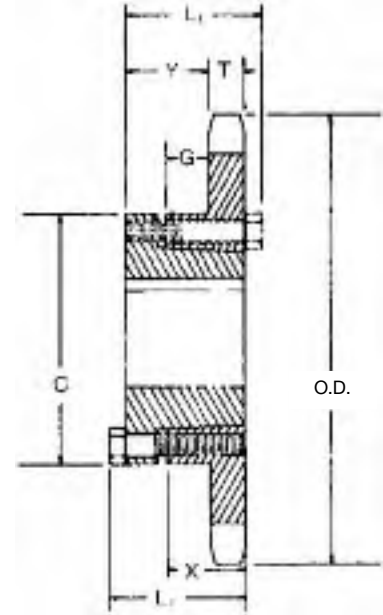

QD — TYPE B

SPROCKETS

Single-Type QD

No. Teeth	Catalog Number	Bush- ing	Diameters		Type	Max. Bore	Dimensions							Weight (Approx.)	
			Outside Diameter	Pitch Diameter			L ₁	L ₂	C	Y	G	X	T	With Hub	Rim Only
15	40JA15	JA	2.650	2.405	B	1/4	1/8	1/8	2 1/16	23/32	1 1/32	5/16	.284	1.24	.34
16	40JA16	JA	2.810	2.563	B									1.30	.40
17	40JA17	JA	2.980	2.721	B									1.38	.48
18	40JA18	JA	3.140	2.879	B									1.44	.54
19	40JA19	JA	3.300	3.038	B	1/4	1/8	1/8	2 1/16	23/32	1 1/32	5/16	.284	1.50	.60
20	40SH20	SH	3.460	3.196	B	1/4	1/16	1/16	2 1/16	3 1/32	1 1/32	1/16	.284	1.76	.76
21	40SH21	SH	3.620	3.355	B									1.84	.84
22	40SH22	SH	3.780	3.513	B									1.92	.92
23	40SH23	SH	3.940	3.672	B									2.14	1.14
24	40SH24	SH	4.100	3.831	B									2.22	1.22
25	40SH25	SH	4.260	3.989	B									2.30	1.30
26	40SH26	SH	4.420	4.148	B									2.44	1.44
27	40SH27	SH	4.580	4.307	B									2.46	1.46
28	40SH28	SH	4.740	4.466	B									2.54	1.54
30	40SH30	SH	5.060	4.783	B									2.72	1.72
32	40SH32	SH	5.380	5.101	B									2.90	1.90
35	40SH35	SH	5.860	5.578	B	1/2	1/16	1/16	3	3 1/32	1 1/32	1/16	.284	3.22	2.22
36	40SDS36	SDS	6.020	5.737	B	2	1/2	1/2	3 1/16	1 1/32	1 1/32	3/16	.284	3.20	2.20
40	40SDS40	SDS	6.650	6.373	B									3.72	2.72
42	40SDS42	SDS	6.970	6.691	B									3.92	2.92
45	40SDS45	SDS	7.450	7.168	B									4.32	3.32
48	40SDS48	SDS	7.930	7.645	B									4.70	3.70
54	40SDS54	SDS	8.890	8.599	B									5.78	4.78
60	40SDS60	SDS	9.840	9.554	B	2	1/2	1/2	3 1/16	1 1/32	1 1/32	3/16	.284	6.86	5.86
70	40SK70	SK	11.430	11.145	B	2 1/2	2 1/2	2 1/2	3 3/8	1 19/32	3 1/32	1 1/4	.284	10.68	8.68
72	40SK72	SK	11.750	11.463	B									10.84	8.84
80	40SK80	SK	13.030	12.736	B									13.20	11.20
84	40SK84	SK	13.660	13.372	B									13.56	11.56
96	40SK96	SK	15.570	15.282	B									17.76	15.76
112	40SK112	SK	18.120	17.828	B	2 1/2	2 1/2	2 1/2	3 3/8	1 19/32	3 1/32	1 1/4	.284	22.28	20.28

No. 40

1/2" Pitch

All Steel Stock Sprockets



Single-Taper Bushed with Hardened Teeth

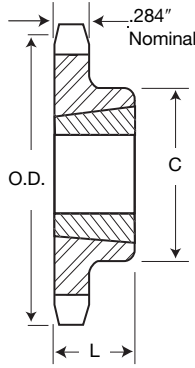

**TAPER BUSHED
TYPE B**

**SABER
TOOTH®**

No. Teeth	Catalog Number
14	40BTB14H
15	40BTB15H
16	40BTB16H
17	40BTB17H
18	40BTB18H
19	40BTB19H
20	40BTB20H
21	40BTB21H
22	40BTB22H
23	40BTB23H
24	40BTB24H
25	40BTB25H
26	40BTB26H
28	40BTB28H
30	40BTB30H

SPROCKETS

Single-Taper Bushed

No. Teeth	Catalog Number	Bushing	Diameters		Max. Bore	Dimensions		Type	Weight (Approx.)	
			Outside Diameter	Pitch Diameter		L	C		Rim Only	Bushing Only
14	40BTB14	1008	2.491	2.247	1	7/8	★1 1/16	B	.3	.3
15	40BTB15	1008	2.652	2.405	1	7/8	1 1/16	B	.4	.3
16	40BTB16	1008	2.814	2.563	1	7/8	1 1/16	B	.5	.3
17	40BTB17	1210	2.975	2.721	1 1/4	1	★2 7/16	B	.5	.3
18	40BTB18	1210	3.135	2.879	1 1/4	1	★2 1/32	B	.6	.6
19	40BTB19	1210	3.296	3.038	1 1/4	1	2 7/32	B	.7	.6
20	40BTB20	1610	3.457	3.196	1 1/2	1	★2 29/32	B	.7	.9
21	40BTB21	1610	3.617	3.355	1 1/2	1	2 25/32	B	.8	.9
22	40BTB22	1610	3.778	3.513	1 1/2	1	2 29/32	B	.9	.9
23	40BTB23	1610	3.938	3.672	1 1/2	1	3 3/32	B	1.0	.9
24	40BTB24	1610	4.098	3.831	1 1/2	1	3 1/4	B	1.4	.9
25	40BTB25	1610	4.258	3.989	1 1/2	1	3 13/32	B	1.5	.9
26	40BTB26	1610	4.418	4.148	1 1/2	1	3 1/2	B	1.7	.9
28	40BTB28	1610	4.738	4.466	1 1/2	1	3 1/2	B	1.8	.9
30	40BTB30	1610	5.057	4.783	1 1/2	1	3 1/2	B	1.9	.9
32	40BTB32	1610	5.377	5.101	1 1/2	1	3 1/2	B	1.9	.9
35	40BTB35	1610	5.855	5.578	1 1/2	1	3 1/2	B	2.3	.9
36	40BTB36	1610	6.015	5.737	1 1/2	1	3	B	2.4	.9
40	40BTB40	1610	6.653	6.373	1 1/2	1	3	B	2.8	.9
42	40BTB42	1610	6.972	6.691	1 1/2	1	3	B	2.9	.9
45	40BTB45	1610	7.451	7.168	1 1/2	1	3	B	3.5	.9
48	40BTB48	1610	7.928	7.645	1 1/2	1	3	B	4.0	.9
54	40BTB54	1610	8.885	8.599	1 1/2	1	3	B	4.9	.9
60	40BTB60	1610	9.841	9.554	1 1/2	1	3	B	6.0	.9
70	40BTB70	2012	11.434	11.145	2	1 1/4	3 5/16	B	8.2	1.7
72	40BTB72	2012	11.752	11.463	2	1 1/4	3 5/16	B	9.0	1.7
80	40BTB80	2012	13.026	12.736	2	1 1/4	3 5/16	B	10.8	1.7
84	40BTB84	2012	13.663	13.372	2	1 1/4	3 5/16	B	11.3	1.7
96	40BTB96	2012	15.573	15.282	2	1 1/4	3 5/16	B	14.6	1.7
112	40BTB112	2517	18.122	17.828	2 1/2	1 1/4	4 1/4	B	20.5	1.7

★ Has recessed groove in hub for chain clearance.

Single - MST[®] Sprockets

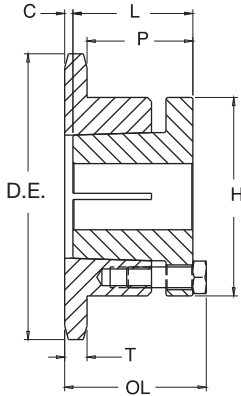

TIPO 3

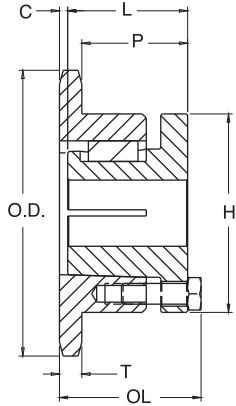

TYPE 4

No. Teeth	Catalog Number	Bush- ing	Diameters		Type	Max. Bore	Dimensions						Weight (Approx.)	
			Outside Dia.	Pitch Dia.			OL	L	C	H	P	T(nom)	With Hub	Rim Only
15	40H15H	H	2.650	2.405	3	1-1/2	1-19/32	1-1/4	5/32	2-1/2	1-1/8	.284	1.3	.5
16	40H16H	H	2.810	2.563	3	1-1/2	1-19/32	1-1/4	5/32	2-1/2	1-1/8	.284	1.4	.6
17	40H17H	H	2.980	2.721	3	1-1/2	1-1/2	1-1/4	1/16	2-1/2	1-1/32	.284	1.4	.6
18	40H18H	H	3.140	2.879	3	1-1/2	1-1/2	1-1/4	1/16	2-1/2	1-1/32	.284	1.4	.6
18	40P18H	P1	3.140	2.879	3	1-3/4	2-3/16	1-15/16	0	3	1-21/32	.284	2.7	1.4
19	40H19H	H	3.300	3.038	3	1-1/2	1-1/2	1-1/4	1/16	2 1/2	1-1/32	.284	1.6	.8
19	40P19H	P1	3.300	3.038	4	1-3/4	2-3/16	1-15/16	0	3	1-21/32	.284	2.6	1.3
20	40H20H	H	3.460	3.196	3	1-1/2	1-1/2	1-1/4	1/16	2-1/2	1-1/32	.284	1.7	.9
20	40P20H	P1	3.460	3.196	4	1-3/4	2-3/16	1-15/16	0	3	1-21/32	.284	2.6	1.3
21	40H21H	H	3.620	3.355	3	1-1/2	1-1/2	1-1/4	1/16	2-1/2	1-1/32	.284	1.7	.9
21	40P21H	P1	3.620	3.355	4	1-3/4	2-3/16	1-15/16	0	3	1-21/32	.284	2.8	1.5
22	40H22H	H	3.780	3.513	3	1-1/2	1-1/2	1-1/4	1/16	2-1/2	1-1/32	.284	1.8	1.0
22	40P22H	P1	3.780	3.513	4	1-3/4	2-3/16	1-15/16	0	3	1-21/32	.284	2.9	1.6
23	40H23H	H	3.940	3.672	3	1-1/2	1-1/2	1-1/4	1/16	2-1/2	1-1/32	.284	1.8	1.0
23	40P23H	P1	3.940	3.672	4	1-3/4	2-3/16	1-15/16	0	3	1-21/32	.284	3.0	1.7
24	40H24H	H	4.100	3.831	3	1-1/2	1 1/2	1-1/4	1/16	2-1/2	1-1/32	.284	1.9	1.1
24	40P24H	P1	4.100	3.831	4	1-3/4	2 3/16	1-15/16	0	3	1-21/32	.284	3.1	1.8
25	40H25H	H	4.260	3.989	3	1-1/2	1 1/2	1-1/4	1/16	2-1/2	1-1/32	.284	2.1	1.3
25	40P25H	P1	4.260	3.989	4	1-3/4	2 3/16	1-15/16	0	3	1-21/32	.284	3.2	1.9
26	40H26H	H	4.420	4.148	3	1-1/2	1 1/2	1-1/4	1/16	2-1/2	1-1/32	.284	2.1	1.3
26	40P26H	P1	4.420	4.148	4	1 3/4	2-3/16	1-15/16	0	3	1-21/32	.284	3.2	1.9
27	40H27H	H	4.580	4.307	3	1 1/2	1-1/2	1-1/4	1/16	2-1/2	1-1/32	.284	2.2	1.4
28	40H28H	H	4.740	4.466	3	1 1/2	1-1/2	1-1/4	1/16	2-1/2	1-1/32	.284	2.2	1.4
28	40P28H	P1	4.740	4.466	4	1 3/4	2-3/16	1-15/16	0	3	1-21/32	.284	3.4	2.1
29	40P29H	P1	4.900	4.625	4	1 3/4	2-3/16	1-15/16	0	3	1-21/32	.284	3.6	2.3
30	40H30H	H	5.060	4.783	3	1-1/2	1-1/2	1-1/4	1/16	2-1/2	1-1/32	.284	2.4	1.6
30	40P30H	P1	5.060	4.783	4	1-3/4	2-3/16	1-15/16	0	3	1-21/32	.284	3.6	2.3
31	40P31	P1	5.220	4.942	4	1-3/4	2-3/16	1-15/16	0	3	1-21/32	.284	3.8	2.5
32	40H32H	H	5.380	5.101	3	1-1/2	1-1/2	1-1/4	1/16	2-1/2	1-1/32	.284	2.6	1.8
32	40P32	P1	5.380	5.101	4	1-3/4	2-3/16	1-15/16	0	3	1-21/32	.284	3.9	2.6
33	40H33H	H	5.540	5.260	3	1-1/2	1-1/2	1-1/4	1/16	2-1/2	1-1/32	.284	2.7	1.9
33	40P33	P1	5.540	5.260	4	1-3/4	2-3/16	1-15/16	0	3	1-21/32	.284	3.9	2.6
34	40P34	P1	5.700	5.419	4	1-3/4	2-3/16	1-15/16	0	3	1-21/32	.284	4.1	2.8
35	40H35H	H	5.860	5.578	3	1-1/2	1-1/2	1-1/4	1/16	2-1/2	1-1/32	.284	2.9	2.1
35	40P35	P1	5.860	5.578	4	1-3/4	2-3/16	1-15/16	0	3	1-21/32	.284	4.2	2.9
36	40H36H	H	6.020	5.737	3	1-1/2	1-1/2	1-1/4	1/16	2-1/2	1-1/32	.284	3.1	2.3
36	40P36	P1	6.020	5.737	4	1-3/4	2-3/16	1-15/16	0	3	1-21/32	.284	4.4	3.1
37	40P37	P1	6.180	5.896	4	1-3/4	2-3/16	1-15/16	0	3	1-21/32	.284	4.6	3.3
38	40H38H	H	6.330	6.055	3	1-1/2	1-1/2	1-1/4	1/16	2-1/2	1-1/32	.284	3.4	2.6
38	40P38	P1	6.330	6.055	4	1-3/4	2-3/16	1-15/16	0	3	1-21/32	.284	4.6	3.3
40	40H40H	H	6.650	6.373	3	1-1/2	1-1/2	1-1/4	1/16	2-1/2	1-1/32	.284	3.6	2.8
40	40P40	P1	6.650	6.373	4	1-3/4	2-3/16	1-15/16	0	3	1-21/32	.284	4.8	3.5
41	40P41	P1	6.810	6.532	4	1-3/4	2-3/16	1-15/16	0	3	1-21/32	.284	4.9	3.6
42	40P42	P1	6.970	6.691	4	1-3/4	2-3/16	1-15/16	0	3	1-21/32	.284	5.2	3.9
44	40P44	P1	7.290	7.009	4	1-3/4	2-3/16	1-15/16	0	3	1-21/32	.284	5.3	4.0
45	40P45	P1	7.450	7.168	4	1-3/4	2-3/16	1-15/16	0	3	1-21/32	.284	5.5	4.2
47	40P47	P1	7.770	7.486	4	1-3/4	2-3/16	1-15/16	0	3	1-21/32	.284	5.9	4.6
48	40P48	P1	7.930	7.645	4	1-3/4	2 3/16	1-15/16	0	3	1-21/32	.284	6.1	4.8
50	40P50	P1	8.250	7.963	4	1-3/4	2-3/16	1-15/16	0	3	1-21/32	.284	6.3	5.0
54	40P54	P1	8.890	8.599	4	1-3/4	2-3/16	1-15/16	0	3	1-21/32	.284	6.8	5.5
56	40P56	P1	9.200	8.917	4	1-3/4	2-3/16	1-15/16	0	3	1-21/32	.284	7.2	5.9
60	40P60	P1	9.840	9.554	4	1-3/4	2-3/16	1-15/16	0	3	1-21/32	.284	7.9	6.6
60	40Q60	Q1	9.840	9.554	4	2-11/16	2-25/32	2-1/2	0	4-1/8	2-7/32	.284	12.3	8.8
70	40P70	P1	11.430	11.145	4	1-3/4	2-3/16	1-15/16	0	3	1-21/32	.284	9.9	8.6
70	40Q70	Q1	11.430	11.145	4	2-11/16	2-25/32	2-1/2	0	4-1/8	2-7/32	.284	14.5	11.0
72	40Q72	Q1	11.750	11.463	4	2-11/16	2-25/32	2-1/2	0	4-1/8	2-7/32	.284	14.7	11.2
80	40Q80	Q1	13.030	12.736	4	2-11/16	2-25/32	2-1/2	0	4-1/8	2-7/32	.284	16.6	13.1
84	40Q84	Q1	13.660	13.372	4	2-11/16	2-25/32	2-1/2	0	4-1/8	2-7/32	.284	17.6	14.1
96	40Q96	Q1	15.570	15.281	4	2-11/16	2-25/32	2-1/2	0	4-1/8	2-7/32	.284	16.3	12.8
112	40Q112	Q1	18.120	17.828	4	2-11/16	2-25/32	2-1/2	0	4-1/8	2-7/32	.284	20.8	17.3

Sprockets with "H" suffix have hardened teeth.

No. 40-2

1/2" Pitch

All Steel Stock Sprockets



Double-Type B

No. Teeth	Catalog Number	Outside Diameter	Type	Bore (inches)		Hub (inches)		Weight Lbs. (Approx.)
				Stock	Rec. Max.	Dia.	Length Thru	
11	D40B11H	2.000	B	1/2	3/4	1 1/16*	1 1/2	.62
12	D40B12H	2.170	B	1/2	7/16	1 1/16*	1 1/2	.76
13	D40B13H	2.330	B	1/2	1	1 1/2	1 1/2	.86
14	D40B14H	2.490	B	1/2	1 1/8	1 1/16	1 1/2	1.08
15	D40B15H	2.650	B	1/2	1 1/4	1 3/16	1 1/2	1.24
16	D40B16H	2.810	B	5/8	1 3/8	2	1 1/2	1.42
17	D40B17H	2.980	B	5/8	1 1/2	2 1/8	1 1/2	1.64
18	D40B18H	3.140	B	5/8	1 5/8	2 1/4	1 1/2	1.92
19	D40B19H	3.300	B	3/4	1 3/4	2 1/8	1 1/2	2.22
20	D40B20H	3.460	B	3/4	1 7/8	2 1/4	1 1/2	2.64
21	D40B21H	3.620	B	3/4	2	2 3/8	1 1/2	2.94
22	D40B22H	3.780	B	3/4	2 1/8	2 1/2	1 1/2	3.18
23	D40B23H	3.940	B	7/8	2	3	1 1/2	3.52
24	D40B24H	4.100	B	7/8	2 1/8	3 1/4	1 1/2	4.04
25	D40B25H	4.260	B	7/8	2 3/8	3 3/4	1 1/2	4.26
26	D40B26	4.420	B	7/8	2 1/2	3 1/2	1 1/2	4.48
30	D40B30	5.060	B	1	2 1/4	3 3/4	1 1/2	5.34
35	D40B35	5.860	B	1 1/8	2 3/4	3 3/4	1 1/2	6.80
36	D40B36	6.020	B	1 1/16	2 1/2	3 3/4	1 1/2	7.20
40	D40B40	6.650	B	1 1/16	2 1/2	3 3/4	1 1/2	9.40
42	D40B42	6.970	B	1 1/8	2 1/2	3 3/4	1 1/2	10.20
45	D40B45	7.450	B	1 1/8	2 1/2	3 3/4	1 1/2	11.36
48	D40B48	7.930	B	1 1/8	2 1/2	3 3/4	1 1/2	12.66
52	D40B52	8.570	B	1 1/8	2 1/2	3 3/4	1 1/2	14.46
54	D40B54	8.890	B	1 1/8	2 1/2	3 3/4	1 1/2	15.48
60	D40B60	9.840	B	1 1/8	2 1/2	3 3/4	1 1/2	18.60
68	D40B68	11.120	B	1 1/16	2 3/4	4 1/4	2 1/2	24.96
72	D40B72	11.750	B	1 1/16	2 3/4	4 1/4	2 1/2	27.88
76	D40B76	12.390	B	1 1/16	2 3/4	4 1/4	2 1/2	30.18
84	D40B84	13.660	B	1 1/16	2 3/4	4 1/4	2 1/2	36.24
95	D40B95	15.410	B	1 1/16	2 3/4	4 1/4	2 1/2	38.84
96	D40B96	15.570	B	1 1/16	2 3/4	4 1/4	2 1/2	39.50
102	D40B102	16.530	B	1 1/16	2 3/4	4 1/4	2 1/2	42.72
112	D40B112	18.120	B	1 1/16	2 3/4	4 1/4	2 1/2	55.54

* Has recessed groove in hub for chain clearance.

Maximum bores shown will accommodate standard keyseat and setscrew over keyseat. Slightly larger bores are possible with no keyseat, shallow keyseat, or setscrew at angle to keyseat.

NOTE: Double 40 stock sprockets with 25 teeth or less have hardened teeth. As indicated by H suffix.

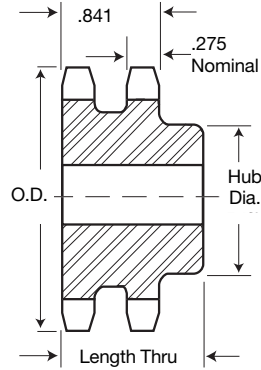

TYPE B

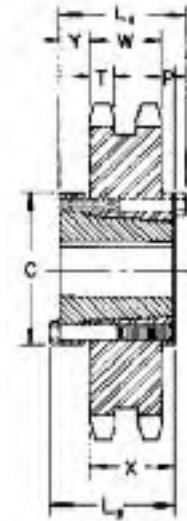

QD — TYPE C

Alteration Charges

See current discount sheet for alteration charges.

Double-Type QD

No. Teeth	Catalog Number	Bush-ing	Diameters		Type	Max. Bore	Dimensions								Weight (Approx.)	
			Outside Diameter	Pitch Diameter			L ₁	L ₂	C	Y	P	X	T	W	With Hub	Rim Only
36	D40SK36	SK	6.020	5.737	C	2%	2 1/2	2 1/2	3 3/8	5/8	1 1/16	1 1/4	.275	.841	6.68	4.68
40	D40SK40	SK	6.650	6.373	C										8.02	6.02
42	D40SK42	SK	6.970	6.691	C										8.82	6.82
45	D40SK45	SK	7.450	7.168	C										9.98	7.98
48	D40SK48	SK	7.930	7.645	C										11.22	9.22
52	D40SK52	SK	8.570	8.281	C										13.04	11.04
54	D40SK54	SK	8.890	8.599	C										14.06	12.06
60	D40SK60	SK	9.840	9.554	C	2%	2 1/2	2 1/2	3 3/8	5/8	1 1/16	1 1/4	.275	.841	16.98	14.98
68	D40SF68	SF	11.180	10.826	C	2 1/16	2 1/4	2 1/4	4%	3/4	1 1/16	1 1/4	2.75	.841	22.72	19.72
72	D40SF72	SF	11.750	11.463	C										24.20	22.20
76	D40SF76	SF	12.390	12.099	C										28.20	25.20
84	D40SF84	SF	13.660	13.372	C										33.64	30.64
95	D40SF95	SF	15.410	15.122	C										40.22	37.22
102	D40SF102	SF	16.530	16.236	C										42.70	39.70
112	D40SF112	SF	18.120	17.828	C	2 1/16	2 1/4	2 1/4	4%	3/4	1 1/16	1 1/4	2.75	.841	52.60	49.60

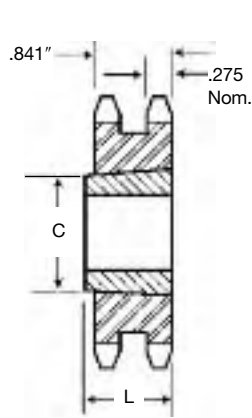

TYPE A

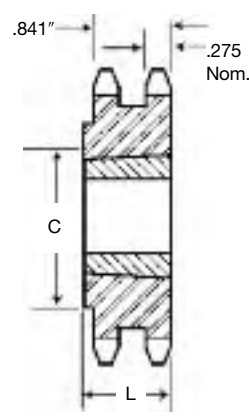

TYPE B

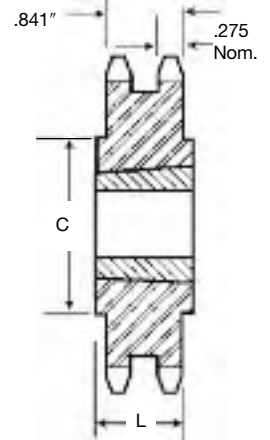

TYPE C

Double-Taper Bushed

No. Teeth	Catalog Number	Bushing	Diameters		Max. Bore	Dimensions		Type	Weight (Approx.)	
			Outside Diameter	Pitch Diameter		L	C		Rim Only	Bushing Only
15	D40ATB15H	1008	2.652	2.405	1	3/8	1 1/4	A	.5	.3
16	D40ATB16H	1008	2.814	2.563	1	3/8	1 1/4	A	.6	.3
17	D40ATB17H	1008	2.975	2.721	1	3/8	1 1/4	A	.7	.3
18	D40BTB18H	1210	3.135	2.879	1 1/4	1	2 5/8	B	.7	.6
19	D40BTB19H	1210	3.296	3.038	1 1/4	1	2 1/2	B	.9	.6
20	D40BTB20H	1610	3.457	3.196	1 1/2	1	2 3/4	B	.9	.9
21	D40BTB21H	1610	3.617	3.355	1 1/2	1	2 3/4	B	1.0	.9
23	D40BTB23H	1610	3.938	3.672	1 1/2	1	3	B	1.3	.9
25	D40BTB25H	2012	4.258	3.989	2	1 1/4	3 13/32	B	1.6	1.7
30	D40BTB30	2012	5.057	4.783	2	1 1/4	4 1/4	B	3.4	1.7
36	D40BTB36	2012	6.015	5.737	2	1 1/4	5 5/8	B	5.9	1.7
42	D40CTB42	2517	6.972	6.691	2 1/2	1 3/4	4 1/4	C	7.0	3.5
48	D40CTB48	2517	7.928	7.645	2 3/4	1 3/4	4 1/4	C	9.6	3.5
52	D40CTB52	2517	8.566	8.281	2 3/4	1 3/4	4 1/4	C	11.4	3.5
60	D40CTB60	2517	9.841	9.554	2 3/4	1 3/4	4 1/4	C	15.4	3.5
68	D40CTB68	2517	11.115	10.826	2 3/4	1 3/4	4 1/4	C	20.5	3.5
76	D40CTB76	2517	12.389	12.099	2 3/4	1 3/4	4 1/4	C	25.7	3.5
84	D40CTB84	2517	13.663	13.372	2 3/4	1 3/4	4 1/4	C	31.6	3.5
95	D40CTB95	2517	15.414	15.122	2 3/4	1 3/4	4 1/4	C	34.1	3.5
102	D40CTB102	2517	16.529	16.236	2 3/4	1 3/4	4 1/4	C	36.8	3.5

NOTE: Double 40 stock sprockets with 25 teeth or less have hardened teeth.
As indicated by H suffix.

No. 40-2

1/2" Pitch

MST[®] Sprockets

Martin

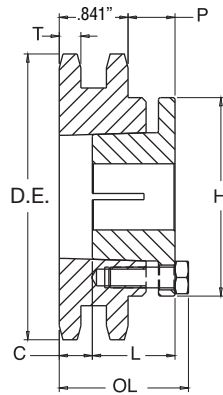

TIPO 11

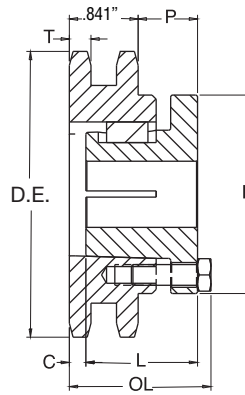

TIPO 12

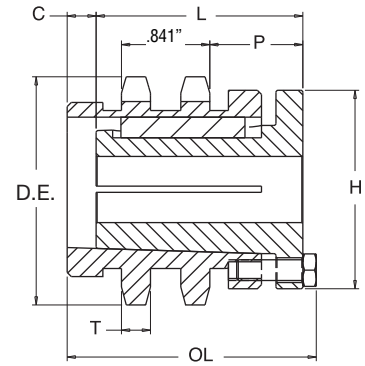

TIPO 16

Double - MST[®] Sprockets

No. Teeth	Catalog Number	Bush-ing	Diameters		Type	Max. Bore	Dimensions						Weight (Approx.)	
			Outside Dia.	Pitch Dia.			OL	L	C	H	P	T(nom)	With Hub	Rim Only
15	D40H15H	H	2.650	2.405	11	1-1/2	2-5/32	1-1/4	23/32	2-1/2	1-1/8	.275	1.7	.9
16	D40H16H	H	2.810	2.563	11	1-1/2	2-5/32	1-1/4	23/32	2-1/2	1-1/8	.275	1.8	1.0
17	D40H17H	H	2.980	2.721	11	1-1/2	2-5/32	1-1/4	23/32	2-1/2	1-1/8	.275	1.9	1.1
18	D40P18H	P1	3.140	2.879	16	1-3/4	3 3/16	1-15/16	1	3	1-3/8	.275	3.1	1.8
19	D40P19H	P1	3.300	3.038	12	1-3/4	2 15/32	1-15/16	9/32	3	1-3/8	.275	2.7	1.4
20	D40P20H	P1	3.460	3.196	12	1-3/4	2-13/32	1-15/16	7/32	3	1-3/8	.275	2.9	1.6
21	D40P21H	P1	3.620	3.355	12	1-3/4	2-13/32	1-15/16	7/32	3	1-3/8	.275	3.1	1.8
22	D40P22H	P1	3.780	3.513	12	1-3/4	2-13/32	1-15/16	7/32	3	1-3/8	.275	3.3	2.0
23	D40P23H	P1	3.940	3.672	12	1-3/4	2-3/16	1-15/16	0	3	1-3/32	.275	3.3	2.0
24	D40P24H	P1	4.100	3.831	12	1-3/4	2-3/16	1-15/16	0	3	1-3/32	.275	3.5	2.2
25	D40P25H	P1	4.260	3.989	12	1-3/4	2-3/16	1-15/16	0	3	1-3/32	.275	3.8	2.5
26	D40P26H	P1	4.420	4.148	12	1-3/4	2-3/16	1-15/16	0	3	1-3/32	.275	4.0	2.7
28	D40P28H	P1	4.740	4.466	12	1-3/4	2-3/16	1-15/16	0	3	1-3/32	.275	4.4	3.1
30	D40Q30H	Q1	5.060	4.783	12	2-11/16	2-25/32	2-1/2	0	4-1/8	1-21/32	.275	7.7	4.2
32	D40Q32H	Q1	5.380	5.101	12	2-11/16	2-25/32	2-1/2	0	4-1/8	1-21/32	.275	8.8	5.3
35	D40Q35H	Q1	5.860	5.578	12	2-11/16	2-25/32	2-1/2	0	4-1/8	1-21/32	.275	9.6	6.1
36	D40Q36H	Q1	6.020	5.737	12	2-11/16	2-25/32	2-1/2	0	4-1/8	1-21/32	.275	10.0	6.5
40	D40Q40H	Q1	6.650	6.373	12	2-11/16	2-25/32	2-1/2	0	4-1/8	1-21/32	.275	11.4	7.9
42	D40Q42H	Q1	6.970	6.691	12	2-11/16	2-25/32	2-1/2	0	4-1/8	1-21/32	.275	12.4	8.9
45	D40Q45H	Q1	7.450	7.168	12	2-11/16	2-25/32	2-1/2	0	4-1/8	1-21/32	.275	13.6	10.1
48	D40Q48H	Q1	7.930	7.645	12	2-11/16	2-25/32	2-1/2	0	4-1/8	1-21/32	.275	15.3	11.8
52	D40Q52H	Q1	8.570	8.281	12	2-11/16	2-25/32	2-1/2	0	4-1/8	1-21/32	.275	16.1	12.6
54	D40Q54H	Q1	8.890	8.599	12	2-11/16	2-25/32	2-1/2	0	4-1/8	1-21/32	.275	17.8	14.3
60	D40Q60H	Q1	9.840	9.554	12	2-11/16	2-25/32	2-1/2	0	4-1/8	1-21/32	.275	20.9	17.4
68	D40Q68	Q1	11.120	10.826	12	2-11/16	2-25/32	2-1/2	0	4-1/8	1-21/32	.275	25.0	21.5
72	D40Q72	Q1	11.750	11.463	12	2-11/16	2-25/32	2-1/2	0	4-1/8	1-21/32	.275	28.5	25.0
76	D40Q76	Q1	12.390	12.099	12	2-11/16	2-25/32	2-1/2	0	4-1/8	1-21/32	.275	30.4	26.9
84	D40Q84	Q1	13.660	13.372	12	2-11/16	2-25/32	2-1/2	0	4-1/8	1-21/32	.275	37.6	34.1
95	D40Q95	Q1	15.410	15.122	12	2-11/16	2-25/32	2-1/2	0	4-1/8	1-21/32	.275	45.5	42.0
96	D40Q96	Q1	15.570	15.281	12	2-11/16	2-25/32	2-1/2	0	4-1/8	1-21/32	.275	47.6	44.1
102	D40Q102	Q1	16.530	16.236	12	2-11/16	2-25/32	2-1/2	0	4-1/8	1-21/32	.275	52.0	48.5
112	D40Q112	Q1	18.120	17.828	12	2-11/16	2-25/32	2-1/2	0	4-1/8	1-21/32	.275	64.5	61.0

Sprockets with "H" suffix have hardened teeth.

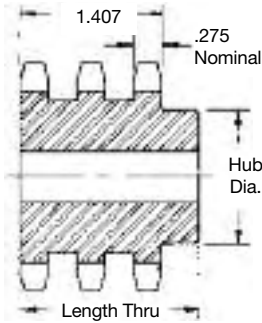

TYPE B

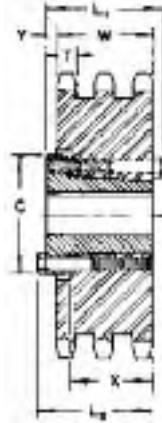

QD — TYPE B

Alteration Charges

See current discount sheet for alteration charges.

Triple-Type B

No. Teeth	Catalog Number	Outside Diameter	Type	Bore (inches)		Hub (inches)		Weight Lbs. (Approx.)
				Stock	Rec. Max.	Dia.	Length Thru	
11	E40B11H	2.000	B	1/2	3/4	1 1/8*	2 1/2	.80
12	E40B12H	2.170	B	1/2	15/16	1 1/8*	2 1/2	1.10
13	E40B13H	2.330	B	1/2	1	1 1/2	2 1/2	1.24
14	E40B14H	2.490	B	1/2	1 1/8	1 1/8	2 1/2	1.50
15	E40B15H	2.650	B	1/2	1 1/4	1 1/8	2 1/2	1.76
16	E40B16H	2.810	B	5/8	1 1/2	2	2 1/2	2.04
17	E40B17H	2.980	B	5/8	1 1/2	2 1/2	2 1/2	2.34
18	E40B18H	3.140	B	5/8	1 1/2	2 1/2	2 1/2	2.72
19	E40B19H	3.300	B	5/8	1 1/4	2 1/2	2 1/2	3.10
20	E40B20H	3.460	B	5/8	1 1/2	2 1/2	2 1/2	3.72
21	E40B21H	3.620	B	5/8	1 1/2	2 1/2	2 1/2	4.06
22	E40B22H	3.780	B	5/8	1 1/2	2 1/2	2 1/2	4.52
23	E40B23H	3.940	B	5/8	2	3	2 1/2	4.96
24	E40B24H	4.100	B	5/8	2 1/4	3 1/2	2 1/2	5.64
25	E40B25H	4.260	B	5/8	2 1/4	3 1/2	2 1/2	6.02
26	E40B26	4.420	B	5/8	2 1/4	3 1/2	2 1/2	6.36
30	E40B30	5.060	B	7/8	2 1/4	3 1/2	2 1/2	7.84
35	E40B35	5.860	B	7/8	2 1/4	3 1/2	2 1/2	10.30
36	E40B36	6.020	B	15/16	2 1/2	3 1/2	2 1/2	11.72
42	E40B42	6.970	B	15/16	2 1/2	3 1/2	2 1/2	15.36
48	E40B48	7.930	B	15/16	2 1/2	3 1/2	2 1/2	19.36
52	E40B52	8.570	B	15/16	2 1/2	3 1/2	2 1/2	22.44
60	E40B60	9.840	B	15/16	2 1/2	3 1/2	2 1/2	30.02
68	E40B68	11.120	B	1 1/8	2 1/2	4	2 1/2	38.44
72	E40B72	11.750	B	1 1/8	2 1/2	4	2 1/2	42.46
76	E40B76	12.390	B	1 1/8	2 1/2	4	2 1/2	46.90
84	E40B84	13.660	B	1 1/8	2 1/2	4 1/4	2 1/2	57.30
95	E40B95	15.410	B	1 1/8	2 1/2	4 1/4	2 1/2	62.18
102	E40B102	16.530	B	1 1/8	2 1/2	4 1/4	2 1/2	68.40

* Has recessed groove in hub for chain clearance.

Maximum bores shown will accommodate standard keyseat and setscrew over keyseat. Slightly larger bores are possible with no keyseat, shallow keyseat, or setscrew at angle to keyseat.

NOTE: Triple 40 stock sprockets with 25 teeth or less have hardened teeth. As indicated by H suffix.

Triple-Type QD

No. Teeth	Catalog Number	Bushing	Diameters		Type	Max. Bore	Dimensions						Weight (Approx.)		
			Outside Diameter	Pitch Diameter			L ₁	L ₂	C	Y	X	T	W	With Hub	Rim Only
36	E40SK36	SK	6.020	5.737	B	2%	2 1/2	2 1/2	3 1/2	15/32	1 1/4	.275	1.407	8.16	6.16
42	E40SK42	SK	6.970	6.691	B									11.92	9.52
48	E40SK48	SK	7.930	7.645	B									15.13	13.16
52	E40SK52	SK	8.570	8.281	B									18.08	16.08
60	E40SK60	SK	9.840	9.554	B	2%	2 1/2	2 1/2	3 1/2	15/32	1 1/4	.275	1.407	24.60	22.60
68	E40SF68	SF	11.120	10.826	B	2 1/8	2 1/4	2 1/4	4%	15/32	1 1/4	.275	1.407	31.98	29.98
72	E40SF72	SF	11.750	11.463	B									37.40	34.40
76	E40SF76	SF	12.390	12.099	B									51.92	48.92
84	E40SF84	SF	13.660	13.372	B									56.70	53.78
95	E40SF95	SF	15.410	15.122	B									58.94	55.94
102	E40SF102	SF	16.530	16.236	B	2 1/8	2 1/4	2 1/4	4%	15/32	1 1/4	.275	1.407	62.24	59.24

No. 40-3

1/2" Pitch

MST[®] Sprockets

Martin

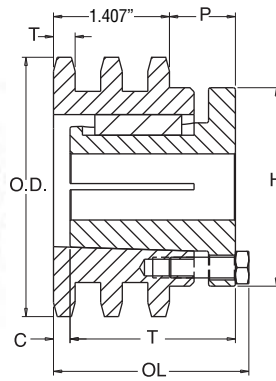

TYPE 22

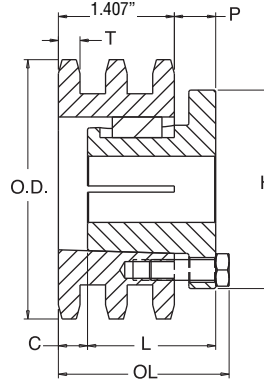

TYPE 23

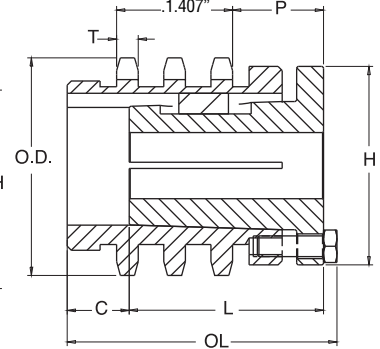

TYPE 27

SPROCKETS

Triple - MST[®] Sprockets

No. Teeth	Catalog Number	Bush-ing	Diameters		Type	Max. Bore	Dimensions						Weight (Approx.)	
			Outside Dia.	Pitch Dia.			OL	L	C	H	P	T(nom)	With Hub	Rim Only
18	E40P18H	P1	3.140	2.879	27	1-3/4	3-3/4	1-15/16	1 9/16	3	1-3/8	.275	3.2	1.9
19	E40P19H	P1	3.300	3.038	22	1-3/4	3 1/32	1-15/16	27/32	3	1-3/8	.275	3.1	1.8
20	E40P20H	P1	3.460	3.196	22	1-3/4	2 31/32	1-15/16	25/32	3	1-5/16	.275	3.3	2.0
23	E40P23H	P1	3.940	3.672	23	1-3/4	2-9/32	1-15/16	3/32	3	5/8	.275	3.6	2.3
24	E40P24H	P1	4.100	3.831	23	1-3/4	2-9/32	1-15/16	3/32	3	5/8	.275	3.9	2.6
25	E40P25H	P1	4.260	3.989	23	1-3/4	2-9/32	1-15/16	3/32	3	5/8	.275	4.3	3.0
27	E40P27H	P1	4.580	4.307	23	1-3/4	2-9/32	1-15/16	3/32	3	5/8	.275	4.6	3.3
30	E40Q30H	Q1	5.060	4.783	22	2-11/16	2-25/32	2-1/2	0	4-1/8	1-3/32	.275	8.0	4.5
35	E40Q35H	Q1	5.860	5.578	22	2-11/16	2-25/32	2-1/2	0	4-1/8	1-3/32	.275	10.4	6.9
36	E40Q36H	Q1	6.020	5.737	22	2-11/16	2-25/32	2-1/2	0	4-1/8	1-3/32	.275	11.1	7.6
42	E40Q42H	Q1	6.970	6.691	22	2-11/16	2-25/32	2-1/2	0	4-1/8	1-3/32	.275	14.6	11.1
48	E40Q48H	Q1	7.930	7.645	22	2-11/16	2-25/32	2-1/2	0	4-1/8	1-3/32	.275	18.7	15.2
52	E40Q52H	Q1	8.570	8.281	22	2-11/16	2-25/32	2-1/2	0	4-1/8	1-3/32	.275	22.2	18.7
54	E40Q54H	Q1	8.890	8.599	22	2-11/16	2-25/32	2-1/2	0	4-1/8	1-3/32	.275	23.4	19.9
60	E40Q60H	Q1	9.840	9.554	22	2-11/16	2-25/32	2-1/2	0	4-1/8	1-3/32	.275	28.8	25.3
68	E40Q68	Q1	11.120	10.826	22	2-11/16	2-25/32	2-1/2	0	4-1/8	1-3/32	.275	37.0	33.5
72	E40Q72	Q1	11.750	11.463	22	2-11/16	2-25/32	2-1/2	0	4-1/8	1-3/32	.275	41.4	37.9
76	E40Q76	Q1	12.390	12.099	22	2-11/16	2-25/32	2-1/2	0	4-1/8	1-3/32	.275	46.0	42.5
84	E40Q84	Q1	13.660	13.372	22	2-11/16	2-25/32	2-1/2	0	4-1/8	1-3/32	.275	55.9	52.4
95	E40Q95	Q1	15.410	15.122	22	2-11/16	2-25/32	2-1/2	0	4-1/8	1-3/32	.275	71.4	67.9
102	E40Q102	Q1	16.530	16.236	22	2-11/16	2-25/32	2-1/2	0	4-1/8	1-3/32	.275	82.0	78.5

Sprockets with "H" suffix have hardened teeth.

Martin

All Steel Stock Sprockets

No. 50

5/8" Pitch

Single Type "BS" — 2 Setscrews — Bored-To-Size

No. Teeth	Catalog Number	Outside Diameter	Length Thru Bore	Weight Lbs. (Approx.)	Stock Finished Bores Includes Keyway and 2 Setscrews
9	50BS9	2.090	1	.30	5/8 - 3/4
10	50BS10	2.300	1	.30	5/8 - 3/4 - 7/8 - 1
11	50BS11	2.500	1	.60	5/8 - 3/4 - 7/8 - 1
12	50BS12	2.710	1	.70	5/8 - 3/4 - 7/8 - 1 - 1 1/8 - 1 3/8 - 1 1/2
13	50BS13	2.910	1	.80	5/8 - 3/4 - 7/8 - 1 - 1 1/8 - 1 3/8 - 1 1/2
14	50BS14	3.110	1	1.00	5/8 - 3/4 - 7/8 - 1 - 1 1/8 - 1 3/8 - 1 1/2
15	50BS15	3.320	1	1.20	5/8 - 3/4 - 7/8 - 1 - 1 1/8 - 1 3/8 - 1 1/2 - 1 3/4 - 1 5/8 - 1 3/2
16	50BS16	3.520	1	1.45	5/8 - 3/4 - 7/8 - 1 - 1 1/8 - 1 3/8 - 1 1/2 - 1 3/4 - 1 5/8 - 1 3/2 - 1 3/4
17	50BS17	3.720	1	1.60	5/8 - 3/4 - 7/8 - 1 - 1 1/8 - 1 3/8 - 1 1/2 - 1 3/4 - 1 5/8 - 1 3/2 - 1 3/4
18	50BS18	3.920	1	1.90	5/8 - 3/4 - 7/8 - 1 - 1 1/8 - 1 3/8 - 1 1/2 - 1 3/4 - 1 5/8 - 1 3/2 - 1 3/4
19	50BS19	4.120	1	2.00	5/8 - 3/4 - 7/8 - 1 - 1 1/8 - 1 3/8 - 1 1/2 - 1 3/4 - 1 5/8 - 1 3/2 - 1 3/4
20	50BS20	4.320	1	2.10	5/8 - 3/4 - 7/8 - 1 - 1 1/8 - 1 3/8 - 1 1/2 - 1 3/4 - 1 5/8 - 1 3/2 - 1 3/4
21	50BS21	4.520	1	2.25	5/8 - 3/4 - 7/8 - 1 - 1 1/8 - 1 3/8 - 1 1/2 - 1 3/4 - 1 5/8 - 1 3/2 - 1 3/4
22	50BS22	4.720	1	2.40	5/8 - 3/4 - 7/8 - 1 - 1 1/8 - 1 3/8 - 1 1/2 - 1 3/4 - 1 5/8 - 1 3/2 - 1 3/4
23	50BS23	4.920	1	2.50	5/8 - 3/4 - 7/8 - 1 - 1 1/8 - 1 3/8 - 1 1/2 - 1 3/4 - 1 5/8 - 1 3/2 - 1 3/4
24	50BS24	5.120	1 1/4	3.00	5/8 - 7/8 - 1 - 1 1/8 - 1 3/8 - 1 1/2 - 1 3/4 - 1 5/8 - 1 3/2 - 1 3/4
25	50BS25	5.320	1 1/4	3.10	5/8 - 7/8 - 1 - 1 1/8 - 1 3/8 - 1 1/2 - 1 3/4 - 1 5/8 - 1 3/2 - 1 3/4
26	50BS26	5.520	1 1/4	3.30	5/8 - 7/8 - 1 - 1 1/8 - 1 3/8 - 1 1/2 - 1 3/4 - 1 5/8 - 1 3/2 - 1 3/4
27	50BS27	5.720	1 1/4	3.46	5/8 - 7/8 - 1 - 1 1/8 - 1 3/8 - 1 1/2 - 1 3/4 - 1 5/8 - 1 3/2 - 1 3/4
28	50BS28	5.920	1 1/4	3.60	5/8 - 7/8 - 1 - 1 1/8 - 1 3/8 - 1 1/2 - 1 3/4 - 1 5/8 - 1 3/2 - 1 3/4
29	50BS29	6.120	1 1/4	3.78	5/8 - 7/8 - 1 - 1 1/8 - 1 3/8 - 1 1/2 - 1 3/4 - 1 5/8 - 1 3/2 - 1 3/4
30	50BS30	6.320	1 1/4	3.90	5/8 - 7/8 - 1 - 1 1/8 - 1 3/8 - 1 1/2 - 1 3/4 - 1 5/8 - 1 3/2 - 1 3/4
31	50BS31	6.520	1 1/4	4.46	5/8 - 7/8 - 1 - 1 1/8 - 1 3/8 - 1 1/2 - 1 3/4 - 1 5/8 - 1 3/2 - 1 3/4 - 1 3/8 - 1 1/2
32	50BS32	6.720	1 1/4	4.70	5/8 - 7/8 - 1 - 1 1/8 - 1 3/8 - 1 1/2 - 1 3/4 - 1 5/8 - 1 3/2 - 1 3/4 - 1 3/8 - 1 1/2
33	50BS33	6.920	1 1/4	4.92	5/8 - 7/8 - 1 - 1 1/8 - 1 3/8 - 1 1/2 - 1 3/4 - 1 5/8 - 1 3/2 - 1 3/4 - 1 3/8 - 1 1/2
34	50BS34	7.120	1 1/4	5.06	5/8 - 7/8 - 1 - 1 1/8 - 1 3/8 - 1 1/2 - 1 3/4 - 1 5/8 - 1 3/2 - 1 3/4 - 1 3/8 - 1 1/2
35	50BS35	7.320	1 1/4	5.30	5/8 - 7/8 - 1 - 1 1/8 - 1 3/8 - 1 1/2 - 1 3/4 - 1 5/8 - 1 3/2 - 1 3/4 - 1 3/8 - 1 1/2
36	50BS36	7.520	1 1/4	5.50	5/8 - 7/8 - 1 - 1 1/8 - 1 3/8 - 1 1/2 - 1 3/4 - 1 5/8 - 1 3/2 - 1 3/4 - 1 3/8 - 1 1/2
37	50BS37	7.720	1 1/4	5.62	5/8 - 7/8 - 1 - 1 1/8 - 1 3/8 - 1 1/2 - 1 3/4 - 1 5/8 - 1 3/2 - 1 3/4 - 1 3/8 - 1 1/2
38	50BS38	7.920	1 1/4	5.80	5/8 - 7/8 - 1 - 1 1/8 - 1 3/8 - 1 1/2 - 1 3/4 - 1 5/8 - 1 3/2 - 1 3/4 - 1 3/8 - 1 1/2
39	50BS39	8.120	1 1/4	6.02	5/8 - 7/8 - 1 - 1 1/8 - 1 3/8 - 1 1/2 - 1 3/4 - 1 5/8 - 1 3/2 - 1 3/4 - 1 3/8 - 1 1/2
40	50BS40	8.320	1 1/4	6.20	5/8 - 7/8 - 1 - 1 1/8 - 1 3/8 - 1 1/2 - 1 3/4 - 1 5/8 - 1 3/2 - 1 3/4 - 1 3/8 - 1 1/2
41	50BS41	8.520	1 1/4	6.45	5/8 - 7/8 - 1 - 1 1/8 - 1 3/8 - 1 1/2 - 1 3/4 - 1 5/8 - 1 3/2 - 1 3/4 - 1 3/8 - 1 1/2
42	50BS42	8.720	1 1/4	6.68	5/8 - 7/8 - 1 - 1 1/8 - 1 3/8 - 1 1/2 - 1 3/4 - 1 5/8 - 1 3/2 - 1 3/4 - 1 3/8 - 1 1/2
43	50BS43	8.910	1 1/4	6.99	5/8 - 7/8 - 1 - 1 1/8 - 1 3/8 - 1 1/2 - 1 3/4 - 1 5/8 - 1 3/2 - 1 3/4 - 1 3/8 - 1 1/2
44	50BS44	9.110	1 1/4	7.30	5/8 - 7/8 - 1 - 1 1/8 - 1 3/8 - 1 1/2 - 1 3/4 - 1 5/8 - 1 3/2 - 1 3/4 - 1 3/8 - 1 1/2
45	50BS45	9.310	1 1/4	8.00	5/8 - 7/8 - 1 - 1 1/8 - 1 3/8 - 1 1/2 - 1 3/4 - 1 5/8 - 1 3/2 - 1 3/4 - 1 3/8 - 1 1/2
46	50BS46	9.510	1 1/4	8.51	1 - 1 1/8 - 1 3/8 - 1 1/2 - 1 3/4 - 1 5/8 - 1 3/2 - 1 3/4 - 1 3/8 - 1 1/2
47	50BS47	9.710	1 1/4	8.76	1 - 1 1/8 - 1 3/8 - 1 1/2 - 1 3/4 - 1 5/8 - 1 3/2 - 1 3/4 - 1 3/8 - 1 1/2
48	50BS48	9.910	1 1/4	9.03	1 - 1 1/8 - 1 3/8 - 1 1/2 - 1 3/4 - 1 5/8 - 1 3/2 - 1 3/4 - 1 3/8 - 1 1/2
49	50BS49	10.110	1 1/4	9.33	1 - 1 1/8 - 1 3/8 - 1 1/2 - 1 3/4 - 1 5/8 - 1 3/2 - 1 3/4 - 1 3/8 - 1 1/2
50	50BS50	10.310	1 1/4	9.63	1 - 1 1/8 - 1 3/8 - 1 1/2 - 1 3/4 - 1 5/8 - 1 3/2 - 1 3/4 - 1 3/8 - 1 1/2
51	50BS51	10.510	1 1/4	9.81	1 - 1 1/8 - 1 3/8 - 1 1/2 - 1 3/4 - 1 5/8 - 1 3/2 - 1 3/4 - 1 3/8 - 1 1/2
52	50BS52	10.710	1 1/4	9.99	1 - 1 1/8 - 1 3/8 - 1 1/2 - 1 3/4 - 1 5/8 - 1 3/2 - 1 3/4 - 1 3/8 - 1 1/2
53	50BS53	10.910	1 1/4	10.37	1 - 1 1/8 - 1 3/8 - 1 1/2 - 1 3/4 - 1 5/8 - 1 3/2 - 1 3/4 - 1 3/8 - 1 1/2
54	50BS54	11.110	1 1/4	10.75	1 - 1 1/8 - 1 3/8 - 1 1/2 - 1 3/4 - 1 5/8 - 1 3/2 - 1 3/4 - 1 3/8 - 1 1/2
55	50BS55	11.310	1 1/4	11.08	1 - 1 1/8 - 1 3/8 - 1 1/2 - 1 3/4 - 1 5/8 - 1 3/2 - 1 3/4 - 1 3/8 - 1 1/2
56	50BS56	11.500	1 1/4	11.41	1 - 1 1/8 - 1 3/8 - 1 1/2 - 1 3/4 - 1 5/8 - 1 3/2 - 1 3/4 - 1 3/8 - 1 1/2
57	50BS57	11.700	1 1/4	11.75	1 - 1 1/8 - 1 3/8 - 1 1/2 - 1 3/4 - 1 5/8 - 1 3/2 - 1 3/4 - 1 3/8 - 1 1/2
58	50BS58	11.900	1 1/4	12.08	1 - 1 1/8 - 1 3/8 - 1 1/2 - 1 3/4 - 1 5/8 - 1 3/2 - 1 3/4 - 1 3/8 - 1 1/2
59	50BS59	12.100	1 1/4	12.41	1 - 1 1/8 - 1 3/8 - 1 1/2 - 1 3/4 - 1 5/8 - 1 3/2 - 1 3/4 - 1 3/8 - 1 1/2
60	50BS60	12.300	1 1/4	13.50	1 - 1 1/8 - 1 3/8 - 1 1/2 - 1 3/4 - 1 5/8 - 1 3/2 - 1 3/4 - 1 3/8 - 1 1/2
70	50BS70	14.290	1 1/2	17.81	1 - 1 1/8 - 1 3/8 - 1 1/2 - 1 3/4 - 1 5/8 - 1 3/2 - 1 3/4 - 1 3/8 - 1 1/2
72	50BS72	14.690	1 1/2	19.13	1 - 1 1/8 - 1 3/8 - 1 1/2 - 1 3/4 - 1 5/8 - 1 3/2 - 1 3/4 - 1 3/8 - 1 1/2
80	50BS80	16.280	1 1/2	24.39	1 - 1 1/8 - 1 3/8 - 1 1/2 - 1 3/4 - 1 5/8 - 1 3/2 - 1 3/4 - 1 3/8 - 1 1/2
84	50BS84	17.080	1 1/2	25.15	1 - 1 1/8 - 1 3/8 - 1 1/2 - 1 3/4 - 1 5/8 - 1 3/2 - 1 3/4 - 1 3/8 - 1 1/2
96	50BS96	19.470	1 1/2	32.57	1 - 1 1/8 - 1 3/8 - 1 1/2 - 1 3/4 - 1 5/8 - 1 3/2 - 1 3/4 - 1 3/8 - 1 1/2
112	50BS112	22.650	1 1/2	41.65	1 - 1 1/8 - 1 3/8 - 1 1/2 - 1 3/4 - 1 5/8 - 1 3/2 - 1 3/4 - 1 3/8 - 1 1/2

* Keyway with Setscrew at 90°. Hub diameters vary to suit different bore sizes.

KEYWAY IS ON CENTER LINE OF TOOTH.

SPROCKETS

Martin

All Steel Stock Sprockets

No. 50

5/8" Pitch

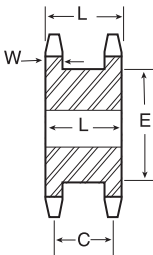

TYPE A

Double Single-Type A — Steel

No. Teeth	Catalog Number	Diameters		Type	Min. Bore	Max. Bore	Dimensions				Wt. (Approx.)
		Outside Diameter	Pitch Diameter				L	C	E	w Nom.	
15	DS50A15	3.320	3.006	A	5/8	1 1/2	1 7/8	1 1/8	2 3/8	.343	2.1
16	DS50A16	3.520	3.204	A	5/8	1 1/8	1 7/8	1 1/8	2 3/8	.343	2.4
17	DS50A17	3.720	3.401	A	5/8	1 1/4	1 7/8	1 1/8	2 1/2	.343	2.9
18	DS50A18	3.920	3.599	A	5/8	1 1/2	1 7/8	1 1/8	2 5/8	.343	3.3
19	DS50A19	4.120	3.797	A	5/8	2 1/8	1 7/8	1 1/8	3 1/8	.343	3.7
20	DS50A20	4.320	3.995	A	5/8	2 1/4	1 7/8	1 1/8	3 1/2	.343	4.2
21	DS50A21	4.520	4.194	A	5/8	2 1/2	1 7/8	1 1/8	3 3/4	.343	4.8
22	DS50A22	4.720	4.392	A	5/8	2 3/8	1 7/8	1 1/8	3 7/8	.343	5.3
23	DS50A23	4.920	4.590	A	5/8	2 3/4	1 7/8	1 1/8	4 1/8	.343	5.8
24	DS50A24	5.120	4.788	A	5/8	3 1/8	1 7/8	1 1/8	4 3/4	.343	6.3

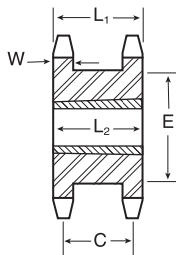

TAPER BUSH TYPE A

Double Single-Taper Bushed — Steel

No. Teeth	Catalog Number	Bushing Size	Diameters		Min. Bore	Max. Bore	Type	Dimensions					Wt. Rim Only
			Outside Diameter	Pitch Diameter				L ₁	C	E	L ₂	w Nom.	
16	DS50ATB16H	1215	3.520	3.204	1/2	1 1/2	A	1 7/8	1 1/8	2 3/8	1 1/2	.343	3.0
17	DS50ATB17H	1615	3.720	3.401	1/2	1 1/4	A	1 7/8	1 1/8	2 1/2	1 1/2	.343	1.8
18	DS50ATB18H	1615	3.920	3.599	1/2	1 1/2	A	1 7/8	1 1/8	2 5/8	1 1/2	.343	2.2
19	DS50ATB19H	1615	4.120	3.797	1/2	1 1/4	A	1 7/8	1 1/8	3 1/8	1 1/2	.343	2.7
20	DS50ATB20H	1615	4.320	3.995	1/2	1 1/2	A	1 7/8	1 1/8	3 1/2	1 1/2	.343	5.0
21	DS50ATB21H	2012	4.520	4.194	1/2	2	A	1 7/8	1 1/8	3 3/4	1 1/4	.343	3.3
23	DS50ATB23H	2012	4.920	4.590	1/2	2	A	1 7/8	1 1/8	3 7/8	1 1/4	.343	3.7
24	DS50ATB24H	2012	5.120	4.788	1/2	2	A	1 7/8	1 1/8	4 1/8	1 1/4	.343	4.1

Sprockets with "H" suffix have hardened teeth.

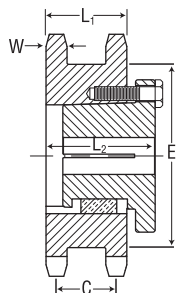

MST TYPE B

Double Single- MST® — Steel

No. Teeth	Catalog Number	Bushing Size	Diameters		Min. Bore	Max. Bore	Type	Dimensions					Wt. Rim Only
			Outside Diameter	Pitch Diameter				L ₁	C	E	L ₂	w Nom.	
17	DS50H17H	H	3.720	3.401	3/8	1 1/2	BH	1 7/8	1 1/8	2 1/8	2 3/8	.343	2.3
19	DS50P19H	P1	4.120	3.797	1/2	1 1/4	B	1 7/8	1 1/8	3 3/8	2 1/8	.343	2.8
21	DS50P21H	P1	4.520	4.194	1/2	1 1/4	B	1 7/8	1 1/8	3 3/8	2 1/8	.343	3.8
23	DS50P23H	P1	4.920	4.590	1/2	1 1/4	B	1 7/8	1 1/8	3 3/8	2 1/8	.343	4.6
24	DS50P24H	P1	5.120	4.788	1/2	1 1/4	B	1 7/8	1 1/8	4 1/8	2 1/8	.343	5.0

Sprockets with "H" suffix have hardened teeth.

SPROCKETS

No. 50
5/8" Pitch

Stainless Steel
Stock Sprockets



Single-Type B — Stainless

Single-Type A

No. Teeth	Catalog Number	Outside Diameter	Type	Bore (inches)		Hub (inches)		Weight Lbs. (Approx.)	Type	Catalog Number	Stock Bore	Lbs. (Approx.)
				Stock	Rec. Max.	Diameter	Length Thru					
10	50B10SS	2.300	B	5/8	7/8	1 1/16*	1	.5				
11	50B11SS	2.500	B	5/8	1	1 1/8*	1	.6				
12	50B12SS	2.710	B	5/8	1 1/4	1 5/16*	1	.7				
13	50B13SS	2.910	B	5/8	1 1/2	1 7/16	1	.8				
14	50B14SS	3.110	B	5/8	1 5/8	2 1/16	1	1.0				
15	50B15SS	3.320	B	5/8	1 3/4	2 3/16	1	1.3				
16	50B16SS	3.520	B	5/8	1 7/8	2 1/2	1	1.5				
17	50B17SS	3.720	B	5/8	2	2 5/16	1	1.8				
18	50B18SS	3.920	B	5/8	2 1/8	2 7/16	1	2.0				
19	50B19SS	4.120	B	5/8	2 1/4	2 9/16	1	2.3				
20	50B20SS	4.320	B	5/8	2 3/8	2 11/16	1	2.5				
21	50B21SS	4.520	B	5/8	2 1/2	3	1	2.7	A	50A21SS	23/32	1.4
22	50B22SS	4.720	B	5/8	2 5/8	3	1	3.3	A	50A22SS	23/32	1.6
23	50B23SS	4.920	B	5/8	2 3/4	3	1	3.8	A	50A23SS	23/32	1.7
24	50B24SS	5.120	B	5/8	2 7/8	3	1 1/4	4.1	A	50A24SS	23/32	1.8
25	50B25SS	5.320	B	5/8	3	3	1 1/4	4.3	A	50A25SS	23/32	1.9
26	50B26SS	5.520	B	5/8	3 1/8	3	1 1/4	4.6	A	50A26SS	23/32	1.7
28	50B28SS	5.920	B	5/8	3 1/4	3	1 1/4	5.0	A	50A28SS	23/32	2.5
30	50B30SS	6.320	B	5/8	3 3/8	3 1/4	1 1/4	5.2	A	50A30SS	23/32	2.7
35	50B35SS	7.320	B	5/8	4 1/4	3 3/4	1 1/4	6.5	A	50A35SS	23/32	3.7
40	50B40SS	8.320	B	5/8	5 1/4	4 1/4	1 1/4	7.8	A	50A40SS	23/32	4.7
45	50B45SS	9.310	B	5/8	6 1/4	5 1/4	1 1/4	8.5	A	50A45SS	23/32	6.0
60	50B60SS	12.300	B	1	8 1/2	7 3/4	1 1/4	14.0	A	50A60SS	1 1/16	10.8

* Has recessed groove in hub for chain clearance.

Maximum bores shown will accommodate standard keyseat and setscrew over keyseat. Slightly larger bores are possible with no keyseat, shallow keyseat, or setscrew at angle to keyseat.

Sprockets altered at factory (rebored with keyway and setscrew added) will be supplied with stainless setscrew.

SPROCKETS

Alteration Charges
See current discount sheet for alteration charges.



STAINLESS STEEL

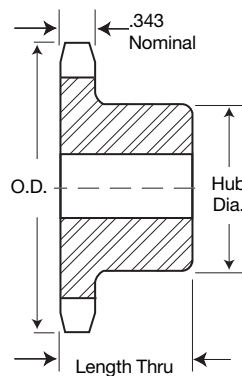

TYPE B

Single-Type B

Single-Type A

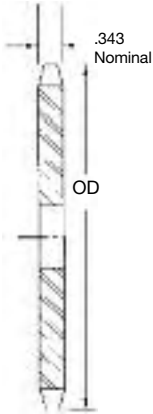

TYPE A

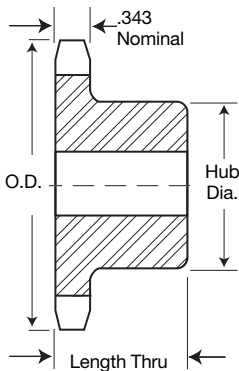

TYPE B

No. Teeth	Catalog Number	Outside Diameter	Type	Bore (inches)		Hub (inches)		Weight Lbs (Approx.)	Type	Catalog Number	Stock Bore	Weight Lbs. (Approx.)
				Stock	Rec. Max.	Diameter	Length Thru					
8	50B8	1.880	B	5/16	5/16	1 1/8*	1	.25				
9	50B9	2.090	B	5/16	5/16	1 1/8*	1	.36				
10	50B10	2.300	B	5/16	5/16	1 1/8*	1	.48				
11	50B11	2.500	B	5/16	1	1 1/8*	1	.64				
12	50B12	2.710	B	5/16	1 1/4	1 5/8*	1	.83	A	50A12	5/16	.34
13	50B13	2.910	B	5/16	1 1/4	1 5/8	1	.88	A	50A13	5/16	.42
14	50B14	3.110	B	5/16	1 1/4	2 1/8	1	1.13	A	50A14	5/16	.50
15	50B15	3.320	B	5/16	1 1/2	2 3/8	1	1.34	A	50A15	5/16	.54
16	50B16	3.520	B	5/16	1 1/2	2 3/8	1	1.51	A	50A16	5/16	.68
17	50B17	3.720	B	5/16	1 1/2	2 1/2	1	1.74	A	50A17	5/16	.76
18	50B18	3.920	B	5/16	1 1/2	2 1/2	1	2.00	A	50A18	5/16	.86
19	50B19	4.120	B	5/16	2	3	1	2.22	A	50A19	5/16	.94
20	50B20	4.320	B	5/16	2	3	1	2.28	A	50A20	5/16	1.06
21	50B21	4.520	B	5/16	2	3	1	2.40	A	50A21	5/16	1.12
22	50B22	4.720	B	5/16	2	3	1	2.56	A	50A22	5/16	1.30
23	50B23	4.920	B	5/16	2	3	1	2.66	A	50A23	5/16	1.44
24	50B24	5.120	B	5/16	2	3	1 1/4	3.30	A	50A24	23/32	1.50
25	50B25	5.320	B	5/16	2	3	1 1/4	3.40	A	50A25	23/32	1.62
26	50B26	5.520	B	5/16	2	3	1 1/4	3.44	A	50A26	23/32	1.72
27	50B27	5.720	B	5/16	2	3	1 1/4	3.74	A	50A27	23/32	1.96
28	50B28	5.920	B	5/16	2	3	1 1/4	3.80	A	50A28	23/32	2.04
29	50B29	6.120	B	5/16	2	3	1 1/4	4.06	A	50A29	23/32	2.36
30	50B30	6.320	B	5/16	2 1/4	3 1/4	1 1/4	4.56	A	50A30	23/32	2.54
31	50B31	6.520	B	5/16	2 1/4	3 1/4	1 1/4	4.74	A	50A31	23/32	2.80
32	50B32	6.720	B	5/16	2 1/4	3 1/4	1 1/4	4.96	A	50A32	23/32	2.72
33	50B33	6.920	B	5/16	2 1/4	3 1/4	1 1/4	5.20	A	50A33	23/32	3.14
34	50B34	7.120	B	5/16	2 1/4	3 1/4	1 1/4	5.14	A	50A34	23/32	3.20
35	50B35	7.320	B	5/16	2 1/4	3 1/4	1 1/4	5.44	A	50A35	23/32	3.34
36	50B36	7.520	B	5/16	2 1/4	3 1/4	1 1/4	5.64	A	50A36	23/32	3.82
37	50B37	7.720	B	5/16	2 1/4	3 1/4	1 1/4	5.90	A	50A37	23/32	3.98
38	50B38	7.920	B	5/16	2 1/4	3 1/4	1 1/4	6.08	A	50A38	23/32	4.14
39	50B39	8.120	B	5/16	2 1/4	3 1/4	1 1/4	6.30	A	50A39	23/32	4.42
40	50B40	8.320	B	5/16	2 1/4	3 1/4	1 1/4	6.50	A	50A40	23/32	4.46
41	50B41	8.520	B	5/16	2 1/4	3 1/4	1 1/4	6.64	A	50A41	23/32	4.86
42	50B42	8.720	B	5/16	2 1/4	3 1/4	1 1/4	6.96	A	50A42	23/32	4.98
43	50B43	8.910	B	5/16	2 1/4	3 1/4	1 1/4	7.06	A	50A43	23/32	5.24
44	50B44	9.110	B	5/16	2 1/4	3 1/4	1 1/4	7.58	A	50A44	23/32	5.42
45	50B45	9.310	B	5/16	2 1/4	3 1/4	1 1/4	8.58	A	50A45	23/32	5.92
46	50B46	9.510	B	1	2 1/2	3 1/4	1 1/4	8.22	A	50A46	15/16	6.42
47	50B47	9.710	B	1	2 1/2	3 1/4	1 1/4	8.48	A	50A47	15/16	6.50
48	50B48	9.910	B	1	2 1/2	3 1/4	1 1/4	9.28	A	50A48	15/16	6.58
49	50B49	10.110	B	1	2 1/2	3 1/4	1 1/4	9.22	A	50A49	15/16	7.06
50	50B50	10.310	B	1	2 1/2	3 1/4	1 1/4	9.88	A	50A50	15/16	7.10
51	50B51	10.510	B	1	2 1/2	3 1/4	1 1/4	9.70	A	50A51	15/16	7.32
52	50B52	10.710	B	1	2 1/2	3 1/4	1 1/4	10.24	A	50A52	15/16	7.98
53	50B53	10.910	B	1	2 1/2	3 1/4	1 1/4	10.48	A	50A53	15/16	8.08
54	50B54	11.110	B	1	2 1/2	3 1/4	1 1/4	11.00	A	50A54	15/16	8.30
55	50B55	11.310	B	1	2 1/2	3 1/4	1 1/4	10.93	A	50A55	15/16	8.56
56	50B56	11.500	B	1	2 1/2	3 1/4	1 1/4	11.50	A	50A56	15/16	8.90
57	50B57	11.700	B	1	2 1/2	3 1/4	1 1/4	12.00	A	50A57	15/16	9.38
58	50B58	11.900	B	1	2 1/2	3 1/4	1 1/4	11.82	A	50A58	15/16	10.30
59	50B59	12.100	B	1	2 1/2	3 1/4	1 1/4	12.32	A	50A59	15/16	10.50
60	50B60	12.300	B	1	2 1/2	3 1/4	1 1/4	13.00	A	50A60	15/16	10.80
70	50B70	14.290	B	1	2 1/2	3 1/4	1 1/4	18.16	A	50A70	15/16	14.00
72	50B72	14.690	B	1	2 1/2	3 1/4	1 1/4	19.48	A	50A72	15/16	15.24
76	50B76	15.486	B	1	2 1/2	3 1/4	1 1/4	21.00	A	50A76	15/16	20.08
80	50B80	16.280	B	1	2 3/4	4 1/4	1 1/4	24.74	A	50A80	15/16	21.00
84	50B84	17.080	B	1	2 3/4	4 1/4	1 1/4	25.50	A	50A84	15/16	22.08
95	50B95	19.270	B	1	2 3/4	4 1/4	1 1/4	32.00	A	50A95	15/16	27.00
96	50B96	19.470	B	1	2 3/4	4 1/4	1 1/4	32.92	A	50A96	15/16	27.40
112	50B112	22.650	B	1	2 3/4	4 1/4	1 1/4	42.00	A	50A112	15/16	37.70

* Has recessed groove in hub for chain clearance.

Maximum bores shown will accommodate standard keyseat and setscrew over keyseat. Slightly larger bores are possible with no keyseat, shallow keyseat, or setscrew at angle to keyseat.

Alteration Charges

See current discount sheet for alteration charges.

No. 50
5/8" Pitch

All Steel
Stock Sprockets



Single-Type QD With Hardened Teeth

No. Teeth	Catalog Number
12	50JA12H
13	50JA13H
14	50JA14H
15	50JA15H
16	50JA16H
17	50SH17H
18	50SH18H
19	50SH19H
20	50SDS20H
21	50SDS21H
22	50SDS22H
23	50SDS23H
24	50SDS24H
25	50SDS25H
26	50SDS26H
27	50SDS27H
28	50SDS28H
30	50SDS30H

S
A
B
E
R

T
O
O
T
H[®]

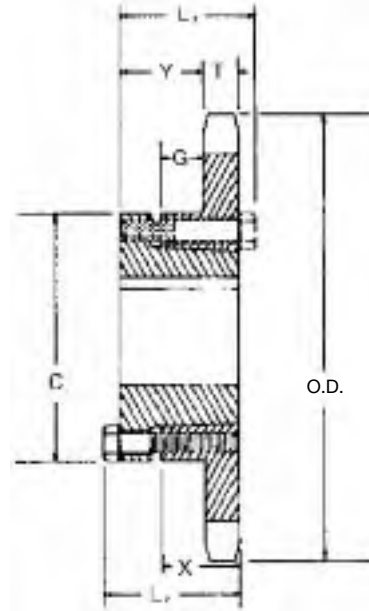

QD — TYPE B

Single-Type QD

No. Teeth	Catalog Number	Bush- ing	Diameters		Type	Max. Bore	Dimensions							Weight (Approx.)	
			Outside Diameter	Pitch Diameter			L ₁	L ₂	C	Y	G	X	T	With Hub	Rim Only
12	50JA12	JA	2.710	2.415	B	1/4	1/8	1/8	2 1/16	2 1/32	3/32	3/8	.343	1.24	.34
13	50JA13	JA	2.910	2.612	B									1.30	.40
14	50JA14	JA	3.110	2.803	B									1.45	.52
15	50JA15	JA	3.320	3.006	B									1.50	.60
16	50JA16	JA	3.520	3.204	B	1/4	1/8	1/8	2 1/16	2 1/32	3/32	3/8	.343	1.58	.68
17	50SH17	SH	3.720	3.401	B	1/2	1/16	1/16	2 1/16	2 9/32	15/32	13/16	.343	1.84	.84
18	50SH18	SH	3.920	3.599	B	1/2	1/16	1/16	2 1/16	2 9/32	15/32	13/16	.343	2.04	1.04
19	50SH19	SH	4.120	3.797	B	1/2	1/16	1/16	2 1/16	2 9/32	15/32	13/16	.343	2.24	1.24
20	50SDS20	SDS	4.320	3.995	B	2	1/2	1/2	3 3/16	3 1/32	1 1/2	3/4	.343	2.20	1.20
21	50SDS21	SDS	4.520	4.194	B									2.32	1.32
22	50SDS22	SDS	4.720	4.392	B									2.48	1.42
23	50SDS23	SDS	4.920	4.590	B									2.58	1.58
24	50SDS24	SDS	5.120	4.788	B									2.70	1.70
25	50SDS25	SDS	5.320	4.987	B									2.86	1.86
26	50SDS26	SDS	5.520	5.185	B									3.00	2.00
27	50SDS27	SDS	5.720	5.384	B									3.12	2.12
28	50SDS28	SDS	5.920	5.582	B									3.32	2.32
30	50SDS30	SDS	6.320	5.979	B									3.64	2.64
32	50SDS32	SDS	6.720	6.376	B									3.98	2.98
35	50SDS35	SDS	7.320	6.972	B									4.62	3.62
36	50SDS36	SDS	7.520	7.171	B									4.64	3.64
40	50SDS40	SDS	8.320	7.966	B									5.74	4.74
42	50SDS42	SDS	8.720	8.363	B									6.40	5.40
45	50SDS45	SDS	9.310	8.960	B									6.90	5.90
48	50SDS48	SDS	9.910	9.556	B	2	1/2	1/2	3 3/16	3 1/32	1 1/2	3/4	.343	7.66	6.66
54	50SK54	SK	11.110	10.749	B	2 1/2	2 1/2	2 1/2	3 3/8	1 11/32	2 1/32	1 1/4	.343	11.68	9.68
60	50SK60	SK	12.300	11.942	B									13.88	11.88
70	50SK70	SK	14.290	13.931	B									17.52	15.52
72	50SK72	SK	14.690	14.329	B	2 3/8	2 3/8	2 3/8	3 1/2	1 13/32	2 1/32	1 1/4	.343	18.44	16.44
80	50SF80	SF	16.280	15.920	B	2 1/2	2 1/4	2 1/4	4 1/8	1 21/32	2 1/32	1 1/4	.343	22.90	19.90
84	50SF84	SF	17.080	16.715	B									25.98	22.98
96	50SF96	SF	19.470	19.102	B									32.88	29.88
112	50SF112	SF	22.650	22.285	B	2 1/2	2 1/4	2 1/4	4 1/2	1 21/32	2 1/32	1 1/4	.343	43.10	40.10

SPROCKETS

Single-Taper Bushed with Hardened Teeth

No. Teeth	Catalog Number
12	50BTB12H
13	50BTB13H
14	50BTB14H
15	50BTB15H
16	50BTB16H
17	50BTB17H
18	50BTB18H
19	50BTB19H
20	50BTB20H
21	50BTB21H
22	50BTB22H
23	50BTB23H
24	50BTB24H
25	50BTB25H
26	50BTB26H
27	50BTB27H
28	50BTB28H
30	50BTB30H

**SABER
TOOTH®**

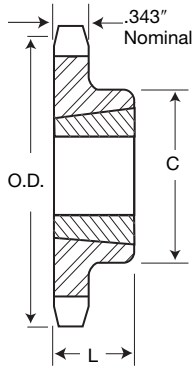

TYPE B

SPROCKETS

Single-Taper Bushed

No. Teeth	Catalog Number	Bushing	Diameter		Max. Bore	Dimensions		Type	Weight (Approx.)	
			Outside Diameter	Pitch Diameter		L	C		Rim Only	Bushing Only
12	50BTB12	1008	2.708	2.415	1	7/8	1 1/16*	B	.5	.3
13	50BTB13	1008	2.911	2.612	1	7/8	1 1/16	B	.5	.3
14	50BTB14	1008	3.113	2.809	1	7/8	1 1/16	B	.6	.3
15	50BTB15	1210	3.315	3.006	1 1/4	1	2 3/32*	B	.7	.6
16	50BTB16	1610	3.517	3.204	1 1/2	1	2 5/32*	B	.7	.9
17	50BTB17	1610	3.719	3.401	1 1/2	1	2 5/32*	B	.8	.9
18	50BTB18	1610	3.920	3.599	1 1/2	1	2 5/32	B	.9	.9
19	50BTB19	1610	4.120	3.797	1 1/2	1	3	B	1.3	.9
20	50BTB20	1610	4.321	3.995	1 1/2	1	3 1/4	B	1.6	.9
21	50BTB21	1610	4.522	4.193	1 1/2	1	3 1/2	B	1.5	.9
22	50BTB22	1610	4.722	4.392	1 1/2	1	3 1/2	B	1.6	.9
23	50BTB23	2012	4.922	4.590	2	1 1/4	3 1/4	B	2.0	1.7
24	50BTB24	2012	5.122	4.788	2	1 1/4	4	B	2.2	1.7
25	50BTB25	2012	5.322	4.987	2	1 1/4	4	B	2.4	1.7
26	50BTB26	2012	5.522	5.185	2	1 1/4	4	B	2.5	1.7
27	50BTB27	2012	5.723	5.384	2	1 1/4	4	B	2.6	1.7
28	50BTB28	2012	5.922	5.582	2	1 1/4	4	B	2.8	1.7
30	50BTB30	2012	6.321	5.979	2	1 1/4	3 3/8	B	3.2	1.7
32	50BTB32	2012	6.721	6.376	2	1 1/4	3 3/8	B	3.6	1.7
35	50BTB35	2012	7.319	6.972	2	1 1/4	3 3/8	B	4.2	1.7
36	50BTB36	2012	7.519	7.171	2	1 1/4	3 3/8	B	4.3	1.7
40	50BTB40	2012	8.316	7.966	2	1 1/4	3 3/8	B	5.2	1.7
42	50BTB42	2012	8.715	8.363	2	1 1/4	3 3/8	B	5.9	1.7
45	50BTB45	2012	9.313	8.960	2	1 1/4	3 3/8	B	6.5	1.7
48	50BTB48	2012	9.911	9.556	2	1 1/4	3 3/8	B	7.3	1.7
54	50BTB54	2012	11.106	10.749	2	1 1/4	3 3/8	B	9.0	1.7
60	50BTB60	2012	12.301	11.942	2	1 1/4	3 3/8	B	10.8	1.7
70	50BTB70	2517	14.292	13.931	2 1/2	1 1/4	4 1/4	B	14.0	3.5
72	50BTB72	2517	14.690	14.329	2 1/2	1 1/4	4 1/4	B	15.5	3.5
80	50BTB80	2517	16.282	15.920	2 1/2	1 1/4	4 1/4	B	19.5	3.5
84	50BTB84	2517	17.079	16.715	2 1/2	1 1/4	4 1/4	B	22.5	3.5
96	50BTB96	2517	19.466	19.102	2 1/2	1 1/4	4 1/4	B	29.0	3.5
112	50BTB112	2517	22.651	22.285	2 1/2	1 1/4	4 1/4	B	38.7	3.5

* Has recessed groove in hub for chain clearance.

No. 50

5/8" Pitch

MST[®]

Sprockets

Martin

Single - MST[®] Sprockets

No. Teeth	Catalog Number	Bush-ing	Diameters		Type	Max. Bore	Dimensions						Weight (Approx.)	
			Outside Dia.	Pitch Dia.			OL	L	C	H	P	T(nom)	With Hub	Rim Only
13	50H13H	H	2.910	2.612	3	1 1/2	1 21/32	1 1/4	7/32	2 1/2	1 1/8	.343	1.4	.6
14	50H14H	H	3.110	2.809	3	1 1/2	1 19/32	1 1/4	5/32	2 1/2	1 1/16	.343	1.4	.6
15	50H15H	H	3.320	3.006	3	1 1/2	1 1/2	1 1/4	1/16	2 1/2	31/32	.343	1.6	.8
15	50P15H	P1	3.320	3.006	4	1 3/4	2 3/16	1 15/16	0	3	1 19/32	.343	2.4	1.1
16	50H16H	H	3.520	3.204	3	1 1/2	1 1/2	1 1/4	1/16	2 1/2	31/32	.343	1.7	.9
16	50P16H	P1	3.520	3.204	4	1 3/4	2 3/16	1 15/16	0	3	1 19/32	.343	2.7	1.4
17	50H17H	H	3.720	3.401	3	1 1/2	1 1/2	1 1/4	1/16	2 1/2	31/32	.343	1.8	1.0
17	50P17H	P1	3.720	3.401	4	1 3/4	2 3/16	1 15/16	0	3	1 19/32	.343	2.7	1.4
18	50H18H	H	3.920	3.599	3	1 1/2	1 1/2	1 1/4	1/16	2 1/2	31/32	.343	1.9	1.1
18	50P18H	P1	3.920	3.599	4	1 3/4	2 3/16	1 15/16	0	3	1 19/32	.343	3.1	1.8
19	50H19H	H	4.120	3.797	3	1 1/2	1 1/2	1 1/4	1/16	2 1/2	31/32	.343	2.1	1.3
19	50P19H	P1	4.120	3.797	4	1 3/4	2 3/16	1 15/16	0	3	1 19/32	.343	3.1	1.8
20	50H20H	H	4.320	3.995	3	1 1/2	1 1/2	1 1/4	1/16	2 1/2	31/32	.343	2.3	1.5
20	50P20H	P1	4.320	3.995	4	1 3/4	2 3/16	1 15/16	0	3	1 19/32	.343	3.3	2.0
21	50H21H	H	4.520	4.194	3	1 1/2	1 1/2	1 1/4	1/16	2 1/2	31/32	.343	2.2	1.4
21	50P21H	P1	4.520	4.194	4	1 3/4	2 3/16	1 15/16	0	3	1 19/32	.343	3.4	2.1
22	50H22H	H	4.720	4.392	3	1 1/2	1 1/2	1 1/4	1/16	2 1/2	31/32	.343	2.3	1.5
22	50P22H	P1	4.720	4.392	4	1 3/4	2 3/16	1 15/16	0	3	1 19/32	.343	3.5	2.2
23	50H23H	H	4.920	4.590	3	1 1/2	1 1/2	1 1/4	1/16	2 1/2	31/32	.343	2.5	1.7
23	50P23H	P1	4.920	4.590	4	1 3/4	2 3/16	1 15/16	0	3	1 19/32	.343	3.7	2.4
23	50Q23H	Q1	4.920	4.590	4	2 11/16	2 25/32	2 1/2	0	4 1/8	2 5/32	.343	6.7	3.2
24	50H24H	H	5.120	4.788	3	1 1/2	1 1/2	1 1/4	1/16	2 1/2	31/32	.343	2.6	1.8
24	50P24H	P1	5.120	4.788	4	1 3/4	2 3/16	1 15/16	0	3	1 19/32	.343	3.9	2.6
24	50Q24H	Q1	5.120	4.788	4	2 11/16	2 25/32	2 1/2	0	4 1/8	2 5/32	.343	7.0	3.5
25	50H25H	H	5.320	4.987	3	1 1/2	1 1/2	1 1/4	1/16	2 1/2	31/32	.343	2.7	1.9
25	50P25H	P1	5.320	4.987	4	1 3/4	2 3/16	1 15/16	0	3	1 19/32	.343	4.0	2.7
25	50Q25H	Q1	5.320	4.987	4	2 11/16	2 25/32	2 1/2	0	4 1/8	2 5/32	.343	7.1	3.6
26	50H26H	H	5.520	5.185	3	1 1/2	1 1/2	1 1/4	1/16	2 1/2	31/32	.343	2.8	2.0
26	50P26H	P1	5.520	5.185	4	1 3/4	2 3/16	1 15/16	0	3	1 19/32	.343	4.1	2.8
26	50Q26H	Q1	5.520	5.185	4	2 11/16	2 25/32	2 1/2	0	4 1/8	2 5/32	.343	7.2	3.7
27	50H27H	H	5.720	5.384	3	1 1/2	1 1/2	1 1/4	1/16	2 1/2	31/32	.343	3.0	2.2
27	50P27H	P1	5.720	5.384	4	1 3/4	2 3/16	1 15/16	0	3	1 19/32	.343	4.2	2.9
27	50Q27H	Q1	5.720	5.384	4	2 11/16	2 25/32	2 1/2	0	4 1/8	2 5/32	.343	7.3	3.8
28	50H28H	H	5.920	5.582	3	1 1/2	1 1/2	1 1/4	1/16	2 1/2	31/32	.343	3.3	2.5
28	50P28H	P1	5.920	5.582	4	1 3/4	2 3/16	1 15/16	0	3	1 19/32	.343	4.3	3.0
28	50Q28H	Q1	5.920	5.582	4	2 11/16	2 25/32	2 1/2	0	4 1/8	2 5/32	.343	7.5	4.0
29	50P29H	P1	6.120	5.781	4	1 3/4	2 3/16	1 15/16	0	3	1 19/32	.343	4.7	3.4
30	50H30H	H	6.320	5.979	3	1 1/2	1 1/2	1 1/4	1/16	2 1/2	31/32	.343	3.7	2.9
30	50P30H	P1	6.320	5.979	4	1 3/4	2 3/16	1 15/16	0	3	1 19/32	.343	4.9	3.6
30	50Q30H	Q1	6.320	5.979	4	2 11/16	2 25/32	2 1/2	0	4 1/8	2 5/32	.343	9.1	5.6
31	50P31	P1	6.520	6.178	4	1 3/4	2 3/16	1 15/16	0	3	1 19/32	.343	4.9	3.6
32	50H32H	H	6.720	6.376	3	1 1/2	1 1/2	1 1/4	1/16	2 1/2	31/32	.343	4.0	3.2
32	50P32	P1	6.720	6.376	4	1 3/4	2 3/16	1 15/16	0	3	1 19/32	.343	5.2	3.9
32	50Q32	Q1	6.720	6.376	4	2 11/16	2 25/32	2 1/2	0	4 1/8	2 5/32	.343	9.6	6.1
33	50H33H	H	6.920	6.575	3	1 1/2	1 1/2	1 1/4	1/16	2 1/2	31/32	.343	4.2	3.4
33	50P33	P1	6.920	6.575	4	1 3/4	2 3/16	1 15/16	0	3	1 19/32	.343	5.4	4.1
34	50H34H	H	7.120	6.774	3	1 1/2	1 1/2	1 1/4	1/16	2 1/2	31/32	.343	4.5	3.7
34	50P34	P1	7.120	6.774	4	1 3/4	2 3/16	1 15/16	0	3	1 19/32	.343	5.6	4.3
35	50H35H	H	7.320	6.972	3	1 1/2	1 1/2	1 1/4	1/16	2 1/2	31/32	.343	4.6	3.8
35	50P35	P1	7.320	6.972	4	1 3/4	2 3/16	1 15/16	0	3	1 19/32	.343	5.6	4.3
35	50Q35	Q1	7.320	6.972	4	2 11/16	2 25/32	2 1/2	0	4 1/8	2 5/32	.343	10.3	6.8
36	50H36H	H	7.520	7.171	3	1 1/2	1 1/2	1 1/4	1/16	2 1/2	31/32	.343	4.8	4.0
36	50P36	P1	7.520	7.171	4	1 3/4	2 3/16	1 15/16	0	3	1 19/32	.343	6.1	4.8
36	50Q36	Q1	7.520	7.171	4	2 11/16	2 25/32	2 1/2	0	4 1/8	2 5/32	.343	10.3	6.8
37	50Q37	Q1	7.720	7.370	4	2 11/16	2 25/32	2 1/2	0	4 1/8	2 5/32	.343	10.5	7.0
38	50H38H	H	7.920	7.569	3	1 1/2	1 1/2	1 1/4	1/16	2 1/2	31/32	.343	5.2	4.4
38	50Q38	Q1	7.920	7.569	4	2 11/16	2 25/32	2 1/2	0	4 1/8	2 5/32	.343	10.9	7.4
39	50Q39	Q1	8.120	7.767	4	2 11/16	2 25/32	2 1/2	0	4 1/8	2 5/32	.343	11.1	7.6
40	50H40H	H	8.320	7.966	3	1 1/2	1 1/2	1 1/4	1/16	2 1/2	31/32	.343	5.6	4.8
40	50Q40	Q1	8.320	7.966	4	2 11/16	2 25/32	2 1/2	0	4 1/8	2 5/32	.343	11.5	8.0
41	50Q41	Q1	8.520	8.165	4	2 11/16	2 25/32	2 1/2	0	4 1/8	2 5/32	.343	11.7	8.2
42	50Q42	Q1	8.720	8.363	4	2 11/16	2 25/32	2 1/2	0	4 1/8	2 5/32	.343	11.8	8.3
44	50Q44	Q1	9.110	8.761	4	2 11/16	2 25/32	2 1/2	0	4 1/8	2 5/32	.343	12.1	8.6
45	50Q45	Q1	9.310	8.960	4	2 11/16	2 25/32	2 1/2	0	4 1/8	2 5/32	.343	12.5	9.0
47	50Q47	Q1	9.710	9.357	4	2 11/16	2 25/32	2 1/2	0	4 1/8	2 5/32	.343	12.8	9.3
48	50Q48	Q1	9.910	9.556	4	2 11/16	2 25/32	2 1/2	0	4 1/8	2 5/32	.343	13.1	9.6
50	50Q50	Q1	10.310	9.954	4	2 11/16	2 25/32	2 1/2	0	4 1/8	2 5/32	.343	13.3	9.8
54	50Q54	Q1	11.110	10.749	4	2 11/16	2 25/32	2 1/2	0	4 1/8	2 5/32	.343	14.8	11.3
56	50Q56	Q1	11.500	11.147	4	2 11/16	2 25/32	2 1/2	0	4 1/8	2 5/32	.343	15.8	12.3
60	50Q60	Q1	12.300	11.942	4	2 11/16	2 25/32	2 1/2	0	4 1/8	2 5/32	.343	16.8	13.3
70	50Q70	Q1	14.290	13.931	4	2 11/16	2 25/32	2 1/2	0	4 1/8	2 5/32	.343	20.4	16.9
72	50Q72	Q1	14.690	14.329	4	2 11/16	2 25/32	2 1/2	0	4 1/8	2 5/32	.343	21.6	18.1
80	50Q80	Q1	16.280	15.920	4	2 11/16	2 25/32	2 1/2	0	4 1/8	2 5/32	.343	24.6	21.1
84	50Q84	Q1	17.080	16.715	4	2 11/16	2 25/32	2 1/2	0	4 1/8	2 5/32	.343	27.8	24.3
96	50Q96	Q1	19.470	19.102	4	2 11/16	2 25/32	2 1/2	0	4 1/8	2 5/32	.343	33.3	29.8
112	50Q112	Q1	22.650	22.285	4	2 11/16	2 25/32	2 1/2	0	4 1/8	2 5/32	.343	42.8	39.3

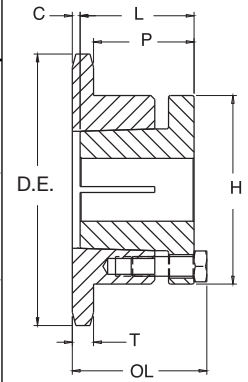

TIPO 3

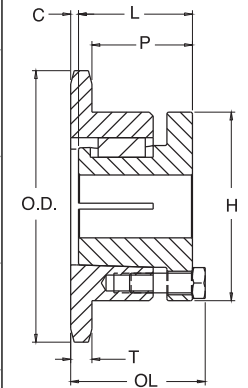

TYPE 4

SPROCKETS

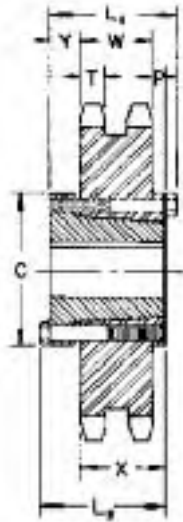

QD — TYPE C

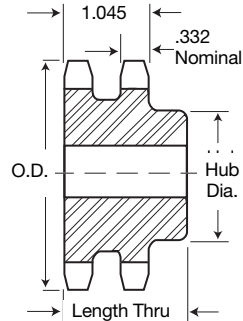

TYPE B

Alteration Charges

See current discount sheet for alteration charges.

Double-Type B

No. Teeth	Catalog Number	Outside Diameter	Type	Bore (inches)		Hub (inches)		Weight Lbs. (Approx.)
				Stock	Rec. Max.	Dia.	Length Thru	
11	D50B11H	2.500	B	5/8	1 1/8	1 1/2	1 1/4	.96
12	D50B12H	2.710	B	5/8	1 1/8	1 1/2	1 1/4	1.25
13	D50B13H	2.910	B	5/8	1 1/8	1 1/2	1 1/4	1.56
14	D50B14H	3.110	B	5/8	1 1/8	2 1/8	1 1/4	1.86
15	D50B15H	3.320	B	3/4	1 1/2	2 1/8	1 1/4	2.22
16	D50B16H	3.520	B	3/4	1 1/2	2 1/2	1 1/4	2.62
17	D50B17H	3.720	B	3/4	1 1/2	2 1/8	1 1/4	3.04
18	D50B18H	3.920	B	3/4	1 1/2	2 1/8	1 1/4	3.58
19	D50B19H	4.120	B	1	2 1/8	3 1/8	1 1/4	3.90
20	D50B20H	4.320	B	1	2 1/8	3 1/8	1 1/4	4.26
21	D50B21H	4.520	B	1	2 1/8	3 1/2	1 1/4	4.90
22	D50B22H	4.720	B	1	2 1/8	3 3/8	1 1/4	5.58
23	D50B23H	4.920	B	1	2 1/2	3 3/8	1 1/4	6.10
24	D50B24H	5.120	B	1	2 1/2	3 3/8	1 1/4	6.50
25	D50B25H	5.320	B	1	2 1/2	3 3/8	1 1/4	6.94
26	D50B26	5.520	B	1	2 1/2	3 3/8	1 1/4	7.54
30	D50B30	6.320	B	1	2 1/2	3 3/8	1 1/4	9.40
32	D50B32	6.720	B	1	2 1/2	3 3/8	1 1/4	10.46
35	D50B35	7.320	B	1	2 1/2	3 3/8	1 1/4	12.28
36	D50B36	7.520	B	1 1/8	2 3/4	4	2 1/4	13.94
40	D50B40	8.320	B	1 1/8	2 3/4	4	2 1/4	16.54
42	D50B42	8.720	B	1 1/8	2 3/4	4	2 1/4	17.92
45	D50B45	9.310	B	1 1/8	2 3/4	4	2 1/4	20.30
48	D50B48	9.910	B	1 1/8	2 3/4	4 1/4	2 1/4	24.08
52	D50B52	10.710	B	1 1/8	2 3/4	4 1/4	2 1/4	27.42
54	D50B54	11.110	B	1 1/8	2 3/4	4 1/4	2 1/4	29.16
60	D50B60	12.300	B	1 1/8	3	4 1/4	2 1/4	35.88
68	D50B68	13.890	B	1 1/8	3	4 1/4	2 1/4	44.98
72	D50B72	14.690	B	1 1/8	3	4 1/4	2 1/4	50.22
76	D50B76	15.490	B	1 1/8	3	4 1/4	2 1/4	45.64
84	D50B84	17.080	B	1 1/8	3	4 1/4	2 1/4	51.64
95	D50B95	19.270	B	1 1/8	3	4 1/4	2 1/4	64.32
96	D50B96	19.470	B	1 1/8	3	4 1/4	2 1/4	67.42
102	D50B102	20.660	B	1 1/8	3	4 1/4	2 1/4	72.68
112	D50B112	22.650	B	1 1/8	3 1/4	5 1/4	2 1/4	90.22

Maximum bores shown will accommodate standard keyseat and setscrew over keyseat. Slightly larger bores are possible with no keyseat, shallow keyseat, or setscrew at angle to keyseat.

NOTE: Double 50 stock sprockets with 25 teeth or less have hardened teeth. As indicated by H suffix.

Double-Type QD

No. Teeth	Catalog Number	Bush-ing	Diameters		Type	Max. Bore	Dimensions							Weight (Approx.)		
			Outside Diameter	Pitch Diameter			L ₁	L ₂	C	Y	P	X	T	W	With Hub	Rim Only
36	D50SK36	SK	7.520	7.171	C	2 1/8	2 1/8	2 1/8	3 3/8	5/8	1 1/4	1 1/4	.332	1.045	11.08	9.08
42	D50SK42	SK	8.720	8.363	C	2 1/8	2 1/8	2 1/8	3 3/8	5/8	1 1/4	1 1/4	.332	1.045	15.16	13.16
48	D50SK48	SK	9.910	9.556	C	2 1/8	2 1/8	2 1/8	3 3/8	5/8	1 1/4	1 1/4	.332	1.045	19.90	17.90
52	D50SF52	SF	10.710	10.351	C	2 1/8	2 1/4	2 1/4	4 1/8	3/4	1 1/4	1 1/4	.332	1.045	24.26	21.26
54	D50SF54	SF	11.110	10.749	C										26.18	23.18
60	D50SF60	SF	12.300	11.942	C										32.12	29.12
68	D50SF68	SF	13.890	13.533	C										41.16	38.16
72	D50SF72	SF	14.690	14.329	C										46.28	43.26
76	D50SF76	SF	15.490	15.124	C										47.00	44.00
84	D50SF84	SF	17.080	16.715	C										48.89	45.88
95	D50SF95	SF	19.270	18.903	C										61.80	58.88
102	D50SF102	SF	20.660	20.295	C										69.02	66.02
112	D50SF112	SF	22.650	22.285	C	2 1/8	2 1/4	2 1/4	4 1/8	3/4	1 1/4	1 1/4	.332	1.045	88.26	85.26

No. 50-2

5/8" Pitch

All Steel Stock Sprockets

Martin

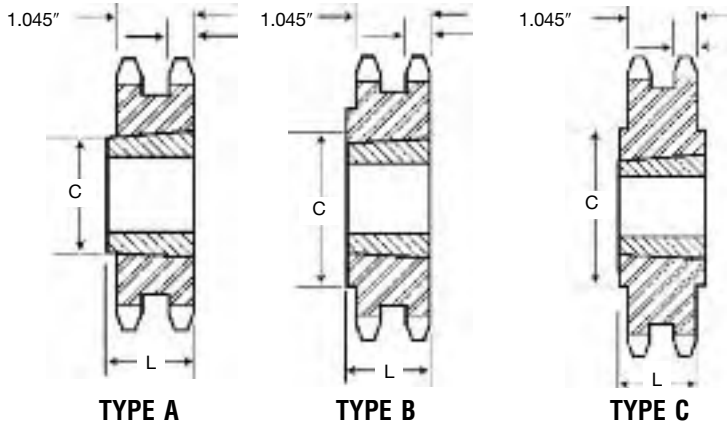

SPROCKETS

Double-Taper Bushed

No. Teeth	Catalog Number	Bushing	Diameter		Max. Bore	Dimensions		Type	Weight (Approx.)	
			Outside Diameter	Pitch Diameter		L	C		Rim Only	Bushing Only
14	D50ATB14H	1008	3.113	2.809	1	3/4		A	.8	.3
15	D50ATB15H	1210	3.315	3.006	1 1/4	1		A	.9	.6
16	D50ATB16H	1210	3.517	3.204	1 1/4	1		A	1.1	.6
17	D50ATB17H	1610	3.719	3.410	1 3/8	1		A	1.1	.6
18	D50ATB18H	1610	3.920	3.599	1 3/8	1		A	1.3	.9
19	D50ATB19H	1610	4.120	3.797	1 3/8	1		A	1.6	.9
20	D50BTB20H	2012	4.321	3.995	2	1 1/4	3/4	B	1.5	1.7
21	D50BTB21H	2012	4.522	4.193	2	1 1/4	3/4	B	1.9	1.7
25	D50BTB25H	2012	5.322	4.987	2	1 1/4	4 1/2	B	3.8	1.7
30	D50BTB30	2517	6.321	5.979	2 1/2	1 1/4	5 1/2	B	7.5	3.5
36	D50CTB36	2517	7.519	7.171	2 1/2	1 1/4	4 1/4	C	9.4	3.5
42	D50CTB42	2517	8.715	8.363	2 1/2	1 1/4	4 1/4	C	13.4	3.5
48	D50CTB48	2517	9.911	9.556	2 1/2	1 1/4	4 1/4	C	18.6	3.5
52	D50CTB52	2517	10.707	10.351	2 1/2	1 1/4	4 1/4	C	22.2	3.5
60	D50CTB60	2517	12.301	11.942	2 1/2	1 1/4	4 1/4	C	30.3	3.5
68	D50CTB68	2517	13.893	13.533	2 1/2	1 1/4	4 1/4	C	39.4	3.5
76	D50CTB76	2517	15.486	15.124	2 1/2	1 1/4	4 1/4	C	41.2	3.5
84	D50CTB84	2517	17.079	16.715	2 1/2	1 1/4	4 1/4	C	45.3	3.5
95	D50CTB95	2517	19.267	18.903	2 1/2	1 1/4	4 1/4	C	58.8	3.5
102	D50CTB102	2517	20.661	20.295	2 1/2	1 1/4	4 1/4	C	67.1	3.5

NOTE: Double 50 stock sprockets with 25 teeth or less have hardened teeth. As indicated by H suffix.

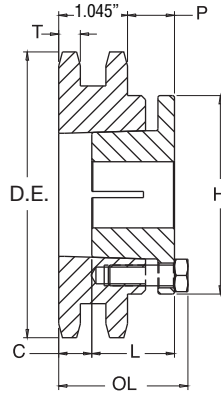

TIPO 11

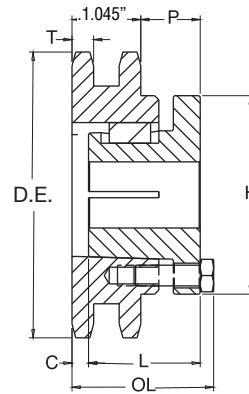

TIPO 12

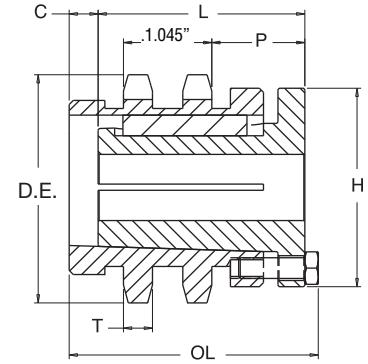

TIPO 16

Double - MST[®] Sprockets

No. Teeth	Catalog Number	Bush-ing	Diameters		Type	Max. Bore	Dimensions						Weight (Approx.)	
			Outside Dia.	Pitch Dia.			OL	L	C	H	P	T(nom)	With Hub	Rim Only
14	D50H14H	H	3.110	2.809	11	1-1/2	2 5/16	1-1/4	7/8	2-1/2	1-3/32	.332	2.0	1.2
15	D50P15H	P1	3.320	3.006	16	1-3/4	3 7/16	1-15/16	1-1/4	3	1-13/32	.332	3.3	2.0
16	D50P16H	P1	3.520	3.204	12	1-3/4	2-11/16	1-15/16	1/2	3	1-13/32	.332	2.9	1.6
17	D50P17H	P1	3.720	3.401	12	1-3/4	2-11/16	1-15/16	1/2	3	1-13/32	.332	3.4	2.1
18	D50P18H	P1	3.920	3.599	12	1-3/4	2-11/16	1-15/16	1/2	3	1-13/32	.332	3.8	2.5
19	D50P19H	P1	4.120	3.797	12	1-3/4	2-3/16	1-15/16	0	3	29/32	.332	3.3	2.0
20	D50P20H	P1	4.320	3.995	12	1-3/4	2-3/16	1-15/16	0	3	29/32	.332	3.8	2.5
21	D50P21H	P1	4.520	4.194	12	1-3/4	2-3/16	1-15/16	0	3	29/32	.332	4.1	2.8
22	D50P22H	P1	4.720	4.392	12	1-3/4	2-3/16	1-15/16	0	3	29/32	.332	4.5	3.2
23	D50P23H	P1	4.920	4.590	12	1-3/4	2-3/16	1-15/16	0	3	29/32	.332	4.9	3.6
24	D50Q24H	Q1	5.120	4.788	12	2-11/16	2-25/32	2-1/2	0	4-1/8	1-15/32	.332	7.5	4.0
25	D50Q25H	Q1	5.320	4.987	12	2-11/16	2-25/32	2-1/2	0	4-1/8	1-15/32	.332	8.0	4.5
26	D50Q26H	Q1	5.520	5.185	12	2-11/16	2-25/32	2-1/2	0	4-1/8	1-15/32	.332	8.8	5.3
27	D50Q27H	Q1	5.720	5.384	12	2-11/16	2-25/32	2-1/2	0	4-1/8	1-15/32	.332	9.4	5.9
28	D50Q28H	Q1	5.920	5.582	12	2-11/16	2-25/32	2-1/2	0	4-1/8	1-15/32	.332	9.8	6.3
30	D50Q30H	Q1	6.320	5.979	12	2-11/16	2-25/32	2-1/2	0	4-1/8	1-15/32	.332	11.0	7.5
32	D50Q32H	Q1	6.720	6.376	12	2-11/16	2-25/32	2-1/2	0	4-1/8	1-15/32	.332	12.0	8.5
35	D50Q35H	Q1	7.320	6.972	12	2-11/16	2-25/32	2-1/2	0	4-1/8	1-15/32	.332	13.9	10.4
36	D50Q36H	Q1	7.520	7.171	12	2-11/16	2-25/32	2-1/2	0	4-1/8	1-15/32	.332	14.5	11.0
40	D50Q40H	Q1	8.320	7.966	12	2-11/16	2-25/32	2-1/2	0	4-1/8	1-15/32	.332	17.1	13.6
42	D50Q42H	Q1	8.720	8.363	12	2-11/16	2-25/32	2-1/2	0	4-1/8	1-15/32	.332	18.5	15.0
45	D50Q45H	Q1	9.310	8.960	12	2-11/16	2-25/32	2-1/2	0	4-1/8	1-15/32	.332	21.0	17.5
48	D50Q48H	Q1	9.910	9.556	12	2-11/16	2-25/32	2-1/2	0	4-1/8	1-15/32	.332	23.9	20.4
52	D50Q52	Q1	10.710	10.351	12	2-11/16	2-25/32	2-1/2	0	4-1/8	1-15/32	.332	26.8	23.3
54	D50Q54	Q1	11.110	10.749	12	2-11/16	2-25/32	2-1/2	0	4-1/8	1-15/32	.332	26.8	23.3
60	D50Q60	Q1	12.300	11.942	12	2-11/16	2-25/32	2-1/2	0	4-1/8	1-15/32	.332	29.0	25.5
72	D50Q72	Q1	14.690	14.329	12	2-11/16	2-25/32	2-1/2	0	4-1/8	1-15/32	.332	46.6	43.1
76	D50Q76	Q1	15.490	15.124	12	2-11/16	2-25/32	2-1/2	0	4-1/8	1-15/32	.332	49.5	46.0
84	D50Q84	Q1	17.080	16.715	12	2-11/16	2-25/32	2-1/2	0	4-1/8	1-15/32	.332	60.2	56.7
95	D50R95	R1	19.270	18.903	12	3-3/4	3-5/32	2-7/8	0	5-3/8	2-3/32	.332	79.8	72.3
96	D50R96	R1	19.470	19.102	12	3-3/4	3-5/32	2-7/8	0	5-3/8	2-3/32	.332	88.2	80.7
102	D50R102	R1	20.660	20.295	12	3-3/4	3-5/32	2-7/8	0	5-3/8	2-3/32	.332	92.0	84.5
112	D50R112	R1	22.650	22.285	12	3-3/4	3-5/32	2-7/8	0	5-3/8	2-3/32	.332	100.7	93.2

Sprockets with "H" suffix have hardened teeth.

No. 50-3

5/8" Pitch

All Steel Stock Sprockets



Triple-Type B & C

No. Teeth	Catalog Number	Outside Diameter	Type	Bore (inches)		Hub (inches)		Weight Lbs. (Approx.)
				Stock	Rec. Max.	Dia.	Length Thru	
11	E50B11H	2.500	B	5/8	1 1/8	1 1/2	2 1/2	1.42
12	E50B12H	2.710	B	5/8	1 1/8	1 1/2	2 1/2	1.84
13	E50B13H	2.910	B	5/8	1 1/8	1 1/2	2 1/2	2.28
14	E50B14H	3.110	B	5/8	1 1/8	2 1/8	2 1/2	2.72
15	E50B15H	3.320	B	5/8	1 1/8	2 1/8	2 1/2	3.24
16	E50B16H	3.520	B	5/8	1 1/8	2 1/8	2 1/2	3.76
17	E50B17H	3.720	B	5/8	1 1/8	2 1/8	2 1/2	4.38
18	E50B18H	3.920	B	5/8	1 1/8	2 1/8	2 1/2	5.10
19	E50B19H	4.120	B	1	2 1/4	3 1/4	2 1/2	5.60
20	E50B20H	4.320	B	1	2 1/4	3 1/4	2 1/2	6.42
21	E50B21H	4.520	B	1	2 1/4	3 1/4	2 1/2	7.42
22	E50B22H	4.720	B	1	2 1/4	3 1/4	2 1/2	7.92
23	E50B23H	4.920	B	1	2 1/2	3 3/4	2 1/2	8.80
24	E50B24H	5.120	B	1	2 1/2	3 3/4	2 1/2	9.42
25	E50B25H	5.320	B	1	2 1/2	3 3/4	2 1/2	10.16
26	E50B26	5.520	B	1	2 1/2	3 3/4	2 1/2	11.02
30	E50B30	6.320	B	1	2 1/2	3 3/4	2 1/2	14.24
35	E50B35	7.320	B	1	2 1/2	3 3/4	2 1/2	18.96
36	E50B36	7.520	B	1 1/8	2 3/4	4	2 1/2	20.60
42	E50B42	8.720	B	1 1/8	2 3/4	4	2 1/2	27.46
48	E50B48	9.910	B	1 1/8	2 3/4	4	3 1/8	36.64
52	E50B52	10.710	B	1 1/8	2 3/4	4	3 1/8	42.54
60	E50B60	12.300	B	1 1/8	3	4 1/2	3 1/8	56.84
68	E50B68	13.890	B	1 1/8	3	4 1/2	3 1/8	73.21
72	E50C72	14.690	C	1 1/8	3	4 1/2	3 1/2	54.40
76	E50C76	15.490	C	1 1/8	3	4 1/2	3 1/2	51.20
84	E50C84	17.080	C	1 1/8	3	4 1/2	3 1/2	65.32
95	E50C95	19.270	C	1 1/8	3	4 1/2	3 1/2	74.42
102	E50C102	20.660	C	1 1/8	3	4 1/2	3 1/2	79.94

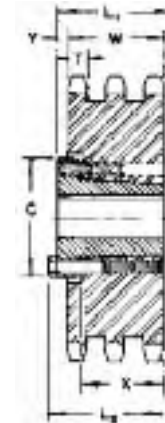
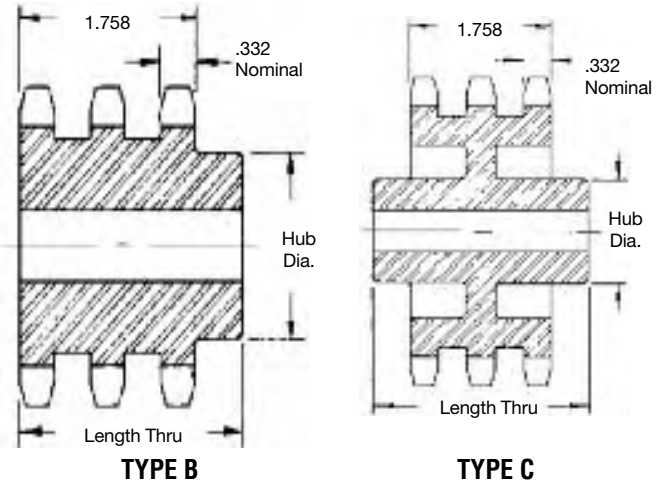

QD — TYPE B

NOTE: Triple 50 stock sprockets with 25 teeth or less have hardened teeth.

Maximum bores shown will accommodate standard keyseat and setscrew over keyseat. Slightly larger bores are possible with no keyseat, shallow keyseat, or setscrew at angle to keyseat.

NOTE: Triple 50 stock sprockets with 25 teeth or less have Hardened Teeth. As indicated by H suffix.

Alteration Charges

See current discount sheet for alteration charges.

Triple-Type QD

No. Teeth	Catalog Number	Bushing	Diameters		Type	Max. Bore	Dimensions							Weight (Approx.)		
			Outside Diameter	Pitch Diameter			L ₁	L ₂	C	Y	V	X	T	W	With Hub	Rim Only
36	E50SK36	SK	7.520	7.171	B	2 1/2	2 1/2	2 1/2	3 3/4	1/2		1 1/4	.332	1.758	14.8	12.8
42	E50SK42	SK	8.720	8.363	B	2 1/2	2 1/2	2 1/2	3 3/4	1/2		1 1/4	.332	1.758	21.5	19.5
48	E50SK48	SK	9.910	9.556	B	2 1/2	2 1/2	2 1/2	3 3/4	1/2		1 1/4	.332	1.758	29.6	27.6
52	E50SF52	SF	10.710	10.351	B	2 1/2	2 1/2	2 1/2	4	1/2		1 1/4	.332	1.758	31.6	28.6
60	E50SF60	SF	12.300	11.942	B										42.1	39.1
68	E50SF68	SF	13.890	13.533	B										53.8	50.8
72	E50SF72	SF	14.690	14.329	B										46.6	43.6
76	E50SF76	SF	15.490	15.124	B					1/2					49.9	46.9
84	E50SF84	SF	17.080	16.715	B										53.9	50.9
95	E50SF95	SF	19.270	18.903	B										62.3	59.3
102	E50SF102	SF	20.660	20.295	B	2 1/2	2 1/2	2 1/2	4	1/2		1 1/4	.332	1.758	69.3	66.3

SPROCKETS

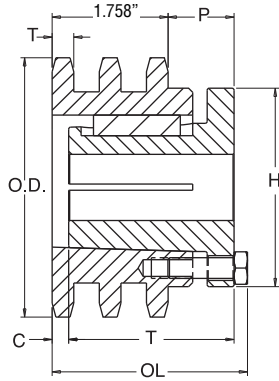

TYPE 22

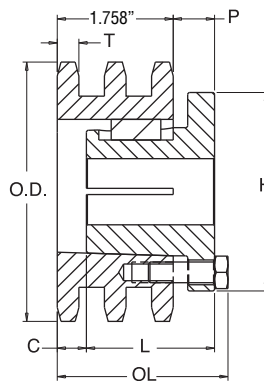

TYPE 23

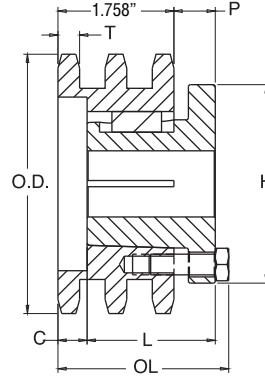

TYPE 24

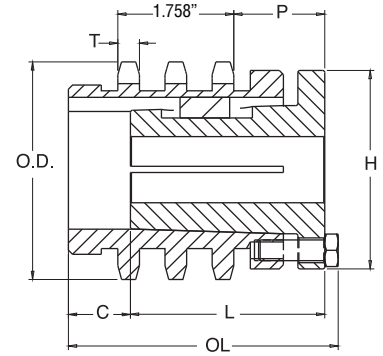

TYPE 27

Triple - MST[®] Sprockets

No. Teeth	Catalog Number	Bush-ing	Diameters		Type	Max. Bore	Dimensions						Weight (Approx.)	
			Outside Dia.	Pitch Dia.			OL	L	C	H	P	T(nom)	With Hub	Rim Only
15	E50P15H	P2	3.320	3.006	27	1-3/4	4-1/8	2-15/16	15/16	3	1-3/8	.332	4.0	2.5
16	E50P16H	P2	3.520	3.204	22	1-3/4	3 3/8	2-15/16	3/16	3	1-3/8	.332	3.9	2.4
17	E50P17H	P2	3.720	3.401	22	1-3/4	3 3/8	2-15/16	3/16	3	1-3/8	.332	4.3	2.8
18	E50P18H	P2	3.920	3.599	22	1-3/4	3 3/8	2-15/16	3/16	3	1-3/8	.332	4.9	3.4
19	E50P19H	P1	4.120	3.797	24	1-3/4	2-5/8	1-15/16	7/16	3	5/8	.332	4.2	2.9
20	E50P20H	P1	4.320	3.995	24	1-3/4	2-5/8	1-15/16	7/16	3	5/8	.332	4.4	3.1
21	E50P21H	P1	4.520	4.194	24	1-3/4	2-5/8	1-15/16	7/16	3	5/8	.332	4.8	3.5
23	E50P23H	P1	4.920	4.590	24	1-3/4	2-5/8	1-15/16	7/16	3	5/8	.332	5.8	4.5
24	E50Q24H	Q1	5.120	4.788	23	2-11/16	2-25/32	2-1/2	0	4-1/8	3/4	.332	8.2	4.7
25	E50Q25H	Q1	5.320	4.987	23	2-11/16	2-25/32	2-1/2	0	4-1/8	3/4	.332	8.5	5.0
26	E50Q26H	Q1	5.520	5.185	23	2-11/16	2-25/32	2-1/2	0	4-1/8	3/4	.332	9.4	5.9
28	E50Q28H	Q1	5.920	5.582	23	2-11/16	2-25/32	2-1/2	0	4-1/8	3/4	.332	10.8	7.3
30	E50Q30H	Q1	6.320	5.979	23	2-11/16	2-25/32	2-1/2	0	4-1/8	3/4	.332	12.3	8.8
32	E50Q32H	Q1	6.720	6.376	23	2-11/16	2-25/32	2-1/2	0	4-1/8	3/4	.332	14.4	10.9
35	E50Q35H	Q1	7.320	6.972	23	2-11/16	2-25/32	2-1/2	0	4-1/8	3/4	.332	17.2	13.7
36	E50Q36H	Q1	7.520	7.171	23	2-11/16	2-25/32	2-1/2	0	4-1/8	3/4	.332	18.1	14.6
40	E50Q40H	Q1	8.320	7.966	23	2-11/16	2-25/32	2-1/2	0	4-1/8	3/4	.332	22.6	19.1
42	E50Q42H	Q1	8.720	8.363	23	2-11/16	2-25/32	2-1/2	0	4-1/8	3/4	.332	25.0	21.5
48	E50Q48H	Q1	9.910	9.556	23	2-11/16	2-25/32	2-1/2	0	4-1/8	3/4	.332	33.1	29.6
52	E50Q52	Q1	10.710	10.351	23	2-11/16	2-25/32	2-1/2	0	4-1/8	3/4	.332	39.9	36.4
60	E50R60	R1	12.300	11.942	22	3-3/4	2-5/32	2-7/8	0	5-3/8	1-1/8	.332	55.5	48.0
68	E50R68	R1	13.890	13.533	22	3-3/4	2-5/32	2-7/8	0	5-3/8	1-1/8	.332	71.0	63.5
72	E50R72	R1	14.690	14.329	22	3-3/4	2-5/32	2-7/8	0	5-3/8	1-1/8	.332	79.5	72.0
76	E50R76	R1	15.490	15.124	22	3-3/4	2-5/32	2-7/8	0	5-3/8	1-1/8	.332	88.5	81.0
84	E50R84	R1	17.080	16.715	22	3-3/4	2-5/32	2-7/8	0	5-3/8	1-1/8	.332	107.5	100.0
95	E50R95	R1	19.270	18.903	22	3-3/4	2-5/32	2-7/8	0	5-3/8	1-1/8	.332	137.5	130.0
102	E50R102	R1	20.660	20.295	22	3-3/4	2-5/32	2-7/8	0	5-3/8	1-1/8	.332	158.5	151.0

Sprockets with "H" suffix have hardened teeth.

No. 60

3/4" Pitch

All Steel Stock Sprockets



Single Type "BS" — 2 Setscrews — Bored-To-Size

No. Teeth	Catalog Number	Outside Diameter	Length Thru Bore	Weight Lbs. (Approx.)	Stock Finished Bores Includes Keyway and Setscrews
9	60BS9	2.510	1 1/4	.6	3/8 - 7/8 - 1
10	60BS10	2.760	1 1/4	.7	3/8 - 7/8 - 1 - 1 1/8 - 1 1/2 - 1 5/8 - 1 7/8
11	60BS11	3.000	1 1/4	.9	3/8 - 7/8 - 1 - 1 1/8 - 1 1/2 - 1 5/8 - 1 7/8
11	60BS11W*	3.000	1 1/4	.8	1 1/4
12	60BS12	3.250	1 1/4	1.3	3/8 - 7/8 - 1 - 1 1/8 - 1 1/2 - 1 5/8 - 1 7/8 - 1 3/4 - 1 5/8
12	60BS12W*	3.250	1 1/4	1.1	1 1/4
13	60BS13	3.490	1 1/4	1.3	3/8 - 7/8 - 1 - 1 1/8 - 1 1/2 - 1 5/8 - 1 7/8 - 1 3/4 - 1 5/8 - 1 7/8
14	60BS14	3.740	1 1/4	1.6	3/8 - 7/8 - 1 - 1 1/8 - 1 1/2 - 1 5/8 - 1 7/8 - 1 3/4 - 1 5/8 - 1 7/8 - 1 3/4
15	60BS15	3.980	1 1/4	1.7	3/8 - 7/8 - 1 - 1 1/8 - 1 1/2 - 1 5/8 - 1 7/8 - 1 3/4 - 1 5/8 - 1 7/8 - 1 3/4 - 1 5/8
16	60BS16	4.220	1 1/4	2.1	3/8 - 7/8 - 1 - 1 1/8 - 1 1/2 - 1 5/8 - 1 7/8 - 1 3/4 - 1 5/8 - 1 7/8 - 1 3/4 - 1 5/8 - 1 7/8
17	60BS17	4.460	1 1/4	2.4	1 - 1 1/8 - 1 1/2 - 1 5/8 - 1 7/8 - 1 3/4 - 1 5/8 - 1 7/8 - 1 3/4 - 1 5/8
18	60BS18	4.700	1 1/4	2.6	1 - 1 1/8 - 1 1/2 - 1 5/8 - 1 7/8 - 1 3/4 - 1 5/8 - 1 7/8 - 1 3/4 - 1 5/8
18	60BS18W*	4.700	1 1/4	2.6	1 1/4
19	60BS19	4.950	1 1/4	3.4	1 - 1 1/8 - 1 1/2 - 1 5/8 - 1 7/8 - 1 3/4 - 1 5/8 - 1 7/8 - 1 3/4 - 1 5/8
20	60BS20	5.190	1 1/4	3.9	1 - 1 1/8 - 1 1/2 - 1 5/8 - 1 7/8 - 1 3/4 - 1 5/8 - 1 7/8 - 1 3/4 - 1 5/8
21	60BS21	5.430	1 1/4	4.4	1 - 1 1/8 - 1 1/2 - 1 5/8 - 1 7/8 - 1 3/4 - 1 5/8 - 1 7/8 - 1 3/4 - 1 5/8
22	60BS22	5.670	1 1/4	4.7	1 - 1 1/8 - 1 1/2 - 1 5/8 - 1 7/8 - 1 3/4 - 1 5/8 - 1 7/8 - 1 3/4 - 1 5/8
23	60BS23	5.910	1 1/4	5.0	1 - 1 1/8 - 1 1/2 - 1 5/8 - 1 7/8 - 1 3/4 - 1 5/8 - 1 7/8 - 1 3/4 - 1 5/8
24	60BS24	6.150	1 1/4	5.3	1 - 1 1/8 - 1 1/2 - 1 5/8 - 1 7/8 - 1 3/4 - 1 5/8 - 1 7/8 - 1 3/4 - 1 5/8
25	60BS25	6.390	1 1/4	5.4	1 - 1 1/8 - 1 1/2 - 1 5/8 - 1 7/8 - 1 3/4 - 1 5/8 - 1 7/8 - 1 3/4 - 1 5/8
26	60BS26	6.630	1 1/4	5.8	1 - 1 1/8 - 1 1/2 - 1 5/8 - 1 7/8 - 1 3/4 - 1 5/8 - 1 7/8 - 1 3/4 - 1 5/8
27	60BS27	6.870	1 1/4	6.3	1 - 1 1/8 - 1 1/2 - 1 5/8 - 1 7/8 - 1 3/4 - 1 5/8 - 1 7/8 - 1 3/4 - 1 5/8
28	60BS28	7.110	1 1/4	6.4	1 - 1 1/8 - 1 1/2 - 1 5/8 - 1 7/8 - 1 3/4 - 1 5/8 - 1 7/8 - 1 3/4 - 1 5/8
29	60BS29	7.350	1 1/4	6.9	1 - 1 1/8 - 1 1/2 - 1 5/8 - 1 7/8 - 1 3/4 - 1 5/8 - 1 7/8 - 1 3/4 - 1 5/8
30	60BS30	7.590	1 1/4	7.1	1 - 1 1/8 - 1 1/2 - 1 5/8 - 1 7/8 - 1 3/4 - 1 5/8 - 1 7/8 - 1 3/4 - 1 5/8
31	60BS31	7.830	1 1/4	7.4	1 - 1 1/8 - 1 1/2 - 1 5/8 - 1 7/8 - 1 3/4 - 1 5/8 - 1 7/8 - 1 3/4 - 1 5/8
32	60BS32	8.070	1 1/4	7.8	1 - 1 1/8 - 1 1/2 - 1 5/8 - 1 7/8 - 1 3/4 - 1 5/8 - 1 7/8 - 1 3/4 - 1 5/8
33	60BS33	8.300	1 1/4	8.2	1 - 1 1/8 - 1 1/2 - 1 5/8 - 1 7/8 - 1 3/4 - 1 5/8 - 1 7/8 - 1 3/4 - 1 5/8
34	60BS34	8.540	1 1/4	8.5	1 - 1 1/8 - 1 1/2 - 1 5/8 - 1 7/8 - 1 3/4 - 1 5/8 - 1 7/8 - 1 3/4 - 1 5/8
35	60BS35	8.780	1 1/4	8.8	1 - 1 1/8 - 1 1/2 - 1 5/8 - 1 7/8 - 1 3/4 - 1 5/8 - 1 7/8 - 1 3/4 - 1 5/8
36	60BS36	9.020	1 1/4	9.2	1 - 1 1/8 - 1 1/2 - 1 5/8 - 1 7/8 - 1 3/4 - 1 5/8 - 1 7/8 - 1 3/4 - 1 5/8 - 2 - 2 1/8 - 2 1/4
37	60BS37	9.260	1 1/4	9.9	1 - 1 1/8 - 1 1/2 - 1 5/8 - 1 7/8 - 1 3/4 - 1 5/8 - 1 7/8 - 1 3/4 - 1 5/8 - 2 - 2 1/8 - 2 1/4
38	60BS38	9.500	1 1/4	10.5	1 - 1 1/8 - 1 1/2 - 1 5/8 - 1 7/8 - 1 3/4 - 1 5/8 - 1 7/8 - 1 3/4 - 1 5/8 - 2 - 2 1/8 - 2 1/4
39	60BS39	9.740	1 1/4	10.9	1 - 1 1/8 - 1 1/2 - 1 5/8 - 1 7/8 - 1 3/4 - 1 5/8 - 1 7/8 - 1 3/4 - 1 5/8 - 2 - 2 1/8 - 2 1/4
40	60BS40	9.980	1 1/4	11.2	1 - 1 1/8 - 1 1/2 - 1 5/8 - 1 7/8 - 1 3/4 - 1 5/8 - 1 7/8 - 1 3/4 - 1 5/8 - 2 - 2 1/8 - 2 1/4
41	60BS41	10.220	1 1/4	11.8	1 - 1 1/8 - 1 1/2 - 1 5/8 - 1 7/8 - 1 3/4 - 1 5/8 - 1 7/8 - 1 3/4 - 1 5/8 - 2 - 2 1/8 - 2 1/4
42	60BS42	10.460	1 1/4	12.4	1 - 1 1/8 - 1 1/2 - 1 5/8 - 1 7/8 - 1 3/4 - 1 5/8 - 1 7/8 - 1 3/4 - 1 5/8 - 2 - 2 1/8 - 2 1/4
43	60BS43	10.700	1 1/4	13.0	1 - 1 1/8 - 1 1/2 - 1 5/8 - 1 7/8 - 1 3/4 - 1 5/8 - 1 7/8 - 1 3/4 - 1 5/8 - 2 - 2 1/8 - 2 1/4
44	60BS44	10.940	1 1/4	13.5	1 - 1 1/8 - 1 1/2 - 1 5/8 - 1 7/8 - 1 3/4 - 1 5/8 - 1 7/8 - 1 3/4 - 1 5/8 - 2 - 2 1/8 - 2 1/4
45	60BS45	11.180	1 1/4	13.8	1 - 1 1/8 - 1 1/2 - 1 5/8 - 1 7/8 - 1 3/4 - 1 5/8 - 1 7/8 - 1 3/4 - 1 5/8 - 2 - 2 1/8 - 2 1/4
46	60BS46	11.420	1 1/4	14.1	1 - 1 1/8 - 1 1/2 - 1 5/8 - 1 7/8 - 1 3/4 - 1 5/8 - 1 7/8 - 1 3/4 - 1 5/8 - 2 - 2 1/8 - 2 1/4
47	60BS47	11.650	1 1/4	14.6	1 - 1 1/8 - 1 1/2 - 1 5/8 - 1 7/8 - 1 3/4 - 1 5/8 - 1 7/8 - 1 3/4 - 1 5/8 - 2 - 2 1/8 - 2 1/4
48	60BS48	11.890	1 1/4	15.4	1 - 1 1/8 - 1 1/2 - 1 5/8 - 1 7/8 - 1 3/4 - 1 5/8 - 1 7/8 - 1 3/4 - 1 5/8 - 2 - 2 1/8 - 2 1/4
49	60BS49	12.130	1 1/4	16.4	1 - 1 1/8 - 1 1/2 - 1 5/8 - 1 7/8 - 1 3/4 - 1 5/8 - 1 7/8 - 1 3/4 - 1 5/8 - 2 - 2 1/8 - 2 1/4
50	60BS50	12.370	1 1/4	17.3	1 - 1 1/8 - 1 1/2 - 1 5/8 - 1 7/8 - 1 3/4 - 1 5/8 - 1 7/8 - 1 3/4 - 1 5/8 - 2 - 2 1/8 - 2 1/4
51	60BS51	12.610	1 1/4	18.3	1 - 1 1/8 - 1 1/2 - 1 5/8 - 1 7/8 - 1 3/4 - 1 5/8 - 1 7/8 - 1 3/4 - 1 5/8 - 2 - 2 1/8 - 2 1/4
52	60BS52	12.850	1 1/4	19.3	1 - 1 1/8 - 1 1/2 - 1 5/8 - 1 7/8 - 1 3/4 - 1 5/8 - 1 7/8 - 1 3/4 - 1 5/8 - 2 - 2 1/8 - 2 1/4
53	60BS53	13.090	1 1/4	20.3	1 - 1 1/8 - 1 1/2 - 1 5/8 - 1 7/8 - 1 3/4 - 1 5/8 - 1 7/8 - 1 3/4 - 1 5/8 - 2 - 2 1/8 - 2 1/4
54	60BS54	13.330	1 1/4	21.0	1 - 1 1/8 - 1 1/2 - 1 5/8 - 1 7/8 - 1 3/4 - 1 5/8 - 1 7/8 - 1 3/4 - 1 5/8 - 2 - 2 1/8 - 2 1/4
55	60BS55	13.570	1 1/4	21.2	1 - 1 1/8 - 1 1/2 - 1 5/8 - 1 7/8 - 1 3/4 - 1 5/8 - 1 7/8 - 1 3/4 - 1 5/8 - 2 - 2 1/8 - 2 1/4
56	60BS56	13.810	1 1/4	21.3	- 1 3/8 - 1 1/2 - 1 5/8 - 1 7/8 - 1 3/4 - 1 5/8 - 1 7/8 - 1 3/4 - 1 5/8 - 2 - 2 1/8 - 2 1/4
57	60BS57	14.040	1 1/4	22.2	- 1 3/8 - 1 1/2 - 1 5/8 - 1 7/8 - 1 3/4 - 1 5/8 - 1 7/8 - 1 3/4 - 1 5/8 - 2 - 2 1/8 - 2 1/4
58	60BS58	14.280	1 1/4	23.0	- 1 3/8 - 1 1/2 - 1 5/8 - 1 7/8 - 1 3/4 - 1 5/8 - 1 7/8 - 1 3/4 - 1 5/8 - 2 - 2 1/8 - 2 1/4
59	60BS59	14.520	1 1/4	23.8	- 1 3/8 - 1 1/2 - 1 5/8 - 1 7/8 - 1 3/4 - 1 5/8 - 1 7/8 - 1 3/4 - 1 5/8 - 2 - 2 1/8 - 2 1/4
60	60BS60	14.760	1 1/4	25.0	- 1 3/8 - 1 1/2 - 1 5/8 - 1 7/8 - 1 3/4 - 1 5/8 - 1 7/8 - 1 3/4 - 1 5/8 - 2 - 2 1/8 - 2 1/4
70	60BS70	17.150	1 1/4	31.4	- 1 3/8 - 1 1/2 - 1 5/8 - 1 7/8 - 1 3/4 - 1 5/8 - 1 7/8 - 1 3/4 - 1 5/8 - 2 - 2 1/8 - 2 1/4
72	60BS72	17.630	2	33.5	- 1 3/8 - 1 1/2 - 1 5/8 - 1 7/8 - 1 3/4 - 1 5/8 - 1 7/8 - 1 3/4 - 1 5/8 - 2 - 2 1/8 - 2 1/4
80	60BS80	19.540	2	41.2	- 1 3/8 - 1 1/2 - 1 5/8 - 1 7/8 - 1 3/4 - 1 5/8 - 1 7/8 - 1 3/4 - 1 5/8 - 2 - 2 1/8 - 2 1/4
84	60BS84	20.490	2	45.8	- 1 3/8 - 1 1/2 - 1 5/8 - 1 7/8 - 1 3/4 - 1 5/8 - 1 7/8 - 1 3/4 - 1 5/8 - 2 - 2 1/8 - 2 1/4
96	60BS96	23.360	2 1/2	62.3	- 1 3/8 - 1 1/2 - 1 5/8 - 1 7/8 - 1 3/4 - 1 5/8 - 1 7/8 - 1 3/4 - 1 5/8 - 2 - 2 1/8 - 2 1/4
112	60BS112	27.180	2 1/2	81.0	- 1 3/8 - 1 1/2 - 1 5/8 - 1 7/8 - 1 3/4 - 1 5/8 - 1 7/8 - 1 3/4 - 1 5/8 - 2 - 2 1/8 - 2 1/4

Hub diameters vary to suit different bore sizes.

* W = Winch Sprockets — KW 3/16 x 3/32 — One SS at 90°

KEYWAY IS ON CENTER LINE OF TOOTH.

SPROCKETS



No. 60-Hardened Teeth — 2 Setscrews

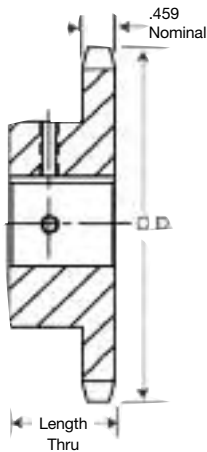

TYPE BS

No. Teeth	Catalog Number	Outside Diameter	Length Thru Bore	Weight Lbs. (Approx.)	Stock Finished Bores Includes Keyway and Setscrews
9	60BS9HT	2.51	1 1/4	.6	3/4 - 7/8 - 1
10	60BS10HT	2.76	1 1/4	.7	3/4 - 7/8 - 1 - 1 1/8 - 1 1/8 - 1 1/8 - 1 1/4
11	60BS11HT	3.00	1 1/4	.9	3/4 - 7/8 - 1 - 1 1/8 - 1 1/8 - 1 1/8 - 1 1/4
12	60BS12HT	3.25	1 1/4	1.3	3/4 - 7/8 - 1 - 1 1/8 - 1 1/8 - 1 1/8 - 1 1/4 - 1 1/8
13	60BS13HT	3.49	1 1/4	1.3	3/4 - 7/8 - 1 - 1 1/8 - 1 1/8 - 1 1/8 - 1 1/4 - 1 1/8 - 1 1/8 - 1 1/8 - 1 1/2
14	60BS14HT	3.74	1 1/4	1.6	3/4 - 7/8 - 1 - 1 1/8 - 1 1/8 - 1 1/8 - 1 1/4 - 1 1/8 - 1 1/8 - 1 1/8 - 1 1/2 - 1 1/2
15	60BS15HT	3.98	1 1/4	1.7	3/4 - 7/8 - 1 - 1 1/8 - 1 1/8 - 1 1/8 - 1 1/4 - 1 1/8 - 1 1/8 - 1 1/8 - 1 1/2 - 1 1/2 - 1 1/2
16	60BS16HT	4.22	1 1/4	2.1	3/4 - 7/8 - 1 - 1 1/8 - 1 1/8 - 1 1/8 - 1 1/4 - 1 1/8 - 1 1/8 - 1 1/8 - 1 1/2 - 1 1/2 - 1 1/2 - 1 1/2
17	60BS17HT	4.46	1 1/4	2.4	1 - 1 1/8 - 1 1/8 - 1 1/4 - 1 1/8 - 1 1/8 - 1 1/8 - 1 1/2 - 1 1/2 - 1 1/2 - 1 1/2
18	60BS18HT	4.70	1 1/4	2.6	1 - 1 1/8 - 1 1/8 - 1 1/4 - 1 1/8 - 1 1/8 - 1 1/8 - 1 1/2 - 1 1/2 - 1 1/2 - 1 1/2
19	60BS19HT	4.95	1 1/4	3.4	1 - 1 1/8 - 1 1/8 - 1 1/4 - 1 1/8 - 1 1/8 - 1 1/8 - 1 1/2 - 1 1/2 - 1 1/2 - 1 1/2
20	60BS20HT	5.19	1 1/4	3.9	1 - 1 1/8 - 1 1/8 - 1 1/4 - 1 1/8 - 1 1/8 - 1 1/8 - 1 1/2 - 1 1/2 - 1 1/2 - 1 1/2

KEYWAY IS ON CENTER LINE OF TOOTH.

Martin stock hardened teeth sprockets afford longer chain and sprocket life. Hardened teeth on the smaller sprocket of a roller chain drive are recommended if the drive ratio is four to one or greater or if the smaller sprocket has 24 teeth or less and is running at a speed of over 600 R.P.M.

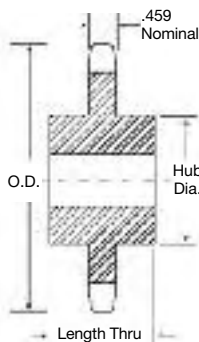

TYPE C

Single-Type C

No. Teeth	Catalog Number	Outside Diameter	Bore (inches)		Hub (inches)		Weight Lbs. (Approx.)
			Stock	Rec. Max.	Diameter	Length	
12	60C12	3.250	3/4	1	2 5/8*	2	2.25
13	60C13	3.490	3/4	1 1/2	2 1/2	2	2.75
14	60C14	3.740	3/4	1	2 5/8	2	3.19
15	60C15	3.980	3/4	1	2 5/8	2	3.10
16	60C16	4.220	3/4	2	3 1/8	2	4.19
17	60C17	4.460	3/4	2 1/4	3 1/4	2	4.81
18	60C18	4.700	3/4	2	3 1/2	2	5.62

* Has recessed groove in hub for chain clearance.

No. 60

3/4" Pitch

All Steel Stock Sprockets

Martin



SPROCKETS

Double Single-Type A — Steel

No. Teeth	Catalog Number	Diameters		Type	Min. Bore	Max. Bore	Dimensions				Wt. (Approx.)
		Outside Diameter	Pitch Diameter				L	C	E	w Nom.	
13	DS60A13	3.490	3.134	A	3/4	1 1/4	1 1/16	1 3/64	2 11/32	.459	2.6
14	DS60A14	3.740	3.371	A	3/4	1 1/8	1 1/16	1 3/64	2 1/16	.459	3.2
15	DS60A15	3.980	3.607	A	3/4	1 1/2	1 1/16	1 3/64	2 1/8	.459	3.8
16	DS60A16	4.220	3.844	A	3/4	1 5/8	1 1/16	1 3/64	3 3/64	.459	4.5
17	DS60A17	4.460	4.082	A	3/4	1 3/4	1 1/16	1 3/64	3 1/4	.459	5.3
18	DS60A18	4.700	4.319	A	3/4	1 7/8	1 1/16	1 3/64	3 1/2	.459	6.5
19	DS60A19	4.950	4.557	A	3/4	2 1/8	1 1/16	1 3/64	3 5/64	.459	6.8
20	DS60A20	5.190	4.794	A	3/4	2 1/4	1 1/16	1 3/64	3 3/64	.459	7.0
21	DS60A21	5.430	5.032	A	3/4	2 3/8	1 1/16	1 3/64	4 1/16	.459	7.5
22	DS60A22	5.670	5.270	A	3/4	2 1/2	1 1/16	1 3/64	4 7/16	.459	11.0
23	DS60A23	5.910	5.508	A	3/4	2 3/4	1 1/16	1 3/64	4 21/32	.459	11.5
24	DS60A24	6.150	5.749	A	3/4	2 7/8	1 1/16	1 3/64	4 29/32	.459	12.0

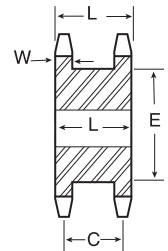

TYPE A

Double Single-Taper Bushed — Steel

No. Teeth	Catalog Number	Bushing Size	Diameters		Min. Bore	Max. Bore	Type	Dimensions				Wt. Rim Only	
			Outside Diameter	Pitch Diameter				L ₁	C	E	L ₂		w Nom.
16	DS60ATB16H	1615	4.220	3.844	1/2	1 1/8	A	1 1/16	1 3/64	2 63/64	1 1/2	.459	4.5
17	DS60ATB17H	1615	4.460	4.002	1/2	1 1/4	A	1 1/16	1 3/64	3 1/2	1 1/2	.459	4.5
18	DS60ATB18H	2012	4.700	4.319	1/2	2	A	1 1/16	1 3/64	3 1/2	1 1/4	.459	5.0
19	DS60ATB19H	2012	4.950	4.557	1/2	2	A	1 1/16	1 3/64	3 5/64	1 1/4	.459	5.8
20	DS60ATB20H	2517	5.190	4.794	1/2	2 1/2	A	1 1/16	1 3/64	3 3/64	1 1/4	.459	5.6
21	DS60ATB21H	2517	5.430	5.032	1/2	2 3/4	A	1 1/16	1 3/64	4 1/16	1 1/4	.459	6.4
23	DS60ATB23H	2517	5.910	5.508	1/2	2 3/4	A	1 1/16	1 3/64	4 43/64	1 1/4	.459	7.3
24	DS60ATB24H	2517	6.150	5.746	1/2	2 7/8	A	1 1/16	1 3/64	4 29/32	1 1/4	.459	8.2

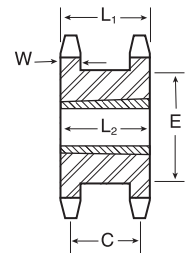

TAPER BUSH TYPE A

Double Single-MST® — Steel

No. Teeth	Catalog Number	Bushing Size	Diameters		Min. Bore	Max. Bore	Type	Dimensions				Wt. Rim Only	
			Outside Diameter	Pitch Diameter				L ₁	C	E	L ₂		w Nom.
17	DS60P17H	P1	4.460	4.002	1/2	1 1/4	B	1 1/16	1 3/64	3 7/32	1 15/16	.459	3.9
19	DS60P19H	P1	4.950	4.557	1/2	1 3/4	B	1 1/16	1 3/64	3 45/64	1 15/16	.459	5.3
21	DS60Q21H	Q1	5.430	5.032	3/4	2 11/16	B	1 1/16	1 3/64	4 3/16	2 1/2	.459	5.4
22	DS60Q22H	Q1	5.670	5.270	3/4	2 11/16	B	1 1/16	1 3/64	4 7/64	2 1/2	.459	6.2
23	DS60Q23H	Q1	5.910	5.508	3/4	2 11/16	B	1 1/16	1 3/64	4 43/64	2 1/2	.459	6.9
24	DS60Q24H	Q1	6.150	5.746	3/4	2 11/16	B	1 1/16	1 3/64	4 29/32	2 1/2	.459	7.6

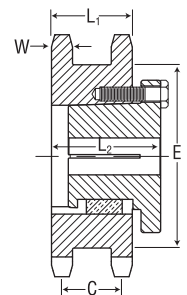

MST TYPE B

Single-Type B — Stainless

Single-Type A

No. Teeth	Catalog Number	Outside Diameter	Type	Bore (inches)		Hub (inches)		Weight Lbs. (Approx.)	Type	Catalog Number	Stock Bore	Weight Lbs. (Appl.)
				Stock	Rec. Max.	Diameter	Length Thru					
12	60B12SS	3.250	B	3/4	1 1/2	2 3/4*	1 1/4	1.5				
13	60B13SS	3.490	B	3/4	1 1/2	2 1 1/2	1 1/4	1.8				
14	60B14SS	3.740	B	3/4	1 1/2	2 5/8	1 1/4	2.0				
15	60B15SS	3.980	B	3/4	1 7/8	2 7/8	1 1/4	2.4				
16	60B16SS	4.220	B	3/4	2	3 1/8	1 1/4	2.8				
17	60B17SS	4.466	B	3/4	2 1/4	3 1/4	1 1/4	3.3				
18	60B18SS	4.700	B	3/4	2 1/2	3 1/2	1 1/4	3.8				
19	60B19SS	4.950	B	3/4	2 3/8	3 3/8	1 1/4	4.0				
20	60B20SS	5.190	B	3/4	2 1/2	3 5/8	1 1/4	4.6				
21	60B21SS	5.430	B	3/4	2 3/4	4	1 1/4	5.0	A	60A21SS	3/4	2.5
22	60B22SS	5.670	B	3/4	2 3/4	4	1 1/4	5.3	A	60A22SS	3/4	2.7
23	60B23SS	5.910	B	3/4	2 3/4	4	1 1/4	5.7	A	60A23SS	3/4	3.0
24	60B24SS	6.150	B	3/4	2 3/4	4	1 1/4	5.9	A	60A24SS	23/32	3.1
25	60B25SS	6.390	B	3/4	2 3/4	4	1 1/4	6.1	A	60A25SS	23/32	3.3
26	60B26SS	6.630	B	3/4	2 3/4	4	1 1/4	6.3	A	60A26SS	23/32	3.8
28	60B28SS	7.110	B	3/4	2 3/4	4	1 1/4	6.7	A	60A28SS	23/32	4.2
30	60B30SS	7.590	B	3/4	2 3/4	4	1 1/4	7.0	A	60A30SS	23/32	4.7
35	60B35SS	8.780	B	1	2 3/4	4	1 1/4	9.0	A	60A35SS	15/16	6.9
40	60B40SS	9.980	B	1	2 3/4	4 1/4	1 1/4	11.7	A	60A40SS	15/16	8.3
45	60B45SS	11.180	B	1	2 3/4	4 1/4	1 1/4	14.5	A	60A45SS	15/16	10.6
60	60B60SS	14.760	B	1 1/4	2 3/4	4 1/4	1 1/4	25.0	A	60A60SS	1 1/4	18.0

★ Has recessed groove in hub for chain clearance.

Maximum bores shown will accommodate standard keyseat and setscrew over keyseat. Slightly larger bores are possible with no keyseat, shallow keyseat, or setscrew at angle to keyseat.

Sprockets altered at factory (rebored with keyway and setscrew added) will be supplied with stainless setscrew.

SPROCKETS

Alteration Charges
See current discount sheet for alteration charges.



STAINLESS STEEL

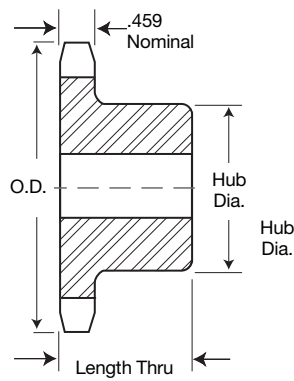

TYPE B

No. 60

3/4" Pitch

All Steel Stock Sprockets



Single-Type B

Single-Type A

No. Teeth	Catalog Number	Outside Diameter	Type	Bore (inches)		Hub (inches)		Weight Lbs (Approx.)	Type	Catalog Number	Stock Bore	Weight Lbs. (Approx.)
				Stock	Rec. Max.	Diameter	Length Thru					
8	60B8	2.260	B	3/8	3/8	1 1/2*	1 1/4	.54				
9	60B9	2.510	B	3/8	7/8	1 1/2*	1 1/4	.64				
10	60B10	2.760	B	3/8	1 1/8	1 1/2*	1 1/4	.99	A	60A10	3/8	.44
11	60B11	3.000	B	3/8	1 1/8	2 1/2*	1 1/4	1.16	A	60A11	3/8	.54
12	60B12	3.250	B	3/8	1 1/2	2 3/4*	1 1/4	1.47	A	60A12	3/8	.68
13	60B13	3.490	B	3/8	1 1/2	2 1/2	1 1/4	1.66	A	60A13	3/8	.80
14	60B14	3.740	B	3/8	1 1/2	2 1/2	1 1/4	2.00	A	60A14	3/8	.94
15	60B15	3.980	B	3/8	1 1/2	2 1/2	1 1/4	2.51	A	60A15	3/8	1.08
16	60B16	4.220	B	3/8	2	3 1/2	1 1/4	2.81	A	60A16	3/8	1.24
17	60B17	4.460	B	3/8	2 1/4	3 1/4	1 1/4	3.22	A	60A17	3/8	1.44
18	60B18	4.700	B	3/8	2 1/4	3 1/4	1 1/4	3.72	A	60A18	3/8	1.62
19	60B19	4.950	B	3/8	2 1/4	3 1/4	1 1/4	3.92	A	60A19	3/8	1.84
20	60B20	5.190	B	3/8	2 1/2	3 3/4	1 1/4	4.63	A	60A20	3/8	2.12
21	60B21	5.430	B	3/8	2 1/2	4	1 1/4	5.00	A	60A21	3/8	2.28
22	60B22	5.670	B	3/8	2 1/2	4	1 1/4	5.25	A	60A22	3/8	2.48
23	60B23	5.910	B	3/8	2 1/2	4	1 1/4	5.48	A	60A23	3/8	2.68
24	60B24	6.150	B	3/8	2 1/2	4	1 1/4	5.78	A	60A24	23/32	3.00
25	60B25	6.390	B	3/8	2 1/2	4	1 1/4	6.13	A	60A25	23/32	3.34
26	60B26	6.630	B	3/8	2 1/2	4	1 1/4	6.38	A	60A26	23/32	3.54
27	60B27	6.870	B	3/8	2 1/2	4	1 1/4	6.72	A	60A27	23/32	3.96
28	60B28	7.110	B	3/8	2 1/2	4	1 1/4	6.88	A	60A28	23/32	4.14
29	60B29	7.350	B	3/8	2 1/2	4	1 1/4	7.28	A	60A29	23/32	4.40
30	60B30	7.590	B	3/8	2 1/2	4	1 1/4	7.58	A	60A30	23/32	4.78
31	60B31	7.830	B	3/8	2 1/2	4	1 1/4	7.72	A	60A31	23/32	5.24
32	60B32	8.070	B	3/8	2 1/2	4	1 1/4	8.26	A	60A32	23/32	5.52
33	60B33	8.300	B	1	2 1/2	4	1 1/4	8.42	A	60A33	1 1/8	5.86
34	60B34	8.540	B	1	2 1/2	4	1 1/4	8.80	A	60A34	1 1/8	6.16
35	60B35	8.780	B	1	2 1/2	4	1 1/4	9.04	A	60A35	1 1/8	6.78
36	60B36	9.020	B	1	2 1/2	4	1 1/4	9.60	A	60A36	1 1/8	6.82
37	60B37	9.260	B	1	2 1/2	4	1 1/4	10.24	A	60A37	1 1/8	7.52
38	60B38	9.500	B	1	2 1/2	4 1/4	1 1/4	10.84	A	60A38	1 1/8	7.84
39	60B39	9.740	B	1	2 1/2	4 1/4	1 1/4	11.36	A	60A39	1 1/8	8.28
40	60B40	9.980	B	1	2 1/2	4 1/4	1 1/4	11.50	A	60A40	1 1/8	8.56
41	60B41	10.220	B	1	2 1/2	4 1/4	1 1/4	12.14	A	60A41	1 1/8	9.10
42	60B42	10.460	B	1	2 1/2	4 1/4	1 1/4	12.74	A	60A42	1 1/8	9.84
43	60B43	10.700	B	1	2 1/2	4 1/4	1 1/4	13.00	A	60A43	1 1/8	9.74
44	60B44	10.940	B	1 1/8	2 1/2	4 1/4	1 1/4	13.88	A	60A44	1 1/8	10.76
45	60B45	11.180	B	1 1/8	2 1/2	4 1/4	1 1/4	13.98	A	60A45	1 1/8	11.08
46	60B46	11.420	B	1 1/8	2 1/2	4 1/4	1 1/4	14.60	A	60A46	1 1/8	11.50
47	60B47	11.650	B	1 1/8	2 1/2	4 1/4	1 1/4	15.00	A	60A47	1 1/8	12.32
48	60B48	11.890	B	1 1/8	2 1/2	4 1/4	1 1/4	15.82	A	60A48	1 1/8	12.42
49	60B49	12.130	B	1 1/8	2 1/2	4 1/4	1 1/4	15.90	A	60A49	1 1/8	12.92
50	60B50	12.370	B	1 1/8	2 1/2	4 1/4	1 1/4	17.66	A	60A50	1 1/8	13.98
51	60B51	12.610	B	1 1/8	2 1/2	4 1/4	1 1/4	16.98	A	60A51	1 1/8	14.58
52	60B52	12.850	B	1 1/8	2 1/2	4 1/4	1 1/4	17.93	A	60A52	1 1/8	14.60
53	60B53	13.090	B	1 1/8	2 1/2	4 1/4	1 1/4	17.99	A	60A53	1 1/8	15.84
54	60B54	13.330	B	1 1/8	2 1/2	4 1/4	1 1/4	21.60	A	60A54	1 1/8	15.92
55	60B55	13.570	B	1 1/4	2 1/2	4 1/4	1 1/4	21.14	A	60A55	1 1/4	16.96
56	60B56	13.810	B	1 1/4	2 1/2	4 1/4	1 1/4	21.88	A	60A56	1 1/4	17.60
57	60B57	14.040	B	1 1/4	2 1/2	4 1/4	1 1/4	22.26	A	60A57	1 1/4	17.62
58	60B58	14.280	B	1 1/4	2 1/2	4 1/4	1 1/4	22.80	A	60A58	1 1/4	19.00
59	60B59	14.520	B	1 1/4	2 1/2	4 1/4	1 1/4	23.86	A	60A59	1 1/4	19.20
60	60B60	14.760	B	1 1/4	2 1/2	4 1/4	1 1/4	25.22	A	60A60	1 1/4	20.02
64	60B64	15.720	B	1 1/4	2 1/2	4 1/4	1 1/4	27.40	A	60A64	1 1/4	23.00
65	60B65	15.960	B	1 1/4	2 1/2	4 1/4	1 1/4	28.92	A	60A65	1 1/4	23.24
66									A	60A66	1 1/4	24.42
68	60B68	16.670	B	1 1/4	2 1/2	4 1/4	1 1/4	30.38	A	60A68	1 1/4	25.54
70	60B70	17.150	B	1 1/4	2 1/2	4 1/4	1 1/4	31.98	A	60A70	1 1/4	27.20
72	60B72	17.630	B	1 1/4	2 1/2	4 1/4	2	34.18	A	60A72	1 1/4	28.90
76	60B76	18.580	B	1 1/4	2 1/2	4 1/4	2	38.06	A	60A76	1 1/4	32.34
80	60B80	19.540	B	1 1/4	2 1/2	4 1/4	2	41.88	A	60A80	1 1/4	45.50
84	60B84	20.490	B	1 1/4	3 1/4	4 3/4	2	46.46	A	60A84	1 1/4	40.18
90	60B90	21.930	B	1 1/4	3 3/8	5	2 1/2	63.20	A	60A90	1 1/4	43.44
96	60B96	23.360	B	1 1/4	3 3/4	5 1/2	2 1/2	63.08	A	60A96	1 1/4	52.02
112	60B112	27.180	B	1 1/4	3 3/4	5 1/2	2 1/2	81.78	A	60A112	1 1/4	70.80

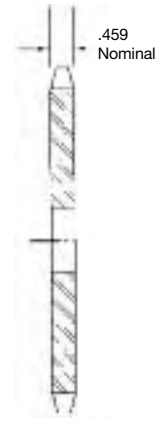

TYPE A

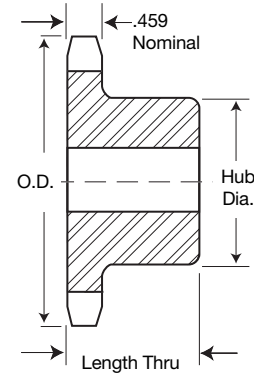

TYPE B

Alteration Charges

See current discount sheet for alteration charges.

★ Has recessed groove in hub for chain clearance.

Maximum bores shown will accommodate standard keyseat and setscrew over keyseat. Slightly larger bores are possible with no keyseat, shallow keyseat, or setscrew at angle to keyseat.

SPROCKETS

Single-Type QD With Hardened Teeth

No. Teeth	Catalog Number
11	60JA11H
12	60JA12H
13	60JA13H
14	60SH14H
15	60SH15H
16	60SH16H
17	60SDS17H
18	60SDS18H
19	60SDS19H
20	60SDS20H
21	60SDS21H
22	60SDS22H
23	60SDS23H
24	60SDS24H
25	60SDS25H
26	60SK26H
27	60SK27H
28	60SK28H
30	60SK30H

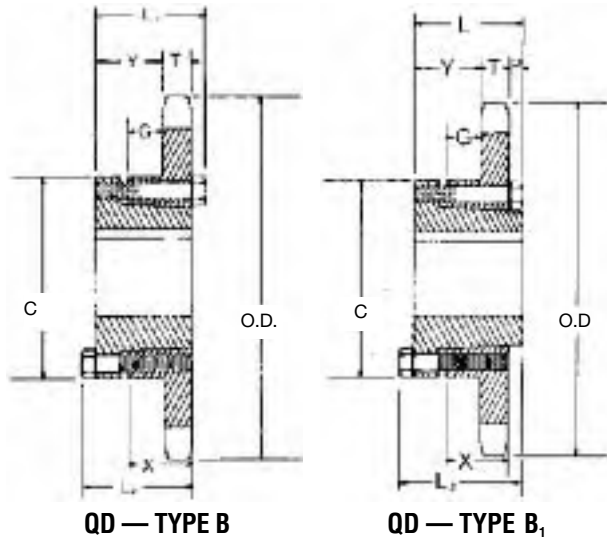

**SABER
TOOTH®**



SPROCKETS

Single-Type QD

No. Teeth	Catalog Number	Bush- ing	Diameters		Type	Max. Bore	Dimensions							Weight (Approx.)	
			Outside Diameter	Pitch Diameter			L ₁	L ₂	C	Y	G	X	T	With Hub	Rim Only
11	60JA11	JA	3.000	2.662	B	1 1/4	1 1/8	1 1/8	2 1/16	3/64	1 1/64	5/8	.459	1.36	.46
12	60JA12	JA	3.250	2.898	B	1 1/4	1 1/8	1 1/8	2 1/16	3/64	1 1/64	5/8	.459	1.50	.60
13	60JA13	JA	3.490	3.134	B	1 1/4	1 1/8	1 1/8	2 1/16	3/64	1 1/64	5/8	.459	1.66	.76
14	60SH14	SH	3.740	3.371	B	1 1/8	1 1/16	1 1/16	2 1/16	5/64	2 3/64	1 3/16	.459	1.88	.88
15	60SH15	SH	3.980	3.607	B	1 1/8	1 1/16	1 1/16	2 1/16	5/64	2 3/64	1 3/16	.459	2.08	1.08
16	60SH16	SH	4.220	3.844	B	1 1/8	1 1/16	1 1/16	2 1/16	5/64	2 3/64	1 3/16	.459	2.26	1.26
17	60SDS17	SDS	4.460	4.082	B	2	1 1/2	1 1/2	3 3/16	5/64	1 9/64	3/4	.459	2.38	1.38
18	60SDS18	SDS	4.700	4.319	B									2.56	1.56
19	60SDS19	SDS	4.950	4.557	B									2.76	1.76
20	60SDS20	SDS	5.190	4.794	B									3.00	2.00
21	60SDS21	SDS	5.430	5.032	B									3.20	2.20
22	60SDS22	SDS	5.670	5.270	B									3.44	2.44
23	60SDS23	SDS	5.910	5.508	B									3.70	2.70
24	60SDS24	SDS	6.150	5.746	B									3.94	2.94
25	60SDS25	SDS	6.390	5.984	B	2	1 1/2	1 1/2	3 3/16	5/64	1 9/64	3/4	.459	4.24	3.24
26	60SK26	SK	6.630	6.222	B	2 5/8	2 1/2	2 1/2	3 3/8	1 27/64	5 1/64	1 1/4	.459	6.18	4.18
27	60SK27	SK	6.870	6.460	B									6.52	4.52
28	60SK28	SK	7.110	6.699	B									6.72	4.72
30	60SK30	SK	7.590	7.175	B									7.34	5.34
32	60SK32	SK	8.070	7.652	B									8.10	6.10
35	60SK35	SK	8.780	8.367	B									9.42	7.42
36	60SK36	SK	9.020	8.605	B									9.70	7.70
40	60SK40	SK	9.980	9.559	B	2 5/8	2 1/2	2 1/2	3 3/8	1 27/64	5 1/64	1 1/4	.459	11.56	9.56
42	60SF42	SF	10.460	10.036	B	2 15/16	2 1/2	2 1/2	4 1/8	1 35/64	5 1/64	1 1/4	.459	13.78	10.78
45	60SF45	SF	11.180	10.752	B									15.40	12.40
48	60SF48	SF	11.890	11.467	B									17.26	14.26
54	60SF54	SF	13.330	12.899	B									20.02	17.02
60	60SF60	SF	14.760	14.331	B									23.76	20.76
70	60SF70	SF	17.150	16.717	B									31.60	28.60
72	60SF72	SF	17.630	17.194	B									32.58	29.58
80	60SF80	SF	19.540	19.103	B									41.24	38.24
84	60SF84	SF	20.490	20.058	B									43.94	40.94
96	60SF96	SF	23.360	22.922	B	2 5/8	2 1/2	2 1/2	4 1/8	1 35/64	5 1/64	1 1/4	.459	55.40	52.40
112	60E112	E	27.180	26.742	B1	3 1/2	2 3/4	2 3/4	6	2 3/16	1 11/64	1 1/8	.459	83.76	73.76

No. 60

3/4" Pitch

All Steel Stock Sprockets



Single-Taper Bushed with Hardened Teeth

No. Teeth	Catalog Number
11	60BTB11H
12	60BTB12H
13	60BTB13H
14	60BTB14H
15	60BTB15H
16	60BTB16H
17	60BTB17H
18	60BTB18H
19	60BTB19H
20	60BTB20H
21	60BTB21H
22	60BTB22H
23	60BTB23H
24	60BTB24H
25	60BTB25H
26	60BTB26H
27	60BTB27H
28	60BTB28H
30	60BTB30H

**SABER
TOOTH®**

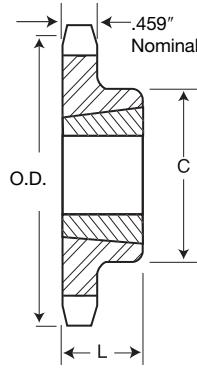

**TAPER BUSH
TYPE B**

SPROCKETS

Single-Taper Bushed

No. Teeth	Catalog Number	Bushing	Diameters		Max. Bore	Dimensions		Type	Weight (Approx.)	
			Outside Diameter	Pitch Diameter		L	C		Rim Only	Bushing Only
11	60BTB11	1008	3.004	2.662	1	7/8	1 1/16	B	.6	.3
12	60BTB12	1008	3.249	2.898	1	7/8	1 1/16	B	.8	.3
13	60BTB13	1210	3.493	3.134	1 1/4	1	2 1/32★	B	.8	.6
14	60BTB14	1210	3.736	3.371	1 1/4	1	2 9/32	B	1.0	.6
15	60BTB15	1610	3.979	3.607	1 1/2	1	2 5/32	B	1.0	.9
16	60BTB16	1610	4.221	3.844	1 1/2	1	3	B	1.4	.9
17	60BTB17	1610	4.462	4.082	1 1/2	1	3 1/4	B	1.8	.9
18	60BTB18	1610	4.704	4.319	1 1/2	1	3 1/2	B	1.9	.9
19	60BTB19	1610	4.945	4.557	1 1/2	1	3 1/2	B	2.2	.9
20	60BTB20	2012	5.185	4.794	2	1 1/4	3 5/16	B	2.2	1.7
21	60BTB21	2012	5.426	5.032	2	1 1/4	4	B	2.5	1.7
22	60BTB22	2012	5.666	5.270	2	1 1/4	4	B	2.8	1.7
23	60BTB23	2012	5.907	5.508	2	1 1/4	4	B	3.1	1.7
24	60BTB24	2012	6.147	5.746	2	1 1/4	3 3/8	B	3.4	1.7
25	60BTB25	2012	6.387	5.984	2	1 1/4	3 3/8	B	3.7	1.7
26	60BTB26	2012	6.627	6.222	2	1 1/4	3 3/8	B	4.0	1.7
27	60BTB27	2012	6.867	6.416	2	1 1/4	3 3/8	B	4.2	1.7
28	60BTB28	2012	7.107	6.699	2	1 1/4	3 3/8	B	4.6	1.7
30	60BTB30	2012	7.586	7.175	2	1 1/4	3 3/8	B	5.2	1.7
32	60BTB32	2012	8.065	7.652	2	1 1/4	3 3/8	B	5.6	1.7
35	60BTB35	2012	8.783	8.367	2	1 1/4	3 3/8	B	6.4	1.7
36	60BTB36	2012	9.022	8.605	2	1 1/4	3 3/8	B	6.6	1.7
40	60BTB40	2012	9.980	9.559	2	1 1/4	3 3/8	B	8.3	1.7
42	60BTB42	2012	10.458	10.036	2	1 1/4	3 3/8	B	10.0	1.7
45	60BTB45	2012	11.175	10.752	2	1 1/4	3 3/8	B	11.5	1.7
48	60BTB48	2012	11.893	11.467	2	1 1/4	3 3/8	B	13.2	1.7
54	60BTB54	2517	13.327	12.899	2 1/2	1 1/4	4 1/4	B	17.1	3.5
60	60BTB60	2517	14.761	14.330	2 1/2	1 1/4	4 1/4	B	21.0	3.5
70	60BTB70	2517	17.150	16.717	2 1/2	1 1/4	4 1/4	B	27.6	3.5
72	60BTB72	2517	17.628	17.194	2 1/2	1 1/4	4 1/4	B	30.0	3.5
80	60BTB80	2517	19.539	19.103	2 1/2	1 1/4	4 1/4	B	36.3	3.5
84	60BTB84	2517	20.494	20.058	2 1/2	1 1/4	4 1/4	B	40.6	3.5

★ Has recessed groove in hub for chain clearance.

Single - MST[®] Sprockets

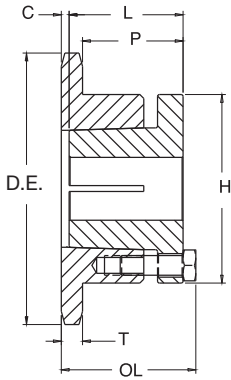

TIPO 3

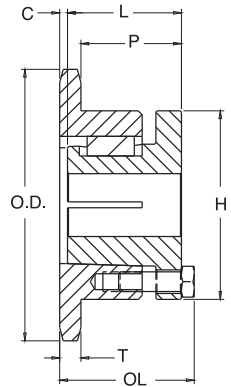

TYPE 4

No. Teeth	Catalog Number	Bush-ing	Diameters		Type	Max. Bore	Dimensions					Weight (Approx.)		
			Outside Dia.	Pitch Dia.			OL	L	C	H	P	T(nom)	With Hub	Rim Only
11	60H11H	H	3.000	2.662	3	1-1/2	1-13/16	1-1/4	3/8	2-1/2	1-5/32	.459	1.5	.7
12	60H12H	H	3.250	2.898	3	1-1/2	1-3/4	1-1/4	5/16	2-1/2	1-3/32	.459	1.6	.8
13	60H13H	H	3.490	3.134	3	1-1/2	1-1/2	1-1/4	1/16	2-1/2	27/32	.459	1.6	.8
13	60P13H	P1	3.490	3.134	4	1-3/4	2-3/16	1-15/16	0	3	1-15/32	.459	2.5	1.2
14	60H14H	H	3.740	3.371	3	1-1/2	1-1/2	1-1/4	1/16	2-1/2	27/32	.459	1.9	1.1
14	60P14H	P1	3.740	3.371	4	1-3/4	2-3/16	1-15/16	0	3	1-15/32	.459	2.7	1.4
15	60H15H	H	3.980	3.607	3	1-1/2	1-1/2	1-1/4	1/16	2-1/2	27/32	.459	2.2	1.4
15	60P15H	P1	3.980	3.607	4	1-3/4	2-3/16	1-15/16	0	3	1-15/32	.459	3.0	1.7
16	60H16H	H	4.220	3.844	3	1-1/2	1-1/2	1-1/4	1/16	2-1/2	27/32	.459	2.1	1.3
16	60P16H	P1	4.220	3.844	4	1-3/4	2-3/16	1-15/16	0	3	1-15/32	.459	3.1	1.8
17	60H17H	H	4.460	4.082	3	1-1/2	1-1/2	1-1/4	1/16	2-1/2	27/32	.459	2.3	1.5
17	60P17H	P1	4.460	4.082	4	1-3/4	2-3/16	1-15/16	0	3	1-15/32	.459	3.4	2.1
18	60H18H	H	4.700	4.319	3	1-1/2	1-1/2	1-1/4	1/16	2-1/2	27/32	.459	2.5	1.7
18	60P18H	P1	4.700	4.319	4	1-3/4	2-3/16	1-15/16	0	3	1-15/32	.459	3.5	2.2
19	60H19H	H	4.950	4.557	3	1-1/2	1-1/2	1-1/4	1/16	2-1/2	27/32	.459	2.7	1.9
19	60P19H	P1	4.950	4.557	4	1-3/4	2-3/16	1-15/16	0	3	1-15/32	.459	3.8	2.5
20	60H20H	H	5.190	4.794	3	1-1/2	1-1/2	1-1/4	1/16	2-1/2	27/32	.459	2.9	2.1
20	60P20H	P1	5.190	4.794	4	1-3/4	2-3/16	1-15/16	0	3	1-15/32	.459	4.4	3.1
20	60Q20H	Q1	5.190	4.794	4	2-11/16	2-25/32	2-1/2	0	4-1/8	2-1/32	.459	7.0	3.5
21	60P21H	P1	5.430	5.032	4	1-3/4	2-3/16	1-15/16	0	3	1-15/32	.459	4.2	2.9
21	60Q21H	Q1	5.430	5.032	4	2-11/16	2-25/32	2-1/2	0	4-1/8	2-1/32	.459	7.1	3.6
22	60H22H	H	5.670	5.270	3	1-1/2	1-1/2	1-1/4	1/16	2-1/2	27/32	.459	3.4	2.6
22	60P22H	P1	5.670	5.270	4	1-3/4	2-3/16	1-15/16	0	3	1-15/32	.459	4.5	3.2
22	60Q22H	Q1	5.670	5.270	4	2-11/16	2-25/32	2-1/2	0	4-1/8	2-1/32	.459	7.5	4.0
23	60P23H	P1	5.910	5.508	4	1-3/4	2-3/16	1-15/16	0	3	1-15/32	.459	4.8	3.5
23	60Q23H	Q1	5.910	5.508	4	2-11/16	2-25/32	2-1/2	0	4-1/8	2-1/32	.459	7.6	4.1
24	60H24H	H	6.150	5.746	3	1-1/2	1-1/2	1-1/4	1/16	2-1/2	27/32	.459	3.8	3.0
24	60P24H	P1	6.150	5.746	4	1-3/4	2-3/16	1-15/16	0	3	1-15/32	.459	5.1	3.8
24	60Q24H	Q1	6.150	5.746	4	2-11/16	2-25/32	2-1/2	0	4-1/8	2-1/32	.459	8.0	4.5
25	60P25H	P1	6.390	5.984	4	1-3/4	2-3/16	1-15/16	0	3	1-15/32	.459	5.4	4.1
25	60Q25H	Q1	6.390	5.984	4	2-11/16	2-25/32	2-1/2	0	4-1/8	2-1/32	.459	9.4	5.9
26	60P26H	P1	6.630	6.222	4	1-3/4	2-3/16	1-15/16	0	3	1-15/32	.459	5.6	4.3
26	60Q26H	Q1	6.630	6.222	4	2-11/16	2-25/32	2-1/2	0	4-1/8	2-1/32	.459	9.8	6.3
27	60P27H	P1	6.870	6.460	4	1-3/4	2-3/16	1-15/16	0	3	1-15/32	.459	5.8	4.5
27	60Q27H	Q1	6.870	6.460	4	2-11/16	2-25/32	2-1/2	0	4-1/8	2-1/32	.459	9.9	6.4
28	60P28H	P1	7.110	6.699	4	1-3/4	2-3/16	1-15/16	0	3	1-15/32	.459	6.2	4.9
28	60Q28H	Q1	7.110	6.699	4	2-11/16	2-25/32	2-1/2	0	4-1/8	2-1/32	.459	10.4	6.9
29	60Q29H	Q1	7.350	6.937	4	2-11/16	2-25/32	2-1/2	0	4-1/8	2-1/32	.459	10.8	7.3
30	60P30H	P1	7.590	7.175	4	1-3/4	2-3/16	1-15/16	0	3	1-15/32	.459	6.9	5.6
30	60Q30H	Q1	7.590	7.175	4	2-11/16	2-25/32	2-1/2	0	4-1/8	2-1/32	.459	11.1	7.6
31	60Q31	Q1	7.830	7.413	4	2-11/16	2-25/32	2-1/2	0	4-1/8	2-1/32	.459	11.3	7.8
32	60Q32	Q1	8.070	7.652	4	2-11/16	2-25/32	2-1/2	0	4-1/8	2-1/32	.459	11.8	8.3
33	60Q33	Q1	8.300	7.890	4	2-11/16	2-25/32	2-1/2	0	4-1/8	2-1/32	.459	12.2	8.7
34	60Q34	Q1	8.540	8.129	4	2-11/16	2-25/32	2-1/2	0	4-1/8	2-1/32	.459	12.6	9.1
35	60Q35	Q1	8.780	8.367	4	2-11/16	2-25/32	2-1/2	0	4-1/8	2-1/32	.459	12.8	9.3
36	60Q36	Q1	9.020	8.605	4	2-11/16	2-25/32	2-1/2	0	4-1/8	2-1/32	.459	13.4	9.9
37	60Q37	Q1	9.260	8.844	4	2-11/16	2-25/32	2-1/2	0	4-1/8	2-1/32	.459	13.8	10.3
38	60Q38	Q1	9.500	9.082	4	2-11/16	2-25/32	2-1/2	0	4-1/8	2-1/32	.459	14.1	10.6
39	60Q39	Q1	9.740	9.321	4	2-11/16	2-25/32	2-1/2	0	4-1/8	2-1/32	.459	14.6	11.1
40	60Q40	Q1	9.980	9.559	4	2-11/16	2-25/32	2-1/2	0	4-1/8	2-1/32	.459	15.1	11.6
41	60Q41	Q1	10.220	9.798	4	2-11/16	2-25/32	2-1/2	0	4-1/8	2-1/32	.459	15.4	11.9
42	60Q42	Q1	10.460	10.036	4	2-11/16	2-25/32	2-1/2	0	4-1/8	2-1/32	.459	16.1	12.6
44	60Q44	Q1	10.940	10.513	4	2-11/16	2-25/32	2-1/2	0	4-1/8	2-1/32	.459	16.9	13.4
45	60Q45	Q1	11.180	10.752	4	2-11/16	2-25/32	2-1/2	0	4-1/8	2-1/32	.459	17.4	13.9
47	60Q47	Q1	11.650	11.229	4	2-11/16	2-25/32	2-1/2	0	4-1/8	2-1/32	.459	19.8	16.3
48	60Q48	Q1	11.890	11.467	4	2-11/16	2-25/32	2-1/2	0	4-1/8	2-1/32	.459	19.9	16.4
50	60Q50	Q1	12.370	11.945	4	2-11/16	2-25/32	2-1/2	0	4-1/8	2-1/32	.459	20.4	16.9
54	60Q54	Q1	13.330	12.899	4	2-11/16	2-25/32	2-1/2	0	4-1/8	2-1/32	.459	23.1	19.6
56	60Q56	Q1	13.810	13.376	4	2-11/16	2-25/32	2-1/2	0	4-1/8	2-1/32	.459	23.8	20.3
60	60Q60	Q1	14.760	14.331	4	2-11/16	2-25/32	2-1/2	0	4-1/8	2-1/32	.459	26.4	22.9
70	60Q70	Q1	17.150	16.717	4	2-11/16	2-25/32	2-1/2	0	4-1/8	2-1/32	.459	34.4	30.9
70	60R70	R1	17.150	16.717	4	3-3/4	3-5/32	2-7/8	0	5-3/8	2-13/32	.459	39.3	31.8
72	60Q72	Q1	17.630	17.194	4	2-11/16	2-25/32	2-1/2	0	4-1/8	2-1/32	.459	35.4	31.9
72	60R72	R1	17.630	17.194	4	3-3/4	3-5/32	2-7/8	0	5-3/8	2-13/32	.459	41.6	34.1
80	60Q80	Q1	19.540	19.103	4	2-11/16	2-25/32	2-1/2	0	4-1/8	2-1/32	.459	42.6	39.1
80	60R80	R1	19.540	19.103	4	3-3/4	3-5/32	2-7/8	0	5-3/8	2-13/32	.459	49.0	41.5
84	60Q84	Q1	20.490	20.058	4	2-11/16	2-25/32	2-1/2	0	4-1/8	2-1/32	.459	45.1	41.6
84	60R84	R1	20.490	20.058	4	3-3/4	3-5/32	2-7/8	0	5-3/8	2-13/32	.459	52.3	44.8
96	60Q96	Q1	23.360	22.922	4	2-11/16	2-25/32	2-1/2	0	4-1/8	2-1/32	.459	57.5	54.0
96	60R96	R1	23.360	22.922	4	3-3/4	3-5/32	2-7/8	0	5-3/8	2-13/32	.459	63.5	56.0
112	60Q112	Q1	27.180	26.742	4	2-11/16	2-25/32	2-1/2	0	4-1/8	2-1/32	.459	76.5	73.0
112	60R112	R1	27.180	26.742	4	3-3/4	3-5/32	2-7/8	0	5-3/8	2-13/32	.459	82.0	74.5

Sprockets with "H" suffix have hardened teeth.

SPROCKETS

No. 60-2

3/4" Pitch

All Steel Stock Sprockets



Double-Type B & C

No. Teeth	Catalog Number	Outside Diameter	Type	Bore (inches)		Hub (inches)		Weight Lbs. (Approx.)
				Stock	Rec. Max.	Dia.	Length Thru	
11	D60B11H	3.000	B	1	1 1/4	1 1/16	2 1/2	1.62
12	D60B12H	3.250	B	1	1 1/8	2 1/8	2 1/2	2.20
13	D60B13H	3.490	B	1	1 1/2	2 1/4	2 1/2	2.60
14	D60B14H	3.740	B	1	1 1/4	2 1/8	2 1/2	3.24
15	D60B15H	3.980	B	1	1 1/8	2 1/16	2 1/2	3.96
16	D60B16H	4.220	B	1	2	3	2 1/2	4.62
17	D60B17H	4.460	B	1	2 1/4	3 1/4	2 1/2	5.40
18	D60B18H	4.700	B	1	2 1/2	3 1/2	2 1/2	6.24
19	D60B19H	4.950	B	1	2 1/2	3 1/16	2 1/2	7.00
20	D60B20H	5.190	B	1	2 1/2	3 1/4	2 1/2	7.72
21	D60B21H	5.430	B	1	2 1/4	4	2 1/2	8.82
22	D60B22H	5.670	B	1	2 1/4	4 1/4	2 1/2	9.68
23	D60B23H	5.910	B	1	2 1/4	4 1/4	2 1/2	10.30
24	D60B24H	6.150	B	1	2 1/4	4 1/4	2 1/2	11.14
25	D60B25H	6.390	B	1	2 1/4	4 1/4	2 1/2	11.96
26	D60B26	6.630	B	1	2 1/4	4 1/4	2 1/2	12.70
30	D60B30	7.590	B	1	2 1/4	4 1/4	2 1/2	16.36
32	D60B32	8.070	B	1 1/4	3	4 1/4	2 1/2	19.52
35	D60B35	8.780	B	1 1/4	3	4 1/2	2 1/2	22.80
36	D60B36	9.020	B	1 1/4	3	4 1/2	2 1/2	23.82
40	D60B40	9.980	B	1 1/4	3 1/4	4 1/4	2 1/2	30.84
42	D60B42	10.460	B	1 1/4	3 1/4	4 1/4	2 1/2	33.08
45	D60B45	11.180	B	1 1/4	3 1/4	4 1/4	2 1/2	37.08
52	D60B52	12.850	B	1 1/4	3 1/4	4 1/4	2 1/2	48.70
60	D60B60	14.760	B	1 1/4	3 1/4	4 1/4	2 1/2	63.10
68	D60C68	16.670	C	1 1/4	3 3/8	5	3	53.68
72	D60C72	17.630	C	1 1/4	3 3/8	5	3	53.74
76	D60C76	18.580	C	1 1/4	3 3/8	5	3	60.28
95	D60C95	23.120	C	1 1/4	3 1/2	5 1/2	3 1/2	87.14

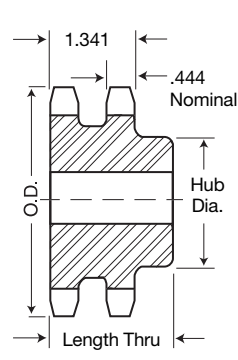

TYPE B

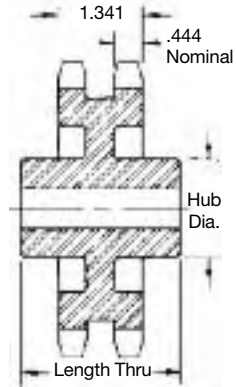

TYPE C

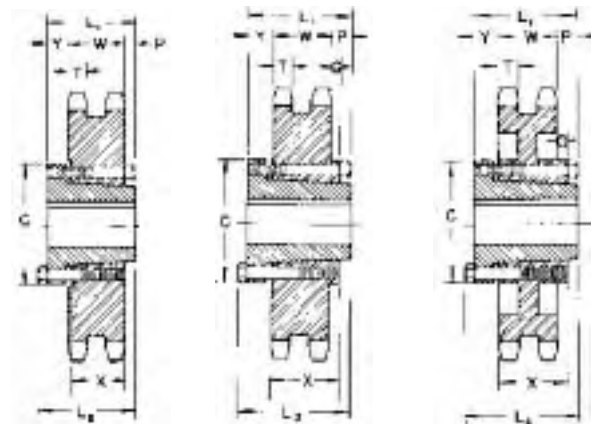

QD — TYPE C₁

QD — TYPE C₂

QD — TYPE C₄

Maximum bores shown will accommodate standard keyseat and setscrew over keyseat. Slightly larger bores are possible with no keyseat, shallow keyseat, or setscrew at angle to keyseat.

NOTE: Double 60 stock sprockets with 25 teeth or less have hardened teeth. As indicated by H suffix.

Alteration Charges

See current discount sheet for alteration charges.

Double-Type QD

No. Teeth	Catalog Number	Bush-ing	Diameters		Type	Max. Bore	Dimensions										Weight (Approx.)		
			Outside Diameter	Pitch Diameter			L ₁	L ₂	C	Y	P	G	X	T	W	With Hub	Rim Only		
14	D60SH14H	SH	3.740	3.371	B*	1 1/8	1 1/16	1 1/16	2 1/16	1/2					.444	1.341	2.5	1.5	
22	D60SDS22H	SDS	5.670	5.270	B*	2	1 1/16	1 1/16	3 1/16	3/4					.444	1.341	5.44	4.44	
36	D60SF36	SF	9.020	8.605	C1	2 1/16	2	2 1/4	4 1/4	3/4					1 1/4	.444	1.341	19.26	16.26
42	D60E42	E	10.460	10.036	C2	3 1/2	2 1/2	2 1/16	6	7/8	1 1/16	1/2			1 1/4	.444	1.341	34.04	24.04
45	D60E45	E	11.180	10.752	C2													38.26	28.36
52	D60E52	E	12.850	12.422	C2													49.52	39.52
60	D60E60	E	14.760	14.331	C2													63.39	53.74
68	D60E68	E	16.670	16.240	C4													54.32	44.32
76	D60E76	E	18.580	18.149	C4													61.48	51.48
95	D60E95	E	23.120	22.683	C4	3 1/2	2 1/2	2 1/16	6	7/8	1 1/16	1/2			1 1/4	.444	1.341	82.96	72.96

* Not illustrated. Dimensions listed correspond approximately to illustrations shown.

SPROCKETS

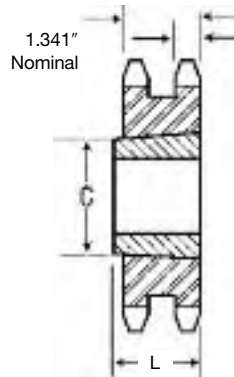

TYPE A

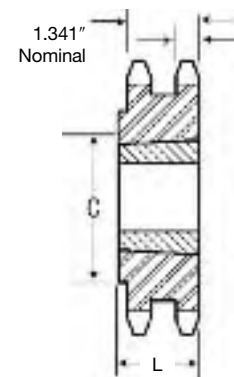

TYPE B

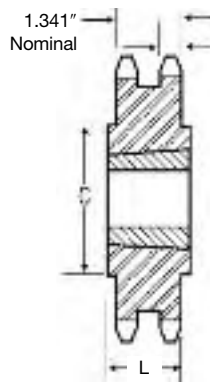

TYPE C₁

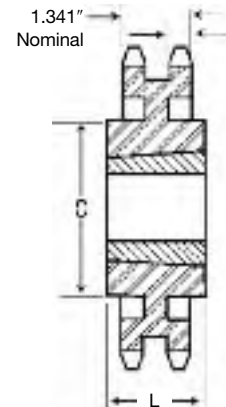

TYPE C

Double-Taper Bushed

No. Teeth	Catalog Number	Bushing	Diameters		Max. Bore	Dimensions			Weight (Approx.)	
			Outside Diameter	Pitch Diameter		L	C	Type	Rim Only	Bushing Only
13	D60BTB13H	1215	3.493	3.134	1/4	1 1/2	2 1/4	B	1.2	1.6
14	D60BTB14H	1215	3.736	3.371	1/4	1 1/2	2 1/2	B	1.6	1.7
15	D60BTB15H	1615	3.979	3.607	1/4	1 1/2	2 3/16	B	1.3	1.8
16	D60BTB16H	1615	4.221	3.844	1/4	1 1/2	3	B	2.2	2.3
17	D60BTB17H	1615	4.462	4.082	1/4	1 1/2	3 1/4	B	2.5	2.8
18	D60ATB18H	2012	4.704	4.319	2	1 1/4		A	3.0	2.4
19	D60ATB19H	2012	4.945	4.557	2	1 1/4		A	3.5	2.9
20	D60BTB20H	2517	5.185	4.794	2 1/2	1 1/4	3 5/16	B	4.0	2.9
21	D60BTB21H	2517	5.426	5.032	2 1/2	1 1/4	4 1/16	B	5.0	3.8
25	D60BTB25H	2517	6.387	4.984	2 1/2	1 1/4	5 5/16	B	7.5	7.4
30	D60BTB30	2517	7.586	7.175	2 1/2	1 1/4	6 1/2	B	13.5	13.3
36	D60CTB36	2517	9.022	8.605	2 1/2	1 1/4	4 1/4	C	17.5	17.4
42	D60CTB42	2517	10.458	10.036	2 1/2	1 1/4	4 1/4	C	25.5	25.0
45	D60CTB45	2517	11.176	10.752	2 1/2	1 1/4	4 1/4	C	29.5	29.3
52	D60CTB52	2517	12.849	12.422	2 1/2	1 1/4	4 1/4	C	41.0	40.3
60	D60CTB60	2517	14.761	14.330	2 1/2	1 1/4	4 1/4	C 1	32.5	33.5
68	D60CTB68	2517	16.672	16.240	2 1/2	1 1/4	4 1/4	C 1	36.5	43.2
76	D60CTB76	3020	18.583	18.149	3	2	5 1/4	C 1	42.5	47.8
95	D60CTB95	3020	23.121	22.684	3	2	5 1/4	C 1	48.5	69.8

NOTE: Double 60 stock sprockets with 25 teeth or less have hardened teeth.

No. 60-2

3/4" Pitch

MST® Sprockets

Martin

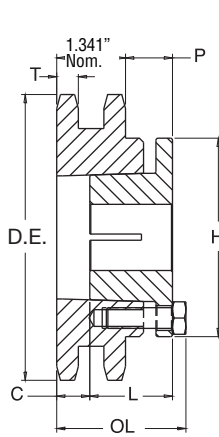

TIPO 11

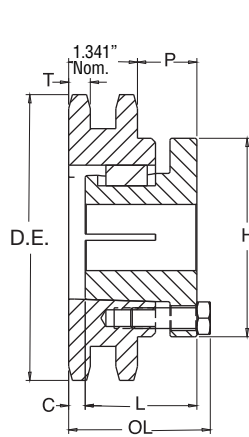

TIPO 12

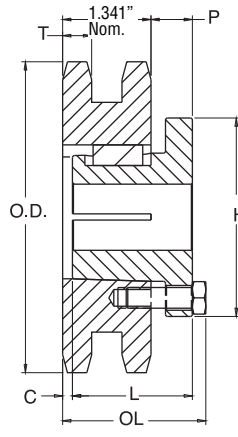

TYPE 13

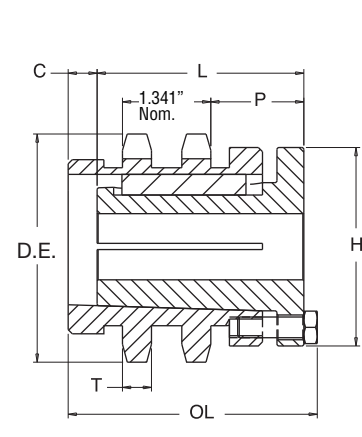

TIPO 16

SPROCKETS

Double - MST® Sprockets

No. Teeth	Catalog Number	Bush-ing	Diameters		Type	Max. Bore	Dimensions					Weight (Approx.)		
			Outside Dia.	Pitch Dia.			OL	L	C	H	P	T(nom)	With Hub	Rim Only
13	D60P13H	P1	3.490	3.134	16	1-3/4	3-13/16	1-15/16	1 5/8	3	1-13/32	.444	3.8	2.5
14	D60P14H	P1	3.740	3.371	12	1-3/4	3	1-15/16	13/16	3	1-13/32	.444	3.6	2.3
15	D60P15H	P1	3.980	3.607	12	1-3/4	3	1-15/16	13/16	3	1-13/32	.444	4.0	2.7
16	D60P16H	P1	4.220	3.844	13	1-3/4	2-7/32	1-15/16	1/32	3	5/8	.444	3.7	2.4
17	D60P17H	P1	4.460	4.082	13	1-3/4	2-7/32	1-15/16	1/32	3	5/8	.444	4.1	2.8
18	D60P18H	P1	4.700	4.319	13	1-3/4	2-7/32	1-15/16	1/32	3	5/8	.444	4.7	3.4
19	D60P19H	P1	4.950	4.557	13	1-3/4	2-7/32	1-15/16	1/32	3	5/8	.444	5.3	4.0
20	D60P20H	P1	5.190	4.794	13	1-3/4	2-7/32	1-15/16	1/32	3	5/8	.444	6.0	4.7
21	D60Q21H	Q1	5.430	5.032	12	2-11/16	2-25/32	2-1/2	0	4-1/8	1-5/32	.444	8.3	4.8
22	D60Q22H	Q1	5.670	5.270	12	2-11/16	2-25/32	2-1/2	0	4-1/8	1-5/32	.444	9.1	5.6
23	D60Q23H	Q1	5.910	5.508	12	2-11/16	2-25/32	2-1/2	0	4-1/8	1-5/32	.444	9.8	6.3
24	D60Q24H	Q1	6.150	5.746	12	2-11/16	2-25/32	2-1/2	0	4-1/8	1-5/32	.444	10.5	7.0
25	D60Q25H	Q1	6.390	5.984	12	2-11/16	2-25/32	2-1/2	0	4-1/8	1-5/32	.444	11.4	7.9
26	D60Q26H	Q1	6.630	6.222	12	2-11/16	2-25/32	2-1/2	0	4-1/8	1-5/32	.444	12.3	8.8
27	D60Q27H	Q1	6.870	6.460	12	2-11/16	2-25/32	2-1/2	0	4-1/8	1-5/32	.444	13.1	9.6
28	D60Q28H	Q1	7.110	6.699	12	2-11/16	2-25/32	2-1/2	0	4-1/8	1-5/32	.444	14.0	10.5
30	D60Q30H	Q1	7.590	7.175	12	2-11/16	2-25/32	2-1/2	0	4-1/8	1-5/32	.444	15.8	12.3
32	D60Q32H	Q1	8.070	7.652	12	2-11/16	2-25/32	2-1/2	0	4-1/8	1-5/32	.444	17.8	14.3
35	D60Q35H	Q1	8.780	8.367	12	2-11/16	2-25/32	2-1/2	0	4-1/8	1-5/32	.444	21.2	17.7
36	D60Q36H	Q1	9.020	8.605	12	2-11/16	2-25/32	2-1/2	0	4-1/8	1-5/32	.444	21.9	18.4
40	D60Q40H	Q1	9.980	9.559	12	2-11/16	2-25/32	2-1/2	0	4-1/8	1-5/32	.444	27.4	23.9
42	D60Q42	Q1	10.460	10.036	12	2-11/16	2-25/32	2-1/2	0	4-1/8	1-5/32	.444	29.8	26.3
42	D60R42	R1	10.460	10.036	12	3-3/4	3-5/32	2-7/8	0	5-3/8	1 17/32	.444	33.2	25.7
45	D60R45	R1	11.180	10.752	12	3-3/4	3-5/32	2-7/8	0	5-3/8	1 17/32	.444	37.7	30.2
48	D60R48	R1	11.890	11.467	12	3-3/4	3-5/32	2-7/8	0	5-3/8	1 17/32	.444	42.6	35.1
52	D60R52	R1	12.850	12.422	12	3-3/4	3-5/32	2-7/8	0	5-3/8	1 17/32	.444	49.3	41.8
54	D60R54	R1	13.330	12.899	12	3-3/4	3-5/32	2-7/8	0	5-3/8	1 17/32	.444	52.6	45.1
60	D60R60	R1	14.760	14.331	12	3-3/4	3-5/32	2-7/8	0	5-3/8	1 17/32	.444	62.3	54.8
68	D60R68	R1	16.670	16.240	12	3-3/4	3-5/32	2-7/8	0	5-3/8	1 17/32	.444	81.3	73.8
72	D60R72	R1	17.630	17.194	12	3-3/4	3-5/32	2-7/8	0	5-3/8	1 17/32	.444	89.3	81.8
76	D60R76	R1	18.580	18.149	12	3-3/4	3-5/32	2-7/8	0	5-3/8	1 17/32	.444	100.5	93.0
84	D60R84	R1	20.490	20.058	12	3-3/4	3-5/32	2-7/8	0	5-3/8	1 17/32	.444	118.5	111.0
95	D60R95	R1	23.120	22.683	12	3-3/4	3-5/32	2-7/8	0	5-3/8	1 17/32	.444	155.5	148.0
96	D60R96	R1	23.360	22.922	12	3-3/4	3-5/32	2-7/8	0	5-3/8	1 17/32	.444	162.5	155.0

Sprockets with "H" suffix have hardened teeth.

Triple-Type B & C

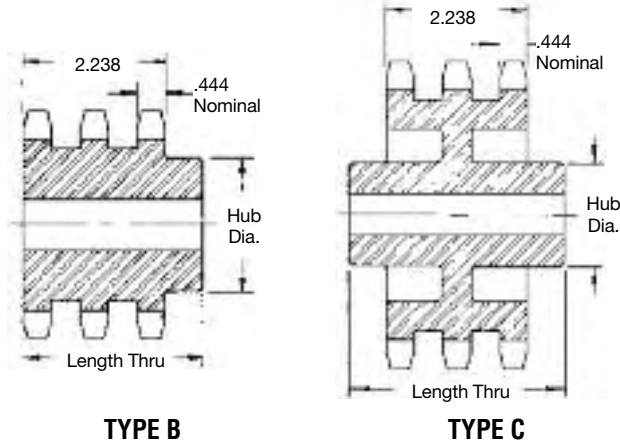

TYPE B

TYPE C

No. Teeth	Catalog Number	Outside Diameter	Type	Bore (inches)		Hub (inches)		Weight Lbs. (Approx.)
				Stock	Rec. Max.	Dia.	Length Thru	
11	E60B11H	3.000	B	1	1 1/4	1 13/16	3	2.5
12	E60B12H	3.250	B	1	1 1/2	2 1/8	3	3.3
13	E60B13H	3.490	B	1	1 1/2	2 1/4	3	3.9
14	E60B14H	3.740	B	1	1 1/2	2 1/2	3	4.5
15	E60B15H	3.980	B	1	1 1/2	2 3/8	3	5.4
16	E60B16H	4.220	B	1	2	3	3	6.5
17	E60B17H	4.460	B	1	2 1/4	3 1/4	3	7.7
18	E60B18H	4.700	B	1	2 1/2	3 1/2	3	8.5
19	E60B19H	4.950	B	1	2 1/2	3 3/8	3	10.0
20	E60B20H	5.190	B	1	2 1/2	3 1/2	3	11.2
21	E60B21H	5.430	B	1	2 1/2	4	3	12.5
22	E60B22H	5.670	B	1	2 1/2	4 1/4	3	13.2
23	E60B23H	5.910	B	1	2 1/2	4 1/4	3	14.6
24	E60B24H	6.150	B	1	2 1/2	4 1/4	3	15.8
25	E60B25H	6.390	B	1	2 1/2	4 1/4	3	17.0
26	E60B26	6.630	B	1	2 1/2	4 1/4	3	18.6
30	E60B30	7.590	B	1	2 1/2	4 1/4	3	23.2
35	E60B35	8.780	B	1 1/4	3	4 1/2	3 1/4	34.5
36	E60B36	9.020	B	1 1/4	3	4 1/2	3 1/4	37.0
42	E60B42	10.460	B	1 1/4	3 1/4	4 1/2	3 3/8	49.0
45	E60B45	11.180	B	1 1/4	3 1/4	4 1/2	3 3/8	57.0
52	E60C52	12.850	C	1 1/4	3 1/4	4 1/2	3 1/2	73.0
60	E60C60	14.760	C	1 1/4	3 1/4	4 1/2	3 1/2	63.0
68	E60C68	16.670	C	1 1/4	3 1/4	5	3 1/2	73.0
72	E60C72	17.630	C	1 1/2	3 1/2	5	3 1/2	85.0
76	E60C76	18.580	C	1 1/2	3 1/2	5 1/2	3 1/2	82.0
95	E60C95	23.120	C	1 1/2	3 1/2	5 1/2	4	105.0

Maximum bores shown will accommodate standard keyseat and setscrew over keyseat. Slightly larger bores are possible with no keyseat, shallow keyseat, or setscrew at angle to keyseat.

NOTE: Triple 60 stock sprockets with 25 teeth or less have hardened teeth. As indicated by H suffix.



Alteration Charges

See current discount sheet for alteration charges.

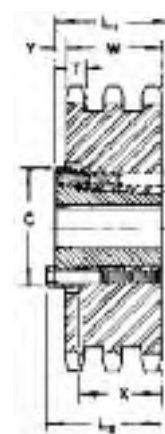

QD — TYPE B

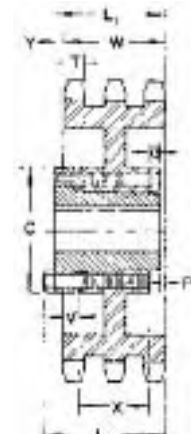

QD — TYPE B₁

Triple-Type QD

No. Teeth	Catalog Number	Bush-ing	Diameters		Type	Max. Bore	Dimensions										Weight (Approx.)	
			Outside Diameter	Pitch Diameter			L ₁	L ₂	C	Y	P	G	V	X	T	W	With Hub	Rim Only
36	E60E36	E	9.020	8.605	B	3 1/2	2 1/4	2 1/8	6	1 1/4	1/2			1 1/4	.444	2.238	49	37
42	E60E42	E	10.460	10.036	B	3 1/2	2 1/4	2 1/8	6	1 1/4	1/2			1 1/4	.444	2.238	62	50
52	E60E52	E	12.850	12.422	B	3 1/2	2 1/4	2 1/8	6	1 1/4	1/2			1 1/4	.444	2.238	80	68
68	E60E68	E	16.670	16.240	B1	3 1/2	2 1/8	3 1/4	6	1 1/2	3/8	1/2	1/8	1 1/4	.444	2.238	83	71
76	E60E76	E	18.580	18.149	B1	3 1/2	2 1/8	3 1/4	6	1 1/2	3/8	1/2	1/8	1 1/4	.444	2.238	99	87
95	E60E95	E	23.120	22.683	B1	3 1/2	2 1/8	3 1/4	6	1 1/2	3/8	1/2	1/8	1 1/4	.444	2.238	129	117

No. 60-3

3/4" Pitch

MST[®] Sprockets

Martin

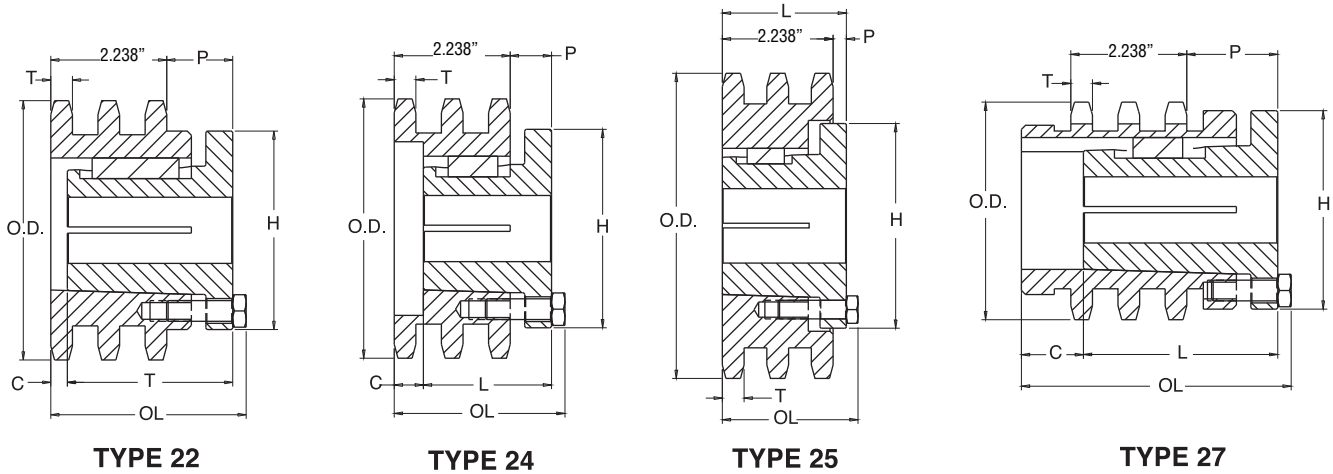

TYPE 22

TYPE 24

TYPE 25

TYPE 27

Triple - MST[®] Sprockets

No. Teeth	Catalog Number	Bush-ing	Diameters		Type	Max. Bore	Dimensions						Weight (Approx.)	
			Outside Dia.	Pitch Dia.			OL	L	C	H	P	T(nom)	With Hub	Rim Only
13	E60P13H	P2	3.490	3.134	27	1-3/4	4 23/32	2-15/16	1 17/32	3	1-13/32	.444	4.8	3.3
14	E60P14H	P2	3.740	3.371	22	1-3/4	3 29/32	2-15/16	1-23/32	3	1-13/32	.444	4.8	3.3
15	E60P15H	P2	3.980	3.607	22	1-3/4	3 29/32	2-15/16	1-23/32	3	1-13/32	.444	5.5	4.0
16	E60P16H	P1	4.220	3.844	24	1-3/4	3 1/8	1-15/16	15/16	3	5/8	.444	4.7	3.4
17	E60Q17H	Q1	4.460	4.082	27	2-11/16	5	3-1/2	13/32	4-1/8	1-21/32	.444	8.1	4.6
18	E60Q18H	Q1	4.700	4.319	22	2-11/16	4-3/16	3-1/2	13/32	4-1/8	1-21/32	.444	8.5	5.0
19	E60Q19H	Q1	4.950	4.557	22	2-11/16	4-3/16	3-1/2	13/32	4-1/8	1-21/32	.444	9.4	5.9
20	E60Q20H	Q1	5.190	4.794	22	2-11/16	4-3/16	3-1/2	13/32	4-1/8	1-21/32	.444	10.5	7.0
21	E60Q21H	Q1	5.430	5.032	24	2-11/16	3-1/4	2-1/2	15/32	4-1/8	3/4	.444	9.2	5.7
22	E60Q22H	Q1	5.670	5.270	24	2-11/16	3-1/4	2-1/2	15/32	4-1/8	3/4	.444	10.1	6.6
23	E60Q23H	Q1	5.910	5.508	25	2-11/16	2-25/32	2-1/2	0	4-1/8	1/4	.444	11.2	7.7
24	E60Q24H	Q1	6.150	5.746	25	2-11/16	2-25/32	2-1/2	0	4-1/8	1/4	.444	12.3	8.8
25	E60Q25H	Q1	6.390	5.984	25	2-11/16	2-25/32	2-1/2	0	4-1/8	1/4	.444	13.5	10.0
26	E60Q26H	Q1	6.630	6.222	25	2-11/16	2-25/32	2-1/2	0	4-1/8	1/4	.444	14.6	11.1
27	E60Q27H	Q1	6.870	6.460	25	2-11/16	2-25/32	2-1/2	0	4-1/8	1/4	.444	15.9	12.4
28	E60Q28H	Q1	7.110	6.699	25	2-11/16	2-25/32	2-1/2	0	4-1/8	1/4	.444	17.1	13.6
30	E60R30H	R1	7.590	7.175	25	3-3/4	3-5/32	2-7/8	0	5-3/8	5/8	.444	21.5	14.0
32	E60R32H	R1	8.070	7.652	25	3-3/4	3-5/32	2-7/8	0	5-3/8	5/8	.444	26.5	19.0
35	E60R35H	R1	8.780	8.367	25	3-3/4	3-5/32	2-7/8	0	5-3/8	5/8	.444	29.5	22.0
36	E60R36H	R1	9.020	8.605	25	3-3/4	3-5/32	2-7/8	0	5-3/8	5/8	.444	30.9	23.4
40	E60R40	R1	9.980	9.559	25	3-3/4	3-5/32	2-7/8	0	5-3/8	5/8	.444	38.8	31.3
42	E60R42	R1	10.460	10.036	25	3-3/4	3-5/32	2-7/8	0	5-3/8	5/8	.444	42.8	35.3
52	E60R52	R1	12.850	12.422	25	3-3/4	3-5/32	2-7/8	0	5-3/8	5/8	.444	70.7	63.2

Sprockets with "H" suffix have hardened teeth.



All Steel Stock Sprockets

No. 80 1" Pitch

Single Type "BS" — 2 Setscrews — Bored-To-Size

No. Teeth	Catalog Number	Outside Diameter	Length Thru Bore	Weight Lbs. (Approx.)	Stock Finished Bores Includes Keyway and Setscrews
9	80BS9	3.350	1 1/4	1.6	1 — 1/8 — 1/8 — 1/4
10	80BS10	3.680	1 1/4	1.7	1 — 1/8 — 1/8 — 1/4
10	80BS10W*	3.680	1 1/4	1.7	1/4
11	80BS11	4.010	1 1/4	1.8	1 — 1/8 — 1/8 — 1/4 — 1/8 — 1/8 — 1/2 — 1/4
11	80BS11W*	4.010	1 1/4	1.8	1/4
12	80BS12	4.330	1 1/4	3.0	1 — 1/8 — 1/8 — 1/4 — 1/8 — 1/8 — 1/2 — 1/4 — 1/4
12	80BS12W*	4.330	1 1/4	3.0	1/4
13	80BS13	4.660	1 1/2	3.5	1 — 1/8 — 1/8 — 1/4 — 1/8 — 1/8 — 1/2 — 1/4 — 1/4 — 1/8 — 1/8 — 1 1/2
14	80BS14	4.980	1 1/2	4.1	1 — 1/8 — 1/8 — 1/4 — 1/8 — 1/8 — 1/2 — 1/4 — 1/4 — 1/8 — 1/8 — 1 1/2
15	80BS15	5.300	1 1/2	5.2	1 — 1/8 — 1/8 — 1/4 — 1/8 — 1/8 — 1/2 — 1/4 — 1/4 — 1/8 — 1/8 — 1 1/2
15	80BS15W*	5.300	1 1/2	5.3	1/4
16	80BS16	5.630	1 1/2	5.5	1 — — — 1/8 — 1/4 — 1/8 — 1/8 — 1/2 — 1/4 — 1/4 — — — 1 1/2
17	80BS17	5.950	1 1/2	6.0	1 — — — 1/8 — 1/4 — 1/8 — 1/8 — 1/2 — 1/4 — 1/4 — — — 1 1/2
18	80BS18	6.270	1 1/2	6.5	1 — — — 1/8 — 1/4 — 1/8 — 1/8 — 1/2 — 1/4 — 1/4 — — — 1 1/2
18	80BS18W*	6.270	1 1/2	6.0	1/4 — — — 1/2
19	80BS19	6.590	1 1/2	7.0	1 — — — 1/8 — 1/4 — 1/8 — 1/8 — 1/2 — 1/4 — 1/4 — — — 1 1/2
20	80BS20	6.910	1 1/2	8.0	1 — — — 1/8 — 1/4 — 1/8 — 1/8 — 1/2 — 1/4 — 1/4 — — — 1 1/2
21	80BS21	7.240	1 1/2	8.9	1 — — — 1/8 — 1/4 — 1/8 — 1/8 — 1/2 — 1/4 — 1/4 — — — 1 1/2
22	80BS22	7.560	1 1/2	9.5	1 — — — 1/8 — 1/4 — 1/8 — 1/8 — 1/2 — 1/4 — 1/4 — — — 1 1/2
23	80BS23	7.880	1 1/2	10.2	1 — — — 1/8 — 1/4 — 1/8 — 1/8 — 1/2 — 1/4 — 1/4 — — — 1 1/2
24	80BS24	8.200	1 1/2	10.8	1 — — — 1/8 — 1/4 — 1/8 — 1/8 — 1/2 — 1/4 — 1/4 — — — 1 1/2
25	80BS25	8.520	1 1/2	11.4	1 — — — 1/8 — 1/4 — 1/8 — 1/8 — 1/2 — 1/4 — 1/4 — — — 1 1/2
26	80BS26	8.840	2	14.0	1/4 — 1/4 — 1/4 — 1/4 — 1/4 — 1/4 — 1/4 — 1/4 — 1/4 — — — 1 1/2
27	80BS27	9.160	2	14.7	1/4 — 1/4 — 1/4 — 1/4 — 1/4 — 1/4 — 1/4 — 1/4 — 1/4 — — — 1 1/2
28	80BS28	9.480	2	15.3	1/4 — 1/4 — 1/4 — 1/4 — 1/4 — 1/4 — 1/4 — 1/4 — 1/4 — — — 1 1/2
29	80BS29	9.800	2	16.4	1/4 — 1/4 — 1/4 — 1/4 — 1/4 — 1/4 — 1/4 — 1/4 — 1/4 — — — 1 1/2
30	80BS30	10.110	2	16.7	1/4 — 1/4 — 1/4 — 1/4 — 1/4 — 1/4 — 1/4 — 1/4 — 1/4 — — — 1 1/2
31	80BS31	10.430	2	18.0	1/4 — 1/4 — 1/4 — 1/4 — 1/4 — 1/4 — 1/4 — 1/4 — 1/4 — — — 1 1/2
32	80BS32	10.750	2	18.8	1/4 — 1/4 — 1/4 — 1/4 — 1/4 — 1/4 — 1/4 — 1/4 — 1/4 — — — 1 1/2
33	80BS33	11.070	2	18.9	1/4 — 1/4 — 1/4 — 1/4 — 1/4 — 1/4 — 1/4 — 1/4 — 1/4 — — — 1 1/2
34	80BS34	11.390	2	20.6	1/4 — 1/4 — 1/4 — 1/4 — 1/4 — 1/4 — 1/4 — 1/4 — 1/4 — — — 1 1/2
35	80BS35	11.710	2	21.4	1/4 — 1/4 — 1/4 — 1/4 — 1/4 — 1/4 — 1/4 — 1/4 — 1/4 — — — 1 1/2
36	80BS36	12.030	2	22.4	1/4 — 1/4 — 1/4 — 1/4 — 1/4 — 1/4 — 1/4 — 1/4 — 1/4 — — — 1 1/2
37	80BS37	12.350	2	23.9	1/4 — 1/4 — 1/4 — 1/4 — 1/4 — 1/4 — 1/4 — 1/4 — 1/4 — — — 1 1/2
38	80BS38	12.670	2	24.0	1/4 — 1/4 — 1/4 — 1/4 — 1/4 — 1/4 — 1/4 — 1/4 — 1/4 — — — 1 1/2
39	80BS39	12.990	2	24.9	1/4 — 1/4 — 1/4 — 1/4 — 1/4 — 1/4 — 1/4 — 1/4 — 1/4 — — — 1 1/2
40	80BS40	13.310	2	26.0	1/4 — 1/4 — 1/4 — 1/4 — 1/4 — 1/4 — 1/4 — 1/4 — 1/4 — — — 1 1/2
41	80BS41	13.630	2	27.1	1/4 — 1/4 — 1/4 — 1/4 — 1/4 — 1/4 — 1/4 — 1/4 — 1/4 — — — 1 1/2
42	80BS42	13.940	2	28.0	1/4 — 1/4 — 1/4 — 1/4 — 1/4 — 1/4 — 1/4 — 1/4 — 1/4 — — — 1 1/2
43	80BS43	14.260	2	29.3	1/4 — 1/4 — 1/4 — 1/4 — 1/4 — 1/4 — 1/4 — 1/4 — 1/4 — — — 1 1/2
44	80BS44	14.580	2	29.3	1/4 — 1/4 — 1/4 — 1/4 — 1/4 — 1/4 — 1/4 — 1/4 — 1/4 — — — 1 1/2
45	80BS45	14.900	2	30.7	1/4 — 1/4 — 1/4 — 1/4 — 1/4 — 1/4 — 1/4 — 1/4 — 1/4 — — — 1 1/2
46	80BS46	15.220	2	32.4	1/4 — 1/4 — 1/4 — 1/4 — 1/4 — 1/4 — 1/4 — 1/4 — 1/4 — — — 1 1/2
47	80BS47	15.540	2	33.3	1/4 — 1/4 — 1/4 — 1/4 — 1/4 — 1/4 — 1/4 — 1/4 — 1/4 — — — 1 1/2
48	80BS48	15.860	2	34.8	1/4 — 1/4 — 1/4 — 1/4 — 1/4 — 1/4 — 1/4 — 1/4 — 1/4 — — — 1 1/2
49	80BS49	16.180	2	35.1	1/4 — 1/4 — 1/4 — 1/4 — 1/4 — 1/4 — 1/4 — 1/4 — 1/4 — — — 1 1/2
50	80BS50	16.500	2	36.6	1/4 — 1/4 — 1/4 — 1/4 — 1/4 — 1/4 — 1/4 — 1/4 — 1/4 — — — 1 1/2
51	80BS51	16.810	2	38.5	1/4 — 1/4 — 1/4 — 1/4 — 1/4 — 1/4 — 1/4 — 1/4 — 1/4 — — — 1 1/2
52	80BS52	17.130	2	40.3	1/4 — 1/4 — 1/4 — 1/4 — 1/4 — 1/4 — 1/4 — 1/4 — 1/4 — — — 1 1/2
53	80BS53	17.450	2	42.2	1/4 — 1/4 — 1/4 — 1/4 — 1/4 — 1/4 — 1/4 — 1/4 — 1/4 — — — 1 1/2
54	80BS54	17.770	2	44.0	1/4 — 1/4 — 1/4 — 1/4 — 1/4 — 1/4 — 1/4 — 1/4 — 1/4 — — — 1 1/2
55	80BS55	18.090	2	46.3	1/4 — 1/4 — 1/4 — 1/4 — 1/4 — 1/4 — 1/4 — 1/4 — 1/4 — — — 1 1/2
56	80BS56	18.410	2	47.3	1/4 — 1/4 — 1/4 — 1/4 — 1/4 — 1/4 — 1/4 — 1/4 — 1/4 — — — 1 1/2
57	80BS57	18.730	2	48.9	1/4 — 1/4 — 1/4 — 1/4 — 1/4 — 1/4 — 1/4 — 1/4 — 1/4 — — — 1 1/2
58	80BS58	19.040	2	50.6	1/4 — 1/4 — 1/4 — 1/4 — 1/4 — 1/4 — 1/4 — 1/4 — 1/4 — — — 1 1/2
59	80BS59	19.360	2	52.2	1/4 — 1/4 — 1/4 — 1/4 — 1/4 — 1/4 — 1/4 — 1/4 — 1/4 — — — 1 1/2
60	80BS60	19.680	2	58.8	1/4 — 1/4 — 1/4 — 1/4 — 1/4 — 1/4 — 1/4 — 1/4 — 1/4 — — — 1 1/2

Hub diameters vary to suit different bore sizes.

NOTE: KEYWAY IS ON CENTER LINE OF TOOTH

* W = Winch Sprockets — KW 5/16 x 5/32 — One S.S. at 90°

SPROCKETS

No. 80 1" Pitch

All Steel Stock Sprockets



Single Type "BS" Winch — 1 Setscrew

No. Teeth	Catalog Number	Outside Diameter	Length Thru Bore	Weight Lbs. (Approx.)	Stock Finished Bores Includes Keyway (see Footnote) and Set Screw at 90° from Keyway
10	80BS10W	3.680	1"	1.7	1"
11	80BS11W	4.010	1"	1.8	1"
12	80BS12W	4.330	1"	3.0	1"
15	80BS15W	5.300	1½"	5.2	1"
18	80BS18W	6.270	1½"	7.8	1" — 1½"

NOTE: KEYWAY IS ON CENTER LINE OF TOOTH.



Double Type "BS" Winch (Hardened Teeth) — 1 Setscrew

No. Teeth	Catalog Number	Outside Diameter	Length Thru Bore	Weight Lbs. (Approx.)	Stock Finished Bores Includes Keyway (see Footnote) and Set Screw at 90° from Keyway
12	D80BS12HW	3.680	2"	5.2	1" — 1½" — 1"
15	D80BS15HW	5.300	2"	9.2	1" — 1½" — 1"
18	D80BS18HW	6.270	2"	13.5	1½" — 1" — 2"
20	D80BS20HW	6.910	2"	16.2	1½" — 1" — 2"
24	D80BS24HW	8.200	2"	23.2	1½" — 2"

NOTE: KEYWAY IS ON CENTER LINE OF TOOTH.

Footnote: 1¼" bore has a ⅜" x ⅛" keyway
 1½" bore has a ⅜" x ⅛" keyway
 1¾" bore has a ⅜" x ⅛" keyway
 2" bore has a ⅜" x ⅛" keyway

SINGLE TYPE BS

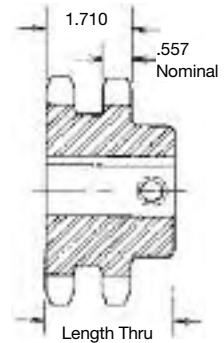

DOUBLE TYPE BS

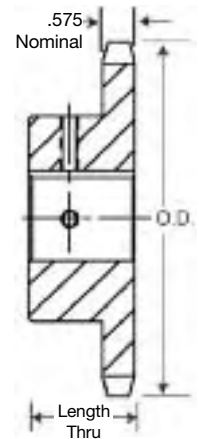

TYPE BS

No. 80 — Hardened Teeth — 2 Setscrews

No. Teeth	Catalog Number	Outside Diameter	Length Thru Bore	Weight Lbs. (Approx.)	Stock Finished Bores Includes Keyway and 2 Setscrews
9	80BS9HT	3.350	1"	1.6	1 — 1½ — 1½ — 1½
10	80BS10HT	3.680	1"	1.7	1 — 1½ — 1½ — 1½
11	80BS11HT	4.010	1"	1.8	1 — 1½ — 1½ — 1½ — 1½ — 1½ — 1½ — 1½
12	80BS12HT	4.330	1"	3.0	1 — 1½ — 1½ — 1½ — 1½ — 1½ — 1½ — 1½
13	80BS13HT	4.660	1"	3.5	1 — 1½ — 1½ — 1½ — 1½ — 1½ — 1½ — 1½ — 1½ — 1½ — 2
14	80BS14HT	4.980	1½"	4.1	1 — 1½ — 1½ — 1½ — 1½ — 1½ — 1½ — 1½ — 1½ — 1½ — 2
15	80BS15HT	5.300	1½"	5.2	1 — 1½ — 1½ — 1½ — 1½ — 1½ — 1½ — 1½ — 1½ — 1½ — 2
16	80BS16HT	5.630	1½"	6.1	1 — 1½ — 1½ — 1½ — 1½ — 1½ — 1½ — 1½ — 1½ — 1½ — 2
17	80BS17HT	5.950	1½"	7.0	1 — 1½ — 1½ — 1½ — 1½ — 1½ — 1½ — 1½ — 1½ — 1½ — 2 — 2½
18	80BS18HT	6.270	1½"	7.8	1 — 1½ — 1½ — 1½ — 1½ — 1½ — 1½ — 1½ — 1½ — 1½ — 2 — 2½
19	80BS19HT	6.590	1½"	8.3	1 — 1½ — 1½ — 1½ — 1½ — 1½ — 1½ — 1½ — 1½ — 1½ — 2 — 2½
20	80BS20HT	6.910	1½"	9.5	1 — 1½ — 1½ — 1½ — 1½ — 1½ — 1½ — 1½ — 1½ — 1½ — 2 — 2½

NOTE: KEYWAY IS ON CENTER LINE OF TOOTH

Martin stock hardened teeth sprockets afford longer chain and sprocket life. Hardened teeth on the smaller sprocket of a roller chain drive are recommended if the drive ratio is four to one or greater or if the smaller sprocket has 24 teeth or less and is running at a speed of over 600 R.P.M.

Single-Type C — Steel

No. Teeth	Catalog Number	Outside Diameter	Bore (inches)		Hub (inches)		Weight Lbs. (Approx.)
			Stock	Rec. Max.	Diameter	Length	
11	80C11	4.010	1	1½"	2½"★	2"	3.87
12	80C12	4.330	1	1½"	3½"★	2"	4.31
13	80C13	4.660	1	2"	3¾"	2"	5.32
14	80C14	4.980	1	2½"	3½"	2"	6.44
15	80C15	5.300	1	2½"	3¾"	2"	7.75
16	80C16	5.630	1	2¾"	4"	2"	8.81

★ Has recessed groove in hub for chain clearance.

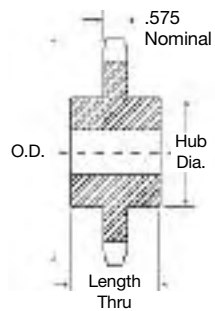

TYPE C

SPROCKETS



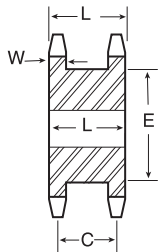

TYPE A

Double Single-Type A — Steel

No. Teeth	Catalog Number	Diameters		Type	Min. Bore	Max. Bore	Dimensions				Wt. (Approx)
		Outside Diameter	Pitch Diameter				L	C	E	w Nom.	
13	DS80A13	4.660	4.179	A	1	2	2 ³ / ₁₆	1 ¹ / ₂	3 ³ / ₄	.575	6.5
14	DS80A14	4.980	4.494	A	1	2 ¹ / ₂	2 ³ / ₁₆	1 ¹ / ₂	3 ¹ / ₂	.575	7.7
15	DS80A15	5.300	4.810	A	1	2 ³ / ₁₆	2 ³ / ₁₆	1 ¹ / ₂	3 ³ / ₁₆	.575	9.1
16	DS80A16	5.630	5.126	A	1	2 ¹ / ₂	2 ³ / ₁₆	1 ¹ / ₂	4	.575	9.5
17	DS80A17	5.950	5.442	A	1	2 ³ / ₁₆	2 ³ / ₁₆	1 ¹ / ₂	4 ¹ / ₁₆	.575	10.8
18	DS80A18	6.270	5.759	A	1	3 ¹ / ₂	2 ³ / ₁₆	1 ¹ / ₂	4 ³ / ₁₆	.575	12.1
19	DS80A19	6.590	6.076	A	1	3 ¹ / ₂	2 ³ / ₁₆	1 ¹ / ₂	4 ³ / ₁₆	.575	12.8
20	DS80A20	6.910	6.392	A	1	3 ¹ / ₂	2 ³ / ₁₆	1 ¹ / ₂	5 ¹ / ₁₆	.575	14.0
21	DS80A21	7.240	6.710	A	1	3 ¹ / ₂	2 ³ / ₁₆	1 ¹ / ₂	5 ³ / ₁₆	.575	16.5
22	DS80A22	7.560	7.027	A	1	3 ¹ / ₂	2 ³ / ₁₆	1 ¹ / ₂	5 ⁵ / ₁₆	.575	18.4
23	DS80A23	7.880	7.344	A	1	3 ¹ / ₂	2 ³ / ₁₆	1 ¹ / ₂	6 ¹ / ₁₆	.575	20.5

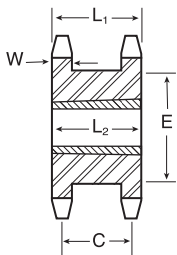

**TAPER BUSH
TYPE A**

Double Single-Taper Bushed — Steel

No. Teeth	Catalog Number	Bushing Size	Diameters		Min. Bore	Max. Bore	Type	Dimensions				Wt. Rim Only	
			Outside Diameter	Pitch Diameter				L ₁	C	E	L ₂		w Nom.
17	DS80ATB17H	2517	5.950	5.442	1/2	2 1/2	A	2 3/16	1 1/2	4 1/16	1 3/4	.575	7.6
18	DS80ATB18H	2517	6.270	5.759	1/2	2 1/2	A	2 3/16	1 1/2	4 1/16	1 3/4	.575	8.7
19	DS80ATB19H	3020	6.590	6.076	15/16	3	A	2 3/16	1 1/2	4 3/16	2	.575	9.7
20	DS80ATB20H	3020	6.910	6.392	15/16	3	A	2 3/16	1 1/2	5 1/16	2	.575	10.0
21	DS80ATB21H	3020	7.240	6.710	15/16	3	A	2 3/16	1 1/2	5 3/16	2	.575	12.0
22	DS80ATB22H	3020	7.560	7.027	15/16	3	A	2 3/16	1 1/2	5 5/16	2	.575	13.0
23	DS80ATB23H	3020	7.880	7.344	15/16	3	A	2 3/16	1 1/2	6 1/16	2	.575	14.5

Sprockets with "H" suffix have hardened teeth.

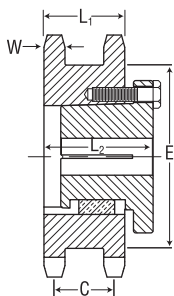

**MST
TYPE B**

Double Single- MST® — Steel

No. Teeth	Catalog Number	Bushing Size	Diameters		Min. Bore	Max. Bore	Type	Dimensions				Wt. Rim Only	
			Outside Diameter	Pitch Diameter				L ₁	C	E	L ₂		w Nom.
17	DS80Q17H	Q1	5.950	5.442	3/4	2 1/16	B	2 3/16	1 1/2	4 1/16	3 15/16	.575	7.2
19	DS80Q19H	Q1	6.590	6.076	3/4	2 1/16	B	2 3/16	1 1/2	4 3/16	3 15/16	.575	10.5
20	DS80Q20H	Q1	6.910	6.392	3/4	2 1/16	B	2 3/16	1 1/2	5 1/16	3 15/16	.575	12.2
21	DS80R21H	R1	7.240	6.710	1 1/8	3 3/8	B	2 3/16	1 1/2	5 3/16	3 3/4	.575	12.8
23	DS80R23H	R1	7.880	7.344	1 1/8	3 3/8	B	2 3/16	1 1/2	6 1/16	3 3/4	.575	13.3

Sprockets with "H" suffix have hardened teeth.

No. 80 1" Pitch

Stainless Steel Stock Sprockets

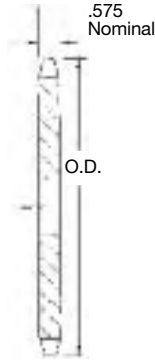

TYPE A

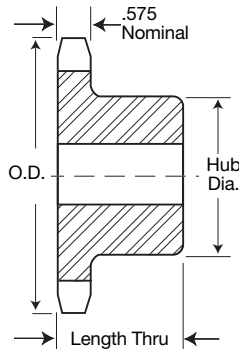

TYPE B

SPROCKETS

Single-Type B & C

Single-Type A

No. Teeth	Catalog Number	Outside Diameter	Type	Bore (inches)		Hub (inches)		Weight Lbs (Approx.)	Type	Catalog Number	Stock Bore	Weight Lbs. (Approx.)
				Stock	Rec. Max.	Dia.	Length Thru					
10	80B10SS	3.680	B	1	1½	2⅝*	1¾	2.2				
11	80B11SS	4.010	B	1	1¾	2⅞*	1¾	3.2				
12	80B12SS	4.330	B	1	1⅝	3⅜*	1¾	3.4				
13	80B13SS	4.660	B	1	2	3	1½	3.5				
14	80B14SS	4.980	B	1	2¼	3¼	1½	4.1				
15	80B15SS	5.300	B	1	2½	3⅝	1½	5.3				
16	80B16SS	5.630	B	1	2¾	4	1½	5.9				
17	80B17SS	5.950	B	1	2¾	4	1½	6.6				
18	80B18SS	6.270	B	1	2¾	4¼	1½	7.3				
19	80B19SS	6.590	B	1	2¾	4¼	1½	7.8				
20	80B20SS	6.910	B	1	2¾	4¼	1½	8.4				
21	80B21SS	7.240	B	1	2¾	4¼	1¾	9.4	A	80A21SS	1⅝	4.9
22	80B22SS	7.560	B	1	2¾	4¼	1¾	10.0	A	80A22SS	1⅝	5.5
23	80B23SS	7.880	B	1	2¾	4¼	1¾	10.7	A	80A23SS	1⅝	6.3
24	80B24SS	8.200	B	1	2¾	4¼	1¾	11.3	A	80A24SS	1⅝	6.7
25	80B25SS	8.520	B	1	2¾	4¼	1¾	11.9	A	80A25SS	1⅝	7.2
26	80B26SS	8.840	B	1¼	3¼	4¾	2	14.3	A	80A26SS	1¾	7.8
30	80B30SS	10.110	B	1⅝	3¼	4¾	2	17.4	A	80A30SS	1¾	10.7
35	80B35SS	11.710	B	1⅝	3¼	4¾	2	22.1	A	80A35SS	1¾	14.8
40	80B40SS	13.310	B	1⅝	3¼	4¾	2	26.7	A	80A40SS	1¾	18.9

* Has recessed groove in hub for chain clearance.

Maximum bores shown will accommodate standard keyseat and setscrew over keyseat. Slightly larger bores are possible with no keyseat, shallow keyseat, or setscrew at angle to keyseat.

Single-Type B & C

Single-Type A

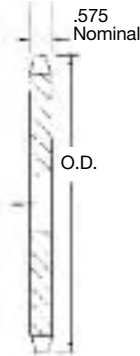

TYPE A

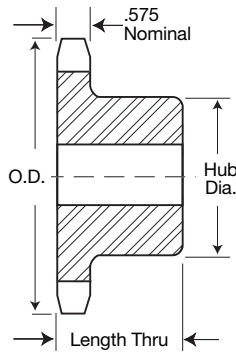

TYPE B

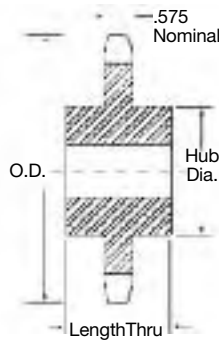

TYPE C

No. Teeth	Catalog Number	Outside Diameter	Type	Bore (inches)		Hub (inches)		Weight Lbs (Approx.)	Type	Catalog Number	Stock Bore	Weight Lbs. (Approx.)
				Stock	Rec. Max.	Dia.	Length Thru					
8	80B8	3.010	B	1	1	1 ¹ / ₁₆ ★	1 ¹ / ₁₆	1.4				
9	80B9	3.350	B	1	1 ¹ / ₁₆	2 ¹ / ₁₆ ★	1 ¹ / ₁₆	1.6	A	80A9	1 ¹ / ₁₆	.8
10	80B10	3.680	B	1	1 ¹ / ₁₆	2 ¹ / ₁₆ ★	1 ¹ / ₁₆	2.2	A	80A10	1 ¹ / ₁₆	1.0
11	80B11	4.010	B	1	1 ¹ / ₁₆	2 ¹ / ₁₆ ★	1 ¹ / ₁₆	3.2	A	80A11	1 ¹ / ₁₆	1.3
12	80B12	4.330	B	1	1 ¹ / ₁₆	3 ¹ / ₁₆ ★	1 ¹ / ₁₆	3.4	A	80A12	1 ¹ / ₁₆	1.5
13	80B13	4.660	B	1	2	3	1 ¹ / ₁₆	3.5	A	80A13	1 ¹ / ₁₆	1.8
14	80B14	4.980	B	1	2 ¹ / ₁₆	3 ¹ / ₁₆	1 ¹ / ₁₆	4.1	A	80A14	1 ¹ / ₁₆	2.2
15	80B15	5.300	B	1	2 ¹ / ₁₆	3 ¹ / ₁₆	1 ¹ / ₁₆	5.3	A	80A15	1 ¹ / ₁₆	2.5
16	80B16	5.630	B	1	2 ¹ / ₁₆	4	1 ¹ / ₁₆	5.9	A	80A16	1 ¹ / ₁₆	2.9
17	80B17	5.950	B	1	2 ¹ / ₁₆	4	1 ¹ / ₁₆	6.6	A	80A17	1 ¹ / ₁₆	3.3
18	80B18	6.270	B	1	2 ¹ / ₁₆	4 ¹ / ₁₆	1 ¹ / ₁₆	7.3	A	80A18	1 ¹ / ₁₆	3.7
19	80B19	6.590	B	1	2 ¹ / ₁₆	4 ¹ / ₁₆	1 ¹ / ₁₆	7.8	A	80A19	1 ¹ / ₁₆	4.1
20	80B20	6.910	B	1	2 ¹ / ₁₆	4 ¹ / ₁₆	1 ¹ / ₁₆	8.4	A	80A20	1 ¹ / ₁₆	4.7
21	80B21	7.240	B	1	2 ¹ / ₁₆	4 ¹ / ₁₆	1 ¹ / ₁₆	9.4	A	80A21	1 ¹ / ₁₆	4.9
22	80B22	7.560	B	1	2 ¹ / ₁₆	4 ¹ / ₁₆	1 ¹ / ₁₆	10.0	A	80A22	1 ¹ / ₁₆	5.5
23	80B23	7.880	B	1	2 ¹ / ₁₆	4 ¹ / ₁₆	1 ¹ / ₁₆	10.7	A	80A23	1 ¹ / ₁₆	6.3
24	80B24	8.200	B	1	2 ¹ / ₁₆	4 ¹ / ₁₆	1 ¹ / ₁₆	11.3	A	80A24	1 ¹ / ₁₆	6.7
25	80B25	8.520	B	1	2 ¹ / ₁₆	4 ¹ / ₁₆	1 ¹ / ₁₆	11.9	A	80A25	1 ¹ / ₁₆	7.2
26	80B26	8.840	B	1 ¹ / ₁₆	3 ¹ / ₁₆	4 ¹ / ₁₆	2	14.3	A	80A26	1 ¹ / ₁₆	7.8
27	80B27	9.160	B	1 ¹ / ₁₆	3 ¹ / ₁₆	4 ¹ / ₁₆	2	15.4	A	80A27	1 ¹ / ₁₆	8.6
28	80B28	9.480	B	1 ¹ / ₁₆	3 ¹ / ₁₆	4 ¹ / ₁₆	2	16.0	A	80A28	1 ¹ / ₁₆	9.3
29	80B29	9.800	B	1 ¹ / ₁₆	3 ¹ / ₁₆	4 ¹ / ₁₆	2	17.1	A	80A29	1 ¹ / ₁₆	9.8
30	80B30	10.110	B	1 ¹ / ₁₆	3 ¹ / ₁₆	4 ¹ / ₁₆	2	17.4	A	80A30	1 ¹ / ₁₆	10.7
31	80B31	10.430	B	1 ¹ / ₁₆	3 ¹ / ₁₆	4 ¹ / ₁₆	2	18.7	A	80A31	1 ¹ / ₁₆	11.3
32	80B32	10.750	B	1 ¹ / ₁₆	3 ¹ / ₁₆	4 ¹ / ₁₆	2	19.5	A	80A32	1 ¹ / ₁₆	12.1
33	80B33	11.070	B	1 ¹ / ₁₆	3 ¹ / ₁₆	4 ¹ / ₁₆	2	19.6	A	80A33	1 ¹ / ₁₆	13.6
34	80B34	11.390	B	1 ¹ / ₁₆	3 ¹ / ₁₆	4 ¹ / ₁₆	2	21.3	A	80A34	1 ¹ / ₁₆	14.3
35	80B35	11.710	B	1 ¹ / ₁₆	3 ¹ / ₁₆	4 ¹ / ₁₆	2	22.1	A	80A35	1 ¹ / ₁₆	14.8
36	80B36	12.030	B	1 ¹ / ₁₆	3 ¹ / ₁₆	4 ¹ / ₁₆	2	23.1	A	80A36	1 ¹ / ₁₆	16.1
37	80B37	12.350	B	1 ¹ / ₁₆	3 ¹ / ₁₆	4 ¹ / ₁₆	2	23.8	A	80A37	1 ¹ / ₁₆	16.8
38	80B38	12.670	B	1 ¹ / ₁₆	3 ¹ / ₁₆	4 ¹ / ₁₆	2	24.7	A	80A38	1 ¹ / ₁₆	17.2
39	80B39	12.990	B	1 ¹ / ₁₆	3 ¹ / ₁₆	4 ¹ / ₁₆	2	25.6	A	80A39	1 ¹ / ₁₆	17.9
40	80B40	13.310	B	1 ¹ / ₁₆	3 ¹ / ₁₆	4 ¹ / ₁₆	2	26.7	A	80A40	1 ¹ / ₁₆	18.9
41	80B41	13.630	B	1 ¹ / ₁₆	3 ¹ / ₁₆	4 ¹ / ₁₆	2	27.8	A	80A41	1 ¹ / ₁₆	21.0
42	80B42	13.940	B	1 ¹ / ₁₆	3 ¹ / ₁₆	4 ¹ / ₁₆	2	28.7	A	80A42	1 ¹ / ₁₆	21.8
43	80B43	14.260	B	1 ¹ / ₁₆	3 ¹ / ₁₆	4 ¹ / ₁₆	2	29.4	A	80A43	1 ¹ / ₁₆	23.6
44	80B44	14.580	B	1 ¹ / ₁₆	3 ¹ / ₁₆	4 ¹ / ₁₆	2	29.9	A	80A44	1 ¹ / ₁₆	24.3
45	80B45	14.900	B	1 ¹ / ₁₆	3 ¹ / ₁₆	4 ¹ / ₁₆	2	31.4	A	80A45	1 ¹ / ₁₆	25.2
46	80B46	15.220	B	1 ¹ / ₁₆	3 ¹ / ₁₆	4 ¹ / ₁₆	2	33.1	A	80A46	1 ¹ / ₁₆	26.6
47	80B47	15.540	B	1 ¹ / ₁₆	3 ¹ / ₁₆	4 ¹ / ₁₆	2	34.0	A	80A47	1 ¹ / ₁₆	26.4
48	80B48	15.860	B	1 ¹ / ₁₆	3 ¹ / ₁₆	4 ¹ / ₁₆	2	35.5	A	80A48	1 ¹ / ₁₆	27.8
49	80B49	16.180	B	1 ¹ / ₁₆	3 ¹ / ₁₆	4 ¹ / ₁₆	2	35.8	A	80A49	1 ¹ / ₁₆	28.9
50	80B50	16.500	B	1 ¹ / ₁₆	3 ¹ / ₁₆	4 ¹ / ₁₆	2	37.3	A	80A50	1 ¹ / ₁₆	30.9
51	80B51	16.810	B	1 ¹ / ₁₆	3 ¹ / ₁₆	4 ¹ / ₁₆	2	38.6	A	80A51	1 ¹ / ₁₆	32.2
52	80B52	17.130	B	1 ¹ / ₁₆	3 ¹ / ₁₆	4 ¹ / ₁₆	2	39.4	A	80A52	1 ¹ / ₁₆	33.0
53	80B53	17.450	B	1 ¹ / ₁₆	3 ¹ / ₁₆	4 ¹ / ₁₆	2	41.3	A	80A53	1 ¹ / ₁₆	34.9
54	80B54	17.770	B	1 ¹ / ₁₆	3 ¹ / ₁₆	5 ¹ / ₁₆	2	44.7	A	80A54	1 ¹ / ₁₆	36.6
55	80B55	18.090	B	1 ¹ / ₁₆	3 ¹ / ₁₆	5 ¹ / ₁₆	2	45.6	A	80A55	1 ¹ / ₁₆	37.5
56	80B56	18.410	B	1 ¹ / ₁₆	3 ¹ / ₁₆	5 ¹ / ₁₆	2	47.5	A	80A56	1 ¹ / ₁₆	39.4
57	80B57	18.730	B	1 ¹ / ₁₆	3 ¹ / ₁₆	5 ¹ / ₁₆	2	48.5	A	80A57	1 ¹ / ₁₆	40.4
58	80B58	19.040	B	1 ¹ / ₁₆	3 ¹ / ₁₆	5 ¹ / ₁₆	2	50.5	A	80A58	1 ¹ / ₁₆	41.3
59	80B59	19.360	B	1 ¹ / ₁₆	3 ¹ / ₁₆	5 ¹ / ₁₆	2	52.1	A	80A59	1 ¹ / ₁₆	42.9
60	80B60	19.680	B	1 ¹ / ₁₆	3 ¹ / ₁₆	5 ¹ / ₁₆	2	54.5	A	80A60	1 ¹ / ₁₆	45.3
65	80B65	21.270	B	1 ¹ / ₁₆	3 ¹ / ₁₆	5 ¹ / ₁₆	2	61.8	A	80A65	1 ¹ / ₁₆	52.2
70	80C70	22.870	C	1 ¹ / ₁₆	4 ¹ / ₁₆	6 ¹ / ₁₆	3 ¹ / ₁₆	75.7	A	80A70	1 ¹ / ₁₆	59.8
72	80C72	23.500	C	1 ¹ / ₁₆	4 ¹ / ₁₆	6 ¹ / ₁₆	3 ¹ / ₁₆	81.4	A	80A72	1 ¹ / ₁₆	65.7
76	80C76	24.780	C	1 ¹ / ₁₆	4 ¹ / ₁₆	6 ¹ / ₁₆	3 ¹ / ₁₆	87.8	A	80A76	1 ¹ / ₁₆	70.2
80	80C80	26.050	C	1 ¹ / ₁₆	4 ¹ / ₁₆	6 ¹ / ₁₆	3 ¹ / ₁₆	89.9	A	80A80	1 ¹ / ₁₆	79.6
84	80C84	27.330	C	1 ¹ / ₁₆	4 ¹ / ₁₆	6 ¹ / ₁₆	3 ¹ / ₁₆	99.2	A	80A84	1 ¹ / ₁₆	86.1
90	80C90	29.240	C	1 ¹ / ₁₆	4 ¹ / ₁₆	6 ¹ / ₁₆	3 ¹ / ₁₆	106	A	80A90	1 ¹ / ₁₆	101
96	80C96	31.150	C	1 ¹ / ₁₆	4 ¹ / ₁₆	6 ¹ / ₁₆	3 ¹ / ₁₆	117	A	80A96	1 ¹ / ₁₆	120
112	80C112	36.240	C	1 ¹ / ₁₆	4 ¹ / ₁₆	6 ¹ / ₁₆	3 ¹ / ₁₆	154	A	80A112	1 ¹ / ₁₆	165

★ Has recessed groove in hub for chain clearance.

Maximum bores shown will accommodate standard keyseat and setscrew over keyseat. Slightly larger bores are possible with no keyseat, shallow keyseat, or setscrew at angle to keyseat.

No. 80 1" Pitch

All Steel Stock Sprockets



Single-Type QD With Hardened Teeth

No. Teeth	Catalog Number
11	80SH11H
12	80SH12H
13	80SDS13H
14	80SDS14H
15	80SK15H
16	80SK16H
17	80SK17H
18	80SK18H
19	80SK19H
20	80SF20H
21	80SF21H
22	80SF22H
23	80SF23H
24	80SF24H
25	80SF25H
26	80SF26H
27	80SF27H
28	80SF28H
30	80SF30H

**SABER
TOOTH®**

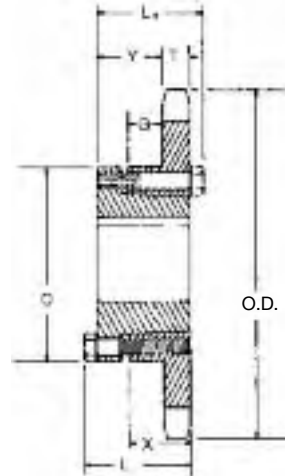

QD — TYPE B

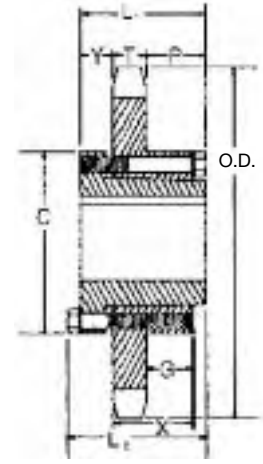

QD — TYPE C

SPROCKETS

Single-Type QD

No. Teeth	Catalog Number	Bush- ing	Diameters		Type	Max. Bore	Dimensions							Weight (Approx.)		
			Outside Diameter	Pitch Diameter			L ₁	L ₂	C	Y	P	G	X	T	With Hub	Rim Only
11	80SH11	SH	4.010	3.550	B	1 $\frac{1}{8}$	1 $\frac{1}{16}$	1 $\frac{1}{16}$	2 $\frac{1}{16}$	2 $\frac{1}{32}$		1 $\frac{5}{64}$	1 $\frac{3}{16}$.575	2.0	1.0
12	80SH12	SH	4.330	3.864	B	1 $\frac{1}{8}$	1 $\frac{1}{16}$	1 $\frac{1}{16}$	2 $\frac{1}{16}$	2 $\frac{1}{32}$		1 $\frac{5}{64}$	1 $\frac{3}{16}$.575	2.4	1.4
13	80SDS13	SDS	4.660	4.179	B	2	1 $\frac{1}{2}$	1 $\frac{1}{2}$	3 $\frac{3}{16}$	4 $\frac{1}{64}$		1 $\frac{1}{64}$	3 $\frac{1}{4}$.575	2.5	1.5
14	80SDS14	SDS	4.980	4.494	B	2	1 $\frac{1}{2}$	1 $\frac{1}{2}$	3 $\frac{3}{16}$	4 $\frac{1}{64}$		1 $\frac{1}{64}$	3 $\frac{1}{4}$.575	2.8	1.8
15	80SK15	SK	5.300	4.810	B	2 $\frac{1}{8}$	2 $\frac{1}{8}$	2 $\frac{1}{8}$	3 $\frac{1}{8}$	1 $\frac{1}{64}$		2 $\frac{1}{32}$	1 $\frac{1}{4}$.575	4.5	2.5
16	80SK16	SK	5.630	5.126	B										5.1	3.1
17	80SK17	SK	5.950	5.442	B										5.5	3.5
18	80SK18	SK	6.270	5.759	B										5.9	3.9
19	80SK19	SK	6.590	6.076	B	2 $\frac{1}{8}$	2 $\frac{1}{8}$	2 $\frac{1}{8}$	3 $\frac{1}{8}$	1 $\frac{1}{64}$		2 $\frac{1}{32}$	1 $\frac{1}{4}$.575	6.4	4.4
20	80SF20	SF	6.910	6.392	B	2 $\frac{1}{16}$	2 $\frac{1}{4}$	2 $\frac{1}{4}$	4 $\frac{1}{8}$	1 $\frac{27}{64}$		2 $\frac{1}{32}$	1 $\frac{1}{4}$.575	8.3	5.3
21	80SF21	SF	7.240	6.710	B										8.7	5.7
22	80SF22	SF	7.560	7.027	B										9.3	6.3
23	80SF23	SF	7.880	7.344	B										9.8	6.8
24	80SF24	SF	8.200	7.661	B										10.5	7.5
25	80SF25	SF	8.520	7.979	B										11.0	8.0
26	80SF26	SF	8.840	8.296	B										11.6	8.6
27	80SF27	SF	9.160	8.614	B										12.4	9.4
28	80SF28	SF	9.480	8.931	B										13.2	10.2
30	80SF30	SF	10.110	9.567	B										14.3	11.3
32	80SF32	SF	10.750	10.202	B										16.0	13.0
33	80SF33	SF	11.070	10.520	B										16.5	13.5
34	80SF34	SF	11.390	10.838	B										17.1	14.1
35	80SF35	SF	11.710	11.156	B										18.5	15.5
36	80SF36	SF	12.030	11.474	B										19.9	16.9
40	80SF40	SF	13.310	12.746	B										23.6	20.6
42	80SF42	SF	13.940	13.382	B										25.4	22.4
45	80SF45	SF	14.900	14.336	B										28.1	25.1
48	80SF48	SF	15.860	15.290	B										31.6	28.6
54	80SF54	SF	17.770	17.198	B										39.8	36.8
60	80SF60	SF	19.680	19.107	B	2 $\frac{1}{16}$	2 $\frac{1}{4}$	2 $\frac{1}{4}$	4 $\frac{1}{8}$	1 $\frac{27}{64}$		2 $\frac{1}{32}$	1 $\frac{1}{4}$.575	48.8	45.8
70	80E70	E	22.870	22.289	C	3 $\frac{1}{2}$	2 $\frac{1}{8}$	2 $\frac{1}{16}$	6	1 $\frac{1}{8}$	1 $\frac{1}{16}$	1 $\frac{3}{64}$	1 $\frac{1}{8}$.575	65.6	55.6
72	80E72	E	23.500	22.926	C										69.3	59.3
80	80E80	E	26.050	25.471	C										79.2	69.2
84	80E84	E	27.330	26.744	C										84.9	74.9
96	80E96	E	31.150	30.563	C	3 $\frac{1}{2}$	2 $\frac{1}{8}$	2 $\frac{1}{16}$	6	1 $\frac{1}{8}$	1 $\frac{1}{16}$	1 $\frac{3}{64}$	1 $\frac{1}{8}$.575	108	97.5
112	80F112	F	36.240	35.655	C	3 $\frac{1}{16}$	3 $\frac{1}{8}$	4	6 $\frac{1}{8}$	1	2 $\frac{1}{16}$	1 $\frac{3}{64}$	2 $\frac{1}{2}$.575	145	134

S
A
B
E
R

T
O
O
T
®

Single-Taper Bushed with Hardened Teeth

No. Teeth	Catalog Number
10	80BTB10H
11	80BTB11H
12	80BTB12H
13	80BTB13H
14	80BTB14H
15	80BTB15H
16	80BTB16H
17	80BTB17H
18	80BTB18H
19	80BTB19H
20	80BTB20H
21	80BTB21H
22	80BTB22H
23	80BTB23H
24	80BTB24H
25	80BTB25H
26	80BTB26H
27	80BTB27H
28	80BTB28H
30	80BTB30H

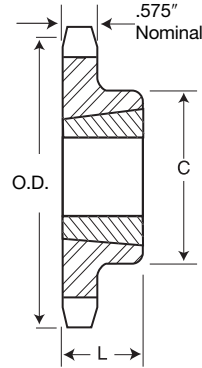

TYPE B



SPROCKETS

Single-Taper Bushed

No. Teeth	Catalog Number	Bushing	Diameter		Max. Bore	Dimensions		Type	Weight (Approx.)	
			Outside Diameter	Pitch Diameter		L	C		Rim Only	Bushing Only
10	80BTB10	1215	3.678	3.236	1 1/4	1 1/2	2 3/8*	B	1.1	.8
11	80BTB11	1215	4.006	3.549	1 1/4	1 1/2	2 3/8*	B	1.5	.8
12	80BTB12	1615	4.332	3.864	1 1/2	1 1/2	3*	B	1.8	1.2
13	80BTB13	1615	4.657	4.179	1 1/2	1 1/2	3	B	2.3	1.2
14	80BTB14	1615	4.982	4.494	1 1/2	1 1/2	3 1/2	B	2.5	1.2
15	80BTB15	1615	5.305	4.810	1 1/2	1 1/2	3 1/2	B	2.7	1.2
16	80BTB16	2012	5.627	5.126	2	1 1/4	4	B	2.8	1.7
17	80BTB17	2012	5.950	5.442	2	1 1/4	4	B	3.1	1.7
18	80BTB18	2012	6.271	5.759	2	1 1/4	3 5/8	B	2.6	1.7
19	80BTB19	2012	6.593	6.076	2	1 1/4	3 5/8	B	4.1	1.7
20	80BTB20	2517	6.914	6.392	2 1/2	1 1/4	4 1/4	B	5.5	1.7
21	80BTB21	2517	7.235	6.710	2 1/2	1 1/4	4 1/4	B	6.0	3.5
22	80BTB22	2517	7.555	7.027	2 1/2	1 1/4	4 1/4	B	6.5	3.5
23	80BTB23	2517	7.875	7.344	2 1/2	1 1/4	4 1/4	B	7.0	3.5
24	80BTB24	2517	8.196	7.661	2 1/2	1 1/4	4 1/4	B	7.5	3.5
25	80BTB25	2517	8.516	7.979	2 1/2	1 1/4	4 1/4	B	8.1	3.5
26	80BTB26	2517	8.836	8.296	2 1/2	1 1/4	4 1/4	B	8.8	3.5
27	80BTB27	2517	9.156	8.614	2 1/2	1 1/4	4 1/4	B	9.0	3.5
28	80BTB28	2517	9.475	8.931	2 1/2	1 1/4	4 1/4	B	9.5	3.5
30	80BTB30	2517	10.114	9.567	2 1/2	1 1/4	4 1/4	B	11.5	3.5
32	80BTB32	2517	10.753	10.202	2 1/2	1 1/4	4 1/4	B	12.0	3.5
35	80BTB35	2517	11.711	11.156	2 1/2	1 1/4	4 1/4	B	15.2	3.5
36	80BTB36	2517	12.030	11.474	2 1/2	1 1/4	4 1/4	B	17.0	3.5
40	80BTB40	2517	13.306	12.746	2 1/2	1 1/4	4 1/4	B	21.0	3.5
45	80BTB45	2517	14.901	14.336	2 1/2	1 1/4	4 1/4	B	26.5	3.5
48	80BTB48	2517	15.857	15.290	2 1/2	1 1/4	4 1/4	B	29.5	3.5
54	80BTB54	2517	17.769	17.198	2 1/2	1 1/4	4 1/4	B	38.5	3.5
60	80BTB60	2517	19.681	19.107	2 1/2	1 1/4	4 1/4	B	45.0	3.5
70	80BTB70	3020	22.867	22.289	3	2	5 1/2	B	52.3	6.5
80	80BTB80	3020	26.052	25.471	3	2	5 1/2	B	69.2	6.5

* Has recessed groove in hub for chain clearance.

No. 80 1" Pitch

MST® Sprockets

Martin

Single - MST® Sprockets

No. Teeth	Catalog Number	Bush-ing	Diameters		Type	Max. Bore	Dimensions						Weight (Approx.)	
			Outside Dia.	Pitch Dia.			OL	L	C	H	P	T(nom)	With Hub	Rim Only
10	80H10H	H	3.680	3.236	3	1-1/2	2-3/32	11/4	21/32	2-1/2	1-21/64	.575	2.8	2.0
11	80H11H	H	4.010	3.550	3	1-1/2	1-1/2	1-1/4	1/16	2-1/2	3/4	.575	2.1	1.3
11	80P11H	P	4.010	3.550	4	1-3/4	2-11/32	1-15/16	5/32	3	1-17/32	.575	2.4	1.6
12	80P12H	P1	4.330	3.864	4	1-3/4	2-3/16	1-15/16	0	3	1-3/8	.575	3.3	2.0
13	80P13H	P1	4.660	4.179	4	1-3/4	2-3/16	1-15/16	0	3	1-3/8	.575	3.7	2.4
14	80P14H	P1	4.980	4.494	4	1-3/4	2-3/16	1-15/16	0	3	1-3/8	.575	3.9	2.6
14	80Q14H	Q1	4.980	4.494	4	2-11/16	2-25/32	2-1/2	0	4-1/8	1-15/16	.575	6.4	2.9
15	80P15H	P1	5.300	4.810	4	1-3/4	2-3/16	1-15/16	0	3	1-3/8	.575	4.3	3.0
15	80Q15H	Q1	5.300	4.810	4	2-11/16	2-25/32	2-1/2	0	4-1/8	1-15/16	.575	6.9	3.4
16	80P16H	P1	5.630	5.126	4	1-3/4	2-3/16	1-15/16	0	3	1-3/8	.575	4.8	3.5
16	80Q16H	Q1	5.630	5.126	4	2-11/16	2-25/32	2-1/2	0	4-1/8	1-15/16	.575	8.1	4.6
17	80P17H	P1	5.950	5.442	4	1-3/4	2-3/16	1-15/16	0	3	1-3/8	.575	5.1	3.8
17	80Q17H	Q1	5.950	5.442	4	2-11/16	2-25/32	2-1/2	0	4-1/8	1-15/16	.575	8.8	5.3
18	80P18H	P1	6.270	5.759	4	1-3/4	2-3/16	1-15/16	0	3	1-3/8	.575	5.7	4.4
18	80Q18H	Q1	6.270	5.759	4	2-11/16	2-25/32	2-1/2	0	4-1/8	1-15/16	.575	9.5	6.0
19	80P19H	P1	6.590	6.076	4	1-3/4	2-3/16	1-15/16	0	3	1-3/8	.575	6.2	4.9
19	80Q19H	Q1	6.590	6.076	4	2-11/16	2-25/32	2-1/2	0	4-1/8	1-15/16	.575	10.0	6.5
20	80Q20H	Q1	6.910	6.392	4	2-11/16	2-25/32	2-1/2	0	4-1/8	1-15/16	.575	10.5	7.0
21	80Q21H	Q1	7.240	6.710	4	2-11/16	2-25/32	2-1/2	0	4-1/8	1-15/16	.575	10.8	7.3
22	80Q22H	Q1	7.560	7.027	4	2-11/16	2-25/32	2-1/2	0	4-1/8	1-15/16	.575	11.7	8.2
23	80Q23H	Q1	7.880	7.344	4	2-11/16	2-25/32	2-1/2	0	4-1/8	1-15/16	.575	12.3	8.8
24	80Q24H	Q1	8.200	7.661	4	2-11/16	2-25/32	2-1/2	0	4-1/8	1-15/16	.575	12.6	9.1
25	80Q25H	Q1	8.520	7.979	4	2-11/16	2-25/32	2-1/2	0	4-1/8	1-15/16	.575	13.1	9.6
26	80Q26H	Q1	8.840	8.296	4	2-11/16	2-25/32	2-1/2	0	4-1/8	1-15/16	.575	14.1	10.6
27	80Q27H	Q1	9.160	8.614	4	2-11/16	2-25/32	2-1/2	0	4-1/8	1-15/16	.575	14.4	10.9
28	80Q28H	Q1	9.480	8.931	4	2-11/16	2-25/32	2-1/2	0	4-1/8	1-15/16	.575	15.9	12.4
29	80Q29H	Q1	9.800	9.249	4	2-11/16	2-25/32	2-1/2	0	4-1/8	1-15/16	.575	16.1	12.6
30	80Q30H	Q1	10.110	9.567	4	2-11/16	2-25/32	2-1/2	0	4-1/8	1-15/16	.575	16.9	13.4
31	80Q31	Q1	10.430	9.885	4	2-11/16	2-25/32	2-1/2	0	4-1/8	1-15/16	.575	17.4	13.9
32	80Q32	Q1	10.750	10.202	4	2-11/16	2-25/32	2-1/2	0	4-1/8	1-15/16	.575	18.3	14.8
33	80Q33	Q1	11.070	10.520	4	2-11/16	2-25/32	2-1/2	0	4-1/8	1-15/16	.575	19.0	15.5
34	80Q34	Q1	11.390	10.838	4	2-11/16	2-25/32	2-1/2	0	4-1/8	1-15/16	.575	19.8	16.3
35	80Q35	Q1	11.710	11.156	4	2-11/16	2-25/32	2-1/2	0	4-1/8	1-15/16	.575	21.3	17.8
36	80Q36	Q1	12.030	11.474	4	2-11/16	2-25/32	2-1/2	0	4-1/8	1-15/16	.575	21.6	18.1
36	80R36	R1	12.030	11.474	4	3-3/4	3-5/32	2-7/8	0	5-3/8	2 5/16	.575	27.0	19.5
37	80Q37	Q1	12.350	11.792	4	2-11/16	2-25/32	2-1/2	0	4-1/8	1-15/16	.575	22.0	18.5
38	80Q38	Q1	12.670	12.110	4	2-11/16	2-25/32	2-1/2	0	4-1/8	1-15/16	.575	23.5	20.0
39	80R39	R1	12.990	12.428	4	3-3/4	3-5/32	2-7/8	0	5-3/8	2 5/16	.575	30.3	22.8
40	80Q40	Q1	13.310	12.746	4	2-11/16	2-25/32	2-1/2	0	4-1/8	1-15/16	.575	25.4	21.9
40	80R40	R1	13.310	12.746	4	3-3/4	3-5/32	2-7/8	0	5-3/8	2 5/16	.575	30.9	23.4
41	80R41	R1	13.630	13.064	4	3-3/4	3-5/32	2-7/8	0	5-3/8	2 5/16	.575	31.4	23.9
42	80Q42	Q1	13.940	13.382	4	2-11/16	2-25/32	2-1/2	0	4-1/8	1-15/16	.575	27.3	23.8
42	80R42	R1	13.940	13.382	4	3-3/4	3-5/32	2-7/8	0	5-3/8	2 5/16	.575	32.9	25.4
44	80R44	R1	14.580	14.018	4	3-3/4	3-5/32	2-7/8	0	5-3/8	2 5/16	.575	34.7	27.2
45	80Q45	Q1	14.900	14.336	4	2-11/16	2-25/32	2-1/2	0	4-1/8	1-15/16	.575	31.3	27.8
45	80R45	R1	14.900	14.336	4	3-3/4	3-5/32	2-7/8	0	5-3/8	2 5/16	.575	36.0	28.5
47	80R47	R1	15.540	14.972	4	3-3/4	3-5/32	2-7/8	0	5-3/8	2 5/16	.575	38.5	31.0
48	80Q48	Q1	15.860	15.290	4	2-11/16	2-25/32	2-1/2	0	4-1/8	1-15/16	.575	34.3	30.8
48	80R48	R1	15.860	15.290	4	3-3/4	3-5/32	2-7/8	0	5-3/8	2 5/16	.575	39.8	32.3
50	80R50	R1	16.500	15.926	4	3-3/4	3-5/32	2-7/8	0	5-3/8	2 5/16	.575	42.6	35.1
54	80Q54	Q1	17.770	17.198	4	2-11/16	2-25/32	2-1/2	0	4-1/8	1-15/16	.575	42.0	38.5
54	80R54	R1	17.770	17.198	4	3-3/4	3-5/32	2-7/8	0	5-3/8	2 5/16	.575	48.3	40.8
56	80R56	R1	18.410	17.835	4	3-3/4	3-5/32	2-7/8	0	5-3/8	2 5/16	.575	51.5	44.0
60	80Q60	Q1	19.680	19.107	4	2-11/16	2-25/32	2-1/2	0	4-1/8	1-15/16	.575	50.3	46.8
60	80R60	R1	19.680	19.107	4	3-3/4	3-5/32	2-7/8	0	5-3/8	2 5/16	.575	54.8	47.3
70	80Q70	Q1	22.870	22.289	4	2-11/16	2-25/32	2-1/2	0	4-1/8	2 5/16	.575	63.5	60.0
70	80R70	R1	22.870	22.289	4	3-3/4	3-5/32	2-7/8	0	5-3/8	2 5/16	.575	71.0	63.5
72	80Q72	Q1	23.500	22.926	4	2-11/16	2-25/32	2-1/2	0	4-1/8	2 5/16	.575	71.0	67.5
72	80R72	R1	23.500	22.926	5	3-3/4	3-5/32	2-7/8	1-7/16	5-3/8	7/8	.575	76.9	69.4
80	80R80	R1	26.050	25.471	5	3-3/4	3-5/32	2-7/8	1-7/16	5-3/8	7/8	.575	92.5	85.0
84	80R84	R1	27.330	26.744	5	3-3/4	3-5/32	2-7/8	1-7/16	5-3/8	7/8	.575	97.5	90.0
96	80R96	R1	31.150	30.563	5	3-3/4	3-5/32	2-7/8	1-7/16	5-3/8	7/8	.575	117.5	110.0
112	80S112	S1	36.240	36.655	5	4-1/4	4-3/4	4-3/8	2 3/4	6-3/8	1-1/8	.575	178.5	165.0

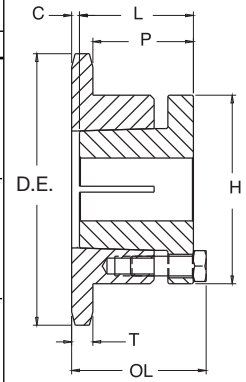

TIPO 3

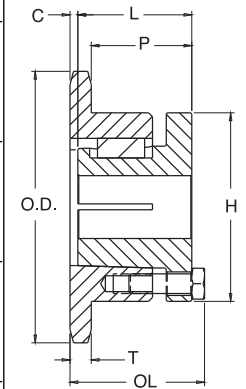

TYPE 4

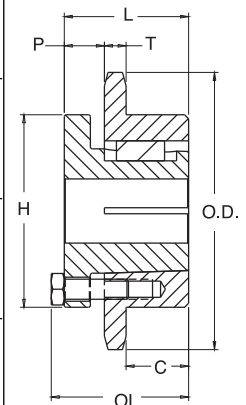

TYPE 5

Sprockets with "H" suffix have hardened teeth.

Double-Type B & C

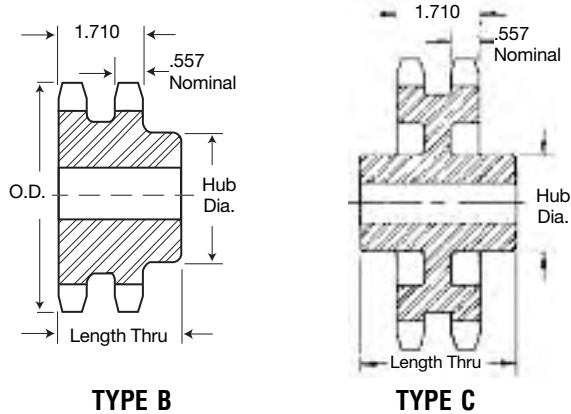

TYPE B

TYPE C

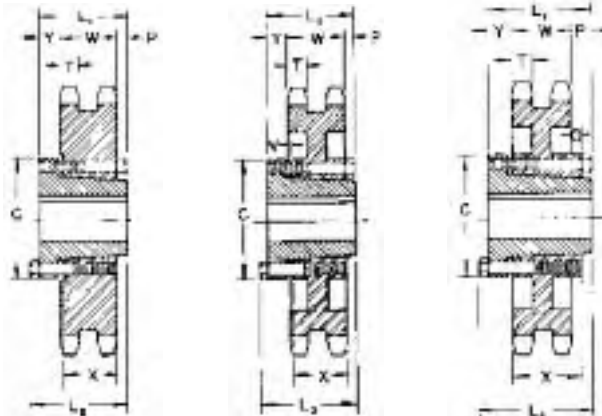

QD — TYPE C₁

QD — TYPE C₃

QD — TYPE C₄

No. Teeth	Catalog Number	Outside Diameter	Type	Bore (inches)		Hub (inches)		Weight Lbs. (Approx.)
				Stock	Rec. Max.	Dia.	Length Thru	
10	D80B10H	3.680	B	1	1½	2⅞*	2½	3.6
11	D80B11H	4.010	B	1	1¾	2½	2½	4.0
12	D80B12H	4.330	B	1	1⅞	2⅞	2½	5.1
13	D80B13H	4.660	B	1	2¼	3⅞	2½	6.3
14	D80B14H	4.980	B	1	2½	3⅞	2½	7.6
15	D80B15H	5.300	B	1	2⅞	3⅞	2½	9.0
16	D80B16H	5.630	B	1	3¼	4	2½	11.0
17	D80B17H	5.950	B	1	3	4⅞	2½	13.2
18	D80B18H	6.270	B	1	3¼	4⅞	2½	15.0
19	D80B19H	6.590	B	1	3⅞	5	2½	17.0
20	D80B20H	6.910	B	1	3⅞	5	2½	18.2
21	D80B21H	7.240	B	1	3⅞	5	2½	19.6
22	D80B22H	7.560	B	1	3⅞	5	2½	21.0
23	D80B23H	7.880	B	1	3⅞	5	2½	22.8
24	D80B24H	8.200	B	1	3½	5½	2½	25.1
25	D80B25H	8.520	B	1	3½	5½	3	28.3
26	D80B26	8.840	B	1	3½	5½	3	29.9
30	D80B30	10.110	B	1¼	3¾	5¾	3	39.5
32	D80B32	10.750	B	1¼	3¾	5¾	3	43.8
35	D80B35	11.710	B	1¼	3¾	5¾	3	49.1
36	D80B36	12.030	B	1¼	3¾	5¾	3¾	54.2
42	D80B42	13.940	B	1¼	3¾	5¾	3¾	71.5
45	D80B45	14.900	B	1¼	3¾	5¾	3¾	73.5
52	D80C52	17.130	C	1½	3¾	5¾	3¾	78.4
60	D80C60	19.680	C	1½	3¾	5¾	3¾	93.3
68	D80C68	22.230	C	1½	3⅞	6	4	96.2
76	D80C76	24.780	C	1½	3⅞	6	4	113
95	D80C95	30.830	C	1½	4	6	4¼	165

* Has recessed groove in hub for chain clearance.

Maximum bores shown will accommodate standard keyseat and setscrew over keyseat. Slightly larger bores are possible with no keyseat, shallow keyseat, or setscrew at angle to keyseat.

NOTE: Double 80 stock sprockets with 25 teeth or less have hardened teeth. As indicated by H suffix.

Alteration Charges

See current discount sheet for alteration charges.

Double-Type QD

No. Teeth	Catalog Number	Bush-ing	Diameters		Type	Max. Bore	Dimensions										Weight (Approx.)	
			Outside Diameter	Pitch Diameter			L ₁	L ₂	C	Y	P	G	V	X	T	W	With Hub	Rim Only
36	D80E36	E	12.030	11.474	C1	3½	2%	2⅞	6	5/64	½			1%	.557	1.710	48.3	38.2
42	D80E42	E	13.940	13.382	C1	3½	2%	2⅞	6	5/64	½			1%	.557	1.710	65.3	55.3
45	D80E45	E	14.900	14.336	C1	3½	2%	2⅞	6	5/64	½			1%	.557	1.710	74.6	64.6
52	D80E52	E	17.130	16.562	C3	3½	2%	2⅞	6	5/64	½		3/32	1%	.557	1.710	68.2	58.2
60	D80E60	E	19.680	19.107	C3	3½	2%	2⅞	6	5/64	½		3/32	1%	.557	1.710	78.2	68.2
68	D80E68	E	22.230	21.653	C3	3½	2%	2⅞	6	5/64	½		3/32	1%	.557	1.710	84.2	74.2
76	D80E76	E	24.780	24.198	C3	3½	2%	2⅞	6	5/64	½		3/32	1%	.557	1.710	100	90.1
95	D80F95	F	30.830	30.245	C4	3⅞	3%	4	6%	1	5/64	5/64		2½	.557	1.710	152	140

SPROCKETS

No. 80-2 1" Pitch

All Steel Stock Sprockets



SPROCKETS

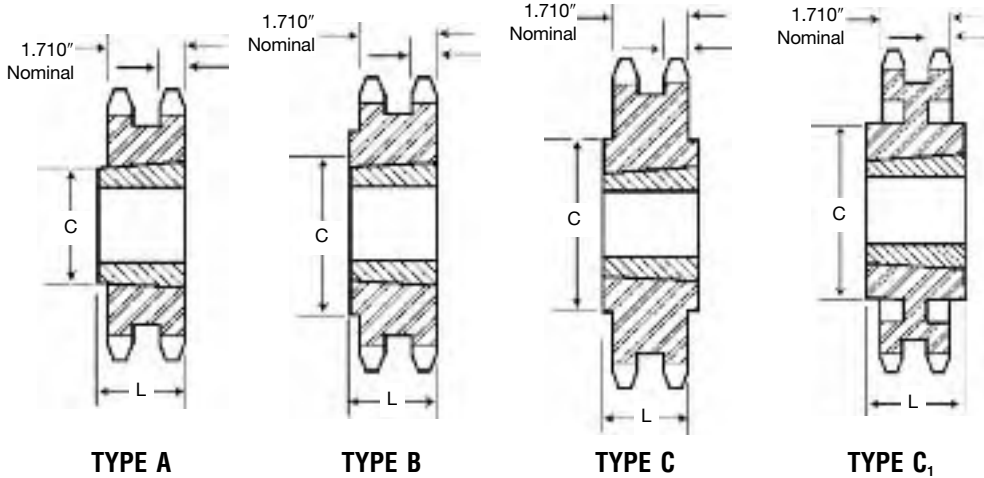

Double-Taper Bushed

No. Teeth	Catalog Number	Bushing	Diameter		Max. Bore	Dimensions		Type	Weight (Approx.)	
			Outside Diameter	Pitch Diameter		L	C		Rim Only	Bushing Only
13	D80ATB13H	1615	4.657	4.179	1%	1½		A	3.4	1.2
14	D80ATB14H	2012	4.982	4.494	2	1½		A	3.5	1.7
15	D80ATB15H	2012	5.305	4.810	2	1½		A	4.3	1.7
16	D80ATB16H	2517	5.627	5.126	2½	1½	3%	A	3.8	3.5
17	D80ATB17H	2517	5.950	5.442	2½	1½	3%	A	5.1	3.5
18	D80ATB18H	2517	6.271	5.759	2½	1½	3%	A	6.4	3.5
19	D80BTB19H	3020	6.593	6.076	3	2	5	B	5.6	6.5
20	D80BTB20H	3020	6.914	6.392	3	2	5½	B	7.1	6.5
21	D80BTB21H	3020	7.235	6.710	3	2	5¾	B	8.9	6.5
25	D80BTB25H	3020	8.516	7.979	3	2	6½	B	16.5	6.5
30	D80CTB30	3020	10.114	9.567	3	2	5½	C	25.1	6.5
36	D80CTB36	3020	12.030	11.474	3	2	5½	C	39.4	6.5
42	D80CTB42	3020	13.944	13.392	3	2	5½	C	36.4	6.5
45	D80CTB45	3020	14.901	14.336	3	2	5½	C1	41.4	6.5
52	D80CTB52	3020	17.132	16.562	3	2	5½	C1	56.2	6.5
60	D80CTB60	3020	19.681	19.107	3	2	5½	C1	66.3	6.5
68	D80CTB68	3020	22.230	21.653	3	2	5½	C1	72.0	6.5
76	D80CTB76	3020	24.778	24.198	3	2	5½	C1	89.1	6.5
95	D80CTB95	3020	30.828	30.245	3	2	5½	C1	112	6.5

NOTE: Double 80 stock sprockets with 25 teeth or less have hardened teeth. As indicated by H suffix.

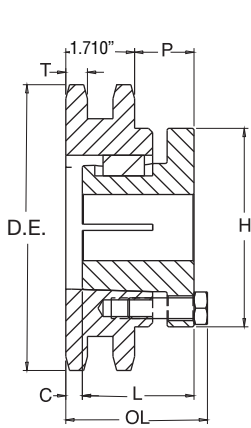

TIPO 12

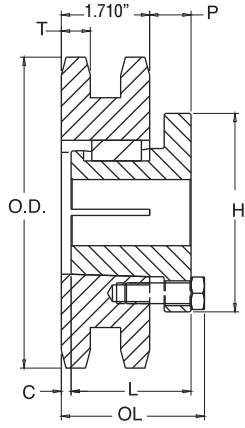

TYPE 13

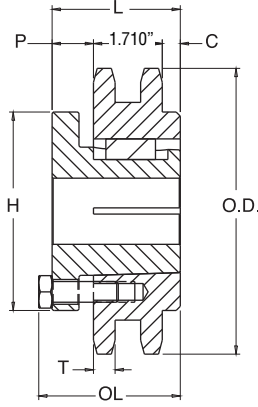

TYPE 15

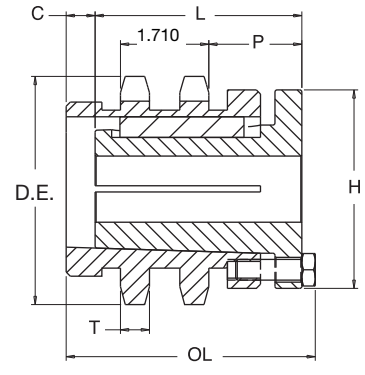

TIPO 16

Double- MST[®] Sprockets

No. Teeth	Catalog Number	Bush- ing	Diameters		Type	Max. Bore	Dimensions						Weight (Approx.)	
			Outside Dia.	Pitch Dia.			OL	L	C	H	P	T(nom)	With Hub	Rim Only
13	D80P13H	P1	4.660	4.179	13	1-3/4	2-19/32	1-15/16	13/32	3	5/8	.557	4.9	3.6
14	D80Q14H	Q2	4.980	4.494	16	2-5/8	4 5/8	3-1/2	27/32	4-1/8	1-3/4	.557	9.9	5.4
15	D80Q15H	Q2	5.300	4.810	12	2-5/8	3-25/32	3-1/2	0	4-1/8	13/4	.557	9.9	5.4
16	D80Q16H	Q1	5.630	5.126	13	2-11/16	2-25/32	2-1/2	0	4-1/8	3/4	.557	8.3	4.8
17	D80Q17H	Q1	5.950	5.442	13	2-11/16	2-25/32	2-1/2	0	4-1/8	3/4	.557	9.5	6.0
18	D80Q18H	Q1	6.270	5.759	13	2-11/16	2-25/32	2-1/2	0	4-1/8	3/4	.557	10.8	7.3
19	D80Q19H	Q1	6.590	6.076	13	2-11/16	2-25/32	2-1/2	0	4-1/8	3/4	.557	12.0	8.5
20	D80R20H	R1	6.910	6.392	12	3-3/4	3-5/32	2-7/8	0	5-3/8	1-5/32	.557	15.3	7.8
21	D80R21H	R1	7.240	6.710	12	3-3/4	3-5/32	2-7/8	0	5-3/8	1-5/32	.557	16.9	9.4
22	D80R22H	R1	7.560	7.027	12	3-3/4	3-5/32	2-7/8	0	5-3/8	1-5/32	.557	18.3	10.8
23	D80R23H	R1	7.880	7.344	12	3-3/4	3-5/32	2-7/8	0	5-3/8	1-5/32	.557	19.8	12.3
24	D80R24H	R1	8.200	7.661	12	3-3/4	3-5/32	2-7/8	0	5-3/8	1-5/32	.557	21.6	14.1
25	D80R25H	R1	8.520	7.979	12	3-3/4	3-5/32	2-7/8	0	5-3/8	1-5/32	.557	23.3	15.8
26	D80R26	R1	8.840	8.296	12	3-3/4	3-5/32	2-7/8	0	5-3/8	1-5/32	.557	25.6	18.1
27	D80R27	R1	9.160	8.614	12	3-3/4	3-5/32	2-7/8	0	5-3/8	1-5/32	.557	27.9	20.4
28	D80R28	R1	9.480	8.931	12	3-3/4	3-5/32	2-7/8	0	5-3/8	1-5/32	.557	30.2	22.7
30	D80R30	R1	10.110	9.567	12	3-3/4	3-5/32	2-7/8	0	5-3/8	1-5/32	.557	34.3	26.8
36	D80R36	R1	12.030	11.474	12	3-3/4	3-5/32	2-7/8	0	5-3/8	1-5/32	.557	49.1	41.6
42	D80R42	R1	13.940	13.382	12	3-3/4	3-5/32	2-7/8	0	5-3/8	1-5/32	.557	65.5	58.0
45	D80R45	R1	14.900	14.336	12	3-3/4	3-5/32	2-7/8	0	5-3/8	1-5/32	.557	75.5	68.0
48	D80R48	R2	15.860	15.290	15	3-5/8	5-5/32	4-7/8	2-9/32	5-3/8	7/8	.557	97.0	86.0
52	D80R52	R2	17.130	16.562	15	3-5/8	5-5/32	4-7/8	2-9/32	5-3/8	7/8	.557	114.0	103.0
54	D80R54	R2	17.770	17.198	15	3-5/8	5-5/32	4-7/8	2-9/32	5-3/8	7/8	.557	122.0	111.0
60	D80R60	R2	19.680	19.107	15	3-5/8	5-5/32	4-7/8	2-9/32	5-3/8	7/8	.557	146.0	135.0
68	D80R68	R2	22.230	21.653	15	3-5/8	5-5/32	4-7/8	2-9/32	5-3/8	7/8	.557	187.0	176.0
72	D80R72	R2	23.500	22.926	15	3-5/8	5-5/32	4-7/8	2-9/32	5-3/8	7/8	.557	209.0	198.0
76	D80U76	U0	24.780	24.198	15	5-1/2	5-23/32	5-1/4	2-1/32	8-3/8	1-1/2	.557	249.0	219.0
95	D80U95	U0	30.830	30.245	15	5/12	5-23/32	5-1/4	2-1/32	8-3/8	1-1/2	.557	372.0	342.0

Sprockets with "H" suffix have hardened teeth.

No. 80-3 1" Pitch

All Steel Stock Sprockets



SPROCKETS

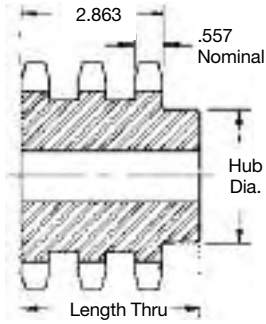

TYPE B

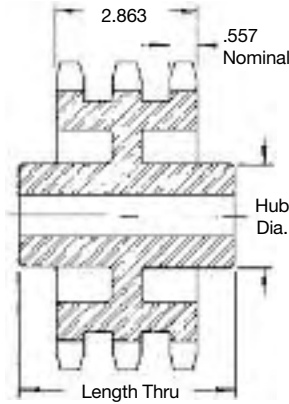

TYPE C

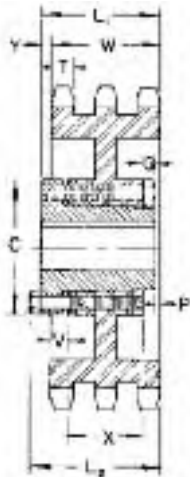

QD — TYPE B₁

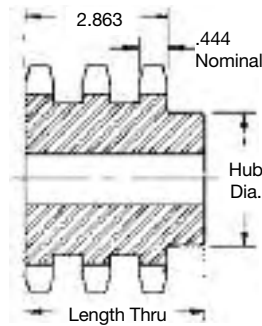

TYPE B

Triple-Type B & C

No. Teeth	Catalog Number	Outside Diameter	Type	Bore (inches)		Hub (inches)		Weight Lbs. (Approx.)
				Stock	Rec. Max.	Dia.	Length Thru	
11	E80B11H	4.010	B	1	1%	2½	3%	5.9
12	E80B12H	4.330	B	1	1%	2 ⁷ / ₃₂	3%	7.5
13	E80B13H	4.660	B	1	2%	3 ³ / ₃₂	3%	9.2
14	E80B14H	4.980	B	1	2%	3 ⁵ / ₃₂	3%	11.0
15	E80B15H	5.300	B	1	2½	3 ³ / ₁₆	3%	13.1
16	E80B16H	5.630	B	1	2½	4	3%	15.8
17	E80B17H	5.950	B	1	3	4 ⁷ / ₆₄	3%	18.6
18	E80B18H	6.270	B	1	3%	4 ⁴ / ₆₄	3%	21.2
19	E80B19H	6.590	B	1	3 ³ / ₁₆	5	3%	23.7
20	E80B20H	6.910	B	1	3 ³ / ₁₆	5	3%	26.0
21	E80B21H	7.240	B	1	3 ³ / ₁₆	5	3%	28.4
22	E80B22H	7.560	B	1	3 ³ / ₁₆	5	3%	31.0
23	E80B23H	7.880	B	1	3 ³ / ₁₆	5	3%	33.6
24	E80B24H	8.200	B	1	3½	5½	3%	37.1
25	E80B25H	8.520	B	1	3½	5½	3%	40.1
26	E80B26	8.840	B	1	3½	5½	3%	42.9
30	E80B30	10.110	B	1½	3%	5½	4%	54.5
35	E80B35	11.710	B	1½	3%	5½	4%	79.5
36	E80B36	12.030	B	1½	3%	5½	4%	83.9
42	E80C42	13.940	C	1½	3 ³ / ₁₆	6	4½	84.9
45	E80C45	14.900	C	1½	3 ³ / ₁₆	6	4½	92.4
52	E80C52	17.130	C	1½	3 ³ / ₁₆	6	4½	107
60	E80C60	19.680	C	1½	4%	6½	4%	128
68	E80C68	22.230	C	1½	4%	6½	4%	140
76	E80C76	24.780	C	1½	4%	6½	4%	165
95	E80C95	30.830	C	1½	4%	6½	5	240

Maximum bores shown will accommodate standard keyseat and setscrew over keyseat. Slightly larger bores are possible with no keyseat, shallow keyseat, or setscrew at angle to keyseat. As indicated by H suffix.

TYPE QD



NOTE: Triple 80 stock sprockets with 25 teeth or less have hardened teeth.

Alteration Charges

See current discount sheet for alteration charges.

Triple-Type QD

No. Teeth	Catalog Number	Bush-ing	Diameters		Type	Max. Bore	Dimensions										Weight (Approx.)	
			Outside Diameter	Pitch Diameter			L ₁	L ₂	C	Y	P	G	V	X	T	W	With Hub	Rim Only
36	E80E36	E	12.030	11.474	B	3½	3 ³ / ₁₆	3 ⁷ / ₁₆	6	¼	3 ³ / ₁₆	½	¾	1%	.557	2.863	65.1	55.1
42	E80E42	E	13.940	13.382	B	3½	3 ³ / ₁₆	3 ⁷ / ₁₆	6	¼	3 ³ / ₁₆	½	¾	1%	.557	2.863	81.9	71.9
45	E80E45	E	14.900	14.336	B1	3½	3 ³ / ₁₆	3 ⁷ / ₁₆	6	¼	3 ³ / ₁₆	½	¾	1%	.557	2.863	75.3	65.3
52	E80E52	E	17.130	16.562	B1	3½	3 ³ / ₁₆	3 ⁷ / ₁₆	6	¼	3 ³ / ₁₆	½	¾	1%	.557	2.863	90.0	80.0
60	E80F60	F	19.680	19.107	B1	3 ³ / ₁₆	3 ³ / ₁₆	4 ³ / ₁₆	6%	1 ³ / ₁₆	¾	½	¾	2%	.557	2.863	112	100
68	E80F68	F	22.230	21.653	B1	3 ³ / ₁₆	3 ³ / ₁₆	4 ³ / ₁₆	6%	1 ³ / ₁₆	¾	½	¾	2%	.557	2.863	132	120
76	E80F76	F	24.780	24.198	B1	3 ³ / ₁₆	3 ³ / ₁₆	4 ³ / ₁₆	6%	1 ³ / ₁₆	¾	½	¾	2%	.557	2.863	150	138
95	E80F95	F	30.830	30.245	B1	3 ³ / ₁₆	3 ³ / ₁₆	4 ³ / ₁₆	6%	1 ³ / ₁₆	¾	½	¾	2%	.557	2.863	208	196

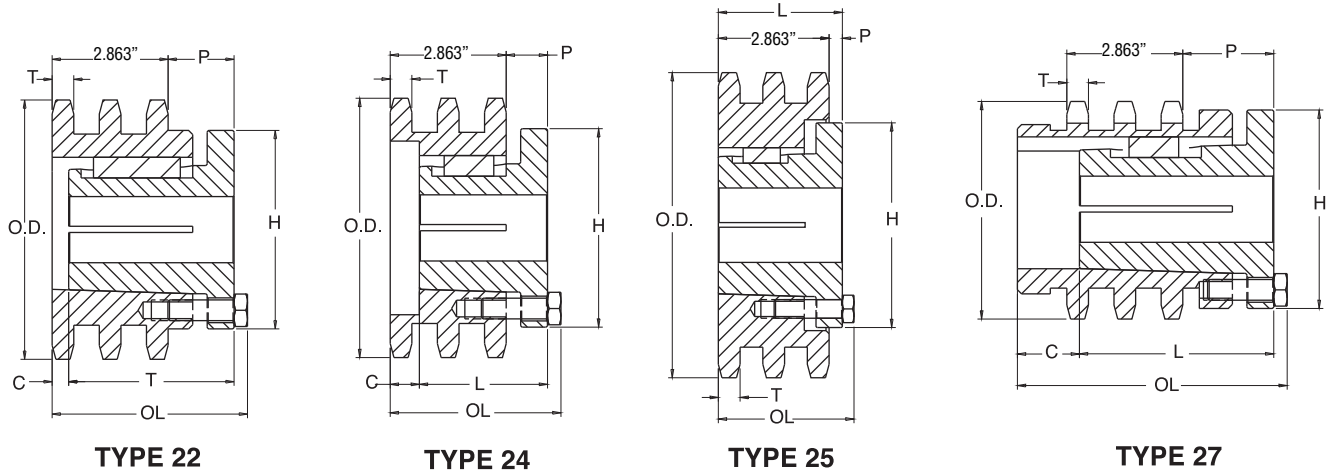

Triple - MST[®] Sprockets

No. Teeth	Catalog Number	Bush-ing	Diameters		Type	Max. Bore	Dimensions						Weight (Approx.)	
			Outside Dia.	Pitch Dia.			OL	L	C	H	P	T(nom)	With Hub	Rim Only
13	E80P13H	P2	4.660	4.179	24	1-3/4	3-3/4	2-15/16	9/16	3	5/8	.557	7.2	5.7
14	E80Q14H	Q2	4.980	4.494	27	2-5/8	5 25/32	3-1/2	2	4-1/8	1-3/4	.557	12.0	7.5
15	E80Q15H	Q2	5.300	4.810	22	2-5/8	4 29/32	3-1/2	1-1/8	4-1/8	1-3/4	.557	12.6	8.1
16	E80Q16H	Q2	5.630	5.126	25	2-5/8	3 7/8	3-1/2	3/32	4-1/8	3/4	.557	13.8	9.3
17	E80Q17H	Q2	5.950	5.442	24	2-5/8	3 29/32	3-1/2	1/8	4-1/8	3/4	.557	14.3	9.8
18	E80Q18H	Q2	6.270	5.759	24	2-5/8	3 29/32	3-1/2	1/8	4-1/8	3/4	.557	16.5	12.0
19	E80Q19H	Q2	6.590	6.076	24	2-5/8	3 29/32	3-1/2	1/8	4-1/8	3/4	.557	18.4	13.9
20	E80R20H	R1	6.910	6.392	24	3-3/4	4 1/32	2-7/8	7/8	5-3/8	7/8	.557	17.7	10.2
21	E80R21H	R1	7.240	6.710	24	3-3/4	4 1/32	2-7/8	7/8	5-3/8	7/8	.557	19.9	12.4
22	E80R22H	R1	7.560	7.027	24	3-3/4	4 1/32	2-7/8	7/8	5-3/8	7/8	.557	22.1	14.6
23	E80R23H	R1	7.880	7.344	25	3-3/4	3-5/32	2-7/8	0	5-3/8	0	.557	23.4	15.9
24	E80R24	R1	8.200	7.661	25	3-3/4	3-5/32	2-7/8	0	5-3/8	0	.557	7.2	18.5
25	E80R25	R1	8.520	7.979	25	3-3/4	3-5/32	2-7/8	0	5-3/8	0	.557	12.0	20.3
26	E80R26	R1	8.840	8.296	25	3-3/4	3-5/32	2-7/8	0	5-3/8	0	.557	12.6	23.4
27	E80R27	R1	9.160	8.614	25	3-3/4	3-5/32	2-7/8	0	5-3/8	0	.557	13.8	25.8
28	E80R28	R1	9.480	8.931	25	3-3/4	3-5/32	2-7/8	0	5-3/8	0	.557	14.3	28.1
30	E80R30	R1	10.110	9.567	25	3-3/4	3-5/32	2-7/8	0	5-3/8	0	.557	16.5	33.3
36	E80S36	S1	12.030	11.474	22	4-1/4	5-1/8	4-3/8	0	6-3/8	1-1/2	.557	18.4	67.0
42	E80S42	S1	13.940	13.382	22	4-1/4	5-1/8	4-3/8	0	6-3/8	1-1/2	.557	17.7	96.1
45	E80S45	S1	14.900	14.336	22	4-1/4	5-1/8	4-3/8	0	6-3/8	1-1/2	.557	19.9	112.0
52	E80U52	U0	17.130	16.562	22	5-1/2	5-23/32	5-1/4	0	8-3/8	1-25/32	.557	22.1	150.0
60	E80U60	U0	19.680	19.107	22	5-1/2	5-23/32	5-1/4	0	8-3/8	1-25/32	.557	23.4	207.0
68	E80U68	U0	22.230	21.653	22	5-1/2	5-23/32	5-1/4	0	8-3/8	1-25/32	.557	23.4	271.0
76	E80U76	U0	24.780	24.198	22	5-1/2	5-23/32	5-1/4	0	8-3/8	1-25/32	.557	23.4	344.0
95	E80U95	U0	30.830	30.245	25	5-1/2	5-55/64	5-1/4	1/32	8-3/8	1-13/32	.557	23.4	183.0

Sprockets with "H" suffix have hardened teeth.

No. 100 1 1/4" Pitch

All Steel Stock Sprockets



BORED-TO-SIZE

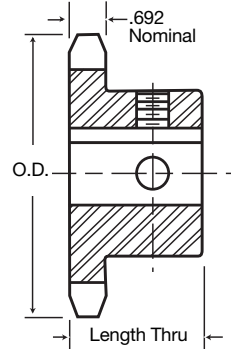

TYPE BS

SPROCKETS

Single Type "BS" — 2 Setscrews — Bored-To-Size

No. Teeth	Catalog Number	Outside Diameter	Length Thru Bore	Weight Lbs. (Approx.)	Stock Finished Bores Includes Keyway and Setscrews
8	100BS8	3.770	1 1/8	2.8	1 - 1 1/8 - 1 1/4
9	100BS9	4.180	1 1/8	3.0	1 - 1 1/8 - 1 1/4 - 1 1/8
10	100BS10	4.600	1 1/8	3.9	1 - 1 1/8 - 1 1/4 - 1 1/8
11	100BS11	5.010	1 1/8	4.9	1 - 1 1/8 - 1 1/4 - 1 1/8 - 1 1/8 - 2 - 2 1/8
12	100BS12	5.420	1 1/8	6.0	1 - 1 1/8 - 1 1/4 - 1 1/8 - 1 1/8 - 2 - 2 1/8
13	100BS13	5.820	1 1/8	6.2	1 - 1 1/8 - 1 1/4 - 1 1/8 - 1 1/8 - 2 - 2 1/8
14	100BS14	6.230	1 1/8	6.6	- 1 1/8 - 1 1/8 - 1 1/8 - 2 - 2 1/8
15	100BS15	6.630	1 1/8	8.4	- 1 1/8 - 1 1/8 - 2 - 2 1/8
16	100BS16	7.030	1 1/8	9.0	- 1 1/8 - 1 1/8 - 2 - 2 1/8 - 2 1/8 - 2 1/8
17	100BS17	7.440	1 1/8	9.9	- 1 1/8 - 1 1/8 - 2 - 2 1/8 - 2 1/8 - 2 1/8
18	100BS18	7.840	1 1/2	10.6	- 1 1/8 - 1 1/8 - 2 - 2 1/8 - 2 1/8 - 2 1/8
19	100BS19	8.240	2	12.1	- 1 1/8 - 1 1/8 - 2 - 2 1/8 - 2 1/8 - 2 1/8
20	100BS20	8.640	2	13.2	- 1 1/8 - 1 1/8 - 2 - 2 1/8 - 2 1/8 - 2 1/8
21	100BS21	9.040	2	14.3	- 1 1/8 - 1 1/8 - 2 - 2 1/8 - 2 1/8 - 2 1/8
22	100BS22	9.440	2	15.1	- 1 1/8 - 1 1/8 - 2 - 2 1/8 - 2 1/8 - 2 1/8
23	100BS23	9.840	2	16.1	- 1 1/8 - 1 1/8 - 2 - 2 1/8 - 2 1/8 - 2 1/8
24	100BS24	10.250	2	18.1	- 1 1/8 - 1 1/8 - 2 - 2 1/8 - 2 1/8 - 2 1/8
25	100BS25	10.650	2	18.4	- 1 1/8 - 1 1/8 - 2 - 2 1/8 - 2 1/8 - 2 1/8

Hub diameters vary to suit different bore sizes.

NOTE: KEYWAY IS ON CENTER LINE OF TOOTH.

Single-Type C — Steel

No. Teeth	Catalog Number	Outside Diameter	Bore (inches)		Hub (inches)		Weight Lbs. (Approx.)
			Stock	Rec. Max.	Diameter	Length	
10	100C10	4.600	1	1 1/8	3 5/8	2 1/8	6.13
11	100C11	5.010	1	2 1/4	3 3/8	2 1/8	7.12
12	100C12	5.420	1	2 1/8	4	2 1/8	8.37
13	100C13	5.820	1	2 1/8	3 3/4	2 1/8	10.00
14	100C14	6.230	1	2 1/8	4 1/8	2 1/8	12.19

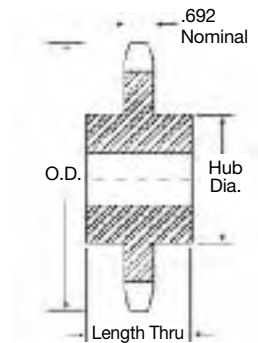

TYPE C



Double Single-Type A — Steel

No. Teeth	Catalog Number	Diameters		Type	Min. Bore	Max. Bore	Dimensions				Wt. (Approx.)
		Outside Diameter	Pitch Diameter				L	C	E	w Nom.	
13	DS100A13	5.820	5.223	A	1	2 1/2	2 1/16	2	3 5/32	.692	11.2
14	DS100A14	6.230	5.617	A	1 1/4	2 3/4	2 1/16	2	4 1/16	.692	13.5
15	DS100A15	6.630	6.012	A	1 1/4	3 1/16	2 1/16	2	4 1/32	.692	16.8
16	DS100A16	7.030	6.407	A	1 1/4	3 1/4	2 1/16	2	5	.692	19.3
17	DS100A17	7.440	6.803	A	1 1/4	3 3/8	2 1/16	2	5 1/32	.692	21.5
18	DS100A18	7.840	7.198	A	1 1/4	3 3/4	2 1/16	2	5 5/64	.692	23.0
19	DS100A19	8.240	7.595	A	1 1/4	4 1/16	2 1/16	2	6 1/64	.692	25.0
20	DS100A20	8.640	7.991	A	1 1/4	4 3/16	2 1/16	2	6 3/64	.692	26.5
21	DS100A21	9.040	8.387	A	1 1/4	5 1/4	2 1/16	2	7	.692	29.0

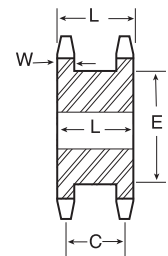

TYPE A

Double Single-Taper Bushed — Steel

No. Teeth	Catalog Number	Bushing Size	Diameters		Min. Bore	Max. Bore	Type	Dimensions				Wt. Rim Only	
			Outside Diameter	Pitch Diameter				L ₁	C	E	L ₂		w Nom.
15	DS100ATB15H	2517	6.630	6.012	3/4	2 1/2	A	2 1/16	2	4 19/32	1 3/4	.692	12.5
16	DS100ATB16H	2517	7.030	6.407	3/4	2 1/2	A	2 1/16	2	5	1 3/4	.692	13.0
17	DS100ATB17H	3020	7.440	6.803	1 1/16	3	A	2 1/16	2	5 1/32	2	.692	14.0
18	DS100ATB18H	3020	7.840	7.198	1 1/16	3	A	2 1/16	2	5 5/64	2	.692	16.0
19	DS100ATB19H	3020	8.240	7.595	1 1/16	3	A	2 1/16	2	6 1/64	2	.692	20.0
20	DS100ATB20H	3020	8.640	7.991	1 1/16	3	A	2 1/16	2	6 39/64	1 3/4	.692	27.5
21	DS100ATB21H	3020	9.040	8.387	1 1/16	3	A	2 1/16	2	7	2	.692	27.5

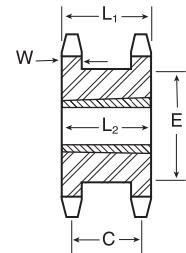

TAPER BUSH
TYPE A

Sprockets with "H" suffix have hardened teeth.

Double Single- MST® — Steel

No. Teeth	Catalog Number	Bushing Size	Diameters		Min. Bore	Max. Bore	Type	Dimensions				Wt. Rim Only	
			Outside Diameter	Pitch Diameter				L ₁	C	E	L ₂		w Nom.
17	DS100R17H	R1	7.440	6.803	1 1/8	3 3/8	B	2 1/16	2	5 1/32	3 27/32	.692	12.5
19	DS100R19H	R1	8.240	7.595	1 1/8	3 3/8	B	2 1/16	2	6 1/64	3 27/32	.692	18.8
21	DS100R21H	R1	9.040	8.387	1 1/8	3 3/8	B	2 1/16	2	7	3 27/32	.692	23.1

Sprockets with "H" suffix have hardened teeth.

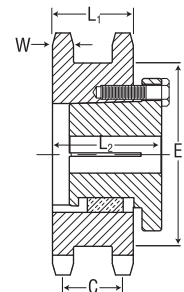

MST
TYPE B

No. 100 1 1/4" Pitch

Stainless Steel Stock Sprockets



TYPE A

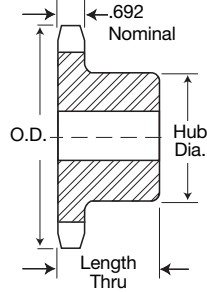

TYPE B

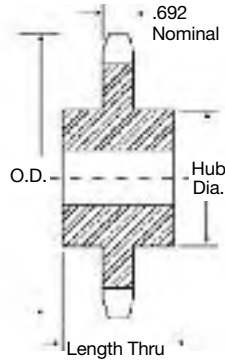

TYPE C

SPROCKETS

Single-Type B & C

Single-Type A

No. Teeth	Catalog Number	Outside Diameter	Type	Bore (inches)		Hub (inches)		Weight Lbs. (Approx.)	Type	Catalog Number	Stock Bore	Weight Lbs. (Approx.)
				Stock	Rec. Max.	Diameter	Length Thru					
11	100B11SS	5.010	B	1	2 1/4	3 5/8*	1 1/2	5.3				
12	100B12SS	5.420	B	1	2 1/4	4*	1 1/2	6.4				
13	100B13SS	5.820	B	1	2 3/4	3 3/8	1 1/2	6.6				
14	100B14SS	6.230	B	1 1/4	2 3/4	4 1/8	1 1/2	7.4				
15	100B15SS	6.630	B	1 1/4	3	4 1/2	1 1/2	9.2				
16	100B16SS	7.030	B	1 5/8	3	4 1/2	1 1/2	9.9	A	100A16SS	1 1/4	5.4
17	100B17SS	7.440	B	1 5/8	3	4 1/2	1 1/2	10.8	A	100A17SS	1 1/4	6.1
18	100B18SS	7.840	B	1 5/8	3	4 1/2	1 1/2	11.5	A	100A18SS	1 1/4	7.0
19	100B19SS	8.240	B	1 5/8	3	4 1/2	2	13.1	A	100A19SS	1 1/4	7.8
20	100B20SS	8.640	B	1 5/8	3	4 1/2	2	14.2	A	100A20SS	1 1/4	8.8
21	100B21SS	9.040	B	1 5/8	3	4 1/2	2	15.3	A	100A21SS	1 1/4	9.8

* Has recessed groove in hub for chain clearance.

Maximum bores shown will accommodate standard keyseat and setscrew over keyseat. Slightly larger bores are possible with no keyseat, shallow keyseat, or setscrew at angle to keyseat.

Alteration Charges

See current discount sheet for alteration charges.

Single-Type B & C

Single-Type A

No. Teeth	Catalog Number	Outside Diameter	Type	Bore (inches)		Hub (inches)		Weight Lbs. (Approx.)	Type	Catalog Number	Stock Bore	Weight Lbs. (Approx.)
				Stock	Rec. Max.	Diameter	Length Thru					
7		3.350							A	100A7	1	1.2
8	100B8	3.770	B	1	1 1/4	2 5/16*	1 1/8	2.3	A	100A8	1	1.4
9	100B9	4.180	B	1	1 1/2	2 3/8*	1 1/8	3.2	A	100A9	1	1.6
10	100B10	4.600	B	1	1 5/8	3 1/8*	1 1/8	4.1	A	100A10	1	2.0
11	100B11	5.010	B	1	2 1/4	3 3/8*	1 1/8	5.3	A	100A11	1 1/4	2.5
12	100B12	5.420	B	1	2 1/2	4*	1 1/8	6.4	A	100A12	1 1/4	3.0
13	100B13	5.820	B	1	2 3/4	3 1/2	1 1/8	6.6	A	100A13	1 1/4	3.5
14	100B14	6.230	B	1 1/8	2 3/4	4 1/8	1 1/8	7.4	A	100A14	1 1/4	4.1
15	100B15	6.630	B	1 1/4	3	4 1/2	1 1/8	9.2	A	100A15	1 1/4	4.7
16	100B16	7.030	B	1 1/2	3	4 1/2	1 1/8	9.9	A	100A16	1 1/4	5.4
17	100B17	7.440	B	1 5/8	3	4 1/2	1 1/8	10.8	A	100A17	1 1/4	6.1
18	100B18	7.840	B	1 3/4	3	4 1/2	1 1/8	11.5	A	100A18	1 1/4	7.0
19	100B19	8.240	B	1 5/8	3	4 1/2	2	13.1	A	100A19	1 1/4	7.8
20	100B20	8.640	B	1 3/4	3	4 1/2	2	14.2	A	100A20	1 1/4	8.8
21	100B21	9.040	B	1 5/8	3	4 1/2	2	15.3	A	100A21	1 1/4	9.8
22	100B22	9.440	B	1 3/4	3	4 1/2	2	16.1	A	100A22	1 1/4	10.5
23	100B23	9.840	B	1 3/4	3	4 1/2	2	17.2	A	100A23	1 1/4	11.8
24	100B24	10.250	B	1 3/4	3	4 1/2	2	19.2	A	100A24	1 1/4	12.8
25	100B25	10.650	B	1 3/4	3	4 1/2	2	19.5	A	100A25	1 1/4	13.9
26	100B26	11.050	B	1 3/4	3 5/8	5	2	21.7	A	100A26	1 1/4	15.0
27	100B27	11.440	B	1 3/4	3 5/8	5	2	23.0	A	100A27	1 1/4	16.0
28	100B28	11.840	B	1 3/4	3 5/8	5	2	24.4	A	100A28	1 1/4	17.4
29	100B29	12.240	B	1 3/4	3 5/8	5	2	25.0	A	100A29	1 1/4	19.6
30	100B30	12.640	B	1 3/4	3 5/8	5	2	26.9	A	100A30	1 1/4	20.1
31		13.040							A	100A31	1 1/4	21.5
32	100B32	13.440	B	1 3/4	3 5/8	5	2	29.8	A	100A32	1 1/4	22.6
33		13.840							A	100A33	1 1/4	24.1
34		14.240							A	100A34	1 1/4	26.0
35	100B35	14.640	B	1 3/4	3 5/8	5	2 1/2	36.9	A	100A35	1 1/4	27.2
36	100B36	15.040	B	1 3/4	3 5/8	5	2 1/2	38.6	A	100A36	1 1/4	30.0
37		15.440							A	100A37	1 1/4	31.0
38	100B38	15.840	B	1 3/4	3 5/8	5	2 1/2	41.5	A	100A38	1 1/4	33.0
39	100B39	16.230	B	1 3/4	3 5/8	5	2 1/2	43.6	A	100A39	1 1/4	35.0
40	100B40	16.630	B	1 3/4	3 5/8	5	2 1/2	46.9	A	100A40	1 1/4	36.0
41		17.030							A	100A41	1 1/4	39.0
42	100B42	17.430	B	1 3/4	3 5/8	5	2 1/2	50.4	A	100A42	1 1/4	40.0
43		17.830							A	100A43	1 1/2	43.0
44		18.230							A	100A44	1 1/2	45.0
45	100B45	18.630	B	1 3/4	3 5/8	5	2 1/2	54.0	A	100A45	1 1/2	47.0
46		19.020							A	100A46	1 1/2	48.0
47		19.420							A	100A47	1 1/2	52.0
48	100B48	19.820	B	1 3/4	4	6	2 1/2	66.0	A	100A48	1 1/2	54.0
49		20.220							A	100A49	1 1/2	56.0
50		20.620							A	100A50	1 1/2	57.0
51		21.020							A	100A51	1 1/2	63.0
52		21.420							A	100A52	1 1/2	64.0
53		21.810							A	100A53	1 1/2	64.2
54	100C54	22.210	C	1 1/2	4	6	3 1/4	78.0	A	100A54	1 1/2	68.0
55		22.610							A	100A55	1 1/2	70.0
56		23.010							A	100A56	1 1/2	72.0
57		23.410							A	100A57	1 1/2	75.8
58		23.810							A	100A58	1 1/2	76.0
59		24.200							A	100A59	1 1/2	77.0
60	100C60	24.600	C	1 1/2	4	6	3 3/4	89.0	A	100A60	1 1/2	80.0
70	100C70	28.580	C	1 1/2	5 1/4	7	3 3/4	125	A	100A70	1 1/2	113
72	100C72	29.380	C	1 1/2	5 1/4	7	3 3/4	134	A	100A72	1 1/2	119
76	100C76	30.973	C	1 1/2	5 1/4	7	3 3/4	143	A	100A76	1 1/2	133
80	100C80	32.570	C	1 1/2	5 1/4	7	3 3/4	151	A	100A80	1 1/2	146
84	100C84	34.160	C	1 1/2	5 1/4	7	3 3/4	170	A	100A84	1 1/2	162
90	100C90	36.550	C	1 1/2	5 1/4	7	3 3/4	184	A	100A90	1 1/2	193
96	100C96	38.930	C	1 1/2	5 1/4	7	4 1/4	203	A	100A96	1 1/2	215

* Has recessed groove in hub for chain clearance.

Maximum bores shown will accommodate standard keyseat and setscrew over keyseat. Slightly larger bores are possible with no keyseat, shallow keyseat, or setscrew at angle to keyseat.



TYPE A

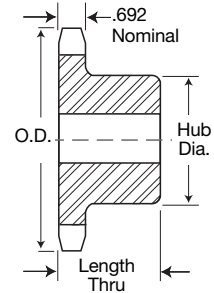

TYPE B

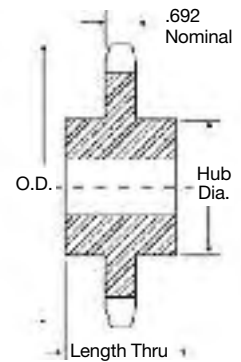

TYPE C

Alteration Charges

See current discount sheet for alteration charges.

No. 100

1 1/4" Pitch

All Steel Stock Sprockets



Single-Type QD With Hardened Teeth

No. Teeth	Catalog Number
11	100SDS11H
12	100SDS12H
13	100SK13H
14	100SK14H
15	100SF15H
16	100SF16H
17	100SF17H
18	100E18H
19	100E19H
20	100E20H
21	100E21H
22	100E22H
23	100E23H
24	100E24H
25	100E25H
26	100E26H
27	100E27H
28	100E28H
30	100E30H

SABER TOOTH®

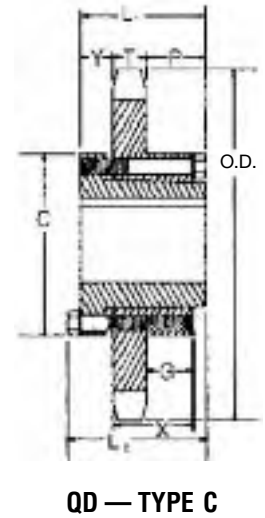
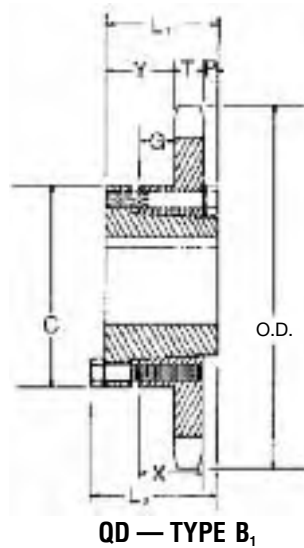
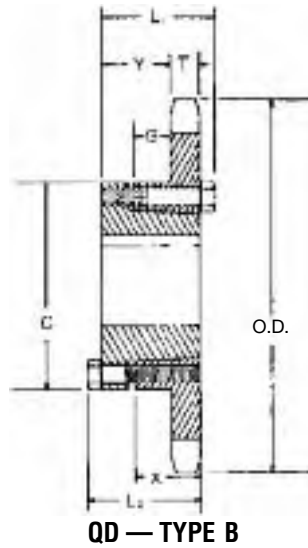

SPROCKETS

Single-Type QD

No. Teeth	Catalog Number	Bush-ing	Diameters		Type	Max. Bore	Dimensions							Weight (Approx.)		
			Outside Diameter	Pitch Diameter			L ₁	L ₂	C	Y	P	G	X	T	With Hub	Rim Only
11	100SDS11	SDS	5.010	4.437	B	2	1 1/2	1 1/2	3 3/16	5/8		1/16	3/4	.692	3.0	2.0
12	100SDS12	SDS	5.420	4.830	B	2	1 1/2	1 1/2	3 3/16	5/8		1/16	3/4	.692	3.6	2.6
13	100SK13	SK	5.820	5.223	B	2 1/2	2 1/2	2 1/2	3 3/8	1 1/4		3/16	1 1/4	.692	5.3	3.3
14	100SK14	SK	6.230	5.617	B	2 1/2	2 1/2	2 1/2	3 3/8	1 1/4		3/16	1 1/4	.692	6.1	4.1
15	100SF15	SF	6.630	6.012	B	2 1/16	2 1/4	2 1/4	4 1/4	1 1/4		3/16	1 1/4	.692	7.8	4.8
16	100SF16	SF	7.030	6.407	B	2 1/16	2 1/4	2 1/4	4 1/4	1 1/4		3/16	1 1/4	.692	8.6	5.6
17	100SF17	SF	7.440	6.803	B	2 1/16	2 1/4	2 1/4	4 1/4	1 1/4		3/16	1 1/4	.692	9.5	6.5
18	100E18	E	7.840	7.198	B1	3 1/2	2 1/2	2 1/16	6	1 1/16	1/8	1 1/16	1 1/4	.692	19.0	9.0
19	100E19	E	8.240	7.595	B1										20.2	10.2
20	100E20	E	8.640	7.991	B1										21.6	11.6
21	100E21	E	9.040	8.387	B1										22.5	12.5
22	100E22	E	9.440	8.783	B1										23.5	13.5
23	100E23	E	9.840	9.180	B1										24.6	14.6
24	100E24	E	10.250	9.577	B1										25.7	15.7
25	100E25	E	10.650	9.973	B1										26.8	16.8
26	100E26	E	11.050	10.370	B1										28.1	18.1
27	100E27	E	11.440	10.767	B1										29.2	19.2
28	100E28	E	11.840	11.164	B1										30.7	20.7
30	100E30	E	12.640	11.958	B1										33.2	23.2
32	100E32	E	13.440	12.753	B1										35.4	25.4
35	100E35	E	14.640	13.945	B1										40.5	30.5
36	100E36	E	15.040	14.342	B1										42.5	32.3
40	100E40	E	16.630	15.932	B1										49.1	39.1
42	100E42	E	17.430	16.727	B1										53.4	43.4
45	100E45	E	18.630	17.920	B1										58.9	48.9
48	100E48	E	19.820	19.112	B1	3 1/2	2 1/2	2 1/16	6	1 1/16	1/8	1 1/16	1 1/4	.692	64.0	54.0
54	100E54	E	22.210	21.498	C	3 1/2	2 1/2	2 1/16	6	7/8	1 1/16	1 1/16	1 1/4	.692	72.0	62.0
60	100E60	E	24.600	23.884	C	3 1/2	2 1/2	2 1/16	6	7/8	1 1/16	1 1/16	1 1/4	.692	84.0	74.0
70	100F70	F	28.580	27.862	C	3 1/16	3 1/2	4	6 1/2	1	1 1/16	1 1/16	2 1/2	.692	110.5	99.0
72	100F72	F	29.380	28.657	C										117.5	106
80	100F80	F	32.570	31.839	C										134.5	123
84	100F84	F	34.160	33.430	C	3 1/16	3 1/2	4	6 1/2	1	1 1/16	1 1/16	2 1/2	.692	151.5	140

Single-Taper Bushed with Hardened Teeth

No. Teeth	Catalog Number
11	100BTB11H
12	100BTB12H
13	100BTB13H
14	100BTB14H
15	100BTB15H
16	100BTB16H
17	100BTB17H
18	100BTB18H
19	100BTB19H
20	100BTB20H
21	100BTB21H
22	100BTB22H
24	100BTB24H
26	100BTB26H
28	100BTB28H
30	100BTB30H

**SABER
TOOTH®**



SPROCKETS

Single-Taper Bushed

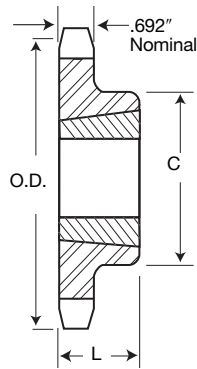

TYPE B

No. Teeth	Catalog Number	Bushing	Diameter		Max. Bore	Dimensions		Type	Weight (Approx.)	
			Outside Diameter	Pitch Diameter		L	C		Rim Only	Bushing Only
11	100BTB11	1615	5.007	4.437	1%	1½	3	B	2.7	1.2
12	100BTB12	1615	5.415	4.830	1%	1½	3¼	B	3.5	1.2
13	100BTB13	2012	5.821	5.223	2	1¼	3⅝	B	3.6	1.7
14	100BTB14	2012	6.227	5.617	2	1¼	3⅝	B	3.9	1.7
15	100BTB15	2517	6.631	6.012	2½	1¼	4¼	B	5.0	3.5
16	100BTB16	2517	7.034	6.407	2½	1¼	4¼	B	6.4	3.5
17	100BTB17	2517	7.437	6.803	2½	1¼	4¼	B	7.1	3.5
18	100BTB18	2517	7.839	7.198	2½	1¼	4¼	B	7.8	3.5
19	100BTB19	2517	8.241	7.594	2½	1¼	4¼	B	8.7	3.5
20	100BTB20	2517	8.642	7.991	2½	1¼	4¼	B	9.6	3.5
21	100BTB21	2517	9.043	8.387	2½	1¼	4¼	B	10.6	3.5
22	100BTB22	2517	9.444	8.783	2½	1¼	4¼	B	11.0	3.5
24	100BTB24	2517	10.245	9.577	2½	1¼	4¼	B	13.0	3.5
26	100BTB26	2517	11.045	10.370	2½	1¼	4¼	B	15.0	3.5
28	100BTB28	3020	11.844	11.164	3	2	5¼	B	16.5	6.5
30	100BTB30	3020	12.643	11.958	3	2	5¼	B	22.0	6.5
32	100BTB32	3020	13.442	12.753	3	2	5¼	B	23.0	6.5
35	100BTB35	3020	14.639	13.945	3	2	5¼	B	28.0	6.5
36	100BTB36	3020	15.038	14.342	3	2	5¼	B	31.0	6.5
40	100BTB40	3020	16.633	15.932	3	2	5¼	B	37.0	6.5
45	100BTB45	3020	18.626	17.919	3	2	5¼	B	46.0	6.5
48	100BTB48	3020	19.821	19.112	3	2	5¼	B	53.0	6.5
54	100BTB54	3020	22.212	21.498	3	2	5¼	B	62.0	6.5
60	100BTB60	3020	24.601	23.884	3	2	5¼	B	72.0	6.5

No. 100

1/4" Pitch

MST[®]

Sprockets

Martin

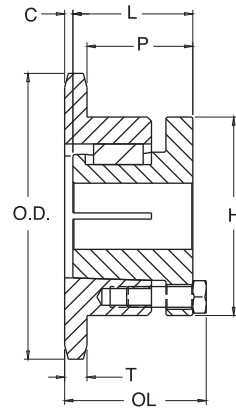

TYPE 4

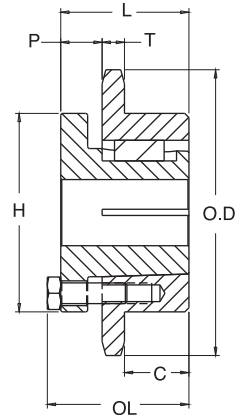

TYPE 5

Single - MST[®] Sprockets

No. Teeth	Catalog Number	Bush-ing	Diameters		Type	Max. Bore	Dimensions						Weight (Approx.)	
			Outside Dia.	Pitch Dia.			OL	L	C	H	P	T(nom)	With Hub	Rim Only
11	100P11H	P1	5.010	4.437	4	1-3/4	2-3/16	1-15/16	0	3	1-1/4	.692	4.1	2.8
12	100Q12H	Q1	5.420	4.830	4	2-11/16	2-27/32	2-1/2	1/16	4-1/8	1-7/8	.692	7.0	3.5
13	100Q13H	Q1	5.820	5.223	4	2-11/16	2-27/32	2-1/2	1/16	4-1/8	1-7/8	.692	7.8	4.3
14	100Q14H	Q1	6.230	5.617	4	2-11/16	2-25/32	2-1/2	0	4-1/8	1-13/16	.692	9.1	5.6
15	100Q15H	Q1	6.630	6.012	4	2-11/16	2-25/32	2-1/2	0	4-1/8	1-13/16	.692	10.1	6.6
16	100Q16H	Q1	7.030	6.407	4	2-11/16	2-25/32	2-1/2	0	4-1/8	1-13/16	.692	10.9	7.4
17	100Q17H	Q1	7.440	6.803	4	2-11/16	2-25/32	2-1/2	0	4-1/8	1-13/16	.692	11.7	8.2
18	100Q18H	Q1	7.840	7.198	4	2-11/16	2-25/32	2-1/2	0	4-1/8	1-13/16	.692	12.5	9.0
19	100Q19H	Q1	8.240	7.595	4	2-11/16	2-25/32	2-1/2	0	4-1/8	1-13/16	.692	13.3	9.8
20	100Q20H	Q1	8.640	7.991	4	2-11/16	2-25/32	2-1/2	0	4-1/8	1-13/16	.692	14.4	10.9
21	100Q21H	Q1	9.040	8.387	4	2-11/16	2-25/32	2-1/2	0	4-1/8	1-13/16	.692	15.3	11.8
21	100R21H	R1	9.040	8.387	4	3-3/4	3-5/32	2-7/8	0	5-3/8	2-3/16	.692	20.8	13.3
22	100Q22H	Q1	9.440	8.783	4	2-11/16	2-25/32	2-1/2	0	4-1/8	1-13/16	.692	16.1	12.6
23	100Q23H	Q1	9.840	9.180	4	2-11/16	2-25/32	2-1/2	0	4-1/8	1-13/16	.692	17.3	13.8
24	100Q24H	Q1	10.250	9.577	4	2-11/16	2-25/32	2-1/2	0	4-1/8	1-13/16	.692	18.9	15.4
24	100R24H	R1	10.250	9.577	4	3-3/4	3-5/32	2-7/8	0	5-3/8	2-3/16	.692	23.1	15.6
25	100Q25H	Q1	10.650	9.973	4	2-11/16	2-25/32	2-1/2	0	4-1/8	1-13/16	.692	19.5	16.0
25	100R25H	R1	10.650	9.973	4	3-3/4	3-5/32	2-7/8	0	5-3/8	2-3/16	.692	24.5	17.0
26	100Q26H	Q1	11.050	10.370	4	2-11/16	2-25/32	2-1/2	0	4-1/8	1-13/16	.692	20.8	17.3
26	100R26H	R1	11.050	10.370	4	3-3/4	3-5/32	2-7/8	0	5-3/8	2-3/16	.692	25.4	17.9
27	100Q27H	Q1	11.440	10.767	4	2-11/16	2-25/32	2-1/2	0	4-1/8	1-13/16	.692	21.7	18.2
27	100R27H	R1	11.440	10.767	4	3-3/4	3-5/32	2-7/8	0	5-3/8	2-3/16	.692	27.1	19.6
28	100Q28H	Q1	11.840	11.164	4	2-11/16	2-25/32	2-1/2	0	4-1/8	1-13/16	.692	23.1	19.6
28	100R28H	R1	11.840	11.164	4	3-3/4	3-5/32	2-7/8	0	5-3/8	2-3/16	.692	28.5	21.0
30	100Q30H	Q1	12.640	11.958	4	2-11/16	2-25/32	2-1/2	0	4-1/8	1-13/16	.692	25.9	22.4
30	100R30H	R1	12.640	11.958	4	3-3/4	3-5/32	2-7/8	0	5-3/8	2-3/16	.692	32.0	24.5
32	100Q32	Q1	13.440	12.753	4	2-11/16	2-25/32	2-1/2	0	4-1/8	1-13/16	.692	28.8	25.3
32	100R32	R1	13.440	12.753	4	3-3/4	3-5/32	2-7/8	0	5-3/8	2-3/16	.692	34.0	26.5
35	100Q35	Q1	14.640	13.945	4	2-11/16	2-25/32	2-1/2	0	4-1/8	1-13/16	.692	33.7	30.2
35	100R35	R1	14.640	13.945	4	3-3/4	3-5/32	2-7/8	0	5-3/8	2-3/16	.692	37.3	29.8
36	100R36	R1	15.040	14.342	4	3-3/4	3-5/32	2-7/8	0	5-3/8	2-3/16	.692	40.5	33.0
40	100R40	R1	16.630	15.932	4	3-3/4	3-5/32	2-7/8	0	5-3/8	2-3/16	.692	48.4	40.9
42	100R42	R1	17.430	16.727	4	3-3/4	3-5/32	2-7/8	0	5-3/8	2-3/16	.692	51.8	44.3
45	100R45	R1	18.630	17.920	4	3-3/4	3-5/32	2-7/8	0	5-3/8	2-3/16	.692	58.0	50.5
48	100R48	R1	19.820	19.112	4	3-3/4	3-5/32	2-7/8	0	5-3/8	2-3/16	.692	65.0	57.5
54	100R54	R1	22.210	21.498	5	3-3/4	3-5/32	2-7/8	1-5/16	5-3/8	7/8	.692	76.5	69.0
60	100R60	R1	24.600	23.884	5	3-3/4	3-5/32	2-7/8	1-5/16	5-3/8	7/8	.692	91.5	84.0
70	100R70	R1	28.580	27.862	5	3-3/4	3-5/32	2-7/8	1-5/16	5-3/8	7/8	.692	111.5	104.0
72	100R72	R1	29.380	28.657	5	3-3/4	3-5/32	2-7/8	1-5/16	5-3/8	7/8	.692	113.5	106.0
80	100R80	R1	32.570	31.839	5	3-3/4	3-5/32	2-7/8	1-5/16	5-3/8	7/8	.692	142.5	135.0
84	100R84	R1	34.160	33.430	5	3-3/4	3-5/32	2-7/8	1-5/16	5-3/8	7/8	.692	145.5	138.0

Sprockets with "H" suffix have hardened teeth.

Double-Type B & C

No. Teeth	Catalog Number	Outside Diameter	Type	Bore (inches)		Hub (inches)		Weight Lbs. (Approx.)
				Stock	Rec. Max.	Dia.	Length Thru	
9	D100B9	4.180	B	1	1 1/2	2 1/2	2 1/2	4.6
10	D100B10	4.600	B	1	1 1/2	2 1/2	2 1/2	6.2
11	D100B11	5.010	B	1	2 1/2	3 1/2	2 1/2	7.9
12	D100B12	5.420	B	1 1/2	2 1/2	3 1/2	2 1/2	9.3
13	D100B13	5.820	B	1 1/2	2 1/2	3 13/16	2 1/2	11.4
14	D100B14	6.230	B	1 1/2	2 1/2	4 1/16	2 1/2	13.6
15	D100B15	6.630	B	1 1/4	3 1/2	4 5/8	3 1/2	17.1
16	D100B16	7.030	B	1 1/4	3 1/2	5	3 1/2	20.1
17	D100B17	7.440	B	1 1/4	3 1/2	5 1/4	3 1/2	23.1
18	D100B18	7.840	B	1 1/4	3 1/2	5 3/4	3 1/2	25.4
19	D100B19	8.240	B	1 1/4	3 1/2	5 1/2	3 1/2	29.6
20	D100B20	8.640	B	1 1/4	3 1/2	5 1/2	3 1/2	32.4
21	D100B21	9.040	B	1 1/4	3 1/2	5 1/2	3 1/2	35.3
22	D100B22	9.440	B	1 1/4	3 1/2	5 1/2	3 1/2	38.4
23	D100B23	9.840	B	1 1/4	3 1/2	5 1/2	3 1/2	41.3
24	D100B24	10.250	B	1 1/4	3 1/2	5 1/2	3 1/2	45.1
25	D100B25	10.650	B	1 1/4	3 1/2	5 1/2	3 1/2	48.5
26	D100B26	11.050	B	1 1/2	3 1/2	5 1/2	3 1/2	51.5
30	D100B30	12.640	B	1 1/2	3 1/2	5 1/2	3 1/2	65.0
35	D100C35	14.640	C	1 1/2	3 3/16	6	4 1/4	75.0
45	D100C45	18.630	C	1 1/2	3 3/16	6	4 1/2	103
60	D100C60	24.600	C	1 1/2	5	7 1/2	5	175
70	D100C70	28.580	C	1 1/2	5	7 1/2	5	197
80	D100C80	32.570	C	1 1/2	5	7 1/2	5	231

Maximum bores shown will accommodate standard keyseat and setscrew over keyseat. Slightly larger bores are possible with no keyseat, shallow keyseat, or setscrew at angle to keyseat.

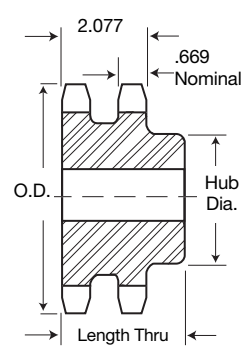

TYPE B

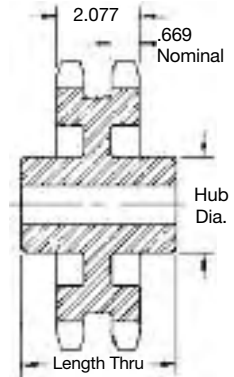

TYPE C

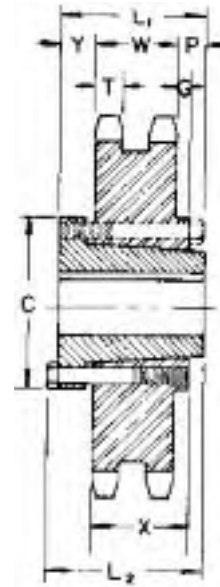

QD — TYPE C₂

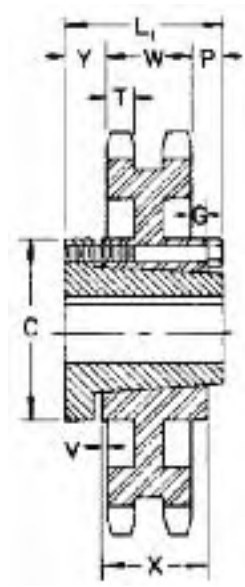

QD — TYPE C₆

Alteration Charges

See current discount sheet for alteration charges.

Double-Type QD

No. Teeth	Catalog Number	Bush-ing	Diameters		Type	Max. Bore	Dimensions										Weight (Approx.)	
			Outside Diameter	Pitch Diameter			L ₁	L ₂	C	Y	P	G	V	X	T	W	With Hub	Rim Only
35	D100F35	F	14.640	13.945	C2	3 15/16	3 3/4	4	6 3/4	1	35/64	27/64		2 1/2	.669	2.077	84.5	73
45	D100F45	F	18.630	17.920	C2	3 3/16	3 3/4	4	6 3/4	1	35/64	27/64		2 1/2	.669	2.077	92.5	81
60	D100J60	J	24.600	23.884	C6	4 1/16	4 1/2	5	7 1/4	1 1/32	1 1/64	1 1/32	1/32	3 3/16	.669	2.077	152	133
70	D100J70	J	28.580	27.862	C6	4 1/16	4 1/2	5	7 1/4	1 1/32	1 1/64	1 1/32	1/32	3 3/16	.669	2.077	180	161
80	D100J80	J	32.570	31.839	C6	4 1/16	4 1/2	5	7 1/4	1 1/32	1 1/64	1 1/32	1/32	3 3/16	.669	2.077	215	196

No. 100-2 1-1/4" Pitch

MST® Sprockets

Martin

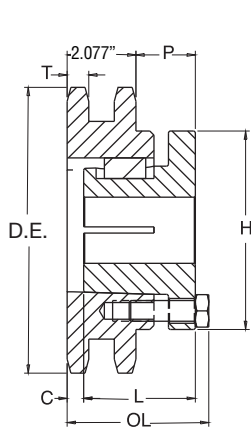

TIPO 12

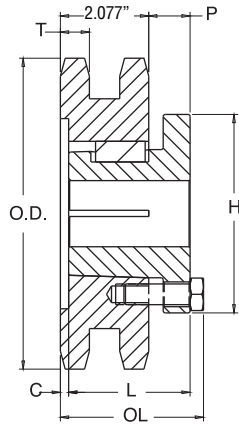

TYPE 14

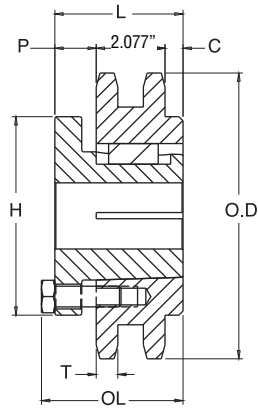

TYPE 15

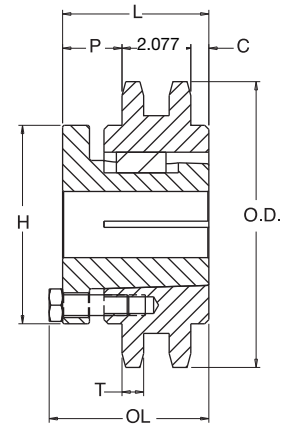

TYPE 18

SPROCKETS

Double - MST® Sprockets

No. Teeth	Catalog Number	Bushing	Diameters		Type	Max. Bore	Dimensions						Weight (Approx.)	
			Outside Dia.	Pitch Dia.			OL	L	C	H	P	T(nom)	With Hub	Rim Only
11	D100P11H	P1	5.010	4.437	14	1-3/4	2-15/16	1-15/16	3/4	3	5/8	.669	6.0	4.7
12	D100Q12H	Q2	5.420	4.830	12	2-5/8	4-7/32	3-1/2	7/16	4-1/8	1-55/64	.669	10.4	5.9
13	D100Q13H	Q2	5.820	5.223	12	2-5/8	4-7/32	3-1/2	7/16	4-1/8	1-55/64	.669	12.4	7.9
14	D100Q14H	Q1	6.230	5.617	14	2-11/16	3-3/32	2-1/2	5/16	4-1/8	3/4	.669	10.9	7.4
15	D100Q15H	Q1	6.630	6.012	14	2-11/16	3-3/32	2-1/2	5/16	4-1/8	3/4	.669	12.6	9.1
16	D100Q16H	Q1	7.030	6.407	14	2-11/16	3-3/32	2-1/2	5/16	4-1/8	3/4	.669	14.4	10.9
17	D100R17H	R1	7.440	6.803	14	3-3/4	3-7/32	2-7/8	1/16	5-3/8	7/8	.669	17.5	10.0
18	D100R18H	R1	7.840	7.198	14	3-3/4	3-7/32	2-7/8	1/16	5-3/8	7/8	.669	19.8	12.3
19	D100R19	R1	8.240	7.595	14	3-3/4	3-7/32	2-7/8	1/16	5-3/8	7/8	.669	22.4	14.9
20	D100R20	R1	8.640	7.991	14	3-3/4	3-7/32	2-7/8	1/16	5-3/8	7/8	.669	24.9	17.4
21	D100R21	R1	9.040	8.387	14	3-3/4	3-7/32	2-7/8	1/16	5-3/8	7/8	.669	27.8	20.3
22	D100R22	R1	9.440	8.783	14	3-3/4	3-7/32	2-7/8	1/16	5-3/8	7/8	.669	30.3	22.8
24	D100R24	R1	10.250	9.577	14	3-3/4	3-7/32	2-7/8	1/16	5-3/8	7/8	.669	37.0	29.5
35	D100R35	R1	14.640	13.945	14	3-3/4	3-7/32	2-7/8	1/16	5-3/8	7/8	.669	84.3	76.8
45	D100S45	S1	18.630	17.920	15	4-1/4	4-3/4	4-3/8	1-15/64	6-3/8	1-1/16	.669	151.5	138.0
60	D100S60	S1	24.600	23.884	15	4-1/4	4-3/4	4-3/8	1-15/64	6-3/8	1-1/16	.669	264.5	251.0
70	D100S70	S1	28.580	27.862	18	4-1/4	7-1/8	6-3/4	2 1/4	6-3/8	2-7/16	.669	371.5	358.0
80	D100S80	S1	32.570	31.839	18	4-1/4	7-1/8	6-3/4	2 1/4	6-3/8	2-7/16	.669	444.5	431.0

Sprockets with "H" suffix have hardened teeth.

Triple-Type B & C

No. Teeth	Catalog Number	Outside Diameter	Type	Bore (inches)		Hub (inches)		Weight Lbs. (Approx.)
				Stock	Rec. Max.	Dia.	Length Thru	
11	E100B11	5.010	B	1	2½	3¾	4¾	11.7
12	E100B12	5.420	B	1½	2½	3¾	4¾	13.7
13	E100B13	5.820	B	1½	2½	3¾	4¾	16.9
14	E100B14	6.230	B	1½	2½	4¾	4¾	20.2
15	E100B15	6.630	B	1½	3¾	4¾	4¾	25.0
16	E100B16	7.030	B	1½	3¾	5	4¾	29.3
17	E100B17	7.440	B	1½	3¾	5½	4¾	33.8
18	E100B18	7.840	B	1½	3¾	5½	4¾	38.6
19	E100B19	8.240	B	1½	3¾	5½	4¾	43.3
20	E100B20	8.640	B	1½	3¾	5½	4¾	47.9
21	E100B21	9.040	B	1½	3¾	5½	4¾	52.3
22	E100B22	9.440	B	1½	3¾	5½	4¾	57.5
23	E100B23	9.840	B	1½	3¾	5½	4¾	62.5
24	E100B24	10.250	B	1½	3¾	5½	4¾	69
25	E100B25	10.650	B	1½	3¾	5½	4¾	73
26	E100B26	11.050	B	1½	3¾	5½	4¾	79
30	E100B30	12.640	B	1½	3¾	5½	4¾	103
35	E100C35	14.640	C	1½	4	6	5	108
45	E100C45	18.630	C	1½	4	6	5	143
60	E100C60	24.600	C	1½	5½	7½	5	217
70	E100C70	28.580	C	1½	5½	7½	5	262
80	E100C80	32.570	C	1½	5½	7½	5	313

Maximum bores shown will accommodate standard keyseat and setscrew over keyseat. Slightly larger bores are possible with no keyseat, shallow keyseat, or setscrew at angle to keyseat.

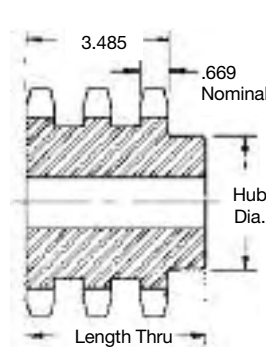

TYPE B

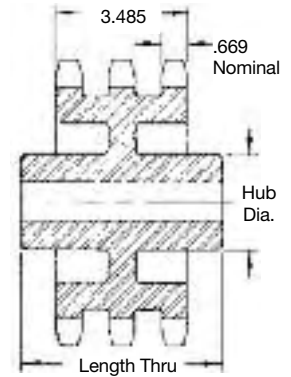

TYPE C

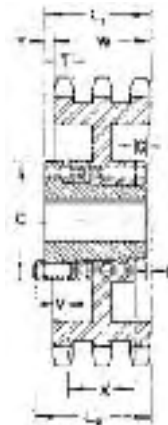

QD — TYPE B₁

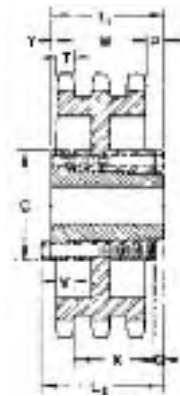

QD — TYPE C₃

Alteration Charges

See current discount sheet for alteration charges.

Triple-Type QD

No. Teeth	Catalog Number	Bush- ing	Diameters		Type	Max. Bore	Dimensions										Weight (Approx.)	
			Outside Diameter	Pitch Diameter			L ₁	L ₂	C	Y	P	G	V	X	T	W	With Hub	Rim Only
35	E100F35	F	14.640	13.945	B1	3 ¹⁵ / ₁₆	3 ⁶³ / ₆₄	4 ²³ / ₆₄	6 ⁶ / ₁₆	½	2 ³ / ₆₄	1 ¹ / ₁₆	½	2½	.669	3.485	112	100
45	E100F45	F	18.630	17.820	B1	3 ³ / ₁₆	3 ⁶³ / ₆₄	4 ²³ / ₆₄	6 ⁶ / ₁₆	½	2 ³ / ₆₄	1 ¹ / ₁₆	½	2½	.669	3.485	139	120
60	E100J60	J	24.600	28.884	C3	4 ⁷ / ₁₆	4½	5	7½	½	3 ³ / ₆₄	¾	1 ¹ / ₁₆	3 ³ / ₁₆	.669	3.485	197	178
70	E100J70	J	28.580	27.862	C3	4 ⁴ / ₁₆	4½	5	7½	½	3 ³ / ₆₄	¾	1 ¹ / ₁₆	3 ³ / ₁₆	.669	3.485	247	228
80	E100J80	J	32.570	31.839	C3	4 ⁴ / ₁₆	4½	5	7½	½	3 ³ / ₆₄	¾	1 ¹ / ₁₆	3 ³ / ₁₆	.669	3.485	287	268

No. 120 1½" Pitch

All Steel Stock Sprockets

Martin

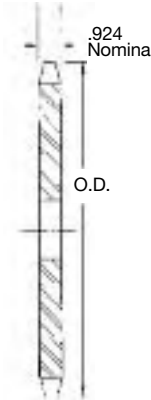

TYPE A

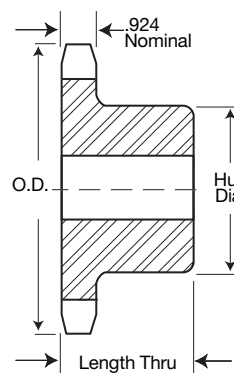

TYPE B

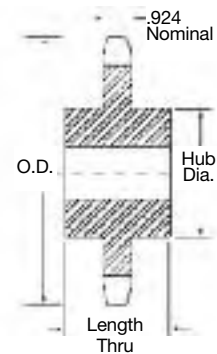

TYPE C

SPROCKETS

Single-Type B & C

Single-Type A

No. Teeth	Catalog Number	Outside Diameter	Type	Bore (inches)		Hub (inches)		Weight Lbs. (Approx.)	Type	Catalog Number	Stock Bore	Weight Lbs. (Approx.)
				Stock	Rec. Max.	Dia.	Length Thru					
8		4.520							A	120A8	1½	2.4
9	120B9	5.020	B	1½	1⅞	3½*	2½	5.3	A	120A9	1½	3.0
10	120B10	5.520	B	1½	2¼	3½*	2½	7.1	A	120A10	1½	3.8
11	120B11	6.010	B	1½	2¾	3½*	2½	7.6	A	120A11	1½	4.8
12	120B12	6.500	B	1½	2¾	4¼	2½	9.9	A	120A12	1½	5.8
13	120B13	6.990	B	1½	3	4¼	2½	12.4	A	120A13	1½	6.7
14	120B14	7.470	B	1½	3¼	4¼	2½	14.4	A	120A14	1½	8.0
15	120B15	7.960	B	1½	3¼	4¼	2½	16.7	A	120A15	1½	9.1
16	120B16	8.440	B	1½	3½	5¼	2½	19.9	A	120A16	1½	10.6
17	120B17	8.920	B	1½	3½	5¼	2½	20.8	A	120A17	1½	12.6
18	120B18	9.410	B	1½	3½	5¼	2½	22.2	A	120A18	1½	13.6
19	120B19	9.890	B	1½	3½	5¼	2½	24.8	A	120A19	1½	15.1
20	120B20	10.370	B	1½	3½	5¼	2½	25.8	A	120A20	1½	16.9
21	120B21	10.850	B	1½	3½	5¼	2½	26.7	A	120A21	1½	18.7
22	120B22	11.330	B	1½	3½	5¼	2½	28.2	A	120A22	1½	20.0
23	120B23	11.810	B	1½	3½	5¼	2½	30.3	A	120A23	1½	22.1
24	120B24	12.290	B	1½	3½	5¼	2½	32.1	A	120A24	1½	24.8
25	120B25	12.770	B	1½	3½	5¼	2½	34.6	A	120A25	1½	26.8
26	120B26	13.250	B	1½	4	6	2½	40.0	A	120A26	1½	28.3
27		13.730							A	120A27	1½	30.9
28	120B28	14.210	B	1½	4	6	2½	44.9	A	120A28	1½	33.6
30	120B30	15.170	B	1½	4	6	2½	50.2	A	120A30	1½	39.0
32	120B32	16.130	B	1½	4	6	2½	56.0	A	120A32	1½	43.9
33		16.610							A	120A33	1½	48.2
34		17.090							A	120A34	1½	50
35	120B35	17.570	B	1½	4	6	2½	62.4	A	120A35	1½	52
36	120B36	18.050	B	1½	4	6	2½	66.4	A	120A36	1½	56
40	120C40	19.960	C	1½	4	6	3½	92.0	A	120A40	1½	71
42	120C42	20.920	C	1½	4	6	3½	98.0	A	120A42	1½	75
45	120C45	22.350	C	1½	4	6	3½	99.2	A	120A45	1½	88
48	120C48	23.790	C	1½	4	6	4	113	A	120A48	1½	103
54	120C54	26.650	C	1½	4	6	4	133	A	120A54	1½	140
60	120C60	29.520	C	1½	5¼	7	4	160	A	120A60	1½	160
70	120C70	34.300	C	1½	5¼	7¼	4¼	206	A	120A70	1½	216
80	120C80	39.080	C	1½	5¼	7¼	4¼	254	A	120A80	1½	284
90		43.850							A	120A90	1½	358

* Has recessed groove in hub for chain clearance.

Maximum bores shown will accommodate standard keyseat and setscrew over keyseat. Slightly larger bores are possible with no keyseat, shallow keyseat, or setscrew at angle to keyseat.

Alteration Charges

See current discount sheet for alteration charges.

Single-Type QD With Hardened Teeth

No. Teeth	Catalog Number
12	120SF12H
13	120SF13H
14	120SF14H
15	120SF15H
16	120E16H
17	120E17H
18	120E18H
19	120E19H
20	120E20H
21	120E21H
22	120E22H
23	120E23H
24	120E24H
25	120E25H
26	120E26H
28	120E28H
30	120E30H

**SABER
TOOTH®**

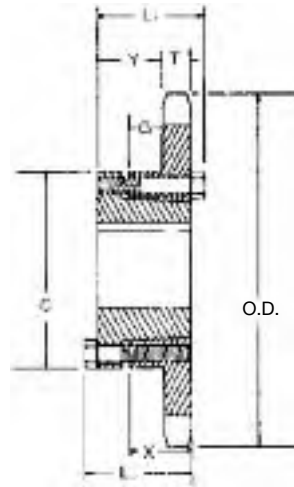

QD — TYPE B

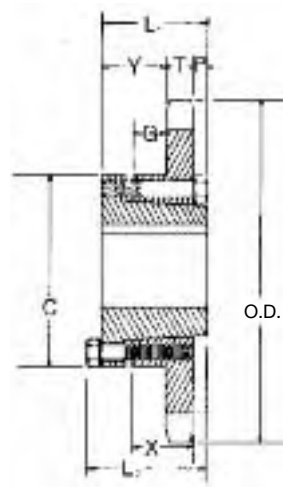

QD — TYPE B₁

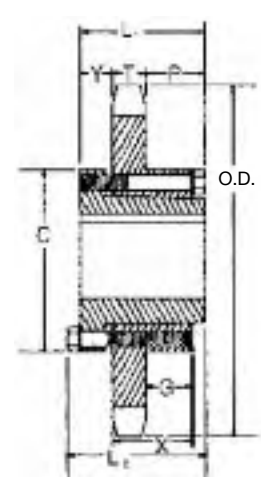

QD — TYPE C

Single-Type QD

No. Teeth	Catalog Number	Bush- ing	Diameters		Type	Max. Bore	Dimensions								Weight (Approx.)	
			Outside Diameter	Pitch Diameter			L ₁	L ₂	C	Y	P	G	X	T	With Hub	Rim Only
12	120SF12	SF	6.500	5.796	B	2 ¹⁵ / ₁₆	2 ¹ / ₄	2 ¹ / ₄	4 ³ / ₄	1 ³ / ₄		2 ³ / ₄	1 ¹ / ₄	.924	7.7	4.7
13	120SF13	SF	6.990	6.268	B										9.1	6.1
14	120SF14	SF	7.470	6.741	B										10.4	7.4
15	120SF15	SF	7.960	7.215	B	2 ¹⁵ / ₁₆	2 ¹ / ₄	2 ¹ / ₄	4 ³ / ₄	1 ³ / ₄		2 ³ / ₄	1 ¹ / ₄	.924	11.8	8.0
16	120E16	E	8.440	7.689	B1	3 ¹ / ₂	2 ¹ / ₂	2 ¹⁵ / ₁₆	6	1 ¹ / ₂		4 ⁵ / ₁₆	1 ¹ / ₂	.924	21.2	11.2
17	120E17	E	8.920	8.163	B1										23.4	13.4
18	120E18	E	9.410	8.638	B1										24.8	14.8
19	120E19	E	9.890	9.113	B1										26.5	16.5
20	120E20	E	10.370	9.589	B1										29.2	19.2
21	120E21	E	10.850	10.064	B1										29.9	19.9
22	120E22	E	11.330	10.540	B1										31.6	21.6
23	120E23	E	11.810	11.016	B1										33.8	23.8
24	120E24	E	12.290	11.492	B1										35.8	25.8
25	120E25	E	12.770	11.968	B1										38.1	28.1
26	120E26	E	13.250	12.444	B1										39.9	29.9
28	120E28	E	14.210	13.397	B1										49.7	34.7
30	120E30	E	15.170	14.350	B1	3 ¹ / ₂	2 ¹ / ₂	2 ¹⁵ / ₁₆	6	1 ¹ / ₂		4 ⁵ / ₁₆	1 ¹ / ₂	.924	49.4	39.4
32	120F32	F	16.130	15.303	C	3 ³ / ₁₆	3 ¹ / ₂	4	6 ³ / ₄	1	1 ¹ / ₁₆	1 ³ / ₁₆	2 ¹ / ₂	.924	62.0	50.5
35	120F35	F	17.570	16.734	C										71.0	59.5
36	120F36	F	18.050	17.211	C										74.9	63.4
40	120F40	F	19.960	19.118	C										88.5	77.0
42	120F42	F	20.920	20.072	C										94.5	83.0
45	120F45	F	22.350	21.503	C										95.5	84.0
48	120F48	F	23.790	22.935	C										103.5	92.0
54	120F54	F	26.650	25.798	C	3 ³ / ₁₆	3 ¹ / ₂	4	6 ³ / ₄	1	1 ¹ / ₁₆	1 ³ / ₁₆	2 ¹ / ₂	.924	125	114
60	120J60	J	29.520	28.661	C	4 ¹ / ₁₆	4 ¹ / ₂	5	7 ¹ / ₄	1 ¹ / ₁₆	2 ¹ / ₁₆	2 ¹ / ₁₆	3 ¹ / ₁₆	.924	159	140
70	120J70	J	34.300	33.434	C	4 ¹ / ₁₆	4 ¹ / ₂	5	7 ¹ / ₄	1 ¹ / ₁₆	2 ¹ / ₁₆	2 ¹ / ₁₆	3 ¹ / ₁₆	.924	196	177
80	120J80	J	39.080	38.207	C	4 ¹ / ₁₆	4 ¹ / ₂	5	7 ¹ / ₄	1 ¹ / ₁₆	2 ¹ / ₁₆	2 ¹ / ₁₆	3 ¹ / ₁₆	.924	241	222

SPROCKETS

No. 120 1½" Pitch

All Steel Stock Sprockets

Martin

Single-Taper Bushed

No. Teeth	Catalog Number	Bushing	Diameter		Max. Bore	Dimensions		Type	Weight (Approx.)	
			Outside Diameter	Pitch Diameter		L	C		Rim Only	Bushing Only
12	120BTB12	2012	6.498	5.796	2	1¼	3¾	B	5.5	1.7
13	120BTB13	2517	6.896	6.268	2½	1¼	4¼	B	6.0	3.5
14	120BTB14	2517	7.472	6.741	2½	1¼	4¼	B	7.0	3.5
15	120BTB15	2517	7.957	7.215	2½	1¼	4¼	B	8.0	3.5
16	120BTB16	3020	8.441	7.689	3	2	5¼	B	10.0	6.5
17	120BTB17	3020	8.924	8.163	3	2	5¼	B	11.0	6.5
18	120BTB18	3020	9.407	8.638	3	2	5¼	B	12.0	6.5
19	120BTB19	3020	9.889	9.113	3	2	5¼	B	14.0	6.5
20	120BTB20	3020	10.371	9.588	3	2	5¼	B	15.5	6.5
21	120BTB21	3020	10.851	10.064	3	2	5¼	B	17.5	6.5
24	120BTB24	3020	12.294	11.492	3	2	5¼	B	23.5	6.5
26	120BTB26	3020	13.254	12.444	3	2	5¼	B	28.5	6.5
30	120BTB30	3020	15.171	14.351	3	2	5¼	B	33.5	6.5
35	120CTB35	3020	17.566	16.734	3	2	5¼	C	52.0	6.5
45	120CTB45	3030	22.351	21.503	3	3	5¼	C	82.0	9.2
60	120CTB60	3535	29.522	28.661	3½	3½	6¼	C	140.0	14.0
70	120CTB70	3535	34.301	33.434	3½	3½	6¼	C	175.0	14.0
80	120CTB80	3535	39.078	38.207	3½	3½	6¼	C	220.0	14.0

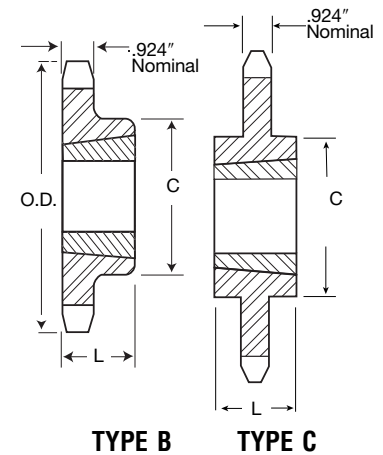

SPROCKETS

Single-Taper Bushed with Hardened Teeth

No. Teeth	Catalog Number
12	120BTB12 H
13	120BTB13 H
14	120BTB14 H
15	120BTB15 H
16	120BTB16 H
17	120BTB17 H
18	120BTB18 H
19	120BTB19 H
20	120BTB20 H
21	120BTB21 H
24	120BTB24 H
26	120BTB26 H
30	120BTB30 H

**SABER
TOOTH®**



Single-Type C — Steel 1½" Pitch

No. Teeth	Catalog Number	Outside Diameter	Bore (inches)		Hub (inches)		Weight Lbs. (Approx.)
			Stock	Rec. Max.	Diameter	Length	
11	120C11	6.010	1¼	2½	3¾	3¾	12.45
12	120C12	6.500	1¼	2¾	4¼	3¾	14.80
13	120C13	6.990	1¼	3	4¾	3¾	17.15
14	120C14	7.470	1¼	3¼	4¾	3¾	19.50

Double Single-Type A — Steel

No. Teeth	Catalog Number	Diameters		Type	Min. Bore	Max. Bore	Dimensions				Wt. (Approx.)
		Outside Diameter	Pitch Diameter				L	C	E	w Nom.	
15	DS120A15	7.960	7.215	A	1¼	3¾	3 ¹¹ / ₃₂	2 ¹ / ₁₆	5 ³² / ₆₄	.924	30.0
16	DS120A16	8.440	7.689	A	1¼	4	3 ¹ / ₃₂	2 ¹ / ₁₆	6	.924	34.0
17	DS120A17	8.920	8.163	A	1¼	4 ¹ / ₁₆	3 ¹ / ₃₂	2 ¹ / ₁₆	6 ³ / ₆₄	.924	37.0
18	DS120A18	9.410	8.638	A	1¼	5 ¹ / ₁₆	3 ¹ / ₃₂	2 ¹ / ₁₆	6 ³ / ₆₄	.924	42.0
19	DS120A19	9.890	9.113	A	1¼	5½	3 ¹ / ₃₂	2 ¹ / ₁₆	7 ²⁹ / ₆₄	.924	47.0
20	DS120A20	10.370	9.589	A	1¼	5 ⁵ / ₁₆	3 ¹ / ₃₂	2 ¹ / ₁₆	7 ¹⁵ / ₁₆	.924	51.0

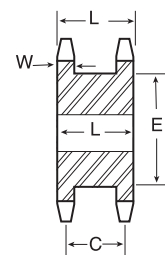

TYPE A

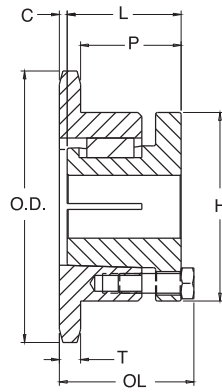

TYPE 4

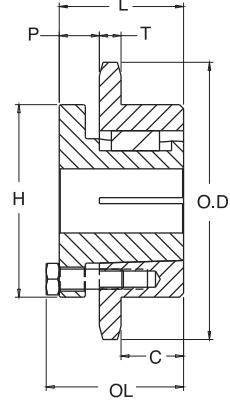

TYPE 5

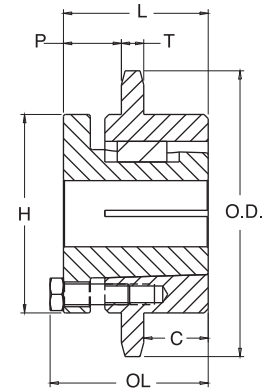

TYPE 6

Single - MST Sprockets

No. Teeth	Catalog Number	Bush- ing	Diameters		Type	Max. Bore	Dimensions						Weight (Approx.)	
			Outside Dia.	Pitch Dia.			OL	L	C	H	P	T(nom)	With Hub	Rim Only
11	120Q11H	Q1	6.010	5.324	4	2-11/16	2-25/32	2-1/2	0	4-1/8	1 9/16	.924	8.3	4.8
12	120Q12H	Q1	6.500	5.796	4	2-11/16	2-25/32	2-1/2	0	4-1/8	1 9/16	.924	9.8	6.3
13	120Q13H	Q1	6.990	6.268	4	2-11/16	2-25/32	2-1/2	0	4-1/8	1 9/16	.924	11.4	7.9
14	120Q14H	Q1	7.470	6.741	4	2-11/16	2-25/32	2-1/2	0	4-1/8	1 9/16	.924	12.7	9.2
15	120Q15H	Q1	7.960	7.215	4	2-11/16	2-25/32	2-1/2	0	4-1/8	1 9/16	.924	13.9	10.4
16	120Q16H	Q1	8.440	7.689	4	2-11/16	2-25/32	2-1/2	0	4-1/8	1-15/16	.924	15.3	11.8
16	120R16H	R1	8.440	7.689	4	3-3/4	3-5/32	2-7/8	0	5-3/8	1-15/16	.924	19.5	12.0
17	120Q17H	Q1	8.920	8.163	4	2-11/16	2-25/32	2-1/2	0	4-1/8	1-15/16	.924	16.9	13.4
17	120R17H	R1	8.920	8.163	4	3-3/4	3-5/32	2-7/8	0	5-3/8	1-15/16	.924	21.2	13.7
18	120Q18H	Q1	9.410	8.638	4	2-11/16	2-25/32	2-1/2	0	4-1/8	1-15/16	.924	19.1	15.6
18	120R18H	R1	9.410	8.638	4	3-3/4	3-5/32	2-7/8	0	5-3/8	1-15/16	.924	22.5	15.0
19	120R19H	R1	9.890	9.113	4	3-3/4	3-5/32	2-7/8	0	5-3/8	1-15/16	.924	24.4	16.9
20	120R20H	R1	10.370	9.589	4	3-3/4	3-5/32	2-7/8	0	5-3/8	1-15/16	.924	26.3	18.8
21	120R21H	R1	10.850	10.064	4	3-3/4	3-5/32	2-7/8	0	5-3/8	1-15/16	.924	28.2	20.7
22	120R22H	R1	11.330	10.540	4	3-3/4	3-5/32	2-7/8	0	5-3/8	1-15/16	.924	30.0	22.5
23	120R23H	R1	11.810	11.016	4	3-3/4	3-5/32	2-7/8	0	5-3/8	1-15/16	.924	31.8	24.3
24	120R24H	R1	12.290	11.492	4	3-3/4	3-5/32	2-7/8	0	5-3/8	1-15/16	.924	34.6	27.1
25	120R25H	R1	12.770	11.968	4	3-3/4	3-5/32	2-7/8	0	5-3/8	1-15/16	.924	36.6	29.1
26	120R26H	R1	13.250	12.444	5	3-3/4	3-5/32	2-7/8	1-1/16	5-3/8	7/8	.924	40.8	33.3
28	120R28H	R1	14.210	13.397	5	3-3/4	3-5/32	2-7/8	1-1/16	5-3/8	7/8	.924	45.5	38.0
30	120R30H	R1	15.170	14.350	5	3-3/4	3-5/32	2-7/8	1-1/16	5-3/8	7/8	.924	50.8	43.3
32	120R32	R1	16.130	15.303	5	3-3/4	3-5/32	2-7/8	1-1/16	5-3/8	7/8	.924	56.9	49.4
35	120R35	R2	17.570	16.734	6	3-5/8	5-5/32	4-7/8	2	5-3/8	1-15/16	.924	79.0	68.0
36	120R36	R2	18.050	17.211	6	3-5/8	5-5/32	4-7/8	2	5-3/8	1-15/16	.924	83.0	72.0
40	120R40	R2	19.960	19.118	6	3-5/8	5-5/32	4-7/8	2	5-3/8	1-15/16	.924	93.0	82.0
40	120S40	S1	19.960	19.118	5	4-1/4	4-3/4	4-3/8	2-3/8	6-3/8	1-1/16	.924	96.5	83.0
42	120S42	S1	20.920	20.072	5	4-1/4	4-3/4	4-3/8	2-3/8	6-3/8	1-1/16	.924	103.5	90.0
45	120R45	R2	22.350	21.503	6	3-5/8	5-5/32	4-7/8	2	5-3/8	1-15/16	.924	113.0	102.0
45	120S45	S1	22.350	21.503	5	4-1/4	4-3/4	4-3/8	2-3/8	6-3/8	1-1/16	.924	113.5	100.0
48	120S48	S1	23.790	22.935	5	4-1/4	4-3/4	4-3/8	2-3/8	6-3/8	1-1/16	.924	124.5	111.0
54	120S54	S1	26.650	25.798	5	4-1/4	4-3/4	4-3/8	2-3/8	6-3/8	1-1/16	.924	151.5	138.0
60	120R60	R2	29.520	28.661	6	3-5/8	5-5/32	4-7/8	2	5-3/8	1-15/16	.924	190.0	179.0
60	120S60	S1	29.520	28.661	5	4-1/4	4-3/4	4-3/8	2-3/8	6-3/8	1-1/16	.924	193.5	180.0
70	120R70	R2	34.300	33.434	6	3-5/8	5-5/32	4-7/8	2	5-3/8	1-15/16	.924	159.0	148.0
70	120S70	S2	34.300	33.434	5	4-3/16	7-1/8	6-3/4	2-7/8	6-3/8	2-15/16	.924	186.0	167.0
80	120R80	R2	39.080	38.207	6	3-5/8	5-5/32	4-7/8	2	5-3/8	1-15/16	.924	302.0	291.0
80	120S80	S2	39.080	38.207	6	4-3/16	7-1/8	6-3/4	2-7/8	6-3/8	2-15/16	.924	324.0	305.0

Sprockets with "H" suffix have hardened teeth.

No. 120-2

1½" Pitch

All Steel Stock Sprockets



Double-Type B & C

No. Teeth	Catalog Number	Outside Diameter	Type	Bore (inches)		Hub (inches)		Weight Lbs. (Approx.)
				Stock	Rec. Max.	Dia.	Length Thru	
11	D120B11	6.010	B	1½	2¾	3⅞	3¾	13.6
12	D120B12	6.500	B	1½	2¾	4⅞	3¾	17.3
13	D120B13	6.990	B	1½	3	4¾	3¾	21.1
14	D120B14	7.470	B	1½	3⅞	5	3¾	25.6
15	D120B15	7.960	B	1½	3¾	5¼	3¾	29.9
16	D120B16	8.440	B	1½	3¾	5¼	3¾	33.8
17	D120B17	8.920	B	1½	3¾	5¼	3¾	36.9
18	D120B18	9.410	B	1½	3¾	5¼	3¾	41.9
19	D120B19	9.890	B	1½	3¾	5¼	3¾	46.5
20	D120B20	10.370	B	1½	3¾	5¼	3¾	50.2
21	D120B21	10.850	B	1½	3¾	5¼	3¾	55.6
22	D120B22	11.330	B	1½	3⅞	5¼	4	64.0
23	D120B23	11.810	B	1½	4	6½	4	75.0
24	D120B24	12.290	B	1½	4	6½	4	79.0
25	D120B25	12.770	B	1½	4	6½	4	84.0
26	D120B26	13.250	B	1½	4	6½	4	90.0
30	D120B30	15.170	B	1½	4	6½	4	119
35	D120C35	17.570	C	1½	5¾	7¾	6	148
45	D120C45	22.350	C	1½	5¾	7¾	6	188
60	D120C60	29.520	C	1½	6¾	9¾	6¼	307

Maximum bores shown will accommodate standard keyseat and setscrew over keyseat. Slightly larger bores are possible with no keyseat, shallow keyseat, or setscrew at angle to keyseat.

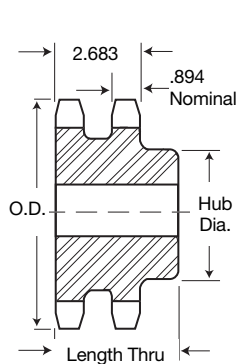

TYPE B

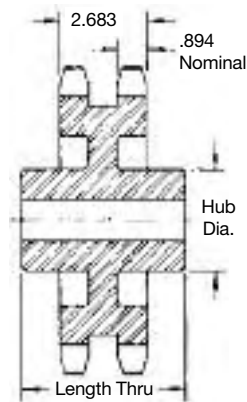

TYPE C

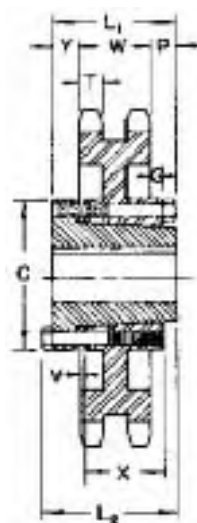

"QD" — TYPE C₅

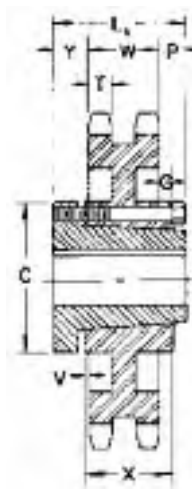

"QD" — TYPE C₆

Alteration Charges

See current discount sheet for alteration charges.

Double-Type "QD"

No. Teeth	Catalog Number	Bush-ing	Diameters		Type	Max. Bore	Dimensions										Weight (Approx.)	
			Outside Diameter	Pitch Diameter			L ₁	L ₂	C	Y	P	G	V	X	T	W	With Hub	Rim Only
30	D120J30	J	15.170	14.350	C5	4⅞	4½	5	7¼	1½	2⅞	2⅞	½	3⅞	.894	2.683	97.5	78.0
35	D120J35	J	17.570	16.734	C5	4⅞	4½	5	7¼	1½	2⅞	2⅞	½	3⅞	.894	2.683	112	93.0
45	D120J45	J	22.350	21.502	C5	4⅞	4½	5	7¼	1½	2⅞	2⅞	½	3⅞	.894	2.683	157	138
60	D120M60	M	29.520	28.661	C6	5¾	6¾	6¾	9	2¾	1⅞	1⅞	2⅞	5⅞	.894	2.683	271	234

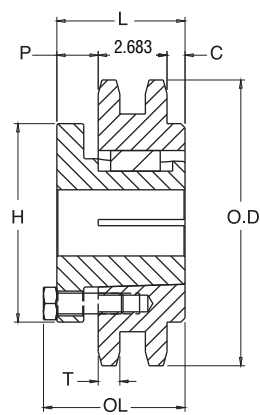

TYPE 15

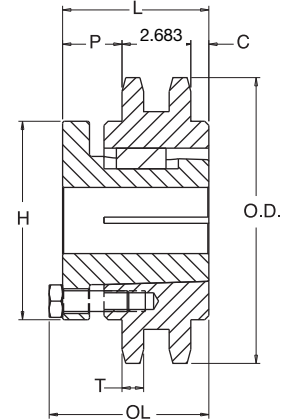

TYPE 18

Double - MST[®] Sprockets

No. Teeth		Bush- ing	Diameters		Type	Max. Bore	Dimensions						Weight (Approx.)	
			Outside Dia.	Pitch Dia.			OL	L	C	H	P	T(nom)	With Hub	Rim Only
30	D120S30	S1	15.170	14.350	15	4-1/4	4-3/4	4-3/8	5/8	6-3/8	1-1/16	.894	118.5	105.0
35	D120S35	S1	17.570	16.734	15	4-1/4	4-3/4	4-3/8	5/8	6-3/8	1-1/16	.894	161.5	148.0
45	D120S45	S2	22.350	21.503	18	4-3/16	7-1/8	6-3/4	1-27/32	6-3/8	2-7/32	.894	287.0	268.0
60	D120U60	U0	29.520	28.661	15	5-1/2	5-23/32	5-1/4	1-9/32	8-3/8	19/32	.894	213.0	183.0

Sprockets with "H" suffix have hardened teeth.

No. 140

1³/₄" Pitch

All Steel Stock Sprockets

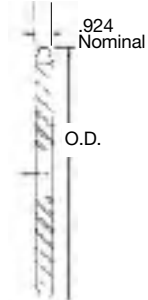

TYPE A

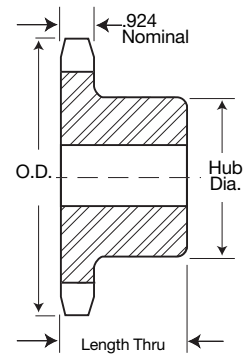

TYPE B

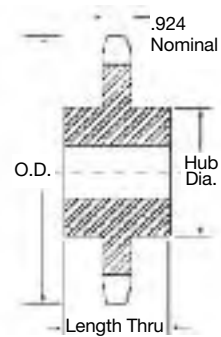

TYPE C

Single-Type B & C

Single-Type A

No. Teeth	Catalog Number	Outside Diameter	Type	Bore (inches)		Hub (inches)		Weight Lbs (Approx.)	Type	Catalog Number	Stock Bore	Weight Lbs. (Approx.)
				Stock	Rec. Max.	Dia.	Length Thru					
11	140B11	7.010	B	1½	2¼	4¼	2¼	11.3	A	140A11	1½	5.0
12	140B12	7.580	B	1½	3	4½	2¼	13.2	A	140A12	1½	7.8
13	140B13	8.150	B	1½	3½	5½	2½	18.9	A	140A13	1½	8.2
14	140B14	8.720	B	1½	3¾	5½	2½	20.4	A	140A14	1½	10.0
15	140B15	9.280	B	1½	4¼	6¼	2½	25.1	A	140A15	1½	11.0
16	140B16	9.850	B	1½	4¼	6¼	2½	27.9	A	140A16	1½	14.0
17	140B17	10.410	B	1½	4¼	6¼	2½	29.8	A	140A17	1½	16.0
18	140B18	10.980	B	1½	4¼	6¼	2½	32.0	A	140A18	1½	18.0
19	140B19	11.540	B	1½	4¼	6¼	2½	34.1	A	140A19	1½	21.0
20	140B20	12.100	B	1½	4¼	6¼	2½	36.0	A	140A20	1½	23.0
21	140B21	12.660	B	1½	4¼	6¼	2½	38.7	A	140A21	1½	25.0
22	140B22	13.220	B	1½	4¼	6¼	2½	40.6	A	140A22	1½	28.0
23	140B23	13.780	B	1½	4¼	6¼	2½	42.1	A	140A23	1½	30.0
24	140B24	14.340	B	1½	4¼	6¼	2½	46.2	A	140A24	1½	33.0
25	140B25	14.900	B	1½	4¼	6¼	2½	47.8	A	140A25	1½	34.0
26	140B26	15.460	B	1½	4¼	6¼	3	57.2	A	140A26	1½	39.0
27	140B27	16.020	B	1½	4¼	6¼	3	58.5	A	140A27	1½	41.0
28	140B28	16.580	B	1½	4¼	6¼	3	62.2	A	140A28	1½	45.0
30	140B30	17.700	B	1½	4¼	6¼	3	69.8	A	140A30	1½	52.0
31		18.260								140A31	1½	56.0
32	140B32	18.820	B	1½	4¼	6¼	3	76.3	A	140A32	1½	60.0
35	140C35	20.490	C	1½	5¼	7	4	108	A	140A35	1½	73.0
36		21.050								140A36	1½	77.0
40	140C40	23.290	C	1½	5¼	7	4	121	A	140A40	1½	93.0
45	140C45	26.080	C	1½	5¼	7	4	142	A	140A45	1½	131
48	140C48	27.750	C	1½	5¼	7	4	150	A	140A48	1½	134
54	140C54	31.100	C	1½	5¼	7	4	177	A	140A54	1½	173
60	140C60	34.440	C	1½	5¼	7	5	220	A	140A60	1½	219
70	140C70	40.020	C	1½	5¼	7½	5	282	A	140A70	1½	292
80	140C80	45.590	C	1½	5¼	7½	5	331	A	140A80	1½	402

Maximum bores shown will accommodate standard keyseat and setscrew over keyseat. Slightly larger bores are possible with no keyseat, shallow keyseat, or setscrew at angle to keyseat.

Alteration Charges

See current discount sheet for alteration charges.

Single-Type QD With Hardened Teeth

No. Teeth	Catalog Number
11	140SF11 H
12	140SF12 H
13	140SF13 H
14	140E14 H
15	140E15 H
16	140E16 H
17	140E17 H
18	140E18 H
19	140E19 H
20	140E20 H
21	140E21 H
22	140E22 H
23	140F23 H
24	140F24 H
25	140F25 H
26	140F26 H
30	140F30 H

**SABER
TOOTH®**

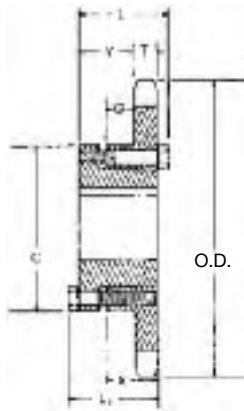

QD — TYPE B

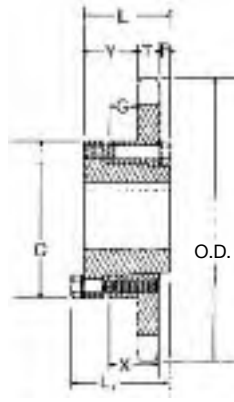

QD — TYPE B₁

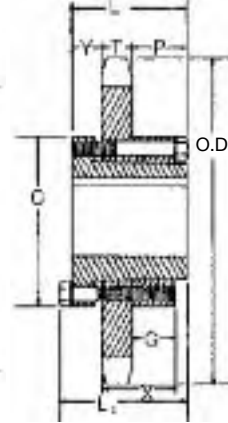

QD — TYPE C

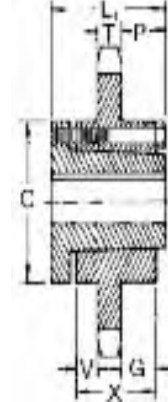

QD — TYPE C₁

SPROCKETS

Single-Type QD

No. Teeth	Catalog Number	Bush- ing	Diameters		Type	Max. Bore	Dimensions								Weight (Approx.)		
			Outside Diameter	Pitch Diameter			L ₁	L ₂	C	Y	P	G	V	X	T	With Hub	Rim Only
11	140SF11	SF	7.010	6.212	B	2 5/16	2 1/4	2 1/4	4 3/4	1 1/4		2 1/4		1 1/4	.924	8.6	5.6
12	140SF12	SF	7.580	6.762	B	2 5/16	2 1/4	2 1/4	4 3/4	1 1/4		2 1/4		1 1/4	.924	10.4	7.4
13	140SF13	SF	8.150	7.313	B	2 5/16	2 1/4	2 1/4	4 3/4	1 1/4		2 1/4		1 1/4	.924	11.9	8.9
14	140E14	E	8.720	7.864	B1	3 1/2	2 3/8	2 5/16	6	1 1/8	1/2	5/8		1 3/8	.924	21.6	11.6
15	140E15	E	9.280	8.417	B1											24.2	14.2
16	140E16	E	9.850	8.970	B1											25.9	15.9
17	140E17	E	10.410	9.524	B1											28.0	18.0
18	140E18	E	10.980	10.078	B1											29.6	19.6
19	140E19	E	11.540	10.632	B1											32.0	22.0
20	140E20	E	12.100	11.187	B1											34.6	24.6
21	140E21	E	12.660	11.742	B1											37.6	27.6
22	140E22	E	13.220	12.297	B1	3 1/2	2 3/8	2 5/16	6	1 1/8	1/2	5/8		1 3/8	.924	39.5	29.5
23	140F23	F	13.780	12.852	B1	3 5/16	3 3/8	4	6 3/4	2 1/8	1/2	1 3/8		2 1/2	.924	48.0	36.4
24	140F24	F	14.340	13.407	B1											51.6	40.1
25	140F25	F	14.900	13.963	B1											53.8	42.3
26	140F26	F	15.460	14.518	B1											58.0	46.5
30	140F30	F	17.700	16.742	B1	3 5/16	3 3/8	4	6 3/4	2 1/8	1/2	1 3/8		2 1/2	.924	72.0	60.4
35	140F35	F	20.490	19.523	C	3 5/16	3 3/8	4	6 3/4	1 1/2	1 1/8	1 3/8		2 1/2	.924	89.5	78.0
36	140F36	F	21.050	20.079	C	3 5/16	3 3/8	4	6 3/4	1	1 1/8	1 3/8		2 1/2	.924	95.5	84.0
40	140J40	J	23.290	22.305	C	4 1/8	4 1/4	5	7 1/4	1 1/8	2 3/8	2 1/4		3 3/8	.924	117	98.0
45	140J45	J	26.080	25.087	C											139	120
48	140J48	J	27.750	26.757	C											148	129
54	140J54	J	31.100	30.097	C											168	149
60	140J60	J	34.440	33.438	C	4 1/8	4 1/4	5	7 1/4	1 1/8	2 3/8	2 1/4		3 3/8	.924	205	186
70	140M70	M	40.020	39.006	C1	5 1/2	6 3/8	6 3/4	9	2 3/8	2 3/8	2 1/2	1 1/2	5 3/8	.924	301	264
80	140M80	M	45.590	44.575	C1	5 1/2	6 3/8	6 3/4	9	2 3/8	2 3/8	2 1/2	1 1/2	5 3/8	.924	385	348

No. 140

1³/₄" Pitch

All Steel Stock Sprockets



Single-Taper Bushed with Hardened Teeth

No. Teeth	Catalog Number
12	140BTB12 H
13	140BTB13 H
14	140BTB14 H
15	140BTB15 H
16	140BTB16 H
17	140BTB17 H
18	140BTB18 H
19	140BTB19 H
21	140BTB21 H
26	140BTB26 H

SABER TOOTH[®]

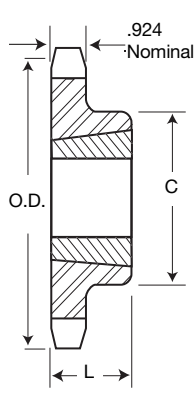

TYPE B

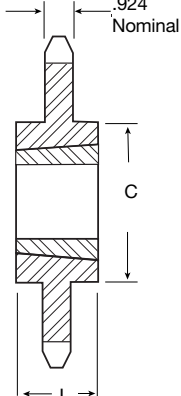

TYPE C



SPROCKETS

Single-Taper Bushed

No. Teeth	Catalog Number	Bushing	Diameter		Max. Bore	Dimensions		Type	Weight (Approx.)	
			Outside Diameter	Pitch Diameter		L	C		Rim Only	Bushing Only
12	140BTB12	2517	7.581	6.762	2 ¹ / ₂	1 ¹ / ₄	4 ¹ / ₄	B	7.0	3.5
13	140BTB13	3020	8.150	7.313	3	2	5 ¹ / ₄	B	8.0	6.5
14	140BTB14	3020	8.718	7.864	3	2	5 ¹ / ₄	B	10.0	6.5
15	140BTB15	3020	9.283	8.417	3	2	5 ¹ / ₄	B	12.0	6.5
16	140BTB16	3020	9.848	8.970	3	2	5 ¹ / ₄	B	14.0	6.5
17	140BTB17	3020	10.411	9.524	3	2	5 ¹ / ₄	B	16.0	6.5
18	140BTB18	3020	10.975	10.078	3	2	5 ¹ / ₄	B	18.0	6.5
19	140BTB19	3020	11.537	10.632	3	2	5 ¹ / ₄	B	20.0	6.5
21	140BTB21	3020	12.660	11.742	3	2	5 ¹ / ₄	B	24.0	6.5
26	140BTB26	3020	15.463	14.518	3	2	5 ¹ / ₄	B	40.0	6.5
35	140CTB35	3535	20.494	19.523	3 ¹ / ₂	3 ¹ / ₂	6 ¹ / ₄	C	78.0	14
45	140CTB45	4040	26.076	25.087	4	4	7 ¹ / ₄	C	118.0	22
60	140CTB60	4040	34.442	33.438	4	4	7 ¹ / ₄	C	188.0	22
70	140CTB70	4040	40.017	39.006	4	4	7 ¹ / ₄	C	241.0	22

Double Single-Type A — Steel

No. Teeth	Catalog Number	Diameters		Type	Min. Bore	Max. Bore	Dimensions			w Nom.	Wt. (Approx.)
		Outside Diameter	Pitch Diameter				L	C	E		
14	DS140A14	8.720	7.864	A	1 ¹ / ₁₆	3 ³ / ₁₆	3 ³⁹ / ₆₄	2 ¹¹ / ₁₆	5 ⁵ / ₁₆	.924	35.0
15	DS140A15	9.280	8.417	A	1 ¹ / ₁₆	4 ¹ / ₁₆	3 ³⁹ / ₆₄	2 ¹¹ / ₁₆	6 ²⁹ / ₆₄	.924	43.0
16	DS140A16	9.850	8.970	A	1 ¹ / ₁₆	5 ¹ / ₁₆	3 ³⁹ / ₆₄	2 ¹¹ / ₁₆	7 ⁷ / ₆₄	.924	49.0
17	DS140A17	10.410	9.524	A	1 ¹ / ₁₆	5 ⁹ / ₁₆	3 ³⁹ / ₆₄	2 ¹¹ / ₁₆	7 ³⁷ / ₆₄	.924	58.0
18	DS140A18	10.980	10.078	A	1 ¹ / ₁₆	6 ¹ / ₁₆	3 ³⁹ / ₆₄	2 ¹¹ / ₁₆	8 ³ / ₆₄	.924	66.0

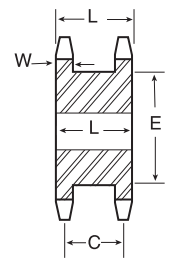

TYPE A

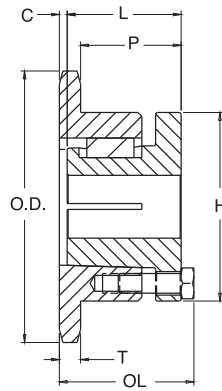

TYPE 4

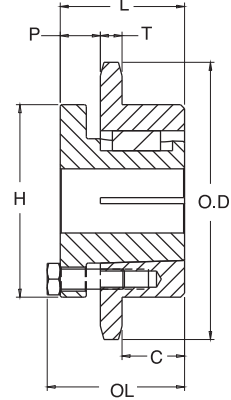

TYPE 5

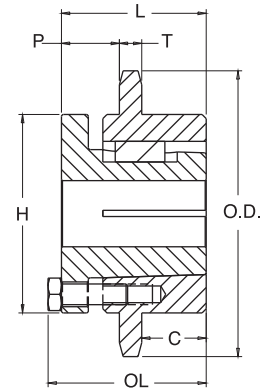

TYPE 6

Single - MST[®] Sprockets

No. Teeth	Catalog Number	Bush-ing	Diameters		Type	Max. Bore	Dimensions						Weight (Approx.)	
			Outside Dia.	Pitch Dia.			OL	L	C	H	P	T(nom)	With Hub	Rim Only
11	140Q11H	Q1	7.010	6.212	4	2-11/16	2-25/32	2-1/2	0	4-1/8	1 9/16	.924	9.9	6.4
12	140Q12H	Q1	7.580	6.762	4	2-11/16	2-25/32	2-1/2	0	4-1/8	1 9/16	.924	12.5	9.0
13	140R13H	R1	8.150	7.313	4	3-3/4	3-5/32	2-7/8	0	5-3/8	1-15/16	.924	18.6	11.1
14	140R14H	R1	8.720	7.864	4	3-3/4	3-5/32	2-7/8	0	5-3/8	1-15/16	.924	20.1	12.6
15	140R15H	R1	9.280	8.417	4	3-3/4	3-5/32	2-7/8	0	5-3/8	1-1/16	.924	22.2	14.7
16	140R16H	R1	9.850	8.970	4	3-3/4	3-5/32	2-7/8	0	5-3/8	1-1/16	.924	24.0	16.5
17	140R17H	R1	10.410	9.524	4	3-3/4	3-5/32	2-7/8	0	5-3/8	1-15/16	.924	26.0	18.5
18	140R18H	R1	10.980	10.078	4	3-3/4	3-5/32	2-7/8	0	5-3/8	1-15/16	.924	28.0	20.5
19	140R19H	R1	11.540	10.632	4	3-3/4	3-5/32	2-7/8	0	5-3/8	1-15/16	.924	30.5	23.0
20	140R20H	R1	12.100	11.187	4	3-3/4	3-5/32	2-7/8	0	5-3/8	1-15/16	.924	32.9	25.4
21	140R21H	R1	12.660	11.742	4	3-3/4	3-5/32	2-7/8	0	5-3/8	1-15/16	.924	35.3	27.8
22	140R22H	R1	13.220	12.297	5	3-3/4	3-5/32	2-7/8	1-1/16	5-3/8	7/8	.924	40.0	32.5
23	140R23H	R1	13.780	12.852	5	3-3/4	3-5/32	2-7/8	1-1/16	5-3/8	7/8	.924	43.5	36.0
24	140R24H	R1	14.340	13.407	5	3-3/4	3-5/32	2-7/8	1-1/16	5-3/8	7/8	.924	45.1	37.6
25	140R25H	R1	14.900	13.963	5	3-3/4	3-5/32	2-7/8	1-1/16	5-3/8	7/8	.924	47.8	40.3
26	140R26H	R1	15.460	14.518	5	3-3/4	3-5/32	2-7/8	1-1/16	5-3/8	7/8	.924	51.5	44.0
30	140R30H	R2	17.700	16.742	5	3-5/8	5-5/32	4-7/8	2	5-3/8	7/8	.924	79.0	68.0
35	140R35	R2	20.490	19.523	6	3-5/8	5-5/32	4-7/8	2	5-3/8	7/8	.924	99.0	88.0
36	140R36	R2	21.050	20.079	6	3-5/8	5-5/32	4-7/8	2	5-3/8	7/8	.924	101.0	90.0
36	140S36	S1	21.050	20.079	5	4-1/4	43/4	4-3/8	2-3/8	6-3/8	1-1/16	.924	102.5	89.0
40	140R40	R2	23.290	22.305	6	3-5/8	5-5/32	4-7/8	2	5-3/8	7/8	.924	120.0	109.0
40	140S40	S1	23.290	22.305	5	4-1/4	4-3/4	4-3/8	2-3/8	6-3/8	1-1/16	.924	120.5	107.0
45	140S45	S1	26.080	25.087	5	4-1/4	4-3/4	43/8	2-3/8	6-3/8	1-1/16	.924	145.5	132.0
48	140S48	S2	27.750	26.757	6	4-3/16	7-1/2	6-3/4	2-7/8	6-3/8	2-15/16	.924	188.0	169.0
54	140S54	S2	31.100	30.097	6	4-3/16	7-1/2	6-3/4	2-7/8	6-3/8	2-15/16	.924	227.0	208.0
60	140S60	S2	34.440	33.438	6	4-3/16	7-1/2	6-3/4	2-7/8	6-3/8	2-15/16	.924	249.0	230.0
70	140S70	S2	40.020	39.006	6	4-3/16	7-1/2	6-3/4	2-7/8	6-3/8	2-15/16	.924	330.0	311.0
80	140S80	S2	45.590	44.575	6	4-3/16	7-1/2	6-3/4	2-7/8	6-3/8	2-15/16	.924	261.0	242.0

Sprockets with "H" suffix have hardened teeth.

No. 140-2

1³/₄" Pitch

All Steel Stock Sprockets



Double-Type B & C

No. Teeth	Catalog Number	Outside Diameter	Type	Bore (inches)		Hub (inches)		Weight Lbs. (Approx.)
				Stock	Rec. Max.	Dia.	Length Thru	
13	D140B13	8.150	B	1 ¹ / ₂	3 ⁵ / ₁₆	5	3 ³ / ₄	29
14	D140B14	8.720	B	1 ¹ / ₂	3 ¹ / ₂	5 ¹ / ₂	3 ³ / ₄	34.8
15	D140B15	9.280	B	1 ¹ / ₂	4 ¹ / ₂	6 ¹ / ₂	3 ³ / ₄	42.5
16	D140B16	9.850	B	1 ¹ / ₂	5 ¹ / ₄	7	4	48.1
17	D140B17	10.410	B	1 ¹ / ₂	5 ¹ / ₄	7	4	57.5
18	D140B18	10.980	B	1 ¹ / ₂	5 ¹ / ₄	7	4	65.6
19	D140B19	11.540	B	1 ¹ / ₂	5 ¹ / ₄	7	4	72.0
20	D140B20	12.100	B	1 ¹ / ₂	5 ¹ / ₄	7	4	76.0
21	D140B21	12.660	B	1 ¹ / ₂	5 ¹ / ₄	7	4	82.0
22	D140B22	13.220	B	1 ¹ / ₂	5 ¹ / ₄	7	4	94.0
23	D140B23	13.780	B	1 ¹ / ₂	5 ¹ / ₄	7	4	100
24	D140B24	14.340	B	1 ¹ / ₂	5 ¹ / ₄	7	4	104
25	D140B25	14.900	B	1 ¹ / ₂	5 ¹ / ₄	7	4	120
26	D140B26	15.460	B	1 ¹ / ₂	5 ¹ / ₄	7	4	128
35	D140C35	20.490	C	1 ¹ / ₂	5 ¹ / ₂	7 ¹ / ₂	6	180
45	D140C45	26.080	C	1 ¹ / ₂	5 ¹ / ₂	7 ¹ / ₂	6	232
60	D140C60	34.440	C	1 ¹ / ₂	6 ¹ / ₂	9 ¹ / ₂	6 ¹ / ₄	372

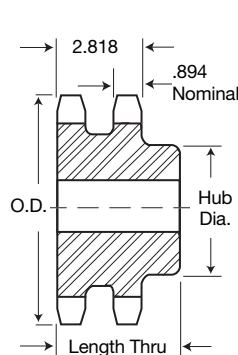

TYPE B

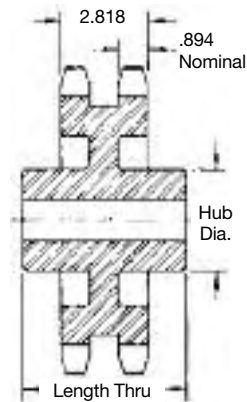

TYPE C

Maximum bores shown will accommodate standard keyseat and setscrew over keyseat. Slightly larger bores are possible with no keyseat, shallow keyseat, or setscrew at angle to keyseat.

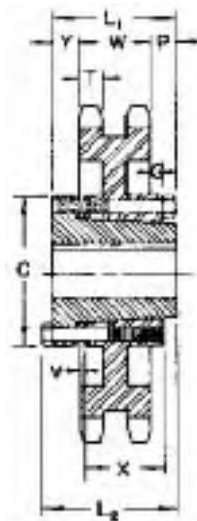

QD — TYPE C₅

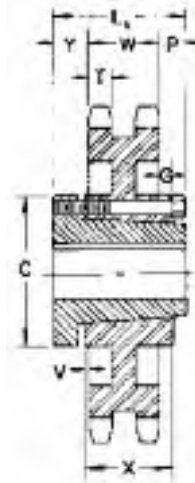

QD — TYPE C₆

Alteration Charges

See current discount sheet for alteration charges.

Double-Type QD

No. Teeth	Catalog Number	Bush-ing	Diameters		Type	Max. Bore	Dimensions										Weight (Approx.)	
			Outside Diameter	Pitch Diameter			L ₁	L ₂	C	Y	P	G	V	X	T	W	With Hub	Rim Only
35	D140J35	J	20.490	19.523	C5	4 ¹ / ₁₆	4 ¹ / ₂	5	7 ¹ / ₄	3 ¹ / ₃₂	2 ¹ / ₃₂	1 ¹⁹ / ₃₂	7 ¹ / ₃₂	3 ³ / ₁₆	.894	2.818	137	128
45	D140J45	J	26.080	25.087	C5	4 ¹ / ₁₆	4 ¹ / ₂	5	7 ¹ / ₄	3 ¹ / ₃₂	2 ¹ / ₃₂	1 ¹⁹ / ₃₂	7 ¹ / ₃₂	3 ³ / ₁₆	.894	2.818	195	176
60	D140M60	M	34.440	33.438	C6	5 ¹ / ₂	6 ¹ / ₄	6 ¹ / ₄	9	2 ¹ / ₃₂	1 ²³ / ₃₂	1 ¹⁹ / ₃₂	2 ¹ / ₃₂	5 ¹ / ₁₆	.894	2.818	339	302

Single-Type B & C

Single-Type A — Plate

No. Teeth	Catalog Number	Outside Diameter	Type	Bore (inches)		Hub (inches)		Weight Lbs. (Approx.)	Type	Catalog Number	Stock Bore	Weight Lbs. (Approx.)
				Stock	Rec. Max.	Dia.	Length Thru					
8	160B8	6.030	B	1½	1¾	3¼	2¼	8.0	A	160A8	1½	5.0
9	160B9	6.700	B	1½	2¼	3¼	2¼	10.0	A	160A9	1½	7.0
10	160B10	7.360	B	1½	2¾	4¼	2¼	12.0	A	160A10	1½	8.0
11	160B11	8.010	B	1½	3¼	4¼	2½	17.0	A	160A11	1½	10.0
12	160B12	8.660	B	1½	3¾	5¼	2½	21.0	A	160A12	1½	12.0
13	160B13	9.310	B	1½	4	6	2¼	28.0	A	160A13	1½	16.0
14	160B14	9.960	B	1½	4½	6½	2¼	32.0	A	160A14	1½	17.0
15	160B15	10.610	B	1½	5¼	7	2¼	37.0	A	160A15	1½	21.0
16	160B16	11.260	B	1½	5¾	7	2¼	41.0	A	160A16	1½	24.0
17	160B17	11.900	B	1½	5¾	7	2¼	45.0	A	160A17	1½	27.0
18	160B18	12.540	B	1½	5¾	7	2¼	48.0	A	160A18	1½	30.0
19	160B19	13.190	B	1½	5¾	7	2¼	52.0	A	160A19	1½	34.0
20	160B20	13.830	B	1½	5¾	7	2¼	56.0	A	160A20	1½	38.0
21	160B21	14.470	B	1½	5¾	7	2¼	59.0	A	160A21	1½	42.0
22	160B22	15.110	B	1½	5¾	7	2¼	65.0	A	160A22	1½	46.0
23	160B23	15.750	B	1½	5¾	7	2¼	68.0	A	160A23	1½	50.0
24	160B24	16.390	B	1½	5¾	7	3	77.0	A	160A24	1½	56.0
25	160B25	17.030	B	1½	5¾	7	3	81.0	A	160A25	1½	61.0
26	160B26	17.670	B	1½	5¾	7	3	86.0	A	160A26	1½	65.0
27	160B27	18.310	B	1½	5¾	7	3	91.0	A	160A27	1½	71.0
28	160B28	18.950	B	1½	5¾	7	3	98.0	A	160A28	1½	77.0
30	160B30	20.230	B	1½	5¾	7	3	108	A	160A30	1½	90.0
35	160C35	23.420	C	1½	5¾	8	4½	154	A	160A35	1½	121
40	160C40	26.610	C	1½	5¾	8	4½	196	A	160A40	1½	138
45	160C45	29.800	C	1½	5¾	8	5	234	A	160A45	1½	204
54	160C54	35.540	C	1½	5¾	8	5	276	A	160A54	1½	294
60	160C60	39.360	C	1½	5¾	8	5	329	A	160A60	1½	366
70	160C70	45.730	C	1½	5¾	8	5	446	A	160A70	1½	507
80	160C80	52.100	C	1½	5¾	8	6	612	A	160A80	1½	656

Single-Type C — Steel 2" Pitch

No. Teeth	Catalog Number	Outside Diameter	Bore (inches)		Hub (inches)		Weight Lbs. (Approx.)
			Stock	Rec. Max.	Diameter	Length	
11	160C11	8.010	1½"	3¼"	4½"	4½"	21.0
12	160C12	8.660	1½"	3¼"	5½"	4½"	26.0



Maximum bores shown will accommodate standard keyseat and setscrew over keyseat. Slightly larger bores are possible with no keyseat, shallow keyseat, or setscrew at angle to keyseat.

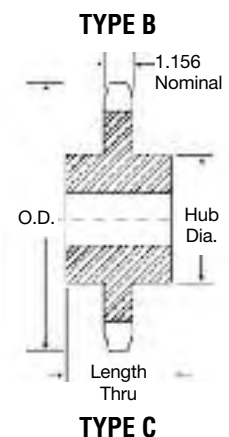
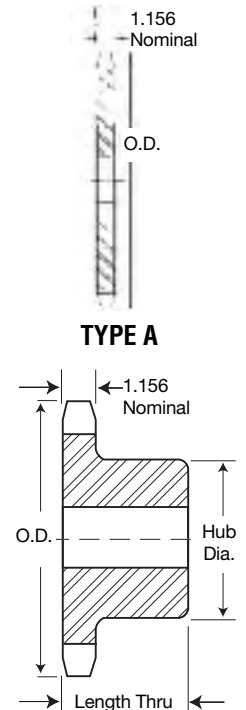

Alteration Charges

See current discount sheet for alteration charges.

No. 160 2" Pitch

All Steel Stock Sprockets



Single-Type QD With Hardened Teeth

No. Teeth	Catalog Number
12	160E12 H
13	160E13 H
14	160E14 H
15	160F15 H
16	160F16 H
17	160F17 H
18	160F18 H
19	160F19 H
20	160F20 H
21	160F21 H
22	160F22 H
23	160F23 H
24	160F24 H
25	160F25 H
26	160J26 H
28	160J28 H
30	160J30 H

**SABER
TOOTH®**

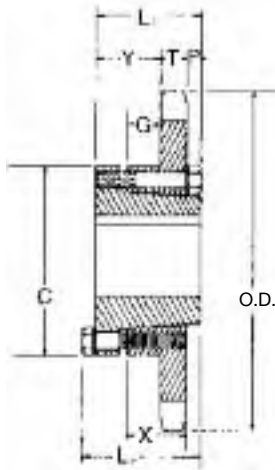

QD — TYPE B₁

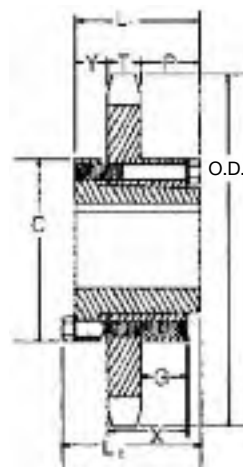

QD — TYPE C

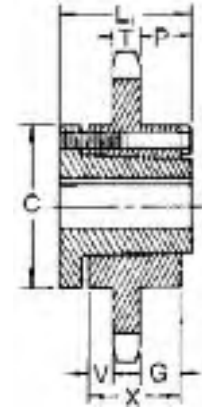

QD — TYPE C₁



SPROCKETS

Single-Type QD

No. Teeth	Catalog Number	Bushing	Diameters		Type	Max. Bore	Dimensions								Weight (Approx.)			
			Outside Diameter	Pitch Diameter			L ₁	L ₂	C	Y	P	G	V	X	T	With Hub	Rim Only	
12	160E12	E	8.660	7.727	B1	3 ¹ / ₂	2 ¹ / ₂	2 ⁵ / ₁₆	6	1 ¹ / ₁₆	1 ¹ / ₂	1 ¹ / ₃₂			1 ¹ / ₂	1.156	21.0	11
13	160E13	E	9.310	8.357	B1	3 ¹ / ₂	2 ¹ / ₂	2 ⁵ / ₁₆	6	1 ¹ / ₁₆	1 ¹ / ₂	1 ¹ / ₃₂			1 ¹ / ₂	1.156	24.0	14
14	160E14	E	9.960	8.988	B1	3 ¹ / ₂	2 ¹ / ₂	2 ⁵ / ₁₆	6	1 ¹ / ₁₆	1 ¹ / ₂	1 ¹ / ₃₂			1 ¹ / ₂	1.156	26.0	16
15	160F15	F	10.610	9.620	B1	3 ¹ / ₁₆	3 ¹ / ₂	4	6 ¹ / ₂	2 ¹ / ₁₆	1 ¹ / ₂	1 ¹ / ₃₂			2 ¹ / ₂	1.156	35.5	24
16	160F16	F	11.260	10.252	B1												38.5	27
17	160F17	F	11.900	10.885	B1												42.5	31
18	160F18	F	12.540	11.518	B1												46.5	35
19	160F19	F	13.190	12.151	B1												49.5	38
20	160F20	F	13.830	12.785	B1												53.5	42
21	160F21	F	14.740	13.419	B1												56.5	45
22	160F22	F	15.110	14.053	B1												62.5	51
23	160F23	F	15.750	14.688	B1												66.5	55
24	160F24	F	16.390	15.323	B1												70.5	59
25	160F25	F	17.030	15.958	B1	3 ¹ / ₁₆	3 ¹ / ₂	4	6 ¹ / ₂	2 ¹ / ₁₆	1 ¹ / ₂	1 ¹ / ₃₂			2 ¹ / ₂	1.156	75.5	64
26	160J26	J	17.670	16.593	C	4 ¹ / ₁₆	4 ¹ / ₂	5	7 ¹ / ₄	1 ¹ / ₁₆	2 ¹ / ₂	2 ¹ / ₃₂			3 ¹ / ₁₆	1.156	92.5	74
28	160J28	J	18.950	17.863	C												103	84
30	160J30	J	20.230	19.134	C												115	96
35	160J35	J	23.420	22.312	C	4 ¹ / ₁₆	4 ¹ / ₂	5	7 ¹ / ₄	1 ¹ / ₁₆	2 ¹ / ₂	2 ¹ / ₃₂			3 ¹ / ₁₆	1.156	135	116
40	160M40	M	26.610	25.491	C1	5 ¹ / ₂	6 ¹ / ₂	6 ¹ / ₂	9	2 ¹ / ₁₆	2 ¹ / ₁₆	2 ¹ / ₃₂	1 ¹ / ₃₂		5 ¹ / ₁₆	1.156	211	174
45	160M45	M	29.800	28.671	C1												245	208
54	160M54	M	35.540	34.397	C1												299	262
60	160M60	M	39.360	38.215	C1												347	310
70	160M70	M	45.730	44.578	C1												468	431
80	160M80	M	52.100	50.943	C1	5 ¹ / ₂	6 ¹ / ₂	6 ¹ / ₂	9	2 ¹ / ₁₆	2 ¹ / ₁₆	2 ¹ / ₃₂	1 ¹ / ₃₂		5 ¹ / ₁₆	1.156	567	530

Single-Taper Bushed with Hardened Teeth

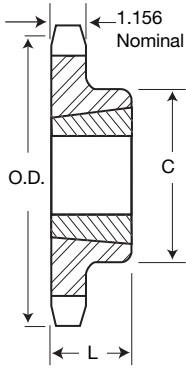

TYPE B

No. Teeth	Catalog Number
11	160BTB11H
12	160BTB12H
13	160BTB13H
14	160BTB14H
15	160BTB15H
16	160BTB16H
17	160BTB17H
18	160BTB18H
19	160BTB19H
21	160BTB21H
26	160BTB26H

S
A
B
E
R
T
O
O
T
H[®]

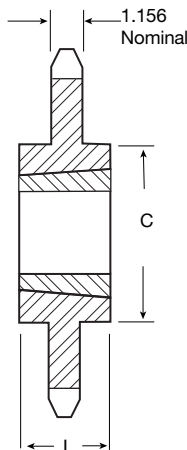

TYPE C

Single-Taper Bushed

No. Teeth	Catalog Number	Bushing	Diameter		Max. Bore	Dimensions		Type	Weight (Approx.)	
			Outside Diameter	Pitch Diameter		L	C		Rim Only	Bushing Only
11	160BTB11	2517	8.011	7.099	2½	1¾	4¾	B	9.0	3.5
12	160BTB12	3020	8.664	7.727	3	2	5¼	B	11.0	6.5
13	160BTB13	3020	9.314	8.357	3	2	5¼	B	13.0	6.5
14	160BTB14	3020	9.963	8.988	3	2	5¼	B	16.0	6.5
15	160BTB15	3535	10.609	9.620	3½	3¾	6½	B	25.0	14.0
16	160BTB16	3535	11.255	10.252	3½	3¾	6½	B	28.0	14.0
17	160BTB17	3535	11.899	10.885	3½	3¾	6½	B	32.0	14.0
18	160BTB18	3535	12.543	11.518	3½	3¾	6½	B	35.0	14.0
19	160BTB19	3535	13.185	12.151	3½	3¾	6½	B	39.0	14.0
21	160BTB21	3535	14.470	13.419	3½	3¾	6½	B	48.0	14.0
26	160BTB26	3535	17.671	16.593	3½	3¾	6½	B	68.0	14.0
35	160CTB35	4040	23.422	22.312	4	4	7¾	C	118	14.0
45	160CTB45	4040	29.802	28.671	4	4	7¾	C	186	22.0
60	160CTB60	4545	39.362	38.215	4½	4½	8¾	C	292	30.0

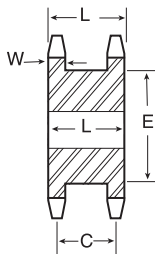

TYPE A

Double Single-Type A — Steel

No. Teeth	Catalog Number	Diameters		Type	Min. Bore	Max. Bore	Dimensions			Wt. (Approx.)	
		Outside Diameter	Pitch Diameter				L	C	E		
15	DS160A15	10.609	9.620	A	1½	5½	4¾	3½	7¾	1.156	69.0
16	DS160A16	11.255	10.252	A	1½	6	4¾	3½	8¼	1.156	75.0
17	DS160A17	11.899	10.885	A	1½	6½	4¾	3½	8¾	1.156	92.0
18	DS160A18	12.543	11.518	A	1½	6¾	4¾	3½	9¼	1.156	97.0

No. 160 2" Pitch

MST[®] Sprockets

Martin

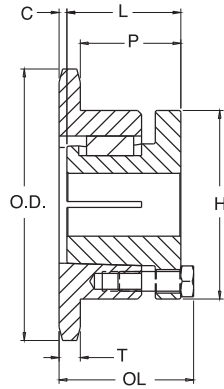

TYPE 4

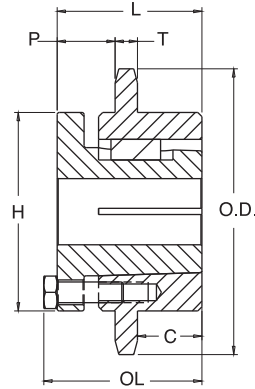

TYPE 6

SPROCKETS

Single - MST[®] Sprockets

No. Teeth	Catalog Number	Bush- ing	Diameters		Type	Max. Bore	Dimensions						Weight (Approx.)	
			Outside Dia.	Pitch Dia.			OL	L	C	H	P	T(nom)	With Hub	Rim Only
11	160R11H	R1	8.010	7.099	4	3-3/4	3-13/32	2-7/8	1/4	5-3/8	1-31/32	1.156	18.3	10.8
12	160R12H	R1	8.660	7.727	4	3-3/4	3-13/32	2-7/8	1/4	5-3/8	1-31/32	1.156	21.7	14.2
13	160R13H	R1	9.310	8.357	4	3-3/4	3-5/32	2-7/8	0	5-3/8	1-23/32	1.156	23.0	15.5
14	160R14H	R1	9.960	8.988	4	3-3/4	3-5/32	2-7/8	0	5-3/8	1-23/32	1.156	26.0	18.5
15	160R15H	R1	10.610	9.620	4	3-3/4	3-5/32	2-7/8	0	5-3/8	1-23/32	1.156	29.1	21.6
16	160R16H	R1	11.260	10.252	4	3-3/4	3-5/32	2-7/8	0	5-3/8	1-23/32	1.156	32.5	25.0
17	160R17H	R1	11.900	10.885	4	3-3/4	3-5/32	2-7/8	0	5-3/8	1-23/32	1.156	35.5	28.0
18	160R18H	R1	12.540	11.518	4	3-3/4	3-5/32	2-7/8	0	5-3/8	1-23/32	1.156	39.4	31.9
19	160R19H	R1	13.190	12.151	4	3-3/4	3-5/32	2-7/8	0	5-3/8	1-23/32	1.156	43.4	35.9
20	160R20H	R2	13.830	12.785	6	3-5/8	5-5/32	4-7/8	2	5-3/8	1-23/32	1.156	62.0	51.0
21	160R21H	R2	14.470	13.419	6	3-5/8	5-5/32	4-7/8	2	5-3/8	1-23/32	1.156	67.0	56.0
22	160R22H	R2	15.110	14.053	6	3-5/8	5-5/32	4-7/8	2	5-3/8	1-23/32	1.156	71.0	60.0
23	160R23H	R2	15.750	14.688	6	3-5/8	5-5/32	4-7/8	2	5-3/8	1-23/32	1.156	76.0	65.0
24	160R24H	R2	16.390	15.323	6	3-5/8	5-5/32	4-7/8	2	5-3/8	1-23/32	1.156	82.5	71.5
25	160R25H	R2	17.030	15.958	6	3-5/8	5-5/32	4-7/8	2	5-3/8	1-23/32	1.156	85.0	74.0
26	160R26H	R2	17.670	16.593	6	3-5/8	5-5/32	4-7/8	2	5-3/8	1-23/32	1.156	90.0	79.0
26	160S26H	S2	17.670	16.593	6	4-3/16	7-1/8	6-3/4	2-7/8	6-3/8	2-23/32	1.156	98.0	79.0
28	160R28H	R2	18.950	17.863	6	3-5/8	5-5/32	4-7/8	2	5-3/8	1-23/32	1.156	110.8	99.8
28	160S28H	S2	19.950	17.863	6	4-3/16	7-1/8	6-3/4	2-7/8	6-3/8	2-23/32	1.156	118.8	99.8
30	160R30H	R2	20.230	19.134	6	3-5/8	5-5/32	4-7/8	2	5-3/8	1-23/32	1.156	117.0	106.0
30	160S30H	S2	20.230	19.134	6	4-3/16	7-1/8	6-3/4	2-7/8	6-3/8	2-23/32	1.156	134.0	115.0
35	160S35	S2	23.420	22.312	6	4-3/16	7-1/8	6-3/4	2-7/8	6-3/8	2-23/32	1.156	169.0	150.0
40	160S40	S2	26.610	25.491	6	4-3/16	7-1/8	6-3/4	2-7/8	6-3/8	2-23/32	1.156	184.0	165.0
45	160S45	S2	29.800	28.671	6	4-3/16	7-1/8	6-3/4	2-7/8	6-3/8	2-23/32	1.156	223.0	204.0
60	160U60	U0	39.360	38.215	6	5-1/2	5 25/32	5-1/4	1-15/16	8-3/8	1-21/32	1.156	338.0	308.0
70	160U70	U0	45.730	44.578	6	5-1/2	5 25/32	5-1/4	1-15/16	8-3/8	1-21/32	1.156	384.0	354.0
80	160S80	S2	52.100	50.943	6	4-3/16	7-1/8	6-3/4	2-7/8	6-3/8	2-23/32	1.156	0	0
80	160U80	U1	52.100	50.943	6	5-1/2	7-19/32	7-1/8	2-7/8	8-3/8	2 19/32	1.156	434.0	394.0

Sprockets with "H" suffix have hardened teeth.

Double-Type B & C

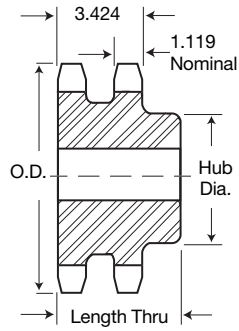

TYPE B

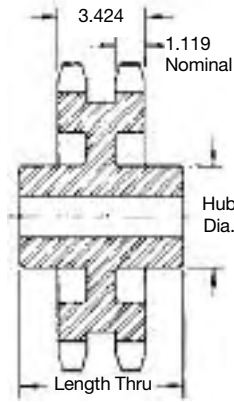

TYPE C

No. Teeth	Catalog Number	Outside Diameter	Type	Bore (inches)		Hub (inches)		Weight Lbs. (App.)
				Stock	Rec. Max.	Dia.	Length Thru	
13	D160B13	9.310	B	2	4	6	4%	48
14	D160B14	9.960	B	2	4 $\frac{1}{4}$	6 $\frac{1}{2}$	4%	58
15	D160B15	10.610	B	2	5 $\frac{1}{4}$	7	4%	68
16	D160B16	11.260	B	2	5 $\frac{1}{2}$	7	4%	75
17	D160B17	11.900	B	2	5 $\frac{1}{2}$	7	4%	91
18	D160B18	12.540	B	2	5 $\frac{1}{2}$	7	4%	96
19	D160B19	13.190	B	2	5 $\frac{1}{2}$	7	4%	107
20	D160B20	13.830	B	2	5 $\frac{1}{2}$	7	4%	119
21	D160B21	14.470	B	2	5 $\frac{1}{2}$	7 $\frac{1}{2}$	4%	130
22	D160B22	15.110	B	2	5 $\frac{3}{4}$	7 $\frac{1}{2}$	4%	141
23	D160B23	15.750	B	2	5 $\frac{3}{4}$	7 $\frac{1}{2}$	4%	157
24	D160B24	16.390	B	2	5 $\frac{3}{4}$	7 $\frac{1}{2}$	4%	171
25	D160B25	17.030	B	2	5 $\frac{3}{4}$	7 $\frac{1}{2}$	4%	187
26	D160B26	17.670	B	2	5 $\frac{3}{4}$	7 $\frac{1}{2}$	4%	201
35	D160C35	23.420	C	1 $\frac{1}{2}$	6 $\frac{3}{4}$	9 $\frac{1}{2}$	6%	306
45	D160C45	29.800	C	1 $\frac{1}{2}$	7	10	7%	431
60	D160C60	39.360	C	1 $\frac{1}{2}$	7	10	7%	564

Maximum bores shown will accommodate standard keyseat and setscrew over keyseat. Slightly larger bores are possible with no keyseat, shallow keyseat, or setscrew at angle to keyseat.

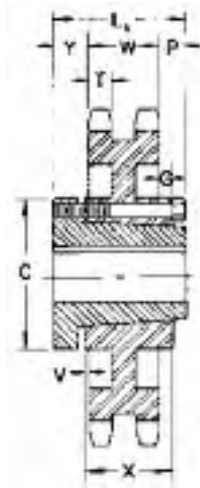

QD — TYPE C₆



Alteration Charges

See current discount sheet for alteration charges.

Double-Type QD

No. Teeth	Catalog Number	Bush-ing	Diameters		Type	Max. Bore	Dimensions										Weight (Approx.)	
			Outside Diameter	Pitch Diameter			L ₁	L ₂	C	Y	P	G	V	X	T	W	With Hub	Rim Only
35	D160M35	M	23.420	22.312	C6	5 $\frac{1}{2}$	6 $\frac{1}{4}$	6 $\frac{1}{4}$	9	2 $\frac{3}{4}$	1 $\frac{1}{2}$	1 $\frac{1}{2}$	3 $\frac{3}{4}$	5 $\frac{5}{8}$	1.119	3.424	259	222
45	D160N45	N	29.800	28.671	C6	6	8 $\frac{1}{4}$	8 $\frac{1}{4}$	10	2 $\frac{1}{2}$	2 $\frac{3}{4}$	2 $\frac{1}{2}$	2 $\frac{1}{2}$	6 $\frac{1}{4}$	1.119	3.424	377	340
60	D160N60	N	39.360	38.215	C6	6	8 $\frac{1}{4}$	8 $\frac{1}{4}$	10	2 $\frac{1}{2}$	2 $\frac{3}{4}$	2 $\frac{1}{2}$	2 $\frac{1}{2}$	6 $\frac{1}{4}$	1.119	3.424	509	472

No. 180 2 1/4" Pitch

All Steel Stock Sprockets



Single-Type B & C

Single-Type A

No. Teeth	Catalog Number	Outside Diameter	Type	Bore (inches)		Hub (inches)		Weight Lbs (Approx.)	Type	Catalog Number	Stock Bore	Weight Lbs. (Approx.)
				Stock	Rec. Max.	Dia.	Length Thru					
11	180B11	9.010	B	1 1/2	3%	5 1/2	3	29	A	180A11	1 1/2	14
12	180B12	9.750	B	1 1/2	4	6	3	32	A	180A12	1 1/2	16
13	180B13	10.480	B	1 1/2	4%	6 3/4	3 3/8	40	A	180A13	1 1/2	20
14	180B14	11.210	B	1 1/2	5 1/4	7	3 3/8	44	A	180A14	1 1/2	24
15	180B15	11.930	B	1 1/2	5 1/4	7	3 3/8	48	A	180A15	1 1/2	28
16	180B16	12.660	B	1 1/2	5 1/4	7	3 3/8	52	A	180A16	1 1/2	32
17	180B17	13.390	B	1 1/2	5 1/4	7	3 3/8	58	A	180A17	1 1/2	37
18	180B18	14.110	B	1 1/2	5 1/4	7	3 3/8	63	A	180A18	1 1/2	43
19	180B19	14.830	B	1 1/2	5%	7 1/2	3 3/8	74	A	180A19	1 1/2	47
20	180B20	15.560	B	1 1/2	5%	7 1/2	3 3/8	81	A	180A20	1 1/2	53
21	180B21	16.280	B	1 1/2	5%	7 1/2	3 3/8	83	A	180A21	1 1/2	57
22	180B22	17.000	B	1 1/2	5%	7 1/2	3 3/8	92	A	180A22	1 1/2	62
23	180B23	17.720	B	1 1/2	5%	7 1/2	3 3/8	99	A	180A23	1 1/2	69
24	180B24	18.440	B	1 1/2	5%	7 1/2	3 3/8	105	A	180A24	1 1/2	77
25	180B25	19.160	B	1 1/2	5%	7 1/2	3 3/8	113	A	180A25	1 1/2	84
28	180B28	21.320	B	1 1/2	5%	8	3 1/2	135	A	180A28	1 1/2	104
30	180C30	22.760	C	1 1/2	5%	8 1/2	4%	180	A	180A30	1 1/2	120
35	180C35	26.350	C	1 1/2	5%	8 1/2	4%	222	A	180A35	1 1/2	172
40	180C40	29.940	C	1 1/2	5%	8 1/2	4%	270	A	180A40	1 1/2	229
45	180C45	33.530	C	1 1/2	6	9	5	315	A	180A45	1 1/2	284
54	180C54	39.980	C	1 1/2	6	9	5	477	A	180A54	1 1/2	420
60	180C60	44.280	C	1 1/2	6 1/2	9 1/2	5%	489	A	180A60	1 1/2	505



SPROCKETS

Maximum bores shown will accommodate standard keyseat and setscrew over keyseat. Slightly larger bores are possible with no keyseat, shallow keyseat, or setscrew at angle to keyseat.

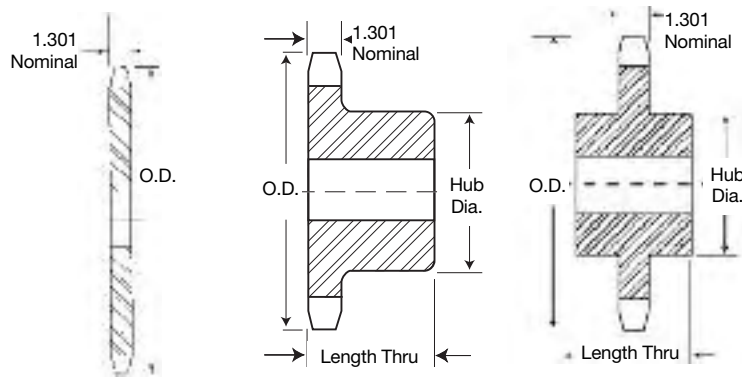

TYPE A

TYPE B

TYPE C

Alteration Charges

See current discount sheet for alteration charges.

Single-Type B & C

Single-Type A

No. Teeth	Catalog Number	Outside Diameter	Type	Bore (inches)		Hub (inches)		Weight Lbs. (Approx.)	Type	Catalog Number	Stock Bore	Weight Lbs. (Approx.)
				Stock	Rec. Max.	Diameter	Length Thru					
10	200B10	9.200	B	1 1/2	3 3/4	5 1/2	3	26	A	200A10	1 1/2	16
11	200B11	10.020	B	1 1/2	4	6	3	33	A	200A11	1 1/2	20
12	200B12	10.830	B	1 1/2	4 1/2	6 1/2	3	37	A	200A12	1 1/2	24
13	200B13	11.640	B	1 1/2	5 1/4	7	3	46	A	200A13	1 1/2	30
14	200B14	12.460	B	1 1/2	5 1/2	7 1/2	3 1/2	59	A	200A14	1 1/2	32
15	200B15	13.260	B	1 1/2	5 1/2	7 1/2	3 1/2	64	A	200A15	1 1/2	40
16	200B16	14.070	B	1 1/2	5 1/2	7 1/2	3 1/2	72	A	200A16	1 1/2	46
17	200B17	14.870	B	1 1/2	5 1/2	7 1/2	3 1/2	76	A	200A17	1 1/2	51
18	200B18	15.680	B	1 1/2	5 1/2	7 1/2	3 1/2	84	A	200A18	1 1/2	57
19	200B19	16.480	B	1 1/2	5 1/2	7 1/2	3 1/2	91	A	200A19	1 1/2	65
20	200B20	17.290	B	1 1/2	5 1/2	7 1/2	3 1/2	98	A	200A20	1 1/2	72
21	200B21	18.090	B	1 1/2	5 1/2	7 1/2	3 1/2	106	A	200A21	1 1/2	82
22	200B22	18.890	B	1 1/2	5 1/2	8 1/2	4	131	A	200A22	1 1/2	88
23	200B23	19.690	B	1 1/2	5 1/2	8 1/2	4	136	A	200A23	1 1/2	95
24	200B24	20.490	B	1 1/2	5 1/2	8 1/2	4	142	A	200A24	1 1/2	105
25	200B25	21.290	B	1 1/2	5 1/2	8 1/2	4	153	A	200A25	1 1/2	113
26	200C26	22.090	C	1 1/2	5 1/2	8 1/2	4 1/2	178	A	200A26	1 1/2	124
28	200C28	23.690	C	1 1/2	5 1/2	8 1/2	4 1/2	195	A	200A28	1 1/2	144
30	200C30	25.290	C	1 1/2	5 1/2	8 1/2	4 1/2	212	A	200A30	1 1/2	167
32	200C32	26.880	C	1 1/2	5 1/2	8 1/2	4 1/2	220	A	200A32	1 1/2	195
35	200C35	29.280	C	1 1/2	5 1/2	8 1/2	4 1/2	254	A	200A35	1 1/2	227
40	200C40	33.270	C	1 1/2	6	9	5	320	A	200A40	1 1/2	301
45	200C45	37.250	C	1 1/2	6	9	5	364	A	200A45	1 1/2	390
54	200C54	44.420	C	1 1/2	6 1/2	9 1/2	5 1/2	512	A	200A54	1 1/2	555
60	200C60	49.200	C	1 1/2	6 1/2	9 1/2	5 1/2	654	A	200A60	1 1/2	692

Maximum bores shown will accommodate standard keyseat and setscrew over keyseat. Slightly larger bores are possible with no keyseat, shallow keyseat, or setscrew at angle to keyseat.

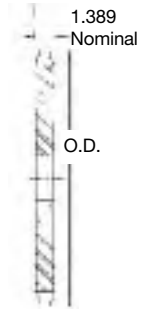

TYPE A

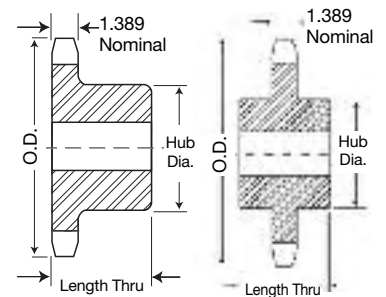

TYPE B

TYPE C

Alteration Charges

See current discount sheet for alteration charges.

Single-Type QD

No. Teeth	Catalog Number	Bush-ing	Diameters		Type	Max. Bore	Dimensions									Weight (Approx.)	
			Outside Dia.	Pitch Dia.			L ₁	L ₂	C	Y	P	G	V	X	T	With Hub	Rim Only
12	200F12	F	10.830	9.660	C	3 1/16	3 3/8	4	6 3/8	1	1 1/16	1 1/8		2 1/2	1.389	25.5	24
13	200J13	J	11.640	10.447	C	4 1/16	4 1/2	5	7 1/4	1 1/16	2	1 13/16		3 3/8	1.389	50.5	32
14	200J14	J	12.460	11.235	C											57.5	39
15	200J15	J	13.260	12.025	C											62.5	44
16	200J16	J	14.070	12.815	C	4 1/16	4 1/2	5	7 1/4	1 1/16	2	1 13/16		3 3/8	1.389	68.5	50
17	200M17	M	14.870	13.605	C-1	5 1/2	6 3/8	6 3/8	9	2 23/32	2 23/32	2 1/8	1 1/2	5 3/8	1.389	113	76
18	200M18	M	15.680	14.397	C-1											119	82
19	200M19	M	16.480	15.910	C-1											125	88
20	200M20	M	17.290	15.982	C-1											134	97
21	200M21	M	18.090	16.775	C-1											140	103
22	200M22	M	18.890	17.567	C-1											149	112
23	200M23	M	19.690	18.360	C-1											157	120
24	200M24	M	20.490	19.152	C-1											168	131
25	200M25	M	21.290	19.947	C-1											175	138
26	200M26	M	22.090	20.740	C-1											185	148
28	200M28	M	23.690	22.330	C-1											205	168
30	200M30	M	25.290	23.917	C-1											227	190
32	200M32	M	26.880	25.505	C-1											251	214
35	200M35	M	29.280	27.890	C-1											265	228
40	200M40	M	33.270	31.865	C-1	5 1/2	6 3/8	6 3/8	9	2 23/32	2 23/32	2 1/8	1 1/2	5 3/8	1.389	315	278
45	200N45	N	37.250	35.840	C-1	5 1/2	8 1/8	8 1/8	10	3 13/32	3 13/32	3 1/8	1 11/16	6 1/4	1.389	405	348
54	200N54	N	44.420	42.995	C-1	5 1/2	8 1/8	8 1/8	10	3 13/32	3 13/32	3 1/8	1 11/16	6 1/4	1.389	535	478
60	200N60	N	49.200	47.767	C-1	5 1/2	8 1/8	8 1/8	10	3 13/32	3 13/32	3 1/8	1 11/16	6 1/4	1.389	665	608

SPROCKETS

No. 200
2 1/2" Pitch

MST®
Sprockets

Martin

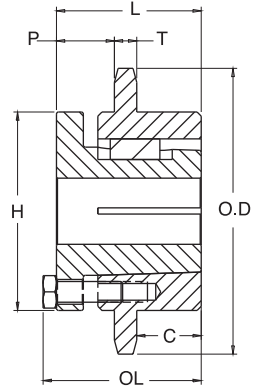

TYPE 6

SPROCKETS

Single - MST® Sprockets

No. Teeth	Catalog Number	Bush- ing	Diameters		Type	Max. Bore	Dimensions						Weight (Approx.)	
			Outside Dia.	Pitch Dia.			OL	L	C	H	P	T(nom)	With Hub	Rim Only
12	200R12	R2	10.830	9.660	6	3-5/8	5-5/32	4-7/8	2	5-3/8	1-1/2	1.389	46.3	35.3
13	200S13	S2	11.640	10.447	6	4-3/16	7-1/8	6-3/4	2-7/8	6-3/8	2-1/2	1.389	71.2	52.2
14	200S14	S2	12.460	11.235	6	4-3/16	7-1/8	6-3/4	2-7/8	6-3/8	2-1/2	1.389	76.5	57.5
15	200S15	S2	13.260	12.025	6	4-3/16	7-1/8	6-3/4	2-7/8	6-3/8	2-1/2	1.389	80.0	61.0
16	200S16	S2	14.070	12.815	6	4-3/16	7-1/8	6-3/4	2-7/8	6-3/8	2-1/2	1.389	90.0	71.0
17	200S17	S2	14.870	13.605	6	4-3/16	7-1/8	6-3/4	2-7/8	6-3/8	2-1/2	1.389	98.0	79.0
18	200U18	U0	15.680	14.397	6	5-1/2	5-23/32	5-1/4	1 5/8	8-3/8	2-17/32	1.389	106.5	76.5
19	200U19	U0	16.480	15.190	6	5-1/2	5-23/32	5-1/4	1 5/8	8-3/8	2-17/32	1.389	113.7	83.7
20	200U20	U0	17.290	15.982	6	5-1/2	5-23/32	5-1/4	1 5/8	8-3/8	2-17/32	1.389	121.3	91.3
21	200U21	U0	18.090	16.775	6	5-1/2	5-23/32	5-1/4	1 5/8	8-3/8	2-17/32	1.389	129.4	99.4
22	200U22	U0	18.890	17.567	6	5-1/2	5-23/32	5-1/4	1 5/8	8-3/8	2-17/32	1.389	140.0	110.0
23	200U23	U0	19.690	18.360	6	5-1/2	5-23/32	5-1/4	1 5/8	8-3/8	2-17/32	1.389	147.0	117.0
24	200U24	U0	20.490	19.152	6	5-1/2	5-23/32	5-1/4	1 5/8	8-3/8	2-17/32	1.389	156.0	126.0
25	200U25	U0	21.290	19.947	6	5-1/2	5-23/32	5-1/4	1 5/8	8-3/8	2-17/32	1.389	170.0	140.0
26	200U26	U0	22.090	20.740	6	5-1/2	5-23/32	5-1/4	1 5/8	8-3/8	2-17/32	1.389	180.0	150.0
28	200U28	U0	23.690	22.330	6	5-1/2	5-23/32	5-1/4	1 5/8	8-3/8	2-17/32	1.389	199.0	169.0
30	200U30	U0	25.290	23.917	6	5-1/2	5-23/32	5-1/4	1 5/8	8-3/8	2-17/32	1.389	218.0	188.0
32	200U32	U0	26.880	25.505	6	5-1/2	5-23/32	5-1/4	1 5/8	8-3/8	2-17/32	1.389	242.0	212.0
35	200U35	U1	29.280	27.890	6	5-1/2	7-19/32	7-1/8	2-7/8	8-3/8	2-7/8	1.389	292.0	252.0
40	200U40	U1	33.270	31.865	6	5-1/2	7-19/32	7-1/8	2-7/8	8-3/8	2-7/8	1.389	346.0	306.0
45	200U45	U1	37.250	35.840	6	5-1/2	7-19/32	7-1/8	2-7/8	8-3/8	2-7/8	1.389	330.0	290.0
54	200U54	U2	44.420	42.995	6	5	10-19/32	10-1/8	4-1/4	8-3/8	3-29/32	1.389	435.0	385.0
60	200U60	U2	49.200	47.767	6	5	10-19/32	10-1/8	4-1/4	8-3/8	3-29/32	1.389	495.0	445.0

Sprockets with "H" suffix have hardened teeth.



Double-Type B & C

No. Teeth	Catalog Number	Outside Diameter	Type	Bore (inches)		Hub (inches)		Weight Lbs. (Approx.)
				Stock	Rec. Max.	Dia.	Length Thru	
11	D200B11	10.020	B	2	3½	5½	5½	57
12	D200B12	10.830	B	2	4½	6½	6¼	80
13	D200B13	11.640	B	2	5½	7	6¾	96
14	D200B14	12.460	B	2	5½	8	6¾	119
15	D200B15	13.260	B	2	5½	8½	6¾	138
16	D200B16	14.070	B	2	5½	8½	6¾	161
17	D200B17	14.870	B	2	5½	8½	6¾	178
18	D200B18	15.680	B	2	5½	8½	6¾	196
19	D200B19	16.480	B	2	5½	8½	6¾	217
20	D200B20	17.290	B	2	5½	8½	6¾	236
21	D200B21	18.090	B	2	5½	8½	6¾	250
22	D200B22	18.890	B	2	5½	8½	6¾	284
23	D200B23	19.690	B	2	5½	8½	6¾	308
24	D200B24	20.490	B	2	5½	8½	6¾	330
25	D200B25	21.290	B	2	5½	8½	6¾	358
26	D200B26	22.090	B	2	5½	8½	6¾	386
45	D200C45	37.250	C	1½	7	10	8½	665
60	D200C60	49.200	C	1½	7	10	9	972

Maximum bores shown will accommodate standard keyseat and setscrew over keyseat. Slightly larger bores are possible with no keyseat, shallow keyseat, or setscrew at angle to keyseat.

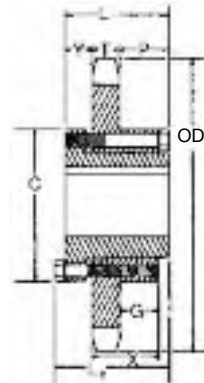

QD — TYPE C

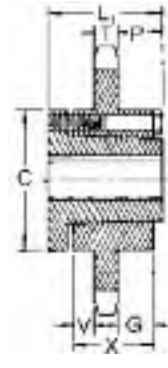

QD — TYPE C1

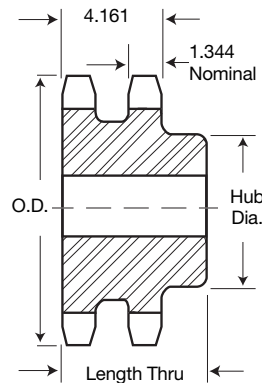

TYPE B

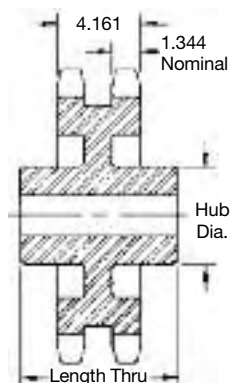

TYPE C

Alteration Charges

See current discount sheet for alteration charges.

No. 240 3" Pitch

All Steel Stock Sprockets



Single-Type B & C

Single-Type A

No. Teeth	Catalog Number	Outside Diameter	Type	Bore (inches)		Hub (inches)		Weight Lbs (Approx.)	Type	Catalog Number	Stock Bore	Weight Lbs. (Approx.)
				Stock	Rec. Max.	Dia.	Length Thru					
10	240B10	11.030	B	1½	4¾	6½	3¾	49	A	240A10	1½	30
11	240B11	12.020	B	1½	4¾	7	3¾	66	A	240A11	1½	37
12	240B12	13.000	B	1½	5¾	7½	3¾	72	A	240A12	1½	45
13	240B13	13.970	B	1½	5¾	7½	3¾	81	A	240A13	1½	54
14	240B14	14.940	B	1½	5¾	7½	3¾	88	A	240A14	1½	62
15	240B15	15.910	B	1½	5¾	7½	3¾	98	A	240A15	1½	68
16	240B16	16.880	B	1½	5¾	8	4¾	120	A	240A16	1½	82
17	240B17	17.850	B	1½	5¾	8	4¾	137	A	240A17	1½	93
18	240B18	18.810	B	1½	5¾	8	4¾	142	A	240A18	1½	108
19	240B19	19.780	B	1½	5¾	8	4¾	154	A	240A19	1½	120
20	240B20	20.740	B	1½	5¾	8	4¾	169	A	240A20	1½	128
21	240B21	21.710	B	1½	5¾	8	4¾	186	A	240A21	1½	148
25	240B25	25.550	B	1½	5¾	8	4¾	254	A	240A25	1½	208
30	240C30	30.340	C	1½	6	9	6¾	398	A	240A30	1½	310
35	240C35	35.130	C	1½	6	9	6¾	527	A	240A35	1½	416
40	240C40	39.920	C	1½	7	10	6¾	672	A	240A40	1½	548
45	240C45	44.700	C	1½	7	10	6¾	850	A	240A45	1½	702
54	240C54	53.310	C	1½	7	10	6¾	1148	A	240A54	1½	1022
60	240C60	59.040	C	1½	7	10	6¾	1419	A	240A60	1½	1268



SPROCKETS



TYPE A

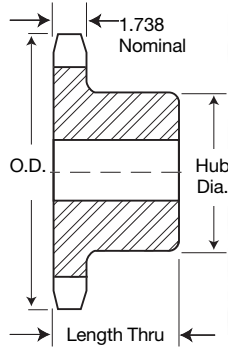

TYPE B

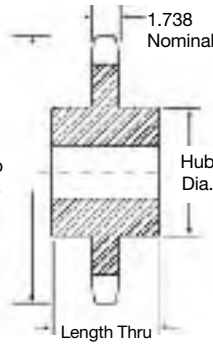

TYPE C

Metric Sprockets ISO STANDARDS

Types A - B & C Stock Sprockets



TYPE A
SIMPLEX



TYPE B
SIMPLEX



TYPE C
TRIPLEX



TYPE B
DUPLEX



Taper Bushed
SIMPLEX



Taper Bushed
DUPLEX



INSTANT
SPLIT® SPROCKET

Made-to-Order



Taper Bushed
DOUBLE-SIMPLEX
HARDENED TEETH
Double Simplex



QD
SIMPLEX
“QD” Sprockets



IDLER
BALL BEARING
Idler Sprockets



TYPE B
SIMPLEX
STAINLESS
Stainless Steel

Metric Sprockets



0.375 INCH (9.525mm) PITCH **SIMPLEX**

ISO **06B-1**
METRIC **35**

CHAIN DATA:
BS 228/3
ISO 06B-1
PITCH: 9.53mm (0.375 in.)
ROLLER DIAMETER: 6.35mm (0.250 in.)
ROLLER WIDTH: 5.72mm (0.225 in.)
TENSILE: 910 kilos (2000 lbs.)

Simplex-Type B — Steel

Simplex-Type A — Steel

No. Teeth	Pitch Diameter MM	Catalog Number	Bore		Hub		Weight (Approx.) Kilos	Catalog Number	Bore Stock MM	Weight (Approx.) Kilos
			Stock MM	Max. MM	Dia. MM	Thru MM				
8	24.89	06B8	8	9	13	22	0.03			
9	27.85	06B9	8	11	16	22	0.04			
10	30.82	06B10	8	12	20	22	0.06			
11	33.81	06B11	8	14	23	25	0.09			
12	36.80	06B12	8	16	26	25	0.10			
13	39.80	06B13	10	18	29	25	0.11			
14	42.80	06B14	10	16	31	25	0.12			
15	45.81	06B15	10	20	34	25	0.14	06A15	8	0.07
16	48.82	06B16	10	22	37	25	0.18	06A16	10	0.08
17	51.84	06B17	10	25	40	28	0.20	06A17	10	0.18
18	54.85	06B18	10	25	43	28	0.23	06A18	10	0.11
19	57.87	06B19	10	28	46	28	0.25	06A19	10	0.12
20	60.89	06B20	10	30	49	28	0.31	06A20	10	0.13
21	63.91	06B21	12	30	50	28	0.36	06A21	10	0.14
22	66.93	06B22	12	32	51	28	0.37	06A22	10	0.15
23	69.95	06B23	12	32	52	28	0.39	06A23	10	0.17
24	72.97	06B24	12	32	54	28	0.40	06A24	10	0.19
25	76.00	06B25	12	35	57	28	0.41	06A25	10	0.20
26	79.02	06B26	12	38	60	28	0.42	06A26	10	0.21
27	82.05	06B27	12	38	60	28	0.44	06A27	10	0.22
28	85.07	06B28	12	38	60	28	0.45	06A28	10	0.23
29	88.10	06B29	12	38	60	28	0.47	06A29	10	0.25
30	91.12	06B30	12	38	60	30	0.48	06A30	10	0.27
32	97.18	06B32	14	40	65	30	0.56	06A32	12	0.20
35	106.26	06B35	14	40	65	30	0.68	06A35	12	0.27
36	109.29	06B36	16	45	70	30	0.71	06A36	12	0.28
38	115.35	06B38	16	45	70	30	0.77	06A38	14	0.43
40	121.40	06B40	16	45	70	30	0.81	06A40	14	0.45
42	127.46	06B42	16	45	70	30	0.85	06A42	14	0.48
45	136.55	06B45	16	45	75	30	0.91	06A45	14	0.51
48	145.64	06B48	16	45	75	30	0.97	06A48	14	0.54
54	163.82	06B54	16	45	75	30	1.09	06A54	14	0.61
57	172.91	06B57	19	45	75	30	1.27	06A57	18	0.86
60	182.00	06B60	19	45	75	30	1.34	06A60	18	0.91
64	194.12	06B64	19	45	75	30	1.43	06A64	18	0.97
70	212.30	06B70	19	45	75	30	1.56	06A70	18	1.06
72	218.37	06B72	19	45	75	30	1.60	06A72	18	1.09
76	230.49	06B76	19	45	75	30	1.91	06A76	18	1.45
80	242.61	06B80	19	45	75	30	2.01	06A80	18	1.53
84	254.74	06B84	19	45	75	30	2.11	06A84	18	1.60
90	272.93	06B90	19	52	75	30	2.26	06A90	18	1.72
95	288.08	06B95	19	52	75	30	2.61	06A95	18	2.18
96	291.11	06B96	19	52	75	30	2.64	06A96	18	2.20
114	345.68	06B114	19	52	75	30	3.63	06A114	18	3.13

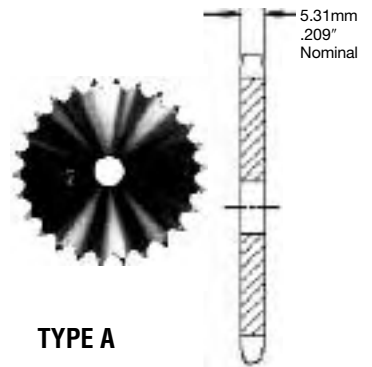

TYPE A

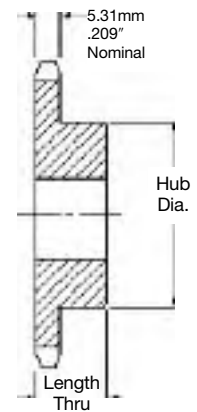

TYPE B



Maximum bores shown will accommodate standard keyseat and setscrew over keyseat. Slightly larger bores are possible with no keyseat, shallow keyseat, or setscrew at angle to keyseat.

SPROCKETS

0.375 INCH (9.525mm) PITCH **SIMPLEX**

ISO **06B-1**
METRIC **35**

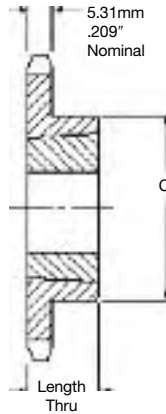

CHAIN DATA:
BS 228/3
ISO 06B-1
PITCH: 9.53mm (0.375 in.)
ROLLER DIAMETER: 6.35mm (0.250 in.)
ROLLER WIDTH: 5.72mm (0.225 in.)
TENSILE: 910 kilos (2000 lbs.)

TYPE B

Simplex-Taper Bushed — Steel

No. Teeth	Pitch Diameter	Catalog Number	Bushing Number	Bore Max.	Dimension		Weight	
	MM			MM	L	C	Rim Kilos	Bushing Kilos
18	54.85	06BTB18H	1008	25.40	22.23	47.63*	0.18	0.14
19	57.87	06BTB19H	1008	25.40	22.23	46.04	0.23	0.14
20	60.89	06BTB20H	1008	25.40	22.23	49.20	0.27	0.14
21	63.91	06BTB21H	1008	25.40	22.23	52.39	0.32	0.14
22	66.93	06BTB22H	1210	31.75	25.40	60.33	0.36	0.27
23	69.95	06BTB23H	1210	31.75	25.40	61.91	0.41	0.27
24	72.97	06BTB24H	1210	31.75	25.40	61.91	0.41	0.27
25	76.00	06BTB25H	1210	31.75	25.40	61.91	0.54	0.27
26	79.02	06BTB26H	1610	41.28	25.40	73.03*	0.50	0.41
28	85.07	06BTB28H	1610	41.28	25.40	73.03	0.54	0.41
30	91.12	06BTB30H	1610	41.28	25.40	79.38	0.54	0.41
32	97.18	06BTB32	1610	41.28	25.40	82.55	0.59	0.41
35	106.26	06BTB35	1610	41.28	25.40	82.55	0.64	0.41
36	109.29	06BTB36	1610	41.28	25.40	82.55	0.64	0.41
38	115.35	06BTB38	1610	41.28	25.40	82.55	0.68	0.41
40	121.40	06BTB40	1610	41.28	25.40	82.55	0.86	0.41
45	136.55	06BTB45	1610	41.28	25.40	82.55	0.95	0.41
48	145.65	06BTB48	1610	41.28	25.40	82.55	1.04	0.41
54	163.82	06BTB54	1610	41.28	25.40	82.55	1.18	0.41
57	172.91	06BTB57	1610	41.28	25.40	82.55	1.25	0.41
60	182.00	06BTB60	1610	41.28	25.40	82.55	1.36	0.41
70	212.30	06BTB70	1610	41.28	25.40	82.55	1.68	0.41
76	230.49	06BTB76	1610	41.28	25.40	82.55	1.82	0.41
95	288.08	06BTB95	1610	41.28	25.40	82.55	2.28	0.41

*Has recessed groove in hub for chain clearance.
Sprockets with "H" suffix have hardened teeth.

Metric Sprockets



ISO **06B-2**
METRIC **35-2**

0.375 INCH (9.525mm) PITCH **DUPLEX** WIDTH CHAIN

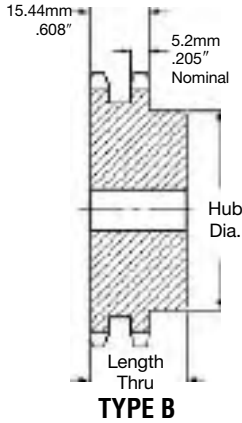

CHAIN DATA:
BS 228/3
ISO 06B-2
PITCH: 9.53mm (0.375 in.)
ROLLER DIAMETER: 6.35mm (0.250 in.)
ROLLER WIDTH: 5.72mm (0.225 in.)
TENSILE: 1730 kilos (3800 lbs.)

SPROCKETS

Duplex-Type B — Steel

No. Teeth	Pitch Diameter MM	Catalog Number	Bore		Hub		Weight (Approx.) Kilos
			Stock MM	Max. MM	Dia. MM	Thru MM	
12	36.80	D06B12	10	16	25	25	0.16
13	39.79	D06B13	10	18	28	25	0.20
14	42.80	D06B14	10	18	31	25	0.25
15	45.81	D06B15	10	20	34	25	0.29
16	48.82	D06B16	12	20	37	30	0.34
17	51.83	D06B17	12	24	40	30	0.39
18	54.85	D06B18	12	25	43	30	0.45
19	57.87	D06B19	12	28	46	30	0.52
20	60.89	D06B20	12	30	49	30	0.59
21	63.91	D06B21	12	30	52	30	0.68
22	66.93	D06B22	12	35	55	30	0.75
23	69.95	D06B23	12	38	58	30	0.80
24	72.97	D06B24	12	39	61	30	0.84
25	76.00	D06B25	12	40	64	30	0.89
26	79.02	D06B26	12	42	67	30	0.91
27	82.05	D06B27	12	45	70	30	1.00
28	85.07	D06B28	12	48	73	30	1.07
29	88.10	D06B29	12	50	76	30	1.14
30	91.12	D06B30	12	52	80	30	1.22
32	98.18	D06B32	16	52	80	30	1.30
35	106.26	D06B35	16	52	80	30	1.42
36	109.29	D06B36	16	60	90	30	1.58
38	115.35	D06B38	16	60	90	30	1.72
40	121.40	D06B40	16	52	80	35	1.81
42	127.46	D06B42	19	60	90	35	2.05
45	136.55	D06B45	19	60	90	35	2.35
48	145.64	D06B48	19	60	90	35	2.75
52	157.75	D06B52	19	60	90	35	3.13
57	172.91	D06B57	19	60	90	35	3.47
60	182.00	D06B60	19	60	90	35	3.78
68	206.24	D06B68	19	60	90	35	4.43
70	212.30	D06B70	19	60	90	35	4.56
72	218.37	D06B72	19	60	90	35	4.89
76	230.49	D06B76	19	60	90	38	5.67
84	254.74	D06B84	19	60	90	38	7.10
95	288.08	D06B95	25	62	95	38	8.64
96	291.11	D06B96	25	62	95	38	8.75
114	345.68	D06B114	25	62	95	38	11.12

Maximum bores shown will accommodate standard keyseat and setscrew over keyseat. Slightly larger bores are possible with no keyseat, shallow keyseat, or setscrew at angle to keyseat.

ISO **06B-2**
METRIC **35-2**

0.375 INCH (9.525mm) PITCH DUPLEX WIDTH CHAINS

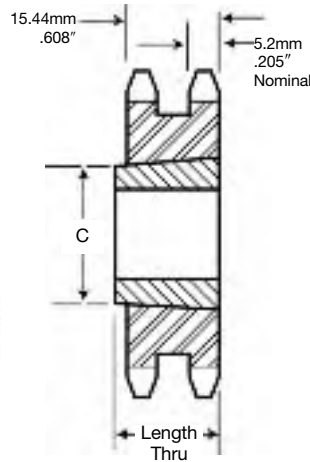

TYPE B

CHAIN DATA:

BS 228/3
ISO 06B-2
PITCH: 9.53mm (0.375 in.)
ROLLER DIAMETER: 6.35mm (0.250 in.)
ROLLER WIDTH: 5.72mm (0.225 in.)
TENSILE: 1730 kilos (3800 lbs.)

Duplex-Taper Bushed — Steel

No. Teeth	Pitch Diameter	Catalog Number	Bushing Number	Bore Max.	Dimension		Weight	
	MM				L	C	Rim	Bushing
							MM	MM
19	57.87	D06BTB19	1008	25.40	22.23	46.43	0.6	0.14
20	60.89	D06BTB20	1008	25.40	22.23	49.20	0.8	0.14
21	63.91	D06BTB21	1008	25.40	22.23	52.39	1.4	0.14
22	66.93	D06BTB22	1008	25.40	22.23	55.56	1.7	0.14
24	72.97	D06BTB24	1210	31.75	25.40	61.91	1.8	0.27
25	76.00	D06BTB25	1210	31.75	25.40	61.91	1.9	0.27
26	79.02	D06BTB26	1210	31.75	25.40	66.68	2.0	0.27
30	91.12	D06BTB30	1610	41.28	25.40	79.38	1.8	0.41
32	97.18	D06BTB32	1610	41.28	25.40	82.55	2.0	0.41
35	106.26	D06BTB35	1610	41.28	25.40	82.55	2.3	0.41
38	115.34	D06BTB38	1610	41.28	25.40	82.55	2.5	0.41
40	121.40	D06BTB40	1610	41.28	25.40	82.55	2.9	0.41
45	136.55	D06BTB45	1610	41.28	25.40	82.55	3.2	0.41
48	145.65	D06BTB48	1610	41.28	25.40	92.08	3.5	0.41
54	163.82	D06BTB54	1610	41.28	25.40	92.08	3.9	0.41
57	172.91	D06BTB57	1610	41.28	25.40	92.08	4.1	0.41
60	182.00	D06BTB60	1610	41.28	25.40	92.08	4.9	0.41
70	212.30	D06BTB70	1610	41.28	25.40	92.08	6.3	0.41
76	230.49	D06BTB76	1610	41.28	25.40	92.08	6.8	0.41
95	288.08	D06BTB95	1610	41.28	25.40	92.08	6.9	0.41

Metric Sprockets



0.375 INCH (9.525mm) PITCH TRIPLEX

ISO 06B-3
METRIC 35-3

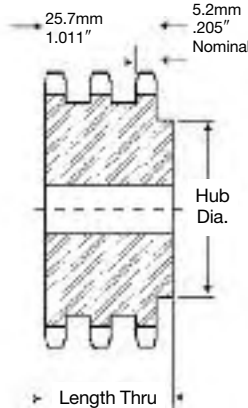

TYPE B

CHAIN DATA:

BS 228/3
ISO 06B-3
PITCH: 9.53mm (0.375 in.)
ROLLER DIAMETER: 6.35mm (0.250 in.)
ROLLER WIDTH: 5.72mm (0.225 in.)
TENSILE: 2540 kilos (5600 lbs.)

SPROCKETS

Triplex-Type B — Steel

No. Teeth	Pitch Diameter MM	Catalog Number	Bore		Hub		Weight (Approx.) Kilos
			Stock MM	Max. MM	Dia. MM	Thru MM	
12	36.80	E06B12	12	16	25	35	0.23
13	39.80	E06B13	12	18	28	35	0.27
14	42.80	E06B14	12	18	31	35	0.32
15	45.81	E06B15	12	20	34	35	0.36
16	48.82	E06B16	12	20	37	35	0.45
17	51.84	E06B17	12	24	40	35	0.54
18	54.85	E06B18	12	25	43	35	0.64
19	57.87	E06B19	12	28	46	35	0.72
20	60.89	E06B20	12	30	49	35	0.77
21	63.91	E06B21	14	30	52	40	0.86
22	66.93	E06B22	14	35	54	40	0.95
23	69.95	E06B23	14	38	58	40	1.04
24	72.97	E06B24	14	39	61	40	1.18
25	76.00	E06B25	14	40	64	40	1.27
26	79.02	E06B26	14	42	67	40	1.31
27	82.05	E06B27	14	45	70	40	1.36
28	85.07	E06B28	14	48	73	40	1.50
29	88.10	E06B29	14	50	76	40	1.68
30	91.12	E06B30	14	52	80	40	1.72
32	97.18	E06B32	16	52	80	48	2.00
35	106.26	E06B35	16	52	80	48	2.25
36	109.29	E06B36	16	60	90	40	2.33
38	115.34	E06B38	16	60	90	40	2.49
40	121.40	E06B40	16	52	80	48	2.65
42	127.46	E06B42	19	60	90	48	2.81
45	136.55	E06B45	19	60	90	48	3.00
48	145.64	E06B48	19	60	90	48	3.20
52	157.75	E06B52	19	60	90	48	3.46
57	172.91	E06B57	19	60	90	48	4.77
60	182.00	E06B60	19	60	80	48	5.02
68	206.24	E06B68	19	60	90	48	5.69
72	218.37	E06B72	19	60	90	48	6.02
76	230.49	E06B76	19	64	100	48	8.48
84	254.74	E06B84	19	64	100	48	9.37
95	288.08	E06B95	25	64	100	54	13.61
96	291.11	E06B96	25	64	100	54	13.75
114	345.68	E06B114	25	64	100	54	17.48

ISO 08B-1 METRIC 40

0.500 INCH (12.70mm) PITCH SIMPLEX

CHAIN DATA:
BS 228/7
ISO 08B-1
PITCH: 12.70mm (0.500 in.)
ROLLER DIAMETER: 8.51mm (0.335 in.)
ROLLER WIDTH: 7.75mm (0.305 in.)
TENSILE: 1820 kilos (4000 lbs.)

Simplex-Type A — Steel

Simplex-Type B — Steel

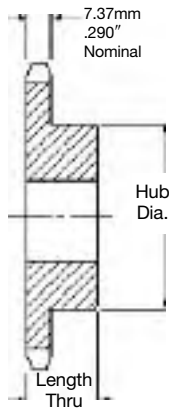
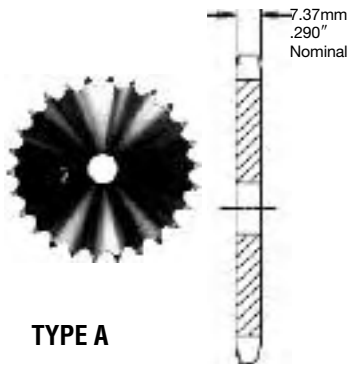

TYPE B

No. Teeth	Pitch Diameter MM	Catalog Number	Bore		Hub		Weight (Approx.) Kilos	Catalog Number	Bore Stock MM	Weight (Approx.) Kilos
			Stock MM	Max. MM	Dia. MM	Thru MM				
9	37.13	08B9	10	15	21	25	0.14			
10	41.10	08B10	10	20	26	25	0.15			
11	45.08	08B11	10	22	30	25	0.17			
12	49.07	08B12	10	22	34	28	0.24	08A12	0.08	
13	53.07	08B13	10	25	38	28	0.25	08A13	0.1	
14	57.07	08B14	10	28	42	28	0.31	08A14	0.12	
15	61.08	08B15	10	30	46	28	0.33	08A15	0.14	
16	65.10	08B16	12	32	50	28	0.37	08A16	0.15	
17	69.12	08B17	12	35	54	28	0.51	08A17	0.16	
18	73.14	08B18	12	38	57	28	0.54	08A18	0.2	
19	77.16	08B19	12	40	64	28	0.65	08A19	0.21	
20	81.18	08B20	12	42	67	28	0.76	08A20	0.25	
21	85.21	08B21	12	45	70	28	0.82	08A21	0.26	
22	89.24	08B22	12	48	73	28	0.88	08A22	0.3	
23	93.27	08B23	12	51	78	28	1.05	08A23	0.33	
24	97.30	08B24	14	53	82	28	1.05	08A24	0.37	
25	101.33	08B25	14	53	82	28	1.13	08A25	0.4	
26	105.36	08B26	16	53	82	30	1.15	08A26	0.43	
27	109.40	08B27	16	53	82	30	1.19	08A27	0.44	
28	113.43	08B28	16	53	82	30	1.30	08A28	0.5	
29	117.46	08B29	16	53	82	30	1.33	08A29	0.55	
30	121.50	08B30	16	53	89	30	1.36	08A30	0.57	
31	125.53	08B31	16	60	89	30	1.41	08A31	0.64	
32	129.57	08B32	16	60	89	30	1.46	08A32	0.67	
33	133.61	08B33	16	60	89	30	1.51	08A33	0.71	
34	137.64	08B34	16	60	89	30	1.56	08A34	0.74	
35	141.68	08B35	16	60	89	30	1.61	08A35	0.77	
36	145.72	08B36	16	60	89	35	1.69	08A36	0.83	
37	149.75	08B37	16	60	89	35	1.74	08A37	0.87	
38	153.79	08B38	16	60	89	35	1.78	08A38	0.91	
39	157.83	08B39	19	60	89	35	1.83	08A39	0.92	
40	161.87	08B40	19	60	89	35	1.88	08A40	1.01	
42	169.94	08B42	19	60	89	35	1.97	08A42	1.13	
45	182.06	08B45	19	60	89	35	2.11	08A45	1.43	
48	194.18	08B48	19	64	100	35	2.76	08A48	1.46	
54	218.42	08B54	19	64	100	35	3.11	08A54	2.01	
57	230.54	08B57	19	64	100	35	3.28	08A57	2.27	
60	242.66	08B60	19	64	100	35	3.45	08A60	2.03	
64	258.83	08B64	19	64	100	35	3.68	08A64	2.17	
70	283.07	08B70	19	64	100	35	4.02	08A70	3.28	
72	291.15	08B72	19	64	100	35	4.13	08A72	3.51	
76	307.32	08B76	19	64	100	35	5.73	08A76	3.70	
80	323.49	08B80	19	64	100	35	6.03	08A80	4.63	
84	339.65	08B84	19	64	100	35	6.33	08A84	4.57	
95	384.11	08B95	25	64	100	35	8.90	08A95	5.45	
96	388.15	08B96	25	64	100	35	8.99	08A96	5.51	
114	460.91	08B114	25	64	100	35	11.17	08A114	6.54	

Maximum bores shown will accommodate standard keyseat and setscrew over keyseat. Slightly larger bores are possible with no keyseat, shallow keyseat, or setscrew at angle to keyseat.

SPROCKETS

Metric Sprockets

Martin

0.500 INCH (12.70mm) PITCH **SIMPLEX**

ISO **08B-1**
METRIC **40**

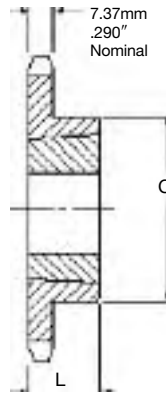

TYPE B

CHAIN DATA:

BS 228/7
ISO 08B-1
PITCH: 12.70mm (0.500 in.)
ROLLER DIAMETER: 8.51mm (0.335 in.)
ROLLER WIDTH: 7.75mm (0.305 in.)
TENSILE: 1820 kilos (4000 lbs.)

SPROCKETS

Simplex-Taper Bushed — Steel

No. Teeth	Pitch Diameter	Catalog Number	Bushing Number	Bore Max. MM	Dimension		Weight	
	MM				L MM	C MM	Rim Kilos	Bushing Kilos
14	57.07	08BTB14H	1008	25.40	22.23	46*	0.18	0.14
15	61.08	08BTB15H	1008	25.40	22.23	46	0.18	0.14
16	65.10	08BTB16H	1008	25.40	22.23	46	0.23	0.14
17	69.12	08BTB17H	1210	31.75	25.40	60*	0.23	0.14
18	73.14	08BTB18H	1210	31.75	25.40	62*	0.27	0.27
19	77.16	08BTB19H	1210	31.75	25.40	62	0.32	0.27
20	81.18	08BTB20H	1610	41.28	25.40	70*	0.41	0.41
21	85.21	08BTB21H	1610	41.28	25.40	70	0.45	0.41
22	89.24	08BTB22H	1610	41.28	25.40	70	0.50	0.41
23	93.27	08BTB23H	1610	41.28	25.40	76	0.59	0.41
24	97.30	08BTB24H	1610	41.28	25.40	82	0.73	0.41
25	101.33	08BTB25H	1610	41.28	25.40	82	0.73	0.41
26	105.36	08BTB26H	1610	41.28	25.40	82	0.73	0.41
27	109.40	08BTB27H	1610	41.28	25.40	76	0.70	0.41
28	113.43	08BTB28H	1610	41.28	25.40	76	0.73	0.41
29	117.46	08BTB29H	1610	41.28	25.40	76	0.76	0.41
30	121.50	08BTB30H	1610	41.28	25.40	73	0.82	0.41
32	129.57	08BTB32	1610	41.28	25.40	76	0.87	0.41
35	141.68	08BTB35	1610	41.28	25.40	76	0.96	0.41
36	145.72	08BTB36	1610	41.28	25.40	76	0.98	0.41
38	153.79	08BTB38	1610	41.28	25.40	76	1.23	0.41
40	161.87	08BTB40	1610	41.28	25.40	76	1.29	0.41
42	169.94	08BTB42	1610	41.28	25.40	76	1.36	0.41
45	182.06	08BTB45	1610	41.28	25.40	76	1.46	0.41
48	194.18	08BTB48	1610	41.28	25.40	76	1.55	0.41
54	218.42	08BTB54	1610	41.28	25.40	76	1.75	0.41
57	230.54	08BTB57	1610	41.28	25.40	76	2.63	0.41
60	242.66	08BTB60	1610	41.28	25.40	76	2.77	0.41
70	283.07	08BTB70	2012	50.80	31.75	90	3.93	0.41
72	291.15	08BTB72	2012	50.80	31.75	90	4.05	0.41
76	307.32	08BTB76	2012	50.80	31.75	90	4.27	0.77
80	323.49	08BTB80	2012	50.80	31.75	90	4.49	0.77
84	339.65	08BTB84	2012	50.80	31.75	90	4.72	0.77
95	384.11	08BTB95	2012	50.80	31.75	90	6.81	0.77
96	388.15	08BTB96	2012	50.80	31.75	90	6.88	0.77
114	460.91	08BTB114	2517	63.50	44.45	108	10.44	0.77

* Has recessed groove in hub for chain clearance.
Sprockets with "H" suffix have hardened teeth.

0.500 INCH (12.70mm) PITCH DUPLEX

ISO 08B-2
METRIC 40-2

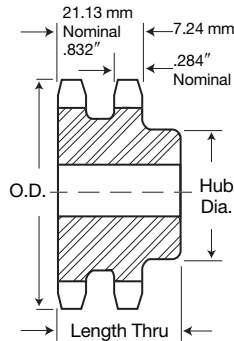

TYPE B

CHAIN DATA:

BS 228/7
ISO 08B-2
PITCH: 12.70mm (0.500 in.)
ROLLER DIAMETER: 8.51mm (0.335 in.)
ROLLER WIDTH: 7.75mm (0.305 in.)
TENSILE: 3180 kilos (7000 lbs.)

Duplex-Type B — Steel

No. Teeth	Pitch Diameter MM	Catalog Number	Bore		Hub		Weight (Approx.) Kilos
			Stock MM	Max. MM	Dia. MM	Thru MM	
10	41.10	D08B10	10	18	26	32	0.22
11	45.08	D08B11	11	21	30	35	0.22
12	49.07	D08B12	12	23	34	35	0.26
13	53.07	D08B13	12	25	38	35	0.28
14	57.07	D08B14	12	28	42	35	0.34
15	61.08	D08B15	12	30	46	35	0.36
16	65.10	D08B16	14	33	50	35	0.35
17	69.12	D08B17	14	36	54	35	0.44
18	73.14	D08B18	14	38	58	35	0.49
19	77.16	D08B19	14	40	62	35	0.57
20	81.18	D08B20	14	40	66	35	0.65
21	85.21	D08B21	16	45	70	40	0.72
22	89.24	D08B22	16	45	70	40	0.73
23	93.27	D08B23	16	45	70	40	0.83
24	97.30	D08B24	16	50	75	40	0.94
25	101.33	D08B25	16	52	80	40	0.98
26	105.36	D08B26	20	56	85	40	1.04
27	109.40	D08B27	20	56	85	40	1.08
28	113.43	D08B28	20	60	90	40	1.10
29	117.46	D08B29	20	62	95	40	1.14
30	121.50	D08B30	20	64	100	40	1.16
32	129.57	D08B32	20	64	100	40	1.24
35	141.68	D08B35	20	64	100	40	1.35
36	145.72	D08B36	20	73	110	40	2.05
38	153.79	D08B38	20	73	110	45	2.17
40	161.87	D08B40	20	73	110	45	2.28
42	169.94	D08B42	20	73	110	45	2.32
45	182.06	D08B45	20	73	110	45	2.49
48	194.18	D08B48	20	73	110	45	2.65
54	218.42	D08B54	25	73	110	45	2.98
57	230.54	D08B57	25	73	110	45	3.88
60	242.66	D08B60	25	73	110	45	4.08
68	283.07	D08B68	25	73	110	45	4.63
72	291.16	D08B72	25	73	110	45	4.90
76	307.32	D08B76	30	80	120	45	6.60
84	339.65	D08B84	30	80	120	45	7.29
95	384.11	D08B95	30	80	120	45	9.89
96	388.15	D08B96	30	80	120	45	9.99
114	460.90	D08B114	30	80	120	45	12.88

Maximum bores shown will accommodate standard keyseat and setscrew over keyseat. Slightly larger bores are possible with no keyseat, shallow keyseat, or setscrew at angle to keyseat.

Metric Sprockets



ISO **08B-2**
METRIC **40-2**

0.500 INCH (12.70mm) PITCH **DUPLEX**

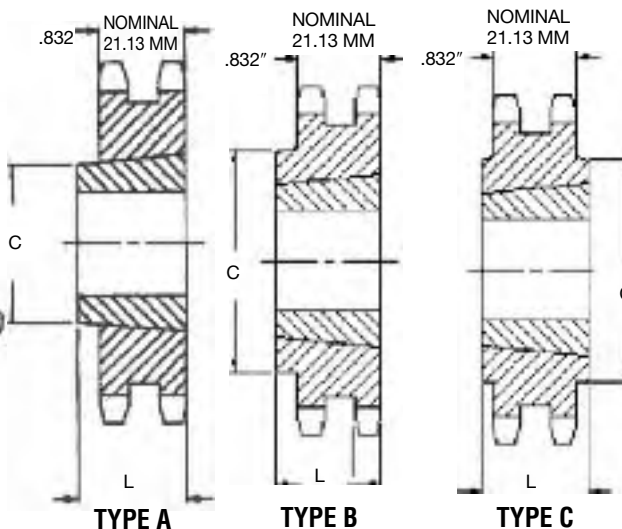

CHAIN DATA:
BS 228/7
ISO 08B-2
PITCH: 12.70mm (0.500 in.)
ROLLER DIAMETER: 8.51mm (0.335 in.)
ROLLER WIDTH: 7.75mm (0.305 in.)
TENSILE: 3180 kilos (7000 lbs.)

SPROCKETS

Duplex-Taper Bushed — Steel

No. Teeth	Pitch Diameter	Catalog Number	Bushing Number	Bore Max.	Dimension		Weight	
	MM			MM	L	C	Rim	Bushing
					MM	MM	Kilos	Kilos
15	61.08	D08ATB15	1008	25.40	22.22		0.18	0.13
16	65.10	D08ATB16	1008	25.40	22.22		0.22	0.13
17	69.12	D08ATB17	1008	25.40	22.22		0.27	0.13
18	73.14	D08BTB18	1210	31.75	25.40	58	0.27	0.27
19	77.16	D08BTB19	1210	31.75	25.40	63	0.36	0.27
20	81.18	D08BTB20	1610	41.27	25.40	70	0.37	0.41
21	85.21	D08BTB21	1610	41.27	25.40	70	0.46	0.41
22	89.24	D08BTB22	1610	41.27	25.40	74	0.55	0.41
23	93.27	D08BTB23	1610	41.27	25.40	78	0.59	0.41
24	97.30	D08BTB24	2012	41.27	25.40	83	0.70	0.41
25	101.33	D08BTB25	2012	50.80	31.75	87	0.77	0.77
26	105.36	D08BTB26	2012	50.80	31.75	87	0.80	0.77
28	113.43	D08BTB28	2012	50.80	31.75	99	1.06	0.77
30	121.50	D08BTB30	2012	50.80	31.75	108	1.59	0.77
35	141.68	D08BTB35	2012	50.80	31.75	108	1.86	0.77
36	145.72	D08BTB36	2012	50.80	31.75	108	1.91	0.77
38	153.79	D08BTB38	2012	50.80	31.75	108	3.18	0.77
42	169.94	D08CTB42	2517	50.80	44.45	108	5.57	1.59
45	182.06	D08CTB45	2517	63.50	44.45	108	5.97	1.59
48	194.18	D08CTB48	2517	63.50	44.45	108	6.37	1.59
54	218.42	D08CTB54	2517	63.50	44.45	108	7.17	1.59
57	230.54	D08CTB57	2517	63.50	44.45	108	7.56	1.59
60	242.66	D08CTB60	2517	63.50	44.45	108	12.05	1.59
68	274.99	D08CTB68	2517	63.50	44.45	108	13.66	1.59
70	283.07	D08CTB70	2517	63.50	44.45	108	14.06	1.59
72	291.15	D08CTB72	2517	63.50	44.45	108	14.46	1.59
76	307.32	D08CTB76	2517	63.50	44.45	108	15.26	1.59
84	339.65	D08CTB84	2517	63.50	44.45	108	16.87	1.59
95	384.11	D08CTB95	2517	63.50	44.45	108	19.08	1.59
96	388.15	D08CTB96	2517	63.50	44.45	108	19.28	1.59
114	460.91	D08CTB114	2517	63.50	44.45	108	22.90	1.59

ISO **08B-3**
METRIC **40-3**

0.500 INCH (12.70mm) PITCH TRIPLEX

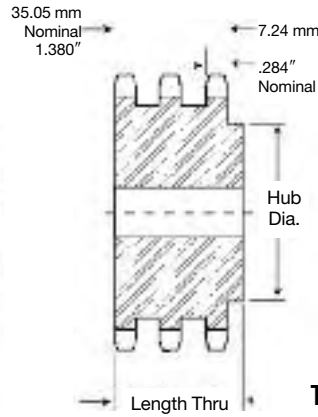

TYPE B

CHAIN DATA:

BS 228/7
ISO 08B-3
PITCH: 12.70mm (0.500 in.)
ROLLER DIAMETER: 8.51mm (0.335 in.)
ROLLER WIDTH: 7.75mm (0.305 in.)
TENSILE: 4540 kilos (10,000 lbs.)

Triples-Type B — Steel

No. Teeth	Pitch Diameter MM	Catalog Number	Bore		Hub		Weight (Approx.) Kilos
			Stock	Max.	Dia.	Thru	
			MM	MM	MM	MM	
11	45.08	E08B11	14	22	30	50	0.32
12	49.07	E08B12	14	24	34	50	0.45
13	53.06	E08B13	14	25	38	50	0.59
14	57.07	E08B14	14	28	42	50	0.72
15	61.08	E08B15	14	31	46	50	0.81
16	65.10	E08B16	16	35	50	50	0.90
17	69.12	E08B17	16	36	54	50	1.04
18	73.14	E08B18	16	38	58	50	1.22
19	77.16	E08B19	16	40	62	50	1.41
20	81.18	E08B20	16	40	66	50	1.58
21	85.21	E08B21	20	45	70	55	1.81
22	89.24	E08B22	20	45	70	55	2.03
23	93.27	E08B23	20	45	70	55	2.27
24	97.30	E08B24	20	50	75	55	2.44
25	101.33	E08B25	20	52	80	55	2.54
26	105.36	E08B26	20	56	85	55	2.85
27	109.40	E08B27	20	56	85	55	2.85
28	113.43	E08B28	20	60	90	55	3.16
29	117.46	E08B29	20	62	95	55	3.34
30	121.50	E08B30	20	64	100	55	3.48
35	141.68	E08B35	20	73	110	55	4.79
36	145.72	E08B36	25	80	120	55	5.43
38	153.79	E08B38	25	80	120	60	6.49
42	169.94	E08B42	25	80	120	60	7.17
45	182.06	E08B45	25	80	120	60	7.69
48	194.18	E08B48	25	80	120	60	8.20
52	210.34	E08B52	25	80	120	60	8.88
54	218.43	E08B54	25	80	120	60	9.22
57	230.54	E08B57	25	80	120	60	12.62
60	242.66	E08B60	25	85	130	65	13.84
68	274.99	E08B68	25	85	130	65	15.69
72	291.15	E08B72	25	85	130	65	16.61
76	307.32	E08B76	30	85	130	65	22.23
84	339.65	E08B84	30	85	130	65	24.57
95	384.11	E08B95	30	85	130	65	33.11
114	460.91	E08B114	30	85	130	65	41.90

Maximum bores shown will accommodate standard keyseat and setscrew over keyseat. Slightly larger bores are possible with no keyseat, shallow keyseat, or setscrew at angle to keyseat.

Metric Sprockets



0.625 INCH (15.88mm) PITCH **SIMPLEX**

ISO **10B-1**
METRIC **50**

Simplex-Type B — Steel

Simplex-Type A — Steel

No. Teeth	Pitch Diameter MM	Catalog Number	Bore		Hub		Weight (Approx.) Kilos	Catalog Number	Bore Stock MM	Weight (Approx.) Kilos
			Stock MM	Max. MM	Dia. MM	Thru MM				
8	41.48	10B8	12	16	22	25	0.09			
9	46.42	10B9	12	19	27	25	0.14			
10	51.37	10B10	12	22	32	25	0.23			
11	56.35	10B11	12	25	37	25	0.27			
12	61.34	10B12	12	32	43	25	0.32	10A12	12	0.15
13	66.33	10B13	12	33	48	25	0.36	10A13	12	0.19
14	71.34	10B14	12	36	53	25	0.45	10A14	12	0.23
15	76.36	10B15	12	38	57	25	0.59	10A15	12	0.25
16	81.37	10B16	12	44	63	25	0.68	10A16	12	0.31
17	86.39	10B17	12	47	67	25	0.82	10A17	12	0.35
18	91.42	10B18	12	48	73	25	0.91	10A18	12	0.39
19	96.45	10B19	16	51	76	25	1.04	10A19	16	0.43
20	101.48	10B20	16	51	76	25	1.13	10A20	16	0.48
21	106.51	10B21	16	51	76	25	1.18	10A21	16	0.51
22	111.55	10B22	16	51	76	25	1.27	10A22	16	0.59
23	116.59	10B23	16	51	76	25	1.45	10A23	16	0.65
24	121.62	10B24	16	51	76	32	1.50	10A24	15	0.68
25	126.66	10B25	16	51	76	32	1.59	10A25	15	0.73
26	131.70	10B26	16	51	76	32	1.63	10A26	15	0.78
27	136.74	10B27	19	51	76	32	1.68	10A27	18	0.89
28	141.79	10B28	19	51	76	32	1.72	10A28	18	0.93
29	146.83	10B29	19	51	76	32	1.91	10A29	18	1.07
30	151.87	10B30	19	57	82	32	2.04	10A30	18	1.15
31	156.92	10B31	19	57	82	32	2.13	10A31	18	1.27
32	161.96	10B32	19	57	82	32	2.27	10A32	18	1.23
33	167.01	10B33	19	57	82	32	2.33	10A33	18	1.42
34	172.05	10B34	19	57	82	32	2.36	10A34	18	1.45
35	177.10	10B35	19	57	82	32	2.48	10A35	18	1.51
36	182.15	10B36	19	57	82	32	2.56	10A36	18	1.73
37	187.19	10B37	19	57	82	32	2.68	10A37	18	1.81
38	192.24	10B38	19	57	82	32	2.72	10A38	18	1.88
39	197.29	10B39	19	57	82	32	2.86	10A39	18	2.00
40	202.33	10B40	19	57	82	32	2.95	10A40	18	2.02
41	207.38	10B41	19	57	82	32	3.01	10A41	18	2.20
42	212.43	10B42	19	57	82	32	3.16	10A42	18	2.26
43	217.48	10B43	19	57	82	32	3.20	10A43	18	2.38
44	222.53	10B44	19	57	82	32	3.44	10A44	18	2.46
45	227.58	10B45	19	64	95	32	3.73	10A45	18	2.69
46	232.63	10B46	19	64	95	32	3.85	10A46	18	2.91
47	237.68	10B47	19	64	95	32	3.89	10A47	18	2.95
48	242.73	10B48	25	64	95	32	4.18	10A48	24	2.98
49	247.78	10B49	25	64	95	32	4.21	10A49	24	3.20
50	252.82	10B50	25	64	95	32	4.40	10A50	24	3.22
51	257.87	10B51	25	64	95	32	4.48	10A51	24	3.32
52	262.92	10B52	25	64	95	32	4.64	10A52	24	3.62
53	267.97	10B53	25	64	95	32	4.75	10A53	24	3.67
54	273.03	10B54	25	64	95	32	4.86	10A54	24	3.76
55	278.08	10B55	25	64	95	32	4.96	10A55	24	3.88
56	283.13	10B56	25	64	95	32	5.22	10A56	24	4.04
57	288.18	10B57	25	64	95	32	5.27	10A57	24	4.25
58	293.23	10B58	25	64	95	32	5.36	10A58	24	4.67
59	298.28	10B59	25	64	95	32	5.59	10A59	24	4.76
60	303.33	10B60	25	64	95	32	5.90	10A60	24	4.90
70	353.84	10B70	25	64	95	44	8.24	10A70	24	6.35
72	363.94	10B72	25	64	95	44	8.84	10A72	24	6.91
76	384.15	10B76	25	64	95	44	11.03	10A76	24	9.11
80	404.36	10B80	25	70	108	44	11.22	10A80	24	9.53
84	424.57	10B84	25	70	108	44	11.57	10A84	24	10.02
95	480.14	10B95	25	70	108	44	14.57	10A95	24	12.25
96	485.19	10B96	25	70	108	44	14.93	10A96	24	12.43
112	566.03	10B112	25	70	108	44	19.05	10A112	24	17.10
114	576.13	10B114	25	70	108	44	20.61	10A114	24	17.84

CHAIN DATA:

BS 228/11
ISO 10B-1
PITCH: 15.88mm (0.625 in.)
ROLLER DIAMETER: 10.16mm (0.400 in.)
ROLLER WIDTH: 9.65mm (0.380 in.)
TENSILE: 2270 kilos (4500 lbs.)

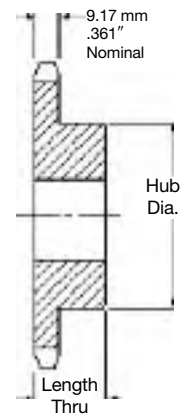
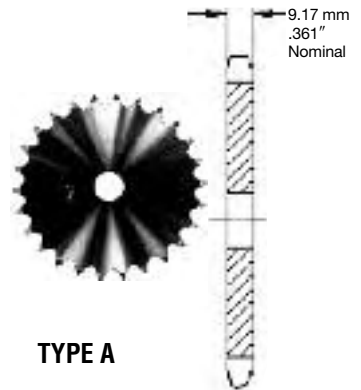

TYPE B

Maximum bores shown will accommodate standard keyseat and setscrew over keyseat. Slightly larger bores are possible with no keyseat, shallow keyseat, or setscrew at angle to keyseat.

ISO **10B-1**
METRIC **50**

0.625 INCH (15.88mm) PITCH SIMPLEX

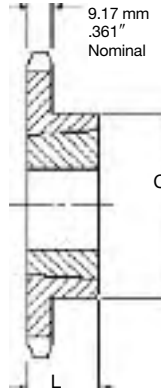

TYPE B

CHAIN DATA:

BS 228/11
ISO 10B-1
PITCH: 15.88mm (0.625 in.)
ROLLER DIAMETER: 10.16mm (0.400 in.)
ROLLER WIDTH: 9.65mm (0.380 in.)
TENSILE: 2270 kilos (5000 lbs.)

Simplex-Taper Bushed — Steel

No. Teeth	Pitch Diameter	Catalog Number	Bushing Number	Bore Max.	Dimension		Weight	
	MM				L	C	Rim Kilos	Bushing Kilos
12	61.34	10BTB12H	1008	25.40	22.23	49.20*	0.23	0.14
13	66.33	10BTB13H	1008	25.40	22.23	46.02	0.23	0.14
14	71.34	10BTB14H	1008	25.40	22.23	49.20	0.27	0.14
15	76.35	10BTB15H	1210	31.75	25.40	62.69*	0.32	0.27
16	81.37	10BTB16H	1610	41.28	25.40	70.64*	0.41	0.41
17	86.39	10BTB17H	1610	41.28	25.40	70.64*	0.41	0.41
18	91.42	10BTB18H	1610	41.28	25.40	70.64	0.41	0.41
19	96.45	10BTB19H	1610	41.28	25.40	76.20	0.64	0.41
20	101.48	10BTB20H	1610	41.28	25.40	76.20	0.68	0.41
21	106.51	10BTB21H	1610	41.28	25.40	76.20	0.73	0.41
22	111.55	10BTB22H	1610	41.28	25.40	76.20	0.78	0.41
23	116.59	10BTB23H	2012	50.80	31.75	90.47	0.82	0.77
24	121.62	10BTB24H	2012	50.80	31.75	90.47	0.91	0.77
25	126.66	10BTB25H	2012	50.80	31.75	90.47	1.09	0.77
26	131.70	10BTB26H	2012	50.80	31.75	90.47	1.14	0.77
27	136.74	10BTB27H	2012	50.80	31.75	90.47	1.18	0.77
28	141.79	10BTB28H	2012	50.80	31.75	90.47	1.29	0.77
30	151.87	10BTB30H	2012	50.80	31.75	90.47	1.41	0.77
32	161.96	10BTB32	2012	50.80	31.75	90.47	1.63	0.77
35	177.10	10BTB35	2012	50.80	31.75	90.47	1.91	0.77
36	182.15	10BTB36	2012	50.80	31.75	90.47	1.95	0.77
38	192.24	10BTB38	2012	50.80	31.75	90.47	2.22	0.77
40	202.33	10BTB40	2012	50.80	31.75	90.47	2.36	0.77
42	212.43	10BTB42	2012	50.80	31.75	90.47	2.68	0.77
45	227.58	10BTB45	2012	50.80	31.75	90.47	2.95	0.77
48	242.73	10BTB48	2012	50.80	31.75	90.47	3.31	0.77
54	273.03	10BTB54	2012	50.80	31.75	90.47	4.08	0.77
57	288.18	10BTB57	2012	50.80	31.75	90.47	4.59	0.77
60	303.33	10BTB60	2012	50.80	31.75	90.47	4.90	0.77
70	353.84	10BTB70	2517	63.50	44.45	107.95	6.35	1.59
72	363.94	10BTB72	2517	63.50	44.45	107.95	7.03	1.59
76	384.15	10BTB76	2517	63.50	44.45	107.95	8.31	1.59
80	404.36	10BTB80	2517	63.50	44.45	107.95	8.85	1.59
84	424.57	10BTB84	2517	63.50	44.45	107.95	10.21	1.59
95	480.14	10BTB95	2517	63.50	44.45	107.95	12.76	1.59
96	485.19	10BTB96	2517	63.50	44.45	107.95	13.15	1.59
114	576.13	10BTB114	2517	63.50	44.45	107.95	19.61	1.59

* Has recessed groove in hub for chain clearance.
Sprockets with "H" suffix have hardened teeth.

Metric Sprockets

0.625 INCH (15.88mm) PITCH **DUPLEX**

ISO **10B-2**
METRIC **50-2**

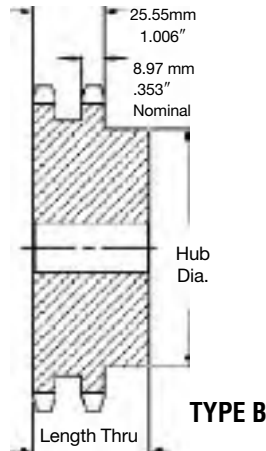

CHAIN DATA:
BS 228/11
ISO 10B-2
PITCH: 15.88mm (0.625 in.)
ROLLER DIAMETER: 10.16mm (0.400 in.)
ROLLER WIDTH: 9.65mm (0.380 in.)
TENSILE: 4540 kilos (10,000 lbs.)

SPROCKETS

Duplex-Type B — Steel

No. Teeth	Pitch Diameter MM	Catalog Number	Bore		Hub		Weight (Approx.) Kilos
			Stock	Max.	Dia.	Thru	
			MM	MM	MM	MM	
11	56.35	D10B11	14	24	37	40	0.44
12	61.34	D10B12	14	28	43	40	0.57
13	66.33	D10B13	14	33	48	40	0.71
14	71.34	D10B14	14	35	53	40	0.84
15	76.35	D10B15	14	38	58	40	1.01
16	81.37	D10B16	16	40	63	45	1.19
17	86.39	D10B17	16	45	68	45	1.38
18	91.42	D10B18	16	48	73	45	1.62
19	96.45	D10B19	16	52	79	45	1.77
20	101.48	D10B20	16	56	84	45	1.93
21	106.51	D10B21	16	56	85	45	2.22
22	111.55	D10B22	16	60	90	45	2.53
23	116.59	D10B23	16	62	95	45	2.77
24	121.62	D10B24	16	64	100	45	2.95
25	126.66	D10B25	16	68	105	45	3.15
26	131.70	D10B26	20	73	110	45	3.42
27	136.74	D10B27	20	73	110	45	3.98
28	141.79	D10B28	20	76	115	45	4.20
29	146.83	D10B29	20	76	115	45	4.43
30	151.87	D10B30	20	80	120	45	4.66
32	161.96	D10B32	20	80	120	45	5.16
35	177.10	D10B35	20	80	120	45	5.96
36	182.15	D10B36	20	80	120	45	6.70
38	192.24	D10B38	20	80	120	50	7.67
40	202.33	D10B40	30	80	120	50	7.92
45	227.58	D10B45	30	80	120	50	9.21
48	242.73	D10B48	30	80	120	60	10.92
57	288.18	D10B57	32	85	130	60	15.07
60	303.33	D10B60	32	85	130	60	16.27
70	353.84	D10B70	32	85	130	60	21.99
76	384.15	D10B76	32	85	130	60	26.31
80	404.36	D10B80	32	85	130	60	27.98
95	480.14	D10B95	32	85	130	60	32.69
114	576.13	D10B114	32	85	130	60	49.30

Maximum bores shown will accommodate standard keyseat and setscrew over keyseat. Slightly larger bores are possible with no keyseat, shallow keyseat, or setscrew at angle to keyseat.

0.625 INCH (15.88mm) PITCH DUPLEX

ISO 10B-2
METRIC 50-2

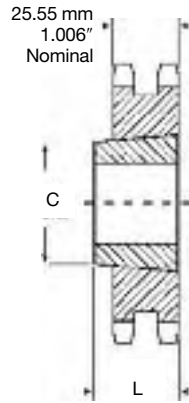

TYPE A

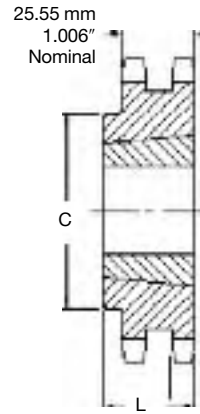

TYPE B

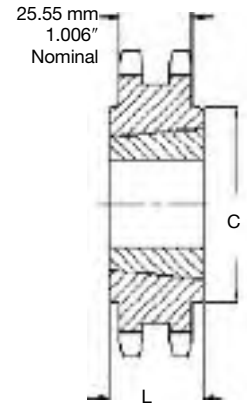

TYPE C

CHAIN DATA:

BS 228/11
ISO 10B-2
PITCH: 15.878mm (0.625 in.)
ROLLER DIAMETER: 10.16mm (0.400 in.)
ROLLER WIDTH: 9.65mm (0.380 in.)
TENSILE: 4540 kilos (10,000 lbs.)

Duplex-Taper Bushed — Steel

No. Teeth	Pitch Diameter	Catalog Number	Bushing Number	Bore Max. MM	Dimension		Weight	
	MM				L MM	C MM	Rim Kilos	Bushing Kilos
14	71.34	D10ATB14	1008	25.40	22.23		0.45	0.14
15	76.35	D10ATB15	1210	31.75	25.40		0.48	0.27
16	81.37	D10ATB16	1210	31.75	25.40		0.50	0.27
17	86.39	D10ATB17	1610	41.28	25.40		0.57	0.41
18	91.42	D10ATB18	1610	41.28	25.40		0.64	0.41
19	96.45	D10ATB19	1610	41.28	25.40		0.71	0.41
20	101.49	D10BTB20	2012	50.80	25.40	84	0.82	0.77
21	106.52	D10BTB21	2012	50.80	25.40	89	0.86	0.77
22	111.55	D10BTB22	2012	50.80	31.75	99	1.45	0.77
23	116.59	D10BTB23	2012	50.80	31.75	109	1.72	0.77
25	126.66	D10BTB25	2012	50.80	31.75	134	3.40	0.77
30	151.87	D10BTB30	2517	63.50	44.45	107.95	3.92	1.59
36	182.15	D10CTB36	2517	63.50	44.45	107.95	4.54	1.59
38	192.24	D10CTB38	2517	63.50	44.45	107.95	5.68	1.59
42	212.43	D10CTB42	2517	63.50	44.45	107.95	7.95	1.59
48	242.73	D10CTB48	2517	63.50	44.45	107.95	11.35	1.59
57	288.18	D10CTB57	2517	63.50	44.45	107.95	19.69	1.59
60	303.33	D10CTB60	2517	63.50	44.45	107.95	22.47	1.59
68	343.74	D10CTB68	2517	63.50	44.45	107.95	25.47	1.59
76	384.15	D10CTB76	2517	63.50	44.45	107.95	37.30	1.59
84	424.57	D10CTB84	2517	63.50	44.45	107.95	44.72	1.59
95	480.14	D10CTB95	2517	63.50	44.45	107.95	52.14	1.59
114	576.13	D10CTB114	2517	63.50	44.45	107.95	62.57	1.59

Metric Sprockets



0.625 INCH (15.88mm) PITCH TRIPLEX

ISO 10B-3
METRIC 50-3

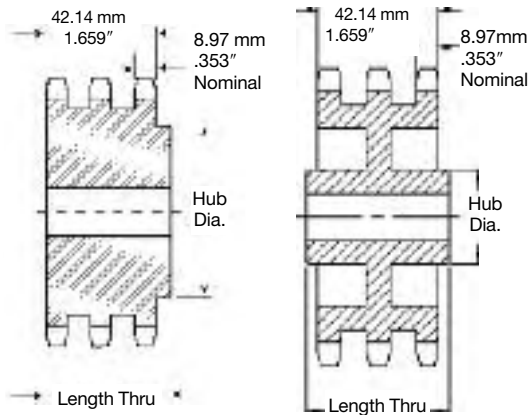

CHAIN DATA:
BS 228/11
ISO 10B-3
PITCH: 15.88mm (0.625 in.)
ROLLER DIAMETER: 10.16mm (0.400 in.)
ROLLER WIDTH: 9.65mm (0.380 in.)
TENSILE: 6810 kilos (10,000 lbs.)

TYPE B

TYPE C

SPROCKETS

Triplex-Type B — Steel

No. Teeth	Pitch Diameter MM	Catalog Number	Bore		Hub		Weight (Approx.) Kilos
			Stock MM	Max. MM	Dia. MM	Thru MM	
11	56.35	E10B11	16	24	37	55	0.68
12	61.34	E10B12	16	29	43	55	0.82
13	66.33	E10B13	16	34	48	55	1.05
14	71.34	E10B14	16	35	53	55	1.23
15	76.35	E10B15	16	38	58	55	1.36
16	81.37	E10B16	16	42	63	60	1.55
17	86.39	E10B17	16	45	68	60	1.81
18	91.42	E10B18	16	48	73	60	2.09
19	96.45	E10B19	16	52	79	60	2.40
20	101.48	E10B20	16	56	84	60	2.72
21	106.51	E10B21	20	56	85	60	3.04
22	111.55	E10B22	20	60	90	60	3.36
23	116.59	E10B23	20	62	95	60	3.67
24	121.62	E10B24	20	64	100	60	4.00
25	126.66	E10B25	20	68	105	60	4.31
26	131.70	E10B26	20	73	110	60	5.18
27	136.74	E10B27	20	73	110	60	5.63
28	141.79	E10B28	20	76	115	60	6.04
29	146.83	E10B29	20	76	115	60	6.22
30	151.87	E10B30	20	80	120	60	6.36
32	161.96	E10B32	20	80	120	60	7.26
35	177.10	E10B35	20	80	120	60	8.60
36	182.15	E10B36	25	80	120	60	9.34
38	192.24	E10B38	25	80	120	60	11.03
45	227.58	E10B45	30	80	120	75	14.94
48	242.73	E10B48	30	80	120	75	16.62
57	288.18	E10B57	32	80	120	75	21.77
60	303.33	E10B60	32	80	120	75	22.22
76	384.15	E10C76	32	80	120	89	23.13
80	404.36	E10C80	32	80	120	89	25.14
95	480.14	E10C95	32	80	120	95	32.66
114	576.13	E10C114	32	80	120	95	44.76

Maximum bores shown will accommodate standard keyseat and setscrew over keyseat. Slightly larger bores are possible with no keyseat, shallow keyseat, or setscrew at angle to keyseat.

ISO **12B-1**
METRIC **60**

0.750 INCH (19.05mm) PITCH **SIMPLEX**

CHAIN DATA:

BS 228/13
ISO 12B-1
PITCH: 19.05mm (0.750 in.)
ROLLER DIAMETER: 12.07mm (0.475 in.)
ROLLER WIDTH: 11.68mm (0.460 in.)
TENSILE: 2950 kilos (6500 lbs.)

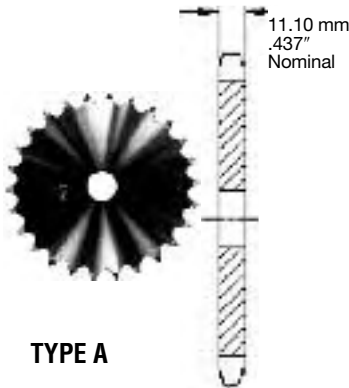

TYPE A

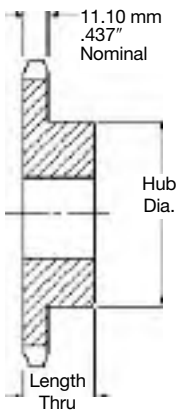

TYPE B

Simplex-Type B — Steel

Simplex-Type A — Steel

No. Teeth	Pitch Diameter MM	Catalog Number	Bore		Hub		Weight (Approx.) Kilos	Catalog Number	Bore Stock MM	Weight (Approx.) Kilos
			Stock MM	Max. MM	Dia. MM	Thru MM				
11	67.62	12B11	12	32	47	35	.53	12A11	14	.36
12	73.60	12B12	12	35	53	35	.67	12A12	14	.42
13	79.60	12B13	12	38	59	35	.75	12A13	14	.48
14	85.61	12B14	12	42	64	35	.91	12A14	14	.54
15	91.63	12B15	12	45	70	35	1.14	12A15	14	.60
16	97.65	12B16	16	50	75	35	1.27	12A16	14	.68
17	103.67	12B17	16	52	80	35	1.46	12A17	14	.77
18	109.71	12B18	16	52	80	35	1.69	12A18	14	.85
19	115.74	12B19	16	60	90	35	1.78	12A19	14	.95
20	121.78	12B20	16	64	90	35	2.10	12A20	14	1.08
21	127.82	12B21	20	64	100	40	2.27	12A21	16	1.15
22	133.86	12B22	20	64	100	40	2.38	12A22	16	1.24
23	139.90	12B23	20	67	100	40	2.49	12A23	16	1.33
24	145.95	12B24	20	67	100	40	2.62	12A24	19	1.47
25	151.99	12B25	20	67	100	40	2.78	12A25	19	1.63
26	158.04	12B26	20	67	100	40	2.89	12A26	19	1.72
27	164.09	12B27	20	67	100	40	3.05	12A27	19	1.91
28	170.14	12B28	20	67	100	40	3.12	12A28	19	1.99
29	176.19	12B29	20	67	100	40	3.30	12A29	19	2.44
30	182.25	12B30	20	67	100	40	3.44	12A30	19	2.28
31	188.30	12B31	20	67	100	40	3.50	12A31	19	2.49
32	194.35	12B32	20	67	100	40	3.75	12A32	19	2.62
33	200.41	12B33	20	67	100	40	3.82	12A33	19	2.77
34	206.46	12B34	20	67	100	40	3.99	12A34	19	2.91
35	212.52	12B35	20	67	100	40	4.10	12A35	19	3.19
36	218.57	12B36	20	67	100	40	4.35	12A36	19	3.21
37	224.63	12B37	20	67	100	40	4.64	12A37	19	3.52
38	230.69	12B38	25	70	107	40	4.92	12A38	24	3.67
39	236.74	12B39	25	70	107	40	5.15	12A39	24	3.87
40	242.80	12B40	25	70	107	40	5.22	12A40	24	4.00
41	248.86	12B41	25	70	107	40	5.51	12A41	24	4.24
42	254.92	12B42	25	70	107	40	5.78	12A42	24	4.53
43	260.98	12B43	25	70	107	40	5.90	12A43	24	4.58
44	267.03	12B44	25	70	107	40	6.30	12A44	25	4.99
45	273.09	12B45	25	70	107	40	6.34	12A45	25	5.14
46	279.15	12B46	25	70	107	40	6.62	12A46	25	5.33
47	285.21	12B47	25	70	107	40	6.80	12A47	25	5.70
48	291.27	12B48	25	70	107	40	7.18	12A48	25	5.75
50	303.39	12B50	25	70	107	40	8.01	12A50	25	6.45
54	327.63	12B54	32	70	110	45	9.80	12A54	32	7.33
57	345.81	12B57	32	70	110	45	10.10	12A57	32	8.11
60	363.99	12B60	32	70	110	45	11.44	12A60	32	9.19
65	394.30	12B65	32	70	110	45	13.12	12A65	32	10.65
70	424.61	12B70	32	70	110	45	14.51	12A70	32	12.45
72	436.73	12B72	32	80	120	50	15.50	12A72	32	13.22
76	460.98	12B76	32	80	120	50	17.26	12A76	32	14.78
80	485.23	12B80	32	80	120	50	19.00	12A80	32	20.75
84	509.48	12B84	32	80	120	50	21.07	12A84	32	21.78
95	576.17	12B95	32	92	140	55	23.83	12A95	32	23.46
96	582.23	12B96	32	92	140	55	26.61	12A96	32	23.71
114	691.36	12B114	32	92	140	55	33.98	12A114	32	28.16

Maximum bores shown will accommodate standard keyseat and setscrew over keyseat. Slightly larger bores are possible with no keyseat, shallow keyseat, or setscrew at angle to keyseat.

Metric Sprockets

0.750 INCH (19.05mm) PITCH **SIMPLEX**

ISO **12B-1**
METRIC **60**

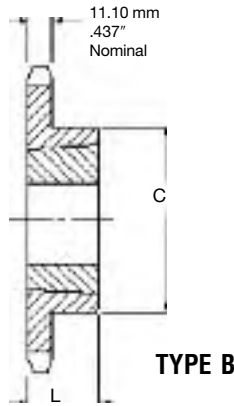

CHAIN DATA:

BS 228/13
ISO 12B-1
PITCH: 19.05mm (0.750 in.)
ROLLER DIAMETER: 12.07mm (0.475 in.)
ROLLER WIDTH: 11.68mm (0.460 in.)
TENSILE: 2950 kilos (6500 lbs.)

SPROCKETS

Simplex-Taper Bushed — Steel

No. Teeth	Pitch Diameter	Catalog Number	Bushing Number	Bore Max. MM	Dimension		Weight	
	MM				L MM	C MM	Rim Kilos	Bushing Kilos
11	67.62	12BTB11H	1008	25.40	22.23	46.04	0.27	0.14
12	73.61	12BTB12H	1008	25.40	22.23	49.21	0.36	0.14
13	79.60	12BTB13H	1210	31.75	25.40	62.69	0.41	0.27
14	85.61	12BTB14H	1210	31.75	25.40	62.69	0.45	0.27
15	91.63	12BTB15H	1610	41.28	25.40	70.64	0.54	0.41
16	97.65	12BTB16H	1610	41.28	25.40	76.20	0.73	0.41
17	103.67	12BTB17H	1610	41.28	25.40	82.55	0.82	0.41
18	109.70	12BTB18H	1610	41.28	25.40	82.55	0.91	0.41
19	115.74	12BTB19H	1610	41.28	25.40	82.55	1.00	0.41
20	121.78	12BTB20H	2012	50.80	31.75	90.47	1.00	0.77
21	127.82	12BTB21H	2012	50.80	31.75	90.47	1.18	0.77
22	133.86	12BTB22H	2012	50.80	31.75	90.47	1.27	0.77
23	139.90	12BTB23H	2012	50.80	31.75	90.47	1.27	0.77
24	145.95	12BTB24H	2012	50.80	31.75	90.47	1.50	0.77
25	151.99	12BTB25H	2012	50.80	31.75	90.47	1.74	0.77
26	158.04	12BTB26H	2012	50.80	31.75	90.47	1.74	0.77
27	164.09	12BTB27H	2012	50.80	31.75	90.47	1.80	0.77
28	170.14	12BTB28H	2012	50.80	31.75	90.47	2.04	0.77
30	182.25	12BTB30H	2012	50.80	31.75	90.47	2.32	0.77
32	194.35	12BTB32	2012	50.80	31.75	90.47	2.48	0.77
35	212.52	12BTB35	2012	50.80	31.75	90.47	2.71	0.77
36	218.57	12BTB36	2012	50.80	31.75	90.47	2.78	0.77
38	230.69	12BTB38	2012	50.80	31.75	90.47	3.36	0.77
40	242.80	12BTB40	2012	50.80	31.75	90.47	3.53	0.77
42	254.92	12BTB42	2012	50.80	31.75	90.47	3.71	0.77
45	273.09	12BTB45	2012	50.80	31.75	90.47	3.98	0.77
48	291.27	12BTB48	2012	50.80	31.75	90.47	4.24	0.77
54	327.63	12BTB54	2517	63.50	44.45	107.95	8.30	1.59
57	345.81	12BTB57	2517	63.50	44.45	107.95	8.76	1.59
60	363.99	12BTB60	2517	63.50	44.45	107.95	9.22	1.59
68	412.49	12BTB68	2517	63.50	44.45	107.95	10.45	1.59
70	424.61	12BTB70	2517	63.50	44.45	107.95	10.76	1.59
72	436.73	12BTB72	2517	63.50	44.45	107.95	11.06	1.59
76	460.98	12BTB76	2517	63.50	44.45	107.95	11.68	1.59
84	509.48	12BTB84	2517	63.50	44.45	107.95	12.91	1.59
95	576.17	12BTB95	2517	63.50	44.45	107.95	14.60	1.59
96	582.23	12BTB96	2517	63.50	44.45	107.95	14.75	1.59
114	691.36	12BTB114	2517	63.50	44.45	107.95	17.52	1.59

Sprockets with "H" suffix have hardened teeth.

0.750 INCH (19.05mm) PITCH DUPLEX

ISO 12B-2
METRIC 60-2

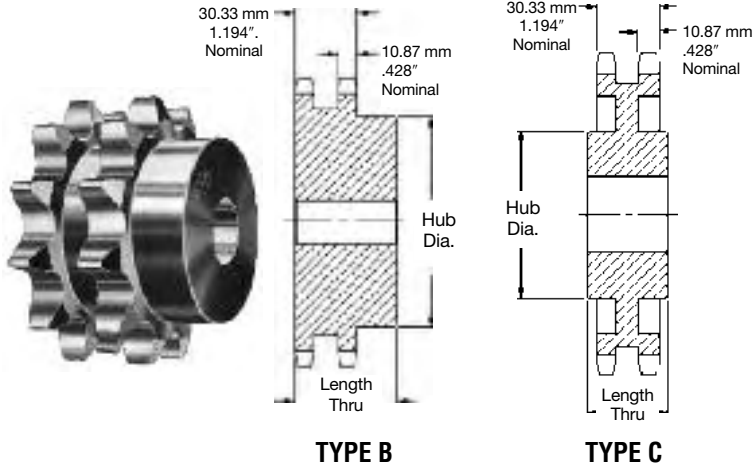

CHAIN DATA:

BS 228/13
ISO 12B-2
PITCH: 19.05mm (0.750 in.)
ROLLER DIAMETER: 12.07mm (0.475 in.)
ROLLER WIDTH: 11.68mm (0.460 in.)
TENSILE: 5900 kilos (13,000 lbs.)

Duplex-Type B/C — Steel

No. Teeth	Pitch Diameter MM	Catalog Number	Bore		Hub		Weight (Approx.) Kilos
			Stock	Max.	Dia.	Thru	
			MM	MM	MM	MM	
11	67.62	D12B11	16	32	47	50	1.00
12	73.60	D12B12	16	36	53	50	1.23
13	79.60	D12B13	16	38	59	50	1.41
14	85.61	D12B14	16	42	65	50	1.68
15	91.63	D12B15	16	45	71	50	1.95
16	97.65	D12B16	20	51	77	50	2.27
17	103.67	D12B17	20	54	83	50	2.63
18	109.70	D12B18	20	60	89	50	3.18
19	115.74	D12B19	20	62	95	50	3.50
20	121.78	D12B20	20	64	100	50	3.72
21	127.82	D12B21	20	64	100	50	4.31
22	133.86	D12B22	20	64	100	50	4.77
23	139.90	D12B23	20	73	110	50	4.99
24	145.95	D12B24	20	73	110	50	5.45
25	151.99	D12B25	20	80	120	50	5.67
26	158.04	D12B26	20	80	120	50	6.13
27	164.09	D12B27	20	80	120	50	6.49
28	170.14	D12B28	20	80	120	50	6.81
29	176.19	D12B29	20	80	120	50	7.13
30	182.25	D12B30	20	80	120	50	7.49
32	194.35	D12B32	20	85	130	50	9.31
35	212.52	D12B35	20	85	130	50	10.18
36	218.57	D12B36	25	85	130	50	12.31
38	230.69	D12B38	25	85	130	50	12.99
40	242.80	D12B40	25	85	130	50	13.67
45	273.09	D12B45	25	85	130	50	15.38
48	291.27	D12B48	25	85	130	50	16.41
57	345.81	D12B57	32	85	130	65	25.34
60	363.99	D12B60	32	85	130	65	26.67
68	412.49	D12C68	32	85	130	75	30.48
76	460.98	D12C76	40	85	130	75	25.63
80	485.23	D12C80	40	85	130	75	26.98
95	576.17	D12C95	40	93	140	85	39.24
96	582.23	D12C96	40	93	140	85	39.65
114	691.36	D12C114	40	93	140	85	41.86

Maximum bores shown will accommodate standard keyseat and setscrew over keyseat. Slightly larger bores are possible with no keyseat, shallow keyseat, or setscrew at angle to keyseat.

Metric Sprockets



ISO **12B-2**
METRIC **60-2**

0.750 INCH (19.05mm) PITCH **DUPLEX**

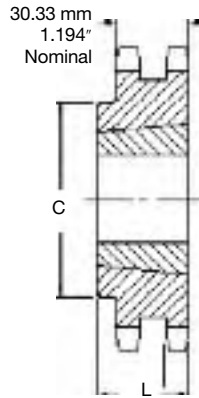

TYPE B

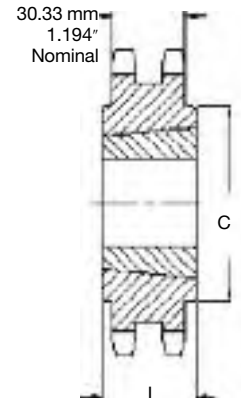

TYPE C

CHAIN DATA:

BS 228/13
ISO 12B-2
PITCH: 19.05mm (0.750 in.)
ROLLER DIAMETER: 12.07mm (0.475 in.)
ROLLER WIDTH: 11.68mm (0.460 in.)
TENSILE: 5900 kilos (13000 lbs.)

Duplex-Taper Bushed — Steel

No. Teeth	Pitch Diameter	Catalog Number	Bushing Number	Bore Max.	Dimension		Weight	
	MM				L	C	Rim	Bushing
				MM	MM	MM	Kilos	Kilos
12	73.60	D12BTB12	1215	31.75	38.10	53.54	.61	0.73
13	79.60	D12BTB13	1215	31.75	38.10	59.74	.66	0.77
14	85.61	D12BTB14	1215	31.75	38.10	65.91	.84	0.82
15	91.63	D12BTB15	1615	41.28	38.10	72.09	.70	0.77
16	97.65	D12BTB16	1615	41.28	38.10	76.20	1.11	0.77
17	103.67	D12BTB17	1615	41.28	38.10	82.93	1.25	0.77
18	109.70	D12BTB18	2012	50.80	31.75	90.50	1.56	0.77
19	115.74	D12BTB19	2012	50.80	31.75	96.6	1.81	0.77
20	121.78	D12BTB20	2517	63.50	44.45	102.00	2.04	1.59
21	127.82	D12BTB21	2517	63.50	44.45	107.95	2.50	1.59
22	133.86	D12BTB22	2517	63.50	44.45	107.95	2.78	1.59
23	139.90	D12BTB23	2517	63.50	44.45	107.95	3.07	1.59
24	145.95	D12BTB24	2517	63.50	44.45	107.95	3.35	1.59
25	151.99	D12BTB25	2517	63.50	44.45	107.95	3.63	1.59
26	158.04	D12BTB26	2517	63.50	44.45	107.95	3.91	1.59
27	164.09	D12BTB27	2517	63.50	44.45	107.95	4.20	1.59
28	170.14	D12BTB28	2517	63.50	44.45	107.95	4.48	1.59
30	182.25	D12BTB30	2517	63.50	44.45	107.95	5.04	1.59
32	194.35	D12BTB32	2517	63.50	44.45	107.95	5.61	1.59
35	212.52	D12BTB35	2517	63.50	44.45	107.95	6.46	1.59
38	230.69	D12CTB38	2517	63.50	44.45	107.95	8.40	1.59
40	242.80	D12CTB40	2517	63.50	44.45	107.95	9.56	1.59
42	254.92	D12CTB42	2517	63.50	44.45	107.95	10.73	1.59
45	273.09	D12CTB45	2517	63.50	44.45	107.95	12.48	1.59
48	291.27	D12CTB48	2517	63.50	44.45	107.95	14.23	1.59
54	327.63	D12CTB54	2517	63.50	44.45	107.95	17.73	1.59
57	345.81	D12CTB57	2517	63.50	44.45	107.95	19.48	1.59
60	363.99	D12CTB60	2517	63.50	44.45	107.95	21.23	1.59
65	394.30	D12CTB65	2517	63.50	44.45	107.95	24.15	1.59
70	424.61	D12CTB70	2517	63.50	44.45	107.95	27.06	1.59
75	454.92	D12CTB75	3020	76.20	50.80	133.35	19.27	2.95
76	460.98	D12CTB76	3020	76.20	50.80	133.35	19.52	2.95
84	509.48	D12CTB84	3020	76.20	50.80	133.35	21.58	2.95
95	576.17	D12CTB95	3020	76.20	50.80	133.35	24.40	2.95
96	582.23	D12CTB96	3020	76.20	50.80	133.35	24.66	2.95
114	691.36	D12CTB114	3020	76.20	50.80	133.35	29.28	2.95

ISO 12B-3
METRIC 60-3

0.750 INCH (19.05mm) PITCH TRIPLEX

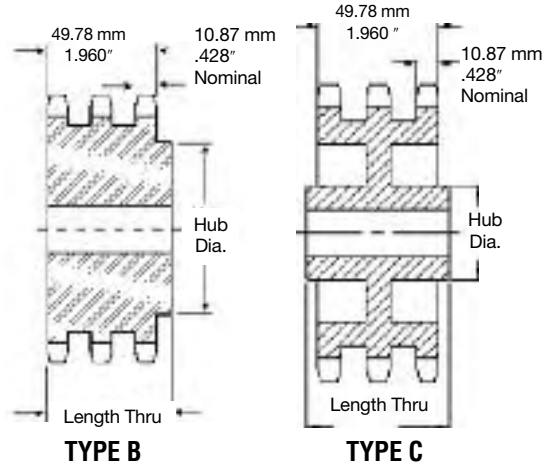

CHAIN DATA:

BS 228/13
ISO 12B-3
PITCH: 19.05mm (0.750 in.)
ROLLER DIAMETER: 12.07mm (0.475 in.)
ROLLER WIDTH: 11.68mm (0.460 in.)
TENSILE: 8850 kilos (19,500 lbs.)

Triples-Type B/C — Steel

No. Teeth	Pitch Diameter MM	Catalog Number	Bore		Hub		Weight (Approx.) Kilos
			Stock MM	Max. MM	Dia. MM	Thru MM	
11	67.62	E12B11	20	32	47	70	1.13
12	73.60	E12B12	20	36	53	70	1.50
13	79.60	E12B13	20	38	59	70	1.77
14	85.61	E12B14	20	42	65	70	2.04
15	91.63	E12B15	20	45	71	70	2.45
16	97.65	E12B16	20	51	77	70	2.95
17	103.67	E12B17	20	54	83	70	3.49
18	109.70	E12B18	20	60	89	70	3.86
19	115.74	E12B19	20	62	95	70	4.54
20	121.78	E12B20	20	64	100	70	5.08
21	127.82	E12B21	20	64	100	70	5.67
22	133.86	E12B22	20	64	100	70	5.99
23	139.90	E12B23	20	73	110	70	6.62
24	145.95	E12B24	20	73	110	70	7.17
25	151.99	E12B25	20	80	120	70	7.71
26	158.04	E12B26	20	80	120	70	8.44
27	164.09	E12B27	20	80	120	70	8.99
28	170.14	E12B28	20	80	120	70	9.49
29	176.19	E12B29	20	80	120	70	9.99
30	182.25	E12B30	20	80	120	70	10.53
35	212.52	E12B35	25	85	130	70	18.95
36	218.57	E12B36	25	85	130	70	19.49
38	230.69	E12B38	25	85	130	70	20.57
45	273.10	E12B45	25	85	130	70	24.36
48	291.27	E12B48	25	85	130	70	25.98
57	345.81	E12C57	32	82	130	85	33.73
60	363.99	E12C60	32	82	130	85	35.51
68	412.49	E12C68	32	82	130	85	40.24
76	460.98	E12C76	40	95	140	85	37.19
80	485.23	E12C80	40	95	140	85	39.15
95	576.17	E12C95	40	95	140	100	47.63

Maximum bores shown will accommodate standard keyseat and setscrew over keyseat. Slightly larger bores are possible with no keyseat, shallow keyseat, or setscrew at angle to keyseat.

Metric Sprockets



1.00 INCH (25.40mm) PITCH **SIMPLEX**

ISO **16B-1**
METRIC **80**

CHAIN DATA:

BS 228/15
ISO 16B-1
PITCH: 25.40mm (1.00 in.)
ROLLER DIAMETER: 15.88mm (0.625 in.)
ROLLER WIDTH: 17.02mm (0.670 in.)
TENSILE: 4310 kilos (9,500 lbs.)

Simplex-Type B/C — Steel

Simplex-Type A — Steel

No. Teeth	Pitch Diameter MM	Catalog Number	Bore		Hub		Weight (Approx.) Kilos	Catalog Number	Bore Stock MM	Weight (Approx.) Kilos
			Stock MM	Max. MM	Dia. MM	Thru MM				
11	90.16	16B11	16	41	63	40	1.45	16A11	14	0.82
12	98.14	16B12	16	47	72	40	1.82	16A12	14	0.91
13	106.14	16B13	16	52	79	40	1.82	16A13	14	1.04
14	114.15	16B14	16	60	88	40	2.09	16A14	14	1.22
15	122.17	16B15	16	62	96	40	2.59	16A15	14	1.36
16	130.20	16B16	20	67	100	45	3.00	16A16	14	1.54
17	138.23	16B17	25	67	102	45	3.18	16A17	14	1.81
18	146.27	16B18	25	70	108	45	3.77	16A18	24	2.00
19	154.32	16B19	25	70	108	45	3.86	16A19	24	2.13
20	162.37	16B20	25	70	108	45	4.09	16A20	24	2.49
21	170.42	16B21	25	70	108	50	4.54	16A21	24	2.63
22	178.48	16B22	25	70	108	50	4.99	16A22	24	2.82
23	186.56	16B23	25	70	108	50	5.08	16A23	24	3.04
24	194.60	16B24	25	70	108	50	5.54	16A24	24	3.45
25	202.66	16B25	25	70	108	50	5.76	16A25	24	3.63
26	210.72	16B26	32	80	120	50	7.03	16A26	30	3.90
27	218.79	16B27	32	80	120	50	7.53	16A27	30	4.31
28	226.86	16B28	32	80	120	50	7.58	16A28	30	4.58
29	234.93	16B29	32	80	120	50	7.94	16A29	30	4.81
30	243.00	16B30	32	80	120	50	8.26	16A30	32	5.22
31	251.07	16B31	32	80	120	50	8.62	16A31	32	5.56
32	259.14	16B32	32	80	120	50	8.98	16A32	32	5.90
33	267.21	16B33	32	80	120	50	9.33	16A33	32	6.24
34	275.28	16B34	32	80	120	50	9.69	16A34	32	6.58
35	283.36	16B35	32	80	120	50	10.05	16A35	32	6.92
36	291.43	16B36	32	80	120	50	10.41	16A36	32	7.26
37	299.51	16B37	32	80	120	50	10.76	16A37	32	7.60
38	307.58	16B38	32	80	120	50	11.12	16A38	32	7.94
39	315.66	16B39	32	80	120	50	11.48	16A39	32	8.48
40	323.74	16B40	32	80	120	50	11.83	16A40	32	9.01
41	331.81	16B41	32	80	120	50	12.19	16A41	32	9.55
42	339.89	16B42	32	80	120	50	12.55	16A42	32	10.09
43	347.97	16B43	32	80	120	50	12.91	16A43	32	10.62
44	356.05	16B44	32	80	120	50	13.27	16A44	32	11.16
45	364.12	16B45	32	80	120	50	13.62	16A45	32	11.70
46	372.20	16B46	32	80	120	50	13.98	16A46	32	12.23
47	380.28	16B47	32	80	120	50	14.34	16A47	32	12.77
48	388.36	16B48	32	80	120	50	14.70	16A48	32	12.31
49	396.44	16B49	32	80	120	50	15.05	16A49	32	13.85
50	404.52	16B50	32	80	120	50	15.41	16A50	32	14.38
54	436.84	16B54	32	85	130	50	20.99	16A54	32	16.53
57	461.08	16B57	32	85	130	50	22.16	16A57	32	18.14
60	485.33	16B60	32	85	130	50	23.33	16A60	32	19.75
65	525.73	16B65	32	85	130	50	25.27	16A65	32	22.43
70	566.15	16C70	40	108	159	90	33.59	16A70	40	25.47
72	582.31	16C72	40	108	159	90	35.48	16A72	40	27.94
76	614.64	16C76	40	108	159	90	39.24	16A76	40	32.89
80	646.97	16C80	40	108	159	90	43.00	16A80	40	37.84
84	679.30	16C84	40	108	159	90	46.77	16A84	40	42.78
90	727.80	16C90	40	108	159	90	52.41	16A90	40	50.21
95	768.22	16C95	40	108	159	90	57.12	16A95	40	56.39
96	766.31	16C96	40	108	159	90	58.06	16A96	40	57.63
114	921.81	16C114	40	108	159	90	75.00	16A114	40	76.36

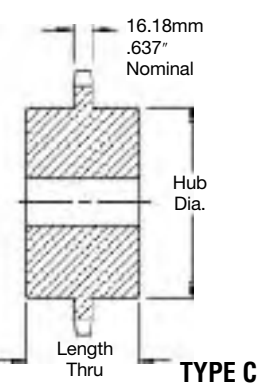
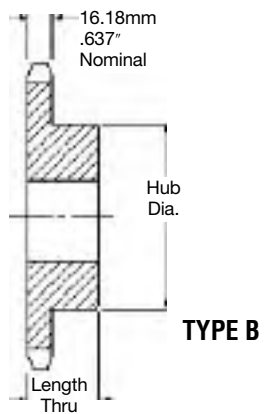

Maximum bores shown will accommodate standard keyseat and setscrew over keyseat. Slightly larger bores are possible with no keyseat, shallow keyseat, or setscrew at angle to keyseat.

SPROCKETS

ISO **16B-1**
METRIC **80**

1.00 INCH (25.40mm) PITCH SIMPLEX

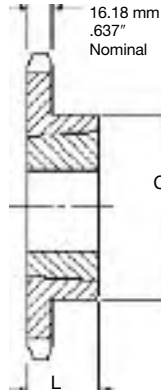

TYPE B

CHAIN DATA:

BS 228/15
ISO 16B-1
PITCH: 25.40mm (1.00 in.)
ROLLER DIAMETER: 15.88mm (0.625 in.)
ROLLER WIDTH: 17.02mm (0.670 in.)
TENSILE: 4310 KILOS (9,500 lbs.)

SPROCKETS

Simplex-Taper Bushed — Steel

No. Teeth	Pitch Diameter	Catalog Number	Bushing Number	Bore Max.	Dimension		Weight	
	MM			MM	L	C	Rim	Bushing
				MM	MM	MM	Kilos	Kilos
10	82.20	16BTB10H	1215	31.75	38.10	62.69	0.73	0.36
11	90.16	16BTB11H	1215	31.75	38.10	62.69	0.91	0.36
12	98.14	16BTB12H	1615	41.28	38.10	76.20	1.04	0.54
13	106.14	16BTB13H	1615	41.28	38.10	76.20	1.27	0.54
14	114.15	16BTB14H	1615	41.28	38.10	82.55	1.36	0.54
15	122.17	16BTB15H	1615	41.28	38.10	82.55	1.45	0.54
16	130.20	16BTB16H	2012	50.80	31.75	90.47	1.55	0.77
17	138.23	16BTB17H	2012	50.80	31.75	90.47	1.69	0.77
18	146.27	16BTB18H	2012	50.80	31.75	90.47	1.46	0.77
19	154.32	16BTB19H	2012	50.80	31.75	90.47	2.14	0.77
20	162.37	16BTB20H	2517	63.50	44.45	107.95	2.72	1.59
21	170.42	16BTB21H	2517	63.50	44.45	107.95	2.95	1.59
22	178.48	16BTB22H	2517	63.50	44.45	107.95	3.18	1.59
23	186.54	16BTB23H	2517	63.50	44.45	107.95	3.40	1.59
24	194.60	16BTB24H	2517	63.50	44.45	107.95	3.63	1.59
25	202.66	16BTB25H	2517	63.50	44.45	107.95	3.90	1.59
26	210.72	16BTB26H	2517	63.50	44.45	107.95	4.22	1.59
27	218.79	16BTB27H	2517	63.50	44.45	107.95	4.31	1.59
28	226.86	16BTB28H	2517	63.50	44.45	107.95	4.54	1.59
30	243.00	16BTB30H	2517	63.50	44.45	107.95	5.44	1.59
32	259.14	16BTB32	2517	63.50	44.45	107.95	5.67	1.59
35	283.36	16BTB35	2517	63.50	44.45	107.95	7.12	1.59
36	291.43	16BTB36	2517	63.50	44.45	107.95	7.94	1.59
38	307.58	16BTB38	2517	63.50	44.45	107.95	8.85	1.59
40	323.74	16BTB40	2517	63.50	44.45	107.95	9.75	1.59
45	364.12	16BTB45	2517	63.50	44.45	107.95	12.25	1.59
48	388.36	16BTB48	2517	63.50	44.45	107.95	13.61	1.59
54	436.84	16BTB54	2517	63.50	44.45	107.95	17.69	1.59
57	461.07	16BTB57	2517	63.50	44.45	107.95	19.16	1.59
60	485.33	16BTB60	2517	63.50	44.45	107.95	20.64	1.59
64	517.65	16BTB64	3020	76.20	50.80	133.35	19.35	2.95
70	566.15	16BTB70	3020	76.20	50.80	133.35	23.95	2.95
76	614.64	16BTB76	3020	76.20	50.80	133.35	28.55	2.95
80	646.97	16BTB80	3020	76.20	50.80	133.35	31.62	2.95
84	679.30	16BTB84	3020	76.20	50.80	133.35	34.68	2.95
95	768.22	16BTB95	3020	76.20	50.80	133.35	41.58	2.95
114	921.81	16BTB114	3020	76.20	50.80	133.35	56.15	2.95

Sprockets with "H" suffix have hardened teeth.

Metric Sprockets



ISO **16B-2**
METRIC **80-2**

1.00 INCH (25.40mm) PITCH DUPLEX

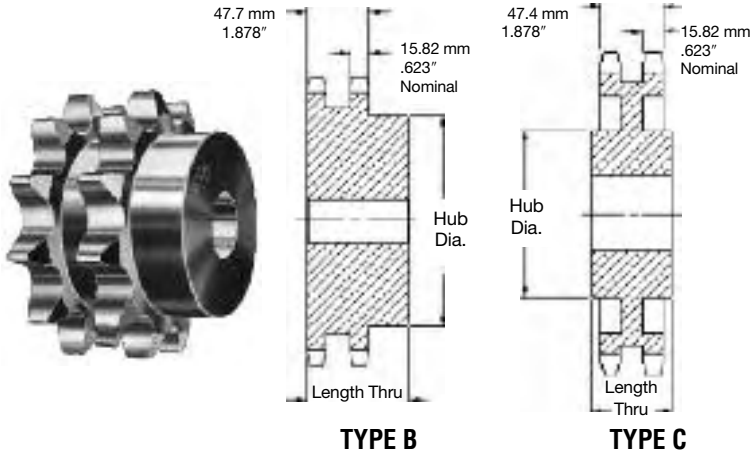

CHAIN DATA:

BS 228/15
ISO 16B-2
PITCH: 25.40mm (1.00 in.)
ROLLER DIAMETER: 15.88mm (0.625 in.)
ROLLER WIDTH: 17.02mm (0.670 in.)
TENSILE: 8620 kilos (19,000 lbs.)

SPROCKETS

Duplex-Type B/C — Steel

No. Teeth	Pitch Diameter MM	Catalog Number	Bore		Hub		Weight (Approx.) Kilos
			Stock	Max.	Dia.	Thru	
			MM	MM	MM	MM	
11	90.16	D16B11	20	42	63	70	1.82
12	98.14	D16B12	20	45	72	70	2.36
13	106.14	D16B13	20	52	80	70	2.95
14	114.15	D16B14	20	53	88	70	3.50
15	122.17	D16B15	20	62	96	70	4.18
16	130.20	D16B16	20	66	104	70	5.22
17	138.23	D16B17	20	74	112	70	5.99
18	146.27	D16B18	20	80	120	70	6.81
19	154.32	D16B19	20	84	128	70	7.71
20	162.37	D16B20	20	85	130	70	8.26
21	170.42	D16B21	25	85	130	70	8.85
22	178.28	D16B22	25	85	130	70	9.53
23	186.54	D16B23	25	85	130	70	10.43
24	194.60	D16B24	25	85	130	70	11.44
25	202.66	D16B25	25	85	130	70	12.47
26	210.72	D16B26	25	85	130	70	13.62
27	218.79	D16B27	25	85	130	70	14.75
28	226.86	D16B28	25	85	130	70	15.89
29	234.93	D16B29	25	85	130	70	17.02
30	243.00	D16B30	25	95	145	75	18.16
32	259.14	D16B32	32	95	145	75	19.86
35	283.36	D16B35	32	95	145	75	22.27
36	291.43	D16B36	32	95	145	80	28.04
38	307.58	D16B38	32	95	145	80	29.60
42	339.89	D16B42	40	95	145	80	32.20
45	364.12	D16C45	40	95	145	95	34.35
57	461.07	D16C57	40	95	145	95	38.18
60	485.33	D16C60	40	95	145	95	42.77
68	549.98	D16C68	40	96	153	102	43.86
76	614.64	D16C76	40	96	152	102	68.11
80	646.97	D16C80	40	102	152	108	54.88
95	768.22	D16C95	40	102	152	108	72.57
114	921.81	D16C114	40	102	152	108	78.22

Maximum bores shown will accommodate standard keyseat and setscrew over keyseat. Slightly larger bores are possible with no keyseat, shallow keyseat, or setscrew at angle to keyseat.

1.00 INCH (25.40mm) PITCH DUPLEX

ISO **16B-2**
METRIC **80-2**

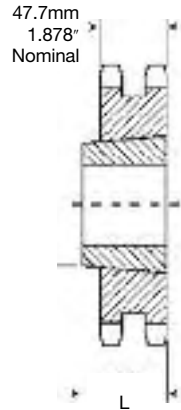

TYPE A

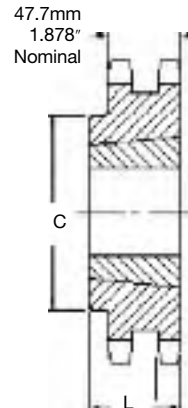

TYPE B

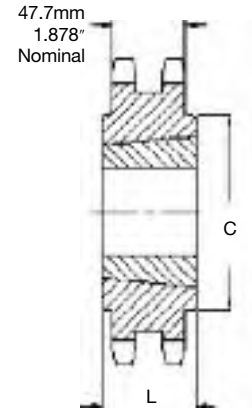

TYPE C

CHAIN DATA:

BS 228/15
ISO 16B-2
PITCH: 25.40mm (1.00 in.)
ROLLER DIAMETER: 15.88mm (0.625 in.)
ROLLER WIDTH: 17.02mm (0.670 in.)
TENSILE: 8620 kilos (19,000 lbs.)

Duplex-Taper Bushed — Steel

No. Teeth	Pitch Diameter	Catalog Number	Bushing Number	Bore Max.	Dimension		Weight	
	MM				L	C	Rim	Bushing
				MM	MM	MM	Kilos	Kilos
13	106.14	D16ATB13	1615	41.28	38.10		1.54	0.77
14	114.15	D16ATB14	2012	50.80	31.75		1.68	0.77
15	122.17	D16ATB15	2012	50.80	31.75		2.04	0.77
16	130.20	D16ATB16	2012	50.80	31.75		2.27	0.77
17	138.23	D16ATB17	2517	63.50	44.45		2.50	1.59
18	146.27	D16ATB18	2517	63.50	44.45		2.64	1.59
19	154.32	D16BTB19	3020	76.20	50.80	127.00	3.18	2.95
20	162.37	D16BTB20	3020	76.20	50.80	133.35	3.45	2.95
21	170.42	D16BTB21	3020	76.20	50.80	141.28	4.09	2.95
22	178.48	D16BTB22	3020	76.20	50.80	149.23	4.73	2.95
23	186.54	D16BTB23	3020	76.20	50.80	158.34	5.48	2.95
24	194.60	D16BTB24	3020	76.20	50.80	166.68	6.34	2.95
25	202.66	D16BTB25	3020	76.20	50.80	174.63	7.72	2.95
26	210.72	D16BTB26	3020	76.20	50.80	182.56	8.36	2.95
27	218.79	D16BTB27	3020	76.20	50.80	133.35	10.22	2.95
28	226.86	D16BTB28	3020	76.20	50.80	133.35	10.59	2.95
30	243.00	D16CTB30	3020	76.20	50.80	133.35	11.35	2.95
35	283.36	D16CTB35	3020	76.20	50.80	133.35	17.88	2.95
38	307.58	D16CTB38	3020	76.20	50.80	133.35	21.79	2.95
42	339.89	D16CTB42	3020	76.20	50.80	133.35	22.94	2.95
45	364.12	D16CTB45	3020	76.20	50.80	133.35	23.80	2.95
57	461.08	D16CTB57	3020	76.20	50.80	133.35	27.24	2.95
76	614.64	D16CTB76	3020	76.20	50.80	133.35	37.68	2.95
95	768.22	D16CTB95	3020	76.20	50.80	133.35	43.13	2.95
114	921.81	D16CTB114	3020	76.20	50.80	133.35	48.58	2.95

Maximum bores shown will accommodate standard keyseat and setscrew over keyseat. Slightly larger bores are possible with no keyseat, shallow keyseat, or setscrew at angle to keyseat.

Metric Sprockets



1.00 INCH (25.40mm) PITCH TRIPLEX

ISO 16B-3
METRIC 80-3

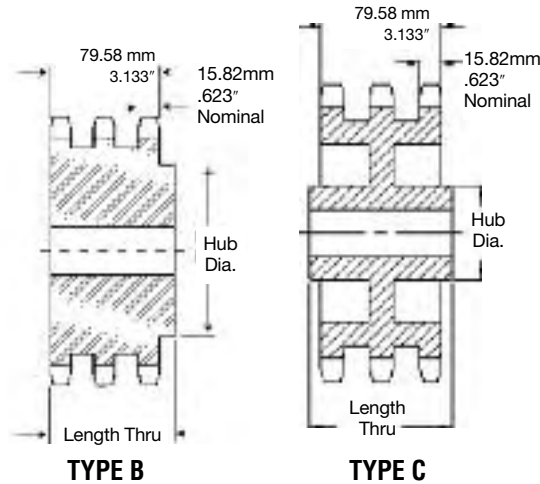

CHAIN DATA:
BS 228/15
ISO 16B-3
PITCH: 25.40mm (1.00 in.)
ROLLER DIAMETER: 15.88mm (0.625 in.)
ROLLER WIDTH: 17.02mm (0.670 in.)
TENSILE: 12,930 kilos (28,500 lbs.)

SPROCKETS

Triplex-Type B/C — Steel

No. Teeth	Pitch Diameter MM	Catalog Number	Bore		Hub		Weight (Approx.) Kilos
			Stock MM	Max. MM	Dia. MM	Thru MM	
11	90.16	E16B11	25	42	63	100	2.72
12	98.14	E16B12	25	45	72	100	3.59
13	106.14	E16B13	25	52	80	100	4.13
14	114.15	E16B14	25	58	88	100	4.68
15	122.17	E16B15	25	62	96	100	5.54
16	130.20	E16B16	30	66	104	100	6.81
17	138.23	E16B17	30	74	112	100	8.07
18	146.27	E16B18	30	80	120	100	9.99
19	154.32	E16B19	30	84	128	100	10.89
20	162.37	E16B20	30	85	130	100	11.80
21	170.42	E16B21	30	85	130	100	13.61
22	178.48	E16B22	30	85	130	100	14.07
23	186.54	E16B23	30	85	130	100	14.97
24	194.60	E16B24	30	85	130	100	16.34
25	202.66	E16B25	30	85	130	100	17.70
26	210.72	E16B26	30	85	130	100	19.98
27	218.79	E16B27	30	85	130	100	21.57
28	226.86	E16B28	30	85	130	100	23.15
29	234.93	E16B29	30	85	130	100	24.74
30	243.00	E16B30	32	95	140	105	26.33
35	283.36	E16B35	32	95	140	105	36.06
36	291.43	E16B36	32	95	140	105	38.06
38	307.58	E16C38	32	97	152	114	41.45
42	339.89	E16C42	40	97	152	114	38.51
45	364.12	E16C45	40	97	152	114	41.91
57	461.08	E16C57	40	107	159	120	51.35
60	485.33	E16C60	40	107	159	120	58.06
68	549.98	E16C68	40	107	159	120	63.50
76	614.64	E16C76	40	107	159	120	77.11
95	768.22	E16C95	40	114	171	127	100.70
114	921.81	E16C114	40	114	171	127	120.84

Maximum bores shown will accommodate standard keyseat and setscrew over keyseat. Slightly larger bores are possible with no keyseat, shallow keyseat, or setscrew at angle to keyseat.

ISO **20B-1**
METRIC **100**

1.25 INCH (31.75mm) PITCH **SIMPLEX**

CHAIN DATA:

BS 228/17
ISO 20B-1
PITCH: 31.75mm (1.250 in.)
ROLLER DIAMETER: 19.05mm (0.750 in.)
ROLLER WIDTH: 19.56mm (0.770 in.)
TENSILE: 6580 kilos (14,500 lbs.)

Simplex-Type A — Steel

Simplex-Type B/C — Steel

No. Teeth	Pitch Diameter MM	Catalog Number	Bore		Hub		Weight (Approx.) Kilos	Catalog Number	Bore Stock MM	Weight (Approx.) Kilos
			Stock MM	Max. MM	Dia. MM	Thru MM				
8	82.97	20B8	25	57	48	48	1.04	20A8	25	0.63
9	92.83	20B9	25	57	58	48	1.45	20A9	25	0.95
10	102.75	20B10	25	60	69	48	1.86	20A10	25	1.27
11	112.70	20B11	25	70	79	48	2.40	20A11	25	1.59
12	122.67	20B12	25	76	90	48	2.95	20A12	25	1.91
13	132.67	20B13	25	76	98	41	3.00	20A13	25	2.18
14	142.68	20B14	25	76	106	41	3.40	20A14	25	2.49
15	152.71	20B15	25	76	114	44	4.31	20A15	25	2.68
16	162.75	20B16	25	76	114	44	4.63	20A16	24	3.08
17	172.79	20B17	32	76	114	44	4.99	20A17	24	3.54
18	182.84	20B18	32	76	114	44	5.44	20A18	30	3.81
19	192.90	20B19	32	76	114	51	5.90	20A19	30	4.31
20	202.96	20B20	32	76	114	51	6.35	20A20	30	4.58
21	213.03	20B21	32	76	114	51	7.03	20A21	32	5.17
22	223.10	20B22	32	76	114	51	7.71	20A22	32	5.72
23	233.17	20B23	32	84	114	51	8.16	20A23	32	5.99
24	243.25	20B24	32	84	114	51	8.62	20A24	32	6.62
25	253.32	20B25	32	84	114	51	9.07	20A25	32	6.94
26	263.41	20B26	32	84	127	51	9.53	20A26	32	7.62
27	273.49	20B27	32	84	127	51	10.43	20A27	32	8.35
28	283.57	20B28	32	84	127	51	11.34	20A28	32	8.85
29	293.66	20B29	32	84	127	51	11.76	20A29	32	9.43
30	303.75	20B30	32	84	127	51	12.02	20A30	32	9.98
31	313.83	20B31	32	84	127	51	12.77	20A31	32	10.73
32	323.92	20B32	32	84	127	51	13.52	20A32	32	11.49
33	334.01	20B33	32	84	127	51	14.59	20A33	32	12.24
34	344.10	20B34	32	84	127	51	15.66	20A34	32	13.00
35	354.20	20B35	32	84	127	64	16.74	20A35	32	13.75
36	364.29	20B36	32	84	127	64	17.51	20A36	32	14.50
37	374.38	20B37	32	84	127	64	18.17	20A37	32	15.25
38	384.48	20B38	32	84	127	64	18.82	20A38	32	16.01
39	394.57	20B39	32	84	127	64	19.78	20A39	32	16.76
40	404.67	20B40	32	84	127	64	21.27	20A40	32	17.52
41	414.77	20B41	32	84	127	64	22.07	20A41	32	18.27
42	424.88	20B42	32	84	127	64	22.86	20A42	32	19.03
43	434.96	20B43	32	84	127	64	23.40	20A43	32	19.78
44	445.06	20B44	32	84	127	64	23.95	20A44	32	20.53
45	455.15	20B45	32	84	127	64	24.49	20A45	32	21.29
46	465.25	20B46	32	84	127	64	26.31	20A46	32	22.04
47	475.35	20B47	32	84	127	64	28.12	20A47	32	22.79
48	485.45	20B48	40	102	152	64	29.94	20A48	32	23.55
49	495.55	20B49	40	102	152	64	31.76	20A49	32	24.30
50	505.65	20B50	40	102	152	64	33.57	20A50	32	25.06
51	515.75	20B51	40	102	152	64	35.39	20A51	40	24.43
52	525.85	20B52	40	102	152	64	37.21	20A52	40	25.85
53	535.95	20B53	40	102	152	64	39.02	20A53	40	27.27
54	546.05	20C54	40	102	152	82	32.90	20A54	40	25.70
55	556.15	20C55	40	102	152	82	34.77	20A55	40	30.12
56	566.25	20C56	40	102	152	82	36.63	20A56	40	31.34
57	576.35	20C57	40	102	152	82	38.50	20A57	40	32.96
58	586.45	20C58	40	102	152	82	40.37	20A58	40	35.80
59	596.56	20C59	40	102	152	82	42.24	20A59	40	37.22
60	606.66	20C60	40	102	152	82	44.10	20A60	40	38.64
70	707.68	20C70	40	133	178	95	65.36	20A70	40	52.85
72	727.89	20C72	40	133	178	95	67.23	20A72	40	55.70
76	768.30	20C76	40	133	178	95	70.98	20A76	40	61.38
80	808.71	20C80	40	133	178	95	74.70	20A80	40	67.06
84	849.13	20C84	40	133	178	95	78.43	20A84	40	72.75
90	909.76	20C90	40	133	178	95	84.03	20A90	40	81.27
95	960.28	20C95	40	133	178	114	117.18	20A95	40	102.42
96	970.38	20C96	40	133	178	114	117.56	20A96	40	103.84
114	1152.27	20C114	40	133	178	114	124.40	20A114	40	130.84

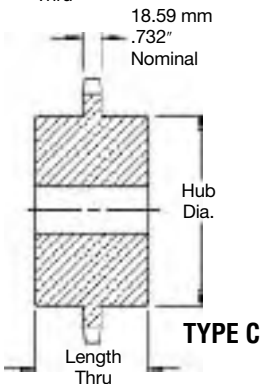
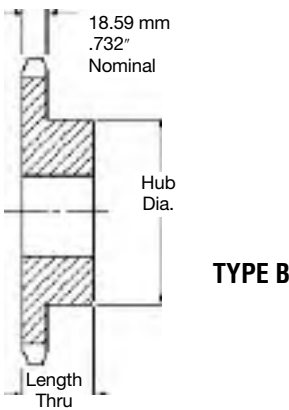

Maximum bores shown will accommodate standard keyseat and setscrew over keyseat. Slightly larger bores are possible with no keyseat, shallow keyseat, or setscrew at angle to keyseat.

SPROCKETS

Metric Sprockets

1.25 INCH (31.75mm) PITCH **SIMPLEX**

ISO **20B-1**
METRIC **100**

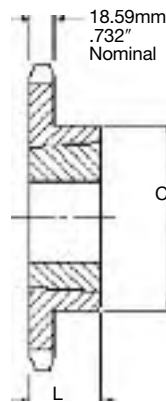

TYPE B

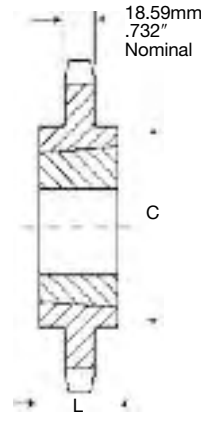

TYPE C

CHAIN DATA:

BS 228/17
ISO 20B1
PITCH: 31.75mm (1.250 in.)
ROLLER DIAMETER: 19.05mm (0.750 in.)
ROLLER WIDTH: 19.56mm (0.770 in.)
TENSILE: 6580 kilos (14,500 lbs.)

SPROCKETS

Simplex-Taper Bushed — Steel

No. Teeth	Pitch Diameter	Catalog Number	Bushing Number	Bore Max.	Dimension		Weight	
	MM				L	C	Rim Kilos	Bushing Kilos
11	112.70	20BTB11H	1615	41.28	38.10	62.69	1.22	0.54
12	122.67	20BTB12H	1615	41.28	38.10	70.64	1.41	0.54
13	132.67	20BTB13H	2012	50.80	31.75	90.47	1.45	0.77
14	142.68	20BTB14H	2012	50.80	31.75	90.47	1.63	0.77
15	152.71	20BTB15H	2517	63.50	44.45	107.95	2.31	1.59
16	162.75	20BTB16H	2517	63.50	44.45	107.95	2.72	1.59
17	172.79	20BTB17H	2517	63.50	44.45	107.95	3.27	1.59
18	182.84	20BTB18H	2517	63.50	44.45	107.95	3.63	1.59
19	192.90	20BTB19H	2517	63.50	44.45	107.95	4.09	1.59
20	202.96	20BTB20H	2517	63.50	44.45	107.95	4.40	1.59
21	213.03	20BTB21H	2517	63.50	44.45	107.95	4.54	1.59
22	223.10	20BTB22H	2517	63.50	44.45	107.95	4.77	1.59
23	233.17	20BTB23H	2517	63.50	44.45	107.95	5.58	1.59
24	243.25	20BTB24H	2517	63.50	44.45	107.95	6.13	1.59
25	253.32	20BTB25H	2517	63.50	44.45	107.95	6.95	1.59
26	263.41	20BTB26H	2517	63.50	44.45	107.95	7.35	1.59
28	283.57	20BTB28H	3020	76.20	50.80	133.35	7.90	2.95
30	303.75	20BTB30H	3020	76.20	50.80	133.35	9.62	2.95
32	323.92	20BTB32	3020	76.20	50.80	133.35	11.03	2.95
35	354.20	20BTB35	3020	76.20	50.80	133.35	13.15	2.95
36	364.29	20BTB36	3020	76.20	50.80	133.35	13.86	2.95
38	384.48	20BTB38	3020	76.20	50.80	133.35	15.98	2.95
40	404.67	20BTB40	3020	76.20	50.80	133.35	19.43	2.95
45	455.15	20BTB45	3020	76.20	50.80	133.35	25.18	2.95
48	485.45	20BTB48	3020	76.20	50.80	133.35	28.62	2.95
54	546.05	20BTB54	3020	76.20	50.80	133.35	35.52	2.95
57	576.35	20BTB57	3020	76.20	50.80	133.35	37.82	2.95
60	606.66	20BTB60	3020	76.20	50.80	133.35	41.27	2.95
70	707.68	20CTB70	3535	88.90	88.90	171.45	51.56	6.35
72	727.89	20CTB72	3535	88.90	88.90	171.45	53.97	6.35
76	768.30	20CTB76	3535	88.90	88.90	171.45	60.33	6.35
80	808.71	20CTB80	3535	88.90	88.90	171.45	66.23	6.35
84	849.13	20CTB84	3535	88.90	88.90	171.45	73.48	6.35
90	909.76	20CTB90	3535	88.90	88.90	171.45	94.33	6.35
95	960.28	20CTB95	3535	88.90	88.90	171.45	96.16	6.35

Sprockets with "H" suffix have hardened teeth.

ISO **20B-2**
METRIC **100-2**

1.25 INCH (31.75mm) PITCH **DUPLEX**

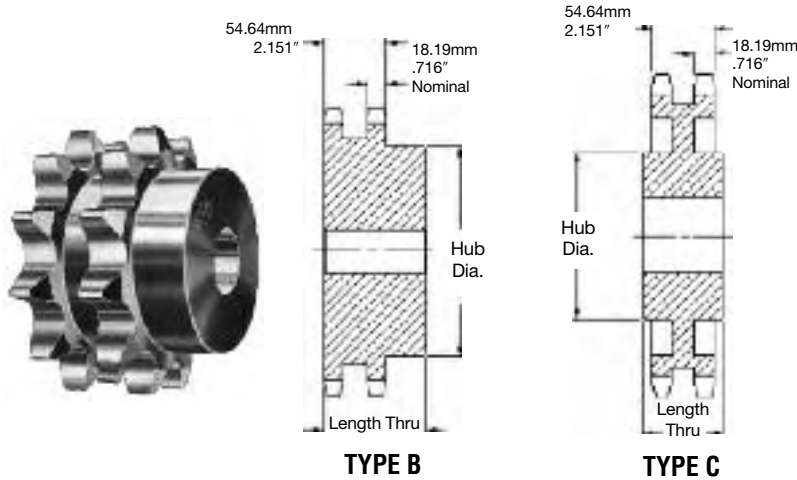

CHAIN DATA:

BS 228/17
ISO 20B-2
PITCH: 31.75mm (1.250 in.)
ROLLER DIAMETER: 19.05mm (0.750 in.)
ROLLER WIDTH: 19.56mm (0.770 in.)
TENSILE: 13,160 kilos (29,000 lbs.)

Duplex-Type B/C — Steel

No. Teeth	Pitch Diameter MM	Catalog Number	Bore		Hub		Weight (Approx.) Kilos
			Stock MM	Max. MM	Dia. MM	Thru MM	
10	102.75	D20B10	20	45	69	75	2.90
11	112.70	D20B11	20	52	79	80	3.67
12	122.67	D20B12	20	60	90	80	4.31
13	132.67	D20B13	20	64	100	80	5.53
14	142.68	D20B14	20	73	110	80	6.62
15	152.71	D20B15	20	80	120	80	7.76
16	162.75	D20B16	25	80	120	80	9.12
17	172.79	D20B17	25	80	120	80	10.44
18	182.84	D20B18	25	80	120	80	11.71
19	192.90	D20B19	25	80	120	80	12.92
20	202.96	D20B20	25	80	120	80	15.43
21	213.03	D20B21	25	92	140	80	16.55
22	223.10	D20B22	25	92	140	80	17.70
23	233.17	D20B23	25	92	140	80	19.05
24	243.25	D20B24	32	96	145	80	20.43
25	253.32	D20B25	32	96	145	80	21.77
26	263.41	D20B26	32	96	145	80	23.15
27	273.49	D20B27	32	96	145	80	24.97
28	283.57	D20B28	32	96	145	80	26.78
30	303.75	D20B30	32	96	145	80	30.41
32	323.92	D20B32	32	96	145	80	32.22
35	354.20	D20C35	32	100	152	108	34.02
36	364.29	D20C36	32	100	152	108	34.70
38	384.48	D20C38	32	100	152	114	43.72
42	424.86	D20C42	40	100	152	114	43.55
45	455.15	D20C45	40	100	152	114	46.72
57	576.35	D20C57	40	100	191	127	64.10
60	606.66	D20C60	40	125	191	127	79.38
68	687.48	D20C68	40	125	191	127	87.74
76	768.30	D20C76	40	125	191	127	96.11
80	808.71	D20C80	40	125	191	127	100.30
95	960.28	D20C95	40	125	191	127	115.98
114	1152.26	D20C114	40	125	191	127	135.85

Maximum bores shown will accommodate standard keyseat and setscrew over keyseat. Slightly larger bores are possible with no keyseat, shallow keyseat, or setscrew at angle to keyseat.

Metric Sprockets



1.25 INCH (31.75mm) PITCH TRIPLEX

ISO **20B-3**
METRIC **100-3**

CHAIN DATA:
BS 228/17
ISO 20B-3
PITCH: 31.75mm (1.250 in.)
ROLLER DIAMETER: 19.05mm (0.750 in.)
ROLLER WIDTH: 19.56mm (0.770 in.)
TENSILE: 19,740 kilos (43,500 lbs.)

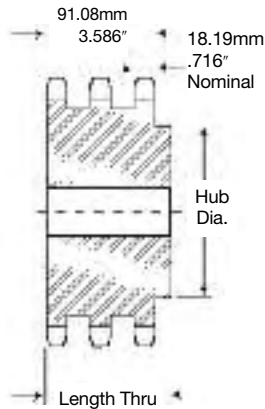

TYPE B

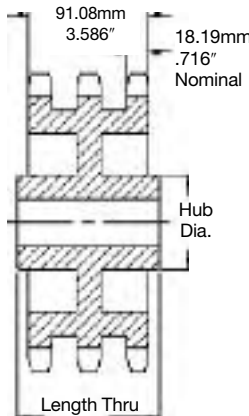

TYPE C

SPROCKETS

Triples-Type B/C — Steel

No. Teeth	Pitch Diameter MM	Catalog Number	Bore		Hub		Weight (Approx.) Kilos
			Stock	Max.	Dia.	Thru	
			MM	MM	MM	MM	
10	102.75	E20B10	25	47	69	110	3.95
11	112.70	E20B11	25	52	79	115	5.26
12	122.67	E20B12	25	60	90	115	6.21
13	132.67	E20B13	25	64	100	115	9.26
14	142.68	E20B14	25	73	110	115	9.76
15	152.71	E20B15	25	80	120	115	10.81
16	162.75	E20B16	25	80	120	115	12.76
17	172.79	E20B17	25	80	120	115	14.76
18	182.84	E20B18	25	80	120	115	16.71
19	192.90	E20B19	25	80	120	115	19.13
20	202.96	E20B20	25	80	120	115	21.57
21	213.03	E20B21	25	92	140	115	23.36
22	223.10	E20B22	25	92	140	115	25.65
23	233.17	E20B23	25	92	140	115	27.90
24	243.25	E20B24	32	95	145	120	27.19
25	253.32	E20B25	32	95	145	120	27.90
26	263.41	E20B26	32	95	145	120	31.90
27	273.49	E20B27	32	95	145	120	35.90
28	283.57	E20B28	32	95	145	120	39.90
30	303.75	E20B30	32	95	145	120	47.90
32	323.92	E20B32	32	95	145	127	51.57
35	354.20	E20C35	32	97	152	127	57.29
36	364.29	E20C36	32	97	152	127	59.35
38	384.48	E20C38	40	97	152	127	62.56
42	424.86	E20C42	40	97	152	127	70.12
45	455.15	E20C45	40	97	152	127	75.84
57	576.35	E20C57	40	102	191	127	100.11
60	606.66	E20C60	40	102	191	127	104.86
68	687.48	E20C68	40	102	191	127	117.54
76	768.30	E20C76	40	102	191	127	130.21
80	808.71	E20C80	40	102	191	127	136.55
95	960.28	E20C95	40	102	191	127	160.31
114	1152.27	E20C114	40	102	191	127	190.41

Maximum bores shown will accommodate standard keyseat and setscrew over keyseat. Slightly larger bores are possible with no keyseat, shallow keyseat, or setscrew at angle to keyseat.

ISO **24B-1**
METRIC **120**

1.50 INCH (38.10mm) PITCH SIMPLEX

CHAIN DATA:

BS 228/18
ISO 24B-1
PITCH: 38.10mm (1.50 in.)
ROLLER DIAMETER: 25.40mm (1.00 in.)
ROLLER WIDTH: 25.40mm (1.00 in.)
TENSILE: 9980 kilos (22,000 lbs.)

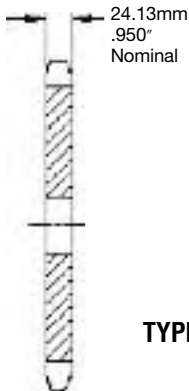

TYPE A

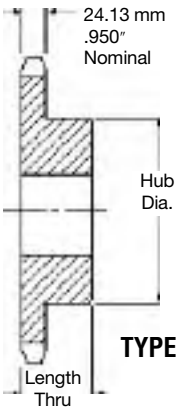

TYPE B

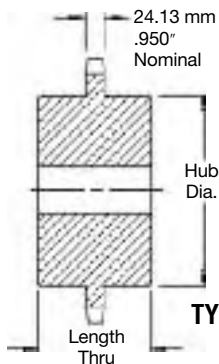

TYPE C

Simplex-Type B/C — Steel

Simplex-Type A — Steel

No. Teeth	Pitch Diameter MM	Catalog Number	Bore		Hub		Weight (Approx.) Kilos	Catalog Number	Bore Stock MM	Weight (Approx.) Kilos
			Stock MM	Max. MM	Dia. MM	Thru MM				
9	111.40	24B9	20	45	69	45	2.02	24A9	20	1.69
10	123.29	24B10	20	52	80	45	2.61	24A10	20	1.88
11	135.23	24B11	25	60	90	50	3.77	24A11	20	2.06
12	147.21	24B12	25	67	102	50	4.77	24A12	20	2.68
13	159.20	24B13	25	76	114	50	5.91	24A13	20	3.06
14	171.22	24B14	32	86	127	60	6.68	24A14	32	3.72
15	183.25	24B15	32	92	140	60	7.49	24A15	32	4.31
16	195.29	24B16	32	92	140	60	9.08	24A16	32	4.86
17	207.35	24B17	32	92	140	60	9.76	24A17	32	5.44
18	219.41	24B18	32	92	140	60	10.49	24A18	32	6.13
19	231.48	24B19	32	92	140	60	11.21	24A19	32	7.03
20	243.55	24B20	32	92	140	60	12.26	24A20	32	7.94
21	255.63	24B21	32	92	140	60	13.38	24A21	32	8.62
22	267.72	24B22	32	92	140	60	13.67	24A22	32	9.76
23	179.80	24B23	32	92	140	60	14.74	24A23	32	10.43
24	291.90	24B24	32	92	140	60	15.48	24A24	32	11.35
25	303.99	24B25	32	92	140	60	16.38	24A25	32	12.47
26	316.09	24B26	40	102	150	65	19.43	24A26	40	13.39
27	328.19	24B27	40	102	150	65	20.39	24A27	40	14.53
28	340.29	24B28	40	102	150	65	21.34	24A28	40	15.89
29	352.39	24B29	40	102	150	65	22.79	24A29	40	17.02
30	364.49	24B30	40	102	150	65	24.25	24A30	40	18.39
31	376.60	24B31	40	102	150	65	26.19	24A31	40	20.02
32	388.71	24B32	40	102	150	65	28.12	24A32	40	21.66
33	400.82	24B33	40	102	150	65	30.05	24A33	40	23.29
34	412.93	24B34	40	102	150	65	31.99	24A34	40	24.93
35	425.04	24B35	40	102	150	65	33.93	24A35	40	26.56
36	437.15	24B36	40	102	152	65	35.86	24A36	40	28.19
38	461.37	24B38	40	102	152	65	39.73	24A38	40	31.46
42	509.83	24C42	40	102	152	95	45.31	24A42	40	40.99
45	546.19	24C45	40	102	152	95	50.71	24A45	40	48.14
48	482.54	24C48	40	102	152	102	57.43	24A48	40	55.29
57	691.62	24C57	40	133	178	102	76.05	24A57	40	76.73
60	727.99	24C60	40	133	178	102	80.05	24A60	40	85.19
68	824.97	24C70	40	133	178	102	93.39	24A68	40	107.74
76	921.96	24C76	40	133	191	114	129.62	24A76	40	130.30

Maximum bores shown will accommodate standard keyseat and setscrew over keyseat. Slightly larger bores are possible with no keyseat, shallow keyseat, or setscrew at angle to keyseat.

Metric Sprockets

1.50 INCH (38.10mm) PITCH **SIMPLEX**

ISO **24B-1**
METRIC **120**

CHAIN DATA:

BS 228/18
ISO 24B-1
PITCH: 38.10mm (1.50 in.)
ROLLER DIAMETER: 25.40mm (1.00 in.)
ROLLER WIDTH: 25.40mm (1.00 in.)
TENSILE: 9980 kilos (22,000 lbs.)

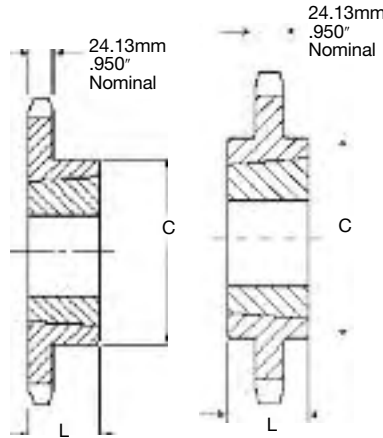

TYPE B

TYPE C

SPROCKETS

Simplex-Taper Bushed — Steel

No. Teeth	Pitch Diameter	Catalog Number	Bushing Number	Bore Max.	Dimension		Weight	
	MM				L	C	Rim	Bushing
				MM	MM	MM	Kilos	Kilos
11	135.23	24BTB11H	2012	50.80	31.75	90.49	2.28	0.77
12	147.21	24BTB12H	2012	50.80	31.75	90.49	2.49	0.77
13	159.20	24BTB13H	2517	63.50	44.45	107.95	2.77	1.59
14	171.22	24BTB14H	2517	63.50	44.45	107.95	3.54	1.59
15	183.25	24BTB15H	2517	63.50	44.45	107.95	4.31	1.59
16	195.29	24BTB16H	3020	76.20	50.80	133.35	4.77	2.95
17	207.35	24BTB17H	3020	76.20	50.80	133.35	5.45	2.95
18	219.41	24BTB18H	3020	76.20	50.80	133.35	6.13	2.95
19	231.48	24BTB19H	3020	76.20	50.80	133.35	6.81	2.95
20	243.55	24BTB20H	3020	76.20	50.80	133.35	7.49	2.95
21	255.63	24BTB21H	3020	76.20	50.80	133.35	7.94	2.95
22	267.72	24BTB22H	3020	76.20	50.80	133.35	8.75	2.95
23	279.80	24BTB23H	3020	76.20	50.80	133.35	9.53	2.95
24	291.90	24BTB24H	3020	76.20	50.80	133.35	10.67	2.95
25	303.99	24BTB25H	3020	76.20	50.80	133.35	11.80	2.95
26	316.09	24BTB26H	3020	76.20	50.80	133.35	12.93	2.95
27	328.19	24BTB27H	3020	76.20	50.80	133.35	13.50	2.95
28	340.29	24BTB28H	3020	76.20	50.80	133.35	14.70	2.95
29	352.29	24BTB29H	3020	76.20	50.80	133.35	14.75	2.95
30	364.49	24BTB30H	3020	76.20	50.80	133.35	15.20	2.95
32	388.71	24BTB32	3020	76.20	50.80	133.35	15.76	2.95
38	461.37	24CTB38	3030	76.20	76.20	139.70	24.97	4.18
40	485.60	24CTB40	3030	76.20	76.20	139.70	28.46	4.18
42	509.83	24CTB42	3030	76.20	76.20	139.70	31.95	4.18
45	546.19	24CTB45	3030	76.20	76.20	139.70	37.19	4.18
48	582.54	24CTB48	3030	76.20	76.20	139.70	42.43	4.18
50	606.78	24CTB50	3030	76.20	76.20	139.70	45.92	4.18
54	655.26	24CTB54	3535	88.90	88.90	165.10	63.32	6.36
57	691.62	24CTB57	3535	88.90	88.90	165.10	71.46	6.36
60	727.99	24CTB60	3535	88.90	88.90	165.10	79.60	6.36
68	824.97	24CTB68	3535	88.90	88.90	165.10	101.31	6.36
72	873.46	24CTB72	3535	88.90	88.90	165.10	112.17	6.36
76	921.96	24CTB76	3535	88.90	88.90	165.10	123.02	6.36
95	1152.33	24CTB95	4040	101.60	101.60	196.85	196.67	9.98
96	1164.46	24CTB96	4040	101.60	101.60	196.85	201.03	9.98
114	1382.72	24CTB114	4040	101.60	101.60	196.85	279.50	9.98

Sprockets with "H" suffix have hardened teeth.

ISO **24B-2**
METRIC **120-2**

1.50 INCH (38.10mm) PITCH **DUPLEX**

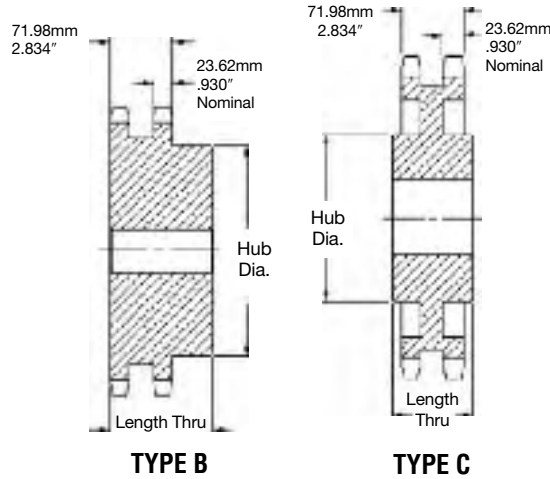

CHAIN DATA:

BS 228/18
ISO 24B-2
PITCH: 38.10mm (1.50 in.)
ROLLER DIAMETER: 25.40mm (1.00 in.)
ROLLER WIDTH: 25.40mm (1.00 in.)
TENSILE: 19,960 kilos (44,000 lbs.)

Duplex-Type B/C — Steel

No. Teeth	Pitch Diameter MM	Catalog Number	Bore		Hub		Weight (Approx.) Kilos
			Stock MM	Max. MM	Dia. MM	Thru MM	
11	135.23	D24B11	32	60	90	100	6.50
12	147.21	D24B12	32	67	102	100	8.13
13	159.20	D24B13	32	76	114	100	9.92
14	171.22	D24B14	32	84	128	100	11.98
15	183.25	D24B15	32	93	140	100	14.13
16	195.29	D24B16	32	100	150	100	16.35
17	207.35	D24B17	40	100	150	100	17.85
18	219.41	D24B18	40	108	160	100	20.35
19	231.48	D24B19	40	108	160	100	22.56
20	243.55	D24B20	40	108	160	100	24.78
21	255.63	D24B21	40	108	160	100	26.99
22	267.72	D24B22	40	108	160	102	29.74
23	279.80	D24B23	40	108	160	102	32.87
24	291.90	D24B24	40	108	160	102	36.00
25	303.99	D24B25	40	108	160	102	39.13
26	316.09	D24B26	40	108	160	102	42.26
27	328.19	D24B27	40	108	160	102	45.40
28	340.29	D24B28	40	108	160	102	48.53
29	352.39	D24B29	40	108	160	102	51.66
30	364.49	D24B30	40	108	160	102	54.79
32	388.71	D24B32	40	108	160	102	61.05
38	461.37	D24C38	40	137	190	152	72.01
40	485.60	D24C40	40	137	190	152	75.80
42	509.83	D24C42	40	137	190	152	79.59
45	546.19	D24C45	40	137	190	152	85.28
48	582.54	D24C48	40	137	190	152	90.97
50	606.78	D24C50	40	137	190	152	94.76
54	655.26	D24C54	40	161	238	159	127.46
57	691.62	D24C57	40	161	238	159	140.74
60	727.99	D24C60	40	161	238	159	154.02
68	824.97	D24C68	40	161	238	159	189.45
72	873.46	D24C72	40	161	238	159	207.16
76	921.96	D24C76	40	161	238	159	224.87
95	1152.33	D24C95	40	161	238	159	309.00
96	1164.46	D24C96	40	161	238	159	313.43
114	1382.72	D24C114	40	161	238	159	393.13

Maximum bores shown will accommodate standard keyseat and setscrew over keyseat. Slightly larger bores are possible with no keyseat, shallow keyseat, or setscrew at angle to keyseat.

Metric Sprockets

1.75 INCH (44.45mm) PITCH SIMPLEX

ISO 28B-1
METRIC 140

CHAIN DATA:

BS 228/20
ISO 28B-1
PITCH: 44.45mm (1.75 in.)
ROLLER DIAMETER: 27.94mm (1.10 in.)
ROLLER WIDTH: 30.99mm (1.22 in.)
TENSILE: 13,160 kilos (29,000 lbs.)

Simplex-Type B/C — Steel

Simplex-Type A — Steel

No. Teeth	Pitch Diameter MM	Catalog Number	Bore		Hub		Weight (Approx.) Kilos	Catalog Number	Bore Stock MM	Weight (Approx.) Kilos
			Stock MM	Max. MM	Dia. MM	Thru MM				
11	157.77	28B11	40	73	112	70	5.27	28A11	32	3.18
12	171.74	28B12	40	84	125	70	6.40	28A12	32	3.95
13	185.74	28B13	40	93	140	70	8.22	28A13	32	4.31
14	199.76	28B14	40	93	140	60	9.13	28A14	32	4.77
15	213.79	28B15	40	108	160	60	11.40	28A15	40	5.45
16	227.84	28B16	40	108	160	64	12.76	28A16	40	6.81
17	241.91	28B17	40	108	160	64	13.65	28A17	40	7.71
18	255.98	28B18	40	108	160	64	13.65	28A18	40	8.63
19	270.06	28B19	40	108	160	64	15.01	28A19	40	9.53
20	284.14	28B20	40	108	160	64	16.84	28A20	40	10.44
21	298.24	28B21	40	108	160	64	18.19	28A21	40	11.79
22	312.34	28B22	40	108	160	64	19.11	28A22	40	13.17
23	326.44	28B23	40	108	160	64	20.46	28A23	40	14.06
24	340.54	28B24	40	108	160	64	21.84	28A24	40	15.44
25	354.65	28B25	40	108	160	64	22.73	28A25	40	16.78
26	368.77	28B26	40	108	160	64	26.83	28A26	40	18.61
27	382.88	28B27	40	108	160	64	27.74	28A27	40	20.43
28	397.00	28B28	40	108	160	64	30.29	28A28	40	20.88
29	411.12	28B29	40	108	160	64	31.74	28A29	40	23.06
30	425.24	28B30	40	108	160	64	32.73	28A30	40	25.17
32	453.49	28B32	40	134	180	76	34.84	28A32	40	31.02
38	538.27	28C38	40	134	178	102	51.25	28A38	40	48.58
40	566.54	28C40	40	134	178	102	52.84	28A40	40	52.80
42	594.81	28C42	40	134	178	102	54.43	28A42	40	57.02
45	637.22	28C45	40	134	178	102	60.55	28A45	40	63.35
48	679.63	28C48	40	134	178	102	62.72	28A48	40	69.68
54	764.47	28C54	40	134	178	127	74.60	28A54	40	82.34
57	806.89	28C57	40	134	178	127	81.77	28A57	40	88.67
60	849.32	28C60	40	134	178	127	88.94	28A60	40	97.97
68	962.47	28C68	40	137	191	127	108.05	28A68	40	122.79
72	1019.04	28C72	40	137	191	127	117.61	28A72	40	135.19
76	1075.62	28C76	40	137	191	127	127.17	28A76	40	147.60
95	1344.39	28C95	40	137	191	127	172.57	28A95	40	206.53
96	1358.53	28C96	40	137	191	127	174.96	28A96	40	209.63
114	1613.18	28C114	40	137	191	127	217.97	28A114	40	265.46



29.44mm
1.159"
Nominal

TYPE A



29.44mm
1.159"
Nominal

TYPE B

Length Thru

29.44mm
1.159"
Nominal

Hub Dia.

TYPE C

Length Thru

Maximum bores shown will accommodate standard keyseat and setscrew over keyseat. Slightly larger bores are possible with no keyseat, shallow keyseat, or setscrew at angle to keyseat.

SPROCKETS

ISO **28B-1**
METRIC **140**

1.75 INCH (44.45mm) PITCH SIMPLEX

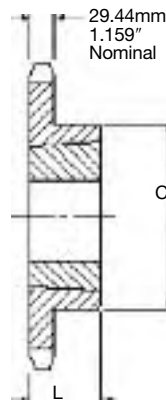

TYPE B

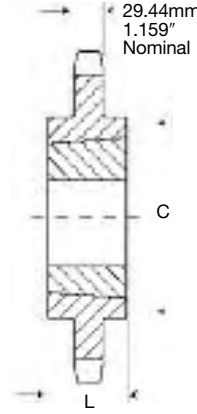

TYPE C

CHAIN DATA:

BS 228/20
ISO 28B-1
PITCH: 44.45mm (1.75 in.)
ROLLER DIAMETER: 27.94mm (1.10 in.)
ROLLER WIDTH: 30.99mm (1.22 in.)
TENSILE: 13,160 kilos (29,000 lbs.)

Simplex-Taper Bushed — Steel

No. Teeth	Pitch Diameter	Catalog Number	Bushing Number	Bore Max.	Dimension		Weight	
	MM			MM	L	C	Rim	Bushing
				MM	MM	MM	Kilos	Kilos
11	157.80	28BTB11H	2517	63.50	44.45	107.95	3.53	1.59
12	170.80	28BTB12H	2517	63.50	44.45	107.95	3.86	1.59
13	185.80	28BTB13H	3020	76.20	50.80	133.35	5.90	2.95
14	199.80	28BTB14H	3020	76.20	50.80	133.35	7.04	2.95
15	213.80	28BTB15H	3020	76.20	50.80	133.35	8.17	2.95
16	227.90	28BTB16H	3020	76.20	50.80	133.35	9.76	2.95
17	241.90	28BTB17H	3020	76.20	50.80	133.35	11.35	2.95
18	256.00	28BTB18H	3020	76.20	50.80	133.35	12.49	2.95
19	270.10	28BTB19H	3020	76.20	50.80	133.35	13.62	2.95
20	284.10	28BTB20H	3020	76.20	50.80	133.35	14.3	2.95
21	298.30	28BTB21H	3020	76.20	50.80	133.35	14.98	2.95
22	312.30	28BTB22H	3020	76.20	50.80	133.35	16.91	2.95
23	326.40	28BTB23H	3020	76.20	50.80	133.35	18.84	2.95
24	340.50	28BTB24H	3020	76.20	50.80	133.35	20.77	2.95
25	354.70	28BTB25H	3020	76.20	50.80	133.35	22.70	2.95
26	368.80	28BTB26H	3020	76.20	50.80	133.35	24.63	2.95
27	382.90	28BTB27	3020	76.20	50.80	133.35	26.56	2.95
28	397.00	28BTB28	3020	76.20	50.80	133.35	28.49	2.95
30	425.20	28BTB30	3020	76.20	50.80	133.35	32.35	2.95
32	453.49	28BTB32	3020	76.20	50.80	133.35	36.21	2.95
38	538.30	28CTB38	3535	88.90	88.90	165.10	45.40	6.36
40	566.55	28CTB40	3535	88.90	88.90	165.10	47.79	6.36
42	594.82	28CTB42	3535	88.90	88.90	165.10	50.18	6.36
45	637.21	28CTB45	4040	101.60	101.60	219.08	57.35	9.99
48	679.63	28CTB48	4040	101.60	101.60	219.08	61.17	9.99
54	764.46	28CTB54	4040	101.60	101.60	219.08	68.82	9.99
57	806.90	28CTB57	4040	101.60	101.60	219.08	72.64	9.99
60	849.33	28CTB60	4040	101.60	101.60	219.08	76.44	9.99
68	962.46	28CTB68	4040	101.60	101.60	219.08	86.63	9.99
72	1019.05	28CTB72	4040	101.60	101.60	219.08	91.73	9.99
76	1075.60	28CTB76	4040	101.60	101.60	219.08	96.83	9.99
95	1344.37	28CTB95	4040	101.60	101.60	219.08	121.03	9.99
96	1358.52	28CTB96	4040	101.60	101.60	219.08	122.31	9.99
114	1613.18	28CTB114	4040	101.60	101.60	219.08	145.24	9.99

Metric Sprockets



1.75 INCH (44.45mm) PITCH DUPLEX

ISO **28B-2**
METRIC **140-2**

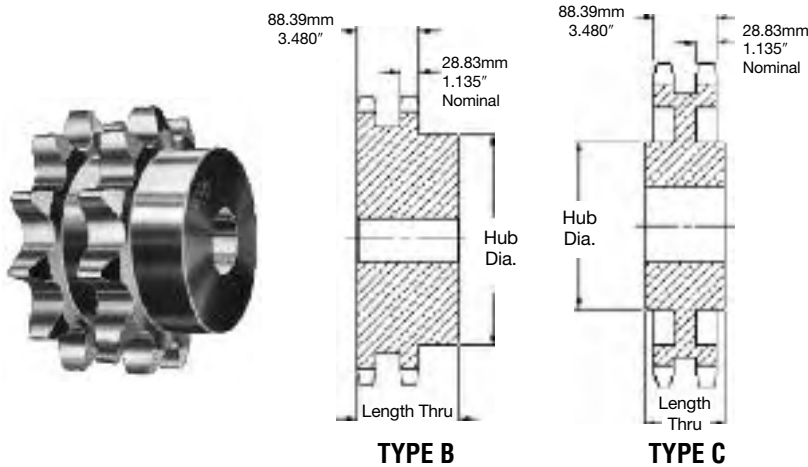

CHAIN DATA:
BS 228/20
ISO 28B-2
PITCH: 44.45mm (1.75 in.)
ROLLER DIAMETER: 27.94mm (1.10 in.)
ROLLER WIDTH: 30.99mm (1.22 in.)
TENSILE: 26,320 kilos (58,000 lbs.)

SPROCKETS

Duplex-Type B/C — Steel

No. Teeth	Pitch Diameter MM	Catalog Number	Bore		Hub		Weight (Approx.) Kilos
			Stock	Max.	Dia.	Thru	
			MM	MM	MM	MM	
11	157.77	D28B11	40	73	112	120	10.21
12	171.74	D28B12	40	84	125	120	13.02
13	185.74	D28B13	40	84	130	120	16.00
14	199.76	D28B14	40	87	135	120	19.28
15	213.79	D28B15	40	96	145	120	22.91
16	227.84	D28B16	40	108	160	120	26.92
17	241.91	D28B17	40	114	178	120	30.83
18	255.98	D28B18	40	114	178	120	34.74
19	270.06	D28B19	40	133	178	120	38.93
20	284.14	D28B20	40	133	178	120	44.27
21	298.24	D28B21	40	133	178	120	45.08
22	312.34	D28B22	40	133	178	120	48.15
23	326.44	D28B23	40	133	178	120	51.59
24	340.54	D28B24	40	133	178	120	55.03
25	354.65	D28B25	40	133	178	120	58.47
26	368.77	D28B26	40	133	178	120	64.06
28	397.00	D28B28	40	133	178	120	76.05
30	425.24	D28B30	40	133	178	120	89.16
32	453.49	D28B32	40	133	178	120	103.38
38	537.27	D28C38	40	133	191	159	97.53
40	566.54	D28C40	40	137	191	159	109.47
45	637.22	D28C45	40	137	191	159	137.32
48	679.63	D28C48	40	137	191	159	153.61
54	764.47	D28C54	40	162	241	181	204.44
57	806.89	D28C57	40	162	241	181	210.02
60	849.32	D28C60	40	162	241	181	230.82
68	962.47	D28C68	40	162	241	181	273.98
72	1019.04	D28C72	40	162	241	181	305.70
76	1075.62	D28C76	40	162	241	181	323.56

Maximum bores shown will accommodate standard keyseat and setscrew over keyseat. Slightly larger bores are possible with no keyseat, shallow keyseat, or setscrew at angle to keyseat.

ISO METRIC **32B-1**
160

2.00 INCH (50.80mm) PITCH SIMPLEX

CHAIN DATA:
BS 228/22
ISO 32B-1
PITCH: 50.80mm(2.00 in.)
ROLLER DIAMETER: 29.21mm (1.15 in.)
ROLLER WIDTH: 30.99mm (1.22 in.)
TENSILE: 17,240 kilos (38,000 lbs.)

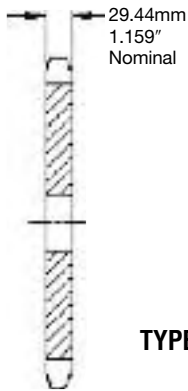

TYPE A

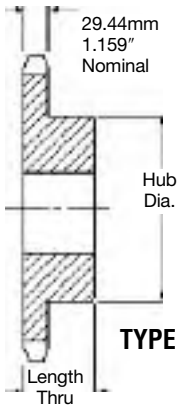

TYPE B

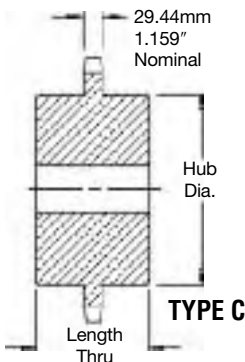

TYPE C

Simplex-Type B/C — Steel

No. Teeth	Pitch Diameter MM	Catalog Number	Bore		Hub		Weight (Approx.) Kilos	Catalog Number	Bore Stock MM	Weight (Approx.) Kilos
			Stock MM	Max. MM	Dia. MM	Thru MM				
11	180.31	32B11	40	83	120	80	9.04	32A11	32	5.00
12	196.28	32B12	40	89	133	80	11.11	32A12	32	6.02
13	212.27	32B13	40	102	152	70	12.61	32A13	32	7.12
14	228.29	32B14	40	102	152	70	14.97	32A14	32	8.32
15	244.33	32B15	40	102	178	70	17.32	32A15	40	9.50
16	260.39	32B16	40	103	178	70	18.78	32A16	40	11.64
17	276.46	32B17	40	103	178	70	20.23	32A17	40	12.35
18	292.55	32B18	40	103	178	70	21.88	32A18	40	13.96
19	308.64	32B19	40	103	178	70	23.53	32A19	40	15.57
20	324.74	32B20	40	133	178	70	25.37	32A20	40	17.36
21	340.84	32B21	40	133	178	70	27.20	32A21	40	19.15
22	356.96	32B22	40	133	178	70	29.23	32A22	40	21.13
23	373.07	32B23	40	133	178	70	31.25	32A23	40	23.10
24	389.19	32B24	40	133	178	76	35.33	32A24	40	25.26
25	405.32	32B25	40	133	178	76	36.80	32A25	40	27.41
26	421.45	32B26	40	133	181	76	39.41	32A26	40	30.25
27	437.58	32B27	40	133	181	76	42.02	32A27	40	33.10
28	453.72	32B28	40	133	181	76	44.62	32A28	40	35.94
29	469.85	32B29	40	133	181	76	47.23	32A29	40	38.78
30	485.99	32B30	40	133	181	76	49.84	32A30	40	41.63
32	518.28	32B32	40	139	203	76	58.02	32A32	40	47.31
38	615.17	32B38	40	139	203	114	86.78	32A38	40	64.37
40	647.47	32C40	40	139	203	114	91.35	32A40	40	72.98
42	679.78	32C42	40	139	203	114	95.91	32A42	40	81.60
45	728.25	32C45	40	139	203	127	116.97	32A45	40	94.52
48	776.72	32C48	40	139	203	127	130.43	32A48	40	107.44
54	873.68	32C54	40	139	203	127	157.34	32A54	40	133.29
57	922.16	32C57	40	139	203	127	170.79	32A57	40	146.21
60	970.65	32C60	40	139	203	127	184.25	32A60	40	164.35
68	1099.96	32C68	40	139	203	127	220.13	32A68	40	212.73
72	1164.62	32C72	40	139	203	152	282.31	32A72	40	236.91
76	1229.28	32C76	40	139	203	152	297.99	32A76	40	261.10

Maximum bores shown will accommodate standard keyseat and setscrew over keyseat. Slightly larger bores are possible with no keyseat, shallow keyseat, or setscrew at angle to keyseat.

Metric Sprockets



2.00 INCH (50.80mm) PITCH **SIMPLEX**

ISO **32B-1**
METRIC **160**

CHAIN DATA:

BS 228/22
ISO 32B-1
PITCH: 50.80mm (2.00 in.)
ROLLER DIAMETER: 29.21mm (1.15 in.)
ROLLER WIDTH: 30.99mm (1.22 in.)
TENSILE: 17,240 kilos (38,000 lbs.)

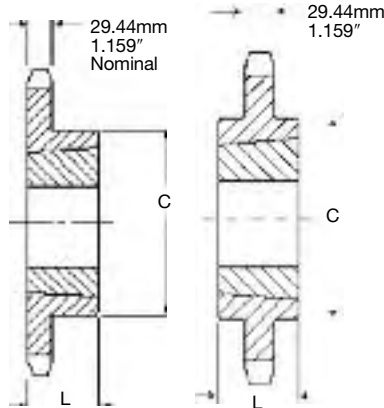

TYPE B

TYPE C

Simplex-Taper Bushed — Steel

No. Teeth	Pitch Diameter MM	Catalog Number	Bushing Number	Bore Max. MM	Dimension		Weight	
					L MM	C MM	Rim Kilos	Bushing Kilos
11	180.31	32BTB11H	2517	63.50	44.45	107.95	4.51	1.59
12	196.28	32BTB12H	3020	76.20	50.80	133.35	5.27	2.95
13	212.27	32BTB13H	3020	76.20	50.80	133.35	6.38	2.95
14	228.29	32BTB14H	3020	76.20	50.80	133.35	6.87	2.95
15	244.33	32BTB15H	3535	88.90	88.90	165.10	11.80	6.36
16	260.39	32BTB16H	3535	88.90	88.90	165.10	13.38	6.36
17	276.46	32BTB17H	3535	88.90	88.90	165.10	14.98	6.36
18	292.55	32BTB18H	3535	88.90	88.90	165.10	16.12	6.36
19	308.64	32BTB19H	3535	88.90	88.90	165.10	17.25	6.36
20	324.74	32BTB20H	3535	88.90	88.90	165.10	21.10	6.36
21	340.84	32BTB21H	3535	88.90	88.90	165.10	24.94	6.36
22	356.96	32BTB22H	3535	88.90	88.90	165.10	27.79	6.36
23	373.07	32BTB23H	3535	88.90	88.90	165.10	30.64	6.36
24	389.19	32BTB24H	3535	88.90	88.90	165.10	33.48	6.36
25	405.32	32BTB25H	3535	88.90	88.90	165.10	36.32	6.36
26	421.45	32BTB26H	3535	88.90	88.90	165.10	39.16	6.36
27	437.58	32BTB27	3535	88.90	88.90	165.10	42.00	6.36
28	453.72	32BTB28	3535	88.90	88.90	165.10	44.84	6.36
30	486.99	32BTB30	3535	88.90	88.90	165.10	50.52	6.36
32	518.28	32BTB32	3535	88.90	88.90	165.10	56.20	6.36
38	615.17	32CTB38	4040	101.60	101.60	219.08	68.10	10.00
40	647.47	32CTB40	4040	101.60	101.60	219.08	77.08	10.00
45	728.25	32CTB45	4040	101.60	101.60	219.08	99.53	10.00
48	776.72	32CTB48	4040	101.60	101.60	219.08	113.01	10.00
54	873.68	32CTB54	4040	101.60	114.30	219.08	139.95	10.00
57	922.16	32CTB57	4545	114.30	114.30	247.65	136.20	13.62
60	970.65	32CTB60	4545	114.30	114.30	247.65	158.84	13.62
64	1035.30	32CTB64	4545	114.30	114.30	247.65	189.03	13.62
70	1132.29	32CTB70	4545	114.30	114.30	247.65	234.32	13.62

SPROCKETS

ISO **32B-2**
METRIC **160-2**

2.00 INCH (50.80mm) PITCH **DUPLEX**

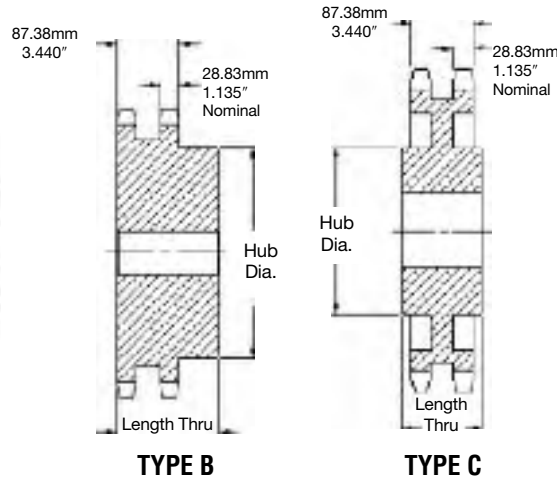

CHAIN DATA:

BS 228/22
ISO 32B-2
PITCH: 50.80mm (2.00 in.)
ROLLER DIAMETER: 29.21mm (1.15 in.)
ROLLER WIDTH: 30.99mm (1.22 in.)
TENSILE: 34,480 kilos (76,000 lbs.)

Duplex-Type B/C — Steel

No. Teeth	Pitch Diameter MM	Catalog Number	Bore		Hub		Weight (Approx.) Kilos
			Stock MM	Max. MM	Dia. MM	Thru MM	
11	180.31	D32B11	40	80	125	120	10.42
12	196.28	D32B12	40	89	133	120	16.32
13	212.27	D32B13	40	96	145	120	21.77
14	228.29	D32B14	40	103	155	120	26.31
15	244.33	D32B15	40	106	160	120	30.84
16	260.39	D32B16	40	120	178	120	34.02
17	276.46	D32B17	40	120	178	120	41.28
18	292.55	D32B18	40	120	178	120	43.55
19	308.64	D32B19	40	120	178	120	48.53
20	324.74	D32B20	40	130	191	120	53.98
21	340.84	D32B21	40	130	191	120	58.97
22	356.96	D32B22	40	130	191	120	63.96
23	373.07	D32B23	40	130	191	120	71.21
24	389.19	D32B24	40	130	191	120	77.57
25	405.32	D32B25	40	130	191	120	84.82
26	421.45	D32B26	40	130	191	120	91.17
27	437.58	D32B27	40	130	191	120	97.52
28	453.72	D32B28	40	130	191	120	101.13
30	485.99	D32B30	40	130	191	120	116.57
38	615.17	D32B38	40	178	254	181	170.25
40	647.47	D32C40	40	178	254	181	177.46
45	728.25	D32C45	40	178	254	181	195.50
48	776.72	D32C48	40	178	254	181	204.51
54	873.68	D32C54	40	178	254	181	222.53
57	922.16	D32C57	40	178	254	181	231.54
60	970.65	D32C60	40	178	254	181	255.83
76	1229.28	D32C76	40	178	254	181	292.83

Maximum bores shown will accommodate standard keyseat and setscrew over keyseat. Slightly larger bores are possible with no keyseat, shallow keyseat, or setscrew at angle to keyseat.

SPROCKET ENGINEERING DATA

ROLLER CHAIN DIMENSIONS
SPROCKET TOOTH DIMENSIONS
MAXIMUM HUB RECOMMENDATIONS
APPLICATION AND SELECTION
HARDENING
CHAIN LENGTH CALCULATION
SPEED RATIOS
SPROCKET DIAMETERS
HORSEPOWER RATINGS

SPROCKETS

American sprocket manufacturers have adopted 4 specific types of sprocket construction styles as American Standards. In addition to the standard sprockets, special sprockets may be available in the same styles.

- Style A** - Flat sprocket with no hub extension either side.
- Style B** - Sprocket with hub extension one side.
- Style C** - Sprocket with hub extension both sides.
- Style D** - Sprocket with a detachable bolt on hub attached to a plate.



Single
Type A Hub

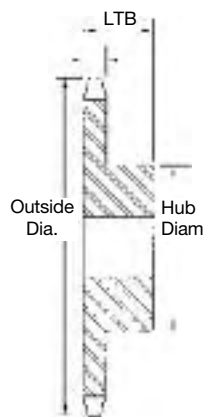

Single
Type B Hub

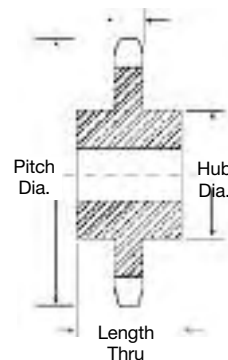

Single
Type C Hub



Single
Type D Hub

Multiple Strand Sprockets -

Listed using a letter prefix starting with the letter "D" for Double Strand, "E" for Triple Strand, and "F" for Quadruple, etc. They also have the same hub configuration letter designation listed on previous page. In addition to the four specific types, sprockets may also be made in various other styles.



Double



Triple

Five common styles are:

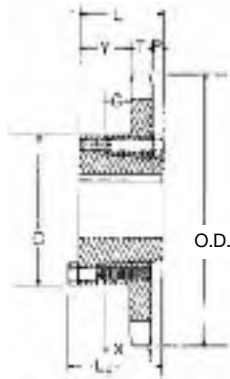

QD

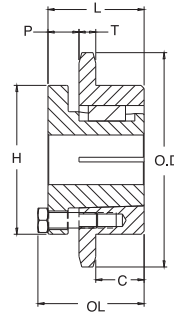

MST®

The **QD** (quick detachable) sprocket; here a tapered bushing is bolted into the bore machined in the sprocket. This bushing, when inserted into the sprocket, compresses onto the shaft providing a tight grip.

The **MST®** (*Martin Split Taper®*) is another style of bushed sprocket. The bushing is similar to the QD style except it has an external key that fits into the driven product.

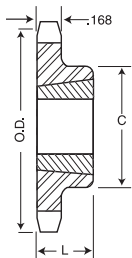

TB

The **TB** (taper bushed) sprocket is another style of an interchangeable bushed sprocket, which provides a positive grip on a driven shaft.

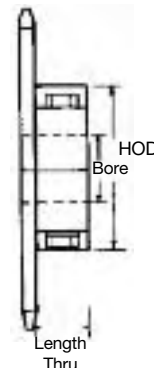

Split

A **split** type sprocket is used in place of solid type to allow quick installation without disruption of shaft and alignment.



Shear Pin Sprocket

A **shear pin** type hub is bolted to a sprocket providing an overload device; as sprocket torque ratings are exceeded the shear device disengages sprocket from drive.

Sprocket Nomenclature

Sprocket nomenclatures provide the chain pitch written to the left of the hub style code letter followed by the number of teeth in the sprocket. If the sprocket is to be multiple strand, the prefix code letter is added to the beginning of the part number.

A suffix of H is added if the teeth are to be heat treated. If the sprocket is to be bored for QD, Taper Bushed or MST, the center hub letter is changed. For QD and MST styles the letter designation of the bushing is used in lieu of the hub style code. If a taper bushing is to be used, the two letters TB are added behind the hub code letter.

In some instances, the material a sprocket is to be manufactured from will be added into the part number as a suffix.

For example:

- SS** - Stainless Steel Material
- NM** - Non-Metallic
- BR** - Brass or Bronze Material
- CD** - Cadmium Plated
- Zi** - Zinc Plated
- Ni** - Nickel Plated
- CH** - Chrome Plated

If the part is to be used with a shear pin device, the center hub style letter is substituted with an SP.

Most manufacturers of sprockets conform to the ANSI (American Standards Institute) and *Martin* conforms to the Type II tooth form as given in the standard B29.1 - 1975. It is not necessary to show detailed tooth information on sprocket drawings, just specify ANSI standard tooth form.

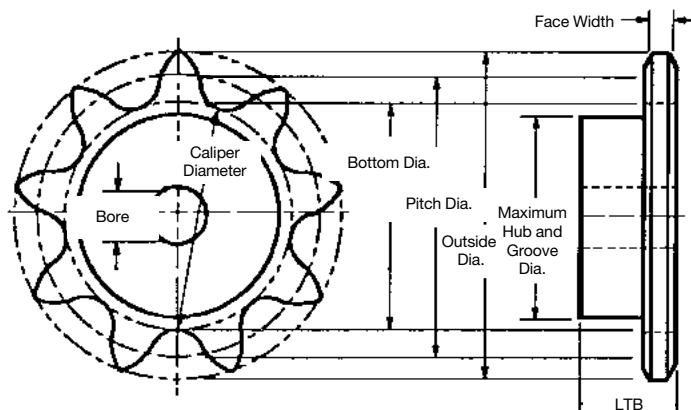

Sprocket Dimensional Specifications

Bottom Diameter (B.D.) - The diameter of a circle tangent to the bottoms of the tooth spaces.

Caliper Diameter - Since the bottom diameter of a sprocket with odd number of teeth cannot be measured directly, caliper diameters are the measurement across the tooth spaces nearly opposite.

Pitch Diameter (P.D.) - The diameter across to the pitch circle which is the circle followed by the centers of the chain pins as the sprocket revolves in mesh with the chain.

$$PD = \frac{PITCH}{\sin (180/Nt)}$$

Outside Diameter (O.D.) - The measurement from the tip of the sprocket tooth across to the corresponding point directly across the sprocket. It is comparatively unimportant as the tooth length is not vital to proper meshing with the chain. The outside diameter may vary depending on type of cutter used.

$$OD = (Pitch) (.6 + \cot [180 / Nt])$$

Hub Diameter (HOD) - That distance across the hub from one side to another. This diameter must not exceed the calculated diameter of the inside of the chain side bars.

Maximum Sprocket Bore - Maximum Sprocket Bore is determined by the required hub wall thickness for proper strength. Allowance must be made for keyway and setscrews.

Face Width - Face width is limited in its maximum dimension to allow proper clearance to provide for chain engagement and disengagement. The minimum width is limited to provide the proper strength to carry the imposed loads.

Length Thru Bore (LTB) - Length Thru Bore (or L.T.B.) must be sufficient to allow a long enough key to withstand the torque transmitted by the shaft. This also assures stability of the sprocket on the shaft.

Roller Chain Dimensions



SPROCKETS

ANSI Number	Roller Width	Roller Diam.	Inside Link Plate Height	Cottered Chain Width*	Riveted Chain Width*	Average Tensile Strength
STANDARD SERIES CHAIN						
25	1/8	.130	.237	.37	.34	875
25-2	1/8	.130	.237	.63	.59	1750
25-3	1/8	.130	.237	.88	.84	2626
35	3/16	.200	.356	.56	.50	2100
35-2	3/16	.200	.356	.96	.90	4200
35-3	3/16	.200	.356	1.36	1.31	6300
35-4	3/16	.200	.356	1.76	1.70	8400
35-5	3/16	.200	.356	2.16	2.11	10500
35-6	3/16	.200	.356	2.57	2.51	12600
40	1/4	.312	.475	.72	.67	3700
40-2	1/4	.312	.475	1.29	1.24	7400
40-3	1/4	.312	.475	1.85	1.80	11100
40-4	1/4	.312	.475	2.42	2.37	14800
40-6	1/4	.312	.475	3.56	3.51	22200
41	1/4	.306	.383	.65	.57	2000
50	3/8	.400	.594	.89	.83	6600
50-2	3/8	.400	.594	1.60	1.55	13200
50-3	3/8	.400	.594	2.31	2.26	19800
50-4	3/8	.400	.594	3.03	2.97	26400
50-5	3/8	.400	.594	3.75	3.69	33000
50-6	3/8	.400	.594	4.46	4.40	39600
60	1/2	.469	.712	1.11	1.04	8500
60-2	1/2	.469	.712	2.01	1.94	17000
60-3	1/2	.469	.712	2.91	2.84	25500
60-4	1/2	.469	.712	3.81	3.74	34000
60-5	1/2	.469	.712	4.71	4.64	42500
60-6	1/2	.469	.712	5.60	5.53	51000
80	3/4	.625	.950	1.44	1.32	14500
80-2	3/4	.625	.950	2.59	2.47	29000
80-3	3/4	.625	.950	3.74	3.62	43500
80-4	3/4	.625	.950	4.90	4.79	58000
80-5	3/4	.625	.950	6.06	5.94	72500
80-6	3/4	.625	.950	7.22	7.10	87000

*Dimensions are across pins.

ANSI Number	Roller Width	Roller Diam.	Inside Link Plate Height	Cottered Chain Width*	Riveted Chain Width*	Average Tensile Strength
STANDARD SERIES CHAIN						
100	3/4	.750	1.187	1.73	1.61	24000
100-2	3/4	.750	1.187	3.14	3.02	48000
100-3	3/4	.750	1.187	4.56	4.43	72000
100-4	3/4	.750	1.187	5.97	5.84	96000
100-5	3/4	.750	1.187	7.38	7.25	120000
100-6	3/4	.750	1.187	8.78	8.66	144000
120	1	.875	1.425	2.14	2.00	34000
120-2	1	.875	1.425	3.93	3.79	68000
120-3	1	.875	1.425	5.72	5.58	102000
120-4	1	.875	1.425	7.52	7.38	136000
120-5	1	.875	1.425	9.31	9.17	170000
120-6	1	.875	1.425	11.10	10.96	204000
140	1	1.000	1.662	2.31	2.14	46000
140-2	1	1.000	1.662	4.24	4.07	92000
140-3	1	1.000	1.662	6.16	6.00	138000
140-4	1	1.000	1.662	8.09	7.93	184000
140-6	1	1.000	1.662	11.94	11.78	276000
160	1 1/4	1.125	1.900	2.73	2.54	58000
160-2	1 1/4	1.125	1.900	5.04	4.85	116000
160-3	1 1/4	1.125	1.900	7.35	7.16	174000
160-4	1 1/4	1.125	1.900	9.66	9.47	232000
160-6	1 1/4	1.125	1.900	14.27	14.09	348000
180	1 1/2	1.406	2.137	3.15	2.88	76000
180-2	1 1/2	1.406	2.137	5.75	5.48	152000
180-3	1 1/2	1.406	2.137	8.34	8.07	228000
200	1 3/4	1.562	2.375	3.44	3.12	95000
200-2	1 3/4	1.562	2.375	6.26	5.94	190000
200-3	1 3/4	1.562	2.375	9.08	8.76	285000
200-4	1 3/4	1.562	2.375	11.90	11.58	380000
200-6	1 3/4	1.562	2.375	17.52	17.21	570000
240	2	1.875	2.812	4.06	3.72	130000
240-2	2	1.875	2.812	7.52	7.18	260000

*Dimensions are across pins.

STANDARD KEYWAYS AND SETSCREWS

Diameter of Shaft	Keyway Width x Depth	Setscrew	Diameter of Shaft	Keyway Width x Depth	Setscrew
1/2-3/8	1/8 x 1/16	10-24	2 1/8 - 2 1/4	3/8 x 3/16	3/8*
3/8-1/2	3/16 x 3/32	1/4	2 1/4 - 3 1/4	1/2 x 1/4	1/2*
1/2-5/8	1/4 x 1/8	5/16	3 1/8 - 3 3/4	3/4 x 3/16	3/4
5/8-3/4	3/8 x 3/32	3/8	3 3/8 - 4 1/2	1 x 1/4	1
3/4-7/8	1/2 x 1/8	1/2	4 1/8 - 5 1/2	1 1/4 x 3/8	1 1/4
7/8-1	5/8 x 1/8	5/8	5 1/8 - 6 1/2	1 3/4 x 3/8	1 3/4

*Hub size may require smaller setscrews in some instances.

STANDARD BORE TOLERANCES

1" and Less	+ .001 - .000
1 1/8" to 2"	+ .002 - .000
2 1/8" to 3"	+ .003 - .000
3 1/8" & up	+ .004 - .000
Bores with closer tolerances will be supplied at a slight increase in price.	

Sprocket Tooth Dimensions



Sprocket Tooth Dimensions

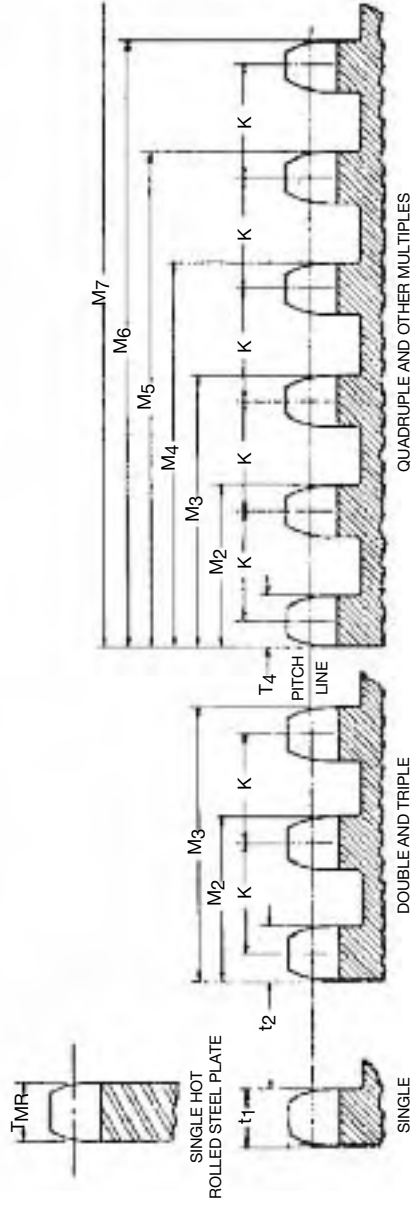

Dimensions in Inches

A.S.A. Chain No.	Chain Data For All Sprockets			Single Strand t_1 and t_{HR}	Double and Triple Strand						STANDARD SERIES ROLLER CHAIN SPROCKETS										K	Minus Tolerance on t_1 and t_{HR} Machined	Minus Tolerance on t_{HR}
	Pitch P	Roller Width W	Roller Diameter		Double Strand		Triple Strand		t_4	M_2	M_3	M_4	M_5	M_6	M_8	M_{10}	M_{12}	M_{16}					
					t_2	M_2	M_3	M_4											M_5	M_6			
25	1/4	1/8	.130	.110	.107	.359	.611	.096	.348	.600	.852	1.104	1.356	1.860	2.364	2.868	3.876	.252	.007	.021			
35	3/8	3/16	.200	.168	.162	.561	.960	.149	.548	.947	1.346	1.745	2.144	2.942	3.740	4.538	6.134	.399	.008	.027			
41	1/2	1/4	.306	.227	†	.841	†	.256	.822	1.388	1.954	2.520	3.086	4.218	5.250	6.482	8.746	†	.009	.032			
40	1/2	5/16	.312	.284	.275	.841	1.407	.311	1.024	1.737	2.450	3.163	3.876	5.302	6.728	8.154	11.006	.566	.009	.035			
50	5/8	3/8	.400	.343	.332	1.045	1.758	.418	1.315	2.212	3.108	4.006	4.903	6.697	8.491	10.258	13.873	.713	.010	.036			
60	3/4	1/2	.469	.459	.444	1.341	2.238	.484	1.679	2.832	3.985	5.138	6.291	8.597	10.903	13.209	17.821	.897	.011	.036			
80	1	3/4	.625	.575	.557	1.700	2.863	.526	2.041	3.449	4.857	6.265	7.673	10.489	13.305	16.121	21.753	1.153	.012	.040			
100	1 1/4	1	.750	.692	.669	2.077	3.484	.633	2.637	4.426	6.215	8.004	9.793	13.371	16.949	20.527	28.121	1.408	.014	.046			
120	1 1/2	1 1/4	.875	.824	.804	2.683	4.472	.848	3.449	5.673	8.004	10.468	12.932	17.198	21.464	25.730	34.527	1.789	.016	.057			
140	1 3/4	1 1/2	1.000	.924	.894	2.818	4.742	.848	3.668	6.000	8.544	11.088	13.632	18.164	22.696	27.228	36.723	1.924	.016	.057			
160	2	1 3/4	1.125	1.056	1.119	3.424	5.729	1.063	4.378	7.000	10.283	13.567	16.851	22.383	27.915	33.447	44.040	2.305	.019	.062			
180	2 1/4	2	1.406	1.301	1.259	3.851	6.443	1.197	4.958	8.000	11.565	14.849	18.133	24.265	30.397	36.529	48.661	2.592	.020	.068			
200	2 3/4	2 1/4	1.562	1.389	1.344	4.161	6.978	1.278	5.059	8.517	12.546	15.533	18.520	24.997	31.529	38.061	50.153	2.817	.021	.072			
240	3	2 3/4	1.875	1.738	1.682	5.140	8.598	1.601	5.959	11.975	15.433	18.891	22.349	30.000	37.651	46.302	60.000	3.458	.025	.087			

HEAVY SERIES CHAIN SPROCKETS

60H	.750	.500	.469	.459	.444	1.472	2.500	.418	1.446	2.474	3.502	4.530	5.558	7.614	9.670	11.726	15.558	1.028	.011	-.036
80H	1.000	.625	.625	.575	.557	1.840	3.123	.526	1.809	3.092	4.375	5.568	6.941	9.507	11.970	14.440	19.126	1.283	.012	-.040
100H	1.250	.750	.750	.692	.669	2.208	3.747	.633	2.172	3.711	5.250	6.789	8.328	11.406	14.486	17.566	23.452	1.539	.014	-.046
120H	1.500	1.000	.875	.824	.804	2.818	4.742	.848	2.772	4.696	6.620	8.544	10.468	14.316	18.164	22.012	29.126	1.924	.016	-.057
140H	1.750	1.000	1.000	.924	.894	2.949	5.004	.848	2.903	4.958	7.013	9.068	11.123	15.233	19.343	23.453	30.558	2.055	.016	-.057
160H	2.000	1.250	1.125	1.056	1.119	3.555	5.991	1.063	3.499	5.935	8.371	10.807	13.243	18.115	22.997	28.891	37.661	2.436	.019	-.062
180H	2.250	1.406	1.406	1.301	1.259	3.982	6.705	1.197	3.920	6.643	9.366	12.089	14.812	20.258	25.730	32.202	42.302	2.723	.020	-.068
200H	2.500	1.500	1.562	1.389	1.344	4.427	7.510	1.278	4.361	7.444	10.527	13.610	16.693	22.859	29.126	36.397	48.661	3.083	.021	-.072

† = Not made in multiple strands.

Maximum Hub Dimensions



Recommended Max. Hub and Bore Sizes

AMERICAN STANDARD NO. 25

AMERICAN STANDARD NO. 25												STD. KEYWAY (Am. Std.) and SETSCREW				
No. of Teeth	Max. RPM	Max. Hub	Max. Bore	No. of Teeth	Max. RPM	Max. Hub	Max. Bore	No. of Teeth	Max. RPM	Max. Hub	Max. Bore	Diameter of Shaft	Keyway Width x Depth	Diam. of Set-screw	Min. added to bore for adequate hub wall Steel Sprockets	
															Set-screw over Key	Set-screw not over Key
6	555	3/4	16	6940	1 3/32	3/16	26	8645	1 9/64	1 1/4				3/16"	3/8"
7	1300	3/4	17	7290	1 1/4	3/8	27	8655	1 5/64	1 1/4				1/2"	3/8"
8	2080	3/4	18	7590	1 1/8	3/8	28	8650	1 1/16	1 1/4				1/2"	3/8"
9	2860	7/16	1/4	19	7840	1 1/32	13/16	29	8625	2 1/64	2 1/8	3/8"	3/32" x 3/64"	3/16"	7/16"	3/8"
10	3610	1/2	1/4	20	8050	1 1/64	7/8	30	8580	2 1/2	2 1/2	1/2"	3/32" x 3/64"	3/16"	1/2"	3/8"
11	4310	3/16	1/4	21	8230	1 1/8	7/8	31	8540	2 1/4	2 1/2	1 1/2"	3/32" x 3/64"	3/16"	1/2"	3/8"
12	4960	3/16	3/8	22	8370	1 1/16	15/16	32	8465	2 1/4	2 1/2	1 1/2"	3/32" x 3/64"	3/16"	1/2"	3/8"
13	5540	3/16	3/8	23	8480	1 1/32	1	35	8200	2 3/64	2 1/2	1 1/2"	3/32" x 3/64"	3/16"	1/2"	3/8"
14	6070	3/16	3/8	24	8560	1 1/64	1 1/4	40	7580	2 5/64	2 1/2	1 1/2"	3/32" x 3/64"	3/16"	1/2"	3/8"
15	6530	3/16	3/8	25	8610	1 1/16	1 1/4	45	6820	3 3/32	2 1/2	1 1/2"	3/32" x 3/64"	3/16"	1 1/8"	3/8"

AMERICAN STANDARD NO. 35

AMERICAN STANDARD NO. 35												STD. KEYWAY (Am. Std.) and SETSCREW				
No. of Teeth	Max. RPM	Max. Hub	Max. Bore	No. of Teeth	Max. RPM	Max. Hub	Max. Bore	No. of Teeth	Max. RPM	Max. Hub	Max. Bore	Diameter of Shaft	Keyway Width x Depth	Diam. of Set-screw	Min. added to bore for adequate hub wall Steel Sprockets	
															Set-screw over Key	Set-screw not over Key
6	290	15/64	16	3630	1 15/32	15/16	26	4525	2 5/64	1 3/4				1/2"	3/8"
7	680	1/8	17	3810	1 1/32	1 1/8	27	4530	2 5/64	1 3/4				1/2"	3/8"
8	1090	3/8	1/4	18	3970	1 1/32	1 1/8	28	4525	2 5/64	1 3/4				1/2"	3/8"
9	1495	5/8	3/8	19	4100	1 1/32	1 1/4	29	4510	3 1/2	2	1/2"	3/32" x 3/64"	3/16"	1/2"	3/8"
10	1885	3/4	1/2	20	4210	1 1/64	1 1/4	30	4490	3 1/2	2 1/2	1/2"	3/32" x 3/64"	3/16"	1/2"	3/8"
11	2260	5/64	3/8	21	4300	2 1/64	1 3/8	31	4470	3 1/2	2 1/2	1/2"	3/32" x 3/64"	3/16"	1/2"	3/8"
12	2590	3/64	3/8	22	4380	2 1/64	1 1/2	32	4430	3 1/2	2 1/2	1/2"	3/32" x 3/64"	3/16"	1/2"	3/8"
13	2900	1 1/64	1 1/8	23	4430	2 1/8	1 3/8	35	4290	3 3/4	3	1 1/2"	3/32" x 3/64"	3/16"	1 1/8"	3/8"
14	3170	1 1/64	1 1/8	24	4480	2 1/8	1 3/8	40	3970	4 2/64	2 3/4	1 1/2"	3/32" x 3/64"	3/16"	1 1/8"	3/8"
15	3420	1 25/64	1 1/2	25	4510	2 1/8	1 3/4	45	3570	4 5/64	3 1/4	1 1/2"	3/32" x 3/64"	3/16"	1 1/2"	1"

AMERICAN STANDARD NO. 41

AMERICAN STANDARD NO. 41												STD. KEYWAY (Am. Std.) and SETSCREW				
No. of Teeth	Max. RPM	Max. Hub	Max. Bore	No. of Teeth	Max. RPM	Max. Hub	Max. Bore	No. of Teeth	Max. RPM	Max. Hub	Max. Bore	Diameter of Shaft	Keyway Width x Depth	Diam. of Set-screw	Min. added to bore for adequate hub wall Steel Sprockets	
															Set-screw over Key	Set-screw not over Key
6	130	27/64	1/8	16	1630	2 1/8	1 3/8	26	2040	3 5/64	2 1/2				1 1/2"	1"
7	305	19/32	5/8	17	1720	2 1/32	1 1/2	27	2040	3 5/64	2 1/2				1 1/2"	1"
8	495	49/64	1/2	18	1790	2 1/32	1 1/2	28	2040	4	2 1/2				1 1/2"	1"
9	675	15/16	9/16	19	1850	2 1/32	1 3/4	29	2040	4 1/2	2 3/4	5/8" - 7/8"	3/16" x 3/32"	1/4"	1 1/2"	1"
10	850	1 1/32	1 1/16	20	1890	2 1/32	1 3/4	30	2020	4 1/2	2 3/4	1 1/2" - 1 3/4"	3/16" x 3/32"	1/4"	1 1/2"	1"
11	1020	1 17/64	7/8	21	1940	2 1/8	1 3/4	31	2020	4 1/2	2 3/4	1 1/2" - 1 3/4"	3/16" x 3/32"	1/4"	1 1/2"	1"
12	1170	1 27/64	7/8	22	1970	3 1/32	2	32	2000	4 1/2	3 1/8	1 1/2" - 1 3/4"	3/16" x 3/32"	1/4"	1 1/2"	1"
13	1310	1 37/64	1 1/8	23	2000	3 1/8	2 1/8	35	1930	5 1/64	3 1/8	1 1/2" - 2 1/4"	3/16" x 3/32"	1/4"	1 1/2"	1"
14	1430	1 1/2	1 1/4	24	2020	3 3/64	2 1/4	40	1780	5 29/64	3 1/8	2 1/2" - 2 3/4"	3/16" x 3/32"	1/4"	1 1/2"	1 1/4"
15	1540	1 29/32	1 1/4	25	2030	3 3/64	2 1/4	45	1600	6 5/64	4 1/16	2 1/2" - 3 1/4"	3/16" x 3/32"	1/4"	2 1/4"	1 1/2"

AMERICAN STANDARD NO. 40

AMERICAN STANDARD NO. 40												STD. KEYWAY (Am. Std.) and SETSCREW				
No. of Teeth	Max. RPM	Max. Hub	Max. Bore	No. of Teeth	Max. RPM	Max. Hub	Max. Bore	No. of Teeth	Max. RPM	Max. Hub	Max. Bore	Diameter of Shaft	Keyway Width x Depth	Diam. of Set-screw	Min. added to bore for adequate hub wall Steel Sprockets	
															Set-screw over Key	Set-screw not over Key
6	220	23/64	16	2720	1 5/64	1 1/4	26	3400	3 37/64	2 1/2				1 1/2"	1 1/2"
7	510	1/2	1/4	17	2860	2 1/64	1 3/8	27	3405	3 37/64	2 1/2				1 1/2"	1 1/2"
8	820	3/8	3/8	18	2980	2 1/64	1 1/2	28	3405	3 37/64	2 1/2				1 1/2"	1 1/2"
9	1125	5/8	3/8	19	3080	2 1/64	1 1/2	29	3395	4 1/64	2 3/4	5/8" - 7/8"	3/16" x 3/32"	1/4"	1 1/2"	1 1/2"
10	1420	1	3/8	20	3160	2 1/8	1 3/4	30	3370	4 1/2	2 3/4	1 1/2" - 1 3/4"	3/16" x 3/32"	1/4"	1 1/2"	1 1/2"
11	1690	1 1/64	3/4	21	3230	2 1/32	1 3/4	31	3360	4 1/2	2 3/4	1 1/2" - 1 3/4"	3/16" x 3/32"	1/4"	1 1/2"	1 1/2"
12	1940	1 1/64	3/4	22	3290	2 1/16	1 3/4	32	3330	4 1/2	2 3/4	1 1/2" - 1 3/4"	3/16" x 3/32"	1/4"	1 1/2"	1 1/2"
13	2180	1 1/2	1	23	3330	3 1/32	2 1/8	35	3220	5 1/64	3 1/4	1 1/2" - 2 1/4"	3/16" x 3/32"	1/4"	1 1/2"	1 1/2"
14	2380	1 5/8	1 1/8	24	3360	3 1/64	2 1/4	40	2970	5 3/64	3 1/2	2 1/2" - 2 3/4"	3/16" x 3/32"	1/4"	1 1/2"	1 1/2"
15	2560	1 5/8	1 1/4	25	3380	3 1/64	2 1/4	45	2670	6 3/64	4 3/16	2 1/2" - 3 1/4"	3/16" x 3/32"	1/4"	2 1/4"	1 1/2"

AMERICAN STANDARD NO. 50

AMERICAN STANDARD NO. 50												STD. KEYWAY (Am. Std.) and SETSCREW				
No. of Teeth	Max. RPM	Max. Hub	Max. Bore	No. of Teeth	Max. RPM	Max. Hub	Max. Bore	No. of Teeth	Max. RPM	Max. Hub	Max. Bore	Diameter of Shaft	Keyway Width x Depth	Diam. of Set-screw	Min. added to bore for adequate hub wall Steel Sprockets	
															Set-screw over Key	Set-screw not over Key
6	155	27/64	1/8	16	1960	2 31/64	1 11/16	26	2445	4 37/64	2 1/2				1 1/2"	1 1/2"
7	370	49/64	3/8	17	2060	2 1/16	1 3/4	27	2450	4 11/64	3 3/8				1 1/2"	1 1/2"
8	590	2 1/32	3/8	18	2150	2 1/64	1 3/4	28	2445	4 5/64	3 1/4				1 1/2"	1 1/2"
9	810	1 1/64	1 1/8	19	2220	3 1/64	2 1/8	29	2440	5 1/64	3 3/8	5/8" - 7/8"	3/16" x 3/32"	1/4"	1 1/2"	1 1/2"
10	1020	1 17/64	3/4	20	2280	3 1/32	2 1/4	30	2430	5 1/2	3 1/2	1 1/2" - 1 3/4"	3/16" x 3/32"	1/4"	1 1/2"	1 1/2"
11	1220	1 15/32	15/16	21	2330	3 1/64	2 1/4	31	2415	5 31/64	3 11/16	1 1/2" - 1 3/4"	3/16" x 3/32"	1/4"	1 1/2"	1 1/2"
12	1400	1 43/64	1 1/8	22	2370	3 1/16	2 1/2	32	2395	5 1/16	3 1/2	1 1/2" - 1 3/4"	3/16" x 3/32"	1/4"	1 1/2"	1 1/2"
13	1570	1 1/2	1 1/4	23	2400	3 3/64	2 3/8	35	2320	6 1/32	4 1/8	1 1/2" - 2 1/4"	3/16" x 3/32"	1/4"	1 1/2"	1 1/2"
14	1720	2 1/64	1 3/8	24	2420	4 1/64	2 3/4	40	2140	7 1/32	5 1/2	2 1/2" - 2 3/4"	3/16" x 3/32"	1/4"	1 1/2"	1 1/2"
15	1850	2 1/2	1 1/2	25	2440	4 1/32	2 3/4	45	1930	8 1/32	6 1/4	2 1/2" - 3 1/4"	3/16" x 3/32"	1/4"	2 1/4"	1 1/2"

AMERICAN STANDARD NO. 60

AMERICAN STANDARD NO. 60												STD. KEYWAY (Am. Std.) and SETSCREW				
No. of Teeth	Max. RPM	Max. Hub	Max. Bore	No. of Teeth	Max. RPM	Max. Hub	Max. Bore	No. of Teeth	Max. RPM	Max. Hub	Max. Bore	Diameter of Shaft	Keyway Width x Depth	Diam. of Set-screw	Min. added to bore for adequate hub wall Steel Sprockets	
															Set-screw over Key	Set-screw not over Key
6	120	39/64	1/4	16	1480	2 31/64	1 5/16	26	1840	5 25/64	3 3/8				1 1/2"	1 1/2"
7	275	49/64	1/2	17	1550	3 1/32	2 1/8	27	1845	5 1/8	3 3/4				1 1/2"	1 1/2"
8	445	1 1/32	5/8	18	1610	3 1/32	2 1/4	28	1840	5 1/8	3 3/8				1 1/2"	1 1/2"
9	610	1 1/32	3/4	19	1670	3 3/64	2 1/2	29	1835	6 1/64	4 1/8	1 1/2" - 1 3/4"	3/16" x 3/32"	1/4"	1 1/2"	1 1/2"
10	770	1 39/64	1	20	1720	3 3/64	2 1/2	30	1830	6 11/64	4 1/8	1 1/2" - 1 3/4"	3/16" x 3/32"	1/4"	1 1/2"	1 1/2"
11	920	1 49/64	1 1/4	21	1750	4 1/64	2 1/2	31	1815	6 19/64	4 1/8	1 1/2" - 1 3/4"	3/16" x 3/32"	1/4"	1 1/2"	1 1/2"
12	1050	2 1/64	1 1/4	22	1780	4 1/16	2 1/2	32	1800	6 31/64	4 1/8	1 1/2" - 1 3/4"	3/16" x 3/32"	1/4"	1 1/2"	1 1/2"
13	1180	2 1/4	1 1/2	23	1800	4 1/64	3 1/8	35	1740	7 31/64	5 1/2	2 1/2" - 2 3/4"	3/16" x 3/32"	1/4"	1 1/2"	1 1/2"
14	1290	2 1/2	1 3/4	24	1820	4 1/32	3 1/4	40	1610	8 1/4	6 1/2	2 1/2" - 3 1/4"	3/16" x 3/32"	1/4"	2 1/4"	1 1/2"
15	1390	2 3/4	1 3/4	25	1830	5 1/32	3 3/8	45	1450	9 1/16	7 1/8	3 1/2" - 3 3/4"	3/16" x 3/32"	1/4"	2 3/8"	1 1/2"



Maximum Hub Dimensions

Recommended Max. Hub and Bore Sizes

AMERICAN STANDARD NO. 80

AMERICAN STANDARD NO. 80												STD. KEYWAY (Am. Std.) and SETSCREW				
No. of Teeth	Max. RPM	Max. Hub	Max. Bore	No. of Teeth	Max. RPM	Max. Hub	Max. Bore	No. of Teeth	Max. RPM	Max. Hub	Max. Bore	Diameter of Shaft	Keyway Width x Depth	Diam. of Set-screw	Min. added to bore for adequate hub wall Steel Sprockets	
															Setscrew over Key	Setscrew not over Key
6	75	5/16	3/16	16	935	3 5/16	2 1/16	26	1165	7 1/4	5 1/16					
7	175	1 1/16	5/16	17	985	4 1/16	2 3/16	27	1170	6 3/4	5 1/2					
8	280	1 1/8	7/16	18	1020	4 3/8	3 1/8	28	1170	7 1/2	5 3/8					
9	385	1 1/2	1 1/16	19	1060	4 5/8	3 3/8	29	1165	8 1/2	6 1/8					
10	485	2 1/8	1 1/4	20	1090	5 1/2	3 1/2	30	1160	8 3/4	6 1/4	1 5/16"-1 1/8"	1/4" x 1/8"	1/4"	3/4"	1/2"
11	580	2 3/8	1 5/8	21	1110	5 3/2	3 3/4	31	1155	8 5/8	6 1/2	1 1/8"-1 1/4"	5/16" x 3/32"	3/16"	1 1/8"	3/4"
12	670	2 5/8	1 3/4	22	1130	5 1/2	3 3/8	32	1143	9 1/4	6 3/8	1 1/4"-2 1/4"	3/8" x 1/4"	1/2"	1 1/2"	1"
13	750	3 1/4	2	23	1150	6 1/4	4 1/8	35	1110	10 3/4	7 1/2	2 1/8"-2 3/4"	1/2" x 3/8"	3/4"	1 1/2"	1 1/4"
14	820	3 1/2	2 1/4	24	1160	6 1/2	4 1/4	40	1020	11 1/4	8 1/2	2 3/8"-3 1/4"	3/4" x 1/2"	3/4"	2 1/4"	1 1/2"
15	880	3 3/4	2 3/8	25	1160	6 3/8	5 1/8	45	920	13 1/4	9 1/2	3 1/8"-3 3/4"	1/2" x 5/16"	3/4"	2 3/8"	1 3/4"

AMERICAN STANDARD NO. 100

AMERICAN STANDARD NO. 100												STD. KEYWAY (Am. Std.) and SETSCREW				
No. of Teeth	Max. RPM	Max. Hub	Max. Bore	No. of Teeth	Max. RPM	Max. Hub	Max. Bore	No. of Teeth	Max. RPM	Max. Hub	Max. Bore	Diameter of Shaft	Keyway Width x Depth	Diam. of Set-screw	Min. added to bore for adequate hub wall Steel Sprockets	
															Setscrew over Key	Setscrew not over Key
6	55	1/2	3/8	16	670	5	3 1/4	26	830	9 1/4	6 1/2					
7	125	1 1/16	7/16	17	700	5 1/2	3 3/8	27	835	9 1/2	6 3/4					
8	200	1 1/8	1 1/16	18	730	5 3/4	3 3/4	28	830	9 1/2	7 1/8					
9	275	2 1/8	1 1/8	19	755	6 1/4	4 1/8	29	830	10 1/4	7 1/2	1 1/8"-1 3/8"	5/16" x 3/32"	5/16"	1 1/8"	5/8"
10	350	2 3/8	1 3/8	20	775	6 3/4	4 1/4	30	825	10 3/8	7 3/8	1 1/8"-1 3/4"	3/8" x 1/4"	3/8"	1 1/4"	3/4"
11	415	2 1/2	1 1/2	21	790	7	5 1/4	31	820	11	8	1 1/4"-2 1/4"	1/2" x 1/4"	1/2"	1 1/2"	1"
12	475	3 1/8	2 1/4	22	805	7 1/2	5 1/2	32	815	11 1/2	8 1/2	2 1/8"-2 3/4"	3/8" x 3/8"	3/8"	1 1/4"	1 1/4"
13	535	3 3/8	2 1/2	23	815	7 1/4	5 1/2	35	790	12 3/8	9 1/4	2 1/4"-3 1/4"	1/2" x 3/8"	3/4"	2 1/4"	1 1/2"
14	585	4 1/8	2 3/4	24	825	8 1/4	6 3/8	40	730	14 1/2	10 1/2	3 1/8"-3 3/4"	3/4" x 1/2"	3/4"	2 3/8"	1 3/4"
15	630	4 1/2	3 1/8	25	830	8 3/8	6 1/2	45	655	16 1/2	11 1/2	3 1/8"-4 1/2"	1" x 1/2"	3/4"	2 1/2"	2"

AMERICAN STANDARD NO. 120

AMERICAN STANDARD NO. 120												STD. KEYWAY (Am. Std.) and SETSCREW				
No. of Teeth	Max. RPM	Max. Hub	Max. Bore	No. of Teeth	Max. RPM	Max. Hub	Max. Bore	No. of Teeth	Max. RPM	Max. Hub	Max. Bore	Diameter of Shaft	Keyway Width x Depth	Diam. of Set-screw	Min. added to bore for adequate hub wall Steel Sprockets	
															Setscrew over Key	Setscrew not over Key
6	40	1 1/16	1 1/16	16	520	6	4	26	650	10 1/2	7 1/2					
7	100	1 3/16	1 1/8	17	550	6 1/16	4 1/8	27	650	11 1/8	8 1/4					
8	155	2 1/16	1 1/2	18	570	6 1/2	5 1/8	28	650	11 3/8	8 3/8					
9	215	2 3/8	1 3/4	19	590	7 1/16	5 1/2	29	650	12 1/4	8 1/2	1 1/8"-1 1/2"	3/8" x 3/8"	3/8"	1 1/8"	3/4"
10	270	3 1/8	2 1/8	20	605	7 1/2	5 1/2	30	645	12 3/4	9 1/8	1 1/8"-2 1/4"	1/2" x 1/4"	1/2"	1 1/4"	1"
11	325	3 3/8	2 3/8	21	620	8 1/16	6 1/8	31	645	13 1/8	9 1/4	2 1/8"-2 3/4"	3/8" x 3/8"	3/8"	1 1/8"	1 1/4"
12	375	4 1/8	2 3/4	22	630	8 3/8	6 1/2	32	640	13 1/2	10 1/8	2 1/8"-3 1/4"	3/4" x 3/8"	3/4"	2 1/4"	1 1/2"
13	415	4 3/8	3	23	640	9 1/8	6 1/4	35	615	15 1/2	11 1/4	3 1/8"-3 3/4"	1/2" x 1/2"	3/4"	2 3/8"	1 3/4"
14	455	5 1/2	3 1/4	24	645	9 3/8	7 1/8	40	570	17 3/8	12 1/2	3 1/8"-4 1/2"	1" x 1/2"	3/4"	2 1/2"	2"
15	490	5 3/8	3 3/4	25	650	10 1/2	7 1/2	45	515	19 3/8	14 1/2	4 1/8"-5 1/2"	1 1/4" x 3/8"	3/4"	2 3/8"	1 3/4"

AMERICAN STANDARD NO. 140

AMERICAN STANDARD NO. 140												STD. KEYWAY (Am. Std.) and SETSCREW				
No. of Teeth	Max. RPM	Max. Hub	Max. Bore	No. of Teeth	Max. RPM	Max. Hub	Max. Bore	No. of Teeth	Max. RPM	Max. Hub	Max. Bore	Diameter of Shaft	Keyway Width x Depth	Diam. of Set-screw	Min. added to bore for adequate hub wall Steel Sprockets	
															Setscrew over Key	Setscrew not over Key
6	30	1 1/4	3/8	16	380	7 1/4	5 1/4	26	475	12 3/8	9 1/8					
7	70	1 7/16	1 1/4	17	400	7 3/8	5 1/2	27	475	13 1/8	9 1/4					
8	115	2 1/8	1 1/2	18	415	8 1/16	6 1/8	28	475	13 3/8	10 1/4					
9	150	3 1/8	2	19	430	8 3/8	6 1/2	29	475	14 1/8	10 3/4	1 1/8"-1 1/2"	3/8" x 3/8"	3/8"	1 1/8"	3/4"
10	200	3 3/8	2 1/8	20	440	9 1/16	6 3/4	30	470	14 3/8	11 1/8	1 1/8"-2 1/4"	1/2" x 1/4"	1/2"	1 1/4"	1"
11	235	4 1/8	2 3/4	21	450	9 3/8	7 1/8	31	470	15 1/8	11 3/4	2 1/8"-2 3/4"	3/8" x 3/8"	3/8"	1 1/8"	1 1/4"
12	270	4 3/4	3 1/4	22	460	10 1/8	7 1/2	32	465	15 3/8	12 1/8	2 1/8"-3 1/4"	3/4" x 3/8"	3/4"	2 1/4"	1 1/2"
13	305	5 1/8	3 3/8	23	465	10 3/8	7 3/8	35	450	17 1/2	13 1/4	3 1/8"-3 3/4"	1/2" x 1/2"	3/4"	2 3/8"	1 3/4"
14	335	5 3/8	3 3/4	24	470	11 1/8	8 1/2	40	415	20 3/8	14 1/2	3 1/8"-4 1/2"	1" x 1/2"	3/4"	2 1/2"	2"
15	360	6 3/16	4 1/8	25	475	12 1/8	8 3/8	45	375	23 3/8	16 1/2	4 1/8"-5 1/2"	1 1/4" x 3/8"	3/4"	2 3/8"	1 3/4"

AMERICAN STANDARD NO. 160

AMERICAN STANDARD NO. 160												STD. KEYWAY (Am. Std.) and SETSCREW				
No. of Teeth	Max. RPM	Max. Hub	Max. Bore	No. of Teeth	Max. RPM	Max. Hub	Max. Bore	No. of Teeth	Max. RPM	Max. Hub	Max. Bore	Diameter of Shaft	Keyway Width x Depth	Diam. of Set-screw	Min. added to bore for adequate hub wall Steel Sprockets	
															Setscrew over Key	Setscrew not over Key
6	25	1 1/2	7/8	16	325	8 1/4	6	26	405	14 1/8	10 1/8					
7	60	2 1/16	1 1/8	17	340	8 3/8	6 1/2	27	405	15 1/8	10 3/4					
8	100	2 3/8	1 3/4	18	355	9 1/8	6 3/4	28	405	15 3/8	11 1/4					
9	135	3 1/8	2 1/4	19	365	9 3/8	7 1/8	29	400	16 3/8	11 3/4	1 1/8"-2 1/4"	1/2" x 1/4"	1/2"	1 1/4"	1"
10	170	4 1/8	2 3/4	20	375	10 1/8	7 3/8	30	400	17	12 1/8	2 1/8"-2 3/4"	3/8" x 3/8"	3/8"	1 1/8"	1 1/4"
11	200	4 3/8	3 1/4	21	385	11 1/8	8 1/8	31	400	17 1/2	12 3/4	2 1/8"-3 1/4"	3/4" x 3/8"	3/4"	1 1/2"	1 1/2"
12	230	5 1/8	3 3/8	22	390	11 1/4	8 1/2	32	395	18 1/8	13 1/4	3 1/8"-3 3/4"	1/2" x 1/2"	3/4"	2 3/8"	1 3/4"
13	260	6 1/16	4 1/8	23	395	12 1/8	9	35	380	20 1/8	14 1/2	3 1/8"-4 1/2"	1" x 1/2"	3/4"	2 1/2"	2"
14	280	6 3/8	4 3/8	24	400	13 1/8	9 1/4	40	355	23 1/8	15 1/2	4 1/8"-5 1/2"	1 1/4" x 3/8"	3/4"	2 3/8"	1 3/4"
15	305	7 1/8	5 1/2	25	400	13 3/8	10 1/4	45	320	26 1/8	17 1/2	5 1/8"-6 1/2"	1 1/2" x 3/8"	3/4"	3"	2"

AMERICAN STANDARD NO. 200

AMERICAN STANDARD NO. 200												STD. KEYWAY (Am. Std.) and SETSCREW				
No. of Teeth	Max. RPM	Max. Hub	Max. Bore	No. of Teeth	Max. RPM	Max. Hub	Max. Bore	No. of Teeth	Max. RPM	Max. Hub	Max. Bore	Diameter of Shaft	Keyway Width x Depth	Diam. of Set-screw	Min. added to bore for adequate hub wall Steel Sprockets	
															Setscrew over Key	Setscrew not over Key
6	20	1 5/16	1 1/4	16	235	10 1/2	7 1/2	26	290	18 3/4	13 1/4					
7	45	2 1/8	1 1/2	17	245	10 3/8	7 3/8	27	290	18 3/4	13 1/4					
8	70	3 1/2	2 1/4	18	255	11 1/4	8 1/8	28	290	19 1/2	13 3/4					
9	95	4 1/8	2 3/8	19	265	12 1/8	8 3/8	29	290	20 3/8	14 1/4	2 1/8"-2 3/4"	3/8" x 3/8"	3/8"	1 1/8"	1 1/4"
10	120	5 1/2	3 3/8	20	270	13 1/4	9 1/4	30	290	21 1/4	14 3/4	2 1/8"-3 1/4"	3/4" x 3/8"	3/4"	2 1/4"	1 1/2"
11	145	5 3/8	3 1/2	21	280	14 1/8	10 1/2	31	400	22 3/4	15 1/4	3 1/8"-3 3/4"	1/2" x 1/2"	3/4"	2 3/8"	1 3/4"
12	165	6 1/8	5	22	280	14 3/8	10 3/8	32	285	22 3/8	15 1/2	3 1/8"-4 1/2"	1" x 1/2"	3/4"	2 1/2"	2"
13	185	7 3/8	5 1/2	23	285	15 1/8	11 1/4	35	275	25 1/8	16 1/4	4 1/8"-5 1/2"	1 1/4" x 3/8"	3/4"	2 3/8"	1 3/4"
14	205	8 1/8	6 1/8	24	290	16 3/8	11 3/4	40	255	29 1/8	17 1/4	5 1/8"-6 1/2"	1 1/2" x 3/8"	3/4"	3"	2"
15	220	9 1/2	6 1/2	25	290	17 1/4	12 1/4	45	230	33 1/2	18 1/2	6 1/8"-7 1/2"	1 3/4" x 3/8"	3/4"	3 1/4"	2 1/2"

SPROCKETS

Application Data and Selection Procedure

How to Check Horsepower Rating of Installed Drive

1. Determine the types of driving and driven loads and obtain the proper service factor, as explained in Steps 1 and 2 under Selection Procedures.
2. Find the multiple strand factor, for the number of chain strands in the drive, from the Multiple Strand Factor Table, in Horsepower Tables (Page E-186 thru E-192).
3. From the horsepower rating table for the chain pitch, read the figure under the RPM of the small sprocket and to the right of the column giving number of teeth in the small sprocket.
4. The horsepower this drive can properly transmit is as follows:

$$\text{HORSEPOWER DRIVE CAN TRANSMIT} = \frac{\left(\begin{array}{c} \text{Rating Table} \\ \text{Horsepower} \end{array} \right)}{\text{Service Factor}} \times \left(\begin{array}{c} \text{Multiple Strand} \\ \text{Factor} \end{array} \right)$$

Center Distance

The following general principals should be applied in determining shaft center distances. The center distance must always be greater than one-half the sum of the sprocket outside diameters to avoid interference of teeth. When the speed ratio is greater than 3 to 1, the center distance should be not less than the sum of the sprocket diameters. Chain wrap should be at least 120° of the small sprocket — one-third of the teeth meshing.

Longer center distances give greater chain wrap. For average applications a center distance of 30 to 50 pitches of chain is recommended for best results. For pulsating loads, a center distance of 20 to 30 pitches may be desirable. For center distances of 80 pitches or greater, idlers or chain guides should be used to support the chain. Slightly adjustable center distances will provide chain tension as the chain elongates with wear.

Alignment

Accurate alignment of shafts and sprocket tooth faces provide uniform distribution of the load across the entire chain width and contributes substantially to optimum drive life. Shafting, bearings, and foundations should be suitable to maintain the initial alignment. Periodic maintenance should include an inspection of alignment to insure optimum chain life.

Design Horsepower

When making drive selections consideration is given to the loads imposed on the chain. Service factors based on the type of equipment to be driven (Table I, Page E162) and the type of input power (Table II, Page E162) are used to compensate for these loads.

Horsepower Rating Tables

The horsepower ratings in this catalog apply to lubricated single pitch, single strand precision roller chains, both standard and double pitch roller chain.

The ratings reflect a service factor of 1, a chain length of approximately 100 pitches, use of recommended lubrication methods, and a drive arrangement where two aligned sprockets are mounted on parallel horizontal shafts.

The horsepower ratings relate to the speed of the smaller sprocket and drive selections are made on this basis, whether the drive is speed reducing or speed increasing.

For ratings of multiple strand roller chains refer to Multiple Strand Factor in Horsepower Tables.

Lubrication

It has been shown that a separate wedge of fluid lubricant is formed in operating chain joints much like that formed in journal bearings. Therefore, fluid lubricant must be applied to assure an oil supply to the joints and minimize metal to metal contact. Lubrication, if supplied in sufficient volume, also provides effective cooling and impact damping at the higher speeds. For this reason, it is important that the lubrication recommendations be followed. The horsepower rating tables shown throughout this catalog, apply only to drives lubricated in the manner specified in the tables.

Chain drives should be protected against dirt and moisture and the oil supply kept free of contamination. Periodic oil change is desirable. A good grade of non-detergent petroleum base oil is recommended. Heavy oils and grease are generally too stiff to enter and fill the chain joints.

Application Data and Selection Procedure

Types of Lubrication

There are four basic types of lubrication for chain drives. The recommended type shown in the horsepower rating tables is influenced by chain speed and the amount of power transmitted. These are minimum lubrication requirements and the use of a better type (for example, Type C instead of Type B) is acceptable and may be beneficial. Chain life can vary appreciably depending upon the way the drive is lubricated. The better the lubrication, the longer the chain and sprocket life. For this reason, it is important that the lubrication recommendations be followed when using the rating tables given in this catalog.

Lubrication

TYPE A — Manual Lubrication. Oil applied periodically with brush or spout can.

TYPE B — Oil Bath or Oil Slinger. Oil level maintained in casing at predetermined height.

TYPE C — Oil Stream. Oil supplied by circulating pump inside chain loop on lower span.

NOTE: Drip Lubrication. Oil applied between link plate edges from a drip lubricator and should be used in clean environments only.

Selection of Roller Chain Drives

The following information is necessary for the proper selection and design of Roller Chain Drives:

1. Type of input horsepower (electrical motor, internal combustion engine.)
2. Type of equipment to be driven.
3. Horsepower to be transmitted.
4. Full load speed of the fastest running shaft. (R.P.M.)
5. Desired speed of the slow speed shaft. (R.P.M.)
6. Diameters of the driving and driven shafts.
7. Center to center distance of shafts.
8. Position of drive and space limitations.
9. Method of lubrication.
10. Conditions of drive, steady or fluctuating load, hours of operation, lubrication.

Most roller chain drive applications allow considerable latitude in the selection of sprocket sizes and chain pitch, although usually one combination will best fulfill the requirements of power, speed, space limitations and economy.

Chain and Sprocket Selection Procedure Steps:

1. Determine class of driven load.
2. Select service factor.
3. Calculate design horsepower.
4. Select chain pitch.
5. Select number of teeth in small sprocket.
6. Determine number of teeth in larger sprocket.
7. Determine center distance.
8. Calculate chain length.

Drive Positions

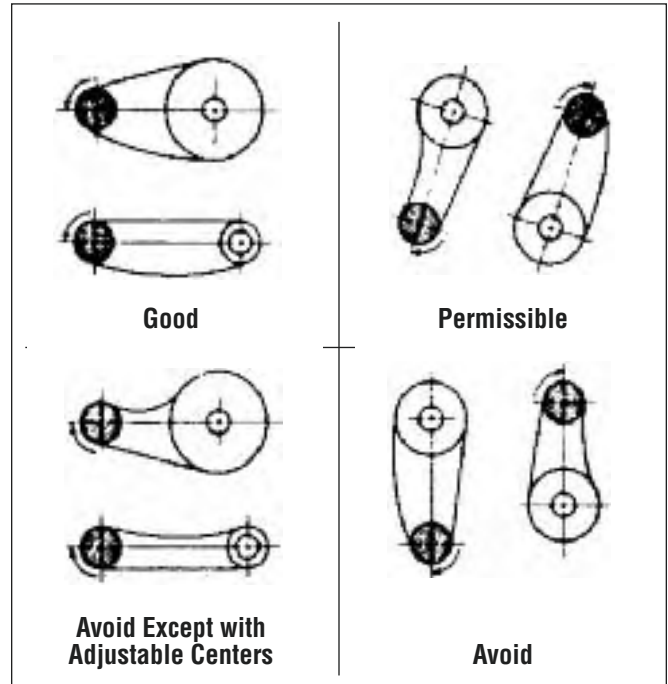

Application Data and Selection Procedure

Step I

Service Classification — Table I

Uniform Load

Agitators, Liquid	Generators
Blowers, Centrifugal	Line Shafts, Even Load
Conveyors, Even Load	Machines, Even Load,
Elevators, Even Load	Non-reversing
Fans, Centrifugal	Pumps, Centrifugal

Moderate Shock Load

Beaters	Laundry - Washers
Compressors, Centrifugal	and Tumblers
Conveyors, Uneven Load	Line Shafts, Uneven Load
Elevators, Uneven Load	Machines, Pulsating
Grinders, Pulp	Load, Non-reversing
Kilns and Dryers	Pumps, Reciprocating, Triplex
	Screens, Rotary, Even Load
	Woodworking Machinery

Heavy Shock Load

Brick Machines	Mills, Hammer, Rolling
Compressors Reciprocating	or Drawing
Crushers	Presses
Machines, Reversing or Impact Loads	Pumps, Reciprocating, Simplex or Duplex

Step II

Service Factor — Table II

SERVICE CLASSIFICATION	TYPE OF INPUT POWER		
	Internal Combustion Engine with Hydraulic Drive	Electric Motor or Turbine	Internal Combustion Engine with Mechanical Drive
Uniform Load	1.0	1.0	1.2
Moderate Shock Load	1.2	1.3	1.4
Heavy Shock Load	1.4	1.5	1.7

Unfavorable Operating Conditions which may be present should be compensated for by adding .2 to the Service Factor for each unfavorable condition. Some of these conditions are listed below:

1. Multiple Shafts — add .2 for each additional shaft.
2. Excessive speed ratios — exceeding 7 to 1.
3. Heavy starting loads with frequent starts and stops.
4. Conditions of high temperatures, unusually abrasive conditions, or circumstances decreasing lubrication effectiveness or not allowing the use of recommended lubrication procedures.

Step III

Determination of Design Horsepower

Determine the design horsepower of the required drive using the following procedure.

1. Determine Service Classification — Table I. Unlisted equipment may be classified by its similarity to a listed type.
2. Using Service Classification and Frequency of Service, select the Service Factor — Table II. Increase the Service Factor by adding compensation for unfavorable operating conditions.
3. Multiply the normal operating horsepower of the drive by the Compensated Service Factor to obtain Service Horsepower.

Step IV

Drive Selection

Using Design Horsepower computed above, use Trial Selection Chart (Horsepower Tables) on page E184-E185, or enter tables of Horsepower Ratings shown on pages E186 thru E192. Select the smallest pitch chain which has the required horsepower rating for a pinion sprocket turning at the specified RPM. Check to be certain the selected sprocket has a listed maximum bore large enough to accommodate the specified shaft. The tables on pages E-158 thru E-159 gives maximum bores for the usual range of driving sprockets.

If the Design Horsepower at the required RPM is greater than the horsepower rating of the largest pitch chain which can operate at that speed, a multiple chain drive should be considered for the application.

Selection of drives to operate at speeds somewhat below the maximum rating will increase the life of the drive and quietness of operation.

Step V

Driving Sprocket

In selecting the driving sprocket **17 teeth are recommended as a minimum** although 15 teeth are quite often used, and as low as 7 teeth can be cut. When the maximum bore of the 17 tooth sprocket will not accommodate the driving shaft, it is necessary to go to a sprocket with a greater number of teeth. Hardened teeth are recommended for sprockets with 25 teeth or less.

Application Data and Selection Procedure

Step VI

Driven Sprocket (Ratio)

The number of teeth selected for the driven sprocket depends upon the driving sprocket chosen and the desired speed of the driven shaft. When space limitations are a factor, the diameter of the driven sprocket sometimes determines the final selection of drive.

The recommended maximum speed ratio is 7 to 1, although higher ratios are occasionally used. It is usually better design, however, for large reductions to use a double reduction drive.

Select the driven sprocket size from the Speed Ratio Table on page E-170 using the required speed ratio and size of driver sprocket.

Step VII

Shaft Centers

May be calculated from the formula on page E-168 where the sprocket diameters and chain length are known.

On many applications the motor base is adjustable, allowing for slight changes in shaft centers. On long centers some form of chain adjuster or take-up is recommended.

Step VIII

Chain Length

On page E-168 is shown a simple method of computing the length of chain necessary for a drive with given sprocket dimensions and center to center distance of shafts. (See chart on page E-169 for length in ft.)

Chain Drive Design Example

To select a roller chain drive from a 10 HP electric motor (1½" shaft) 1200 RPM (1150 under load) to a wood working machine shaft at 300 RPM on 30" centers. Drive conditions — moderate pulsating load, good lubrication, 10 hour day operation.

1. Service class — moderate shock load (Table I).
2. Service factor — 1.3 (Table II).
3. Design HP — $1.3 \times 10 = 13$ DHP.
4. Selection — The Horsepower Ratings on page E-184 show that either of the following combinations may be used.

No. D40-19 Tooth — Smoothest in operation

No. 50-18 Tooth — Lower drive cost

For our purpose we select No. 50 chain and checking the bore find that the 1½" shaft can be accommodated with a stock bored to size sprocket.

The driven sprocket is found as follows:

No. Teeth

Driven

$$\text{Sprocket} = 18 \times \frac{1150}{300} (\text{Ratio}) = 68.99 \text{ or } 69 \text{ Teeth}$$

Since 69 teeth is not a stock size we select 70 teeth. The chain length is calculated as shown on page E-169 and is 142 pitches.

Overhung Load

When a Sprocket is mounted on a reducer shaft, a calculation should be made to determine the overhung load in pounds using formula on page L-2 in general engineering section.

Engineering Data & Design

Horsepower — equals 33,000 foot pounds per minute, or 550 foot pounds per second. In terms of chain load and speed.

$$HP = \frac{\text{Working Load} \times \text{Ft. Per Min.}}{33,000}$$

$$\text{or } HP = \frac{\text{Working Load} \times T \times P \times \text{R.P.M.}}{396,000}$$

Where T = number of sprocket teeth
P = chain pitch

Chain Working Load — when the horsepower input is known and the chain working load is desired, this can be calculated as follows:

$$\text{Working Load} = \frac{HP \times 33,000}{\text{Ft. Per Min.}}$$

$$\text{or} = \frac{HP \times 396,000}{T \times P \times \text{R.P.M.}}$$

Chain Speed — can be determined from the following formula:

$$\text{Chain Speed (Ft. Per Min.)} = \frac{T \times \text{R.P.M.}}{K}$$

where T = number of sprocket teeth
Constant K (Pitches of Chain Per Foot)

PITCH	3/8"	1/2"	5/8"	3/4"	1"	1 1/4"	1 1/2"	1 3/4"	2"	2 1/2"	3"
K	32	24	19.2	16	12	9.6	8	6.85	6	4.8	4

Approx. Wt./Ft. of Standard Roller Chain

Number	Single	Double	Triple	Quadruple
25	.08	.18	.27	.35
35	.23	.46	.69	.92
41	.28	—	—	—
40	.41	.82	1.23	1.64
50	.69	1.38	2.07	2.76
60	1.04	2.08	3.12	4.16
80	1.77	3.54	5.31	7.08
100	2.59	5.18	7.77	10.36
120	4.05	8.10	12.15	16.20
140	5.10	10.20	15.30	20.40
160	6.85	13.70	20.55	27.40
180	9.30	18.20	27.20	36.30
200	10.20	21.00	31.50	42.00
240	16.90	33.40	50.00	66.50

Factor of Safety — is determined as follows:

$$F.S. = \frac{\text{Chain Ultimate Strength}}{\text{Chain Working Load}}$$

Shaft Torque — Ordinarily is greater for the driven shaft than for the driving shaft due to the difference in sprocket sizes and R.P.M. Torque is usually expressed in inch pounds.

$$\text{Torque (Driving Shaft)} = \frac{HP \times 63,000}{\text{R.P.M.}}$$

$$\text{Torque (Driven Shaft)} = \text{Working Load} \times R$$

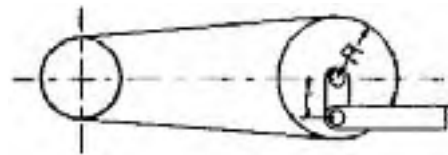

Where a crank arm is used the load transmitted by the arm can be determined as follows:

$$\text{Crank arm Load} = \frac{\text{Driven Shaft Torque}}{r}$$

$$\text{or} = \frac{\text{Chain Working Load} \times R}{r}$$

Catenary Tension — imposed by reason of the weight of chain can be approximated as follows:

$$\text{Catenary Tension} = \frac{W \times L^2}{8 \times S} + (W \times S)$$

where W = weight of chain (lbs. per ft.)
S = chain sag (feet) = 2% to 3% of shaft centers approx.
L = Shaft centers in feet.

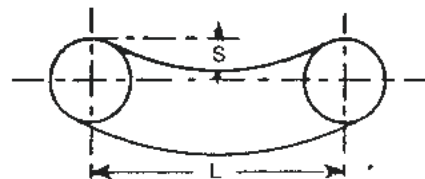

Engineering Data & Design

Conveyor Chains

Chains used in the design of conveyors should be selected on the basis of the **chain pull** imposed by the application and the permissible or **maximum working load** of the chain.

In some instances a larger pitch chain than is necessary may be selected due to the desired attachment spacing, and the effect in this case would be to increase the life of the conveyor.

HORIZONTAL CONVEYORS

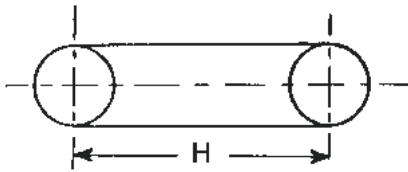

$$\text{Total pull of chains} = f H (W + P)$$

NOTE: When lower strand of conveyor drags on runway above formula becomes $f H (W + 2P)$.

VERTICAL CONVEYORS

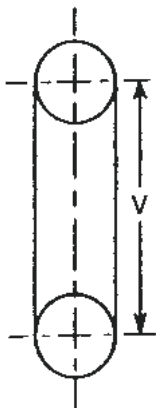

$$\text{Total pull of chains} = V (W + P)$$

- H (feet) = Horizontal projection of conveyor length.
- V (feet) = Vertical projection of conveyor length.
- W (pounds) = Weight of material handled per foot of conveyor length.
- P (pounds) = Weight per foot of all moving conveyor parts (single or two strand).
- f = Coefficient of friction of chain on runway.

Chain Pull

The force or pull required to move a conveyor includes the pull necessary to move the weight of chain and material and the frictional resistance of the chain parts on the runways. The following formulas may be used in calculating the total chain pull. The same formula applies in the case of single or parallel strand chain conveyors, but in the case of parallel strand conveyors, the pull per chain is one-half of the figure calculated from the formula.

INCLINED CONVEYORS

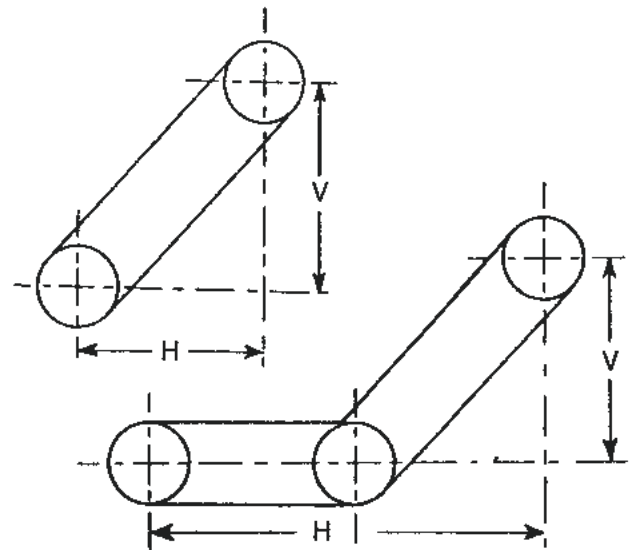

$$\text{Total pull of chains} = f H (W + P) + V (W + P)$$

NOTE: When lower strand of conveyor drags on runway the factor P ($f H - V$) should be added to above formula unless V is greater than $f H$.

Value of Coefficient F

Sliding steel on iron or steel	25%
Rolling friction	15%

(If material or other than the usual chain parts are in contact with the runway, the coefficient should be increased to compensate for the added resistance.)



Chain Drive Selection

Step 1:

Prime Driver:	_____	_____	_____
	Type & Description	Rated - H.P.	R.P.M.
Driven Comp:	_____	_____	_____
	Type & Description	R.P.M.	Hours/Day
Center Distance:	_____ "	_____ "	_____ "
	Maximum	Minimum	Nominal

Step 2: _____
 Service Classification (Step I Page E-162)

Step 3: _____ (Include additions to basic factor)
 Service Factor (Step II Page E-162)

Step 4: Determine Design H.P. _____ × _____ = _____
 H.P. Service Factor H.P. Design

Step 5: Speed Ratio _____ ÷ _____ = _____
 RPM Faster Shaft RPM Slower Shaft Ratio (E-172)

Step 6: From selector chart, select proper chain pitch & driver sprocket.
 (check *Martin* Catalog page E-184)

A. _____ B. _____
 Chain Pitch Driver Sprocket
 Maximum Bore
 (Pages E-16 thru E-112)

Step 7: From ratio chart, select proper driven sprocket.

C. _____
 Driven Sprocket Maximum Bore

Step 8: Check manufacturer's catalog for maximum bore recommended & final stock selection. (Pages E-16 thru E-112)

Step 9: Review Horsepower table for type of lubrication required.

TYPE: A B C (Pages E-161 and E-186 thru E-192)
 OR TYPE: 1 2 3 (Pages E-191 and E-192)

Step 10: _____ ÷ _____ = _____
 Center Dist. (inches) Chain Pitch Center Dist. (pitches)

Step 11: Formula for chain length = $2C + \frac{N+n}{2} + \frac{A}{C}$

Where:

- C = Center Dist. in pitches
- N = Number of teeth in Driven Sprocket
- n = Number of teeth in Driver Sprocket
- A = Value from table tabulated for N - n values

Brinell, Rockwell and Scleroscope Hardness Numbers with Corresponding Tensile Strength

Brinell 10 MM Ball 3,000 Kg.	Rockwell "C" 120 Cone 150 Kg.	Scleroscope Shore Model C	Tensile Strength 1000 Lb. Per Sq. In.
745	68	100	368
712	66	95	352
682	64	91	337
653	62	87	324
627	60	84	311
601	58	81	298
578	57	78	287
555	55	75	276
534	53	72	266
514	52	70	256
495	50	67	247
477	49	65	238
461	47	63	229
444	46	61	220
429	45	59	212
415	44	57	204
401	42	55	196
388	41	54	189
375	40	52	182
362	38	51	176
351	37	49	170
341	36	48	165
331	35	46	160
321	34	45	155
311	33	44	150
302	32	43	146
293	31	42	142
285	30	40	138
277	29	39	134
269	28	38	131
262	26	37	128
255	25	37	125
248	24	36	122
241	23	35	119
235	22	34	116
229	21	33	113
223	20	32	110
	Rockwell "B" 1/16" Ball 100 Kg.		
217	97	31	107
212	96	31	104
207	95	30	101
202	94	30	99
197	93	29	97
192	92	28	95
187	91	28	93
183	90	27	91
179	89	27	89
174	88	26	87

Note: Hardening cannot be accurately checked with a file — stationary or portable hardness testers should be used for conclusive results.

Material

All *Martin* stock sprockets are made of quality steel poured to our specifications.

Bar size sprockets normally include sizes up to 7" or 7½" in diameter type "B", "BS", "QD", "TB" single, double & triple width. And can easily be electrical induction or flame hardened — to Rockwell "C" 40 to 50.

Plate sprockets normally include sizes 7½" in diameter and larger type "B", "BS", "C", "QD", "TB" single, double, & triple width fabricated and type "A" all diameters. This material would have 35 to 40 points of carbon and can be induction or flame hardened to Rockwell "C" 30 to 45. Degree of hardness obtainable and method depends on size of sprocket.

Special quality steel can be used for large quantities or made-to-order sprockets if specified.

Hardening Recommendations

Hardened teeth substantially increases sprocket life and is recommended under conditions listed below:

1. Pinion or driver where the reduction is 4:1 or greater.
2. Slow speed drives (100 FPM or less).
3. Where safety factor is less than standard.
4. Unusual abrasive conditions.

Degree of hardness — this is governed by conditions prevailing each application — for stock sprockets these general suggestions may be used as guide lines:

1. Rockwell "C" 35 to 50 pinion or driver.
2. Rockwell "C" 25 to 40 larger diameter or driver sprockets.

Induction or flame hardening will be used as best suited to the individual application. The diameter and pitch of the sprocket govern the method used.

Caution should be used to avoid "file hardness" (Rockwell C 62 and above) as it is not recommended for sprockets due to brittleness.

Depth of hardening should be limited so as to provide case only on the wear surfaces with a tough resilient core to absorb shock — (see illustration tooth section).

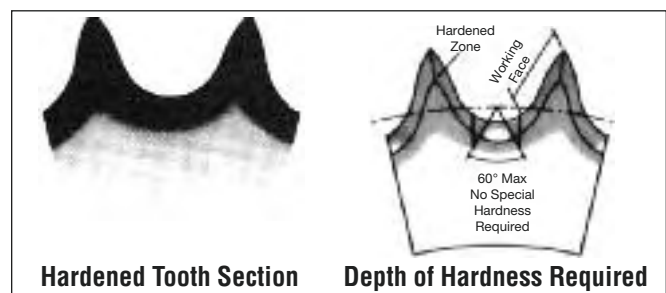



Chain Length Calculation

The following equation may be used to determine the chain length required for any two-sprocket drive.

$$L = 2C + \frac{N+n}{2} + \frac{.1013(N-n)^2}{4C} \quad \text{or substituting A for } \frac{.1013(N-n)^2}{4}, \quad L = 2C + \frac{N+n}{2} + \frac{A}{C}$$

where:

- C = Shaft Center Distance in pitches,
- L = Length of chain in pitches,
- N = Number of teeth in larger sprocket,
- n = Number of teeth in smaller sprocket,
- π = 3.1416,
- A = Value from table below tabulated for values of N-n,
- P = Pitch of chain.

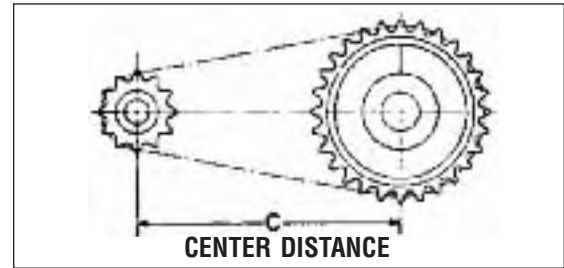

NOTE: The method described with above table of constants is sufficiently accurate for practically all commercial chain drives. When, however, a high degree of precision is necessary, especially if the drive is vertical, the following formula is useful in determining the exact centers for chain length already determined.

Calculation of shaft centers

The following formula is useful in determining the approximate centers in inches for chain lengths in pitches already determined.

$$C = \frac{P}{8} \left\{ 2L - N - n + \sqrt{(2L - N - n)^2 - 0.810(N - n)^2} \right\}$$

Values of A For Chain Length Calculation

N-n	A	N-n	A	N-n	A	N-n	A	N-n	A	N-n	A
1	.03	32	25.94	63	100.54	94	223.82	125	395.79	156	616.44
2	.10	33	27.58	64	103.75	95	228.61	126	402.14	157	624.37
3	.23	34	29.28	65	107.02	96	233.44	127	408.55	158	632.35
4	.41	35	31.03	66	110.34	97	238.33	128	415.01	159	640.38
5	.63	36	32.83	67	113.71	98	243.27	129	421.52	160	648.46
6	.91	37	34.68	68	117.13	99	248.26	130	428.08	161	656.59
7	1.24	38	36.58	69	120.60	100	253.30	131	434.69	162	664.77
8	1.62	39	38.53	70	124.12	101	258.39	132	441.36	163	673.00
9	2.05	40	40.53	71	127.69	102	263.54	133	448.07	164	681.28
10	2.53	41	42.58	72	131.31	103	268.73	134	454.83	165	689.62
11	3.06	42	44.68	73	134.99	104	273.97	135	461.64	166	698.00
12	3.65	43	46.84	74	138.71	105	279.27	136	468.51	167	706.44
13	4.28	44	49.04	75	142.48	106	284.67	137	475.42	168	714.92
14	4.96	45	51.29	76	146.31	107	290.01	138	482.39	169	723.46
15	5.70	46	53.60	77	150.18	108	295.45	139	489.41	170	732.05
16	6.48	47	55.95	78	154.11	109	300.95	140	496.47	171	740.68
17	7.32	48	58.36	79	158.09	110	306.50	141	503.59	172	749.37
18	8.21	49	60.82	80	162.11	111	312.09	142	510.76	173	758.11
19	9.14	50	63.33	81	166.19	112	317.74	143	517.98	174	766.90
20	10.13	51	65.88	82	170.32	113	323.44	144	525.25	175	775.74
21	11.17	52	68.49	83	174.50	114	329.19	145	532.57	176	784.63
22	12.26	53	71.15	84	178.73	115	334.99	146	539.94	177	793.57
23	13.40	54	73.86	85	183.01	116	340.84	147	547.36	178	802.57
24	14.59	55	76.62	86	187.34	117	346.75	148	554.83	179	811.61
25	15.83	56	79.44	87	191.73	118	352.70	149	562.36	180	820.70
26	17.12	57	82.30	88	196.16	119	358.70	150	569.93	181	829.85
27	18.47	58	85.21	89	200.64	120	364.76	151	577.56	182	839.04
28	19.86	59	88.17	90	205.18	121	370.86	152	585.23	183	848.29
29	21.30	60	91.19	91	209.76	122	377.02	153	592.96	184	857.58
30	22.80	61	94.25	92	214.40	123	383.22	154	600.73	185	866.93
31	24.34	62	97.37	93	219.08	124	389.48	155	608.56		



Chain Drive Engineering

Roller Chain Lengths

No. Of Pitches	CHAIN PITCH — INCHES										
	3/8	1/2	5/8	3/4	1	1 1/4	1 1/2	1 3/4	2	2 1/2	3
	CHAIN LENGTHS — FEET										
1	0.0313	0.0417	0.0521	0.0625	0.0833	0.1042	0.1250	0.1458	0.1667	0.2083	0.2500
2	.0625	.0833	.1042	.1250	.1667	.2083	.2500	.2917	.3333	.4167	.5000
3	.0938	.1250	.1563	.1875	.2500	.3125	.3750	.4375	.5000	.6250	.7500
4	.1250	.1667	.2083	.2500	.3333	.4167	.5000	.5833	.6667	.8333	1.0000
5	.1563	.2083	.2604	.3125	.4167	.5208	.6250	.7292	.8333	1.0417	1.2500
6	.1875	.2500	.3125	.3750	.5000	.6250	.7500	.8750	1.0000	1.2500	1.5000
7	.2188	.2917	.3646	.4375	.5833	.7292	.8750	1.0208	1.1667	1.4583	1.7500
8	.2500	.3333	.4167	.5000	.6667	.8333	1.0000	1.1667	1.3333	1.6667	2.0000
9	.2813	.3750	.4688	.5625	.7500	.9375	1.1250	1.3125	1.5000	1.8750	2.2500
10	.3125	.4167	.5208	.6250	.8333	1.0417	1.2500	1.4583	1.6667	2.0833	2.5000
11	.3438	.4584	.5729	.6875	.9167	1.1459	1.3750	1.6041	1.8333	2.2917	2.7500
12	.3750	.5000	.6250	.7500	1.0000	1.2500	1.5000	1.7500	2.0000	2.5000	3.0000
13	.4063	.5417	.6771	.8125	1.0833	1.3542	1.6250	1.8958	2.1667	2.7083	3.2500
14	.4375	.5833	.7292	.8750	1.1667	1.4583	1.7500	2.0417	2.3333	2.9167	3.5000
15	.4688	.6250	.7813	.9375	1.2500	1.5625	1.8750	2.1875	2.5000	3.1250	3.7500
16	.5000	.6667	.8333	1.0000	1.3333	1.6667	2.0000	2.3333	2.6667	3.3333	4.0000
17	.5313	.7084	.8854	1.0625	1.4167	1.7709	2.1250	2.4791	2.8333	3.5417	4.2500
18	.5625	.7500	.9375	1.1250	1.5000	1.8750	2.2500	2.6250	3.0000	3.7500	4.5000
19	.5938	.7917	.9896	1.1875	1.5833	1.9792	2.3750	2.7708	3.1667	3.9583	4.7500
20	.6250	.8333	1.0417	1.2500	1.6667	2.0833	2.5000	2.9167	3.3333	4.1667	5.0000
21	.6563	.8750	1.0938	1.3125	1.7500	2.1875	2.6250	3.0625	3.5000	4.3750	5.2500
22	.6875	.9167	1.1458	1.3750	1.8333	2.2917	2.7500	3.2083	3.6667	4.5833	5.5000
23	.7188	.9584	1.1979	1.4375	1.9166	2.3959	2.8750	3.3541	3.8333	4.7917	5.7500
24	.7500	1.0000	1.2500	1.5000	2.0000	2.5000	3.0000	3.5000	4.0000	5.0000	6.0000
25	.7813	1.0417	1.3021	1.5625	2.0833	2.6042	3.1250	3.6458	4.1667	5.2083	6.2500
26	.8125	1.0833	1.3541	1.6250	2.1667	2.7083	3.2500	3.7917	4.3333	5.3167	6.5000
27	.8438	1.1250	1.4062	1.6875	2.2500	2.8125	3.3750	3.9375	4.5000	5.6250	6.7500
28	.8750	1.1667	1.4583	1.7500	2.3333	2.9167	3.5000	4.0833	4.6667	5.8333	7.0000
29	.9063	1.2084	1.5104	1.8125	2.4167	3.0209	3.6250	4.2291	4.8333	6.0417	7.2500
30	.9375	1.2500	1.5625	1.8750	2.5000	3.1250	3.7500	4.3750	5.0000	6.2500	7.5000
31	.9688	1.2917	1.6146	1.9375	2.5833	3.2292	3.8750	4.5208	5.1667	6.4583	7.7500
32	1.0000	1.3333	1.6667	2.0000	2.6667	3.3333	4.0000	4.6667	5.3333	6.6667	8.0000
33	1.0313	1.3750	1.7188	2.0625	2.7500	3.4375	4.1250	4.8125	5.5000	6.8750	8.2500
34	1.0625	1.4167	1.7708	2.1250	2.8333	3.5417	4.2500	4.9583	5.6667	7.0833	8.5000
35	1.0938	1.4584	1.8229	2.1875	2.9167	3.6459	4.3750	5.1041	5.8333	7.2917	8.7500
36	1.1250	1.5000	1.8750	2.2500	3.0000	3.7500	4.5000	5.2500	6.0000	7.5000	9.0000
37	1.1563	1.5417	1.9271	2.3125	3.0833	3.8542	4.6250	5.3958	6.1667	7.7083	9.2500
38	1.1875	1.5833	1.9791	2.3750	3.1667	3.9583	4.7500	5.5417	6.3333	7.9167	9.5000
39	1.2188	1.6250	2.0312	2.4375	3.2500	4.0625	4.8750	5.0875	6.5000	8.1250	9.7500
40	1.2500	1.6667	2.0833	2.5000	3.3333	4.1667	5.0000	5.8333	6.6667	8.3333	10.0000
41	1.2813	1.7084	2.1354	2.5625	3.4167	4.2709	5.1250	5.9791	6.8333	8.5417	10.2500
42	1.3125	1.7500	2.1875	2.6250	3.5000	4.3750	5.2500	6.1250	7.0000	8.7500	10.5000
43	1.3438	1.7917	2.2396	2.6875	3.5833	4.4792	5.3750	6.2708	7.1667	8.9583	10.7500
44	1.3750	1.8333	2.2916	2.7500	3.6667	4.5833	5.5000	6.4167	7.3333	9.1667	11.0000
45	1.4063	1.8750	2.3437	2.8125	3.7500	4.6875	5.6250	6.5625	7.5000	9.3750	11.2500
46	1.4375	1.9167	2.3958	2.8750	3.8333	4.7917	5.7500	6.7083	7.6667	9.5833	11.5000
47	1.4688	1.9584	2.4479	2.9375	3.9167	4.8959	5.8750	6.8541	7.8333	9.7917	11.7500
48	1.5000	2.0000	2.5000	3.0000	4.0000	5.0000	6.0000	7.0000	8.0000	10.0000	12.0000
49	1.5313	2.0417	2.5521	3.0625	4.0833	5.1042	6.1250	7.1458	8.1667	10.0283	12.2500
50	1.5625	2.0833	2.6042	3.1250	4.1667	5.2083	6.2500	7.2917	8.3333	10.4167	12.5000
51	1.5938	2.1250	2.6563	3.1875	4.2500	5.3125	6.3750	7.4375	8.5000	10.6250	12.7500
52	1.6250	2.1667	2.7083	3.2500	4.3333	5.4167	6.5000	7.5833	8.6667	10.8333	13.0000
53	1.6563	2.2084	2.7604	3.3125	4.4167	5.5209	6.6250	7.7291	8.8333	11.0417	13.2500
54	1.6875	2.2500	2.8125	3.3750	4.5000	5.6250	6.7500	7.8750	9.0000	11.2500	13.5000
55	1.7188	2.2917	2.8647	3.4375	4.5833	5.7292	6.8750	8.0208	9.1667	11.4583	13.7500
56	1.7500	2.3333	2.9167	3.5000	4.6667	5.8333	7.0000	8.1667	9.3333	11.6667	14.0000
57	1.7813	2.3750	2.9688	3.5625	4.7500	5.9375	7.1250	8.3125	9.5000	11.8750	14.2500
58	1.8125	2.4167	3.0208	3.6250	4.8333	6.0417	7.2500	8.4583	9.6667	12.0833	14.5000
59	1.8438	2.4584	3.0729	3.6875	4.9167	6.1459	7.3750	8.6041	9.8333	12.2917	14.7500
60	1.8750	2.5000	3.1250	3.7500	5.0000	6.2500	7.5000	8.7500	10.0000	12.5000	15.0000
61	1.9063	2.5417	3.1771	3.8125	5.0833	6.3542	7.6250	8.8958	10.1667	12.7083	15.2500
62	1.9375	2.5833	3.2292	3.8750	5.1667	6.4583	7.7500	9.0417	10.3333	12.9167	15.5000
63	1.9688	2.6250	3.2813	3.9375	5.2500	6.5625	7.8750	9.1875	10.5000	13.1250	15.7500
64	2.0000	2.6667	3.3333	4.0000	5.3333	6.6667	8.0000	9.3333	10.6667	13.3333	16.0000
65	2.0313	2.7084	3.3854	4.0625	5.4167	6.7709	8.1250	9.4791	10.8333	13.5417	16.2500
66	2.0625	2.7500	3.4375	4.1250	5.5000	6.8750	8.2500	9.6250	11.0000	13.7500	16.5000
67	2.0938	2.7917	3.4897	4.1875	5.5833	6.9792	8.3750	9.7708	11.1667	13.9583	16.7500
68	2.1250	2.8333	3.5417	4.2500	5.6667	7.0833	8.5000	9.9167	11.3333	14.1667	17.0000
69	2.1563	2.8750	3.5938	4.3125	5.7500	7.1875	8.6250	10.0625	11.5000	14.3750	17.2500
70	2.1875	2.9167	3.6458	4.3750	5.8333	7.2917	8.7500	10.2083	11.6667	14.5833	17.5000
71	2.2188	2.9584	3.6979	4.4375	5.9167	7.3959	8.8750	10.3541	11.8333	14.7917	17.7500
72	2.2500	3.0000	3.7500	4.5000	6.0000	7.5000	9.0000	10.5000	12.0000	15.0000	18.0000
73	2.2813	3.0417	3.8021	4.5625	6.0833	7.6042	9.1250	10.6458	12.1667	15.2083	18.2500
74	2.3125	3.0833	3.8541	4.6250	6.1667	7.7083	9.2500	10.7917	12.3333	15.4167	18.5000
75	2.3438	3.1250	3.9062	4.6875	6.2500	7.8125	9.3750	10.9375	12.5000	15.6250	18.7500
80	2.5000	3.3333	4.1667	5.0000	6.6667	8.3333	10.0000	11.6667	13.3333	16.6667	20.0000
85	2.6563	3.5417	4.4271	5.3125	7.0833	8.8542	10.6250	12.3958	14.1667	17.7083	21.2500
90	2.8125	3.7500	4.6875	5.6250	7.5000	9.3750	11.2500	13.1250	15.0000	18.7500	22.5000
95	2.9688	3.9584	4.9479	5.9375	7.9167	9.8959	11.8750	13.8541	15.8333	19.7917	23.7500
100	3.1250	4.1667	5.2083	6.2500	8.3333	10.4167	12.5000	14.5833	16.6667	20.8333	25.0000

SPROCKETS



Speed Ratios For Sprocket Combinations Driver Sprocket Teeth

SPROCKETS

	9	10	11	12	13	14	15	16	17	18	19	20	21	22	23	24	25	26
9	1.00																	
10	1.11	1.00																
11	1.22	1.10	1.00															
12	1.33	1.20	1.09	1.00														
13	1.44	1.30	1.18	1.08	1.00													
14	1.56	1.40	1.27	1.17	1.08	1.00												
15	1.67	1.50	1.36	1.25	1.15	1.07	1.00											
16	1.78	1.60	1.45	1.33	1.23	1.14	1.07	1.00										
17	1.89	1.70	1.55	1.42	1.31	1.21	1.13	1.06	1.00									
18	2.00	1.80	1.64	1.50	1.38	1.29	1.20	1.13	1.06	1.00								
19	2.11	1.90	1.73	1.58	1.46	1.36	1.27	1.19	1.12	1.06	1.00							
20	2.22	2.00	1.82	1.67	1.54	1.43	1.33	1.25	1.18	1.11	1.05	1.00						
21	2.33	2.10	1.91	1.75	1.61	1.50	1.40	1.31	1.23	1.17	1.10	1.05	1.00					
22	2.44	2.20	2.00	1.83	1.69	1.57	1.47	1.38	1.29	1.22	1.16	1.10	1.05	1.00				
23	2.56	2.30	2.09	1.92	1.77	1.64	1.53	1.44	1.35	1.28	1.21	1.15	1.09	1.04	1.00			
24	2.67	2.40	2.18	2.00	1.85	1.71	1.60	1.50	1.41	1.33	1.26	1.20	1.14	1.09	1.04	1.00		
25	2.78	2.50	2.27	2.08	1.92	1.79	1.67	1.56	1.47	1.39	1.32	1.25	1.19	1.14	1.09	1.04	1.00	
26	2.89	2.60	2.36	2.17	2.00	1.86	1.73	1.63	1.53	1.45	1.37	1.30	1.24	1.18	1.13	1.08	1.04	1.00
27	3.00	2.70	2.45	2.25	2.08	1.93	1.80	1.69	1.59	1.50	1.42	1.35	1.29	1.23	1.17	1.12	1.08	1.04
28	3.11	2.80	2.54	2.33	2.15	2.00	1.87	1.75	1.65	1.56	1.47	1.40	1.33	1.27	1.22	1.17	1.12	1.08
29	3.22	2.90	2.64	2.42	2.23	2.07	1.93	1.81	1.71	1.61	1.53	1.45	1.38	1.32	1.26	1.21	1.16	1.12
30	3.33	3.00	2.73	2.50	2.31	2.14	2.00	1.88	1.76	1.67	1.58	1.50	1.43	1.36	1.31	1.25	1.20	1.15
31	3.44	3.10	2.82	2.58	2.38	2.21	2.07	1.94	1.82	1.72	1.63	1.55	1.48	1.41	1.35	1.29	1.24	1.19
32	3.56	3.20	2.91	2.67	2.46	2.28	2.13	2.00	1.88	1.78	1.68	1.60	1.52	1.45	1.39	1.33	1.28	1.23
33	3.67	3.30	3.00	2.75	2.54	2.36	2.20	2.06	1.94	1.83	1.74	1.65	1.57	1.50	1.43	1.38	1.32	1.27
34	3.78	3.40	3.09	2.83	2.62	2.43	2.27	2.13	2.00	1.89	1.79	1.70	1.62	1.55	1.48	1.42	1.36	1.31
35	3.89	3.50	3.18	2.92	2.69	2.50	2.33	2.19	2.06	1.95	1.84	1.75	1.67	1.59	1.52	1.46	1.40	1.34
36	4.00	3.60	3.27	3.00	2.77	2.57	2.40	2.25	2.12	2.00	1.89	1.80	1.71	1.63	1.57	1.50	1.44	1.38
37	4.11	3.70	3.36	3.08	2.85	2.64	2.47	2.31	2.18	2.06	1.95	1.85	1.76	1.68	1.61	1.54	1.48	1.42
38	4.22	3.80	3.45	3.17	2.92	2.71	2.53	2.38	2.24	2.11	2.00	1.90	1.81	1.73	1.65	1.58	1.52	1.46
39	4.33	3.90	3.55	3.25	3.00	2.79	2.60	2.44	2.29	2.17	2.05	1.95	1.86	1.77	1.70	1.63	1.56	1.50
40	4.44	4.00	3.64	3.33	3.08	2.86	2.67	2.50	2.35	2.22	2.10	2.00	1.90	1.82	1.74	1.67	1.60	1.54
41	4.56	4.10	3.73	3.42	3.15	2.93	2.73	2.56	2.41	2.28	2.16	2.05	1.95	1.86	1.78	1.71	1.64	1.58
42	4.67	4.20	3.82	3.50	3.23	3.00	2.80	2.63	2.47	2.34	2.21	2.10	2.00	1.91	1.83	1.75	1.68	1.61
43	4.78	4.30	3.91	3.58	3.31	3.07	2.87	2.69	2.53	2.39	2.26	2.15	2.05	1.95	1.87	1.79	1.72	1.65
44	4.89	4.40	4.00	3.67	3.39	3.14	2.93	2.75	2.59	2.44	2.32	2.20	2.10	2.00	1.91	1.83	1.76	1.69
45	5.00	4.50	4.09	3.75	3.46	3.21	3.00	2.81	2.65	2.50	2.37	2.25	2.14	2.04	1.96	1.88	1.80	1.73
46	5.11	4.60	4.18	3.83	3.54	3.29	3.07	2.88	2.71	2.56	2.42	2.30	2.19	2.09	2.00	1.92	1.84	1.77
47	5.22	4.70	4.27	3.92	3.62	3.36	3.13	2.94	2.76	2.61	2.47	2.35	2.24	2.14	2.04	1.96	1.88	1.81
48	5.33	4.80	4.36	4.00	3.69	3.43	3.20	3.00	2.82	2.67	2.52	2.40	2.28	2.18	2.09	2.00	1.92	1.84
49	5.44	4.90	4.45	4.08	3.77	3.50	3.27	3.06	2.88	2.72	2.58	2.45	2.33	2.23	2.13	2.04	1.96	1.88
50	5.56	5.00	4.55	4.17	3.85	3.57	3.33	3.13	2.94	2.78	2.63	2.50	2.38	2.27	2.17	2.08	2.00	1.92
51	5.67	5.10	4.64	4.25	3.92	3.64	3.40	3.19	3.00	2.83	2.68	2.55	2.43	2.32	2.22	2.13	2.04	1.96
52	5.78	5.20	4.73	4.33	4.00	3.71	3.47	3.25	3.06	2.89	2.74	2.60	2.48	2.36	2.26	2.17	2.08	2.00
53	5.89	5.30	4.82	4.42	4.08	3.79	3.53	3.31	3.12	2.94	2.79	2.65	2.52	2.41	2.30	2.21	2.12	2.04
54	6.00	5.40	4.91	4.50	4.15	3.86	3.60	3.38	3.18	3.00	2.84	2.70	2.57	2.45	2.35	2.25	2.16	2.07
55	6.11	5.50	5.00	4.58	4.23	3.93	3.67	3.44	3.24	3.06	2.90	2.75	2.62	2.50	2.39	2.29	2.20	2.12
56	6.22	5.60	5.09	4.67	4.31	4.00	3.73	3.50	3.29	3.11	2.95	2.80	2.67	2.55	2.43	2.33	2.24	2.15
57	6.33	5.70	5.18	4.75	4.38	4.07	3.80	3.56	3.35	3.17	3.00	2.85	2.71	2.59	2.48	2.38	2.28	2.19
58	6.44	5.80	5.27	4.83	4.46	4.14	3.87	3.63	3.41	3.22	3.05	2.90	2.76	2.64	2.52	2.42	2.32	2.23
59	6.56	5.90	5.36	4.92	4.54	4.21	3.93	3.69	3.47	3.28	3.11	2.95	2.81	2.68	2.57	2.46	2.36	2.27
60	6.67	6.00	5.45	5.00	4.61	4.28	4.00	3.75	3.53	3.34	3.16	3.00	2.86	2.72	2.61	2.50	2.40	2.30
68	7.55	6.80	6.18	5.66	5.23	4.86	4.54	4.25	4.00	3.78	3.58	3.40	3.24	3.09	2.96	2.84	2.72	2.61
70	7.78	7.00	6.36	5.83	5.38	5.00	4.67	4.38	4.12	3.89	3.68	3.50	3.33	3.18	3.05	2.92	2.80	2.69
72	8.00	7.20	6.54	6.00	5.54	5.14	4.80	4.50	4.24	4.00	3.79	3.60	3.43	3.27	3.13	3.00	2.88	2.77
76			6.91	6.33	5.84	5.43	5.07	4.75	4.47	4.23	4.00	3.80	3.62	3.45	3.31	3.17	3.04	2.92
80			7.27	6.66	6.15	5.71	5.34	5.00	4.70	4.45	4.21	4.00	3.81	3.63	3.48	3.34	3.20	3.07
84					6.46	6.00	5.60	5.25	4.94	4.67	4.42	4.20	4.00	3.81	3.65	3.50	3.36	3.23
95					7.31	6.78	6.33	5.94	5.59	5.28	5.00	4.75	4.52	4.32	4.13	3.96	3.80	3.65
96					7.38	6.85	6.40	6.00	5.64	5.34	5.05	4.80	4.57	4.36	4.18	4.00	3.84	3.69
102						7.28	6.80	6.38	6.00	5.67	5.37	5.10	4.86	4.63	4.44	4.25	4.08	3.92
112								7.00	6.59	6.23	5.89	5.60	5.33	5.08	4.87	4.67	4.48	4.30

Martin stock sprockets in pitches No. 40 through No. 100 are available with 8 to 60 teeth inclusive and in all common larger sizes for all pitches.



Sprocket Diameters

No. 25 1/4" Pitch

ROLLER CHAIN SPROCKET DIAMETERS

No. Teeth	Pitch Diameter	Outside Diameter	Caliper Diameter	No. Teeth	Pitch Diameter	Outside Diameter	Caliper Diameter	No. Teeth	Pitch Diameter	Outside Diameter	Caliper Diameter
6	.500	.583	.370	71	5.652	5.796	5.521	136	10.823	10.970	10.693
7	.576	.669	.432	72	5.732	5.876	5.602	137	10.903	11.050	10.772
8	.653	.754	.523	73	5.811	5.956	5.680	138	10.983	11.130	10.853
9	.731	.837	.591	74	5.891	6.035	5.761	139	11.062	11.209	10.932
10	.809	.919	.679	75	5.970	6.115	5.839	140	11.142	11.289	11.012
11	.887	1.002	.748	76	6.050	6.195	5.920	141	11.221	11.369	11.091
12	.966	1.083	.836	77	6.129	6.274	5.998	142	11.301	11.448	11.171
13	1.045	1.167	.907	78	6.209	6.354	6.079	143	11.380	11.528	11.250
14	1.124	1.246	.994	79	6.288	6.433	6.157	144	11.460	11.607	11.330
15	1.203	1.326	1.066	80	6.368	6.513	6.238	145	11.540	11.687	11.409
16	1.282	1.407	1.152	81	6.448	6.593	6.317	146	11.619	11.767	11.489
17	1.361	1.487	1.225	82	6.527	6.672	6.397	147	11.699	11.846	11.568
18	1.440	1.568	1.310	83	6.607	6.752	6.476	148	11.779	11.926	11.649
19	1.519	1.648	1.383	84	6.686	6.832	6.556	149	11.858	12.005	11.727
20	1.598	1.729	1.468	85	6.766	6.911	6.635	150	11.938	12.084	11.807
21	1.678	1.809	1.543	86	6.845	6.991	6.715	151	12.017	12.164	11.886
22	1.757	1.889	1.627	87	6.925	7.070	6.794	152	12.097	12.244	11.966
23	1.836	1.969	1.702	88	7.004	7.150	6.874	153	12.176	12.323	12.045
24	1.915	2.049	1.785	89	7.084	7.230	6.953	154	12.256	12.403	12.125
25	1.995	2.129	1.861	90	7.164	7.309	7.034	155	12.335	12.482	12.204
26	2.074	2.209	1.944	91	7.243	7.389	7.112	156	12.415	12.562	12.284
27	2.154	2.289	2.020	92	7.323	7.468	7.193	157	12.494	12.641	12.363
28	2.233	2.369	2.103	93	7.402	7.548	7.271	158	12.574	12.721	12.444
29	2.312	2.449	2.179	94	7.482	7.628	7.352	159	12.654	12.801	12.523
30	2.392	2.529	2.262	95	7.561	7.707	7.430	160	12.733	12.881	12.603
31	2.471	2.609	2.338	96	7.641	7.787	7.511	161	12.813	12.960	12.682
32	2.551	2.688	2.421	97	7.720	7.866	7.589	162	12.893	13.039	12.762
33	2.630	2.768	2.497	98	7.800	7.946	7.670	163	12.972	13.119	12.841
34	2.710	2.848	2.580	99	7.880	8.026	7.749	164	13.051	13.199	12.921
35	2.789	2.928	2.656	100	7.959	8.105	7.829	165	13.131	13.278	13.000
36	2.869	3.008	2.739	101	8.039	8.185	7.908	166	13.211	13.357	13.080
37	2.948	3.087	2.815	102	8.118	8.264	7.988	167	13.290	13.437	13.159
38	3.028	3.167	2.898	103	8.198	8.344	8.067	168	13.370	13.517	13.239
39	3.107	3.247	2.975	104	8.277	8.424	8.147	169	13.450	13.597	13.318
40	3.187	3.327	3.057	105	8.357	8.503	8.226	170	13.529	13.676	13.398
41	3.266	3.406	3.134	106	8.437	8.583	8.307	171	13.608	13.756	13.477
42	3.346	3.486	3.216	107	8.516	8.662	8.385	172	13.688	13.835	13.558
43	3.425	3.566	3.293	108	8.596	8.742	8.466	173	13.768	13.915	13.637
44	3.505	3.646	3.375	109	8.675	8.822	8.544	174	13.847	13.995	13.717
45	3.584	3.725	3.452	110	8.755	8.901	8.625	175	13.927	14.074	13.796
46	3.664	3.805	3.534	111	8.834	8.981	8.703	176	14.006	14.154	13.876
47	3.743	3.885	3.611	112	8.914	9.060	8.784	177	14.086	14.233	13.955
48	3.823	3.964	3.693	113	8.994	9.140	8.863	178	14.166	14.313	14.035
49	3.902	4.044	3.770	114	9.073	9.220	8.943	179	14.245	14.392	14.114
50	3.982	4.124	3.852	115	9.153	9.299	9.022	180	14.325	14.472	14.195
51	4.061	4.203	3.929	116	9.232	9.379	9.102	181	14.404	14.551	14.273
52	4.141	4.283	4.011	117	9.312	9.458	9.181	182	14.484	14.631	14.353
53	4.220	4.363	4.088	118	9.391	9.538	9.261	183	14.564	14.711	14.433
54	4.300	4.442	4.170	119	9.471	9.618	9.340	184	14.643	14.790	14.513
55	4.379	4.522	4.247	120	9.550	9.697	9.420	185	14.722	14.870	14.591
56	4.459	4.602	4.329	121	9.630	9.777	9.499	186	14.803	14.949	14.672
57	4.538	4.681	4.407	122	9.709	9.856	9.579	187	14.882	15.029	14.751
58	4.618	4.761	4.488	123	9.789	9.936	9.658	188	14.961	15.109	14.831
59	4.697	4.841	4.566	124	9.869	10.016	9.739	189	15.041	15.188	14.910
60	4.777	4.920	4.647	125	9.949	10.095	9.818	190	15.120	15.268	14.990
61	4.857	5.000	4.725	126	10.028	10.175	9.898	191	15.200	15.347	15.069
62	4.936	5.080	4.806	127	10.108	10.255	9.977	192	15.279	15.427	15.149
63	5.016	5.159	4.884	128	10.187	10.334	10.057	193	15.359	15.507	15.228
64	5.095	5.239	4.965	129	10.267	10.414	10.136	194	15.439	15.586	15.308
65	5.175	5.319	5.044	130	10.346	10.493	10.216	195	15.518	15.666	15.387
66	5.254	5.398	5.124	131	10.426	10.573	10.295	196	15.598	15.745	15.467
67	5.334	5.478	5.203	132	10.505	10.652	10.375	197	15.678	15.824	15.547
68	5.413	5.558	5.283	133	10.585	10.732	10.454	198	15.757	15.904	15.626
69	5.493	5.637	5.362	134	10.664	10.811	10.534	199	15.837	15.984	15.706
70	5.572	5.717	5.442	135	10.744	10.891	10.613	200	15.916	16.064	15.786

SPROCKETS

Odd tooth "bottom diameters" equal pitch diameters minus .130".

No. 35
3/8" Pitch

**Sprocket
Diameters**

Martin

ROLLER CHAIN SPROCKET DIAMETERS

No. Teeth	Pitch Diameter	Outside Diameter	Caliper Diameter	No. Teeth	Pitch Diameter	Outside Diameter	Caliper Diameter	No. Teeth	Pitch Diameter	Outside Diameter	Caliper Diameter
5	.638	.741	.407	71	8.478	8.694	8.276	136	16.235	16.456	16.035
6	.750	.875	.550	72	8.597	8.814	8.397	137	16.355	16.575	16.154
7	.864	1.004	.643	73	8.717	8.933	8.514	138	16.474	16.695	16.274
8	9.80	1.130	.780	74	8.836	9.053	8.636	139	16.593	16.814	16.392
9	1.097	1.256	.880	75	8.955	9.172	8.753	140	16.713	16.934	16.513
10	1.214	1.379	1.014	76	9.074	9.292	8.874	141	16.832	17.053	16.631
11	1.331	1.502	1.117	77	9.194	9.411	8.992	142	16.952	17.172	16.752
12	1.449	1.625	1.249	78	9.313	9.531	9.113	143	17.071	17.292	16.870
13	1.567	1.746	1.356	79	9.432	9.650	9.231	144	17.190	17.411	16.990
14	1.685	1.868	1.485	80	9.552	9.770	9.352	145	17.309	17.531	17.108
15	1.804	1.989	1.594	81	9.671	9.889	9.469	146	17.429	17.650	17.229
16	1.922	2.110	1.722	82	9.791	10.008	9.591	147	17.548	17.769	17.347
17	2.041	2.231	1.832	83	9.910	10.128	9.708	148	17.667	17.889	17.467
18	2.160	2.352	1.960	84	10.029	10.247	9.829	149	17.787	18.008	17.586
19	2.279	2.472	2.071	85	10.148	10.367	9.947	150	17.906	18.128	17.706
20	2.397	2.593	2.197	86	10.268	10.486	10.068	151	18.026	18.247	17.825
21	2.516	2.713	2.309	87	10.387	10.605	10.285	152	18.145	18.366	17.945
22	2.635	2.833	2.435	88	10.506	10.725	10.306	153	18.264	18.486	18.063
23	2.754	2.954	2.548	89	10.626	10.844	10.424	154	18.384	18.605	18.184
24	2.873	3.074	2.673	90	10.745	10.964	10.545	155	18.503	18.724	18.302
25	2.992	3.194	2.786	91	10.865	11.083	10.663	156	18.623	18.844	18.423
26	3.111	3.314	2.911	92	10.934	11.202	10.784	157	18.742	18.963	18.541
27	3.230	3.434	3.025	93	11.103	11.322	10.902	158	18.861	19.082	18.661
28	3.349	3.553	3.149	94	11.223	11.441	11.023	159	18.981	19.202	18.780
29	3.468	3.673	3.263	95	11.342	11.561	11.140	160	19.100	19.321	18.900
30	3.588	3.793	3.388	96	11.461	11.680	11.261	161	19.219	19.440	19.018
31	3.707	3.913	3.502	97	11.581	11.799	11.379	162	19.338	19.560	19.138
32	3.826	4.032	3.626	98	11.700	11.919	11.500	163	19.458	19.679	19.257
33	3.945	4.152	3.741	99	11.819	12.038	11.618	164	19.577	19.799	19.377
34	4.064	4.272	3.864	100	11.939	12.158	11.739	165	19.697	19.918	19.496
35	4.184	4.392	3.979	101	12.058	12.277	11.856	166	19.816	20.037	19.616
36	4.303	4.511	4.103	102	12.177	12.396	11.977	167	19.935	20.090	19.734
37	4.422	4.631	4.218	103	12.297	12.516	12.095	168	20.055	20.276	19.855
38	4.541	4.751	4.341	104	12.416	12.635	12.216	169	20.174	20.396	19.973
39	4.661	4.870	4.457	105	12.536	12.755	12.334	170	20.294	20.515	20.094
40	4.780	4.990	4.580	106	12.655	12.874	12.455	171	20.413	20.634	20.212
41	4.899	5.109	4.695	107	12.774	12.993	12.573	172	20.532	20.754	20.332
42	5.018	5.229	4.818	108	12.893	13.113	12.693	173	20.652	20.873	20.451
43	5.138	5.349	4.934	109	13.013	13.232	12.811	174	20.771	20.993	20.571
44	5.257	5.468	5.057	110	13.132	13.352	12.932	175	20.890	21.112	20.689
45	5.376	5.588	5.173	111	13.251	13.471	13.050	176	21.010	21.231	20.810
46	5.495	5.707	5.295	112	13.371	13.590	13.171	177	21.129	21.351	20.928
47	5.615	5.827	5.411	113	13.490	13.710	13.289	178	21.248	21.470	21.048
48	5.734	5.946	5.534	114	13.610	13.829	13.410	179	21.368	21.589	21.167
49	5.853	6.066	5.650	115	13.729	13.949	13.528	180	21.487	21.709	21.287
50	5.972	6.186	5.772	116	13.848	14.068	13.648	181	21.606	21.828	21.406
51	6.092	6.305	5.889	117	13.968	14.187	13.766	182	21.726	21.948	21.526
52	6.211	6.425	6.011	118	14.087	14.307	13.887	183	21.845	22.067	21.644
53	6.330	6.544	6.127	119	14.206	14.426	14.005	184	21.965	22.186	21.765
54	6.449	6.663	6.249	120	14.326	14.546	14.126	185	22.084	22.306	21.883
55	6.569	6.783	6.366	121	14.445	14.665	14.244	186	22.203	22.425	22.003
56	6.688	6.903	6.488	122	14.564	14.784	14.364	187	22.323	22.544	22.122
57	6.807	7.022	6.605	123	14.684	14.904	14.482	188	22.442	22.664	22.242
58	6.927	7.142	6.727	124	14.803	15.023	14.603	189	22.561	22.783	22.360
59	7.046	7.261	6.843	125	14.922	15.143	14.721	190	22.681	22.902	22.481
60	7.165	7.380	6.965	126	15.042	15.262	14.842	191	22.800	23.022	22.599
61	7.285	7.500	7.082	127	15.161	15.381	14.960	192	22.919	23.141	22.719
62	7.404	7.619	7.204	128	15.281	15.501	15.081	193	23.039	23.261	22.838
63	7.523	7.739	7.321	129	15.400	15.620	15.199	194	23.158	23.380	22.958
64	7.643	7.859	7.443	130	15.519	15.740	15.319	195	23.277	23.499	23.177
65	7.762	7.978	7.560	131	15.639	15.859	15.437	196	23.397	23.619	23.197
66	7.881	8.097	7.681	132	15.758	15.978	15.558	197	23.516	23.738	23.315
67	8.001	8.217	7.798	133	15.877	16.098	15.676	198	23.636	23.858	23.436
68	8.120	8.336	7.920	134	15.996	16.217	15.796	199	23.755	23.977	23.554
69	8.239	8.456	8.037	135	16.116	16.337	15.915	200	23.874	24.096	23.674
70	8.358	8.575	8.158								

SPROCKETS



Sprocket Diameters

No. 40 1/2" Pitch

ROLLER CHAIN SPROCKET DIAMETERS

No. Teeth	Pitch Diameter	Outside Diameter	Caliper Diameter	No. Teeth	Pitch Diameter	Outside Diameter	Caliper Diameter	No. Teeth	Pitch Diameter	Outside Diameter	Caliper Diameter
5	.851	.988	.497	71	11.304	11.592	10.988	136	21.647	21.941	21.334
6	1.000	1.166	.688	72	11.463	11.752	11.151	137	21.806	22.100	21.492
7	1.152	1.338	.812	73	11.622	11.911	11.306	138	21.965	22.259	21.653
8	1.307	1.507	.995	74	11.781	12.070	11.468	139	22.124	22.419	21.810
9	1.462	1.674	1.127	75	11.940	12.229	11.625	140	22.284	22.578	21.971
10	1.618	1.839	1.305	76	12.099	12.389	11.786	141	22.442	22.737	22.129
11	1.775	2.003	1.444	77	12.258	12.548	11.943	142	22.602	22.896	22.289
12	1.932	2.166	1.614	78	12.417	12.707	12.105	143	22.761	23.055	22.447
13	2.089	2.328	1.761	79	12.576	12.866	12.261	144	22.920	23.214	22.607
14	2.247	2.490	1.934	80	12.736	13.026	12.423	145	23.079	23.374	22.765
15	2.405	2.652	2.079	81	12.895	13.185	12.580	146	23.238	23.533	22.926
16	2.563	2.814	2.250	82	13.054	13.344	12.742	147	23.398	23.692	23.088
17	2.721	2.974	2.397	83	13.213	13.503	12.898	148	23.557	23.851	23.244
18	2.879	3.136	2.567	84	13.372	13.663	13.059	149	23.716	24.010	23.402
19	3.038	3.292	2.715	85	13.531	13.822	13.216	150	23.875	24.170	23.562
20	3.196	3.457	2.883	86	13.690	13.981	13.373	151	24.034	24.329	23.720
21	3.355	3.618	3.033	87	13.849	14.140	13.534	152	24.193	24.488	23.880
22	3.513	3.778	3.201	88	14.009	14.299	13.696	153	24.352	24.647	24.038
23	3.672	3.938	3.351	89	14.168	14.459	13.853	154	24.512	24.806	24.199
24	3.831	4.098	3.518	90	14.327	14.618	14.014	155	24.672	24.965	24.357
25	3.989	4.258	3.669	91	14.486	14.777	14.171	156	24.830	25.124	24.517
26	4.148	4.418	3.835	92	14.645	14.936	14.332	157	24.989	25.284	24.675
27	4.307	4.578	3.987	93	14.804	15.096	14.489	158	24.148	25.443	24.835
28	4.465	4.738	4.153	94	14.963	15.255	14.651	159	25.307	25.602	24.993
29	4.625	4.898	4.305	95	15.122	15.414	14.808	160	25.466	25.761	25.154
30	4.783	5.057	4.471	96	15.282	15.573	14.969	161	25.625	25.920	25.312
31	4.942	5.217	4.623	97	15.441	15.732	15.126	162	25.785	26.080	25.472
32	5.101	5.376	4.788	98	15.600	15.892	15.287	163	25.944	26.239	25.630
33	5.260	5.536	4.941	99	15.759	16.051	15.445	164	26.103	26.398	25.790
34	5.419	5.696	5.107	100	15.918	16.210	15.605	165	26.262	26.557	25.948
35	5.578	5.856	5.260	101	16.077	16.369	15.763	166	26.421	26.716	26.109
36	5.737	6.015	5.425	102	16.236	16.528	15.924	167	26.581	26.876	26.266
37	5.896	6.174	5.578	103	16.395	16.688	16.081	168	26.739	27.035	26.427
38	6.055	6.334	5.742	104	16.555	16.847	16.242	169	26.899	27.194	26.585
39	6.214	6.494	5.896	105	16.714	17.006	16.399	170	27.058	27.353	26.745
40	6.373	6.653	6.061	106	16.873	17.165	16.561	171	27.217	27.512	26.903
41	6.532	6.812	6.214	107	17.032	17.324	16.717	172	27.376	27.671	27.063
42	6.691	6.972	6.379	108	17.191	17.484	16.878	173	27.535	27.831	27.221
43	6.850	7.132	6.532	109	17.351	17.643	17.036	174	27.694	27.990	27.382
44	7.009	7.291	6.696	110	17.509	17.802	17.197	175	27.854	28.149	27.540
45	7.168	7.450	6.851	111	17.668	17.962	17.304	176	28.013	28.308	27.700
46	7.327	7.609	7.014	112	17.827	18.121	17.515	177	28.172	28.467	27.858
47	7.486	7.769	7.169	113	17.987	18.280	17.672	178	28.331	28.626	28.018
48	7.645	7.928	7.332	114	18.146	18.439	17.834	179	28.490	28.786	28.176
49	7.804	8.088	7.487	115	18.305	18.598	17.991	180	28.649	28.945	28.337
50	7.963	8.248	7.650	116	18.464	18.757	18.151	181	28.808	29.104	28.495
51	8.122	8.406	7.805	117	18.623	18.916	18.309	182	28.968	29.263	28.655
52	8.281	8.566	7.968	118	18.782	19.076	18.470	183	29.127	29.422	28.813
53	8.440	8.725	8.124	119	18.941	19.235	18.627	184	29.286	29.581	28.973
54	8.599	8.884	8.286	120	19.101	19.394	18.788	185	29.445	29.741	29.131
55	8.758	9.044	8.442	121	19.260	19.553	18.946	186	29.604	29.900	29.291
56	8.917	9.204	8.605	122	19.419	19.712	19.106	187	29.763	30.059	29.450
57	9.077	9.362	8.760	123	19.578	19.872	19.264	188	29.922	30.218	29.610
58	9.235	9.522	8.924	124	19.737	20.031	19.425	189	30.082	30.387	29.768
59	9.395	9.682	9.078	125	19.896	20.190	19.582	190	30.241	30.536	29.928
60	9.554	9.840	9.241	126	20.056	20.349	19.743	191	30.400	30.696	30.086
61	9.713	10.000	9.397	127	20.215	20.508	19.900	192	30.559	30.855	30.246
62	9.872	10.159	9.559	128	20.374	20.667	20.061	193	30.718	31.014	30.404
63	10.031	10.319	9.715	129	20.533	20.827	20.219	194	30.877	31.173	30.565
64	10.190	10.478	9.872	130	20.692	20.986	20.379	195	31.037	31.332	30.723
65	10.349	10.637	10.033	131	20.851	21.145	20.537	196	31.196	31.491	30.878
66	10.508	10.796	10.195	132	21.010	21.304	20.698	197	31.355	31.651	31.042
67	10.667	10.955	10.352	133	21.169	21.463	20.855	198	31.514	31.810	31.202
68	10.826	11.115	10.514	134	21.329	21.623	21.016	199	31.673	31.969	31.359
69	10.985	11.274	10.670	135	21.488	21.782	21.174	200	31.832	32.128	31.520
70	11.145	11.433	10.832								

SPROCKETS

No. 50
5/8" Pitch

**Sprocket
Diameters**

Martin

ROLLER CHAIN SPROCKET DIAMETERS

No. Teeth	Pitch Diameter	Outside Diameter	Caliper Diameter	No. Teeth	Pitch Diameter	Outside Diameter	Caliper Diameter	No. Teeth	Pitch Diameter	Outside Diameter	Caliper Diameter
5	1.063	1.235	.611	71	14.129	14.491	13.726	136	27.059	27.426	26.659
6	1.250	1.458	.850	72	14.329	14.690	13.929	137	27.258	27.626	26.856
7	1.441	1.673	1.104	73	14.528	14.889	14.124	138	27.457	27.824	27.057
8	1.633	1.884	1.233	74	14.726	15.088	14.326	139	27.656	28.024	27.254
9	1.828	2.093	1.400	75	14.925	15.287	14.522	140	27.854	28.223	27.454
10	2.023	2.299	1.623	76	15.124	15.486	14.724	141	28.053	28.421	27.652
11	2.219	2.504	1.796	77	15.323	15.685	14.920	142	28.253	28.621	27.853
12	2.415	2.708	2.015	78	15.522	15.884	15.122	143	28.451	28.819	28.050
13	2.612	2.911	2.193	79	15.721	16.083	15.318	144	28.650	29.018	28.250
14	2.809	3.113	2.409	80	15.919	16.283	15.519	145	28.849	28.218	28.447
15	3.006	3.315	2.590	81	16.119	16.481	15.715	146	29.048	29.416	28.608
16	3.204	3.517	2.804	82	16.318	16.681	15.918	147	29.247	29.615	28.845
17	3.401	3.718	2.987	83	16.516	16.879	16.113	148	29.446	29.814	29.046
18	3.599	3.919	3.159	84	16.715	17.079	16.315	149	29.645	30.013	29.243
19	3.798	4.121	3.384	85	16.914	17.278	16.511	150	29.844	30.213	29.444
20	3.995	4.321	3.595	86	17.113	17.476	16.713	151	30.043	30.411	29.641
21	4.194	4.522	3.782	87	17.312	17.676	16.909	152	30.241	30.610	29.841
22	4.392	4.722	3.992	88	17.511	17.874	17.111	153	30.441	30.809	30.039
23	4.590	4.923	4.179	89	17.709	18.074	17.307	154	30.639	31.008	30.239
24	4.788	5.123	4.388	90	17.909	18.273	17.509	155	30.838	31.207	30.437
25	4.987	5.323	4.577	91	18.108	18.472	17.705	156	31.038	31.406	30.638
26	5.185	5.523	4.785	92	18.306	18.671	17.906	157	31.236	31.605	30.835
27	5.384	5.723	4.975	93	18.505	18.870	18.103	158	31.435	31.804	31.035
28	5.582	5.922	5.182	94	18.704	19.069	18.304	159	31.634	32.003	31.233
29	5.781	6.122	5.371	95	18.903	19.268	18.501	160	31.833	32.202	31.433
30	5.979	6.321	5.579	96	19.102	19.467	18.702	161	32.032	32.401	31.630
31	6.178	6.521	5.770	97	19.301	19.666	18.898	162	32.231	32.600	31.831
32	6.376	6.721	5.976	98	19.500	19.865	19.100	163	32.430	32.799	32.082
33	6.575	6.921	6.168	99	19.699	20.064	19.296	164	32.629	32.998	32.229
34	6.774	7.120	6.374	100	19.898	20.263	19.498	165	32.828	33.197	32.426
35	6.973	7.319	6.565	101	20.096	20.462	19.694	166	33.027	33.396	32.627
36	7.171	7.519	6.771	102	20.296	20.661	19.896	167	33.226	33.595	32.824
37	7.370	7.718	6.963	103	20.494	20.860	20.092	168	33.424	33.794	33.024
38	7.569	7.918	7.169	104	20.693	21.059	20.293	169	33.624	33.993	33.222
39	7.768	8.117	7.361	105	20.893	21.258	20.490	170	33.823	34.192	33.423
40	7.966	8.316	7.566	106	21.091	21.457	20.691	171	34.021	34.391	33.620
41	8.165	8.516	7.759	107	21.290	21.656	20.888	172	34.220	34.589	33.820
42	8.364	8.715	7.964	108	21.489	21.855	21.089	173	34.419	34.789	34.018
43	8.563	8.914	8.157	109	21.688	22.054	21.286	174	34.618	34.988	34.218
44	8.761	9.114	8.361	110	21.887	22.253	21.487	175	34.817	35.186	34.416
45	8.960	9.313	8.554	111	22.086	22.452	21.684	176	35.016	35.386	34.616
46	9.159	9.512	8.759	112	22.284	22.651	21.884	177	35.215	35.584	34.814
47	9.358	9.711	8.952	113	22.484	22.850	22.081	178	35.414	35.783	35.014
48	9.556	9.911	9.156	114	22.683	23.049	22.283	179	35.613	35.983	35.211
49	9.755	10.110	9.350	115	22.881	23.248	22.479	180	35.812	36.181	35.412
50	9.954	10.309	9.554	116	23.080	23.447	22.680	181	36.011	36.380	35.609
51	10.153	10.508	9.748	117	23.279	23.646	22.827	182	36.209	36.579	35.809
52	10.351	10.708	9.951	118	23.478	23.845	23.078	183	36.409	36.778	36.007
53	10.550	10.907	10.146	119	23.677	24.044	23.275	184	36.608	36.977	36.208
54	10.749	11.106	10.349	120	23.876	24.243	23.476	185	36.806	37.176	36.405
55	10.948	11.305	10.543	121	24.075	24.442	23.673	186	37.005	37.375	36.605
56	11.147	11.504	10.747	122	24.274	24.641	23.874	187	37.204	37.574	36.803
57	11.346	11.703	10.941	123	24.473	24.840	24.071	188	37.403	37.773	37.003
58	11.544	11.903	11.144	124	24.672	25.039	24.272	189	37.602	37.972	37.201
59	11.743	12.102	11.339	125	24.871	25.238	24.469	190	37.801	38.171	37.401
60	11.942	12.301	11.542	126	25.069	25.437	24.669	191	38.000	38.370	37.599
61	12.141	12.500	11.737	127	25.269	25.636	24.867	192	38.199	38.569	37.799
62	12.340	12.699	11.940	128	25.468	25.834	25.068	193	38.398	38.768	37.998
63	12.539	12.898	12.135	129	25.666	26.034	25.264	194	38.597	38.967	38.197
64	12.738	13.098	12.338	130	25.865	26.233	25.465	195	38.796	39.166	38.394
65	12.936	13.296	12.533	131	26.064	26.432	25.662	196	38.994	39.364	38.594
66	13.135	13.496	12.735	132	26.263	26.631	25.863	197	39.194	39.564	38.792
67	13.334	13.694	12.930	133	26.462	26.829	26.060	198	39.393	39.763	38.993
68	13.533	13.894	13.133	134	26.661	27.029	26.261	199	39.591	39.961	39.190
69	13.732	14.093	13.328	135	26.860	27.228	26.458	200	39.791	40.161	39.391
70	13.931	14.292	13.531								

SPROCKETS



Sprocket Diameters

No. 60 3/4" Pitch

ROLLER CHAIN SPROCKET DIAMETERS

No. Teeth	Pitch Diameter	Outside Diameter	Caliper Diameter	No. Teeth	Pitch Diameter	Outside Diameter	Caliper Diameter	No. Teeth	Pitch Diameter	Outside Diameter	Caliper Diameter
5	1.276	1.482	.745	71	16.955	17.389	16.482	136	32.471	32.912	32.002
6	1.500	1.749	1.031	72	17.195	17.628	16.726	137	32.709	33.151	32.238
7	1.729	2.007	1.216	73	17.433	17.867	16.960	138	32.948	33.389	32.479
8	1.960	2.261	1.491	74	17.672	18.106	17.203	139	33.187	33.629	32.716
9	2.193	2.511	1.691	75	17.910	18.344	17.437	140	33.425	33.867	32.956
10	2.427	2.759	1.958	76	18.149	18.584	17.680	141	33.664	34.106	33.193
11	2.663	3.005	2.166	77	18.388	18.822	17.915	142	33.903	34.345	33.434
12	2.898	3.249	2.429	78	18.626	19.061	18.157	143	34.142	34.583	33.670
13	3.134	3.493	2.642	79	18.865	19.300	18.392	144	34.380	34.822	33.911
14	3.371	3.736	2.902	80	19.103	19.539	18.634	145	34.619	35.061	34.148
15	3.608	3.978	3.119	81	19.343	19.778	18.870	146	34.858	35.300	34.389
16	3.845	4.220	3.380	82	19.581	20.017	19.112	147	35.096	35.538	34.625
17	4.082	4.462	3.595	83	19.820	20.255	19.347	148	35.335	35.777	34.866
18	4.319	4.703	3.850	84	20.058	20.495	19.589	149	35.574	36.016	35.103
19	4.557	4.945	4.072	85	20.297	20.733	19.824	150	35.813	36.255	35.344
20	4.794	5.186	4.325	86	20.536	20.972	20.067	151	36.051	36.494	35.580
21	5.033	5.426	4.549	87	20.774	21.211	20.302	152	36.290	36.732	35.821
22	5.270	5.666	4.801	88	21.013	21.449	20.544	153	36.529	36.971	36.058
23	5.508	5.907	5.026	89	21.251	21.689	20.779	154	36.767	37.210	36.298
24	5.746	6.147	5.277	90	21.491	21.927	21.022	155	37.006	37.448	36.535
25	5.984	6.387	5.503	91	21.729	22.166	21.257	156	37.245	37.688	36.776
26	6.222	6.627	5.753	92	21.968	22.405	21.499	157	37.484	37.926	37.013
27	6.461	6.867	5.980	93	22.206	22.644	21.734	158	37.722	38.165	37.253
28	6.698	7.106	6.229	94	22.445	22.883	21.976	159	37.961	38.404	37.490
29	6.937	7.346	6.458	95	22.684	23.121	22.212	160	38.200	38.642	37.731
30	7.175	7.586	6.706	96	22.922	23.360	22.453	161	38.438	38.881	37.968
31	7.413	7.826	6.935	97	23.162	23.599	22.689	162	38.677	39.120	38.208
32	7.652	8.065	7.183	98	23.400	23.838	22.931	163	38.916	39.359	38.445
33	7.890	8.305	7.412	99	23.639	24.077	23.167	164	39.155	39.597	38.686
34	8.129	8.544	7.660	100	23.877	24.316	23.408	165	39.393	39.836	38.922
35	8.367	8.783	7.889	101	24.116	24.554	23.644	166	39.632	40.075	39.163
36	8.606	9.023	8.137	102	24.355	24.793	23.886	167	39.871	40.314	39.400
37	8.844	9.262	8.367	103	24.593	25.032	24.121	168	40.109	40.553	39.640
38	9.083	9.501	8.614	104	24.832	25.271	24.363	169	40.349	40.791	39.877
39	9.321	9.740	8.844	105	25.071	25.510	24.599	170	40.587	41.030	40.118
40	9.560	9.980	9.091	106	25.310	25.748	24.841	171	40.826	41.269	40.355
41	9.798	10.219	9.321	107	25.548	25.987	25.076	172	41.064	41.507	40.595
42	10.037	10.458	9.568	108	25.787	26.226	25.318	173	41.303	41.747	40.832
43	10.275	10.697	9.799	109	26.026	26.465	25.554	174	41.542	41.985	41.073
44	10.514	10.937	10.045	110	26.264	26.704	25.795	175	41.780	42.224	41.310
45	10.752	11.176	10.276	111	26.503	26.942	26.031	176	42.020	42.463	41.551
46	10.991	11.414	10.522	112	26.741	27.181	26.272	177	42.258	42.701	41.787
47	11.229	11.654	10.754	113	26.981	27.420	26.507	178	42.497	42.940	42.028
48	11.468	11.893	10.999	114	27.219	27.659	26.750	179	42.735	43.179	42.265
49	11.706	12.132	11.231	115	27.458	27.898	26.986	180	42.974	43.418	42.505
50	11.945	12.371	11.476	116	27.696	28.136	27.227	181	43.213	43.656	42.742
51	12.183	12.610	11.708	117	27.935	28.375	27.464	182	43.451	43.895	42.982
52	12.422	12.849	11.953	118	28.174	28.614	27.705	183	43.691	44.134	43.220
53	12.660	13.088	12.186	119	28.412	28.853	27.941	184	43.929	44.372	43.460
54	12.899	13.327	12.430	120	28.652	29.091	28.183	185	44.168	44.612	43.697
55	13.137	13.566	12.663	121	28.890	29.330	28.418	186	44.406	44.850	43.937
56	13.376	13.805	12.907	122	29.129	29.569	28.660	187	44.645	45.089	44.174
57	13.615	14.044	13.140	123	29.367	29.808	28.896	188	44.884	45.328	44.415
58	13.853	14.283	13.384	124	29.606	30.047	29.137	189	45.122	45.566	44.652
59	14.092	14.522	13.618	125	29.845	30.285	29.373	190	45.362	45.805	44.893
60	14.330	14.761	13.861	126	30.083	30.524	29.614	191	45.600	46.044	45.129
61	14.570	15.000	14.095	127	30.323	30.763	29.851	192	45.839	46.283	45.370
62	14.808	15.239	14.339	128	30.561	31.001	30.092	193	46.077	46.521	45.607
63	15.047	15.478	14.573	129	30.800	31.241	30.328	194	46.316	46.760	45.847
64	15.285	15.717	14.816	130	31.038	31.479	30.569	195	46.555	46.999	46.084
65	15.524	15.956	15.050	131	31.277	31.718	30.806	196	46.793	47.237	46.324
66	15.762	16.195	15.293	132	31.516	31.957	31.047	197	47.033	47.477	46.562
67	16.001	16.433	15.528	133	31.754	32.195	31.283	198	47.271	47.715	46.802
68	16.240	16.673	15.771	134	31.993	32.435	31.524	199	47.510	47.954	47.039
69	16.478	16.911	16.005	135	32.232	32.673	31.761	200	47.749	48.193	47.280
70	16.717	17.150	16.248								

SPROCKETS

No. 80 1" Pitch

Sprocket Diameters

ROLLER CHAIN SPROCKET DIAMETERS

No. Teeth	Pitch Diameter	Outside Diameter	Caliper Diameter	No. Teeth	Pitch Diameter	Outside Diameter	Caliper Diameter	No. Teeth	Pitch Diameter	Outside Diameter	Caliper Diameter
5	1.701	1.976	.993	71	22.607	23.185	21.977	136	43.294	43.882	42.669
6	2.000	2.332	1.375	72	22.926	23.504	22.301	137	43.612	44.201	42.984
7	2.305	2.676	1.622	73	23.244	23.822	22.613	138	43.931	44.519	43.306
8	2.613	3.014	1.988	74	23.562	24.141	22.937	139	44.249	44.838	43.621
9	2.924	3.348	2.254	75	23.880	24.459	23.250	140	44.567	45.156	43.942
10	3.236	3.678	2.611	76	24.198	24.778	23.573	141	44.885	45.474	44.258
11	3.550	4.006	2.888	77	24.517	25.096	23.887	142	45.204	45.793	44.579
12	3.864	4.332	3.239	78	24.835	25.415	24.210	143	45.522	46.111	44.894
13	4.179	4.657	3.523	79	25.153	25.733	24.523	144	45.840	46.429	45.215
14	4.494	4.981	3.869	80	25.471	26.052	24.846	145	46.158	46.748	45.531
15	4.810	5.304	4.158	81	25.790	26.370	25.160	146	46.477	47.066	45.852
16	5.126	5.627	4.501	82	26.108	26.689	25.483	147	46.795	47.384	46.167
17	5.442	5.949	4.794	83	26.426	27.007	25.796	148	47.113	47.703	46.488
18	5.759	6.271	5.134	84	26.744	27.326	26.119	149	47.432	48.021	46.804
19	6.076	6.593	5.430	85	27.062	27.644	26.433	150	47.750	48.340	47.125
20	6.392	6.914	5.767	86	27.381	27.962	26.756	151	48.068	48.658	47.441
21	6.710	7.235	6.066	87	27.699	28.281	27.069	152	48.386	48.976	47.761
22	7.027	7.555	6.402	88	28.017	28.599	27.392	153	48.705	49.295	48.077
23	7.344	7.876	6.702	89	28.335	28.918	27.706	154	49.023	49.613	48.398
24	7.661	8.196	7.036	90	28.654	29.236	28.029	155	49.341	49.931	48.714
25	7.979	8.516	7.338	91	28.972	29.555	28.343	156	49.660	50.250	49.035
26	8.296	8.836	7.671	92	29.290	29.873	28.665	157	49.978	50.568	49.351
27	8.614	9.156	7.974	93	29.608	30.192	28.979	158	50.296	50.886	49.671
28	8.931	9.475	8.306	94	29.927	30.510	29.302	159	50.615	51.205	49.987
29	9.249	9.795	8.611	95	30.245	30.828	29.616	160	50.933	51.523	50.308
30	9.567	10.114	8.942	96	30.563	31.147	29.938	161	51.251	51.841	50.624
31	9.884	10.434	9.247	97	30.882	31.465	30.252	162	51.569	52.160	50.944
32	10.202	10.753	9.577	98	31.200	31.784	30.575	163	51.888	52.478	51.260
33	10.520	11.073	9.883	99	31.518	32.102	30.889	164	52.206	52.796	51.581
34	10.838	11.392	10.213	100	31.836	32.421	31.211	165	52.524	53.115	51.897
35	11.156	11.711	10.520	101	32.154	32.739	31.526	166	52.843	53.433	52.218
36	11.471	12.030	10.849	102	32.473	33.057	31.848	167	53.161	53.752	52.533
37	11.792	12.349	11.156	103	32.791	33.376	32.162	168	53.479	54.070	52.854
38	12.110	12.668	11.485	104	33.109	33.694	32.484	169	53.798	54.388	53.170
39	12.428	12.987	11.792	105	33.428	34.013	32.799	170	54.116	54.707	53.491
40	12.746	13.306	12.121	106	33.746	34.331	33.121	171	54.434	55.025	53.807
41	13.064	13.625	12.429	107	34.064	34.649	33.435	172	54.752	55.343	54.127
42	13.382	13.944	12.757	108	34.382	34.968	33.757	173	55.071	55.662	54.443
43	13.700	14.263	13.065	109	34.701	35.286	34.072	174	55.389	55.980	54.764
44	14.018	14.582	13.393	110	35.019	35.605	34.394	175	55.707	56.298	55.080
45	14.336	14.901	13.702	111	35.337	35.923	34.709	176	56.026	56.617	55.401
46	14.654	15.219	14.029	112	35.655	36.241	35.030	177	56.344	56.935	55.717
47	14.972	15.538	14.338	113	35.974	36.560	35.345	178	56.662	57.253	56.037
48	15.290	15.857	14.665	114	36.292	36.878	35.667	179	56.980	57.572	56.353
49	15.608	16.176	14.975	115	36.610	37.197	35.982	180	57.299	57.890	56.674
50	15.926	16.495	15.301	116	36.928	37.515	36.303	181	57.617	58.208	56.990
51	16.244	16.813	15.611	117	37.274	37.833	36.618	182	57.935	58.527	57.310
52	16.562	17.132	15.937	118	37.565	38.152	36.940	183	58.254	58.845	57.626
53	16.880	17.451	16.248	119	37.883	38.470	37.255	184	58.572	59.163	57.947
54	17.198	17.769	16.573	120	38.202	38.788	37.577	185	58.890	59.482	58.263
55	17.516	18.088	16.884	121	38.520	39.107	37.892	186	59.208	59.800	58.583
56	17.835	18.407	17.210	122	38.838	39.425	38.213	187	59.527	60.118	58.900
57	18.153	18.725	17.521	123	39.156	39.744	38.528	188	59.845	60.437	59.220
58	18.471	19.044	17.846	124	39.457	40.062	38.850	189	60.163	60.755	59.536
59	18.789	19.363	18.157	125	39.793	40.380	39.165	190	60.482	61.073	59.857
60	19.107	19.681	18.482	126	40.111	40.699	39.486	191	60.800	61.392	60.173
61	19.426	20.000	18.794	127	40.430	41.017	39.801	192	61.118	61.710	60.493
62	19.744	20.318	19.119	128	40.748	41.335	40.123	193	61.436	62.028	60.809
63	20.062	20.637	19.431	129	41.066	41.654	40.438	194	61.755	62.347	61.130
64	20.380	20.956	19.755	130	41.384	41.972	40.759	195	62.073	62.665	61.447
65	20.698	21.274	20.067	131	41.703	42.291	41.075	196	62.391	62.983	61.756
66	21.016	21.593	20.391	132	42.021	42.609	41.396	197	62.710	63.302	62.083
67	21.335	21.911	20.704	133	42.339	42.927	41.711	198	63.028	63.620	62.403
68	21.653	22.230	21.028	134	42.657	43.246	42.032	199	63.346	63.938	62.719
69	21.971	22.548	21.340	135	42.976	43.564	42.348	200	63.665	64.257	63.040

SPROCKETS



Sprocket Diameters

No. 100 1¼" Pitch

ROLLER CHAIN SPROCKET DIAMETERS

No. Teeth	Pitch Diameter	Outside Diameter	Caliper Diameter	No. Teeth	Pitch Diameter	Outside Diameter	Caliper Diameter	No. Teeth	Pitch Diameter	Outside Diameter	Caliper Diameter
5	2.126	2.470	1.273	71	28.259	28.981	27.502	136	54.118	54.853	53.368
6	2.500	2.915	1.750	72	28.658	29.380	27.908	137	54.515	55.251	53.762
7	2.881	3.345	2.059	73	29.055	29.778	28.298	138	54.914	55.649	54.164
8	3.266	3.768	2.516	74	29.453	30.176	28.703	139	55.311	56.048	54.558
9	3.655	4.185	2.849	75	29.850	30.574	29.094	140	55.709	56.445	54.959
10	4.045	4.598	3.295	76	30.248	30.973	29.498	141	56.106	56.843	55.353
11	4.438	5.008	3.639	77	30.646	31.370	29.890	142	56.505	57.241	55.755
12	4.830	5.415	4.080	78	31.044	31.769	30.294	143	56.903	57.639	56.149
13	5.224	5.821	4.435	79	31.441	32.166	30.685	144	57.300	58.036	56.550
14	5.618	6.226	4.868	80	31.839	32.565	31.089	145	57.698	58.435	56.945
15	6.013	6.630	5.229	81	32.238	32.963	31.481	146	58.096	58.833	57.346
16	6.408	7.034	5.658	82	32.635	33.361	31.885	147	58.494	59.230	57.741
17	6.803	7.436	6.024	83	33.033	33.759	32.277	148	58.891	59.629	58.141
18	7.199	7.839	6.449	84	33.430	34.158	32.680	149	59.290	60.026	58.536
19	7.595	8.241	6.819	85	33.828	34.555	33.072	150	59.688	60.425	58.938
20	7.990	8.643	7.240	86	34.226	34.953	33.476	151	60.085	60.823	59.332
21	8.388	9.044	7.613	87	34.624	35.351	33.868	152	60.483	61.220	59.733
22	8.784	9.444	8.034	88	35.134	35.749	34.384	153	60.881	61.619	60.128
23	9.180	9.845	8.409	89	35.419	36.148	34.664	154	61.279	62.016	60.529
24	9.576	10.245	8.827	90	35.818	36.545	35.068	155	61.676	62.414	60.924
25	9.974	10.645	9.204	91	36.215	36.944	35.460	156	62.075	62.813	61.325
26	10.370	11.045	9.620	92	36.613	37.341	35.863	157	62.473	63.210	61.719
27	10.768	11.445	9.999	93	37.010	37.740	36.255	158	62.870	63.608	62.120
28	11.164	11.844	10.414	94	37.409	38.138	36.659	159	63.269	64.006	62.515
29	11.561	12.244	10.794	95	37.806	38.535	37.051	160	63.666	64.404	62.916
30	11.959	12.643	11.209	96	38.204	38.934	37.454	161	64.064	64.801	63.311
31	12.355	13.043	11.590	97	38.603	39.331	37.847	162	64.461	65.200	63.711
32	12.753	13.441	12.003	98	39.000	39.730	38.250	163	64.860	65.598	64.107
33	13.150	13.841	12.385	99	39.398	40.128	38.643	164	65.258	65.995	64.508
34	13.548	14.240	12.798	100	39.795	40.526	39.045	165	65.655	66.394	64.902
35	13.945	14.639	13.181	101	40.193	40.924	39.438	166	66.054	66.791	65.304
36	14.343	15.038	13.593	102	40.591	41.321	39.841	167	66.451	67.190	65.698
37	14.740	15.436	13.976	103	40.989	41.720	40.234	168	66.849	67.588	66.099
38	15.138	15.835	14.388	104	41.386	42.118	40.636	169	67.248	67.985	66.494
39	15.535	16.234	14.772	105	41.785	42.516	41.030	170	67.645	68.384	66.895
40	15.933	16.633	15.183	106	42.183	42.914	41.433	171	68.043	68.781	67.290
41	16.330	17.031	15.567	107	42.580	43.311	41.826	172	68.440	69.179	67.690
42	16.728	17.430	15.978	108	42.978	43.710	42.228	173	68.839	69.578	68.086
43	17.125	17.829	16.363	109	43.376	44.108	42.621	174	69.236	69.975	68.486
44	17.523	18.228	16.773	110	43.774	44.506	43.024	175	69.634	70.373	68.881
45	17.920	18.626	17.159	111	44.171	44.904	43.420	176	70.033	70.771	69.283
46	18.318	19.024	17.568	112	44.569	45.301	43.819	177	70.430	71.169	69.677
47	18.715	19.423	17.954	113	44.968	45.700	44.213	178	70.828	71.566	70.078
48	19.113	19.821	18.363	114	45.365	46.098	44.615	179	71.225	71.965	70.473
49	19.510	20.220	18.750	115	45.763	46.496	45.009	180	71.624	72.363	70.874
50	19.908	20.619	19.158	116	46.160	46.894	45.410	181	72.021	72.760	71.269
51	20.305	21.016	19.546	117	46.559	47.291	45.804	182	72.419	73.159	71.669
52	20.703	21.415	19.953	118	46.956	47.690	46.206	183	72.818	73.556	72.064
53	21.100	21.814	20.341	119	47.354	48.088	46.600	184	73.215	73.954	72.465
54	21.498	22.211	20.748	120	47.753	48.485	47.003	185	73.613	74.353	72.860
55	21.895	22.610	21.137	121	48.150	48.884	47.396	186	74.010	74.750	73.260
56	22.294	23.009	21.544	122	48.548	49.281	47.798	187	74.409	75.148	73.656
57	22.691	23.406	21.932	123	48.945	49.680	48.192	188	74.806	75.546	74.056
58	23.089	23.805	22.339	124	49.344	50.078	48.594	189	75.204	75.944	74.452
59	23.486	24.204	22.728	125	49.741	50.475	48.987	190	75.603	76.341	74.853
60	23.884	24.601	23.134	126	50.139	50.874	49.389	191	76.000	76.740	75.247
61	24.283	25.000	23.524	127	50.538	51.271	49.783	192	76.398	77.138	75.648
62	24.680	25.398	23.930	128	50.935	51.669	50.185	193	76.795	77.535	76.043
63	25.078	25.796	24.320	129	51.333	52.068	50.579	194	77.194	77.934	76.444
64	25.475	26.195	24.725	130	51.730	52.465	50.980	195	77.591	78.331	76.839
65	25.873	26.593	25.115	131	52.129	52.864	51.375	196	77.989	78.729	77.239
66	26.270	26.991	25.520	132	52.526	53.261	51.776	197	78.388	79.128	77.635
67	26.669	27.389	25.911	133	52.924	53.659	52.170	198	78.785	79.525	78.035
68	27.066	27.788	26.316	134	53.321	54.058	52.571	199	79.183	79.923	78.430
69	27.464	28.185	26.707	135	53.720	54.455	52.966	200	79.581	80.321	78.831
70	27.861	28.584	27.111								

SPROCKETS

No. 120

1½" Pitch

Sprocket Diameters



ROLLER CHAIN SPROCKET DIAMETERS

No. Teeth	Pitch Diameter	Outside Diameter	Caliper Diameter	No. Teeth	Pitch Diameter	Outside Diameter	Caliper Diameter	No. Teeth	Pitch Diameter	Outside Diameter	Caliper Diameter
5	2.552	2.964	1.552	71	33.911	34.778	33.028	136	64.941	65.823	64.066
6	3.000	3.498	2.125	72	34.389	35.256	33.514	137	65.418	66.302	64.539
7	3.458	4.014	2.496	73	34.866	35.733	33.983	138	65.897	66.779	65.022
8	3.920	4.521	3.045	74	35.343	36.212	34.468	139	66.374	67.257	65.494
9	4.386	5.022	3.444	75	35.820	36.689	34.938	140	66.851	67.734	65.976
10	4.854	5.517	3.979	76	36.297	37.167	35.422	141	67.328	68.211	66.449
11	5.325	6.009	4.392	77	36.776	37.644	35.892	142	67.806	68.690	66.931
12	5.796	6.498	4.921	78	37.253	38.123	36.378	143	68.283	69.167	67.404
13	6.269	6.986	5.347	79	37.730	38.600	36.847	144	68.760	69.644	67.885
14	6.741	7.472	5.866	80	38.207	39.078	37.332	145	69.237	70.122	68.359
15	7.215	7.956	6.300	81	38.685	39.555	37.802	146	69.716	70.599	68.841
16	7.689	8.441	6.814	82	39.162	40.034	38.287	147	70.193	71.076	69.314
17	8.163	8.924	7.254	83	39.639	40.511	38.757	148	70.670	71.555	69.795
18	8.639	9.407	7.764	84	40.116	40.989	39.241	149	71.148	72.032	70.269
19	9.114	9.890	8.207	85	40.593	41.466	39.712	150	71.625	72.510	70.750
20	9.588	10.371	8.713	86	41.072	41.943	40.197	151	72.102	72.987	71.224
21	10.065	10.853	9.161	87	41.549	42.422	40.667	152	72.579	73.464	71.704
22	10.541	11.333	9.666	88	42.026	42.899	41.151	153	73.058	73.943	72.178
23	11.016	11.814	10.115	89	42.503	43.377	41.622	154	73.535	74.420	72.660
24	11.492	12.294	10.617	90	42.981	43.854	42.106	155	74.012	74.897	73.133
25	11.969	12.774	11.070	91	43.458	44.333	42.576	156	74.490	75.375	73.615
26	12.444	13.254	11.569	92	43.935	44.810	43.060	157	74.967	75.852	74.088
27	12.921	13.734	12.024	93	44.412	45.288	43.531	158	75.444	76.329	74.569
28	13.397	14.213	12.522	94	44.891	45.765	44.016	159	75.923	76.808	75.043
29	13.874	14.693	12.978	95	45.368	46.242	44.48	160	76.400	77.285	75.525
30	14.351	15.171	13.476	96	45.845	46.721	44.970	161	76.877	77.762	75.998
31	14.826	15.651	13.933	97	46.323	47.198	45.441	162	77.354	78.240	76.479
32	15.303	16.130	14.428	98	46.800	47.676	45.925	163	77.832	78.717	76.953
33	15.780	16.610	14.887	99	47.277	48.153	46.396	164	78.309	79.194	77.434
34	16.257	17.088	15.382	100	47.754	48.632	46.879	165	78.786	79.673	77.908
35	16.734	17.567	15.842	101	48.231	49.109	47.351	166	79.265	80.150	78.390
36	17.211	18.045	16.336	102	48.710	49.586	47.835	167	79.742	80.628	78.863
37	17.688	18.524	16.797	103	49.187	50.064	48.306	168	80.219	81.105	79.344
38	18.165	19.002	17.290	104	49.664	50.541	48.789	169	80.697	81.582	79.818
39	18.642	19.481	17.751	105	50.142	51.020	49.261	170	81.174	82.061	80.299
40	19.119	19.959	18.244	106	50.619	51.497	49.744	171	81.651	82.538	80.773
41	19.596	20.438	18.706	107	51.096	51.974	50.216	172	82.128	83.015	81.253
42	20.073	20.916	19.198	108	51.573	52.452	50.698	173	82.607	83.493	81.728
43	20.550	21.395	19.661	109	52.052	52.929	51.171	174	83.084	83.970	82.209
44	21.027	21.873	20.152	110	52.529	53.408	51.654	175	83.561	84.447	82.683
45	21.504	22.352	20.615	111	53.006	53.885	52.125	176	84.039	84.926	83.164
46	21.981	22.829	21.106	112	53.483	54.362	52.608	177	84.501	85.403	83.637
47	22.458	23.307	21.570	113	53.961	54.840	53.080	178	84.993	85.880	84.118
48	22.935	23.786	22.060	114	54.438	55.317	53.563	179	85.470	86.358	84.592
49	23.412	24.264	22.525	115	54.915	55.796	54.035	180	85.949	86.835	85.074
50	23.889	24.743	23.014	116	55.392	56.273	54.517	181	86.426	87.312	85.547
51	24.366	25.220	23.480	117	55.871	56.750	54.990	182	86.903	87.791	86.028
52	24.843	25.698	23.968	118	56.348	57.228	55.473	183	87.381	88.268	86.502
53	25.320	26.177	24.434	119	56.825	57.705	55.945	184	87.858	88.745	86.983
54	25.797	26.654	24.922	120	57.303	58.182	56.428	185	88.335	89.223	87.457
55	26.274	27.132	25.389	121	57.780	58.661	56.900	186	88.812	89.700	87.937
56	26.753	27.611	25.878	122	58.257	59.138	57.382	187	89.291	90.177	88.412
57	27.230	28.088	26.344	123	58.734	59.616	57.855	188	89.768	90.656	88.893
58	27.707	28.566	26.832	124	59.213	60.093	58.338	189	90.245	91.133	89.367
59	28.184	29.045	27.299	125	59.690	60.570	58.810	190	90.723	91.610	89.848
60	28.661	29.522	27.786	126	60.167	61.049	59.292	191	91.200	92.088	90.322
61	29.139	30.000	28.254	127	60.645	61.526	59.765	192	91.677	92.565	90.802
62	29.616	30.477	28.741	128	61.122	62.003	60.247	193	92.154	93.042	91.277
63	30.093	30.956	29.208	129	61.599	62.481	60.720	194	92.633	93.521	91.758
64	30.570	31.434	29.695	130	62.076	62.958	61.201	195	93.110	93.998	92.232
65	31.047	31.911	30.163	131	62.555	63.437	61.674	196	93.587	94.475	92.712
66	31.524	32.390	30.649	132	63.032	63.914	62.157	197	94.065	94.953	93.187
67	32.003	32.867	31.118	133	63.509	64.391	62.629	198	94.542	95.430	93.667
68	32.480	33.345	31.605	134	63.986	64.869	63.111	199	95.019	95.907	94.141
69	32.957	33.822	32.073	135	64.464	65.346	63.584	200	95.498	96.386	94.623
70	33.434	34.301	32.559								

SPROCKETS



Sprocket Diameters

No. 140 1³/₄" Pitch

ROLLER CHAIN SPROCKET DIAMETERS

No. Teeth	Pitch Diameter	Outside Diameter	Caliper Diameter	No. Teeth	Pitch Diameter	Outside Diameter	Caliper Diameter	No. Teeth	Pitch Diameter	Outside Diameter	Caliper Diameter
5	2.977	3.458	1.832	71	39.562	40.574	38.553	136	75.765	76.794	74.765
6	3.500	4.081	2.500	72	40.121	41.132	39.121	137	76.321	77.352	75.316
7	4.034	4.683	2.932	73	40.677	41.689	39.667	138	76.879	77.908	75.879
8	4.573	5.275	3.573	74	41.234	42.247	40.234	139	77.436	78.467	76.431
9	5.117	5.859	4.039	75	41.790	42.803	40.781	140	78.008	79.023	77.008
10	5.663	6.437	4.663	76	42.347	43.362	41.347	141	78.549	79.580	77.545
11	6.213	7.011	5.148	77	42.905	43.918	41.895	142	79.107	80.138	78.107
12	6.762	7.581	5.762	78	43.461	44.476	42.461	143	79.664	80.694	78.484
13	7.313	8.150	6.259	79	44.018	45.033	43.009	144	80.220	81.251	79.220
14	7.865	8.717	6.865	80	44.574	45.591	43.574	145	80.777	81.809	79.773
15	8.418	9.282	7.371	81	45.133	46.148	44.123	146	81.335	82.366	80.335
16	8.971	9.847	7.971	82	45.689	46.706	44.689	147	81.891	82.922	80.887
17	9.524	10.411	8.483	83	46.246	47.262	45.237	148	82.448	83.480	81.448
18	10.078	10.974	9.078	84	46.802	47.821	45.802	149	83.006	84.037	82.000
19	10.633	11.538	9.596	85	47.359	48.377	46.351	150	83.563	84.595	82.563
20	11.186	12.100	10.186	86	47.917	48.934	46.917	151	84.119	85.152	83.115
21	11.743	12.661	10.709	87	48.473	49.492	47.465	152	84.676	85.708	83.676
22	12.297	13.221	11.297	88	49.030	50.048	48.030	153	85.234	86.266	84.229
23	12.852	13.783	11.822	89	49.586	50.607	48.579	154	85.790	86.823	84.790
24	13.407	14.343	12.407	90	50.145	51.163	49.145	155	86.347	87.379	85.343
25	13.963	14.903	12.935	91	50.701	51.721	49.693	156	86.905	87.938	85.905
26	14.518	15.463	13.518	92	51.258	52.278	50.258	157	87.462	88.494	86.457
27	15.075	16.023	14.049	93	51.814	52.836	50.807	158	88.018	89.051	87.018
28	15.629	16.581	14.629	94	52.372	53.393	51.372	159	88.576	89.609	87.571
29	16.186	17.141	15.162	95	52.929	53.949	51.921	160	89.133	90.165	88.133
30	16.742	17.700	15.742	96	53.485	54.507	52.485	161	89.689	90.722	88.685
31	17.297	18.260	16.276	97	54.044	55.064	53.035	162	90.246	91.280	89.246
32	17.854	18.818	16.854	98	54.600	55.622	53.600	163	90.804	91.837	89.799
33	18.410	19.378	17.389	99	55.157	56.179	54.150	164	91.361	92.393	90.361
34	18.967	19.936	17.967	100	55.713	56.737	54.713	165	91.917	92.951	90.913
35	19.523	20.494	18.503	101	56.270	57.293	55.264	166	92.475	93.508	91.475
36	20.080	21.053	19.080	102	56.828	57.850	55.828	167	93.032	94.066	92.027
37	20.636	21.611	19.617	103	57.384	58.408	56.378	168	93.588	94.623	92.588
38	21.193	22.169	20.193	104	57.941	58.965	56.941	169	94.147	95.179	93.141
39	21.749	22.727	20.730	105	58.499	59.523	57.492	170	94.703	95.737	93.703
40	22.306	23.286	21.306	106	59.056	60.079	58.056	171	95.260	96.294	94.255
41	22.862	23.844	21.844	107	59.612	60.636	58.636	172	95.816	96.850	94.816
42	23.419	24.402	22.419	108	60.169	61.194	59.169	173	96.374	97.409	95.370
43	23.975	24.960	22.958	109	60.727	61.751	59.720	174	96.931	97.965	95.931
44	24.532	25.519	23.532	110	61.283	62.309	60.283	175	97.487	98.522	96.484
45	25.088	26.077	24.072	111	61.840	62.865	60.834	176	98.046	99.080	97.046
46	25.645	26.633	24.645	112	62.396	63.422	61.396	177	98.602	99.636	97.598
47	26.201	27.192	25.186	113	62.955	63.980	61.948	178	99.159	100.193	98.159
48	26.758	27.750	25.758	114	63.511	64.537	62.511	179	99.715	100.751	98.712
49	27.314	28.308	26.300	115	64.068	65.095	63.062	180	100.273	101.308	99.273
50	27.871	28.866	26.871	116	64.624	65.651	63.624	181	100.830	101.864	99.826
51	28.427	29.423	27.414	117	65.182	66.208	64.176	182	101.386	102.422	100.386
52	28.984	29.981	27.984	118	65.739	66.766	64.739	183	101.945	102.979	100.940
53	29.540	30.539	28.528	119	66.295	67.323	65.290	184	102.501	103.535	101.501
54	30.097	31.096	29.097	120	66.854	67.879	65.854	185	103.058	104.094	102.054
55	30.653	31.654	29.641	121	67.410	68.437	66.404	186	103.614	104.650	102.614
56	31.211	32.212	30.211	122	67.967	68.994	66.967	187	104.172	105.207	103.168
57	31.768	32.769	30.755	123	68.523	69.552	67.518	188	104.729	105.765	103.729
58	32.324	33.327	31.324	124	69.081	70.109	68.081	189	105.285	106.321	104.282
59	32.881	33.885	31.869	125	69.638	70.665	68.632	190	105.844	106.878	104.844
60	33.437	34.442	32.437	126	70.194	71.223	69.194	191	106.400	107.436	105.396
61	33.996	35.000	32.983	127	70.753	71.780	69.746	192	106.957	107.993	105.957
62	34.552	35.557	33.552	128	71.309	72.336	70.309	193	107.513	108.549	106.510
63	35.109	36.115	34.097	129	71.866	72.895	70.860	194	108.071	109.107	107.071
64	35.665	36.673	34.665	130	72.422	73.451	71.422	195	108.628	109.664	107.624
65	36.222	37.230	35.211	131	72.980	74.009	71.974	196	109.184	110.220	108.184
66	36.778	37.788	35.778	132	73.537	74.566	72.537	197	109.743	110.779	108.738
67	37.336	38.344	36.325	133	74.093	75.122	73.088	198	110.299	111.335	109.299
68	37.893	38.903	36.893	134	74.650	75.681	73.650	199	110.856	111.892	109.853
69	38.449	39.459	37.439	135	75.208	76.237	74.202	200	111.414	112.450	110.414
70	39.006	40.017	38.006								

SPROCKETS

No. 160

2" Pitch

Sprocket Diameters



ROLLER CHAIN SPROCKET DIAMETERS

No. Teeth	Pitch Diameter	Outside Diameter	Caliper Diameter	No. Teeth	Pitch Diameter	Outside Diameter	Caliper Diameter	No. Teeth	Pitch Diameter	Outside Diameter	Caliper Diameter
5	3.402	3.952	2.111	71	45.214	46.370	44.079	136	86.588	87.764	85.463
6	4.000	4.664	2.875	72	45.852	47.008	44.727	137	87.224	88.402	86.094
7	4.610	5.352	3.369	73	46.488	47.644	45.352	138	87.862	89.038	86.737
8	5.226	6.028	4.101	74	47.124	48.282	45.999	139	88.498	89.676	87.367
9	5.848	6.696	4.635	75	47.760	48.918	46.625	140	89.134	90.312	88.009
10	6.472	7.356	5.347	76	48.396	49.556	47.271	141	89.770	90.948	88.640
11	7.100	8.012	5.902	77	49.034	50.192	47.898	142	90.408	91.586	89.283
12	7.728	8.664	6.603	78	49.670	50.830	48.545	143	91.044	92.222	89.913
13	8.358	9.314	7.171	79	50.306	51.466	49.171	144	91.680	92.858	90.555
14	8.988	9.962	7.863	80	50.942	52.104	49.817	145	92.316	93.496	91.187
15	9.620	10.608	8.442	81	51.580	52.740	50.444	146	92.945	94.132	91.829
16	10.252	11.254	9.127	82	52.216	53.378	51.091	147	93.590	94.768	92.460
17	10.844	11.898	9.713	83	52.852	54.014	51.718	148	94.226	95.406	93.101
18	11.518	12.542	10.393	84	53.488	54.652	52.363	149	94.864	96.042	93.733
19	12.152	13.186	10.985	85	54.124	55.288	52.991	150	95.500	96.680	94.375
20	12.784	13.828	11.659	86	54.762	55.924	53.637	151	96.136	97.316	95.006
21	13.420	14.470	12.256	87	55.398	56.562	54.264	152	96.772	97.952	95.647
22	14.054	15.110	12.929	88	56.034	57.198	54.909	153	97.410	98.590	96.280
23	14.688	15.752	13.529	89	56.670	57.836	55.537	154	98.046	99.226	96.921
24	15.322	16.392	14.197	90	57.308	58.472	56.183	155	98.682	99.862	97.553
25	15.958	17.032	14.801	91	57.944	59.110	56.810	156	99.320	100.500	98.195
26	16.592	17.672	15.467	92	58.580	59.746	57.455	157	99.956	101.136	98.826
27	17.228	18.312	16.073	93	59.216	60.384	58.083	158	100.592	101.772	99.467
28	17.862	18.950	16.737	94	59.854	61.020	58.729	159	101.230	102.410	100.099
29	18.498	19.590	17.346	95	60.490	61.656	59.357	160	101.866	103.046	100.741
30	19.134	20.228	18.009	96	61.126	62.294	60.001	161	102.502	103.682	101.372
31	19.768	20.868	18.619	97	61.764	62.930	60.630	162	103.138	104.320	102.013
32	20.404	21.506	19.279	98	62.400	63.568	61.275	163	103.776	104.956	102.646
33	21.040	22.146	19.891	99	63.036	64.204	61.903	164	104.412	105.592	103.287
34	21.676	22.784	20.551	100	63.672	64.842	62.547	165	105.048	106.230	103.919
35	22.312	23.422	21.164	101	64.308	65.478	63.176	166	105.686	106.866	104.561
36	22.948	24.060	21.823	102	64.946	66.114	63.821	167	106.322	107.504	105.192
37	23.584	24.698	22.437	103	65.582	66.752	64.449	168	106.958	108.140	105.833
38	24.220	25.336	23.095	104	66.218	67.388	65.093	169	107.596	108.776	106.465
39	24.856	25.974	23.710	105	66.856	68.026	65.723	170	108.232	109.414	107.107
40	25.492	26.612	24.367	106	67.492	68.662	66.367	171	108.868	110.050	107.738
41	26.128	27.250	24.983	107	68.128	69.298	66.996	172	109.504	110.686	108.379
42	26.764	27.888	25.639	108	68.764	69.936	67.639	173	110.142	111.324	109.012
43	27.400	28.526	26.256	109	69.402	70.572	68.269	174	110.778	111.960	109.653
44	28.036	29.164	26.911	110	70.038	70.210	68.913	175	111.414	112.596	110.285
45	28.672	29.802	27.529	111	70.674	71.846	69.542	176	112.052	113.234	110.927
46	29.308	30.438	28.183	112	71.310	72.482	70.185	177	112.688	113.870	111.558
47	29.944	31.076	28.802	113	71.948	73.120	70.815	178	113.324	114.506	112.199
48	30.580	31.714	29.455	114	72.584	73.756	71.459	179	113.960	115.144	112.831
49	31.216	32.352	30.075	115	73.220	74.394	72.089	180	114.598	115.780	113.473
50	31.852	32.990	30.727	116	73.856	75.030	72.731	181	115.234	116.416	114.105
51	32.488	33.626	31.348	117	74.494	75.666	73.362	182	115.870	117.054	114.745
52	33.124	34.264	31.999	118	75.130	76.304	74.005	183	116.508	117.690	115.388
53	33.760	34.902	32.621	119	75.766	76.940	74.645	184	117.144	118.326	116.019
54	34.396	35.538	33.271	120	76.404	77.576	75.279	185	117.780	118.964	116.651
55	35.032	36.176	33.894	121	77.040	78.214	75.908	186	118.416	119.600	117.291
56	35.670	36.814	34.545	122	77.676	78.850	76.551	187	119.054	120.236	117.924
57	36.306	37.450	35.167	123	78.312	79.488	77.181	188	119.690	120.874	118.565
58	36.942	38.088	35.817	124	78.950	80.124	77.825	189	120.326	121.510	119.197
59	37.578	38.726	36.440	125	79.586	80.760	78.455	190	120.964	122.146	119.839
60	38.214	39.362	37.089	126	80.222	81.398	79.097	191	121.600	122.784	120.471
61	38.852	40.000	37.713	127	80.860	82.034	79.728	192	122.236	123.420	121.111
62	39.488	40.636	38.363	128	81.496	82.670	80.371	193	122.872	124.056	121.744
63	40.124	41.274	38.986	129	82.132	83.308	81.001	194	123.510	124.694	122.385
64	40.760	41.912	39.635	130	82.768	83.944	81.643	195	124.146	125.330	123.017
65	41.396	42.548	40.259	131	83.406	84.582	82.274	196	124.781	125.966	123.656
66	42.032	43.186	40.907	132	84.042	85.218	82.917	197	125.420	126.604	124.290
67	42.670	43.822	41.532	133	84.678	85.854	83.547	198	126.056	127.240	124.931
68	43.306	44.460	42.181	134	85.314	86.492	84.189	199	126.692	127.876	125.564
69	43.942	45.096	42.806	135	85.952	87.128	84.820	200	127.330	128.514	126.205
70	44.578	45.734	43.453								

SPROCKETS



Sprocket Diameters

No. 180 2 1/4" Pitch

ROLLER CHAIN SPROCKET DIAMETERS

No. Teeth	Pitch Diameter	Outside Diameter	Caliper Diameter	No. Teeth	Pitch Diameter	Outside Diameter	Caliper Diameter	No. Teeth	Pitch Diameter	Outside Diameter	Caliper Diameter
5	3.828	4.446	2.234	71	50.866	52.166	49.448	136	97.412	98.735	96.006
6	4.500	5.247	3.094	72	51.583	52.884	50.177	137	98.128	99.452	96.715
7	5.186	6.021	3.650	73	52.299	53.600	50.880	138	98.844	100.106	97.438
8	5.879	6.782	4.473	74	53.015	54.317	51.609	139	99.560	100.886	98.148
9	6.579	7.533	5.073	75	53.730	55.033	52.313	140	100.276	101.601	98.870
10	7.281	8.276	5.875	76	54.446	55.751	53.040	141	100.992	102.317	99.580
11	7.986	9.014	6.499	77	55.162	56.466	53.745	142	101.708	103.034	100.302
12	8.693	9.747	7.287	78	55.879	57.184	54.473	143	102.425	103.750	101.012
13	9.402	10.478	7.927	79	56.594	57.899	55.177	144	103.140	104.465	101.734
14	10.112	11.207	8.706	80	57.310	58.617	55.904	145	103.857	105.183	102.445
15	10.822	11.934	9.357	81	58.027	59.333	56.610	146	104.573	105.899	103.167
16	11.533	12.661	10.127	82	58.743	60.055	57.337	147	105.289	106.614	103.877
17	12.245	13.385	10.787	83	59.459	60.766	58.042	148	106.005	108.332	104.599
18	12.957	14.110	11.551	84	60.175	61.484	58.769	149	106.721	108.047	105.309
19	13.670	14.834	12.217	85	60.891	62.199	59.474	150	107.438	108.765	106.032
20	14.383	15.557	12.977	86	61.607	62.915	60.201	151	108.154	109.481	106.742
21	15.096	16.279	13.648	87	62.323	63.632	60.907	152	108.870	110.196	107.464
22	15.810	16.999	14.404	88	63.039	63.348	61.633	153	109.586	110.914	108.174
23	16.524	17.721	15.079	89	63.755	65.066	62.339	154	110.302	111.629	108.896
24	17.238	18.441	15.832	90	64.471	65.781	63.065	155	111.018	112.345	109.607
25	17.952	19.161	16.511	91	65.187	66.499	63.771	156	111.734	113.063	110.328
26	18.666	19.881	17.260	92	65.903	67.214	64.497	157	112.451	113.778	111.039
27	19.381	20.601	17.942	93	66.619	67.932	65.203	158	113.167	114.494	111.761
28	20.096	21.319	18.690	94	67.335	68.648	65.929	159	113.883	115.211	112.471
29	20.810	22.039	19.374	95	68.051	69.363	66.636	160	114.599	115.927	113.193
30	21.525	22.757	20.119	96	68.767	70.081	67.361	161	115.315	116.642	113.904
31	22.240	23.477	20.806	97	69.483	70.796	68.068	162	116.031	117.360	114.625
32	22.955	24.194	21.549	98	70.199	71.514	68.793	163	116.747	118.076	115.336
33	23.670	24.914	22.237	99	70.916	72.230	69.500	164	117.464	118.791	116.058
34	24.385	25.632	22.979	100	71.631	72.947	70.225	165	118.180	119.509	116.768
35	25.101	26.350	23.669	101	72.348	73.663	70.933	166	118.896	120.224	117.490
36	25.816	27.068	24.410	102	73.064	74.378	71.658	167	119.612	120.942	118.201
37	26.531	27.785	25.101	103	73.780	75.096	72.365	168	120.328	121.658	118.922
38	27.246	28.503	25.840	104	74.496	75.812	73.090	169	121.044	122.373	119.633
39	27.962	29.221	26.533	105	75.212	76.529	73.798	170	121.760	123.091	120.354
40	28.677	29.939	27.271	106	75.928	77.245	74.522	171	122.477	123.806	121.065
41	29.393	30.656	27.965	107	76.644	77.960	75.230	172	123.193	124.522	121.787
42	30.108	31.374	28.702	108	77.360	78.678	75.954	173	123.909	125.240	122.498
43	30.824	32.092	29.397	109	78.076	79.394	76.662	174	124.625	125.955	123.219
44	31.539	32.810	30.133	110	78.792	80.111	77.386	175	125.341	126.671	123.930
45	32.255	33.527	30.830	111	79.508	80.827	78.095	176	126.057	127.388	124.651
46	32.971	34.243	31.565	112	80.225	81.542	78.819	177	126.774	128.104	125.363
47	33.686	34.961	32.262	113	80.931	82.260	79.527	178	127.490	128.819	126.084
48	34.402	35.678	32.996	114	81.657	82.976	80.251	179	128.206	129.537	126.795
49	35.118	36.396	33.694	115	82.373	83.693	80.959	180	128.922	130.253	127.516
50	35.834	37.114	34.428	116	83.089	84.409	81.683	181	129.638	130.968	128.227
51	36.549	37.829	35.126	117	83.805	85.124	82.392	182	130.354	131.686	128.948
52	37.265	38.547	35.859	118	84.521	85.842	83.115	183	131.071	132.401	129.660
53	37.981	39.265	36.558	119	85.237	86.558	83.824	184	131.787	133.117	130.381
54	38.696	39.980	37.290	120	85.953	87.273	84.547	185	132.503	133.835	131.092
55	39.412	40.698	37.990	121	86.670	87.991	85.256	186	133.219	134.550	131.813
56	40.128	41.416	38.722	122	87.386	88.706	85.980	187	133.935	135.266	132.524
57	40.844	42.131	39.422	123	88.102	89.424	86.689	188	134.651	135.983	133.245
58	41.560	42.849	40.154	124	88.818	90.140	87.412	189	135.367	136.699	133.957
59	42.276	43.567	40.855	125	89.534	90.855	88.121	190	136.084	137.414	134.678
60	42.991	44.282	41.585	126	90.250	91.573	88.844	191	136.800	138.132	135.389
61	43.707	45.000	42.287	127	90.966	92.288	89.553	192	137.516	138.848	136.110
62	44.423	45.716	43.017	128	91.682	93.004	90.276	193	138.232	139.563	136.822
63	45.139	46.433	43.719	129	92.399	93.722	90.986	194	138.948	140.281	137.542
64	45.855	47.151	44.449	130	93.115	94.437	91.709	195	139.664	140.996	138.254
65	46.571	47.867	45.151	131	93.831	95.155	92.418	196	140.381	141.712	138.975
66	47.287	48.584	45.881	132	94.547	95.870	93.141	197	141.097	142.430	139.686
67	48.003	49.300	46.584	133	95.263	96.586	93.850	198	141.813	143.145	140.407
68	48.719	50.018	47.313	134	95.979	97.304	94.573	199	142.529	143.861	141.119
69	49.435	50.733	48.016	135	96.695	98.019	95.283	200	143.245	144.578	141.839
70	50.151	51.451	48.745								

SPROCKETS

No. 200

2½" Pitch

Sprocket Diameters



ROLLER CHAIN SPROCKET DIAMETERS

No. Teeth	Pitch Diameter	Outside Diameter	Caliper Diameter	No. Teeth	Pitch Diameter	Outside Diameter	Caliper Diameter	No. Teeth	Pitch Diameter	Outside Diameter	Caliper Diameter
5	4.253	4.940	2.482	71	56.518	57.962	54.942	136	108.235	109.705	106.672
6	5.000	5.830	3.438	72	57.315	58.760	55.752	137	109.030	110.502	107.461
7	5.760	6.690	4.055	73	58.110	59.555	56.533	138	109.827	111.297	108.264
8	6.533	7.535	4.970	74	58.905	60.352	57.342	139	110.622	112.095	109.052
9	7.310	8.370	5.636	75	59.700	61.147	58.125	140	111.418	112.890	109.855
10	8.090	9.195	6.527	76	60.495	61.945	58.932	141	112.212	113.685	110.644
11	8.875	10.015	7.220	77	61.292	62.740	59.716	142	113.010	114.482	111.447
12	9.660	10.830	8.097	78	62.087	63.537	60.524	143	113.805	115.277	112.235
13	10.447	11.642	8.807	79	62.882	64.332	61.307	144	114.600	116.072	113.037
14	11.235	12.452	9.672	80	63.678	65.130	62.115	145	115.395	116.870	113.827
15	12.025	13.260	10.396	81	64.475	65.925	62.899	146	116.192	117.665	114.629
16	12.815	14.068	11.252	82	65.270	66.722	63.707	147	116.988	118.460	115.418
17	13.605	14.872	11.985	83	66.065	67.517	64.490	148	117.783	119.257	116.220
18	14.397	15.678	12.834	84	66.860	68.315	65.297	149	118.580	120.052	117.010
19	15.190	16.478	13.574	85	67.655	69.110	66.082	150	119.375	120.850	117.812
20	15.980	17.285	14.417	86	68.452	69.905	66.889	151	120.170	121.645	118.601
21	16.775	18.088	15.164	87	69.247	70.702	67.673	152	120.965	122.440	119.402
22	17.567	18.888	16.004	88	70.043	71.497	68.480	153	121.762	123.237	120.193
23	18.360	19.690	16.754	89	70.838	72.295	69.265	154	122.558	124.032	120.995
24	19.153	20.490	17.590	90	71.635	73.090	70.072	155	123.354	124.827	121.784
25	19.947	21.290	18.345	91	72.430	73.887	70.856	156	125.150	125.624	122.587
26	20.740	22.090	19.177	92	73.225	74.682	71.662	157	124.945	126.420	123.376
27	21.535	22.890	19.935	93	74.020	75.480	72.448	158	125.740	127.215	124.177
28	22.327	23.688	20.764	94	74.817	76.275	73.254	159	126.537	128.012	124.967
29	23.123	24.488	21.526	95	75.612	77.070	74.039	160	127.332	128.807	125.769
30	23.917	25.285	22.354	96	76.408	77.867	74.845	161	128.127	129.602	126.559
31	24.710	26.085	23.117	97	77.205	78.662	75.631	162	128.923	130.400	127.360
32	25.505	26.882	23.942	98	78.000	79.460	76.437	163	129.720	131.195	128.150
33	26.300	27.682	24.708	99	78.795	80.255	77.222	164	130.515	131.990	128.952
34	27.095	28.480	25.532	100	79.590	81.052	78.027	165	131.310	132.787	129.742
35	27.890	29.280	26.300	101	80.385	81.847	78.814	166	132.107	133.582	130.544
36	28.685	30.075	27.122	102	81.182	82.642	79.619	167	132.903	134.380	131.333
37	29.480	30.872	27.890	103	81.977	83.440	80.405	168	133.697	135.175	132.134
38	30.275	31.670	28.712	104	82.773	84.235	81.210	169	134.495	135.970	132.925
39	31.070	32.468	29.481	105	83.570	85.032	81.997	170	135.290	136.767	133.727
40	31.865	33.265	30.302	106	84.365	85.827	82.802	171	136.085	137.562	134.516
41	32.660	34.062	31.072	107	85.160	86.622	83.588	172	136.880	138.357	135.317
42	33.455	34.860	31.892	108	85.955	87.420	84.392	173	137.677	139.155	136.108
43	34.250	35.658	32.663	109	86.753	88.215	85.180	174	138.472	139.950	136.909
44	35.045	36.455	33.482	110	87.547	89.012	85.984	175	139.268	140.745	137.700
45	35.840	37.252	34.254	111	88.342	89.808	86.771	176	140.065	141.542	138.502
46	36.635	38.047	35.072	112	89.137	90.603	87.574	177	140.860	142.337	139.291
47	37.430	38.845	35.846	113	89.935	91.400	88.363	178	141.655	143.132	140.092
48	38.225	39.642	36.662	114	90.730	92.195	89.167	179	142.450	143.930	140.883
49	39.020	40.440	37.437	115	91.525	92.992	89.954	180	143.247	144.725	141.684
50	39.815	41.238	38.252	116	92.320	93.787	90.757	181	144.042	145.520	142.474
51	40.610	42.032	39.028	117	93.117	94.582	91.546	182	144.838	146.318	143.275
52	41.405	42.830	39.842	118	93.912	95.380	92.349	183	145.635	147.113	144.066
53	42.200	43.627	40.619	119	94.707	96.175	93.137	184	146.430	147.908	144.867
54	42.995	44.422	41.432	120	95.505	96.970	93.942	185	147.225	148.705	145.657
55	43.790	45.220	42.211	121	96.300	97.767	94.729	186	148.020	149.500	146.457
56	44.587	46.018	43.024	122	97.095	98.562	95.532	187	148.817	150.295	147.249
57	45.383	46.812	43.802	123	97.890	99.360	96.320	188	149.612	151.093	148.049
58	46.177	47.610	44.614	124	98.687	100.155	97.124	189	150.408	151.888	148.840
59	46.973	48.408	45.393	125	99.482	100.950	97.912	190	151.205	152.683	149.642
60	47.768	49.202	46.205	126	100.278	101.747	98.715	191	152.000	153.480	150.432
61	48.565	50.000	46.964	127	101.075	102.542	99.503	192	152.795	154.275	151.232
62	49.360	50.795	47.797	128	101.870	103.337	100.307	193	153.590	155.070	152.023
63	50.155	51.593	48.576	129	102.665	104.135	101.095	194	154.387	155.868	152.824
64	50.950	52.390	49.387	130	103.460	104.930	101.897	195	155.183	156.663	153.615
65	51.745	53.185	50.167	131	104.257	105.727	102.686	196	155.977	157.458	154.414
66	52.540	53.982	50.977	132	105.052	106.522	103.489	197	156.775	158.255	155.206
67	53.337	54.777	51.759	133	105.847	107.317	104.278	198	157.570	159.050	156.007
68	54.132	55.575	52.569	134	106.643	108.115	105.080	199	158.365	159.845	156.798
69	54.927	56.370	53.350	135	107.440	108.910	105.869	200	159.162	160.643	157.599
70	55.723	57.167	54.160								

SPROCKETS



Sprocket Diameters

No. 240 3" Pitch

ROLLER CHAIN SPROCKET DIAMETERS

No. Teeth	Pitch Diameter	Outside Diameter	Caliper Diameter	No. Teeth	Pitch Diameter	Outside Diameter	Caliper Diameter	No. Teeth	Pitch Diameter	Outside Diameter	Caliper Diameter
6	6.000	7.00	4.125	45	43.007	44.70	41.105	83	79.278	81.02	77.388
7	6.914	8.03	4.866	46	43.961	45.66	42.086	84	80.233	81.98	78.358
8	7.839	9.04	5.964	47	44.915	46.61	43.013	85	81.188	82.93	79.298
9	8.771	10.04	6.764	48	45.869	47.57	43.994	86	82.142	83.89	80.267
10	9.708	11.03	7.833	49	46.824	48.53	44.925	87	83.097	84.84	81.207
11	10.649	12.02	8.666	50	47.778	49.49	45.903	88	84.052	85.80	82.177
12	11.591	13.00	9.716	51	48.732	50.44	46.833	89	85.006	86.75	83.116
13	12.536	13.97	10.568	52	49.687	51.40	47.812	90	85.961	87.71	84.086
14	13.482	14.94	11.607	53	50.641	52.35	48.744	91	86.916	88.67	85.026
15	14.429	15.91	12.473	54	51.595	53.31	49.720	92	87.871	89.62	85.996
16	15.377	16.88	13.502	55	52.550	54.26	50.654	93	88.825	90.58	86.938
17	16.327	17.85	14.383	56	53.504	55.22	51.629	94	89.780	91.53	87.905
18	17.276	18.81	15.401	57	54.458	56.18	52.562	95	90.735	92.48	88.848
19	18.227	19.78	16.289	58	55.413	57.13	53.538	96	91.690	93.44	89.815
20	19.177	20.74	17.302	59	56.368	58.09	54.473	97	92.645	94.40	90.758
21	20.129	21.71	18.197	60	57.322	59.04	55.447	98	93.599	95.35	91.724
22	21.080	22.67	19.205	61	58.277	60.00	56.384	99	94.554	96.31	92.667
23	22.032	23.63	20.106	62	59.231	60.95	57.356	100	95.507	97.26	93.634
24	22.984	24.59	21.109	63	60.185	61.91	58.292	101	96.463	98.22	94.676
25	23.936	25.55	22.013	64	61.140	62.87	59.265	102	97.418	99.17	95.543
26	24.889	26.51	23.014	65	62.095	63.82	60.202	103	98.373	100.13	96.486
27	25.841	27.47	23.921	66	63.049	64.78	61.174	104	99.328	101.08	97.453
28	26.794	28.43	24.919	67	64.004	65.73	62.111	105	100.283	102.04	98.396
29	27.747	29.39	25.833	68	64.958	66.69	63.083	106	101.237	102.99	99.362
30	28.700	30.34	26.825	69	65.913	67.64	64.023	107	102.192	103.95	100.305
31	29.654	31.30	27.740	70	66.868	68.60	64.993	108	103.147	104.90	101.272
32	30.607	32.26	28.732	71	67.822	69.56	65.932	109	104.102	105.86	102.215
33	31.560	33.22	29.649	72	68.777	70.51	66.902	110	105.056	106.82	103.181
34	32.514	34.18	30.639	73	69.731	71.45	67.841	111	106.011	107.77	104.124
35	33.467	35.13	31.559	74	70.686	72.42	68.811	112	106.966	108.72	105.091
36	34.421	36.09	32.546	75	71.641	73.38	69.751	113	107.922	109.68	106.035
37	35.375	37.05	33.467	76	72.595	74.33	70.720	114	108.876	110.63	107.001
38	36.329	38.00	34.454	77	73.550	75.29	71.660	115	109.830	111.59	107.943
39	37.283	38.96	35.378	78	74.505	76.25	72.630	116	110.786	112.55	108.911
40	38.237	39.92	36.362	79	75.459	77.20	73.569	117	111.740	113.50	109.820
41	39.191	40.88	37.286	80	76.414	78.16	74.539	118	112.695	114.46	110.810
42	40.145	41.83	38.270	81	77.369	79.11	75.479	119	113.650	115.41	111.750
43	41.099	42.79	39.197	82	78.323	80.07	76.448	120	114.605	116.36	112.730
44	42.053	43.75	40.178								

SPROCKETS

DOUBLE PITCH CHAIN

Sloping Lines Represent Horsepower Ratings
for Chains with 17 Tooth Sprockets

QUICK SELECTOR CHART

RECOMMENDED RANGES OF CHAIN CAPACITIES

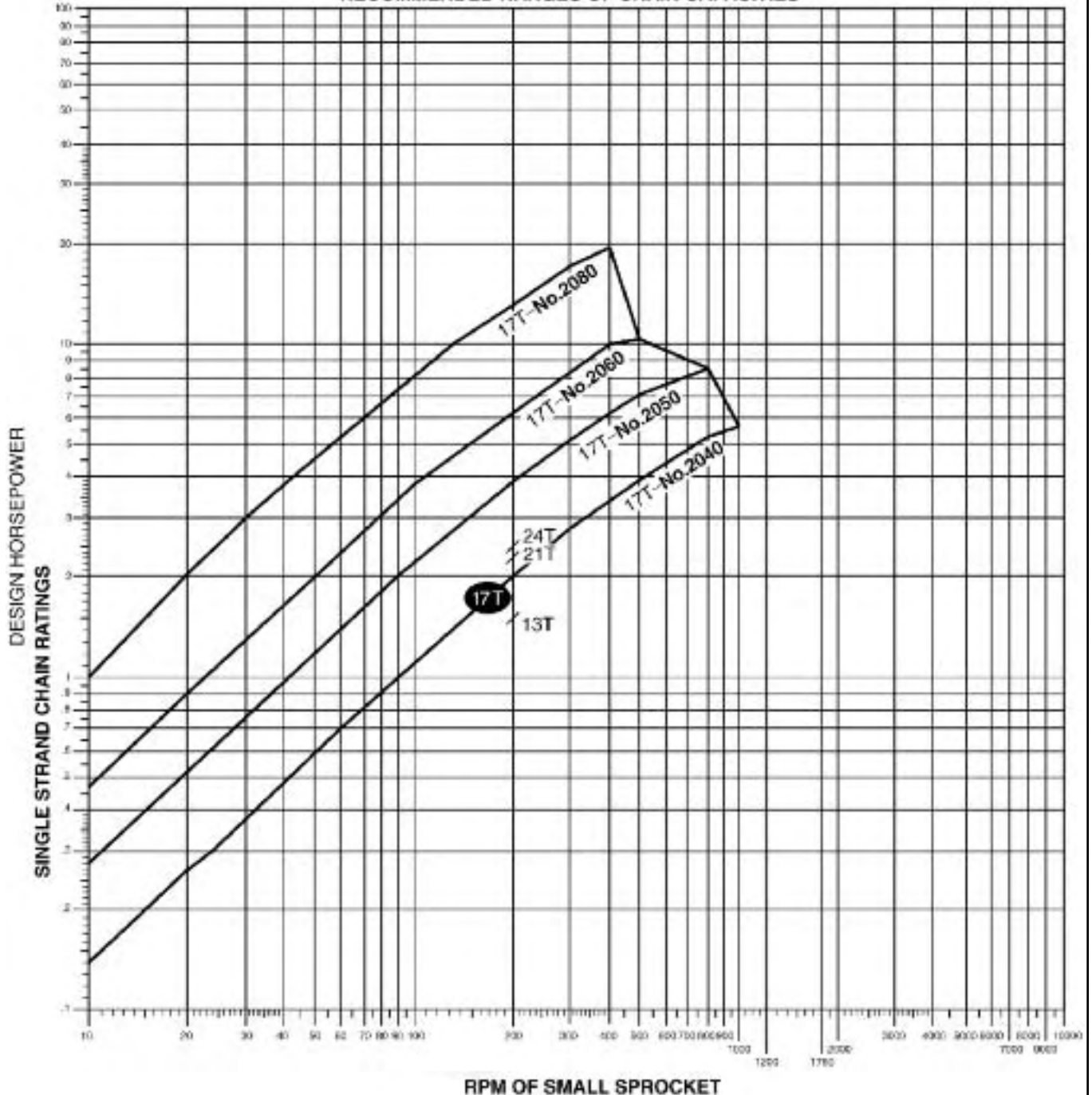

Horsepower Ratings Single Strand Roller Chain



(For Multiple Strand Ratings See Chart on Page E-187)

1/4" Pitch No. 25																				
No. of Teeth Small Sprocket	REVOLUTIONS PER MINUTE — SMALL SPROCKET																			
	100	500	900	1200	1800	2500	3000	3500	4000	4500	5000	5500	6000	6500	7000	7500	8000	8500	9000	10000
11	0.05	0.23	0.39	0.50	0.73	0.98	1.15	1.32	1.38	1.16	0.99	0.86	0.75	0.67	0.60	0.54	0.49	0.45	0.41	0.35
12	0.06	0.25	0.43	0.55	0.80	1.07	1.26	1.45	1.57	1.32	1.12	0.97	0.86	0.76	0.68	0.61	0.56	0.51	0.47	0.40
13	0.06	0.27	0.47	0.60	0.87	1.17	1.38	1.58	1.77	1.49	1.27	1.10	0.96	0.86	0.77	0.69	0.63	0.57	0.53	0.45
14	0.07	0.30	0.50	0.65	0.94	1.27	1.49	1.71	1.93	1.66	1.42	1.23	1.08	0.96	0.86	0.77	0.70	0.64	0.59	0.50
15	0.07	0.32	0.54	0.70	1.01	1.36	1.61	1.85	2.08	1.84	1.57	1.36	1.20	1.06	0.95	0.86	0.78	0.71	0.65	0.56
16	0.08	0.34	0.58	0.76	1.09	1.46	1.72	1.98	2.23	2.03	1.73	1.50	1.32	1.17	1.05	0.94	0.86	0.78	0.72	0.61
17	0.08	0.37	0.62	0.81	1.16	1.56	1.84	2.11	2.38	2.22	1.90	1.64	1.44	1.28	1.14	1.03	0.94	0.86	0.79	0.67
18	0.09	0.39	0.66	0.86	1.24	1.66	1.96	2.25	2.53	2.42	2.07	1.79	1.57	1.39	1.25	1.12	1.02	0.93	0.86	0.73
19	0.09	0.41	0.70	0.91	1.31	1.76	2.07	2.38	2.69	2.62	2.24	1.94	1.70	1.51	1.35	1.22	1.11	1.01	0.93	0.79
20	0.10	0.44	0.74	0.96	1.38	1.86	2.19	2.52	2.84	2.83	2.42	2.10	1.84	1.63	1.46	1.32	1.20	1.09	1.00	0.86
21	0.11	0.46	0.78	1.01	1.46	1.96	2.31	2.66	2.99	3.05	2.60	2.26	1.98	1.76	1.57	1.42	1.29	1.17	1.08	0.92
22	0.11	0.48	0.82	1.07	1.53	2.06	2.43	2.79	3.15	3.27	2.79	2.42	2.12	1.88	1.69	1.52	1.38	1.26	1.16	0.99
23	0.12	0.51	0.86	1.12	1.61	2.16	2.55	2.93	3.30	3.50	2.98	2.59	2.27	2.01	1.80	1.62	1.47	1.35	1.24	1.06
24	0.13	0.53	0.90	1.17	1.69	2.27	2.67	3.07	3.46	3.73	3.18	2.76	2.42	2.15	1.92	1.73	1.57	1.44	1.32	1.12
25	0.13	0.56	0.94	1.22	1.76	2.37	2.79	3.21	3.61	3.96	3.38	2.93	2.57	2.28	2.04	1.84	1.67	1.53	1.40	1.20
26	0.14	0.58	0.98	1.28	1.84	2.47	2.91	3.34	3.77	4.19	3.59	3.11	2.73	2.42	2.17	1.95	1.77	1.62	1.49	1.27
28	0.15	0.63	1.07	1.38	1.99	2.68	3.15	3.62	4.09	4.54	4.01	3.47	3.05	2.70	2.42	2.18	1.98	1.81	1.66	1.42
30	0.16	0.68	1.15	1.49	2.15	2.88	3.40	3.90	4.40	4.89	4.45	3.85	3.38	3.00	2.68	2.42	2.20	2.01	1.84	1.57
32	0.17	0.73	1.23	1.60	2.30	3.09	3.64	4.18	4.72	5.25	4.90	4.25	3.73	3.30	2.96	2.67	2.42	2.21	2.03	1.73
35	0.19	0.80	1.36	1.76	2.53	3.41	4.01	4.61	5.20	5.78	5.60	4.86	4.26	3.78	3.38	3.05	2.77	2.53	2.32	1.98
40	0.22	0.92	1.57	2.03	2.93	3.93	4.64	5.32	6.00	6.68	6.85	5.93	5.21	4.62	4.13	3.73	3.38	3.09	2.83	2.42
45	0.25	1.05	1.78	2.31	3.32	4.47	5.26	6.05	6.82	7.58	8.17	7.08	6.21	5.51	4.93	4.45	4.04	3.69	3.38	2.89
Lubrication	Type A			Type B						Type C										

3/8" Pitch No. 35																				
No. of Teeth Small Sprocket	REVOLUTIONS PER MINUTE — SMALL SPROCKET																			
	100	500	900	1200	1800	2500	3000	3500	4000	4500	5000	5500	6000	6500	7000	7500	8000	8500	9000	10000
11	0.18	0.77	1.31	1.70	2.45	3.30	2.94	2.33	1.91	1.60	1.37	1.18	1.04	0.92	0.82	0.74	0.67	0.62	0.57	0.48
12	0.20	0.85	1.44	1.87	2.70	3.62	3.35	2.66	2.17	1.82	1.56	1.35	1.18	1.05	0.94	0.85	0.77	0.70	0.64	0.55
13	0.22	0.93	1.57	2.04	2.94	3.95	3.77	3.00	2.45	2.05	1.75	1.52	1.33	1.18	1.06	0.95	0.87	0.79	0.73	0.62
14	0.24	1.01	1.71	2.21	3.18	4.28	4.22	3.35	2.74	2.30	1.96	1.70	1.49	1.32	1.18	1.07	0.97	0.88	0.81	0.69
15	0.25	1.08	1.84	2.38	3.43	4.61	4.68	3.71	3.04	2.55	2.17	1.88	1.65	1.47	1.31	1.18	1.07	0.98	0.90	0.77
16	0.27	1.16	1.97	2.55	3.68	4.94	5.15	4.09	3.35	2.81	2.40	2.08	1.82	1.62	1.45	1.30	1.18	1.08	0.99	0.85
17	0.29	1.24	2.10	2.73	3.93	5.28	5.64	4.48	3.67	3.07	2.62	2.27	2.00	1.77	1.58	1.43	1.30	1.18	1.09	0.93
18	0.31	1.32	2.24	2.90	4.18	5.61	6.15	4.88	3.99	3.35	2.86	2.48	2.17	1.93	1.73	1.56	1.41	1.29	1.18	1.01
19	0.33	1.40	2.37	3.07	4.43	5.95	6.67	5.29	4.33	3.63	3.10	2.69	2.36	2.09	1.87	1.69	1.53	1.40	1.28	1.10
20	0.35	1.48	2.51	3.25	4.68	6.29	7.20	5.72	4.68	3.92	3.35	2.90	2.55	2.26	2.02	1.82	1.65	1.51	1.39	1.18
21	0.37	1.56	2.64	3.42	4.93	6.63	7.75	6.15	5.03	4.22	3.60	3.12	2.74	2.43	2.17	1.96	1.78	1.62	1.49	1.27
22	0.38	1.64	2.78	3.60	5.19	6.97	8.21	6.59	5.40	4.52	3.86	3.35	2.94	2.61	2.33	2.10	1.91	1.74	1.60	1.37
23	0.40	1.72	2.92	3.78	5.44	7.31	8.62	7.05	5.77	4.83	4.13	3.58	3.14	2.79	2.49	2.25	2.04	1.86	1.71	1.46
24	0.42	1.80	3.05	3.96	5.70	7.66	9.02	7.51	6.15	5.15	4.40	3.81	3.35	2.97	2.66	2.40	2.17	1.99	1.82	1.56
25	0.44	1.88	3.19	4.13	5.95	8.00	9.43	7.99	6.54	5.48	4.68	4.05	3.56	3.16	2.82	2.55	2.31	2.14	1.94	1.65
26	0.46	1.96	3.33	4.31	6.21	8.35	9.84	8.47	6.93	5.18	4.96	4.30	3.77	3.35	3.00	2.70	2.45	2.24	2.05	1.75
28	0.50	2.12	3.61	4.67	6.73	9.05	10.7	9.47	7.75	6.49	5.55	4.81	4.22	3.74	3.35	3.02	2.74	2.50	2.30	1.96
30	0.54	2.29	3.89	5.03	7.25	9.74	11.5	10.5	8.59	7.20	6.15	5.33	4.68	4.15	3.71	3.35	3.04	2.77	2.55	2.17
32	0.58	2.45	4.17	5.40	7.77	10.4	12.3	11.6	9.47	7.93	6.77	5.87	5.15	4.57	4.09	3.69	3.35	3.06	2.81	...
35	0.64	2.70	4.59	5.95	8.56	11.5	13.6	13.2	10.8	9.08	7.75	6.72	5.90	5.23	4.68	4.22	3.83	3.50	3.21	...
40	0.73	3.12	5.30	6.87	9.89	13.3	15.7	16.2	13.2	11.1	9.47	8.21	7.20	6.39	5.72	5.15	4.68
45	0.83	3.55	6.02	7.80	11.2	15.1	17.8	19.3	15.8	13.2	11.3	9.79	8.59	7.62	6.82
Lubrication	Type A			Type B						Type C										

1/2" Pitch No. 41																	
No. of Teeth Small Sprocket	REVOLUTIONS PER MINUTE — SMALL SPROCKET																
	50	100	200	400	500	700	900	1200	1800	2400	3000	3500	4000	5000	6000	7000	8000
11	0.13	0.24	0.44	0.82	1.01	1.37	1.71	1.71	0.93	0.61	0.43	0.34	0.28	0.20	0.15	0.12	0.10
12	0.14	0.26	0.49	0.91	1.11	1.50	1.88	1.95	1.06	0.69	0.49	0.39	0.32	0.23	0.17	0.14	0.11
13	0.15	0.28	0.53	0.99	1.21	1.63	2.05	2.20	1.20	0.78	0.56	0.44	0.36	0.26	0.20	0.16	0.13
14	0.16	0.31	0.57	1.07	1.31	1.77	2.22	2.46	1.34	0.87	0.62	0.49	0.40	0.29	0.22	0.17	0.14
15	0.18	0.33	0.62	1.15	1.41	1.91	2.39	2.73	1.49	0.96	0.69	0.55	0.45	0.32	0.24	0.19	0.16
16	0.19	0.36	0.66	1.24	1.51	2.05	2.57	3.01	1.64	1.06	0.76	0.60	0.49	0.35	0.27	0.21	0.17
17	0.20	0.38	0.71	1.32	1.61	2.18	2.74	3.29	1.79	1.16	0.83	0.66	0.54	0.39	0.29	0.23	0.19
18	0.22	0.40	0.75	1.40	1.72	2.32	2.91	3.59	1.95	1.27	0.91	0.72	0.59	0.42	0.32	0.25	...
19	0.23	0.43	0.80	1.49	1.82	2.46	3.09	3.89	2.12	1.38	0.98	0.78	0.64	0.46	0.35	0.28	...
20	0.24	0.45	0.84	1.57	1.92	2.60	3.26	4.20	2.29	1.49	1.06	0.84	0.69	0.49	0.38	0.30	...
21	0.26	0.48	0.89	1.66	2.03	2.74	3.44	4.46	2.46	1.60	1.14	0.91	0.74	0.53	0.40	0.32	...
22	0.27	0.50	0.93	1.74	2.13	2.89	3.62	4.69	2.64	1.71	1.23	0.97	0.80	0.57	0.43	0.34	...
23	0.28	0.53	0.98	1.83	2.24	3.03	3.80	4.92	2.82	1.83	1.31	1.04	0.85	0.61	0.46	0.37	...
24	0.29	0.55	1.03	1.92	2.34	3.17	3.97	5.15	3.01	1.95	1.40	1.11	0.91	0.65	0.49	0.39	...
25	0.31	0.57	1.07	2.00	2.45	3.31	4.15	5.38	3.20	2.08	1.49	1.18	0.96	0.69	0.53
26	0.32	0.60	1.12	2.09	2.55	3.46	4.33	5.61	3.39	2.20	1.58	1.25	1.02	0.73	0.56
28	0.35	0.65	1.21	2.26	2.77	3.74	4.69	6.08	3.79	2.46	1.76	1.40	1.14	0.82	0.62
30	0.38	0.70	1.31	2.44	2.98	4.03	5.06	6.55	4.20								



Horsepower Ratings Single Strand Roller Chain

For Multiple Strand Ratings See Chart at Bottom

1/2" Pitch No. 40																	
No. of Teeth Small Sprocket	REVOLUTIONS PER MINUTE — SMALL SPROCKET																
	50	100	200	400	500	700	900	1200	1800	2400	3000	3500	4000	5000	6000	7000	8000
11	0.23	0.43	0.80	1.50	1.83	2.48	3.11	4.63	4.66	3.03	2.17	1.72	1.41	1.01	0.77	0.61	0.50
12	0.25	0.47	0.88	1.65	2.01	2.73	3.42	5.09	5.31	3.45	2.47	1.96	1.60	1.15	0.87	0.69	0.57
13	0.28	0.52	0.96	1.80	2.20	2.97	3.73	5.55	5.99	3.89	2.79	2.21	1.81	1.29	0.98	0.78	0.64
14	0.30	0.56	1.04	1.95	2.38	3.22	4.04	6.01	6.70	4.35	3.11	2.47	2.02	1.45	1.10	0.87	0.71
15	0.32	0.60	1.12	2.10	2.56	3.47	4.35	6.47	7.43	4.82	3.45	2.74	2.24	1.60	1.22	0.97	0.79
16	0.35	0.65	1.20	2.25	2.75	3.72	4.66	6.94	8.18	5.31	3.80	3.02	2.47	1.77	1.34	1.07	0.87
17	0.37	0.69	1.29	2.40	2.93	3.97	4.98	7.41	8.96	5.82	4.17	3.31	2.71	1.94	1.47	1.17	0.96
18	0.39	0.73	1.37	2.55	3.12	4.22	5.30	7.88	9.76	6.34	4.54	3.60	2.95	2.11	1.60	1.27	...
19	0.42	0.78	1.45	2.71	3.31	4.48	5.62	8.36	10.5	6.88	4.92	3.91	3.20	2.29	1.74	1.38	...
20	0.44	0.82	1.53	2.86	3.50	4.73	5.94	8.83	11.1	7.43	5.31	4.22	3.45	2.47	1.88	1.49	...
21	0.46	0.87	1.62	3.02	3.69	4.99	6.26	9.31	11.7	7.99	5.72	4.54	3.71	2.66	2.02	1.60	...
22	0.49	0.91	1.70	3.17	3.88	5.25	6.58	9.79	12.3	8.57	6.13	4.87	3.98	2.85	2.17	1.72	...
23	0.51	0.96	1.78	3.33	4.07	5.51	6.90	10.3	12.9	9.16	6.55	5.20	4.26	3.05	2.32	1.84	...
24	0.54	1.00	1.87	3.48	4.26	5.76	7.23	10.8	13.5	9.76	6.99	5.54	4.54	3.25	2.47	1.96	...
25	0.56	1.05	1.95	3.64	4.45	6.02	7.55	11.2	14.1	10.4	7.43	5.89	4.82	3.45	2.63
26	0.58	1.09	2.04	3.80	4.64	6.28	7.88	11.7	14.7	11.0	7.88	6.25	5.12	3.66	2.79
28	0.63	1.18	2.20	4.11	5.03	6.81	8.54	12.7	15.9	12.3	8.80	6.99	5.72	4.09	3.11
30	0.68	1.27	2.38	4.43	5.42	7.33	9.20	13.7	17.2	13.6	9.76	7.75	6.34	4.54	3.45
32	0.73	1.36	2.55	4.75	5.81	7.86	9.86	14.7	18.4	15.0	10.8	8.64	6.99	5.00
35	0.81	1.50	2.81	5.24	6.40	8.66	10.9	16.2	20.3	17.2	12.3	9.76	7.99	5.76
40	0.93	1.74	3.24	6.05	7.39	10.0	12.5	18.7	23.4	21.0	15.0	11.9	9.76	6.99
45	1.06	1.97	3.68	6.87	8.40	11.4	14.2	21.2	26.6	25.1	17.9	14.2	11.7
Lubrication	Type A			Type B				Type C									

5/8" Pitch No. 50																		
No. of Teeth Small Sprocket	REVOLUTIONS PER MINUTE — SMALL SPROCKET																	
	50	100	300	500	900	1200	1400	1800	2100	2400	2700	3000	3500	4000	4500	5000	6000	
11	0.45	0.84	2.25	3.57	6.06	7.85	8.13	5.58	4.42	3.62	3.04	2.59	2.06	1.68	1.41	1.20	1.04	0.92
12	0.49	0.92	2.47	3.92	6.65	8.62	9.26	6.35	5.04	4.13	3.46	2.95	2.34	1.92	1.61	1.37	1.19	1.04
13	0.54	1.00	2.70	4.27	7.25	9.40	10.4	7.16	5.69	4.65	3.90	3.33	2.64	3.16	1.81	1.55	1.34	...
14	0.58	1.09	2.92	4.63	7.86	10.2	11.7	8.01	6.35	5.20	4.36	3.72	2.95	2.42	2.03	1.73	1.50	...
15	0.73	1.17	3.15	4.99	8.47	11.0	12.6	8.88	7.05	5.77	4.83	4.13	3.27	2.68	2.25	1.92	1.66	...
16	0.67	1.26	3.38	5.35	9.08	11.8	13.5	9.78	7.76	6.35	5.32	4.55	3.61	2.95	2.47	2.11	1.83	...
17	0.72	1.34	3.61	5.71	9.69	12.6	14.4	10.7	8.50	6.96	5.83	4.98	3.95	3.23	2.71	2.31	2.01	...
18	0.76	1.43	3.83	6.07	10.3	13.4	15.3	11.7	9.26	7.58	6.35	5.42	4.30	3.52	2.95	2.52
19	0.81	1.51	4.07	6.44	10.9	14.2	16.3	12.7	10.0	8.22	6.89	5.88	4.67	3.82	3.20	2.73
20	0.86	1.60	4.30	6.80	11.5	15.0	17.2	13.7	10.8	8.88	7.44	6.35	5.04	4.13	3.46	2.95
21	0.90	1.69	4.53	7.17	12.2	15.8	18.1	14.7	11.7	9.55	8.01	6.84	5.42	4.44	3.72	3.18
22	0.95	1.77	4.76	7.54	12.8	16.6	19.1	15.8	12.5	10.2	8.59	7.39	5.82	4.76	3.99	3.41
23	1.00	1.86	5.00	7.91	13.4	17.4	20.0	16.9	13.4	11.0	9.18	7.84	6.22	5.09	4.27
24	1.04	1.95	5.23	8.29	14.1	18.2	20.9	18.0	14.3	11.7	9.78	8.35	6.33	5.42	4.55
25	1.09	2.03	5.47	8.66	14.7	19.0	21.9	19.1	15.2	12.4	10.4	8.88	7.05	5.77	4.83
26	1.14	2.12	5.70	9.03	15.3	19.9	22.8	20.3	16.1	13.2	11.0	9.42	7.47	6.12	5.13
28	1.23	2.30	6.18	9.79	16.6	21.5	24.7	22.6	18.0	14.7	12.3	10.5	8.35	6.84	5.73
30	1.33	2.49	6.66	10.5	17.9	23.2	26.6	25.1	19.9	16.3	13.7	11.7	9.26	7.58
32	1.42	2.66	7.14	11.3	19.2	24.9	28.6	27.7	22.0	18.0	15.1	12.9	10.2	8.35
35	1.57	2.93	7.86	12.5	21.1	27.4	31.5	31.6	25.1	20.6	17.2	14.7	11.7	9.55
40	1.81	3.38	9.08	14.4	24.4	31.6	36.3	38.7	30.7	25.1	21.0	18.0	14.3
45	2.06	3.84	10.3	16.3	27.7	35.9	41.3	46.1	36.6	30.0	25.1	21.4
Lubrication	Type A	Type B			Type C													

Multiple Strand Factors

No. Strands	Strand Factor
1	1.0
2	1.9
3	2.8
4	3.7

Type A Manual Lubrication
 Type B Bath or Disc Lubrication
 Type C Oil Stream Lubrication

SPROCKETS

Horsepower Ratings Single Strand Roller Chain



For Multiple Strand Ratings See Chart Page E-189

SPROCKETS

3/4" Pitch No. 60																	
No. of Teeth Small Sprocket	REVOLUTIONS PER MINUTE — SMALL SPROCKET																
	50	100	200	500	700	900	1200	1400	1600	1800	2000	2500	3000	3500	4000	4500	
11	0.77	1.44	2.69	6.13	8.30	10.4	11.9	9.41	7.70	6.45	5.51	3.94	3.00	2.38	1.95	1.63	
12	0.85	1.58	2.95	6.74	9.12	11.4	13.5	10.7	8.77	7.35	6.28	4.49	3.42	2.71	2.22	1.86	
13	0.92	1.73	3.22	7.34	9.94	12.5	15.2	12.1	9.89	8.29	7.08	5.06	3.85	3.06	2.50	...	
14	1.00	1.87	3.49	7.96	10.8	13.5	17.0	13.5	11.1	9.26	7.91	5.66	4.31	3.42	2.80	...	
15	1.08	2.01	3.76	8.57	11.6	14.5	18.8	15.0	12.3	10.3	8.77	6.28	4.77	3.79	3.10	...	
16	1.16	2.16	4.03	9.19	12.4	15.6	20.2	16.5	13.5	11.3	9.66	6.91	5.26	4.17	3.42	...	
17	1.24	2.31	4.30	9.81	13.3	16.7	21.6	18.1	14.8	12.4	10.6	7.57	5.76	4.57	3.74	...	
18	1.31	2.45	4.58	10.4	14.1	17.7	22.9	19.7	16.1	13.5	11.5	8.25	6.28	4.98	4.08	...	
19	1.39	2.60	4.85	11.1	15.0	18.8	24.3	21.4	17.5	14.6	12.5	8.95	6.81	5.40	4.42	...	
20	1.47	2.75	5.13	11.7	15.8	19.8	25.7	23.1	18.9	15.8	13.5	9.66	7.35	5.83	
21	1.55	2.90	5.40	12.3	16.7	20.9	27.1	24.8	20.3	17.0	14.5	10.4	7.91	6.28	
22	1.63	3.05	5.68	13.0	17.5	22.0	28.5	26.6	21.8	18.2	15.6	11.1	8.48	6.73	
23	1.71	3.19	5.96	13.6	18.4	23.1	29.9	28.4	23.3	19.5	16.7	11.9	9.07	7.19	
24	1.79	3.35	6.24	14.2	19.3	24.1	31.3	30.3	24.8	20.8	17.8	12.7	9.66	7.67	
25	1.87	3.50	6.52	14.9	20.1	25.3	32.7	32.2	26.4	22.1	18.9	13.5	10.3	8.15	
26	1.95	3.65	6.81	15.5	21.0	26.4	34.1	34.2	28.0	23.4	20.0	14.3	10.9	8.65	
28	2.12	3.95	7.37	16.8	22.8	28.5	37.0	38.2	31.3	26.2	22.4	16.0	12.2	
30	2.28	4.26	7.94	18.1	24.5	30.8	39.8	42.4	34.7	29.1	24.8	17.8	13.5	
32	2.45	4.56	8.52	19.4	26.3	33.0	42.7	46.7	38.2	32.0	27.3	19.6	14.9	
35	2.69	5.03	9.38	21.4	29.0	36.3	47.1	53.4	43.7	36.6	31.3	22.4	17.0	
40	3.11	5.81	10.8	23.7	33.5	42.0	54.4	62.5	53.4	44.7	38.2	27.3	
45	3.53	6.60	12.3	28.1	38.0	47.7	61.7	70.9	63.7	53.4	45.6	32.6	
Lubrication	Type A	Type B				Type C											

1" Pitch No. 80																				
No. of Teeth Small Sprocket	REVOLUTIONS PER MINUTE — SMALL SPROCKET																			
	25	50	100	200	300	400	500	700	900	1000	1200	1400	1600	1800	2000	2200	2400	2700	3000	3400
11	0.97	1.80	3.36	6.28	9.04	11.7	14.3	19.4	23.0	19.6	14.9	11.8	9.69	8.12	6.93	6.01	5.27	4.42	3.77	1.70
12	1.06	1.98	3.69	6.89	9.93	12.9	15.7	21.3	26.2	22.3	17.0	13.5	11.0	9.25	7.90	6.85	6.01	5.04	4.30	...
13	1.16	2.16	4.03	7.52	10.8	14.0	17.1	23.2	29.1	25.2	19.2	15.2	12.5	10.4	8.91	7.72	6.78	5.68	4.85	...
14	1.25	2.34	4.36	8.14	11.7	15.2	18.6	25.1	31.5	28.2	21.4	17.0	13.9	11.7	9.96	8.83	7.57	6.35	5.42	...
15	1.35	2.52	4.70	8.77	12.6	16.4	20.0	27.1	34.0	31.2	23.8	18.9	15.4	12.9	11.0	9.57	8.40	7.04	6.01	...
16	1.45	2.70	5.04	9.41	13.5	17.6	21.5	29.0	36.4	34.4	26.2	20.8	17.0	14.2	12.2	10.5	9.25	7.76	6.62	...
17	1.55	2.88	5.38	10.0	14.5	18.7	22.9	31.0	38.9	37.7	28.7	22.7	18.6	15.6	13.3	11.5	10.1	8.49	7.25	...
18	1.64	3.07	5.72	10.7	15.4	19.9	24.4	33.0	41.4	41.1	31.2	24.8	20.3	17.0	14.5	12.6	11.0	9.25	7.90	...
19	1.74	3.25	6.07	11.3	16.3	21.1	25.8	35.0	43.8	44.5	33.9	26.9	22.0	18.4	15.7	13.6	12.0	10.0	8.57	...
20	1.84	3.44	6.41	12.0	17.2	22.3	27.3	37.0	46.3	48.1	36.6	29.0	23.8	19.9	17.0	14.7	12.9	10.8
21	1.94	3.62	6.76	12.6	18.2	23.5	28.8	39.0	48.9	51.7	39.4	31.2	25.6	21.4	18.3	15.9	13.9	11.7
22	2.04	3.81	7.11	13.3	19.1	24.8	30.3	41.0	51.4	55.5	42.2	33.5	27.4	23.0	19.6	17.0	14.9	12.5
23	2.14	4.00	7.46	13.9	20.1	26.0	31.8	43.0	53.9	59.3	45.1	35.8	29.3	24.6	21.0	18.2	15.9	13.4
24	2.24	4.19	7.81	14.6	21.0	27.2	33.2	45.0	56.4	62.0	48.1	38.2	31.2	26.2	22.3	19.4	17.0	14.2
25	2.34	4.37	8.16	15.2	21.9	28.4	34.7	47.0	59.0	64.8	51.1	40.6	33.2	27.8	23.8	20.6	18.1	15.1
26	2.45	4.56	8.52	15.9	22.9	29.7	36.2	49.1	61.5	67.6	54.2	43.0	35.2	29.5	25.2	21.8	19.2	16.1
28	2.65	4.94	9.23	17.2	24.8	32.1	39.3	53.2	66.7	73.3	60.6	48.1	39.4	33.0	28.2	24.4	21.4
30	2.85	5.33	9.94	18.5	26.7	34.6	42.3	57.3	71.8	78.9	67.2	53.3	43.6	36.6	31.2	27.1	23.8
32	3.06	5.71	10.7	19.9	28.6	37.1	45.4	61.4	77.0	84.6	74.0	58.7	48.1	40.3	34.4	29.8	26.2
35	3.37	6.29	11.7	21.9	31.6	40.9	50.0	67.6	84.8	93.3	84.7	67.2	55.0	46.1	39.4	34.1
40	3.89	7.27	13.6	25.3	36.4	47.2	57.7	78.1	98.0	108	103	82.1	67.2	56.3	48.1	20.0
45	4.42	8.25	15.4	28.7	41.4	53.6	65.6	88.7	111	122	123	98.0	80.2	67.2	54.1
Lubrication	Type A	Type B				Type C														

1 1/4" Pitch No. 100																							
No. of Teeth Small Sprocket	REVOLUTIONS PER MINUTE — SMALL SPROCKET																						
	10	25	50	100	200	300	400	500	600	700	800	900	1000	1100	1200	1300	1400	1600	1800	2000	2200	2400	2600
11	0.81	1.85	3.45	6.44	12.0	17.3	22.4	27.4	32.3	37.1	32.8	27.5	23.4	20.3	17.8	15.8	14.2	11.6	9.71	8.29	7.19	6.31	1.29
12	0.89	2.03	3.79	7.08	13.2	19.0	24.6	30.1	35.5	40.8	37.3	31.3	26.7	23.2	20.3	18.0	16.1	13.2	11.1	9.45	8.19	7.19	...
13	0.97	2.22	4.13	7.72	14.4	20.7	26.9	32.8	38.7	44.5	42.1	35.3	30.1	26.1	22.9	20.3	18.2	14.9	12.5	10.6	9.23	8.10	...
14	1.05	2.40	4.48	8.36	15.6	22.5	29.1	35.6	41.9	48.2	47.0	39.4	33.7	29.2	25.6	22.7	20.3	16.6	13.9	11.9	10.3	9.06	...
15	1.13	2.59	4.83	9.01	16.8	24.2	31.4	38.3	45.2	51.9	52.2	43.7	37.3	32.4	28.4	25.2	22.5	18.4	15.5	13.2	11.4	10.0	...
16	1.22	2.77	5.17	9.66	18.0	26.0	33.6	41.1	48.4	55.6	57.5	48.2	41.1	35.7	31.3	27.7	24.8	20.3	17.0	14.5	12.8	11.1	...
17	1.30	2.96	5.52	10.3	19.2	27.7	35.9	43.9	51.7	59.4	63.0	52.8	45.0	39.0	34.3	30.4	27.2	22.3	18.7	15.9	13.8	0.79	...
18	1.38	3.15	5.88	11.0	20.5	29.5	38.2	46.7	55.0	63.2	68.6	57.5	49.1	42.5	37.3	33.1	29.6	24.2	20.3	17.4	15.0
19	1.46	3.34	6.23	11.6	21.7	31.2	40.5	49.5	58.3	67.0	74.4	62.3	53.2	46.1	40.5	35.9	32.1	26.3	22.0	18.8	16.3
20	1.55	3.53	6.58	12.3	22.9	33.0	42.8	52.3	61.6	70.8	79.8	67.3	57.5	49.8	43.7	38.8	34.7	28.4	23.8	20.3	17.6
21	1.63	3.72	6.94	13.0	24.2	34.8	45.1	55.1	65.0	74.6	84.2	72.4	61.8	53.6	47.0	41.7	37.3	30.6	25.6	21.9	19.0
22	1.71	3.91	7.30	13.6	25.4	36.6	47.4	58.0	68.3	78.5	88.5	77.7	66.3	57.5	50.4	44.7	40.0	32.8	27.5	23.4	20.3
23	1.80	4.10	7.66	14.3	26.7	38.4	49.8	60.8	71.7	82.3	92.8	83.0	70.9	61.4	53.9	47.8	42.8	35.0	29.4	25.1	7.74
24	1.88	4.30	8.02	15.0	27.9	40.2	52.1	63.7	75.0	86.2	97.2	88.5	75.6	65.5	57.5	51.0	45.6	37.3	31.3	26.7
25	1.97	4.49	8.38	15.6	29.2	42.0	54.4	66.6	78.4	90.1	102	94.1	80.3	69.6	61.1	54.2	48.5	39.7	33.3	28.4
26	2.05	4.68	8.74	16.3	30.4	43.8	56.8	69.4	81.8	94.0	106	99.8	85.2	73.8	64.8	57.5	51.4	42.1	35.3	30.1
28	2.22	5.07	9.47	17.7	33.0	47.5	61.5	75.2	88.6	102	115	112	95.2	82.5	72.4	64.2	57.5	47.0	39.4	33.7
30	2.40	5.47	10.2	19.0	35.5	51.2	66.3	81.0	95.5	110	124	124	106	91.5	80.3	71.2	63.7	52.2	43.7	10.0
32	2.57	5.86	10.9	20.4	38.1	54.9	71.1	86.9															



Horsepower Ratings Single Strand Roller Chain

For Multiple Strand Ratings See Chart at Bottom

1 1/2" Pitch No. 120																									
No. of Teeth Small Sprocket	REVOLUTIONS PER MINUTE — SMALL SPROCKET																								
	10	25	50	100	150	200	300	400	500	600	700	800	900	1000	1100	1200	1300	1400	1500	1600	1700	1800	1900	2000	2100
11	1.37	3.12	5.83	10.9	15.7	20.3	29.2	37.9	46.3	54.6	62.9	71.2	79.5	87.8	96.1	104.4	112.7	121.0	129.3	137.6	145.9	154.2	162.5	170.8	179.1
12	1.50	3.43	6.40	11.9	17.2	22.3	32.1	41.6	50.9	59.9	68.8	77.7	86.6	95.5	104.4	113.3	122.2	131.1	140.0	148.9	157.8	166.7	175.6	184.5	193.4
13	1.64	3.74	6.98	13.0	18.8	24.3	35.0	45.4	55.5	65.3	75.0	84.7	94.4	104.1	113.8	123.5	133.2	142.9	152.6	162.3	172.0	181.7	191.4	201.1	210.8
14	1.78	4.05	7.56	14.1	20.3	26.3	37.9	49.1	60.1	70.8	81.5	92.2	102.9	113.6	124.3	135.0	145.7	156.4	167.1	177.8	188.5	199.2	209.9	220.6	231.3
15	1.91	4.37	8.15	15.2	21.9	28.4	40.9	53.0	64.7	76.3	87.8	99.3	110.8	122.3	133.8	145.3	156.8	168.3	179.8	191.3	202.8	214.3	225.8	237.3	248.8
16	2.05	4.68	8.74	16.3	23.5	30.4	43.8	56.8	69.4	81.8	94.2	106.6	119.0	131.4	143.8	156.2	168.6	181.0	193.4	205.8	218.2	230.6	243.0	255.4	267.8
17	2.19	5.00	9.33	17.4	25.1	32.5	46.8	60.6	74.1	87.3	100.5	113.7	126.9	140.1	153.3	166.5	179.7	192.9	206.1	219.3	232.5	245.7	258.9	272.1	285.3
18	2.33	5.32	9.92	18.5	26.7	34.6	49.8	64.5	78.8	92.9	107.0	121.1	135.2	149.3	163.4	177.5	191.6	205.7	219.8	233.9	248.0	262.1	276.2	290.3	304.4
19	2.47	5.64	10.5	19.6	28.3	36.6	52.8	68.4	83.6	98.5	113.4	128.3	143.2	158.1	173.0	187.9	202.8	217.7	232.6	247.5	262.4	277.3	292.2	307.1	322.0
20	2.61	5.96	11.1	20.7	29.9	38.7	55.8	72.2	88.3	104	120	136	152	168	184	200	216	232	248	264	280	296	312	328	344
21	2.75	6.28	11.7	21.9	31.5	40.8	58.8	76.2	94.1	110	127	145	162	180	198	216	234	252	270	288	306	324	342	360	378
22	2.90	6.60	12.3	23.0	33.1	42.9	61.8	80.1	97.9	115	131	147	164	182	200	218	236	254	272	290	308	326	344	362	380
23	3.04	6.93	12.9	24.1	34.8	45.0	64.9	84.0	103	121	139	157	175	193	211	229	247	265	283	301	319	337	355	373	391
24	3.18	7.25	13.5	25.3	36.4	47.1	67.9	88.0	108	127	146	165	184	203	222	241	260	279	298	317	336	355	374	393	412
25	3.32	7.58	14.1	26.4	38.0	49.3	71.0	91.9	112	132	152	172	192	212	232	252	272	292	312	332	352	372	392	412	432
26	3.47	7.91	14.8	27.5	39.7	51.4	74.0	95.9	117	138	159	180	201	222	243	264	285	306	327	348	369	390	411	432	453
28	3.76	8.57	16.0	29.8	43.0	55.7	80.2	104	127	150	172	194	216	238	260	282	304	326	348	370	392	414	436	458	480
30	4.05	9.23	17.2	32.1	46.3	60.0	86.4	112	137	161	185	209	233	257	281	305	329	353	377	401	425	449	473	497	521
32	4.34	9.90	18.5	34.5	49.6	64.3	92.6	120	147	173	199	225	251	277	303	329	355	381	407	433	459	485	511	537	563
35	4.78	10.9	20.3	38.0	54.7	70.9	102	132	162	190	219	248	277	306	335	364	393	422	451	480	509	538	567	596	625
40	5.52	12.6	23.5	43.9	63.2	81.8	118	153	187	220	253	286	319	352	385	418	451	484	517	550	583	616	649	682	715
45	6.27	14.3	26.7	49.8	71.7	92.9	134	173	212	250	287	324	361	398	435	472	509	546	583	620	657	694	731	768	805
Lubrication	Type A	Type B						Type C																	

1 3/4" Pitch No. 140																									
No. of Teeth Small Sprocket	REVOLUTIONS PER MINUTE — SMALL SPROCKET																								
	10	25	50	100	150	200	250	300	350	400	450	500	550	600	700	800	900	1000	1100	1200	1300	1400	1500	1600	1700
11	2.12	4.83	9.02	16.8	24.2	31.4	38.4	45.2	52.0	58.6	65.2	71.6	77.8	83.9	89.9	95.8	101.7	107.6	113.5	119.4	125.3	131.2	137.1	143.0	148.9
12	2.33	5.31	9.91	18.5	26.6	34.5	42.2	49.7	57.1	64.4	71.6	78.7	85.7	92.6	99.5	106.4	113.3	120.2	127.1	134.0	140.9	147.8	154.7	161.6	168.5
13	2.54	5.79	10.8	20.2	29.0	37.6	46.0	54.2	62.2	70.2	78.0	85.8	93.5	101.2	108.9	116.6	124.3	132.0	139.7	147.4	155.1	162.8	170.5	178.2	185.9
14	2.75	6.27	11.7	21.8	31.5	40.8	49.8	58.7	67.4	76.0	84.5	93.0	101	109.8	118.6	127.4	136.2	145.0	153.8	162.6	171.4	180.2	189.0	197.8	206.6
15	2.96	6.76	12.6	23.5	33.9	43.9	53.7	63.2	72.7	81.9	91.1	100	109	118.3	127.6	136.9	146.2	155.5	164.8	174.1	183.4	192.7	202.0	211.3	220.6
16	3.18	7.24	13.5	25.2	36.3	47.1	57.5	67.8	77.9	87.8	97.7	107	117	126.9	136.8	146.7	156.6	166.5	176.4	186.3	196.2	206.1	216.0	225.9	235.8
17	3.39	7.73	14.4	26.9	38.8	50.3	61.4	72.4	83.2	93.8	104	115	125	135	145	155	165	175	185	195	205	215	225	235	245
18	3.61	8.23	15.4	28.6	41.3	53.5	65.3	77.0	88.5	99.8	111	122	133	143	153	163	173	183	193	203	213	223	233	243	253
19	3.82	8.72	16.3	30.4	43.7	56.7	60.3	81.6	93.8	106	118	129	141	150	159	168	177	186	195	204	213	222	231	240	249
20	4.04	9.22	17.2	32.1	46.2	59.9	73.2	86.3	99.1	112	124	137	149	161	172	183	194	205	216	227	238	249	260	271	282
21	4.26	9.72	18.1	33.8	48.7	63.1	77.2	91.0	104	118	131	144	157	170	183	196	209	222	235	248	261	274	287	300	313
22	4.48	10.2	19.1	35.6	51.3	66.4	81.2	95.6	110	124	138	151	165	178	191	204	217	230	243	256	269	282	295	308	321
23	4.70	10.7	20.0	37.3	53.8	69.7	85.2	100	115	130	145	159	173	187	200	213	226	239	252	265	278	291	304	317	330
24	4.92	11.2	20.9	39.1	56.3	72.9	89.2	105	121	136	151	166	181	196	210	224	238	252	266	280	294	308	322	336	350
25	5.14	11.7	21.9	40.8	58.8	76.2	93.2	110	126	142	158	174	189	205	220	235	250	265	280	295	310	325	340	355	370
26	5.37	12.2	22.8	42.6	61.4	79.5	97.2	115	132	148	165	181	198	214	230	246	262	278	294	310	326	342	358	374	390
28	5.81	13.3	24.7	46.2	66.5	86.2	105	124	143	161	179	197	214	232	250	268	286	304	322	340	358	376	394	412	430
30	6.26	14.3	26.7	49.7	71.6	92.8	113	134	154	173	193	212	231	249	267	285	303	321	339	357	375	393	411	429	447
32	6.71	15.3	28.6	53.3	76.8	99.5	122	143	165	186	206	227	247	267	286	305	324	343	362	381	400	419	438	457	476
35	7.40	16.9	31.5	58.7	84.6	110	134	158	181	205	227	250	272	295	317	339	361	383	405	427	449	471	493	515	537
40	8.54	19.5	36.4	67.9	97.7	127	155	182	210	236	263	289	315	340	363	387	411	435	459	483	507	531	555	579	603
45	9.70	22.1	41.3	77.1	111	144	176	207	238	268	298	328	357	387	434	355	297	249	213	178	151	130
Lubrication	Type A	Type B						Type C																	

Type A Manual Lubrication
Type B Bath or Disc Lubrication
Type C Oil Stream Lubrication

Multiple Strand Factors

No. Strands	Strand Factor
1	1.0
2	1.9
3	2.8
4	3.7

SPROCKETS

Horsepower Ratings Single Strand Roller Chain



For Multiple Strand Ratings See Chart Page E-191

2" Pitch No. 160																								
No. of Teeth Small Sprocket	REVOLUTIONS PER MINUTE — SMALL SPROCKET																							
	10	25	50	100	150	200	250	300	350	400	450	500	550	600	650	700	750	800	850	900	1000	1100	1200	1300
11	3.07	7.01	13.1	24.4	35.2	45.6	55.7	65.6	75.4	85.0	94.5	96.6	83.7	73.5	65.2	58.3	52.6	47.7	43.6	40.0	34.1	29.6	26.0	23.0
12	3.38	7.70	14.4	26.8	38.6	50.1	61.2	72.1	82.8	93.4	104	110	95.4	83.7	74.2	66.4	59.9	54.4	49.6	45.6	38.9	33.7	29.6	26.3
13	3.68	8.40	15.7	29.2	42.1	54.6	66.7	78.6	90.3	102	113	124	108	94.4	83.7	74.9	67.5	61.3	56.0	51.4	43.9	38.0	33.4	29.6
14	3.99	9.10	17.0	31.7	45.6	59.1	72.3	85.2	97.8	110	123	135	120	105	93.6	83.7	75.5	68.5	62.6	57.4	49.0	42.5	37.3	33.1
15	4.30	9.80	18.3	34.1	49.2	63.7	77.9	91.7	105	119	132	145	133	117	104	92.8	83.7	76.0	69.4	63.7	54.4	47.1	41.4	...
16	4.61	10.5	19.6	36.6	52.7	68.3	83.5	98.4	113	127	142	156	147	129	114	102	92.2	83.7	76.4	70.2	59.9	51.9	45.6	...
17	4.92	11.2	20.9	39.1	56.3	72.9	89.1	105	121	136	151	166	161	141	125	112	101	91.7	83.7	75.8	65.6	56.9	49.9	...
18	5.23	11.9	22.3	41.6	59.9	77.6	94.8	112	128	145	161	177	175	154	136	122	110	99.9	91.2	83.7	71.5	62.0	54.4	...
19	5.55	12.7	23.6	44.1	63.5	82.2	101	118	136	153	171	188	190	167	148	132	119	108	98.9	90.8	77.6	67.2	59.0	...
20	5.86	13.4	25.0	46.6	67.1	86.9	106	125	144	162	180	198	205	180	160	143	129	117	93.1	83.7	72.6	63.7
21	6.18	14.1	26.3	49.1	70.7	91.6	112	132	152	171	190	209	221	194	172	154	139	126	115	105	90.1	78.1	68.5	...
22	6.50	14.8	27.7	51.6	74.4	96.3	118	139	159	180	200	220	237	208	184	165	149	135	123	113	96.6	83.7
23	6.82	15.6	29.0	54.2	78.0	101	124	146	167	189	210	231	251	222	197	176	159	144	132	121	103	98.5
24	7.14	16.3	30.4	56.7	81.7	106	129	152	175	197	220	241	263	237	210	188	169	154	140	129	110	95.4
25	7.46	17.0	31.8	59.3	85.4	111	135	159	183	206	229	252	275	252	223	200	180	164	149	137	117	101
26	7.78	17.8	33.1	61.8	89.1	115	141	166	191	215	239	263	287	267	237	212	191	173	158	145	124	108
28	8.43	19.2	35.9	67.0	96.5	125	153	180	207	233	259	285	311	298	265	237	214	194	177	162	139	120
30	9.08	20.7	38.7	72.2	104	135	165	194	223	251	279	307	335	331	293	263	237	215	196	180	154
32	9.74	22.2	41.5	77.4	111	144	176	208	239	269	300	329	359	365	323	289	261	237	216	198	169
35	10.7	24.5	45.7	85.2	123	159	194	229	263	297	330	363	395	417	370	331	298	271	247	227	180
40	12.4	28.3	52.8	98.5	142	184	225	265	304	343	381	419	457	494	452	404	365	331	302	257
45	14.1	32.1	59.9	112	161	209	255	301	345	389	433	476	519	561	538	482	418	348	271	189
Lubrication	Type A	Type B										Type C												

2 1/4" Pitch No. 180																								
No. of Teeth Small Sprocket	REVOLUTIONS PER MINUTE — SMALL SPROCKET																							
	10	25	50	100	150	200	250	300	350	400	450	500	550	600	650	750	800	850	900	950	1000	1050	1100	1150
11	4.24	9.68	18.1	33.7	48.6	62.9	76.9	90.6	104	117	124	106	92.0	80.7	71.6	57.8	52.4	47.9	43.9	40.5	37.5	34.9	32.5	...
12	4.66	10.6	19.8	37.0	53.4	69.1	84.5	99.6	114	129	142	121	105	92.0	81.6	65.8	59.7	54.6	50.1	46.2	42.8	39.7	37.1	...
13	5.08	11.6	21.6	40.4	58.2	75.4	92.1	109	125	141	156	136	118	104	92.0	74.2	67.4	61.5	55.5	52.1	48.2	44.8
14	5.51	12.6	23.4	43.7	63.0	81.6	99.8	118	135	152	169	152	132	116	103	82.9	75.3	68.7	63.1	58.2	53.9	50.1
15	5.93	13.5	25.3	47.1	67.9	88.0	108	127	146	164	182	169	146	129	114	92.0	83.5	76.2	70.0	64.5	59.7	55.5
16	6.36	14.5	27.1	50.5	72.8	94.3	115	136	156	176	196	186	161	142	126	101	92.0	84.0	77.1	71.1	65.8	61.2
17	6.79	15.5	28.9	54.0	77.7	101	123	145	167	188	209	204	177	155	138	111	101	92.0	84.4	77.9	72.1
18	7.22	16.5	30.8	57.4	82.7	107	131	154	177	200	222	222	193	169	150	121	110	100	92.0	84.8	78.5
19	7.66	17.5	32.6	60.8	87.6	114	139	164	188	212	236	241	209	183	163	131	119	109	99.8	92.0	85.2
20	8.10	18.5	34.5	64.3	92.6	120	147	173	199	224	249	260	226	198	175	142	129	117	108	99.3	92.0
21	8.53	19.5	36.3	67.8	97.6	126	155	182	209	236	262	280	243	213	189	152	138	126	116	107	99.0
22	8.97	20.5	38.2	71.3	103	133	163	192	220	248	276	300	260	228	203	163	148	135	124	115
23	9.41	21.5	40.1	74.8	108	140	171	201	231	260	290	318	278	244	216	175	159	145	133	123
24	9.86	22.5	42.0	78.3	113	146	179	210	242	273	303	333	296	260	231	186	169	154	142	131
25	10.3	23.5	43.9	81.8	118	153	187	220	253	285	317	348	315	277	245	198	180	164	151	139
26	10.7	24.5	45.7	85.4	123	159	195	229	264	297	331	363	334	293	260	210	191	174	160
28	11.6	26.6	49.6	92.5	133	173	211	249	286	322	358	394	374	328	291	235	213	194	178
30	12.5	28.6	53.4	99.6	144	186	227	268	308	347	386	424	414	364	322	260	236	216	198
32	13.4	30.7	57.2	107	154	199	244	287	330	372	414	455	456	401	355	287	260	238
35	14.8	33.8	63.1	118	170	220	268	316	363	410	456	501	522	458	406	328	291	220
40	17.3	39.0	72.9	136	196	254	310	365	420	473	526	579	575	524	465	324	244
45	19.4	44.3	82.7	154	222	288	352	415	477	538	598	631	578	514	441	271
Lubrication	Type A	Type B										Type C												

2 1/2" Pitch No. 200																		
No. of Teeth Small Sprocket	REVOLUTIONS PER MINUTE — SMALL SPROCKET																	
	10	15	20	30	40	50	70	100	150	200	250	300	350	400	450	550	650	
11	5.64	8.12	10.5	15.1	19.6	24.0	32.5	44.8	64.5	83.5	102	120	138	156	135	100	87.8	77.9
12	6.19	8.92	11.6	16.6	21.6	26.4	35.7	49.2	70.8	91.8	112	132	152	171	154	114	100	...
13	6.75	9.72	12.6	18.1	23.5	28.7	38.9	53.6	77.2	100	122	144	168	187	174	129	113	...
14	7.31	10.5	13.6	19.7	25.5	31.1	42.1	58.1	83.7	108	132	156	179	202	194	144	126	...
15	7.88	11.3	14.7	21.2	27.4	33.5	45.4	62.6	90.1	117	143	168	183	218	215	159	140	...
16	8.45	12.2	15.8	22.7	29.4	36.0	48.7	67.1	96.6	125	153	180	207	234	237	176	154	...
17	9.02	13.0	16.8	24.2	31.4	38.4	52.0	71.6	103	134	163	193	221	249	260	192	169	...
18	9.59	13.8	17.9	25.8	33.4	40.8	55.3	76.2	110	142	174	205	235	265	283	209	184	...
19	10.2	14.6	19.0	27.3	35.4	43.3	58.6	80.8	116	151	184	217	249	281	307	227	198	...
20	10.7	15.5	20.1	28.9	37.4	45.8	61.9	85.4	123	159	195	229	264	297	331	245
21	11.3	16.3	21.1	30.5	39.5	48.2	65.3	90.0	130	168	205	242	278	313	348	264
22	11.9	17.2	22.2	32.0	41.5	50.7	68.7	94.6	136	177	216	254	292	330	366	283
23	12.5	18.0	23.3	33.6	43.5	53.2	72.0	99.3	143	185	226	267	307	346	384	303
24	13.1	18.9	24.4	35.2	45.6	55.7	75.4	104	150	194	237	279	321	362	402</			



Horsepower Ratings Single Strand Roller Chain

For Multiple Strand Ratings See Chart at Bottom

3" Pitch No. 240																				
No. of Teeth in Small Sprocket	REVOLUTIONS PER MINUTE — SMALL SPROCKET																			
	5	10	15	20	25	30	40	50	60	80	100	125	150	175	200	250	300	350	400	450
11	4.86	9.08	13.1	16.9	20.7	24.4	31.6	38.6	45.5	59.0	72.1	88.1	104	119	135	164	194	223	187	156
12	5.34	9.97	14.4	18.6	22.7	26.8	34.7	42.4	50.0	64.8	79.2	96.8	114	131	148	181	213	245	218	...
13	5.83	10.9	15.7	20.3	24.8	29.2	37.9	46.3	54.5	70.6	86.4	106	124	143	161	197	232	267	240	...
14	6.31	11.8	17.0	22.0	26.9	31.7	41.0	50.1	59.1	76.5	93.6	114	135	155	175	213	251	289	268	...
15	6.80	12.7	18.3	23.7	28.9	34.1	44.2	54.0	63.6	82.4	101	123	145	167	188	230	274	311	297	...
16	7.29	13.6	19.6	25.4	31.0	36.6	47.4	57.9	68.2	88.4	108	132	156	179	202	247	290	334	328	...
17	7.78	14.5	20.9	27.1	33.1	39.0	50.6	61.8	72.9	94.4	115	141	166	191	215	263	310	356	359	...
18	8.28	15.4	22.3	28.8	35.2	41.5	53.8	65.8	77.5	100	123	150	177	203	229	280	330	379	377	...
19	8.78	16.4	23.6	30.6	37.4	44.0	57.0	69.7	82.2	106	130	159	187	215	243	297	360	402	393	...
20	9.28	17.3	24.9	32.3	39.5	46.5	60.3	73.7	86.8	112	138	168	198	228	257	314	370	423	407	...
21	9.78	18.2	26.3	34.1	41.6	49.0	63.5	77.7	91.5	119	145	177	209	240	270	331	390	439	424	...
22	10.3	19.2	27.6	35.8	43.8	51.6	66.8	81.7	96.2	125	152	186	220	252	284	348	410	454	435	...
23	10.8	20.1	29.0	37.6	45.9	54.1	70.1	85.7	101	131	160	195	230	265	298	365	430	469	448	...
24	11.3	21.1	30.4	39.3	48.1	56.7	73.4	89.7	106	137	167	205	241	277	312	382	450	483
25	11.8	22.0	31.7	41.1	50.3	59.2	76.7	93.8	110	143	175	214	252	290	327	399	470	496
26	12.3	23.0	33.1	42.9	52.4	61.8	80.0	97.8	115	149	183	223	263	302	341	416	491	509

American Standard No. 2040																	
No. of Effective Teeth in Small Sprocket	REVOLUTIONS PER MINUTE — SMALL SPROCKET																
	25	50	100	150	200	250	300	400	500	600	700	800	900	1000	1100	1200	1300
11	.202	.379	.687	.958	1.19	1.41	1.59	1.89	2.14	2.32							
12	.223	.419	.766	1.07	1.34	1.58	1.81	2.16	2.46	2.71	2.88						
13	.243	.458	.842	1.18	1.48	1.76	2.00	2.44	2.79	3.08	3.31	3.48					
14	.263	.497	.914	1.28	1.63	1.93	2.20	2.67	3.09	3.44	3.70	3.91	4.10				
15	.283	.535	.989	1.39	1.76	2.09	2.40	2.93	3.38	3.77	4.08	4.32	4.52	4.67			
16	.303	.572	1.06	1.49	1.89	2.25	2.59	3.17	3.67	4.09	4.44	4.73	4.96	5.13			
17	.322	.611	1.13	1.59	2.02	2.41	2.77	3.41	3.95	4.41	4.80	5.10	5.38	5.57	5.72		
18	.342	.648	1.20	1.70	2.15	2.57	2.94	3.63	4.21	4.71	5.13	5.48	5.76	5.97	6.15		
19	.361	.687	1.27	1.80	2.28	2.72	3.14	3.86	4.49	5.02	5.48	5.85	6.17	6.41	6.61	6.70	
20	.380	.720	1.34	1.90	2.40	2.87	3.29	4.07	4.72	5.29	5.76	6.17	6.50	6.77	6.98	7.13	
21	.399	.758	1.41	1.99	2.52	3.01	3.47	4.27	4.97	5.57	6.07	6.50	6.86	7.13	7.35	7.50	
22	.419	.794	1.48	2.08	2.64	3.15	3.63	4.48	5.20	5.83	6.37	6.81	7.18	7.48	7.71	7.87	
23	.437	.829	1.54	2.18	2.76	3.30	3.79	4.68	5.42	6.09	6.64	7.11	7.49	7.80	8.04	8.21	
24	.456	.866	1.60	2.27	2.88	3.44	3.96	4.87	5.67	6.35	6.92	7.40	7.80	8.12	8.37	8.54	
25	.475	.902	1.67	2.36	3.00	3.58	4.11	5.07	5.90	6.60	7.19	7.73	8.10	8.42	8.67	8.84	
30	.568	1.076	1.99	2.81	3.56	4.24	4.86	5.95	6.83	7.76	8.40	8.90	9.38	9.72	9.95	10.09	
35	.657	1.247	2.30	3.24	4.09	4.86	5.66	6.81	7.86	8.71	9.42	9.99	10.43	10.72	10.93	10.97	
40	.748	1.413	2.60	3.65	4.59	5.44	6.22	7.57	8.67	9.60	10.31	10.86	11.23	11.49	11.61		
Lubrication type	1			2				3									

American Standard No. 2050																	
No. of Effective Teeth in Small Sprocket	REVOLUTIONS PER MINUTE — SMALL SPROCKET																
	25	50	100	150	200	250	300	350	400	450	500	550	600	700	800	900	
11	.385	.72	1.29	1.78	2.19	2.56	2.85	3.12	3.33	3.53							
12	.428	.80	1.44	1.99	2.48	2.90	3.26	3.58	3.86	4.10	4.31						
13	.457	.87	1.59	2.20	2.74	3.23	3.65	4.03	4.36	4.66	4.91	5.11	5.30				
14	.506	.95	1.73	2.41	3.01	3.55	4.02	4.45	4.84	5.17	5.48	5.73	5.96				
15	.544	1.02	1.87	2.61	3.27	3.86	4.39	4.88	5.31	5.68	6.02	6.31	6.57	6.94			
16	.582	1.09	2.00	2.81	3.52	4.16	4.74	5.26	5.73	6.16	6.55	6.87	7.19	7.61			
17	.620	1.16	2.14	2.99	3.77	4.46	5.09	5.66	6.17	6.63	7.05	7.42	7.75	8.24	8.62		
18	.658	1.23	2.27	3.19	4.01	4.75	5.41	6.03	6.58	7.09	7.54	7.94	8.31	8.84	9.28		
19	.696	1.31	2.41	3.39	4.25	5.05	5.76	6.42	7.00	7.55	8.04	8.46	8.87	9.42	9.90		
20	.732	1.38	2.54	3.56	4.48	5.32	6.07	6.75	7.38	7.95	8.46	8.92	9.35	9.97	10.49		
21	.769	1.45	2.66	3.75	4.70	5.59	6.38	7.10	7.77	8.37	8.90	9.39	9.84	10.50	11.06		
22	.806	1.52	2.79	3.92	4.92	5.86	6.69	7.45	8.14	8.76	9.33	9.84	10.31	11.01	11.59		
23	.842	1.58	2.91	4.09	5.16	6.12	6.98	7.78	8.50	9.15	9.74	10.27	10.76	11.50	12.10		
24	.879	1.65	3.05	4.27	5.37	6.38	7.28	8.10	8.85	9.54	10.16	10.70	11.21	11.97	12.59		
25	.914	1.72	3.17	4.45	5.59	6.62	7.58	8.42	9.20	9.91	10.55	11.12	11.64	12.42	13.05		
30	1.092	2.06	3.77	5.28	6.63	7.84	8.93	9.92	10.82	11.62	12.35	12.99	13.57	14.39	15.06		
36	1.267	2.38	4.35	6.07	7.59	8.96	10.18	11.27	12.26	13.14	13.92	14.59	15.17	16.00	16.62		
40	1.44	2.70	4.91	6.82	8.51	10.00	11.33	12.51	13.57	14.49	15.26	15.95	16.57	17.29	17.78		
Lubrication type	1			2				3									

Type 1: Manual drip (4 to 10 drops per minute), or splash.
 Type 2: Rapid drip (20 drops per minute minimum), splash, or disc.
 Type 3: Disc or forced.

No. Strands	Strand Factor
2	1.7
3	2.5
4	3.3

SPROCKETS

Horsepower Ratings Single Strand Roller Chain



For Multiple Strand Ratings See Chart at Bottom

American Standard No. 2060																	
No. of Effective Teeth In Small Sprocket	REVOLUTIONS PER MINUTE — SMALL SPROCKET																
	25	50	75	100	125	150	200	250	300	350	400	450	500	550	600	650	700
11	.66	1.21	1.70	2.15	2.54	2.93	3.58	4.12	4.56	4.93							
12	.73	1.34	1.90	2.41	2.85	3.30	4.05	4.70	5.24	5.71	6.08						
13	.79	1.48	2.09	2.65	3.15	3.65	4.52	5.27	5.91	6.46	6.92	7.32					
14	.86	1.60	2.27	2.90	3.45	4.00	4.97	5.79	6.54	7.17	7.72	8.18	8.58				
15	.92	1.72	2.45	3.14	3.74	4.34	5.39	6.32	7.14	7.86	8.48	9.01	9.48				
16	.99	1.85	2.64	3.36	4.01	4.66	5.82	6.82	7.73	8.52	9.21	9.80	10.34	10.77			
17	1.05	1.97	2.82	3.59	4.28	4.98	6.22	7.32	8.29	9.14	9.91	10.56	11.14	11.64	12.06		
18	1.12	2.10	2.99	3.82	4.56	5.31	6.63	7.82	8.85	9.78	10.60	11.31	11.96	12.50	12.97		
19	1.18	2.23	3.17	4.05	4.83	5.62	7.03	8.29	9.42	10.41	11.29	12.08	12.76	13.35	13.87	14.30	
20	1.25	2.34	3.34	4.26	5.09	5.93	7.41	8.74	9.92	10.97	11.91	12.74	13.46	14.08	14.64	15.10	
21	1.31	2.46	3.51	4.49	5.36	6.24	7.80	9.19	10.43	11.55	12.52	13.40	14.14	14.83	15.42	15.90	
22	1.37	2.58	3.67	4.70	5.62	6.54	8.16	9.62	10.93	12.08	13.13	14.04	14.84	15.55	16.15	16.67	
23	1.44	2.69	3.83	4.90	5.86	6.83	8.53	10.06	11.42	12.62	13.71	14.67	15.49	16.22	16.87	17.38	
24	1.50	2.80	4.00	5.11	6.11	7.12	8.90	10.47	11.90	13.16	14.28	15.27	16.14	16.89	17.56	18.11	
25	1.56	2.92	4.17	5.32	6.36	7.41	9.27	10.89	12.37	13.67	14.84	15.86	16.76	17.53	18.21	18.79	
30	1.86	3.48	4.96	6.32	7.55	8.78	10.94	12.76	14.55	16.05	17.38	18.54	19.53	20.38	21.11	21.70	
35	2.16	4.03	5.73	7.29	8.67	10.06	12.52	14.67	16.54	18.17	19.61	20.80	21.88	22.73	23.40	23.99	
40	2.45	4.55	6.46	8.20	9.70	11.31	13.99	16.33	18.35	20.08	21.57	22.84	23.86	24.64	25.42		
Lubrication Type	1					2					3						

American Standard No. 2080																	
No. of Effective Teeth In Small Sprocket	REVOLUTIONS PER MINUTE — SMALL SPROCKET																
	10	20	30	40	50	60	70	80	90	100	150	200	250	300	350	400	450
11	.66	1.24	1.78	2.26	2.76	3.20	3.60	3.99	4.38	4.78	6.36	7.60					
12	.72	1.37	1.96	2.52	3.08	3.56	4.03	4.48	4.92	5.36	7.20	8.68	9.82				
13	.79	1.49	2.15	2.77	3.36	3.91	4.44	4.95	5.45	5.93	8.02	9.73	11.08				
14	.85	1.62	2.33	3.01	3.66	4.26	4.85	5.42	5.96	6.49	8.82	10.75	12.29	13.60			
15	.91	1.74	2.52	3.25	3.95	4.60	5.25	5.86	6.45	7.03	9.60	11.74	13.46	14.94			
16	.98	1.87	2.70	3.48	4.24	4.94	5.64	6.29	6.93	7.56	10.36	12.70	14.59	16.24	17.65		
17	1.04	1.99	2.88	3.71	4.52	5.28	6.02	6.72	7.40	8.09	11.10	13.63	15.69	17.50	19.04		
18	1.11	2.11	3.05	3.94	4.80	5.61	6.40	7.14	7.87	8.60	11.82	14.53	16.76	18.72	20.38	21.77	
19	1.17	2.23	3.23	4.17	5.09	5.94	6.77	7.56	8.33	9.10	12.52	15.40	17.80	19.90	21.67	23.18	
20	1.23	2.35	3.40	4.40	5.36	6.26	7.13	7.98	8.78	9.60	13.20	16.25	18.81	21.04	22.91	24.52	
21	1.29	2.47	3.57	4.62	5.62	6.58	7.49	8.39	9.23	10.09	13.87	17.08	19.79	22.14	24.11	25.80	
22	1.36	2.58	3.74	4.84	5.90	6.89	7.84	8.79	9.67	10.57	14.53	17.90	20.74	23.20	25.27	27.03	
23	1.42	2.70	3.90	5.06	6.16	7.20	8.19	9.18	10.10	11.05	15.18	18.71	21.66	24.23	26.40	28.22	
24	1.48	2.82	4.05	5.27	6.43	7.51	8.54	9.56	10.53	11.52	15.82	19.51	22.55	25.23	27.50	29.38	
25	1.54	2.92	4.20	5.48	6.69	7.81	8.89	9.94	10.95	11.98	16.45	20.30	23.42	26.20	28.57	30.52	
30	1.84	3.50	5.02	6.54	7.96	9.29	10.59	11.74	12.97	14.23	19.46	23.91	27.52	30.70	33.56	35.52	
35	2.14	4.07	5.82	7.56	9.19	10.71	12.21	13.48	14.92	16.35	22.26	27.23	31.21	34.65	37.57	39.66	
40	2.43	4.61	6.60	8.55	10.38	12.09	13.76	15.17	16.80	18.36	24.88	30.28	34.52	38.09	40.96	43.07	
Lubrication Type	1					2					3						

Type 1: Manual drip (4 to 10 drops per minute), or splash.
 Type 2: Rapid drip (20 drops per minute minimum), splash, or disc.
 Type 3: Disc or forced.

No. Strands	Strand Factor
2	1.7
3	2.5
4	3.3

SPROCKETS

ENGINEERED CLASS SPROCKETS

PRODUCT	PAGE
INDEX	F-1
MADE-TO-ORDER CAPABILITIES	F-3
INSTANT SPLIT® SPROCKETS	F-5
SOLID AND SPLIT DETACHABLE HUBS	F-6
SHEAR PIN SPROCKETS	F-7– F-9
ACCU-TORCH® SPROCKETS	F-10 – F-15
1.654 PITCH (62)	F-11
2.609 PITCH (78)	F-11
3.067 PITCH (1568)	F-12
3.075 PITCH (1030)	F-12
3.075 PITCH (82)	F-13
3.500 PITCH (238)	F-13
4.000 PITCH (124)	F-14
4.063 PITCH (1240)	F-14
4.500 PITCH (635)	F-15
5.000 PITCH (1207)	F-15
6.050 PITCH (132)	F-15
81X HOOKED TOOTH	F-16
Star Gear	F-16
WARNING & SAFETY REMINDER	Opposite Page

Steel Accu-Torch® Sprockets for Engineering Chains

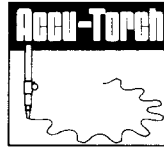

Martin

Accu-Torch

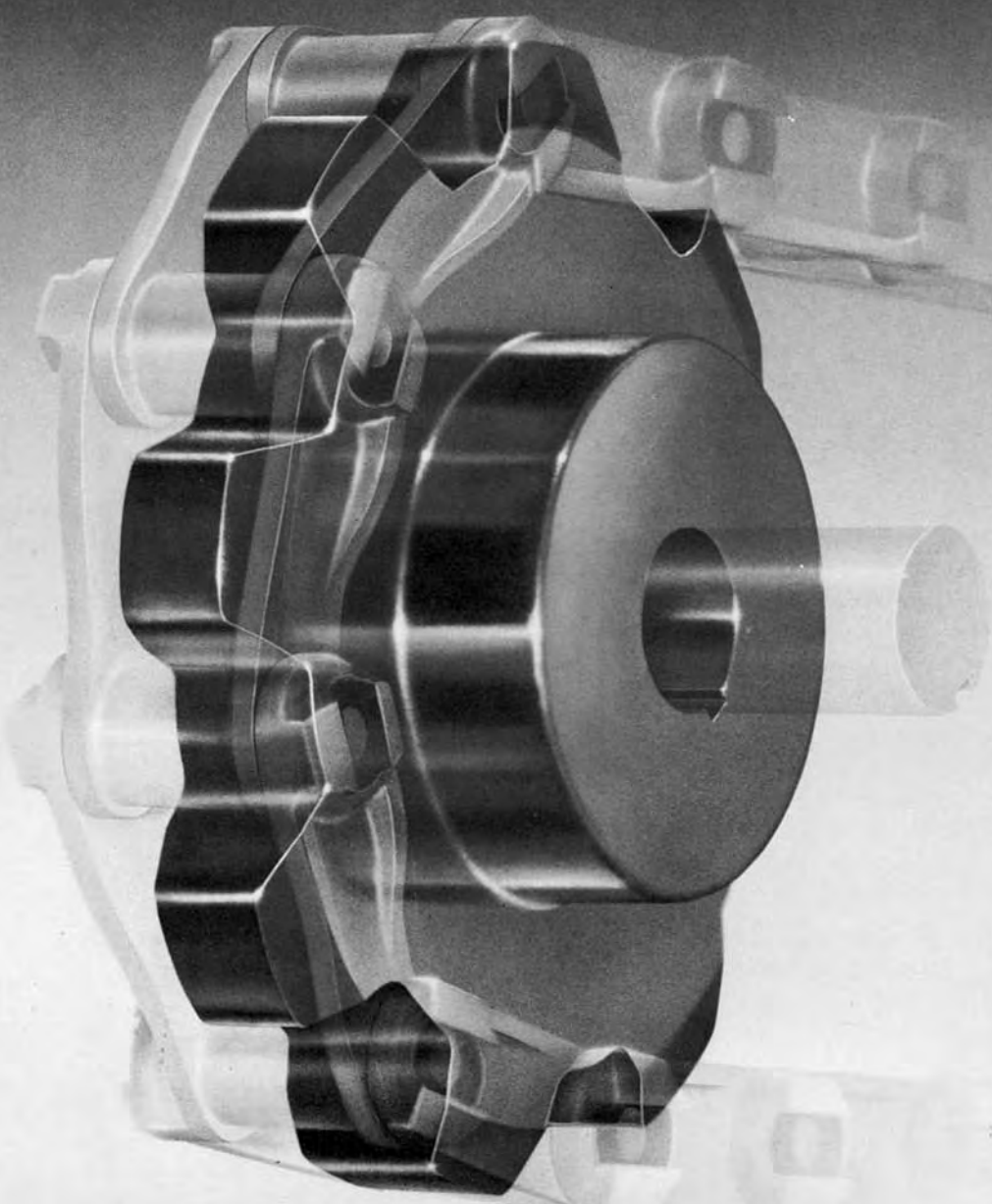

ENGINEERED

Special Engineered Class Sprockets



SPECIAL SPLIT ACCU-TORCH®



**SPLINED MUD RELIEF
ACCU-TORCH®**



**SPECIAL ACCU-TORCH®
FOR SEWAGE TREATMENT**



**10 FT. DIAMETER ACCU-TORCH®
FOR PAPER MILLS**

ENGINEERED

For quality and dependable service, call *Martin* for all your made-to-order requirements.

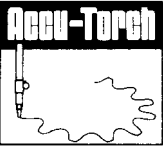

Steel Sprockets

Martin

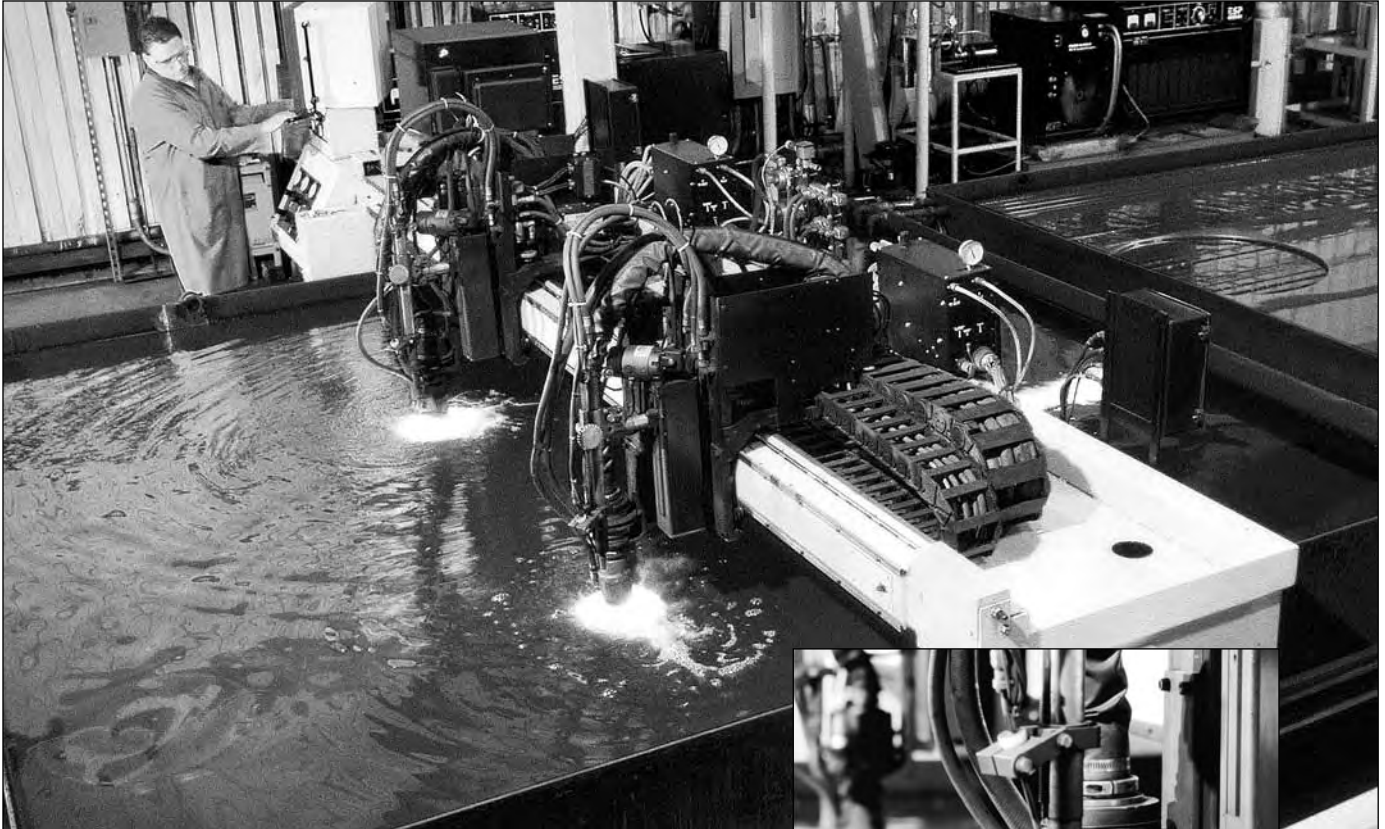

ENGINEERED

Martin Accu-Torch® steel sprockets are available for virtually all engineering class chains in style A, B, and C. Also available as split with welded hub and split or solid detachable hub. May also be furnished as shear pin type. Send us your inquiries.

Where possible please specify chain number, pitch diameter, number of teeth, bore and keyway size, and hub style required.

Accu-Torch® sprockets are not intended to replace cut tooth roller chain sprockets.

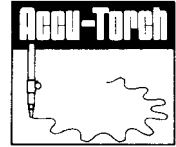

Martin Instant Split®/Accu-Torch® sprockets offer unlimited design and are simply installed with a hand wrench... greatly reducing costly downtime.



Accu-Torch® Size for Instant Split® Hubs

Split Hub Number	Bore	Minimum Number of Teeth										
		Chain Number/Pitch										
		62 1.654	78 2.609	1568 3.067	1030 3.075	82 3.075	238 3.500	124 4.000	1240 4.063	635 4.500	1207 5.000	132 6.050
S-1	¾"-1½"	9	7									
S-2	1½"-2¼"	12	8	8	8	7	8	6	7			
S-3	2"-3"	15	10	10	9	9	9	7	8	8		
S-4	2¾"-4"	18	12	12	11	11	10	9	9	9	8	
S-5	3¾"-5"	21	14	13	13	12	12	10	10	10	9	7
S-6	4¾"-6"	23	15	14	14	13	13	11	11	11	10	8
S-7	5¾"-7"	27	18	16	16	15	15	12	13	12	11	9
S-8	6¾"-8"	31	20	18	18	17	16	14	14	14	13	10

Total list price of *Martin* Split-Sprocket is simply the hub price plus the plate price.

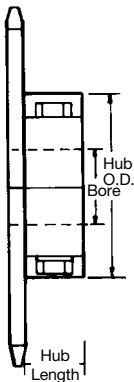

Pricing Example Style B
1030B25 Split with S-3 Hub,
2½" Bore, KW & SS

S-3 Hub
1030A25 Plate

See Hub List
See Plate List
Total Price List

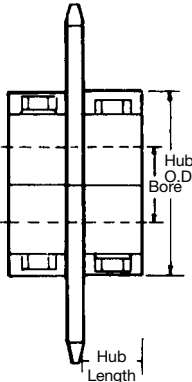

Pricing Example Style C
1030G25 Split with S-3 Hubs,
2½" Bore, KW & SS

Two S-3 Hubs
1030A25 Plate

See Hub List
See Plate List
Total Price List

Instant Split Hubs are for use
with Plate Sprockets only.

Hub Number	Bore	Hub O.D.	Hub★ Length	Bolts	Weight Lbs.
S-1	¾"-1½"	3¾"	1"	¾" x 2¼"	1.8
S-2	1½"-2¼"	4¾"	1¼"	½" x 3"	4.1
S-3	2"-3"	6"	1½"	¾" x 4½"	8.4
S-4	2¾"-4"	7¾"	1¾"	¾" x 5½"	14.4
S-5	3¾"-5"	9¾"	2"	1" x 6"	27.8
S-6	4¾"-6"	10¾"	2¼"	1" x 6"	35.4
S-7	5¾"-7"	12½"	2½"	1" x 7"	64.4
S-8	6¾"-8"	14¾"	3"	1" x 8"	98.5

★Add hub length to plate thickness to determine length thru bore.

For style C, add hub length X 2.

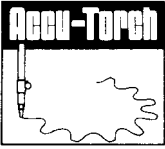

Solid and Split Detachable Hubs



TYPE D SPROCKETS — STOCK DETACHABLE HUBS

Type D sprockets consist of a Type A plate sprocket bolted to a detachable hub. A solid or split plate sprocket may be assembled to a solid or split hub. When ordering a Type D sprocket, be sure to select a plate sprocket large enough to allow chain clearance over the hub flange diameter, dimension D.

Bolt holes of Type D hubs are drilled for interchangeability. Speed ratios may be changed simply by removing the plate sprocket and substituting another with a different number of teeth. When worn, the sprocket may be reversed to use the unworn tooth surfaces, increasing the life of the sprocket.

Solid Hubs - Steel — Dimensions (Inches)

Hub Number	Bore Range A		Hub Diameter B	Bolt Circle C	Flange Diameter D	Bolt Holes		E	F	G*	L
	Stock	Maximum				Number	Bolt Size				
101	5/8	1 1/4	2 1/2	3 3/8	4 1/2	6	5/8	1/2	3/8	1 1/8	2
102	1 1/16	2	3	4	5	6	7/16	1/2	1/2	1 1/8	2 1/2
103	1 1/8	2 1/2	4	5 1/8	6	6	1/2	1/2	3/8	1 1/8	2 3/4
104	2 1/16	3	4 1/2	5 5/8	7	6	5/8	1/2	3/8	2	3 1/4
105	2 1/8	3 1/4	5	6 1/4	7 1/2	6	5/8	3/4	1/2	2 1/2	4
106	2 3/16	3 3/4	5 1/2	7	8 1/2	6	3/4	3/4	1	2 3/4	4
107	3 1/16	4	6	7 1/2	9	6	3/4	3/4	1 1/4	2 3/4	4 1/4
108	3 3/16	4 1/2	7	8 3/8	10 1/8	6	3/4	3/4	1 1/8	2 1/2	4 1/2
109	4 1/16	7	10 1/2	13	15 1/2	6	1	3/4	1 1/2	2 3/4	5

*Maximum bores shown are maximum bores with standard keyseat and setscrew.

ENGINEERED

ALTERATION CHARGES

See current list price and discount sheet for alteration charges.

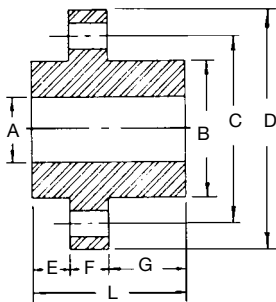

The List Price as shown in the List Price Book is for hub with stock bore. To obtain the price of a complete Type D sprocket add the List Price of hub plus alteration charges and the List Price of the desired Type A plate sprocket, including rebore, bolt hole drilling, and splitting charge if desired.

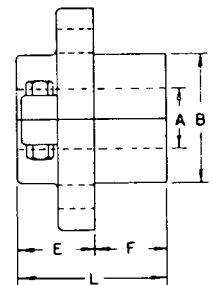
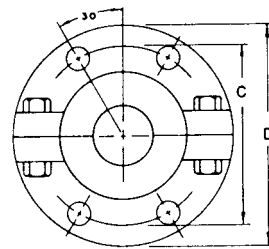

SOLID HUBS — STEEL

SPLIT HUBS — CAST IRON

Split Hubs - Cast Iron — Dimensions (Inches)

Hub Number	Bore Range A		Hub Diameter B	Bolt Circle C	Flange Diameter D	Bolt Holes		E	F*	L
	Stock	Maximum				Number	Bolt Size			
102S	1 1/16	1 1/2	3	4	5	4	7/16	1 1/4	1 1/8	3 1/2
103S	1 1/8	2 1/4	4	5 1/8	6	4	1/2	2	1 1/2	3 1/2
104S	2 1/16	2 1/2	4 1/2	5 5/8	7	4	5/8	2 1/4	1 3/8	4
105S	2 1/8	2 3/4	5	6 1/4	7 1/2	4	5/8	2 1/4	1 3/8	4 1/4
106S	2 3/16	3 1/4	5 1/2	7	8 1/2	4	3/4	2 1/2	2	4 1/4
107S	3 1/16	3 3/4	6	7 1/2	9	4	3/4	3	1 3/8	4 3/4
108S	3 3/16	4	7	8 3/8	10 1/8	4	3/4	3 3/8	1 3/8	5 1/4
109S	4 1/16	6	10 1/2	13	15 1/2	4	1	4 1/4	1 3/8	5 3/4

Maximum bores shown are maximum bores with standard keyseat and setscrew.

* Plate thickness of Accu-Torch not recommended if larger than dimension listed.

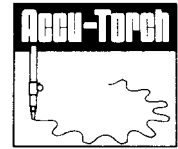

Shear pin sprockets provide simple, dependable protection against expensive machinery damage caused by overloads or jamming. Torque is transmitted by a single pin, necked to shear when the safe load is exceeded. When an overload occurs, the pin shears, disconnecting the drive immediately.

The Bolt-On Shear Pin Adapter converts any plate sprocket into a stock shear pin sprocket allowing immediate delivery of stock shear pin sprockets.

Selection guide on page F-9 gives complete procedure to select the proper shear pin assembly.

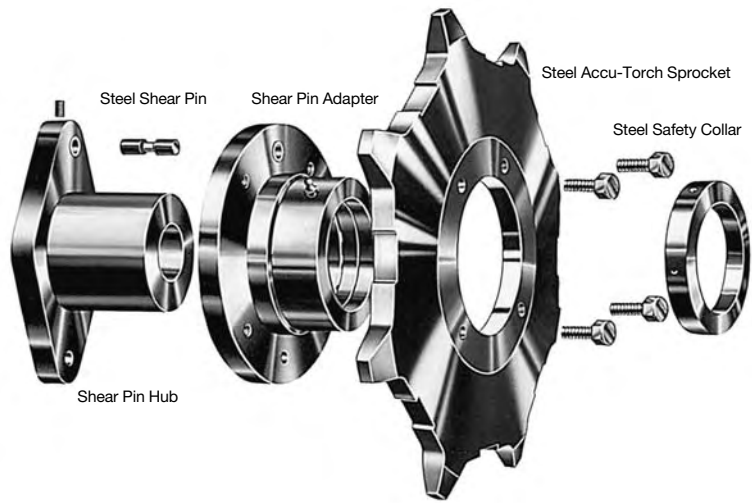

Stock Shear Pin Assemblies

Shear Pin Assembly Number	Hub Bore Range	Shear Pin Hub	Shear Pin Adapter
		Catalog Number	Catalog Number
SP-17	1" & UNDER	SPH-17	SPA-17
SP-18		SPH-18	SPA-18
SP-19		SPH-19	SPA-19
SP-20	1 ¹ / ₁₆ -1 ¹ / ₄	SPH-20	SPA-20
SP-21		SPH-21	SPA-21
SP-22		SPH-22	SPA-22
SP-23	2 ¹ / ₁₆ -2 ¹ / ₄	SPH-23	SPA-23
SP-24		SPH-24	SPA-24
SP-25		SPH-25	SPA-25
SP-26	3 ¹ / ₁₆ -3 ¹ / ₂	SPH-26	SPA-26
SP-27		SPH-27	SPA-27
SP-28		SPH-28	SPA-28
SP-29	4 ¹ / ₁₆ -5	SPH-29	SPA-29
SP-30		SPH-30	SPA-30
SP-31		SPH-31	SPA-31

NOTES ON PRICING:

Shear Pin Hub List Price includes any finished bore within the stated range, standard keyway and setscrew, hardened steel shear pin bushing.

Shear Pin Adapter List Price includes the shear pin bushing, grease fitting.

Complete Assembly List Price includes all components of the shear pin assembly as described above. Total list price of any shear pin sprocket is the complete assembly list price plus the list price of the desired plate sprocket (from tables of stock sprocket list prices).

Replacement Sprockets should be priced as altered stock sprockets directly from List Price and Alteration Charge tables.

Shear Pin Components may be ordered separately and will be treated as stock items when conforming to standard specifications and descriptions above.

PRICING EXAMPLES:

1. Stock Shear Pin Accu-Torch Sprocket

To price a 25 tooth shear pin sprocket for 1030 chain (1030SP25) using SP-26 shear pin assembly with 3¹/₁₆" bore, standard keyway and setscrew:

SP-26 Assembly See List
1030A25 Price Sheet

2. Shear Pin Adapter and Sprocket for Existing Hub

To price a "Bolt-on" shear pin adapter and sprocket to replace the sprocket part of existing 78A12 using SP-20 hub:

SPA-20 Adapter See List
78A12 Price Sheet

Shear Pin Sprockets can also be furnished in other standard styles or made to customers specifications. Price on application.

It is important that torque requirement for selected hub be checked in torque rating on page F-9 and neck diameter of shear pins be specified.

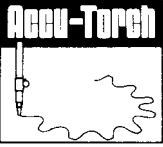

Bolt-On Shear Pin Accu-Torch® Sprockets

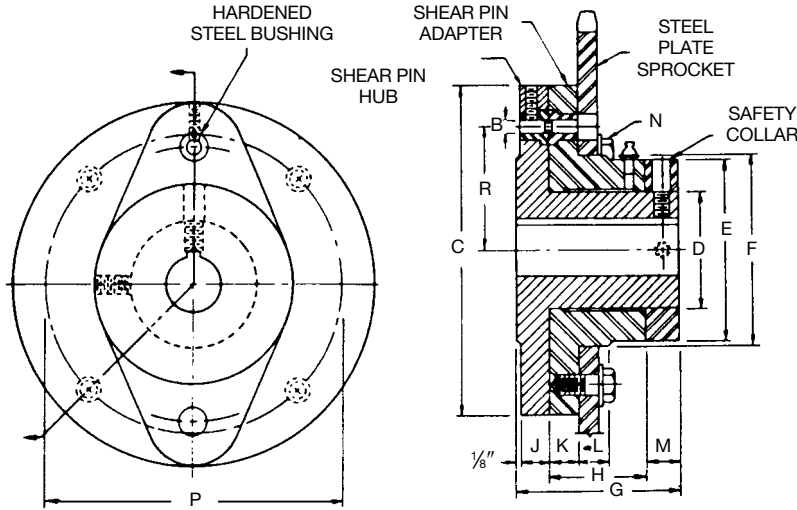

Sprocket Sizes for Stock Shear Pin Assemblies

Shear Pin Assembly Number	Hub Bore Range	Minimum Number of Teeth															
		Chain Number/Pitch															
		62 1.654	78 2.609	1568 3.067	1030 3.075	82 3.075	238 3.500	124 4.000	1240 4.063	635 4.500	1207 5.000	132 6.050					
SP-19	1 ¹ / ₆ -1 ¹ / ₂	16															
SP-20	1 ¹ / ₆ -1 ¹ / ₂	17	12														
SP-21	1 ¹ / ₆ -2	19	13					11									
SP-22	2 ¹ / ₆ -2 ¹ / ₂	21	14	13	13			12	12								
SP-23	2 ¹ / ₆ -2 ¹ / ₂	22	15	14	13			13	12	10							
SP-24	2 ¹ / ₆ -2 ¹ / ₂	25	16	15	15			14	13	11	12		11				
SP-25	2 ¹ / ₆ -3	26	18	16	16			15	14	12	13		12				
SP-26	3 ¹ / ₆ -3 ¹ / ₂	28	19	17	17			16	15	13	13		13				
SP-27	3 ¹ / ₆ -4	32	21	19	19			18	17	14	15		14				
SP-28	4 ¹ / ₆ -4 ¹ / ₂	34	22	20	20			19	18	15	15		15				
SP-29	4 ¹ / ₆ -5	36	24	21	21			20	19	16	16		16				
SP-30	4 ¹ / ₆ -5 ¹ / ₂	41	27	24	23			23	21	18	18		17				
SP-31	5 ¹ / ₆ -6	45	30	26	25			25	23	20	20		19				

AVAILABLE AS MADE TO ORDER
CHECK YOUR NEAREST MARTIN FACILITY

Shear Pin Assembly Dimensions (Inches)

Shear Pin Assembly Number	Shear Pin		Diameters				Length Thru			Hub Flange Thickness	Adapter Flange Thickness	Sprocket Seat Width	Bolts		Weight (lbs.)	
	Radius	Pin Diameter	Flange	Shear Pin Hub	Adapter Hub & Collar	Sprocket Seat	Shear Pin Hub	Adapter	Collar				Number & Size	Bolt Circle	Shear Pin Hub	Shear Pin Adapter
SP-19	2 ¹ / ₆	3 ¹ / ₆	6 ¹ / ₂	2 ³ / ₄	4	4 ¹ / ₂	3 ³ / ₈	2 ¹ / ₂	3 ¹ / ₄	1 ¹ / ₂	1 ¹ / ₂	1 ¹ / ₂	4-1/2"	5 ¹ / ₂	7.2	7.6
SP-20	3	3 ¹ / ₈	7 ¹ / ₂	3 ³ / ₄	4 ¹ / ₂	4 ¹ / ₂	4 ¹ / ₂	2 ¹ / ₂	3 ¹ / ₄	1 ¹ / ₂	1 ¹ / ₂	1 ¹ / ₂	4-1/2"	6 ¹ / ₄	11.0	11.9
SP-21	3 ³ / ₈	3 ¹ / ₂	8 ¹ / ₂	3 ³ / ₄	5 ¹ / ₂	5 ¹ / ₂	4 ¹ / ₂	2 ¹ / ₂	3 ¹ / ₄	1 ¹ / ₂	1 ¹ / ₂	1 ¹ / ₂	4-3/8"	7	16.2	16.9
SP-22	3 ¹ / ₂	3 ¹ / ₂	9 ¹ / ₂	4 ¹ / ₂	6 ¹ / ₂	6 ¹ / ₂	5 ¹ / ₂	3	1	1 ¹ / ₂	1 ¹ / ₂	1 ¹ / ₂	4-3/8"	8	23.3	24.5
SP-23	4	3 ¹ / ₂	10	4 ¹ / ₂	6 ¹ / ₂	6 ¹ / ₂	5 ¹ / ₂	3 ¹ / ₂	1	1 ¹ / ₂	1 ¹ / ₂	1 ¹ / ₂	4-3/8"	8 ¹ / ₄	26.3	27.7
SP-24	4 ¹ / ₂	3 ¹ / ₂	11 ¹ / ₂	5	7	7 ¹ / ₂	6 ¹ / ₂	3 ¹ / ₂	1 ¹ / ₂	1 ¹ / ₂	1 ¹ / ₂	1 ¹ / ₂	4-5/8"	9 ¹ / ₄	40.4	38.6
SP-25	4 ¹ / ₂	3 ¹ / ₂	12 ¹ / ₂	5 ¹ / ₂	8	8 ¹ / ₂	6 ¹ / ₂	4 ¹ / ₂	1 ¹ / ₂	1 ¹ / ₂	1 ¹ / ₂	1 ¹ / ₂	6-3/8"	10 ¹ / ₄	52.6	53.6
SP-26	5 ¹ / ₆	3 ¹ / ₂	13 ¹ / ₂	6 ¹ / ₂	8 ¹ / ₂	8 ¹ / ₂	7 ¹ / ₂	4 ¹ / ₂	1 ¹ / ₂	1 ¹ / ₂	1 ¹ / ₂	1 ¹ / ₂	6-3/8"	11 ¹ / ₄	66.7	66.8
SP-27	6 ¹ / ₆	3 ¹ / ₂	15 ¹ / ₂	7	10	10 ¹ / ₂	8 ¹ / ₂	5 ¹ / ₂	1 ¹ / ₂	1 ¹ / ₂	1 ¹ / ₂	1 ¹ / ₂	6-3/8"	12 ¹ / ₄	96.5	100.0
SP-28	6 ¹ / ₆	3 ¹ / ₂	16 ¹ / ₂	7 ¹ / ₂	10 ¹ / ₂	10 ¹ / ₂	9 ¹ / ₂	6 ¹ / ₂	1 ¹ / ₂	1 ¹ / ₂	1 ¹ / ₂	1 ¹ / ₂	6-3/4"	13 ¹ / ₂	125.0	115.0
SP-29	7 ¹ / ₆	3 ¹ / ₂	17 ¹ / ₂	8 ¹ / ₂	12	12 ¹ / ₂	10 ¹ / ₂	7	1 ¹ / ₂	1 ¹ / ₂	1 ¹ / ₂	1 ¹ / ₂	6-1"	14 ¹ / ₄	160.0	150.0
SP-30	8 ¹ / ₆	1	20 ¹ / ₂	9 ¹ / ₂	13 ¹ / ₂	13 ¹ / ₂	11 ¹ / ₂	7 ¹ / ₂	2	2 ¹ / ₆	1 ¹ / ₂	1 ¹ / ₂	6-1"	17	215.0	207.0
SP-31	8 ¹ / ₆	1 ¹ / ₂	22 ¹ / ₂	10 ¹ / ₂	15	15 ¹ / ₂	12 ¹ / ₂	8 ¹ / ₄	2 ¹ / ₄	2 ¹ / ₆	1 ¹ / ₂	1 ¹ / ₂	6-1"	18 ¹ / ₄	318.0	265.0

ENGINEERED



Bolt-On Shear Pin Accu-Torch® Sprockets

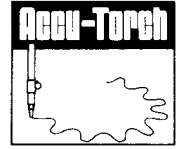

Shear Pin Sprocket Selection

- The shear pin assembly required is determined by the shaft size. Select the smallest shear pin assembly which will accommodate the required bore. Table on page 130 contains the bore ranges and minimum sprocket sizes which allow chain clearance over the shear pin assembly flange.
- Using one of the following formulas, compute the torque load the pin must transmit and enter the torque rating table below to obtain the proper shear pin neck diameter.

$$T = \frac{HP \times 63,000 \times 1.5}{RPM} \quad \text{or} \quad T = \frac{D \times CP \times 1.5}{2}$$

or $T = \text{Output of reducer} \times \text{speed ratio of chain drive} \times 1.5$

Where:

- T = Torque in pound inches
- HP = Horsepower at sprocket
- RPM = Sprocket speed
- D = Pitch diameter of sprocket
- CP = Chain pull in pounds
- 1.5 = Safety factor for starting load

EXAMPLE:

- Determine the shear pin assembly and pin neck diameter to transmit 20 horsepower at 67 RPM with a 36 tooth, No. 62 sprocket on a 2¹⁵/₁₆" shaft.

(1) Referring to Table I, shear pin assembly SP-25 is required for a 2¹⁵/₁₆" bore. The 36 tooth sprocket is well above the minimum size.

(2) Torque and neck diameter:

$$T = \frac{HP \times 63,000 \times 1.5}{RPM}$$

$$T = \frac{20 \times 63,000 \times 1.5}{67} = 28,200 \text{ lb. in.}$$

Referring to Table II under SP-25, a pin necked to ³/₈" shows a torque rating of 29,810 lb. in., which exceeds the 28,200 lb. in. required.

(3) Order: 62SP36, SP-25 assembly with 2¹⁵/₁₆" bore and ³/₈" pin neck diameter.

Shear Pin Torque Ratings

Shear Pin Neck Diameter (Inches)	Torque Rating — Pound Inches												
	Shear Pin Hub Number												
	SP19	SP20	SP21	SP22	SP23	SP24	SP25	SP26	SP27	SP28	SP29	SP30	SP31
³ / ₃₂	1022	1204	1323	1556	1603								
¹ / ₁₆	1752	2064	2268	2616	2748								
⁵ / ₃₂	2774	3268	3591	4142	4351	4750							
³ / ₁₆	3942	4944	5103	5886	6183	6750	7317						
⁷ / ₃₂	5402	6364	6993	8066	8473	9250	10027						
¹ / ₈	7300	8600	9450	10900	11450	12500	13550	15200	17300	18400			
⁹ / ₃₂	9052	10664	11718	13516	14198	15500	16802	18848	21452	22816			
⁵ / ₁₆	11096	13072	14364	16568	17403	19000	20596	23140	26296	27968	30932		
¹¹ / ₃₂		15824	17388	20056	21068	23000	24932	27968	31832	33856	37440		
³ / ₈		18920	20790	23980	25190	27500	29810	33440	38060	40480	44770	51040	
¹³ / ₃₂			24570	28340	29170	32500	35230	39520	44980	47840	52910	60320	
⁷ / ₁₆			28350	32700	34350	37500	41650	45600	51900	55200	61050	69600	
¹⁵ / ₃₂				37060	38930	42500	46070	51680	58820	62560	69190	78880	
¹ / ₂				42728	44884	49000	53116	59584	67816	72128	79772	90944	
¹⁷ / ₃₂						55000	59620	66880	76120	80960	89540	102080	
⁹ / ₁₆						62000	67280	75392	85808	91264	100936	115072	
¹⁹ / ₃₂							73220	82080	93420	99360	109890	125280	136890
⁵ / ₈							82800	92720	105530	112240	124135	141520	154635
²¹ / ₃₂								103360	117640	126120	138380	157760	172380
¹¹ / ₁₆								112480	128020	136160	150590	171680	187590
²³ / ₃₂									138400	147200	162800	185600	202800
³ / ₄									152240	161920	179080	204160	223080
²⁵ / ₃₂											195360	222720	243360
¹³ / ₁₆											211640	241280	263640
²⁷ / ₃₂											227920	259840	283920
⁷ / ₈											244200	278400	304200
²⁹ / ₃₂												296960	324480
¹⁵ / ₁₆												301600	329550
³¹ / ₃₂												338720	370110
1												371200	405600
¹ / ₁₆													446160
¹ / ₈													507000

ENGINEERED

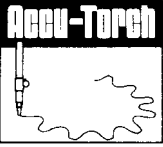

Flame Cut Sprockets For Engineering Chains

Martin



Conveyor Style Tooth for Chains:
78 — 82 — 124 — 132



Driver Style Tooth for Chains:
62 — 1568 — 1030 — 238 — 1240 — 635

ENGINEERED

Typical "Drive" & "Conveyor" Sprocket Tooth Form

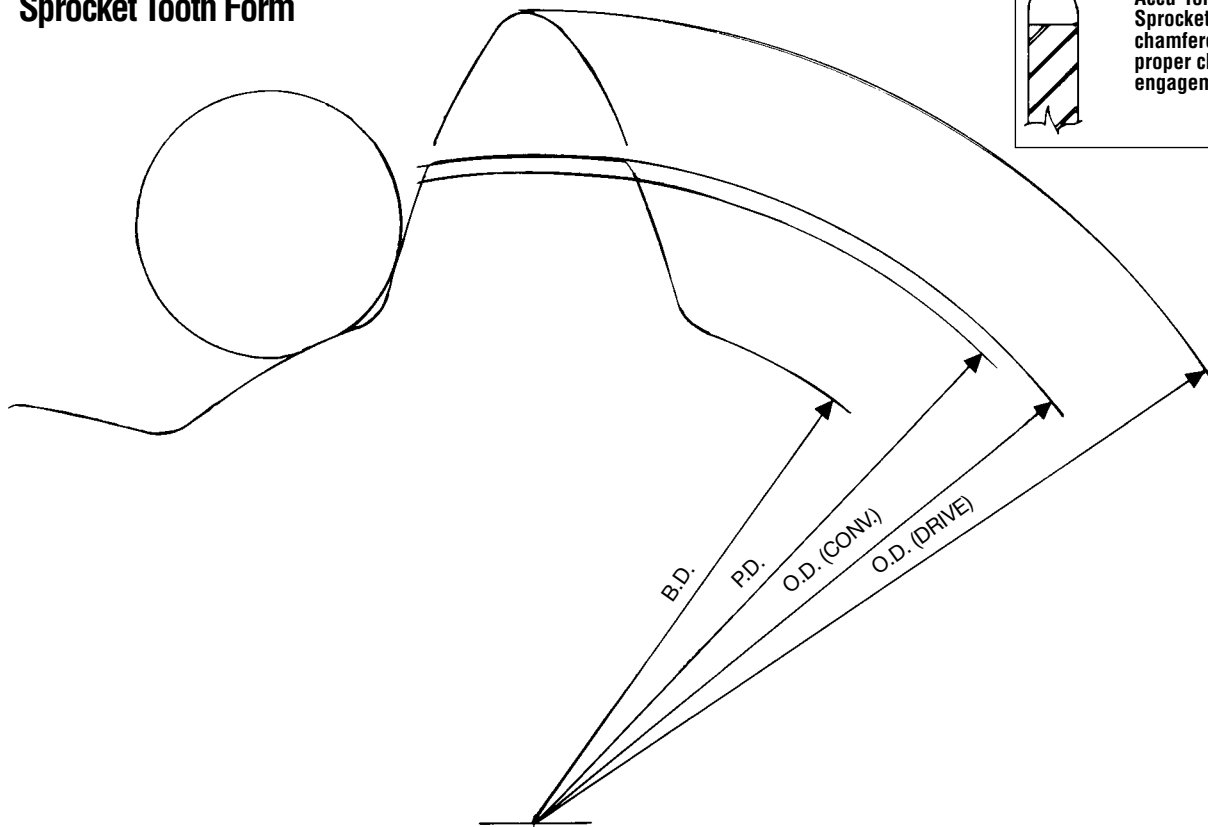

NOTE: All *Martin* Accu-Torch Sprockets have chamfered teeth for proper chain engagement.

Accu-Torch Sprockets are not intended to replace cut tooth roller chain sprockets.

NOTE: For style other than Type "C" or Type "A", or Tooth Size not shown, consult factory for price. See Current List Price Sheet for Stock Pricing.



Flame Cut Sprockets for Engineering Chains

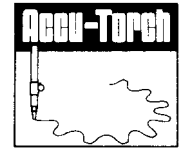

62 FLAME CUT SPROCKETS FOR CHAINS:

62 CAST — 2 — 062 — 62 Steel — 62A — HF 62 A — 62 H — H 62 — 072 — 72½ — 162 — R 362 — RR 362 — R432 — RR 432 — 962 — LXS 627 — IS 620 — 162 R — US 622 — 378 R — 402 RX — US 620

Type C — 1.654" Pitch

PLATE THICKNESS 3/4"
ROLLER DIAMETER 13/16"

Type A

Number of Teeth	Catalog Number	Pitch Diameter	Stock Bore	Max. Bore	Hub Diameter	L.T.B.	Approximate Weight	Catalog Number	Stock Bore	Approximate Weight
12	62C12	6.39	5/16	2 3/4	4 1/4	3 3/8	15.8	62A12	15/16	6.8
13	62C13	6.91	5/16	3 1/4	4 3/4	3	19.4	62A13	15/16	8
14	62C14	7.43	5/16	3 3/4	4 3/4	3	20.6	62A14	15/16	9.2
15	62C15	7.96	5/16	3 3/4	4 3/4	3	22	62A15	15/16	10.5
17	62C17	9.00	5/16	3 3/4	4 3/4	3	24	62A17	15/16	12
19	62C19	10.05	5/16	3 3/4	4 3/4	3	28	62A19	15/16	16.8
20	62C20	10.57	5/16	3 3/4	4 3/4	3	30	62A20	15/16	18.6
24	62C24	12.67	1 1/4	3 3/4	5 1/2	4 3/4	49	62A24	1 1/4	26
26	62C26	13.72	1 1/4	3 3/4	5 1/2	4 3/4	53	62A26	1 1/4	30
30	62C30	15.82	1 1/4	3 3/4	5 1/2	4 3/4	65	62A30	1 1/4	42
36	62C36	18.98	1 1/4	3 3/4	5 1/2	4 3/4	82	62A36	1 1/4	59
54	62C54	28.45	1 1/4	3 3/4	5 1/2	4 3/4	125	62A54	1 1/4	135
60	62C60	31.60	1 1/4	3 3/4	5 1/2	4 3/4	138	62A60	1 1/4	169

78 FLAME CUT SPROCKETS FOR CHAINS:

78 — H 74 — 75 — H 75 — H 78 — H 78 LR — (14 — 18 TEETH ONLY) — H 78 RT — H 78 SR — H 79 — 88 — 188 — S 188 — S 78 — R 588 — RR 588 — R 778 — RR 778 — 988 — IS 880 — 87R — IS 881 — 81X — IS 882 — 433½ — LXS 881 — LXS 886 — US 881 — LXS 887 — LXS 882 — 488 — XS 578 — SS 188 — C 188 — US 278 R — US 882 — 578 R — 588 R

Type C — 2.609" Pitch

PLATE THICKNESS 7/8"
ROLLER DIAMETER 1 1/8"

Type A

Number of Teeth	Catalog Number	Pitch Diameter	Stock Bore	Max. Bore	Hub Diameter	L.T.B.	Approximate Weight	Catalog Number	Stock Bore	Approximate Weight
8	78C8	6.82	5/16	3 3/4	4 3/4	3 3/8	21	78A8	15/16	9
9	78C9	7.63	1 1/4	3 3/4	5 1/4	3 3/8	29	78A9	1 1/4	11.3
10	78C10	8.44	1 1/4	3 3/4	5 3/4	3 3/8	31	78A10	1 1/4	13.9
11	78C11	9.26	1 1/4	3 3/4	5 3/4	3 3/8	34	78A11	1 1/4	16.7
12	78C12	10.08	1 1/4	3 3/4	5 3/4	3 3/8	37	78A12	1 1/4	19.8
13	78C13	10.90	1 1/4	3 3/4	5 3/4	4 1/2	46	78A13	1 1/4	23
14	78C14	11.72	1 1/4	3 3/4	5 3/4	4 1/2	49	78A14	1 1/4	27
15	78C15	12.55	1 1/4	3 3/4	5 3/4	4 1/2	53	78A15	1 1/4	30
17	78C17	14.20	1 1/4	3 3/4	5 3/4	4 1/2	62	78A17	1 1/4	39
19	78C19	15.85	1 1/4	4 1/2	6 1/2	5 3/8	90	78A19	1 1/4	50
21	78C21	17.51	1 1/4	4 1/2	6 1/2	5 3/8	101	78A21	1 1/4	61
24	78C24	19.99	1 1/4	4 1/2	6 1/2	5 3/8	119	78A24	1 1/4	79
25	78C25	20.82	1 1/4	4 1/2	6 1/2	5 3/8	124	78A25	1 1/4	84
28	78C28	23.31	1 1/4	4 1/2	6 1/2	5 3/8	132	78A28	1 1/4	105
30	78C30	24.96	1 1/4	4 1/2	6 1/2	5 3/8	150	78A30	1 1/4	123
35	78C35	29.11	1 1/4	4 1/2	6 1/2	5 3/8	170	78A35	1 1/4	166
40	78C40	33.25	1 1/4	4 3/4	7 1/4	6 3/8	226	78A40	1 1/4	216
42	78C42	34.91	1 1/4	4 3/4	7 1/4	6 3/8	240	78A42	1 1/4	240
46	78C46	38.31	1 1/4	4 3/4	7 1/4	6 3/8	258	78A46	1 1/4	286
54	78C54	44.87	1 1/4	4 3/4	7 1/4	6 3/8	368	78A54	1 1/4	302
60	78C60	49.85	1 1/4	4 3/4	7 1/4	6 3/8	388	78A60	1 1/4	322

78 BORED-TO-SIZE FLAME CUT SPROCKETS

Type C — 2.609" Pitch

PLATE THICKNESS 7/8"
ROLLER DIAMETER 1 1/8"

Part Number	Pitch Diameter	Approximate Wt. Lbs.	Stock Finished Bores - Includes Keyway & 2 Setscrews							
78CS8	6.82"	21	1-7/16	1-15/16	2	2-3/16	2-7/16	2-15/16		
78CS9	7.63"	29	1-7/16	1-15/16	2	2-3/16	2-7/16	2-15/16		
78CS10	8.44"	31	1-7/16	1-15/16	2	2-3/16	2-7/16	2-15/16	3-7/16*	
78CS11	9.26"	34		1-15/16	2	2-3/16	2-7/16	2-15/16	3-7/16*	
78CS12	10.08"	37		1-15/16	2	2-3/16	2-7/16	2-15/16	3-7/16*	
78CS13	10.90"	46		1-15/16	2	2-3/16	2-7/16	2-15/16	3-7/16*	
78CS14	11.72"	49		1-15/16	2	2-3/16	2-7/16	2-15/16	3-7/16*	

Please contact *Martin* if Hub OD and Length Thru Bore dimensions are critical.

* These parts have setscrews at 90 degrees and 180 degrees instead of over keyway and 90 degrees.

ENGINEERED

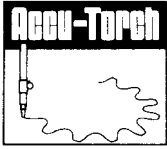

Flame Cut Sprockets for Engineering Chains



1568 FLAME CUT SPROCKETS FOR CHAINS:

AX 1568 — X568 — JS 3011 — SS 568 — XX 568 — 1803 A — 1803 AB — MXS 3011 — IS 3011 — IS 3010 — US 3011 — LXS 3011 — LXS 3011 M

Type C — 3.067" Pitch

PLATE THICKNESS 1¹/₄"
ROLLER DIAMETER 1⁵/₈"

Type A

Number of Teeth	Catalog Number	Pitch Diameter	Stock Bore	Max. Bore	Hub Diameter	L.T.B.	Approximate Weight	Catalog Number	Stock Bore	Approximate Weight
10	1568C10	9.92	1 ¹ / ₂	3 ³ / ₄	5 ¹ / ₂	4 ¹ / ₄	46	1568A10	1 ¹ / ₂	28
12	1568C12	11.85	1 ¹ / ₂	3 ³ / ₄	5 ¹ / ₂	4 ¹ / ₄	58	1568A12	1 ¹ / ₂	40
14	1568C14	13.78	1 ¹ / ₂	3 ³ / ₄	5 ¹ / ₂	4 ¹ / ₄	73	1568A14	1 ¹ / ₂	53
30	1568C30	29.34	1 ¹ / ₂	4 ¹ / ₂	6 ¹ / ₂	5 ¹ / ₂	217	1568A30	1 ¹ / ₂	240
36	1568C36	35.19	1 ¹ / ₂	5 ¹ / ₂	7 ¹ / ₂	5 ¹ / ₂	257	1568A36	1 ¹ / ₂	290
42	1568C42	41.04	1 ¹ / ₂	5 ¹ / ₂	8	6 ¹ / ₂	407	1568A42	1 ¹ / ₂	340
48	1568C48	46.89	1 ¹ / ₂	5 ¹ / ₂	8	6 ¹ / ₂	448	1568A48	1 ¹ / ₂	381

ENGINEERED

1030 FLAME CUT SPROCKETS FOR CHAINS:

1030 — CHAMPION NO. 3 — R 1033 — R 1035 — 1037 — 1539 — SS 40 — LXS 1031 — API 3 — LXS 1032 — SS 40 Hyp — IS 1030 — IS 1031 — IS 1032 — IS 1037 — US 1031 — 1190 — SXX — 1190 R — US 1032

Type C — 3.075" Pitch

PLATE THICKNESS 1¹/₄"
ROLLER DIAMETER 1¹/₄"

Type A

Number of Teeth	Catalog Number	Pitch Diameter	Stock Bore	Max. Bore	Hub Diameter	L.T.B.	Approximate Weight	Catalog Number	Stock Bore	Approximate Weight
8	1030C8	8.05	1 ¹ / ₂	3 ³ / ₄	5	3 ³ / ₄	31	1030A8	1 ¹ / ₂	17.9
9	1030C9	8.99	1 ¹ / ₂	3 ³ / ₄	5	3 ³ / ₄	36	1030A9	1 ¹ / ₂	22.4
10	1030C10	9.95	1 ¹ / ₂	3 ³ / ₄	5	3 ³ / ₄	40	1030A10	1 ¹ / ₂	28
11	1030C11	10.91	1 ¹ / ₂	3 ³ / ₄	5 ¹ / ₂	4 ¹ / ₄	51	1030A11	1 ¹ / ₂	33
12	1030C12	11.88	1 ¹ / ₂	3 ³ / ₄	5 ¹ / ₂	4 ¹ / ₄	57	1030A12	1 ¹ / ₂	39
13	1030C13	12.85	1 ¹ / ₂	3 ³ / ₄	5 ¹ / ₂	4 ¹ / ₄	64	1030A13	1 ¹ / ₂	46
15	1030C15	14.79	1 ¹ / ₂	4	6	5 ¹ / ₂	91	1030A15	1 ¹ / ₂	60
17	1030C17	16.73	1 ¹ / ₂	4	6	5 ¹ / ₂	109	1030A17	1 ¹ / ₂	78
19	1030C19	18.68	1 ¹ / ₂	4 ¹ / ₂	6 ¹ / ₂	5 ¹ / ₂	137	1030A19	1 ¹ / ₂	97
21	1030C21	20.63	1 ¹ / ₂	4 ¹ / ₂	6 ¹ / ₂	5 ¹ / ₂	158	1030A21	1 ¹ / ₂	118
24	1030C24	23.56	1 ¹ / ₂	4 ¹ / ₂	6 ¹ / ₂	5 ¹ / ₂	176	1030A24	1 ¹ / ₂	154
25	1030C25	24.53	1 ¹ / ₂	5 ¹ / ₂	7 ¹ / ₂	5 ¹ / ₂	206	1030A25	1 ¹ / ₂	167
28	1030C28	27.46	1 ¹ / ₂	5 ¹ / ₂	7 ¹ / ₂	5 ¹ / ₂	236	1030A28	1 ¹ / ₂	210
30	1030C30	29.42	1 ¹ / ₂	5 ¹ / ₂	7 ¹ / ₂	5 ¹ / ₂	254	1030A30	1 ¹ / ₂	240
35	1030C35	34.30	1 ¹ / ₂	5 ¹ / ₂	8	6 ¹ / ₂	313	1030A35	1 ¹ / ₂	327
40	1030C40	39.19	1 ¹ / ₂	5 ¹ / ₂	8	6 ¹ / ₂	360	1030A40	1 ¹ / ₂	427
42	1030C42	41.15	1 ¹ / ₂	5 ¹ / ₂	8	6 ¹ / ₂	410	1030A42	1 ¹ / ₂	343
48	1030C48	47.03	1 ¹ / ₂	6 ¹ / ₂	9 ¹ / ₂	6 ¹ / ₂	501	1030A48	1 ¹ / ₂	384
54	1030C54	52.89	1 ¹ / ₂	6 ¹ / ₂	9 ¹ / ₂	6 ¹ / ₂	549	1030A54	1 ¹ / ₂	432
60	1030C60	58.75	1 ¹ / ₂	7	10	7 ¹ / ₂	642	1030A60	1 ¹ / ₂	506

Maximum bores shown will accommodate standard keyseat and setscrew over keyseat. Slightly larger bores are possible with no keyseat, shallow keyseat, or setscrew at angle to keyseat.



Flame Cut Sprockets for Engineering Chains

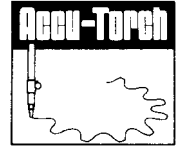

82 FLAME CUT SPROCKETS FOR CHAINS:

H 82 — WH 82 — WR 82 — 103 — 131 — S 131 — WS 82 — WS 82 H — SS 131 — 527 R — 527 RX — C 9103 — 6131 — 4103 — C 131 — 382

Type C — 3.075" Pitch

PLATE THICKNESS 1¹/₈"
ROLLER DIAMETER 1⁷/₃₂"

Type A

Number of Teeth	Catalog Number	Pitch Diameter	Stock Bore	Max. Bore	Hub Diameter	L.T.B.	Approximate Weight	Catalog Number	Stock Bore	Approximate Weight
7	82C7	7.09	1 ¹ / ₈	2 ³ / ₈	4 ¹ / ₂	3 ³ / ₈	24	82A7	1 ¹ / ₈	12.6
8	82C8	8.04	1 ¹ / ₈	3 ¹ / ₈	5 ¹ / ₂	4 ¹ / ₂	34	82A8	1 ¹ / ₈	16
9	82C9	8.99	1 ¹ / ₈	3 ³ / ₈	5 ¹ / ₂	4 ¹ / ₂	38	82A9	1 ¹ / ₈	20
10	82C10	9.95	1 ¹ / ₈	3 ³ / ₈	5 ¹ / ₂	4 ¹ / ₂	43	82A10	1 ¹ / ₈	25
11	82C11	10.91	1 ¹ / ₈	3 ³ / ₈	5 ¹ / ₂	4 ¹ / ₂	54	82A11	1 ¹ / ₈	30
12	82C12	11.88	1 ¹ / ₈	3 ³ / ₈	5 ¹ / ₂	4 ¹ / ₂	60	82A12	1 ¹ / ₈	36
13	82C13	12.85	1 ¹ / ₈	3 ³ / ₈	5 ¹ / ₂	4 ¹ / ₂	66	82A13	1 ¹ / ₈	42
14	82C14	13.82	1 ¹ / ₈	3 ³ / ₈	5 ¹ / ₂	4 ¹ / ₂	72	82A14	1 ¹ / ₈	48
15	82C15	14.79	1 ¹ / ₈	4 ¹ / ₂	6 ¹ / ₂	5 ¹ / ₂	94	82A15	1 ¹ / ₂	54
16	82C16	15.76	1 ¹ / ₈	4 ¹ / ₂	6 ¹ / ₂	5 ¹ / ₂	102	82A16	1 ¹ / ₂	62
17	82C17	16.73	1 ¹ / ₈	4 ¹ / ₂	6 ¹ / ₂	5 ¹ / ₂	110	82A17	1 ¹ / ₂	70
18	82C18	17.71	1 ¹ / ₈	4 ¹ / ₂	6 ¹ / ₂	5 ¹ / ₂	119	82A18	1 ¹ / ₂	79

82 BORED-TO-SIZE FLAME CUT SPROCKETS

Type C — 3.075" Pitch

PLATE THICKNESS 1¹/₈"
ROLLER DIAMETER 1⁷/₃₂"

Part Number	Pitch Diameter	Approximate Wt. Lbs.	Stock Finished Bores - Includes Keyway & 2 Setscrews
82CS10	9.95"	43	2-7/16 2-15/16
82CS11	10.91"	54	2-7/16 2-15/16
82CS12	11.88"	60	2-7/16 2-15/16

Please contact *Martin* if Hub OD and Length Thru Bore dimensions are critical.

238 FLAME CUT SPROCKETS FOR CHAINS:

RX 238 — IS 3514 J — 1616 A — MXS 3514 — US 3514 — LXS 3514 — LXS 3514 M

Type C — 3.500" Pitch

PLATE THICKNESS 1¹/₄"
ROLLER DIAMETER 1³/₄"

Type A

Number of Teeth	Catalog Number	Pitch Diameter	Stock Bore	Max. Bore	Hub Diameter	L.T.B.	Approximate Weight	Catalog Number	Stock Bore	Approximate Weight
10	238C10	11.33	1 ¹ / ₂	3 ³ / ₈	5 ¹ / ₂	4 ¹ / ₂	54	238A10	1 ¹ / ₂	35
12	238C12	13.52	1 ¹ / ₂	3 ³ / ₈	5 ¹ / ₂	4 ¹ / ₂	70	238A12	1 ¹ / ₂	51
14	238C14	15.73	1 ¹ / ₂	3 ³ / ₈	5 ¹ / ₂	4 ¹ / ₂	88	238A14	1 ¹ / ₂	60
30	238C30	33.48	1 ¹ / ₂	4	6	5 ¹ / ₂	312	238A30	1 ¹ / ₂	253
36	238C36	40.16	1 ¹ / ₂	4	6	5 ¹ / ₂	445	238A36	1 ¹ / ₂	370
42	238C42	46.84	1 ¹ / ₂	5 ¹ / ₂	8	6 ¹ / ₂	446	238A42	1 ¹ / ₂	379
48	238C48	53.52	1 ¹ / ₂	5 ¹ / ₂	8	6 ¹ / ₂	517	238A48	1 ¹ / ₂	450

Maximum bores shown will accommodate standard keyseat and setscrew over keyseat. Slightly larger bores are possible with no keyseat, shallow keyseat, or setscrew at angle to keyseat.

ENGINEERED

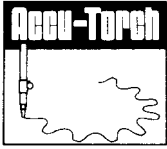

Flame Cut Sprockets for Engineering Chains



124 FLAME CUT SPROCKETS FOR CHAINS:

H 124 — W 124 — WS 124 — WR 124 — WH 124

Type C — 4.000" Pitch

PLATE THICKNESS 1 1/2"
ROLLER DIAMETER 1 1/2"

Type A

Number of Teeth	Catalog Number	Pitch Diameter	Stock Bore	Max. Bore	Hub Diameter	L.T.B.	Approximate Weight	Catalog Number	Stock Bore	Approximate Weight
6	124C6	8.00	5/16	3/4	4 3/4	4%	36	124A6	5/16	21
7	124C7	9.22	1	3 3/8	5%	4%	52	124A7	1	28
8	124C8	10.45	1	3 3/8	5%	4%	61	124A8	1	37
9	124C9	11.70	1	3 3/8	5%	4%	70	124A9	1	46
10	124C10	12.94	1	3 3/8	5%	4%	79	124A10	1	55
11	124C11	14.20	1 1/2	4%	6%	4%	95	124A11	1 1/2	68
12	124C12	15.45	1 1/2	4%	6%	4%	107	124A12	1 1/2	80
13	124C13	16.72	1 1/2	4%	6%	4%	120	124A13	1 1/2	93
14	124C14	17.98	1 1/2	4%	6%	4%	135	124A14	1 1/2	108
15	124C15	19.24	1 1/2	4%	6%	6	168	124A15	1 1/2	124
16	124C16	20.50	1 1/2	4%	6%	6	185	124A16	1 1/2	141

124 BORED-TO-SIZE FLAME CUT SPROCKETS

Type C — 4.000" Pitch

PLATE THICKNESS 1 1/2"
ROLLER DIAMETER 1 1/2"

Part Number	Pitch Diameter	Approximate Wt. Lbs.	Stock Finished Bores - Includes Keyway & 2 Setscrews		
124CS9	11.70"	70	2-3/16	2-7/16	2-15/16
124CS10	12.94"	79		2-7/16	2-15/16
124CS11	14.20"	95			2-15/16
124CS12	15.45"	107			2-15/16

Please contact *Martin* if Hub OD and Length Thru Bore dimensions are critical.

1240 FLAME CUT SPROCKETS FOR CHAINS:

1240 — CHAMPION NO. 4 — 1244 — RX 1245 — R 1248 — SS 124 — API 4 — LXS 1242 — SS 124 — 3 BAR HYPER — LXS 1245 — SS 124 D — SS 124 DP — IS 1242 — IS 1245

Type C — 4.063" Pitch

PLATE THICKNESS 1 3/4"
ROLLER DIAMETER 1 3/4"

Type A

Number of Teeth	Catalog Number	Pitch Diameter	Stock Bore	Max. Bore	Hub Diameter	L.T.B.	Approximate Weight	Catalog Number	Stock Bore	Approximate Weight
6	1240C6	8.13	5/16	2 1/2	4	4	34	1240A6	5/16	26
7	1240C7	9.36	1 1/4	3%	5%	4%	51	1240A7	1 1/4	34
8	1240C8	10.62	1 1/4	4%	6%	5	78	1240A8	1 1/4	44
9	1240C9	11.88	1 1/4	4%	6%	5	89	1240A9	1 1/4	55
10	1240C10	13.15	1 1/2	4%	6%	5	101	1240A10	1 1/2	67
11	1240C11	14.42	1 1/2	4%	6%	5	115	1240A11	1 1/2	81
12	1240C12	15.70	1 1/2	5%	7	6	140	1240A12	1 1/2	96
13	1240C13	16.98	1 1/2	5%	7	6	155	1240A13	1 1/2	111
14	1240C14	18.26	1 1/2	5%	7	6	174	1240A14	1 1/2	130
15	1240C15	19.54	1 1/2	5%	7	6	192	1240A15	1 1/2	148
16	1240C16	20.83	1 1/2	5%	8	6%	230	1240A16	1 1/2	168
18	1240C18	23.40	1 1/2	5%	8	6%	275	1240A18	1 1/2	213
20	1240C20	25.97	1 1/2	5 1/2	8	6%	300	1240A20	1 1/2	263
21	1240C21	27.26	1 1/2	5 1/2	8	6%	319	1240A21	1 1/2	289
24	1240C24	31.12	1 1/2	5 1/2	8	6%	387	1240A24	1 1/2	377
25	1240C25	33.42	1 1/2	6	9	6%	426	1240A25	1 1/2	409
28	1240C28	36.29	1 1/2	6	9	6%	494	1240A28	1 1/2	509
30	1240C30	38.87	1 1/2	7	10	6%	583	1240A30	1 1/2	587
35	1240C35	45.33	1 1/2	7	10	6%	729	1240A35	1 1/2	620
40	1240C40	51.78	1 1/2	7 1/2	11	7%	932	1240A40	1 1/2	721
48	1240C48	62.12	1 1/2	7 1/2	11	7%	1078	1240A48	1 1/2	867



Flame Cut Sprockets for Engineering Chains

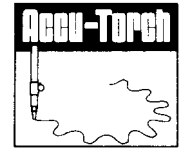

635 FLAME CUT SPROCKETS FOR CHAINS:

RO 635 — B 635 — X 635 — 1350 — 450 SX — 450 SXX — IS 4522 — 1340 RX — LXS 4522 M

Type C — 4.500" Pitch

PLATE THICKNESS 1³/₄"
ROLLER DIAMETER 2¹/₄"

Type A

Number of Teeth	Catalog Number	Pitch Diameter	Stock Bore	Max. Bore	Hub Diameter	L.T.B.	Approximate Weight	Catalog Number	Stock Bore	Approximate Weight
10	635C10	14.56	1 ¹ / ₂	4	6 ¹ / ₂	5	111	635A10	1 ¹ / ₂	87
12	635C12	17.39	1 ¹ / ₂	4	6 ¹ / ₂	5	148	635A12	1 ¹ / ₂	119
14	635C14	20.22	1 ¹ / ₂	4	6 ¹ / ₂	5	188	635A14	1 ¹ / ₂	159
30	635C30	43.05	1 ¹ / ₂	5 ⁵ / ₈	7 ¹ / ₂	5 ⁵ / ₈	592	635A30	1 ¹ / ₂	542
36	635C36	51.63	1 ¹ / ₂	5 ⁵ / ₈	7 ¹ / ₂	5 ⁵ / ₈	764	635A36	1 ¹ / ₂	715
42	635C42	60.22	1 ¹ / ₂	6 ¹ / ₂	9 ¹ / ₂	7 ¹ / ₂	884	635A42	1 ¹ / ₂	776
48	635C48	68.81	1 ¹ / ₂	7 ¹ / ₂	11	7 ¹ / ₂	1174	635A48	1 ¹ / ₂	963

1207 FLAME CUT SPROCKETS FOR CHAINS:

RX 1207 — RO 1205 — A 1302 — JS 5031 — 1510 XX — 1602 A — 1602 AA — US 5201 A — LXS 5028 — LXS 6038 M — MXS 5028

Type C — 5.000" Pitch

PLATE THICKNESS 2¹/₄"
ROLLER DIAMETER 2¹/₂"

Type A

Number of Teeth	Catalog Number	Pitch Diameter	Stock Bore	Max. Bore	Hub Diameter	L.T.B.	Approximate Weight	Catalog Number	Stock Bore	Approximate Weight
10	1207C10	16.18	1 ¹ / ₂	4 ¹ / ₂	6 ¹ / ₂	5 ¹ / ₂	160	1207A10	1 ¹ / ₂	131
12	1207C12	19.32	1 ¹ / ₂	4 ¹ / ₂	6 ¹ / ₂	5 ¹ / ₂	215	1207A12	1 ¹ / ₂	187
14	1207C14	22.47	1 ¹ / ₂	5 ¹ / ₂	7 ¹ / ₂	5 ¹ / ₂	298	1207A14	1 ¹ / ₂	254
30	1207C30	47.84	1 ¹ / ₂	6	9	6 ¹ / ₂	809	1207A30	1 ¹ / ₂	730
36	1207C36	57.37	1 ¹ / ₂	7	10	8 ¹ / ₂	1161	1207A36	1 ¹ / ₂	1025
42	1207C42	66.91	1 ¹ / ₂	7	10	8 ¹ / ₂	1245	1207A42	1 ¹ / ₂	1109
48	1207C48	76.45	1 ¹ / ₂	7 ¹ / ₂	11	10 ¹ / ₂	2005	1207A48	1 ¹ / ₂	1794

132 FLAME CUT SPROCKETS FOR CHAINS:

C 132 — A 132 — A 132 WS — WS 132 — C 132 M — C 132 W — SX 150 — SXA 150 — 150 X — 6150 — W 157 — WH 157 — WR 157

Type C — 6.050" Pitch

PLATE THICKNESS 2³/₄"
ROLLER DIAMETER 1²³/₃₂"

Type A

Number of Teeth	Catalog Number	Pitch Diameter	Stock Bore	Max. Bore	Hub Diameter	L.T.B.	Approximate Weight	Catalog Number	Stock Bore	Approximate Weight
6	132C6	12.10	1 ¹ / ₂	4 ¹ / ₂	6 ¹ / ₂	6	119	132A6	1 ¹ / ₂	90
7	132C7	13.95	1 ¹ / ₂	4 ¹ / ₂	6 ¹ / ₂	6	149	132A7	1 ¹ / ₂	120
8	132C8	15.81	1 ¹ / ₂	4 ¹ / ₂	6 ¹ / ₂	6	182	132A8	1 ¹ / ₂	153
9	132C9	17.69	1 ¹ / ₂	5 ¹ / ₂	7 ¹ / ₂	6 ¹ / ₂	236	132A9	1 ¹ / ₂	192
10	132C10	19.58	1 ¹ / ₂	5 ¹ / ₂	7 ¹ / ₂	6 ¹ / ₂	278	132A10	1 ¹ / ₂	235
11	132C11	21.47	1 ¹ / ₂	5 ¹ / ₂	7 ¹ / ₂	6 ¹ / ₂	326	132A11	1 ¹ / ₂	283
12	132C12	23.38	1 ¹ / ₂	5 ¹ / ₂	7 ¹ / ₂	6 ¹ / ₂	378	132A12	1 ¹ / ₂	334

ENGINEERED

Veneer Dryer Parts

81X 81 x (2.609) Hooked Tooth Sprocket "B" Style (Right and Left Hand)

No. Teeth	Part Number	Outside Diam.	Type	Bore		Hub (Inch)	
				Stock	Max.	Diam.	LTB
8	81X-B8RH	6 $\frac{1}{2}$	B	1	1 $\frac{1}{2}$	2 $\frac{1}{2}$	1 $\frac{1}{2}$
8	81X-B8LH	6 $\frac{1}{2}$	B	1	1 $\frac{1}{2}$	2 $\frac{1}{2}$	1 $\frac{1}{2}$

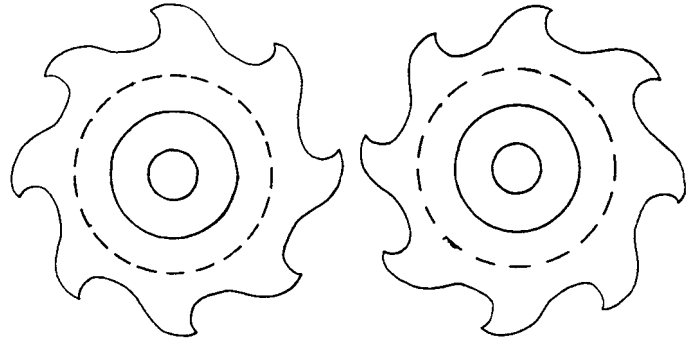

(RH) Right Hand

(LH) Left Hand

"C" Style

No. Teeth	Part Number	Outside Diam.	Type	Bore		Hub (Inch)	
				Stock	Max.	Diam.	LTB
7	81X-C7	5 $\frac{1}{4}$	C	$\frac{3}{4}$	1 $\frac{1}{2}$	2 $\frac{1}{2}$	2 $\frac{1}{8}$
8	81X-C8	6 $\frac{1}{4}$	C	$\frac{3}{4}$	1 $\frac{1}{2}$	2 $\frac{1}{2}$	2 $\frac{1}{8}$
9	81X-C9	7 $\frac{1}{16}$	C	$\frac{3}{4}$	1 $\frac{1}{2}$	2 $\frac{1}{2}$	2 $\frac{1}{8}$

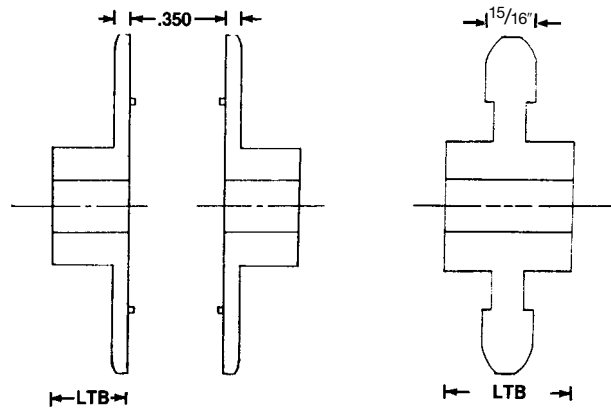

Type B
(Cast Iron)

Type C
(Cast Iron)



Star Gear

No. Teeth	Part Number	Outside Diam.	Type	Bore		Hub (Inch)	
				Stock	Max.	Diam.	LTB
10	SG510	4 $\frac{3}{16}$	B	1	1 $\frac{1}{2}$	2 $\frac{1}{2}$	2

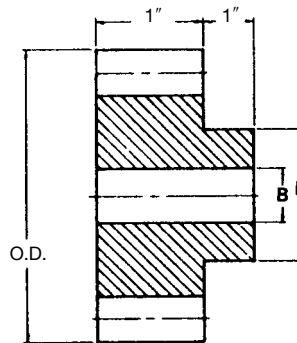

Type B
(Cast Iron)

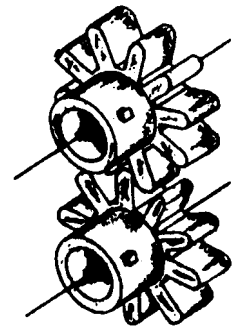

ENGINEERED

GEARS

PRODUCT	PAGE
INDEXG-1
STOCK GEARSG-2
MADE-TO-ORDER GEARSG-3
NUMBERING SYSTEMG-4
GEAR STYLESG-5
SPUR GEARS (14½°)G-6 – G-24
3DPG-6 – G-7
4DPG-8 – G-9
5DPG-10 – G-11
6DPG-12 – G-13
8DPG-14 – G-15
10DPG-16 – G-17
12DPG-18 – G-19
16DPG-20 – G-21
20DPG-22 – G-23
24DPG-24
SPUR GEAR HORSEPOWER RATINGS (14½°)G-25 – G-27
SPUR GEARS (20°)G-28 – G-43
4DPG-28
5DPG-29
6DPG-30
8DPG-31
10DPG-32
12DPG-33
16DPG-34
20DPG-35
SPUR GEAR HORSEPOWER RATINGS (20°)G-36 – G-43
RACKG-44 – G-45
BEVEL GEARSG-46 – G-49
BEVEL GEARS HORSEPOWER RATINGSG-49
MITER GEARSG-50 – G-56
MITER GEARS HORSEPOWER RATINGSG-56
WORM GEARSG-57 – G-77
3DPG-58
4DPG-59
6DPG-60 – G-62
8DPG-63 – G-65
10DPG-66 – G-68
12DPG-69 – G-71
16DPG-72 – G-74
WORM GEAR HORSEPOWER RATINGSG-75 – G-77
GEAR STANDARD TOLERANCESG-78
GEAR ENGINEERING DATAG-79 – G-95
Gear Drive SelectionG-80 – G-82
Horsepower FormulaG-83
Gear StandardsG-84
Spur FormulasG-85 – G-90
Bevel and Miter Gear FormulasG-91
Worm Gear FormulasG-92
SPUR GEAR TOOTH PROFILE (14½°)G-93 – G-95
SPUR GEAR MATERIALSG-96

FOR GEAR INTERCHANGE INFORMATION VISIT WWW.MARTINSPROCKET.COM



Spur Gears



Bevel Gears



Miter Gears



Worm and Worm Gears



Gear Rack



“Made-To-Order” Gears



GEARS

Stock Gears Numbering System

Letters (Prefix) Indicate Material and Type Gear.

Letters (Suffix) Indicate Hardened, Number of Threads, Direction of Rotation and KW and SS.

Numbers Indicate Pitch, Number of Teeth, and Ratio (Suffix).



Spur Gears

S=Steel

TS=Steel 20°

C=Cast

TC=Cast 20°

H=Hardened Teeth

NM=Non-Metallic

Note: Pressure Angle is Shown as a Suffix to Part Number of All Our Spur Gears.

Examples

S620-14½° (Steel 6P 20T-14½°PA)

TS620-20° (Steel 6P 20T-20°PA)

C660-14½° (Cast 6P 60T-14½°PA)

TC660-20° (Cast 6P 60T-20°PA)

S620H-14½° (Steel 6P 20T-Hardened 14½°PA)

NM620-14½° (Non-Metallic 6P 20T-14½°PA)



Rack

R=Rack — Steel

RA=Rack — Steel Heavy Backing

TR=Rack — Steel 20° Heavy Backing

R20=Rack — Steel 20° Wide Face

Examples

R-6X2 (14½° STD Backing 6PX2' Long)

RA-6X4 (14½° Heavy Backing 6PX4' Long)

TR-6X6 (20° STD Width 6PX6' Long)

R20-6X6 (20° Wide Face 6PX6' Long)



Bevel Gears

B=Bevel — Cast Iron Gears

B=Bevel — Steel Pinions

BS=Bevel — Steel Gears

BS=Bevel — Steel Pinions

Note: B Steel Pinions May Run With BS Gears of Same Ratio

Examples

B1040-2 (Cast 10P 40T 2:1 Ratio)

B1020-2 (Steel 10P 20T 2:1 Ratio)

BS1040-2 (Steel 10P 40T 2:1 Ratio)

BS1020-2 (Steel 10P 20T 2:1 Ratio)



Miter Gears

M=Miter — Steel Gears

A or B=Larger Bore (Suffix)

HM=Miter-Hardened Teeth

K=KW & SS

Examples

M824 (Steel 8P 24T)

M824A (Steel 8P 24T Larger Bore)

M2424BR (Brass 24P 24T)

HM1020 (Steel-Hardened Teeth 10P 20T)

HMK1020 (Steel-Hardened 10P 20T With KW & SS)



Worm

W=Worm — Steel

WH=Worm — Steel With Hub Projection

WG=Worm — Steel Hardened Ground Threads

WHG=Worm — Steel Hardened Ground Threads With Hub Projection

L=(Prefix) Longer Face

D or Q=(Suffix) Double or Quadruple Thread

R=Right Hand

Examples

W6R (Steel 6P Right Hand)

WH6R (Steel with Hub Projection 6P Right Hand)

WG6R (Steel-Hardened Ground Threads 6P Right Hand)

WHG6R (Steel with Hub Projection Hardened Ground Threads 6P Right Hand)

LW6R Steel Long Face 6P Right Hand)

W6DR (Steel 6P Double Thread Right Hand)



Worm Gears

W=Worm Gear — Cast Iron

WB=Worm Gear — Bronze

D or Q=Double or Quadruple Thread (Suffix)

R=Right Hand (Suffix)

Examples

W660R (Cast Iron 6P 60T Right Hand)

WB660R (Bronze 6P 60T Right Hand)

W660DR (Cast Iron 6P 60T Double Thread Right Hand)

Martin Stock Spur Gears are available in five different styles. Steel Gears are furnished in plain style and plain style with hub. Cast gears are furnished, plain with hub, web with lightening holes, and spoke. Cast gears are machined on all operating surfaces. *Martin* cast gears are cast with larger hub to provide extra strength and to allow for larger bores.



Type A

- Plain Without Hubs
- All Steel



Type B₁

- Web
- All Steel
- Cast



Type B

- Plain With Hubs
- All Steel
- Cast



Type B₂

- Web With Lighten Holes
- All Steel
- Cast



Type B₃

- Web With Spokes
- Cast

3 DP 3" Face

Steel Stock Spur Gears 14½° Pressure Angle



Type A
Plain Without Hub



Type B
Plain With Hub



Type B₁
Web



Type B₂
Web With
Lighten Holes

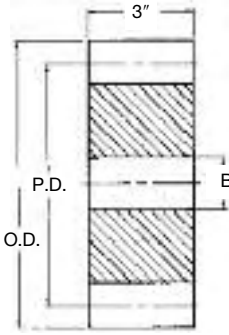

Type A

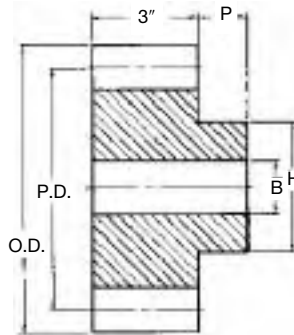

Type B

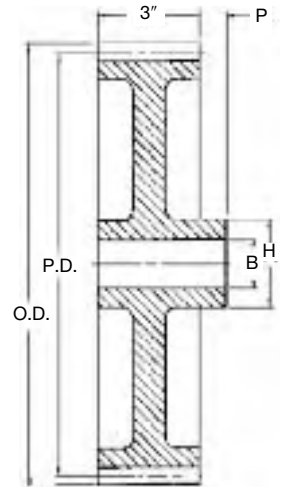

Type B₁, B₂

Steel

No. Teeth	Catalog Number	Pressure Angle (Deg.)	Diameter		Type	Bore (Inches)		Hub (Inches)		Weight Lbs. (App.)
			Pitch	Outside		Stock	Max. *	Diameter	Proj.	
11	S311	14½	4.000†	4.666	A	1⅞	2			12.0
12	S312	14½	4.000‡	4.666	A	1⅞	2			11.0
13	S313	14½	4.333	5.000	A	1⅞	2¼			10.7
14	S314	14½	4.667	5.333	A	1⅞	2½			12.8
15	S315	14½	5.000	5.666	A	1⅞	2¾			14.8
16	S316	14½	5.333	6.000	A	1⅞	2⅞			17.0
18	S318	14½	6.000	6.666	A	1⅞	3¼			22.0
20	S320	14½	6.667	7.333	A	1⅞	3½			27.4
21	S321	14½	7.000	7.666	A	1⅞	3¾			30.7
24	S324	14½	8.000	8.666	B	1⅞	3¼	5½	1¼	48.2
30	S330	14½	10.000	10.666	B	1⅞	3¾	6¼	1¼	74.5
36	S336	14½	12.000	12.666	B	1⅞	4¼	6½	1¼	114
42	S342	14½	14.000	14.666	B1	1⅞	4¾	6¾	1¼	106
48	S348	14½	16.000	16.666	B1	1⅞	4¾	6¾	1¼	120
54	S354	14½	18.000	18.666	B2	1⅞	4¾	6¾	1¼	134
60	S360	14½	20.000	20.666	B2	1⅞	4¾	6¾	1¼	150
72	S372	14½	24.000	24.666	B2	1⅞	4¾	7	1¼	180
84	S384	14½	28.000	28.666	B2	1⅞	4¾	7	1¼	215
96	S396	14½	32.000	32.666	B2	1⅞	4¾	7	1¼	264
108	S3108	14½	36.000	36.666	B2	1⅞	4¾	7	1¼	305
120	S3120	14½	40.000	40.666	B2	1⅞	5	7½	1¼	367

* Recommended Maximum Bore With Keyway and Setscrew.

† Enlarged Pitch Diameter with Special Tooth Form.

‡ 4" Face.

14½ P.A. Gears Will Not Operate With 20° P.A.

Martin

Cast Iron Stock Spur Gears

14½° Pressure Angle

3 DP 3" Face



Type B
Plain With Hub



Type B₂
Web With
Lighten Holes



Type B₃
Web With Spokes

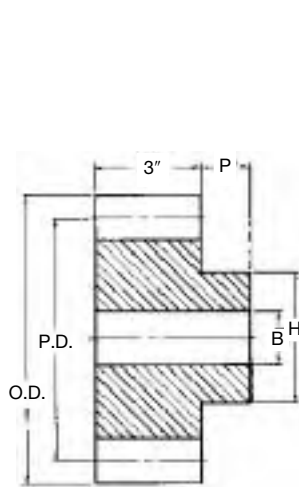

Type B

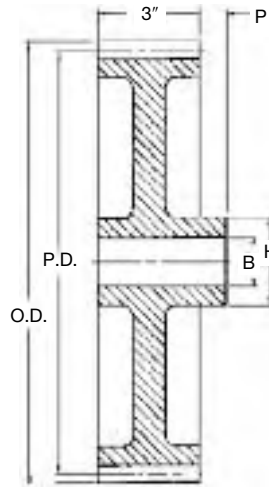

Type B₂, B₃

Cast — Style "B"

No. Teeth	Catalog Number	Pressure Angle (Deg.)	Diameter		Type	Bore (Inches)		Hub (Inches)		Weight Lbs. (App.)
			Pitch	Outside		Stock	Max.*	Diameter	Proj.	
24	C324	14½	8.000	8.666	B	1⅙	2⅙	4½	1¼	40.4
28	C328	14½	9.333	10.000	B	1⅙	3⅙	5½	1¼	54.2
30	C330	14½	10.000	10.666	B	1⅙	3⅙	5½	1¼	57.1
32	C332	14½	10.667	11.333	B	1⅙	3⅙	5½	1¼	62.4
36	C336	14½	12.000	12.666	B ₂	1⅙	3¼	5½	1¼	71.3
40	C340	14½	13.333	14.000	B ₂	1⅙	3¼	5½	1¼	75.9
42	C342	14½	14.000	14.666	B ₂	1⅙	3¼	5½	1¼	79.5
45	C345	14½	15.000	15.666	B ₂	1⅙	3¼	5½	1¼	85.0
48	C348	14½	16.000	16.666	B ₃	1⅙	3¼	5½	1¼	92.9
54	C354	14½	18.000	18.666	B ₃	1⅙	3¼	5½	1¼	104
60	C360	14½	20.000	20.666	B ₃	1⅙	3¼	5½	1¼	115
72	C372	14½	24.000	24.666	B ₃	1⅙	3⅙	6	1¼	153
75	C375	14½	25.000	25.666	B ₃	1⅙	3⅙	6	1¼	155
84	C384	14½	28.000	28.666	B ₃	1⅙	3⅙	6	1¼	178
90	C390	14½	30.000	30.666	B ₃	1⅙	3⅙	6	1¼	185
96	C396	14½	32.000	32.666	B ₃	1⅙	3⅙	6	1¼	205
105	C3105	14½	35.000	35.666	B ₃	1⅙	3⅙	6	1¼	216
108	C3108	14½	36.000	36.666	B ₃	1⅙	3⅙	6	1¼	228
120	C3120	14½	40.000	40.666	B ₃	1⅙	4	6	1¼	226

* Recommended Maximum Bore With Keyway and Setscrew.

14½° P.A. Gears Will Not Operate With 20° P.A.

4 DP 2" Face

Steel Stock Spur Gears 14½° Pressure Angle

Martin



Type B
Plain With Hub



Type B₁
Web



Type B₂
Web With
Lighten Holes

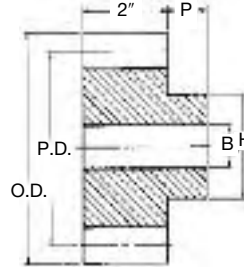

Type B

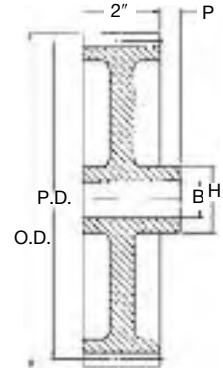

Type B₁, B₂

Steel

No. Teeth	Catalog Number	Pressure Angle (Deg.)	Diameter		Type	Bore (Inches)		Hub (Inches)		Weight Lbs. (App.)
			Pitch	Outside		Stock	Max. *	Diameter	Proj.	
11	S411	14½	3.000†	3.500	B	1½	1½	2¼	¾	4.0
12	S412	14½	3.000	3.500	B	1½	1½	2¼	¾	3.9
13	S413	14½	3.250	3.750	B	1½	1½	2¼	¾	4.6
14	S414	14½	3.500	4.000	B	1½	1½	2¼	¾	5.7
15	S415	14½	3.750	4.250	B	1½	1½	3	¾	6.8
16	S416	14½	4.000	4.500	B	1½	1½	3¼	¾	8.0
17	S417	14½	4.250	4.750	B	1½	2	3½	¾	9.2
18	S418	14½	4.500	5.000	B	1½	2¼	3¾	¾	10.4
19	S419	14½	4.750	5.250	B	1½	2½	4	¾	10.5
20	S420	14½	5.000	5.500	B	1½	2½	4¼	¾	13.4
21	S421	14½	5.250	5.750	B	1½	2½	4½	¾	14.9
22	S422	14½	5.500	6.000	B	1½	2½	4¾	¾	16.5
24	S424	14½	6.000	6.500	B	1½	2½	4¾	1½	22.8
26	S426	14½	6.500	7.000	B	1½	2½	4¾	1½	24.8
28	S428	14½	7.000	7.500	B	1½	2½	4¾	1½	27.8
30	S430	14½	7.500	8.000	B	1½	2½	4¾	1½	31.0
32	S432	14½	8.000	8.500	B	1½	2½	4¾	1½	34.4
36	S436	14½	9.000	9.500	B	1½	2½	4¾	1½	41.7
40	S440	14½	10.000	10.500	B	1½	3½	5½	1½	51.8
42	S442	14½	10.500	11.000	B	1½	3½	5½	1½	56.0
44	S444	14½	11.000	11.500	B	1½	3½	5½	1½	60.8
48	S448	14½	12.000	12.500	B	1½	3½	5½	1½	70.8
54	S454	14½	13.500	14.000	B ₁	1½	3	5	1½	57.4
56	S456	14½	14.000	14.500	B ₁	1½	3	5	1½	59.9
60	S460	14½	15.000	15.500	B ₂	1½	3	5	1½	62.8
64	S464	14½	16.000	16.500	B ₂	1½	3	5	1½	66.2
72	S472	14½	18.000	18.500	B ₂	1½	3¼	5½	1½	82.9
80	S480	14½	20.000	20.500	B ₂	1½	3¼	5½	1½	95.0
84	S484	14½	21.000	21.500	B ₂	1½	3¼	5½	1½	92.0
88	S488	14½	22.000	22.500	B ₂	1½	3¼	6½	1½	95.8
96	S496	14½	24.000	24.500	B ₂	1½	3½	6½	1½	124
120	S4120	14½	30.000	30.500	B ₂	1½	3½	6	1½	155
144	S4144	14½	36.000	36.500	B ₂	1½	4	6½	1½	208

* Recommended Maximum Bore With Keyway and Set Screw.
† Enlarged Pitch Diameter with Special Tooth Form.

14½° P.A. Gears Will Not Operate With 20° P.A.

Martin

Cast Iron Stock Spur Gears

14½° Pressure Angle

4 DP 2" Face



Type B
Plain With Hub



Type B₁
Web



Type B₂
Web With
Lighten Holes



Type B₃
Web With Spokes

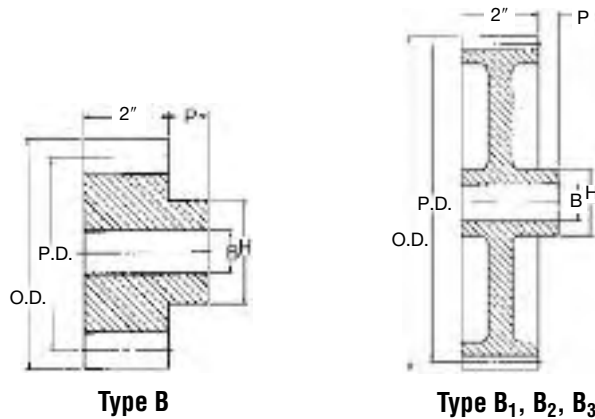

Cast — Style “B”

No. Teeth	Catalog Number	Pressure Angle (Deg.)	Diameter		Type	Bore (Inches)		Hub (Inches)		Weight Lbs. (App.)
			Pitch	Outside		Stock	Max. *	Diameter	Proj.	
24	C424	14½	6.000	6.500	B	1½	2½	3½	1½	17.0 v
28	C428	14½	7.000	7.500	B ₁	1½	2½	3½	1½	20.2
30	C430	14½	7.500	8.000	B ₁	1½	2½	3½	1½	21.1
32	C432	14½	8.000	8.500	B ₁	1½	2½	3½	1½	23.2
36	C436	14½	9.000	9.500	B ₂	1½	2½	3½	1½	30.5
40	C440	14½	10.000	10.500	B ₂	1½	2½	4	1½	26.4
42	C442	14½	10.500	11.000	B ₂	1½	2½	4	1½	33.9
44	C444	14½	11.000	11.500	B ₂	1½	2½	4	1½	32.0
48	C448	14½	12.000	12.500	B ₃	1½	2½	4	1½	38.4
52	C452	14½	13.000	13.500	B ₃	1½	2½	4	1½	42.5
54	C454	14½	13.500	14.000	B ₃	1½	2½	4	1½	44.7
56	C456	14½	14.000	14.500	B ₃	1½	2½	4	1½	46.7
60	C460	14½	15.000	15.500	B ₃	1½	2½	4	1½	49.5
64	C464	14½	16.000	16.500	B ₃	1½	2½	4	1½	54.5
68	C468	14½	17.000	17.500	B ₃	1½	2½	4	1½	56.0
72	C472	14½	18.000	18.500	B ₃	1½	2½	4	1½	63.0
80	C480	14½	20.000	20.500	B ₃	1½	2½	4½	1½	72.0
84	C484	14½	21.000	21.500	B ₃	1½	2½	4½	1½	73.0
88	C488	14½	22.000	22.500	B ₃	1½	2½	4½	1½	75.0
96	C496	14½	24.000	24.500	B ₃	1½	2½	4½	1½	86.0
100	C4100	14½	25.000	25.500	B ₃	1½	2½	4½	1½	91.0
104	C4104	14½	26.000	26.500	B ₃	1½	2½	4½	1½	105
112	C4112	14½	28.000	28.500	B ₃	1½	3½	5	1½	108
120	C4120	14½	30.000	30.500	B ₃	1½	3½	5	1½	115
132	C4132	14½	33.000	33.500	B ₃	1½	3½	5	1½	129
144	C4144	14½	36.000	36.500	B ₃	1½	3½	5½	1½	140

* Recommended Maximum Bore With Keyway and Set Screw.

14½° P.A. Gears Will Not Operate With 20° P.A.

5 DP 1³/₄" Face

Steel Stock Spur Gears 14¹/₂° Pressure Angle

Martin



Type B
Plain With Hub



Type B₂
Web With Lighten Holes

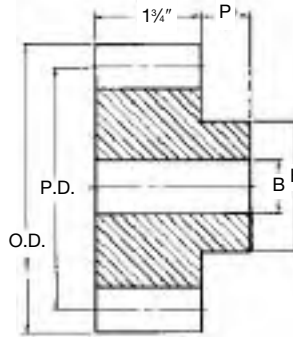

Type B

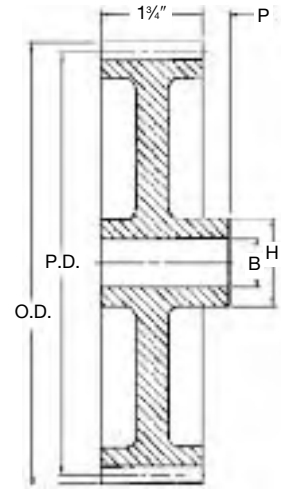

Type B₂

Steel

No. Teeth	Catalog Number	Pressure Angle (Deg.)	Diameter		Type	Bore (Inches)		Hub (Inches)		Weight Lbs. (App.)
			Pitch	Outside		Stock	Max. *	Diameter	Proj.	
11	S511	14 ¹ / ₂	2.400†	2.800	B	1 ¹ / ₁₆	1 ¹ / ₁₆	1 ³ / ₁₆	3 ¹ / ₁₆	2.0
12	S512	14 ¹ / ₂	2.400	2.800	B	1 ¹ / ₁₆	1 ¹ / ₁₆	1 ⁵ / ₁₆	3 ¹ / ₁₆	2.0
13	S513	14 ¹ / ₂	2.600	3.000	B	1 ¹ / ₁₆	1 ¹ / ₁₆	2	3 ¹ / ₁₆	2.6
14	S514	14 ¹ / ₂	2.800	3.200	B	1 ¹ / ₁₆	1 ¹ / ₁₆	2 ¹ / ₁₆	3 ¹ / ₁₆	3.1
15	S515	14 ¹ / ₂	3.000	3.400	B	1 ¹ / ₁₆	1 ¹ / ₁₆	2 ¹ / ₈	3 ¹ / ₁₆	3.7
16	S516	14 ¹ / ₂	3.200	3.600	B	1 ¹ / ₁₆	1 ¹ / ₁₆	2 ³ / ₁₆	3 ¹ / ₁₆	4.5
17	S517	14 ¹ / ₂	3.400	3.800	B	1 ¹ / ₁₆	1 ³ / ₁₆	2 ¹ / ₄	3 ¹ / ₁₆	5.2
18	S518	14 ¹ / ₂	3.600	4.000	B	1 ¹ / ₁₆	1 ¹ / ₈	3	3 ¹ / ₁₆	5.9
19	S519	14 ¹ / ₂	3.800	4.200	B	1 ¹ / ₁₆	2 ¹ / ₈	3 ¹ / ₈	3 ¹ / ₁₆	6.7
20	S520	14 ¹ / ₂	4.000	4.400	B	1 ¹ / ₁₆	2 ¹ / ₄	3 ³ / ₈	3 ¹ / ₁₆	7.5
21	S521	14 ¹ / ₂	4.200	4.600	B	1 ¹ / ₁₆	2 ¹ / ₄	3 ³ / ₈	3 ¹ / ₁₆	8.1
22	S522	14 ¹ / ₂	4.400	4.800	B	1 ¹ / ₁₆	2 ¹ / ₄	3 ³ / ₈	3 ¹ / ₁₆	8.8
23	S523	14 ¹ / ₂	4.600	5.000	B	1 ¹ / ₁₆	2 ¹ / ₄	3 ³ / ₈	3 ¹ / ₁₆	9.5
24	S524	14 ¹ / ₂	4.800	5.200	B	1 ¹ / ₁₆	2 ¹ / ₄	3 ³ / ₈	1 ¹ / ₄	11.0
25	S525	14 ¹ / ₂	5.000	5.400	B	1 ¹ / ₁₆	2 ¹ / ₄	3 ³ / ₈	1 ¹ / ₄	11.8
26	S526	14 ¹ / ₂	5.200	5.600	B	1 ¹ / ₁₆	2 ¹ / ₄	3 ³ / ₈	1 ¹ / ₄	12.9
28	S528	14 ¹ / ₂	5.600	6.000	B	1 ¹ / ₁₆	2 ¹ / ₄	3 ³ / ₈	1 ¹ / ₄	14.3
30	S530	14 ¹ / ₂	6.000	6.400	B	1 ¹ / ₁₆	2 ¹ / ₄	3 ³ / ₈	1 ¹ / ₄	16.0
35	S535	14 ¹ / ₂	7.000	7.400	B	1 ¹ / ₁₆	2 ³ / ₈	4 ¹ / ₈	1 ¹ / ₄	22.8
40	S540	14 ¹ / ₂	8.000	8.400	B	1 ¹ / ₁₆	2 ³ / ₈	4 ¹ / ₈	1 ¹ / ₄	28.5
45	S545	14 ¹ / ₂	9.000	9.400	B	1 ¹ / ₁₆	2 ¹ / ₂	4 ¹ / ₂	1 ¹ / ₄	35.0
50	S550	14 ¹ / ₂	10.000	10.400	B	1 ¹ / ₁₆	2 ³ / ₈	4 ¹ / ₂	1 ¹ / ₄	43.6
55	S555	14 ¹ / ₂	11.000	11.400	B	1 ¹ / ₁₆	2 ⁵ / ₈	4 ¹ / ₂	1 ¹ / ₄	52.0
60	S560	14 ¹ / ₂	12.000	12.400	B	1 ¹ / ₁₆	2 ⁵ / ₈	4 ¹ / ₂	1 ¹ / ₄	60.9
70	S570	14 ¹ / ₂	14.000	14.400	B ₂	1 ¹ / ₁₆	3 ¹ / ₈	5	1 ¹ / ₄	48.4
80	S580	14 ¹ / ₂	16.000	16.400	B ₂	1 ¹ / ₁₆	3 ¹ / ₈	5	1 ¹ / ₄	57.0
90	S590	14 ¹ / ₂	18.000	18.400	B ₂	1 ¹ / ₁₆	3 ¹ / ₈	5	1 ¹ / ₄	67.0
100	S5100	14 ¹ / ₂	20.000	20.400	B ₂	1 ¹ / ₁₆	3 ¹ / ₈	5 ¹ / ₂	1 ¹ / ₄	62.0
110	S5110	14 ¹ / ₂	22.000	22.400	B ₂	1 ¹ / ₁₆	3 ¹ / ₈	5 ¹ / ₂	1 ¹ / ₂	87.6
120	S5120	14 ¹ / ₂	24.000	24.400	B ₂	1 ¹ / ₁₆	3 ¹ / ₈	6 ¹ / ₂	1 ¹ / ₂	113

* Recommended Maximum Bore With Keyway and Setscrew.
† Enlarged Pitch Diameter with Special Tooth Form.

14¹/₂° P.A. Gears Will Not Operate With 20° P.A.

Martin

Cast Iron Stock Spur Gears

14½° Pressure Angle

5 DP

1¾" Face



Type B
Plain With Hub



Type B₁
Web



Type B₂
Web With
Lighten Holes



Type B₃
Web With
Spokes

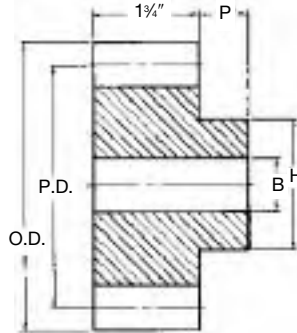

Type B

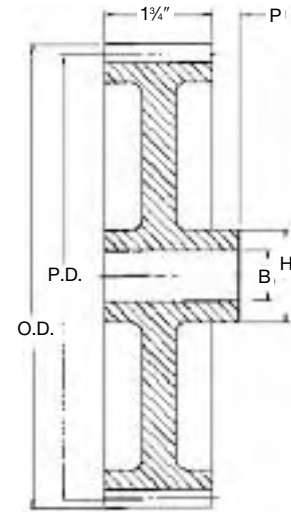

Type B₁, B₂, B₃

Cast — Style "B"

No. Teeth	Catalog Number	Pressure Angle (Deg.)	Diameter		Type	Bore (Inches)		Hub (Inches)		Weight Lbs. (App.)
			Pitch	Outside		Stock	Max. *	Diameter	Proj.	
24	C524	14½	4.800	5.200	B	1⅙	2⅞	¾	1¼	9.9
25	C525	14½	5.000	5.400	B	1⅙	2⅞	¾	1¼	10.6
28	C528	14½	5.600	6.000	B	1⅙	2⅞	¾	1¼	12.1
30	C530	14½	6.000	6.400	B	1⅙	2⅞	¾	1¼	13.9
32	C532	14½	6.400	6.800	B	1⅙	2⅞	¾	1¼	13.5
35	C535	14½	7.000	7.400	B	1⅙	2⅞	¾	1¼	16.9
36	C536	14½	7.200	7.600	B	1⅙	2⅞	¾	1¼	15.5
40	C540	14½	8.000	8.400	B	1⅙	2⅞	¾	1¼	17.4
45	C545	14½	9.000	9.400	B	1⅙	2⅞	¾	1¼	20.3
48	C548	14½	9.600	10.000	B	1⅙	2⅞	¾	1¼	25.2
50	C550	14½	10.000	10.400	B	1⅙	2⅞	¾	1¼	23.7
54	C554	14½	10.800	11.200	B	1⅙	2⅞	¾	1¼	25.1
55	C555	14½	11.000	11.400	B	1⅙	2⅞	¾	1¼	26.0
60	C560	14½	12.000	12.400	B	1⅙	2⅞	¾	1¼	30.6
64	C564	14½	12.800	13.200	B	1⅙	2⅞	¾	1¼	31.2
66	C566	14½	13.200	13.600	B	1⅙	2⅞	¾	1¼	30.8
70	C570	14½	14.000	14.400	B	1⅙	2⅞	4	1¼	34.5
72	C572	14½	14.400	14.800	B	1⅙	2⅞	4	1¼	35.0
75	C575	14½	15.000	15.400	B	1⅙	2⅞	4	1¼	36.7
80	C580	14½	16.000	16.400	B	1⅙	2⅞	4	1¼	40.8
84	C584	14½	16.800	17.200	B	1⅙	2⅞	4	1¼	40.0
90	C590	14½	18.000	18.400	B	1⅙	2⅞	4	1¼	45.4
96	C596	14½	19.200	19.600	B	1⅙	2⅞	4	1¼	48.6
100	C5100	14½	20.000	20.400	B	1⅙	2⅞	4½	1½	54.4
120	C5120	14½	24.000	24.400	B	1⅙	2⅞	4¾	1½	56.1
130	C5130	14½	26.000	26.400	B	1⅙	2⅞	4¾	1½	70.2

* Recommended maximum bore with keyway and set screw.

Quotes for large quantity discontinued cast iron sizes, contact your nearest *Martin* Facility.

14½° P.A. Gears Will Not Operate With 20° P.A.

GEARS

6 DP 1 1/2" Face

Steel Stock Spur Gears 14 1/2° Pressure Angle



Type B
Plain With Hub



Type B₂
Web With
Lighten Holes

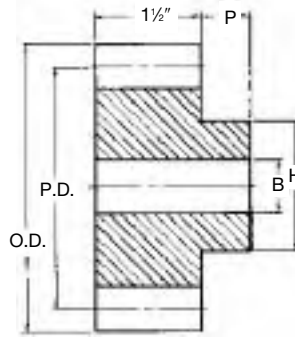

Type B

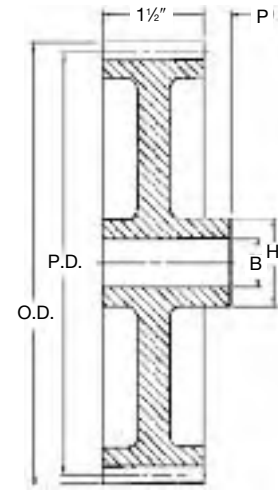

Type B₂

Steel

GEARS

No. Teeth	Catalog Number	Pressure Angle (Deg.)	Diameter		Type	Bore (Inches)		Hub (Inches)		Weight Lbs. (App.)
			Pitch	Outside		Stock	Max. *	Diameter	Proj.	
11	S611	14 1/2	2.000†	2.333	B	1	**	1 1/2	3/8	1.1
12	S612	14 1/2	2.000	2.333	B	1	**	1 1/2	3/8	1.1
14	S614	14 1/2	2.333	2.666	B	1	1 1/16	1 1/16	3/8	1.8
15	S615	14 1/2	2.500	2.833	B	1	1 1/4	2	3/8	2.2
16	S616	14 1/2	2.666	3.000	B	1	1 1/16	2 1/2	3/8	2.6
18	S618	14 1/2	3.000	3.333	B	1	1 1/2	2 1/2	3/8	3.5
20	S620	14 1/2	3.333	3.666	B	1	1 1/2	2 7/8	3/8	4.6
21	S621	14 1/2	3.500	3.833	B	1	1 1/2	3	3/8	5.1
22	S622	14 1/2	3.666	4.000	B	1	1 1/2	3	3/8	5.5
24	S624	14 1/2	4.000	4.333	B	1 1/2	1 1/2	3	1	6.5
27	S627	14 1/2	4.500	4.833	B	1 1/2	1 1/2	3	1	6.6
28	S628	14 1/2	4.666	5.000	B	1 1/2	1 1/2	3	1	8.3
30	S630	14 1/2	5.000	5.333	B	1 1/2	2"	3 1/2	1	9.5
32	S632	14 1/2	5.333	5.666	B	1 1/2	2"	3 1/2	1	10.7
33	S633	14 1/2	5.500	5.833	B	1 1/2	2 1/8	3 1/2	1	11.3
36	S636	14 1/2	6.000	6.333	B	1 1/2	2 1/8	3 1/2	1	13.3
39	S639	14 1/2	6.500	6.833	B	1 1/2	2 1/2	4	1	16.6
40	S640	14 1/2	6.666	7.000	B	1 1/2	2 1/2	4	1	17.6
42	S642	14 1/2	7.000	7.333	B	1 1/2	2 1/2	4	1	18.9
45	S645	14 1/2	7.500	7.833	B	1 1/2	2 1/2	4	1	21.3
48	S648	14 1/2	8.000	8.333	B	1 1/2	2 1/2	4 1/2	1	24.3
52	S652	14 1/2	8.666	9.000	B	1 1/2	2 1/2	4 1/2	1	27.9
54	S654	14 1/2	9.000	9.333	B	1 1/2	2 1/2	4 1/2	1	30.4
58	S658	14 1/2	9.666	10.000	B	1 1/2	2 1/2	4 1/2	1	33.9
60	S660	14 1/2	10.000	10.333	B	1 1/2	2 1/2	4 1/2	1 1/4	34.3
64	S664	14 1/2	10.666	11.000	B	1 1/2	2 1/2	4 1/2	1 1/4	42.2
66	S666	14 1/2	11.000	11.333	B	1 1/2	2 1/2	4 1/2	1 1/4	50.0
72	S672	14 1/2	12.000	12.333	B	1 1/2	2 11/16	4 1/2	1 1/4	53.0
84	S684	14 1/2	14.000	14.333	B ₂	1 1/2	2 11/16	4 1/2	1 1/4	40.0
96	S696	14 1/2	16.000	16.333	B ₂	1 1/2	2 11/16	5 1/2	1 1/4	43.8
108	S6108	14 1/2	18.000	18.333	B ₂	1 1/2	2 11/16	5 1/2	1 1/4	53.0
120	S6120	14 1/2	20.000	20.333	B ₂	1 1/2	2 11/16	5 1/2	1 1/4	63.2
132	S6132	14 1/2	22.000	22.333	B ₂	1 1/2	2 11/16	5 1/2	1 1/4	68.3
144	S6144	14 1/2	24.000	24.333	B ₂	1 1/2	3 1/8	5	1 1/4	82.7

* Recommended maximum bore with keyway and set screw.
 ** Check application with factory.
 † Enlarged pitch diameter with special tooth form.

14 1/2° P.A. Gears Will Not Operate With 20° P.A.

Martin

Cast Iron Stock Spur Gears

14½° Pressure Angle

6 DP 1½" Face



Type B Plain With Hub



Type B₁ Web



Type B₂
Web With Lighten Holes



Type B₃
Web With Spokes

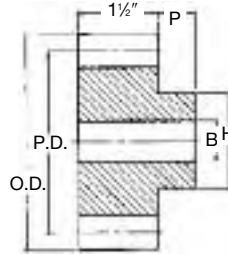

Type B

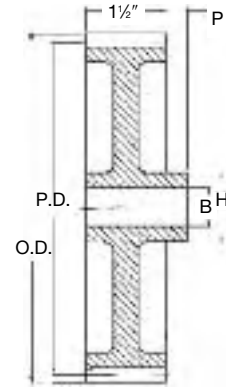

Type B₁, B₂, B₃

Cast — Style “B”

No. Teeth	Catalog Number	Pressure Angle (Deg.)	Diameter		Type	Bore (Inches)		Hub (Inches)		Weight Lbs. (App.)
			Pitch	Outside		Stock	Max.*	Diameter	Proj.	
• 32	C632	14½	5.333	5.666	B ₁	1½	1⅞	2½	1	7.2
• 40	C640	14½	6.666	7.000	B ₁	1½	1⅞	3	1	11.9
• 42	C642	14½	7.000	7.333	B ₁	1½	1⅞	3	1	13.0
• 48	C648	14½	8.000	8.333	B ₁	1½	1⅞	3	1	12.1
• 54	C654	14½	9.000	9.333	B ₁	1½	2⅞	3¼	1	14.4
• 60	C660	14½	10.000	10.333	B ₁	1½	2⅞	3¼	1¼	17.0
• 64	C664	14½	10.666	11.000	B ₁	1½	2⅞	3¼	1¼	18.5
66	C666	14½	11.000	11.333	B ₁	1½	2⅞	3¼	1¼	19.0
70	C670	14½	11.666	12.000	B ₁	1½	2⅞	3¼	1¼	20.6
72	C672	14½	12.000	12.333	B ₁	1½	2⅞	3½	1¼	23.7
75	C675	14½	12.500	12.833	B ₁	1½	2⅞	3½	1¼	25.4
80	C680	14½	13.333	13.666	B ₁	1½	2⅞	3½	1¼	25.8
84	C684	14½	14.000	14.333	B ₁	1½	2⅞	3½	1¼	25.0
90	C690	14½	15.000	15.333	B ₁	1½	2⅞	3½	1¼	25.8
96	C696	14½	16.000	16.333	B ₁	1½	2⅞	3½	1¼	28.0
108	C6108	14½	18.000	18.333	B ₁	1½	2⅞	3¾	1¼	32.0
120	C6120	14½	20.000	20.333	B ₁	1½	2⅞	3¾	1½	34.8
132	C6132	14½	22.000	22.333	B ₁	1½	2⅞	3¾	1½	43.4
144	C6144	14½	24.000	24.333	B ₁	1½	2⅞	4	1½	45.2
180	C6180	14½	30.000	30.333	B ₁	1½	2⅞	4	1½	58.3

* Recommended maximum bore with keyway and set screw
• Consult Factory.

14½° P.A. Gears Will Not Operate With 20° P.A.

Bored-to-Size

No. Teeth	Catalog Number	Pressure Angle (Deg.)	Diameter		Type	Bore (Inches)		Set Screw	Hub (Inches)		Weight Lbs. (App.)
			Pitch	Outside		Stock	Keyway		Diameter	Proj.	
11	S611BS 1	14½	2.000	2.333	B	1	¼ X ¼	(1) 1/4-20 @ 90	1½	¾	1.10
12	S612BS 1	14½	2.000	2.333	B	1	¼ X ¼	(1) 1/4-20 @ 90	1½	¾	1.10
14	S614BS 1	14½	2.333	2.667	B	1	¼ X ¼	(1) 5/16-18 @ 90	1⅞	¾	1.80
14	S614BS 1-1/8	14½	2.333	2.667	B	1-½	¼ X ¼	(1) 5/16-18 @ 90	1⅞	¾	1.80
15	S615BS 1	14½	2.500	2.833	B	1	¼ X ¼	(1) 5/16-18 @ 90	2	¾	2.20
15	S615BS 1-1/8	14½	2.500	2.833	B	1-½	¼ X ¼	(1) 5/16-18 @ 90	2	¾	2.20
15	S615BS 1-3/16	14½	2.500	2.833	B	1-¾	¼ X ¼	(1) 5/16-18 @ 90	2	¾	2.20
15	S615BS 1-1/4	14½	2.500	2.833	B	1-½	¼ X ¼	(1) 5/16-18 @ 90	2	¾	2.20
16	S616BS 1	14½	2.667	3.000	B	1	¼ X ¼	(1) 5/16-18 @ 90	2 ⅝	¾	2.60
16	S616BS 1-1/8	14½	2.667	3.000	B	1-½	¼ X ¼	(1) 5/16-18 @ 90	2 ⅝	¾	2.60
16	S616BS 1-3/16	14½	2.667	3.000	B	1-¾	¼ X ¼	(1) 5/16-18 @ 90	2 ⅝	¾	2.60
16	S616BS 1-1/4	14½	2.667	3.000	B	1-½	¼ X ¼	(1) 5/16-18 @ 90	2 ⅝	¾	2.60
18	S618BS 1	14½	3.000	3.333	B	1	¼ X ¼	(1) 5/16-18 @ 90	2 ½	¾	3.50
18	S618BS 1-1/8	14½	3.000	3.333	B	1-½	¼ X ¼	(1) 5/16-18 @ 90	2 ½	¾	3.50
18	S618BS 1-3/16	14½	3.000	3.333	B	1-¾	¼ X ¼	(1) 5/16-18 @ 90	2 ½	¾	3.50
18	S618BS 1-1/4	14½	3.000	3.333	B	1-½	¼ X ¼	(1) 5/16-18 @ 90	2 ½	¾	3.50
20	S620BS 1	14½	3.333	3.667	B	1	¼ X ¼	(1) 5/16-18 @ 90	2 ⅞	¾	4.60
20	S620BS 1-1/8	14½	3.333	3.667	B	1-½	¼ X ¼	(1) 5/16-18 @ 90	2 ⅞	¾	4.60
20	S620BS 1-3/16	14½	3.333	3.667	B	1-¾	¼ X ¼	(1) 5/16-18 @ 90	2 ⅞	¾	4.60
20	S620BS 1-1/4	14½	3.333	3.667	B	1-½	¼ X ¼	(1) 5/16-18 @ 90	2 ⅞	¾	4.60

GEARS

8 DP 1 1/4" Face

Steel Stock Spur Gears 14 1/2° Pressure Angle

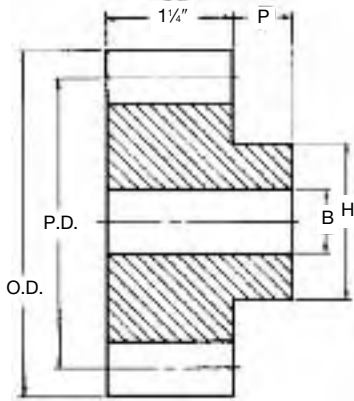

Type B



Type B
Plain With Hub

Steel

No. Teeth	Catalog Number	Pressure Angle (Deg.)	Diameter		Type	Bore (Inches)		Hub (Inches)		Weight Lbs. (App.)
			Pitch	Outside		Stock	Max. *	Diameter	Proj.	
11	S811	14 1/2	1.500†	1.750	B	3/8	**	1 1/8	3/8	.5
12	S812	14 1/2	1.500	1.750	B	3/8	**	1 1/8	3/8	.5
13	S813	14 1/2	1.625	1.875	B	3/8	**	1 1/8	3/8	.7
14	S814	14 1/2	1.750	2.000	B	3/8	1/8	1 1/8	3/8	.9
15	S815	14 1/2	1.875	2.125	B	7/8	7/8	1 1/2	3/8	.9
16	S816	14 1/2	2.000	2.250	B	7/8	1/8	1 1/2	3/8	1.1
17	S817	14 1/2	2.125	2.375	B	7/8	1	1 1/2	3/8	1.3
18	S818	14 1/2	2.250	2.500	B	7/8	1 1/8	1 1/2	3/8	1.6
19	S819	14 1/2	2.375	2.625	B	7/8	1 1/4	2	3/8	1.8
20	S820	14 1/2	2.500	2.750	B	7/8	1 1/2	2 1/8	3/8	2.0
21	S821	14 1/2	2.625	2.875	B	7/8	1 1/2	2 1/8	3/8	2.3
22	S822	14 1/2	2.750	3.000	B	7/8	1 1/2	2 1/8	3/8	2.6
24	S824	14 1/2	3.000	3.250	B	7/8	1 1/2	2 1/8	1	3.6
26	S826	14 1/2	3.250	3.500	B	7/8	1 1/2	2 1/8	1	3.9
28	S828	14 1/2	3.500	3.750	B	7/8	1 1/2	2 1/8	1	4.4
30	S830	14 1/2	3.750	4.000	B	7/8	1 1/2	2 1/8	1	5.1
32	S832	14 1/2	4.000	4.250	B	1	1 1/2	2 1/8	1	5.6
36	S836	14 1/2	4.500	4.750	B	1	1 1/2	3	1	7.0
40	S840	14 1/2	5.000	5.250	B	1	1 1/2	3	1	8.3
42	S842	14 1/2	5.250	5.500	B	1	1 1/2	3	1	9.0
44	S844	14 1/2	5.500	5.750	B	1	1 1/2	3	1	9.7
48	S848	14 1/2	6.000	6.250	B	1	1 1/2	3	1	11.3

* Recommended maximum bore with keyway and set screw.

** Check application with factory.

† Enlarged pitch diameter with special tooth form.

14 1/2° P.A. Gears Will Not Operate With 20° P.A.

Martin

Cast Iron Stock Spur Gears

14½° Pressure Angle

8 DP

1¼" Face



Type B Plain With Hub



Type B₁ Web



Type B₂
Web With Lighten Holes



Type B₃
Web With Spokes

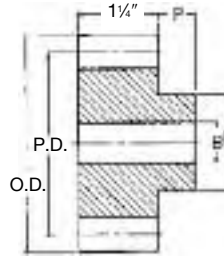

Type B

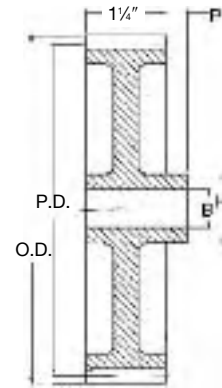

Type B₁, B₂, B₃

Cast — Style "B"

No. Teeth	Catalog Number	Pressure Angle (Deg.)	Diameter		Type	Bore (Inches)		Hub (Inches)		Weight Lbs. (App.)
			Pitch	Outside		Stock	Max.*	Diameter	Proj.	
• 36	C836	14½	4.500	4.750	B ₁	1	1 1/16	2 1/2	1	4.5
• 40	C840	14½	5.000	5.250	B ₁	1	1 1/16	2 1/2	1	5.1
• 42	C842	14½	5.250	5.500	B ₁	1	1 1/16	2 1/2	1	5.5
• 44	C844	14½	5.500	5.750	B ₁	1	1 1/16	2 1/2	1	6.0
52	C852	14½	6.500	6.750	B ₁	1	1 1/16	2 3/4	1	10.3
54	C854	14½	6.750	7.000	B ₁	1	1 1/16	2 3/4	1	8.1
56	C856	14½	7.000	7.250	B ₁	1	1 1/16	2 3/4	1	8.2
60	C860	14½	7.500	7.750	B ₁	1	1 1/16	2 3/4	1	8.8
64	C864	14½	8.000	8.250	B ₁	1	1 1/16	2 3/4	1	11.2
68	C868	14½	8.500	8.750	B ₁	1	1 1/16	3"	1	11.5
72	C872	14½	9.000	9.250	B ₁	1	1 1/16	3"	1	11.7
76	C876	14½	9.500	9.750	B ₁	1	1 1/16	3"	1	12.0
80	C880	14½	10.000	10.250	B ₁	1 1/8	1 1/16	3"	1 1/8	12.2
84	C884	14½	10.500	10.750	B ₁	1 1/8	1 1/16	3"	1 1/8	13.2
88	C888	14½	11.000	11.250	B ₁	1 1/8	1 1/16	3"	1 1/8	13.5
92	C892	14½	11.500	11.750	B ₁	1 1/8	2 1/16	3 1/4	1 1/8	15.0
96	C896	14½	12.000	12.250	B ₁	1 1/8	2 1/16	3 1/4	1 1/8	15.8
100	C8100	14½	12.500	12.750	B ₁	1 1/8	2 1/16	3 1/4	1 1/8	16.5
112	C8112	14½	14.000	14.250	B ₁	1 1/8	2 1/16	3 1/4	1 1/8	17.7
120	C8120	14½	15.000	15.250	B ₁	1 1/8	2 1/16	3 1/4	1 1/8	18.4
128	C8128	14½	16.000	16.250	B ₁	1 1/8	2 3/16	3 1/2	1 1/8	21.3
144	C8144	14½	18.000	18.250	B ₁	1 1/8	2 3/16	3 1/2	1 1/8	24.2
160	C8160	14½	20.000	20.250	B ₁	1 1/8	2 3/16	3 3/4	1 1/8	26.6
168	C8168	14½	21.000	21.250	B ₁	1 1/8	2 3/16	3 3/4	1 1/8	28.9

* Recommended maximum bore with keyway and set screw.
• Consult Factory.

14½° P.A. Gears Will Not Operate With 20° P.A.

Bored-to-Size

No. Teeth	Catalog Number	Pressure Angle (Deg.)	Diameter		Type	Bore (Inches)		Set Screw	Hub (Inches)		Weight Lbs. (App.)
			Pitch	Outside		Stock	Keyway		Diameter	Proj.	
11	S811BS 3/4	14½	1.500	1.750	B	3/4	3/16 X 3/32	(1) 10-24 @ 90	1 1/8	3/4	0.50
12	S812BS 3/4	14½	1.500	1.750	B	3/4	3/16 X 3/32	(1) 10-24 @ 90	1 1/8	3/4	0.50
14	S814BS 3/4	14½	1.750	2.000	B	3/4	3/16 X 3/32	(1) 1/4-20 @ 90	1 1/8	3/4	0.90
15	S815BS 7/8	14½	1.875	2.125	B	7/8	3/16 X 3/32	(1) 1/4-20 @ 90	1 1/2	3/4	1.00
16	S816BS 7/8	14½	2.000	2.250	B	7/8	3/16 X 3/32	(1) 1/4-20 @ 90	1 1/8	3/4	1.10
16	S816BS 1	14½	2.000	2.250	B	1	1/4 X 1/8	(1) 5/16-18 @ 90	1 1/8	3/4	1.10
18	S818BS 7/8	14½	2.250	2.500	B	7/8	3/16 X 3/32	(1) 1/4-20 @ 90	1 1/8	3/4	1.60
18	S818BS 1	14½	2.250	2.500	B	1	1/4 X 1/8	(1) 5/16-18 @ 90	1 1/8	3/4	1.60
18	S818BS 1-1/8	14½	2.250	2.500	B	1 1/8	1/4 X 1/8	(1) 5/16-18 @ 90	1 1/8	3/4	1.60
20	S820BS 7/8	14½	2.500	2.750	B	7/8	3/16 X 3/32	(1) 1/4-20 @ 90	2 1/8	3/4	2.00
20	S820BS 1	14½	2.500	2.750	B	1	1/4 X 1/8	(1) 5/16-18 @ 90	2 1/8	3/4	2.00
20	S820BS 1-1/8	14½	2.500	2.750	B	1 1/8	1/4 X 1/8	(1) 5/16-18 @ 90	2 1/8	3/4	2.00
22	S822BS 7/8	14½	2.750	3.000	B	7/8	3/16 X 3/32	(1) 1/4-20 @ 90	2 3/8	3/4	2.60
22	S822BS 1	14½	2.750	3.000	B	1	1/4 X 1/8	(1) 5/16-18 @ 90	2 3/8	3/4	2.60
22	S822BS 1-1/8	14½	2.750	3.000	B	1 1/8	1/4 X 1/8	(1) 5/16-18 @ 90	2 3/8	3/4	2.60

GEARS

10 DP 1" Face

Steel Stock Spur Gears 14½° Pressure Angle

Martin

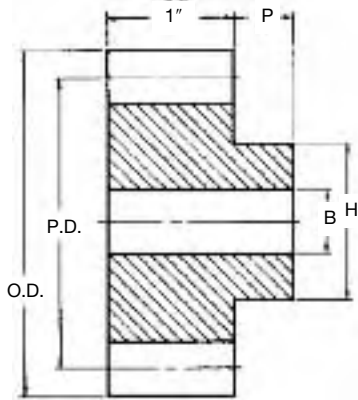

Type B



Type B
Plain With Hub

Steel

No. Teeth	Catalog Number	Pressure Angle (Deg.)	Diameter		Type	Bore (Inches)		Hub (Inches)		Weight Lbs. (App.)
			Pitch	Outside		Stock	Max. *	Diameter	Proj.	
11	S1011	14½	1.200 †	1.400	B	¾	**	1⁄16	5⁄8	.3
12	S1012	14½	1.200	1.400	B	¾	**	1⁄16	5⁄8	.3
13	S1013	14½	1.300	1.500	B	¾	**	1	5⁄8	.3
14	S1014	14½	1.400	1.600	B	¾	5⁄8	1½	5⁄8	.4
15	S1015	14½	1.500	1.700	B	¾	¾	1½	5⁄8	.5
16	S1016	14½	1.600	1.800	B	¾	¾	1½	5⁄8	.6
17	S1017	14½	1.700	1.900	B	¾	13⁄16	1½	5⁄8	.6
18	S1018	14½	1.800	2.000	B	¾	7⁄8	1½	5⁄8	.8
19	S1019	14½	1.900	2.100	B	¾	7⁄8	1½	5⁄8	.9
20	S1020	14½	2.000	2.200	B	¾	1	1¾	5⁄8	1.0
21	S1021	14½	2.100	2.300	B	¾	1	1½	5⁄8	1.2
22	S1022	14½	2.200	2.400	B	¾	1½	1½	5⁄8	1.3
24	S1024	14½	2.400	2.600	B	¾	1½	2½	5⁄8	1.6
25	S1025	14½	2.500	2.700	B	¾	1½	2½	5⁄8	1.8
26	S1026	14½	2.600	2.800	B	¾	1½	2½	5⁄8	1.9
28	S1028	14½	2.800	3.000	B	¾	1½	2½	7⁄8	2.3
30	S1030	14½	3.000	3.200	B	¾	1½	2½	7⁄8	2.6
32	S1032	14½	3.200	3.400	B	¾	1½	2½	7⁄8	2.9
35	S1035	14½	3.500	3.700	B	¾	1½	2½	7⁄8	3.4
36	S1036	14½	3.600	3.800	B	¾	1½	2½	7⁄8	3.5
38	S1038	14½	3.800	4.000	B	¾	1½	2½	7⁄8	3.8
40	S1040	14½	4.000	4.200	B	7⁄8	1½	2½	7⁄8	4.1
42	S1042	14½	4.200	4.400	B	7⁄8	1½	2½	7⁄8	4.5
45	S1045	14½	4.500	4.700	B	7⁄8	1½	2½	7⁄8	5.3
48	S1048	14½	4.800	5.000	B	7⁄8	1½	2½	7⁄8	5.9
50	S1050	14½	5.000	5.200	B	7⁄8	1½	2½	7⁄8	6.4
54	S1054	14½	5.400	5.600	B	7⁄8	1½	2½	7⁄8	7.8
55	S1055	14½	5.500	5.700	B	7⁄8	1½	2½	7⁄8	7.9
60	S1060	14½	6.000	6.200	B	7⁄8	1½	2½	7⁄8	8.7

* Recommended maximum bore with keyway and set screw.

** Check application with factory.

† Enlarged pitch diameter with special tooth form.

14½° P.A. Gears Will Not Operate With 20° P.A.



Cast Iron Stock Spur Gears

14½° Pressure Angle

10 DP 1" Face



Type B
Plain With Hub



Type B₁
Web



Type B₂
Web With
Lighten Holes



Type B₃
Web With
Spokes

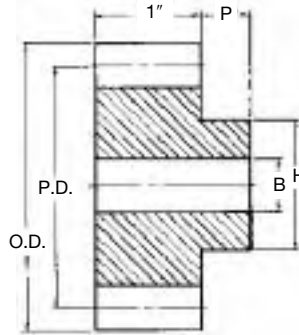

Type B

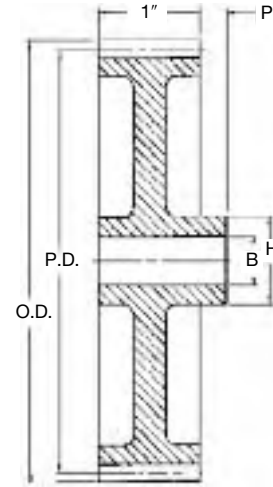

Type B₁, B₂, B₃

Cast — Style “B”

No. Teeth	Catalog Number	Pressure Angle (Deg.)	Diameter		Type	Bore (Inches)		Hub (Inches)		Weight Lbs. (App.)
			Pitch	Outside		Stock	Max.*	Diameter	Proj.	
• 60	C1060	14½	6.000	6.200	B ₃	⅞	1⅞	2½	⅞	4.3
64	C1064	14½	6.400	6.600	B ₃	⅞	1⅞	2½	⅞	5.6
65	C1065	14½	6.500	6.700	B ₃	⅞	1⅞	2½	⅞	5.6
70	C1070	14½	7.000	7.200	B ₃	⅞	1⅞	2½	⅞	5.9
72	C1072	14½	7.200	7.500	B ₃	⅞	1⅞	2½	⅞	6.3
75	C1075	14½	7.500	7.700	B ₃	⅞	1⅞	2½	⅞	6.7
80	C1080	14½	8.000	8.200	B ₃	⅞	1⅞	2½	⅞	7.0
84	C1084	14½	8.400	8.600	B ₃	⅞	1⅞	2½	⅞	6.9
85	C1085	14½	8.500	8.700	B ₃	⅞	1⅞	2½	⅞	7.3
90	C1090	14½	9.000	9.200	B ₃	⅞	1⅞	2½	⅞	7.6
95	C1095	14½	9.500	9.700	B ₃	⅞	1⅞	2½	⅞	8.1
96	C1096	14½	9.600	9.800	B ₃	⅞	1⅞	2½	⅞	8.1
100	C10100	14½	10.000	10.200	B ₃	1	1⅞	2½	⅞	10.3
105	C10105	14½	10.500	10.700	B ₃	1	1⅞	2½	1	10.4
110	C10110	14½	11.000	11.200	B ₃	1	1⅞	2½	1	10.0
112	C10112	14½	11.200	11.400	B ₃	1	1⅞	2½	1	10.2
120	C10120	14½	12.000	12.200	B ₃	1	1⅞	2½	1	11.1
130	C10130	14½	13.000	13.200	B ₃	1	1⅞	2½	1	13.4
140	C10140	14½	14.000	14.200	B ₃	1	1⅞	2½	1	30.8
150	C10150	14½	15.000	15.200	B ₁	1	1⅞	2½	1	33.0
160	C10160	14½	16.000	16.200	B ₁	1	1⅞	2½	1	38.3
180	C10180	14½	18.000	18.200	B ₃	1	1⅞	3	1	43.6

* Recommended maximum bore with keyway and set screw.
• Consult Factory.

14½° P.A. Gears Will Not Operate With 20° P.A.

Bored-to-Size

No. Teeth	Catalog Number	Pressure Angle (Deg.)	Diameter		Type	Bore (Inches)		Set Screw	Hub (Inches)		Weight Lbs. (App.)
			Pitch	Outside		Stock	Keyway		Diameter	Proj.	
11	S1011BS 5/8	14½	1.200	1.400	B	⅝	⅜ X ⅜	(1) 10-24 @ 90	1⅞	⅞	0.30
12	S1012BS 5/8	14½	1.200	1.400	B	⅝	⅜ X ⅜	(1) 10-24 @ 90	1⅞	⅞	0.30
14	S1014BS 5/8	14½	1.400	1.600	B	⅝	⅜ X ⅜	(1) 1/4-20 @ 90	1⅞	⅞	0.40
15	S1015BS 3/4	14½	1.500	1.700	B	⅝	⅜ X ⅜	(1) 1/4-20 @ 90	1⅞	⅞	0.50
16	S1016BS 3/4	14½	1.600	1.800	B	⅝	⅜ X ⅜	(1) 1/4-20 @ 90	1⅞	⅞	0.60
18	S1018BS 3/4	14½	1.800	2.000	B	⅝	⅜ X ⅜	(1) 1/4-20 @ 90	1⅞	⅞	0.80
18	S1018BS 7/8	14½	1.800	2.000	B	⅝	⅜ X ⅜	(1) 1/4-20 @ 90	1⅞	⅞	0.80
20	S1020BS 3/4	14½	2.000	2.200	B	⅝	⅜ X ⅜	(1) 1/4-20 @ 90	1⅞	⅞	1.00
20	S1020BS 7/8	14½	2.000	2.200	B	⅝	⅜ X ⅜	(1) 1/4-20 @ 90	1⅞	⅞	1.00
20	S1020BS 1	14½	2.000	2.200	B	1	¼ X ⅜	(1) 5/16-18 @ 90	1⅞	⅞	1.00
24	S1024BS 3/4	14½	2.400	2.600	B	⅝	⅜ X ⅜	(1) 1/4-20 @ 90	2⅞	⅞	1.60
24	S1024BS 7/8	14½	2.400	2.600	B	⅝	⅜ X ⅜	(1) 1/4-20 @ 90	2⅞	⅞	1.60
24	S1024BS 1	14½	2.400	2.600	B	1	¼ X ⅜	(1) 5/16-18 @ 90	2⅞	⅞	1.60

12 DP

3/4" Face

Steel Stock Spur Gears

14½° Pressure Angle

Martin

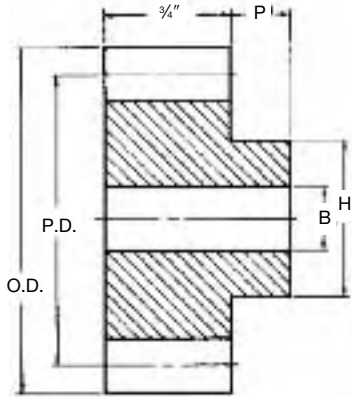

Type B



Type B
Plain With Hub

Steel

No. Teeth	Catalog Number	Pressure Angle (Deg.)	Diameter		Type	Bore (Inches)		Hub (Inches)		Weight Lbs. (App.)
			Pitch	Outside		Stock	Max. *	Diameter	Proj.	
11	S1211	14½	1.000†	1.167	B	½	**	¾	½	.14
12	S1212	14½	1.000	1.167	B	½	**	¾	½	.16
13	S1213	14½	1.083	1.250	B	½	**	13/16	½	.20
14	S1214	14½	1.167	1.333	B	½	**	29/32	½	.24
15	S1215	14½	1.250	1.417	B	¾	**	1	½	.27
16	S1216	14½	1.333	1.500	B	¾	¾	1 1/16	½	.34
17	S1217	14½	1.417	1.580	B	¾	¾	1 1/8	½	.36
18	S1218	14½	1.500	1.667	B	¾	1 1/16	1 1/4	½	.42
19	S1219	14½	1.583	1.750	B	¾	¾	1 1/8	½	.48
20	S1220	14½	1.667	1.833	B	¾	1 1/16	1 3/16	½	.56
21	S1221	14½	1.750	1.917	B	¾	¾	1 1/2	½	.64
22	S1222	14½	1.833	2.000	B	¾	¾	1 5/8	½	.70
23	S1223	14½	1.917	2.083	B	¾	1 5/16	1 1/2	½	.78
24	S1224	14½	2.000	2.166	B	¾	1	1 3/4	½	.88
25	S1225	14½	2.083	2.250	B	¾	1 1/16	1 7/8	½	.96
26	S1226	14½	2.167	2.333	B	¾	1 1/8	1 5/8	5/8	1.14
28	S1228	14½	2.333	2.500	B	¾	1 1/2	2 1/8	5/8	1.34
30	S1230	14½	2.500	2.667	B	¾	1 5/16	2 1/4	5/8	1.60
32	S1232	14½	2.667	2.833	B	¾	1 5/8	2 1/2	5/8	1.72
34	S1234	14½	2.833	3.000	B	¾	1 5/16	2 1/2	5/8	1.88
36	S1236	14½	3.000	3.167	B	¾	1 1/2	2 3/4	5/8	2.20
38	S1238	14½	3.167	3.333	B	¾	1 1/2	2 3/4	5/8	2.38
40	S1240	14½	3.333	3.500	B	¾	1 1/2	2 3/4	5/8	2.54
42	S1242	14½	3.500	3.666	B	¾	1 1/2	2 3/4	5/8	2.72
44	S1244	14½	3.667	3.833	B	¾	1 1/2	2 3/4	5/8	2.94
48	S1248	14½	4.000	4.166	B	¾	1 1/2	2 3/4	3/4	3.50
54	S1254	14½	4.500	4.666	B	¾	1 3/4	2 3/4	3/4	4.40
56	S1256	14½	4.667	4.833	B	¾	1 3/4	2 3/4	3/4	4.60
60	S1260	14½	5.000	5.166	B	¾	1 3/4	2 3/4	3/4	5.14
64	S1264	14½	5.333	5.500	B	¾	1 3/4	2 3/4	3/4	5.74
66	S1266	14½	5.500	5.666	B	¾	1 3/4	2 3/4	3/4	6.02
72	S1272	14½	6.000	6.166	B	¾	1 3/4	2 3/4	3/4	7.02

* Recommended maximum bore with keyway and set screw.

** Check application with factory.

† Enlarged pitch diameter with special tooth form.

14½° P.A. Gears Will Not Operate With 20° P.A.

Martin

Cast Iron Stock Spur Gears

14½° Pressure Angle

12 DP

¾" Face

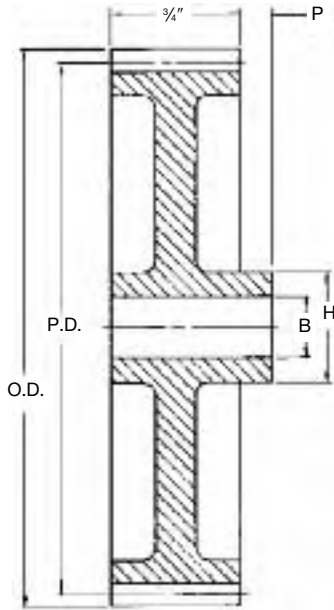

Type B₁, B₃



Type B₃
Web With Spokes



Type B₁
Web

Cast — Style “B”

No. Teeth	Catalog Number	Pressure Angle (Deg.)	Diameter		Type	Bore (Inches)		Hub (Inches)		Weight Lbs. (App.)
			Pitch	Outside		Stock	Max.*	Diameter	Proj.	
78	C1278	14½	6.500	6.666	B ₃	¾	1⅞	2½	¾	4.1
84	C1284	14½	7.000	7.166	B ₃	¾	1⅞	2½	¾	4.4
90	C1290	14½	7.500	7.666	B ₃	¾	1⅞	2½	¾	5.2
96	C1296	14½	8.000	8.166	B ₃	¾	1⅞	2½	¾	5.5
102	C12102	14½	8.500	8.666	B ₃	¾	1⅞	2½	¾	5.9
108	C12108	14½	9.000	9.166	B ₃	¾	1⅞	2½	¾	6.4
112	C12112	14½	9.333	9.500	B ₃	¾	1⅞	2½	¾	6.4
114	C12114	14½	9.500	9.666	B ₃	¾	1⅞	2½	¾	6.4
120	C12120	14½	10.000	10.166	B ₃	¾	1⅞	2½	¾	8.1
126	C12126	14½	10.500	10.666	B ₃	¾	1⅞	3	¾	7.4
144	C12144	14½	12.000	12.166	B ₃	¾	1⅞	3	1	10.1
168	C12168	14½	14.000	14.166	B ₁	¾	1⅞	3	1	10.6

* Recommended maximum bore with keyway and set screw.

14½° P.A. Gears Will Not Operate With 20° P.A.

Bored-to-Size

No. Teeth	Catalog Number	Pressure Angle (Deg.)	Diameter		Type	Bore (Inches)		Set Screw	Hub (Inches)		Weight Lbs. (App.)
			Pitch	Outside		Stock	Keyway		Diameter	Proj.	
11	S1211BS 1/2	14½	1.000	1.167	B	½	NONE	(1) 10-24	¾	½	0.14
12	S1212BS 1/2	14½	1.000	1.167	B	½	NONE	(1) 10-24	¾	½	0.16
13	S1213BS 1/2	14½	1.083	1.250	B	½	NONE	(1) 10-24	1⅞	½	0.20
14	S1214BS 1/2	14½	1.167	1.333	B	½	NONE	(1) 10-24	2⅞	¾	0.24
15	S1215BS 5/8	14½	1.250	1.417	B	¾	¾ X ⅜	(1) 10-24 @ 90	1	½	0.27
16	S1216BS 5/8	14½	1.333	1.500	B	¾	¾ X ⅜	(1) 1/4-20 @ 90	1⅞	½	0.34
18	S1218BS 5/8	14½	1.500	1.667	B	¾	¾ X ⅜	(1) 1/4-20 @ 90	1¼	½	0.42
20	S1220BS 5/8	14½	1.667	1.833	B	¾	¾ X ⅜	(1) 1/4-20 @ 90	1⅞	½	0.56
20	S1220BS 3/4	14½	1.667	1.833	B	¾	¾ X ⅜	(1) 1/4-20 @ 90	1⅞	½	0.56
21	S1221BS 5/8	14½	1.750	1.917	B	¾	¾ X ⅜	(1) 1/4-20 @ 90	1⅞	½	0.56
21	S1221BS 3/4	14½	1.750	1.917	B	¾	¾ X ⅜	(1) 1/4-20 @ 90	1⅞	½	0.56
21	S1221BS 7/8	14½	1.750	1.917	B	¾	¾ X ⅜	(1) 1/4-20 @ 90	1⅞	½	0.56
22	S1222BS 5/8	14½	1.833	2.000	B	¾	¾ X ⅜	(1) 1/4-20 @ 90	1⅞	½	0.70
22	S1222BS 3/4	14½	1.833	2.000	B	¾	¾ X ⅜	(1) 1/4-20 @ 90	1⅞	½	0.70
22	S1222BS 7/8	14½	1.833	2.000	B	¾	¾ X ⅜	(1) 1/4-20 @ 90	1⅞	½	0.70
22	S1222BS 1	14½	1.833	2.000	B	1	¾ X ½	(1) 5/16-18 @ 90	1⅞	½	0.70
24	S1224BS 5/8	14½	2.000	2.167	B	¾	¾ X ⅜	(1) 1/4-20 @ 90	1¼	½	0.88
24	S1224BS 3/4	14½	2.000	2.167	B	¾	¾ X ⅜	(1) 1/4-20 @ 90	1¼	½	0.88
24	S1224BS 7/8	14½	2.000	2.167	B	¾	¾ X ⅜	(1) 1/4-20 @ 90	1¼	½	0.88
24	S1224BS 1	14½	2.000	2.167	B	1	¾ X ½	(1) 5/16-18 @ 90	1¼	½	0.88

16 DP

1/2" Face

Steel Stock Spur Gears

14½° Pressure Angle

Martin

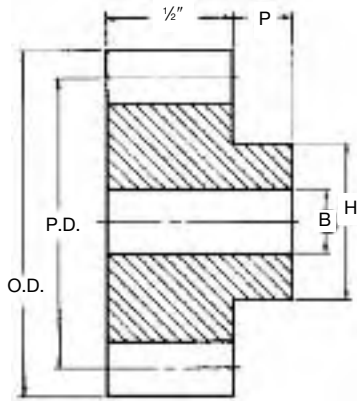

Type B



Type B
Plain With Hub

Steel

No. Teeth	Catalog Number	Pressure Angle (Deg.)	Diameter		Type	Bore (Inches)		Hub (Inches)		Weight Lbs. (App.)
			Pitch	Outside		Stock	Max. *	Diameter	Proj.	
11	S1611	14½	.750†	.875	B	¾	**	⅜	⅜	0.06
12	S1612	14½	.750	.875	B	¾	**	⅜	⅜	0.06
13	S1613	14½	.812	.937	B	¾	**	⅜	⅜	0.08
14	S1614	14½	.875	1.000	B	¾	**	⅜	⅜	0.08
15	S1615	14½	.937	1.062	B	½	**	¾	⅜	0.10
16	S1616	14½	1.000	1.125	B	½	**	⅞	⅜	0.12
17	S1617	14½	1.062	1.187	B	½	**	¾	⅜	0.14
18	S1618	14½	1.125	1.250	B	½	**	⅞	⅜	0.16
19	S1619	14½	1.187	1.312	B	½	½	1	⅜	0.20
20	S1620	14½	1.250	1.375	B	½	⅝	1⅜	⅜	0.22
21	S1621	14½	1.312	1.438	B	½	¾	1½	⅜	0.24
22	S1622	14½	1.375	1.500	B	½	¾	1⅜	⅜	0.28
23	S1623	14½	1.437	1.562	B	½	⅞	1½	⅜	0.32
24	S1624	14½	1.500	1.625	B	½	¾	1⅞	⅜	0.34
26	S1626	14½	1.625	1.750	B	½	¾	1⅞	⅜	0.42
28	S1628	14½	1.750	1.875	B	½	¾	1½	½	0.52
30	S1630	14½	1.875	2.000	B	½	⅞	1½	½	0.60
32	S1632	14½	2.000	2.125	B	½	1	1½	½	0.70
34	S1634	14½	2.125	2.250	B	½	1½	1½	½	0.80
36	S1636	14½	2.250	2.375	B	½	1½	2	½	0.92
38	S1638	14½	2.375	2.500	B	½	1½	2	½	0.98
40	S1640	14½	2.500	2.626	B	½	1½	2	½	1.1
44	S1644	14½	2.750	2.875	B	½	1½	2	½	1.2
48	S1648	14½	3.000	3.125	B	½	1½	2	½	1.4
52	S1652	14½	3.250	3.375	B	½	1½	2	½	1.5
54	S1654	14½	3.375	3.500	B	½	1½	2	½	1.6
56	S1656	14½	3.500	3.625	B	½	1½	2	½	1.7
60	S1660	14½	3.750	3.875	B	½	1½	2	½	1.3
64	S1664	14½	4.000	4.125	B	¾	1½	2	¾	2.2
68	S1668	14½	4.250	4.375	B	¾	1⅞	2¼	¾	2.5
72	S1672	14½	4.500	4.625	B	¾	1⅞	2¼	¾	2.8
80	S1680	14½	5.000	5.125	B	¾	1⅞	2¼	¾	3.4
84	S1684	14½	5.250	5.375	B	¾	1⅞	2¼	¾	3.6
88	S1688	14½	5.500	5.625	B	¾	1⅞	2¼	¾	3.9
96	S1696	14½	6.000	6.125	B	¾	1⅞	2¼	¾	4.6
104	S16104	14½	6.500	6.625	B	¾	1⅞	2¼	¾	5.2

* Recommended maximum bore with keyway and set screw.

** Check application with factory.

† Enlarged pitch diameter with special tooth form.

14½° P.A. Gears Will Not Operate With 20° P.A.

Martin

Cast Iron Stock Spur Gears

14½° Pressure Angle

16 DP

1½" Face

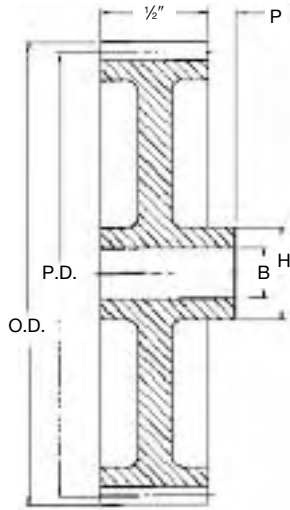

Type B₁, B₃



Type B₃
Web With Spokes



Type B₁
Web

Cast — Style "B"

No. Teeth	Catalog Number	Pressure Angle (Deg.)	Diameter		Type	Bore (Inches)		Hub (Inches)		Weight Lbs. (App.)
			Pitch	Outside		Stock	Max.*	Diameter	Proj.	
112	C16112	14½	7.000	7.125	B ₃	¾	1⅞	2½	¾	3.4
120	C16120	14½	7.500	7.625	B ₃	¾	1⅞	2½	¾	3.5
128	C16128	14½	8.000	8.125	B ₃	¾	1⅞	2½	¾	3.7
144	C16144	14½	9.000	9.125	B ₃	¾	1⅞	2½	¾	5.0
160	C16160	14½	10.000	10.125	B ₃	¾	1⅞	2½	¾	5.2
192	C16192	14½	12.000	12.125	B ₁	¾	1⅞	2½	¾	8.1

* Recommended maximum bore with keyway and set screw.

14½° P.A. Gears Will Not Operate With 20° P.A.

Bored-to-Size

No. Teeth	Catalog Number	Pressure Angle (Deg.)	Diameter		Type	Bore (Inches)		Set Screw	Hub (Inches)		Weight Lbs. (App.)
			Pitch	Outside		Stock	Keyway		Diameter	Proj.	
11	S1611BS 3/8	14½	0.750	0.875	B	¾	None	(1) 8-32	⅞	⅞	0.06
12	S1612BS 3/8	14½	0.752	0.875	B	¾	None	(1) 8-32	⅞	⅞	0.06
13	S1613BS 3/8	14½	0.812	0.937	B	¾	None	(1) 8-32	⅞	⅞	0.08
14	S1614BS 3/8	14½	0.875	1.000	B	¾	None	(1) 10-24	1⅞	⅞	0.08
15	S1615BS 1/2	14½	0.937	1.062	B	½	None	(1) 10-24	¾	⅞	0.10
16	S1616BS 1/2	14½	1.000	1.125	B	½	None	(1) 10-24	1⅞	⅞	0.12
18	S1618BS 1/2	14½	1.125	1.250	B	½	None	(1) 1/4-20	1⅞	⅞	0.16
20	S1620BS 1/2	14½	1.250	1.375	B	½	None	(1) 1/4-20	1⅞	⅞	0.22
20	S1620BS 5/8	14½	1.250	1.375	B	¾	¾ X ⅜	(1) 1/4-20 @ 90	1⅞	⅞	0.22
22	S1622BS 1/2	14½	1.375	1.500	B	½	None	(1) 1/4-20	1⅞	⅞	0.28
22	S1622BS 5/8	14½	1.375	1.500	B	¾	¾ X ⅜	(1) 1/4-20 @ 90	1⅞	⅞	0.28
24	S1624BS 1/2	14½	1.500	1.625	B	½	None	(1) 1/4-20	1⅞	⅞	0.34
24	S1624BS 5/8	14½	1.500	1.625	B	¾	¾ X ⅜	(1) 1/4-20 @ 90	1⅞	⅞	0.34
24	S1624BS 3/4	14½	1.500	1.625	B	¾	¾ X ⅜	(1) 1/4-20 @ 90	1⅞	⅞	0.34
26	S1626BS 1/2	14½	1.625	1.750	B	½	None	(1) 1/4-20	1⅞	⅞	0.42
26	S1626BS 5/8	14½	1.625	1.750	B	¾	¾ X ⅜	(1) 1/4-20 @ 90	1⅞	⅞	0.42
26	S1626BS 3/4	14½	1.625	1.750	B	¾	¾ X ⅜	(1) 1/4-20 @ 90	1⅞	⅞	0.42
28	S1628BS 1/2	14½	1.750	1.875	B	½	None	(1) 1/4-20	1⅞	⅞	0.52
28	S1628BS 5/8	14½	1.750	1.875	B	¾	¾ X ⅜	(1) 1/4-20 @ 90	1⅞	⅞	0.52
28	S1628BS 3/4	14½	1.750	1.875	B	¾	¾ X ⅜	(1) 1/4-20 @ 90	1⅞	⅞	0.52
28	S1628BS 7/8	14½	1.750	1.875	B	¾	¾ X ⅜	(1) 1/4-20 @ 90	1⅞	⅞	0.52
30	S1630BS 1/2	14½	1.875	2.000	B	½	None	(1) 1/4-20	1⅞	⅞	0.60
30	S1630BS 5/8	14½	1.875	2.000	B	¾	¾ X ⅜	(1) 1/4-20 @ 90	1⅞	⅞	0.60
30	S1630BS 3/4	14½	1.875	2.000	B	¾	¾ X ⅜	(1) 1/4-20 @ 90	1⅞	⅞	0.60
30	S1630BS 7/8	14½	1.875	2.000	B	¾	¾ X ⅜	(1) 1/4-20 @ 90	1⅞	⅞	0.60
30	S1630BS 1	14½	1.875	2.000	B	1	¼ X ⅞	(1) 5/16-18 @ 90	1⅞	⅞	0.60
32	S1632BS 1/2	14½	2.000	2.125	B	½	None	(1) 1/4-20	1⅞	⅞	0.70
32	S1632BS 5/8	14½	2.000	2.125	B	¾	¾ X ⅜	(1) 1/4-20 @ 90	1⅞	⅞	0.70
32	S1632BS 3/4	14½	2.000	2.125	B	¾	¾ X ⅜	(1) 1/4-20 @ 90	1⅞	⅞	0.70
32	S1632BS 7/8	14½	2.000	2.125	B	¾	¾ X ⅜	(1) 1/4-20 @ 90	1⅞	⅞	0.70
32	S1632BS 1	14½	2.000	2.125	B	1	¼ X ⅞	(1) 5/16-18 @ 90	1⅞	⅞	0.70

20 DP

3/8" Face

Steel Stock Spur Gears

14½° Pressure Angle

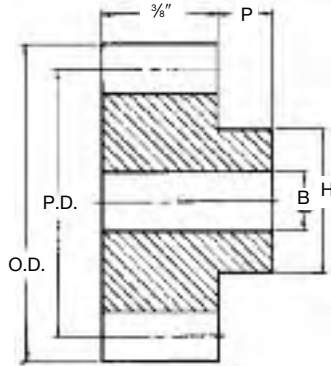

Type B



Type B
Plain With Hub

Steel

No. Teeth	Catalog Number	Pressure Angle (Deg.)	Diameter		Type	Bore (Inches)		Hub (Inches)		Weight Lbs. (App.)
			Pitch	Outside		Stock	Max. *	Diameter	Proj.	
11	S2011	14½	.600†	.700	B	3/16	**	1 1/2	3/8	.02
12	S2012	14½	.600	.700	B	3/16	**	1 1/2	3/8	.02
13	S2013	14½	.650	.750	B	3/16	**	1/2	3/8	.04
14	S2014	14½	.700	.800	B	3/16	**	3/4	3/8	.04
15	S2015	14½	.750	.850	B	3/8	**	3/4	3/8	.04
16	S2016	14½	.800	.900	B	3/8	**	1 1/2	3/8	.04
17	S2017	14½	.850	.950	B	3/8	**	4 5/64	3/8	.08
18	S2018	14½	.900	1.000	B	3/8	**	1/2	3/8	.08
19	S2019	14½	.950	1.050	B	3/8	**	5 1/64	3/8	.10
20	S2020	14½	1.000	1.100	B	3/8	**	5 5/64	3/8	.12
21	S2021	14½	1.050	1.150	B	3/8	**	7/8	3/8	.12
22	S2022	14½	1.100	1.200	B	3/8	**	3 1/32	3/8	.14
23	S2023	14½	1.150	1.250	B	3/8	**	3 1/2	3/8	.16
24	S2024	14½	1.200	1.300	B	3/8	1/16	1 1/16	3/8	.19
25	S2025	14½	1.250	1.350	B	3/8	1/8	1 1/4	3/8	.20
28	S2028	14½	1.400	1.500	B	3/8	1 1/16	1 1/4	3/8	.26
30	S2030	14½	1.500	1.600	B	3/8	3/16	1 3/4	3/8	.30
32	S2032	14½	1.600	1.700	B	3/8	7/8	1 1/16	1/2	.40
35	S2035	14½	1.750	1.850	B	3/8	7/8	1 1/8	1/2	.50
36	S2036	14½	1.800	1.900	B	3/8	3/8	1 1/8	1/2	.52
40	S2040	14½	2.000	2.100	B	3/8	1 1/16	1 13/16	1/2	.64
45	S2045	14½	2.250	2.350	B	3/8	1 1/4	2	1/2	.82
48	S2048	14½	2.400	2.500	B	3/8	1 1/4	2	1/2	.88
50	S2050	14½	2.500	2.600	B	3/8	1 1/4	2	1/2	.90
55	S2055	14½	2.750	2.850	B	3/8	1 1/4	2	1/2	1.04
60	S2060	14½	3.000	3.100	B	3/8	1 1/4	2	1/2	1.16
64	S2064	14½	3.200	3.300	B	3/8	1 1/4	2	1/2	1.26
70	S2070	14½	3.500	3.600	B	3/8	1 1/4	2	1/2	1.40
72	S2072	14½	3.600	3.700	B	3/8	1 1/16	2 1/4	1/2	1.60
75	S2075	14½	3.750	3.850	B	3/8	1 1/16	2 1/4	1/2	1.70
80	S2080	14½	4.000	4.100	B	1/2	1 1/16	2 1/4	1/2	1.82
84	S2084	14½	4.200	4.300	B	1/2	1 1/16	2 1/4	1/2	1.96
90	S2090	14½	4.500	4.600	B	1/2	1 1/16	2 1/4	1/2	2.20
96	S2096	14½	4.800	4.900	B	1/2	1 1/16	2 1/4	1/2	2.42
100	S20100	14½	5.000	5.100	B	1/2	1 1/16	2 1/4	1/2	2.60
112	S20112	14½	5.600	5.700	B	1/2	1	1 1/4	1/2	2.86
120	S20120	14½	6.000	6.100	B ₁	1/2	1	1 1/4	1/2	3.24
132	S20132	14½	6.600	6.700	B	1/2	1	1 1/4	1/2	3.80

* Recommended maximum bore with keyway and set screw.

** Check application with factory.

† Enlarged pitch diameter with special tooth form.

14½° P.A. Gears Will Not Operate With 20° P.A.

Martin

Cast Iron Stock Spur Gears

14½° Pressure Angle

20 DP

3/8" Face

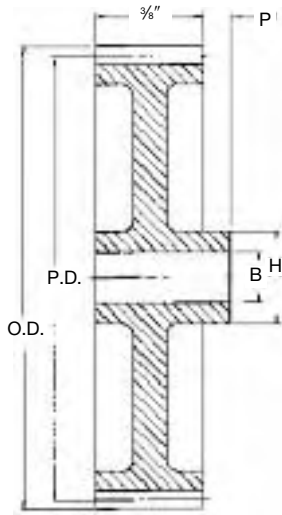

Type B₁, B₃



Type B₃
Web With Spokes



Type B₁
Web

Cast — Style "B"

No. Teeth	Catalog Number	Pressure Angle (Deg.)	Diameter		Type	Bore (Inches)		Hub (Inches)		Weight Lbs. (App.)
			Pitch	Outside		Stock	Max.*	Diameter	Proj.	
•48	C2048	14½	2.400	2.500	B ₁	¾	¾	1½	½	.50
•64	C2064	14½	3.200	3.300	B ₁	¾	¾	1½	½	.68
140	C20140	14½	7.000	7.100	B ₁	½	1	1¼	½	2.00
160	C20160	14½	8.000	8.100	B ₁	½	1	1¼	¾	2.34
180	C20180	14½	9.000	9.100	B ₁	½	1	1¼	¾	2.66
200	C20200	14½	10.000	10.100	B ₁	½	1	1¼	¾	2.84

* Recommended maximum bore with keyway and set screw.
• Consult Factory.

14½° P.A. Gears Will Not Operate With 20° P.A.

Bored-to-Size

No. Teeth	Catalog Number	Pressure Angle (Deg.)	Diameter		Type	Bore (Inches)		Set Screw	Hub (Inches)		Weight Lbs. (App.)
			Pitch	Outside		Stock	Keyway		Diameter	Proj.	
11	S2011BS 5/16	14½	0.600	0.700	B	5/16	None	#35 P.H.	15/32	¾	0.02
12	S2012BS 5/16	14½	0.600	0.700	B	5/16	None	#35 P.H.	15/32	¾	0.02
13	S2013BS 5/16	14½	0.650	0.750	B	5/16	None	#35 P.H.	½	¾	0.04
14	S2014BS 5/16	14½	0.700	0.800	B	5/16	None	#35 P.H.	35/64	¾	0.04
15	S2015BS 3/8	14½	0.750	0.850	B	¾	None	(1) 8-32	39/64	¾	0.04
16	S2016BS 3/8	14½	1.800	0.900	B	¾	None	(1) 8-32	21/32	¾	0.04
18	S2018BS 3/8	14½	1.900	1.000	B	¾	None	(1) 10-24	¾	¾	0.08
20	S2020BS 3/8	14½	1.000	1.100	B	¾	None	(1) 10-24	55/64	¾	0.12
20	S2020BS 1/2	14½	1.000	1.100	B	½	None	(1) 10-24	55/64	¾	0.12
22	S2022BS 3/8	14½	1.100	1.200	B	¾	None	(1) 1/4-20	31/32	¾	0.14
22	S2022BS 1/2	14½	1.100	1.200	B	½	None	(1) 1/4-20	31/32	¾	0.14
24	S2024BS 3/8	14½	1.200	1.300	B	¾	None	(1) 1/4-20	11/16	¾	0.19
24	S2024BS 1/2	14½	1.200	1.300	B	½	None	(1) 1/4-20	11/16	¾	0.19
25	S2025BS 3/8	14½	1.250	1.350	B	¾	None	(1) 1/4-20	11/16	¾	0.20
25	S2025BS 1/2	14½	1.250	1.350	B	½	None	(1) 1/4-20	11/16	¾	0.20
28	S2028BS 3/8	14½	1.400	1.500	B	¾	None	(1) 1/4-20	117/64	¾	0.26
28	S2028BS 1/2	14½	1.400	1.500	B	½	None	(1) 1/4-20	117/64	¾	0.26
30	S2030BS 3/8	14½	1.500	1.600	B	¾	None	(1) 1/4-20	123/64	¾	0.30
30	S2030BS 1/2	14½	1.500	1.600	B	½	None	(1) 1/4-20	123/64	¾	0.30
32	S2032BS 3/8	14½	1.600	1.700	B	¾	None	(1) 1/4-20	11/16	¾	0.40
32	S2032BS 1/2	14½	1.600	1.700	B	½	None	(1) 1/4-20	11/16	¾	0.40
35	S2035BS 3/8	14½	1.750	1.850	B	¾	None	(1) 1/4-20	11/16	¾	0.50
35	S2035BS 1/2	14½	1.750	1.850	B	½	None	(1) 1/4-20	11/16	¾	0.50
36	S2036BS 3/8	14½	1.800	1.900	B	¾	None	(1) 1/4-20	11/16	¾	0.52
36	S2036BS 1/2	14½	1.800	1.900	B	½	None	(1) 1/4-20	11/16	¾	0.52
40	S2040BS 3/8	14½	2.000	2.100	B	¾	None	(1) 1/4-20	119/64	¾	0.64
40	S2040BS 1/2	14½	2.000	2.100	B	½	None	(1) 1/4-20	119/64	¾	0.64
40	S2040BS 5/8	14½	2.000	2.100	B	¾	5/16 X 3/32	(1) 1/4-20 @ 90	119/64	¾	0.64
40	S2040BS 3/4	14½	2.000	2.100	B	¾	5/16 X 3/32	(1) 1/4-20 @ 90	119/64	¾	0.64

24 DP

1/4" Face

Steel Stock Spur Gears

14½° Pressure Angle

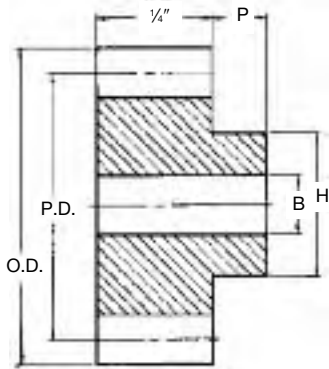

Type B



Type B
Plain With Hub

Steel

No. Teeth	Catalog Number	Pressure Angle (Deg.)	Diameter		Type	Bore (Inches)		Hub (Inches)		Weight Lbs. (App.)
			Pitch	Outside		Stock	Max. *	Diameter	Proj.	
11	S2411	14½	.500†	.583	B	¼	**	¾	⅜	.02
12	S2412	14½	.500	.583	B	¼	**	¾	⅜	.02
14	S2414	14½	.583	.666	B	¼	**	1½	⅜	.04
15	S2415	14½	.625	.708	B	¼	**	½	⅜	.04
16	S2416	14½	.666	.750	B	⅜	**	¾	⅜	.04
17	S2417	14½	.709	.791	B	⅜	**	¾	⅜	.04
18	S2418	14½	.750	.833	B	⅜	**	¾	⅜	.04
19	S2419	14½	.791	.875	B	⅜	**	¾	⅜	.06
20	S2420	14½	.833	.917	B	⅜	**	2½	⅜	.06
21	S2421	14½	.875	.959	B	¾	**	¾	⅜	.06
22	S2422	14½	.917	1.000	B	¾	**	¾	⅜	.06
24	S2424	14½	1.000	1.083	B	¾	**	¾	⅜	.10
26	S2426	14½	1.083	1.166	B	¾	**	¾	⅜	.10
27	S2427	14½	1.125	1.208	B	¾	**	¾	⅜	.12
30	S2430	14½	1.250	1.333	B	¾	½	1	⅜	.16
33	S2433	14½	1.375	1.458	B	¾	⅝	1½	⅜	.20
36	S2436	14½	1.500	1.583	B	¾	¾	1½	⅜	.20
40	S2440	14½	1.666	1.750	B	¾	¾	1½	⅜	.24
42	S2442	14½	1.750	1.833	B	¾	⅞	1½	⅜	.28
44	S2444	14½	1.833	1.917	B	¾	1¼	1½	⅜	.30
45	S2445	14½	1.875	1.959	B	¾	1¼	1½	⅜	.30
48	S2448	14½	2.000	2.083	B	¾	1¼	1½	⅜	.32
54	S2454	14½	2.250	2.333	B	¾	1¼	1½	⅜	.38
56	S2456	14½	2.333	2.416	B	¾	1¼	1½	⅜	.40
60	S2460	14½	2.500	2.583	B	¾	1½	1½	⅜	.46
66	S2466	14½	2.750	2.833	B	¾	1½	1½	⅜	.52
72	S2472	14½	3.000	3.083	B	½	1½	1½	½	.64
84	S2484	14½	3.500	3.583	B	½	¾	1½	½	.88
96	S2496	14½	4.000	4.083	B	½	¾	1½	½	1.08
120	S24120	14½	5.000	5.083	B	½	¾	1½	½	2.60
144	S24144	14½	6.000	6.083	B	½	1½	1½	1½	2.28

* Recommended maximum bore with keyway and set screw.
 ** Check application with factory.
 † Enlarged pitch diameter with special tooth form.

14½° P.A. Gears Will Not Operate With 20° P.A.

GEARS



14 1/2° Spur Gear Horsepower Ratings

(S) = Steel

(CI) = Cast Iron

3 D.P. 3" Face

Number Teeth	12		15		18		21		24		48		72		96		120	
	S	CI	S	CI	S	CI	S	CI	S	CI	S	CI	S	CI	S	CI	S	CI
50	6		9		12		13		16	10	33	20	45	27	55	33	63	38
100	11		16		21		25		29	17	52	31	67	41	76	47	86	52
200	20		27		35		40		45	27	73	45	89	54	96	59	105	63
300	26		35		44		50		56	33	85	52	99	60	106	65	113	69
500	35		46		57		64		70	41	98	60	110	66	115	70	121	73
600	39		51		61		68		74	44	102	62	113	68	117	71	123	74
900	46		59		70		77		83	49	109	66	118	72	121	74	126	77
1200	51		64		76		83		89	53	112	68	121	73	124	75	128	78
1800	58		71		82		89		95	56	117	71	124	76	126	77	130	79

4 D.P. 2" Face

Number Teeth	12		16		20		24		48		72		96		144		S	CI
	S	CI	S	CI	S	CI	S	CI	S	CI	S	CI	S	CI				
50	2		4		5		6	4	13	8	18	11	23	14	30	18		
100	4		7		9		11	7	22	13	29	17	34	21	42	25		
200	8		12		16		19	11	32	20	40	24	35	27	52	31		
300	11		16		20		24	14	38	23	46	28	51	31	56	34		
500	15		22		27		31	19	45	28	52	32	56	34	60	36		
600	17		24		29		33	20	57	29	54	33	58	35	61	37		
900	20		29		34		38	23	52	31	57	35	60	36	64	38		
1200	23		32		37		41	25	54	33	59	36	62	37	65	39		
1800	27		36		41		45	27	57	34	61	37	63	38	66	41		

5 D.P. 1 3/4" Face

Number Teeth	12		18		24		30		45		80		120		160		S	CI
	S	CI	S	CI	S	CI	S	CI	S	CI	S	CI	S	CI				
50	1		2		4	2	5	3	8	4	12	7	16	10		12		
100	2		4		7	4	9	5	12	7	19	12	24	15		17		
200	4		8		11	7	14	8	19	11	27	16	32	19		21		
300	6		11		15	9	18	11	23	14	31	19	36	22		23		
500	9		14		20	12	23	14	29	17	36	22	40	24		25		
600	10		16		22	13	25	15	30	20	37	23	41	25		26		
900	12		20		25	15	29	17	34	21	40	24	43	26		27		
1200	14		22		28	17	31	19	36	25	41	25	44	27		27		
1800	16		25		30	18	42	25	38	26	43	26	45	28		28		

14¹/₂^o Spur Gear Horsepower Ratings



(S) = Steel

(CI) = Cast Iron

6 D.P. 1¹/₂" Face

Number Teeth	12		18		24		30		36		48		84		120		180		
	S	CI	S	CI	S	CI	S	CI	S	CI	S	CI	S	CI	S	CI	S	CI	
100	2		3		4	2	5	3	6	4	8	5	13	8	16	10			12
200	3		5		7	4	9	5	10	6	13	8	18	11	21	13			15
300	4		7		10	5	11	7	13	7	16	10	21	13	24	15			16
600	7		11		13	8	17	10	18	11	21	13	26	16	28	17			18
900	8		13		17	9	19	11	21	13	24	14	28	17	30	18			19
1200	10		15		19	10	21	13	22	14	25	15	29	18	31	19			19
1800	12		18		21	11	23	14	24	15	27	16	30	19	32	19			20

8 D.P. 1¹/₄" Face

RPM	Steel				Cast Iron					
	Number of Teeth				Number of Teeth					
	12	24	36	48	24	48	72	96	120	160
100	.72	1.98	3.02	4.08	1.18	2.50	3.47	4.40	5.05	6.02
200	1.37	3.59	5.13	6.76	2.13	4.14	5.45	6.49	7.22	8.21
300	1.95	4.81	6.73	8.58	2.86	5.26	6.67	7.75	8.48	9.35
600	3.32	7.55	9.85	11.91	4.48	7.29	8.72	9.63	10.31	10.83
900	4.36	9.25	11.66	13.73	5.49	8.41	9.33	10.41	10.87	11.44
1200	5.21	10.48	12.86	15.10	6.22	9.07	9.86	10.88	11.29	11.76
1800	6.38	12.08	14.27	16.41	7.17	9.86	10.45	11.37	11.78	12.11

10 D.P. 1" Face

RPM	Steel				Cast Iron				
	Number of Teeth				Number of Teeth				
	12	24	48	60	28	72	140	180	200
100	.38	1.08	2.26	2.68	.80	1.88	3.12	3.63	3.88
200	.75	1.98	3.77	4.45	1.44	3.02	4.52	5.04	5.29
300	1.08	2.71	4.94	5.65	1.94	3.80	5.33	5.81	6.02
600	1.88	4.33	7.13	7.84	3.03	5.16	6.38	6.83	6.99
900	2.50	5.41	8.23	9.04	3.71	5.81	6.96	7.24	7.36
1200	3.00	6.25	9.06	9.74	4.21	6.25	7.23	7.46	7.59
1800	3.75	7.21	9.95	10.59	4.85	6.78	7.55	7.74	7.86

GEARS



14 1/2° Spur Gear Horsepower Ratings

12 D.P. 3/4" Face

RPM	Steel					Cast Iron			
	Number of Teeth					Number of Teeth			
	12	24	48	60	72	36	72	120	200
100	.21	.56	1.16	1.46	1.71	.53	1.04	1.54	2.19
200	.39	1.05	2.02	2.44	2.84	.95	1.72	2.37	3.08
300	.55	1.43	2.70	3.19	3.60	1.28	2.18	2.90	3.56
600	.99	2.37	3.99	4.61	5.00	2.01	3.03	3.68	4.21
900	1.33	3.01	4.76	5.32	5.76	2.46	3.49	4.07	4.50
1200	1.64	3.50	5.28	5.85	6.21	2.79	3.77	4.18	4.65
1800	2.09	4.17	5.92	6.42	6.75	3.21	4.09	4.41	4.85

16 D.P. 1/2" Face

RPM	Steel					Cast Iron				
	Number of Teeth					Number of Teeth				
	12	24	36	48	80	36	80	120	160	200
100	.08	.21	.32	.45	.76	.14	.45	.63	.78	.93
200	.14	.39	.60	.82	1.26	.27	.75	1.00	1.21	1.34
300	.21	.56	.82	1.10	1.65	.37	.99	1.25	1.48	1.60
600	.40	.96	1.35	1.72	2.38	.60	1.43	1.68	1.78	1.92
900	.53	1.26	1.71	2.11	2.75	.68	1.64	1.88	1.87	1.99
1200	.66	1.50	1.97	2.39	3.02	.87	1.81	2.03	2.17	2.24
1800	.87	1.84	2.33	2.75	3.32	1.03	1.99	2.16	2.29	2.36

20 D.P. 3/8" Face

RPM	Steel					Cast Iron				
	Number of Teeth					Number of Teeth				
	12	24	48	60	96	48	80	120	160	200
100	.05	.11	.22	.28	.46	.14	.22	.32	.40	.47
200	.07	.20	.43	.50	.76	.26	.39	.53	.64	.73
300	.10	.29	.58	.67	.99	.35	.52	.66	.79	.89
600	.19	.51	.93	1.06	1.44	.56	.76	.92	1.05	1.08
900	.27	.68	1.16	1.29	1.66	.70	.91	1.06	1.16	1.14
1200	.33	.81	1.34	1.47	1.70	.81	1.01	1.14	1.25	1.32
1800	.46	1.02	1.55	1.69	2.00	.94	1.13	1.26	1.33	1.39

24 D.P. 1/4" Face

RPM	Steel				
	Number of Teeth				
	12	24	48	60	144
100	.017	.047	.105	.200	.291
200	.033	.091	.197	.349	.482
300	.049	.132	.275	.462	.617
600	.092	.236	.455	.688	.857
900	.131	.321	.583	.822	.984
1200	.165	.391	.679	.910	1.063

4 DP 3 1/2" Face

Steel Stock Spur Gears 20° Pressure Angle



Type B
Plain With Hub
All Steel



Type B₁
Web
All Steel



Type B₂
Web With
Lighten Holes
All Steel

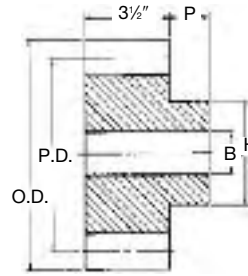

Type B

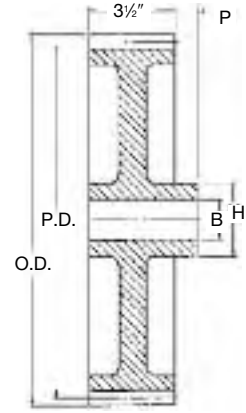

Type B₁, B₂

Steel

No. Teeth	Catalog Number	Pressure Angle (Deg.)	Diameter		Type	Bore (Inches)		Hub (Inches)		Weight Lbs. (App.)
			Pitch	Outside		Stock	Max. *	Diameter	Proj.	
12	TS412	20	3.000	3.500	B	1 1/4	1 1/16	2 7/16	7/16	6.8
14	TS414	20	3.500	4.000	B	1 1/4	1 3/8	2 9/16	7/16	9.8
15	TS415	20	3.750	4.250	B	1 1/4	1 7/8	3 1/16	7/16	11.5
16	TS416	20	4.000	4.500	B	1 1/4	2 1/8	3 3/16	7/16	13.3
18	TS418	20	4.500	5.000	B	1 1/4	2 3/8	3 5/16	7/16	17.3
20	TS420	20	5.000	5.500	B	1 1/4	2 7/8	4 1/16	7/16	21.8
22	TS422	20	5.500	6.000	B	1 1/4	3	4 3/16	7/16	26.7
24	TS424	20	6.000	6.500	B	1 1/4	3 1/8	5	1 1/4	33.7
28	TS428	20	7.000	7.500	B	1 1/4	3 3/8	5	1 1/2	43.8
30	TS430	20	7.500	8.000	B	1 1/4	3 7/8	5	1 1/2	49.4
32	TS432	20	8.000	8.500	B	1 1/4	3 7/8	5	1 1/2	56.8
36	TS436	20	9.000	9.500	B	1 1/4	3 7/8	5	1 1/2	70.0
40	TS440	20	10.000	10.500	B	1 1/4	3 7/8	5 1/2	1 1/2	85.2
44	TS444	20	11.000	11.500	B	1 1/4	3 7/8	5 1/2	1 1/2	101.6
48	TS448	20	12.000	12.500	B	1 1/4	3 7/8	5 1/2	1 1/2	119.5
56	TS456	20	14.000	14.500	B ₁	1 1/4	3 7/8	5 1/2	1 1/2	96.9
60	TS460	20	15.000	15.500	B ₂	1 1/4	3 7/8	5 1/2	1 1/2	88.1
64	TS464	20	16.000	16.500	B ₂	1 1/4	3 7/8	5 1/2	1 1/2	86.9
72	TS472	20	18.000	18.500	B ₂	1 1/4	3 7/8	5 1/2	1 1/2	86.5
80	TS480	20	20.000	20.500	B ₂	1 1/4	3 7/8	5 1/2	1 1/2	90.9

* Recommended maximum bore with keyway and set screw.

20° P.A. Gears Will Not Operate With 14 1/2° P.A.

Martin

Steel Stock Spur Gears 20° Pressure Angle

5 DP 2 1/2" Face

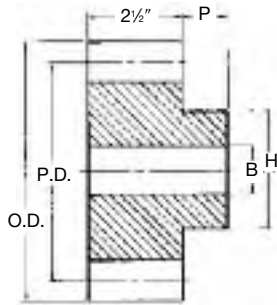

Type B

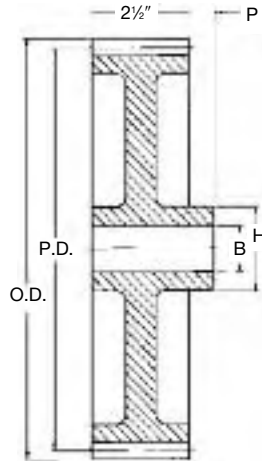

Type B₂



Type B
Plain With Hub
All Steel



Type B₂
Web With Lighten Holes
All Steel

Steel

No. Teeth	Catalog Number	Pressure Angle (Deg.)	Diameter		Type	Bore (Inches)		Hub (Inches)		Weight Lbs. (App.)
			Pitch	Outside		Stock	Max. *	Diameter	Proj.	
12	TS512	20	2.400	2.800	B	1 1/8	1 1/8	1 3/16	3/8	2.9
14	TS514	20	2.800	3.200	B	1 1/8	1 1/8	2 3/16	3/8	4.3
15	TS515	20	3.000	3.400	B	1 1/8	1 1/8	2 3/8	3/8	5.2
16	TS516	20	3.200	3.600	B	1 1/8	1 1/8	2 7/16	3/8	6.1
18	TS518	20	3.600	4.000	B	1 1/8	1 1/8	3	3/8	8.0
20	TS520	20	4.000	4.400	B	1 1/8	2 1/4	3 3/8	3/8	10.2
24	TS524	20	4.800	5.200	B	1 1/8	2 3/8	3 3/4	1 1/8	15.7
25	TS525	20	5.000	5.400	B	1 1/8	2 3/8	3 3/4	1 1/8	20.3
28	TS528	20	5.600	6.000	B	1 1/8	2 3/8	3 3/4	1 1/8	22.9
30	TS530	20	6.000	6.400	B	1 1/8	2 3/8	3 3/4	1 1/8	23.9
35	TS535	20	7.000	7.400	B	1 1/8	2 3/8	3 3/4	1 1/8	29.9
40	TS540	20	8.000	8.400	B	1 1/8	2 3/8	3 3/4	1 1/8	38.2
45	TS545	20	9.000	9.400	B	1 1/8	2 3/8	3 3/4	1 1/8	47.7
50	TS550	20	10.000	10.400	B	1 1/8	2 3/8	4 1/8	1 1/8	60.3
60	TS560	20	12.000	12.400	B	1 1/8	2 3/8	4 1/8	1 1/8	84.7
70	TS570	20	14.000	14.400	B ₂	1 3/16	3 1/8	5 1/8	1 1/8	51.6
80	TS580	20	16.000	16.400	B ₂	1 3/16	3 1/8	5 1/8	1 1/8	55.8
90	TS590	20	18.000	18.400	B ₂	1 3/16	3 1/8	5 1/8	1 1/8	59.7
100	TS5100	20	20.000	20.400	B ₂	1 3/16	3 1/8	5 1/8	1 1/2	69.2
110	TS5110	20	22.000	22.400	B ₂	1 3/16	3 1/8	5 1/8	1 1/2	72.3
120	TS5120	20	24.000	24.400	B ₂	1 3/16	3 1/2	6 1/8	1 1/2	80.2

* Recommended maximum bore with keyway and set screw.

20° P.A. Gears Will Not Operate With 14 1/2° P.A.

GEARS

6 DP 2" Face

Steel Stock Spur Gears 20° Pressure Angle

Martin



Type B
Plain With Hub
All Steel



Type B₂
Web With Lighten Holes
All Steel

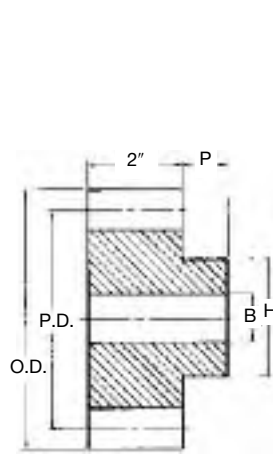

Type B

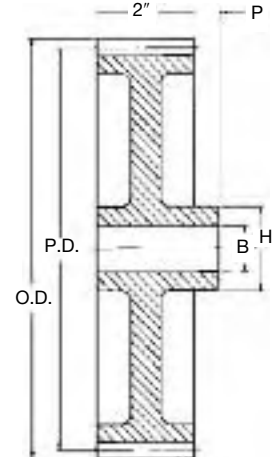

Type B₂

Steel

No. Teeth	Catalog Number	Pressure Angle (Deg.)	Diameter		Type	Bore (Inches)		Hub (Inches)		Weight Lbs. (App.)
			Pitch	Outside		Stock	Max.*	Diameter	Proj.	
11	TS611†	20	2.000	2.333	B	1	1	1½	¾	1.6
12	TS612	20	2.000	2.333	B	1	1	1½	¾	1.6
14	TS614	20	2.333	2.666	B	1	1	1⅞	¾	2.4
15	TS615	20	2.500	2.833	B	1	1¼	2	¾	2.9
16	TS616	20	2.666	3.000	B	1	1⅙	2½	¾	3.4
18	TS618	20	3.000	3.333	B	1	1½	2½	¾	4.6
21	TS621	20	3.500	3.833	B	1	1⅞	3	¾	6.6
24	TS624	20	4.000	4.333	B	1½	1⅞	3	¾	8.1
27	TS627	20	4.500	4.833	B	1½	2⅞	3½	¾	10.6
30	TS630	20	5.000	5.333	B	1½	2½	4	¾	13.4
33	TS633	20	5.500	5.833	B	1½	2½	4	1½	17.8
36	TS636	20	6.000	6.333	B	1½	2½	4	1½	20.4
42	TS642	20	7.000	7.333	B	1½	2½	4	1½	26.2
48	TS648	20	8.000	8.333	B	1½	2½	4	1½	32.8
54	TS654	20	9.000	9.333	B	1½	2½	4	1½	40.4
60	TS660	20	10.000	10.333	B	1½	2⅞	4½	1½	50.0
64	TS664	20	10.666	11.000	B	1½	2⅞	4½	1½	56.5
66	TS666	20	11.000	11.333	B	1½	2⅞	4½	1½	59.8
72	TS672	20	12.000	12.333	B	1½	2⅞	4½	1½	70.0
84	TS684	20	14.000	14.333	B ₂	1½	2⅞	5	1½	42.8
96	TS696	20	16.000	16.333	B ₂	1½	2⅞	5	1½	46.0
108	TS6108	20	18.000	18.333	B ₂	1½	2⅞	5	1½	48.8
120	TS6120	20	20.000	20.333	B ₂	1½	2⅞	5	1½	51.3

* Recommended maximum bore with keyway and set screw.

† Enlarged pitch diameter with special tooth form.

20° P.A. Gears Will Not Operate With 14½° P.A.

Bored-to-Size

No. Teeth	Catalog Number	Pressure Angle (Deg.)	Diameter		Type	Bore (Inches)		Set Screw	Hub (Inches)		Weight Lbs. (App.)
			Pitch	Outside		Stock	Keyway		Diameter	Proj.	
12	TS612BS 1	20	2.000	2.333	B	1	¼X ⅞	(1) 1/4-20 @90	1½	¾	1.60
14	TS614BS 1	20	2.333	2.667	B	1	¼X ⅞	(1) 5/16-18 @90	1⅞	¾	2.40
14	TS614BS 1-1/8	20	2.333	2.667	B	1½	¼X ⅞	(1) 5/16-18 @90	1⅞	¾	2.40
15	TS615BS 1	20	2.500	2.833	B	1	¼X ⅞	(1) 5/16-18 @90	2	¾	2.90
15	TS615BS 1-1/8	20	2.500	2.833	B	1½	¼X ⅞	(1) 5/16-18 @90	2	¾	2.90
15	TS615BS 1-3/16	20	2.500	2.833	B	1⅞	¼X ⅞	(1) 5/16-18 @90	2	¾	2.90
15	TS615BS 1-1/4	20	2.500	2.833	B	1½	¼X ⅞	(1) 5/16-18 @90	2	¾	2.90
16	TS616BS 1	20	2.667	3.000	B	1	¼X ⅞	(1) 5/16-18 @90	2½	¾	3.40
16	TS616BS 1-1/8	20	2.667	3.000	B	1½	¼X ⅞	(1) 5/16-18 @90	2½	¾	3.40
16	TS616BS 1-3/16	20	2.667	3.000	B	1⅞	¼X ⅞	(1) 5/16-18 @90	2½	¾	3.40
16	TS616BS 1-1/4	20	2.667	3.000	B	1½	¼X ⅞	(1) 5/16-18 @90	2½	¾	3.40
18	TS618BS 1	20	3.000	3.333	B	1	¼X ⅞	(1) 5/16-18 @90	2½	¾	4.60
18	TS618BS 1-1/8	20	3.000	3.333	B	1½	¼X ⅞	(1) 5/16-18 @90	2½	¾	4.60
18	TS618BS 1-3/16	20	3.000	3.333	B	1⅞	¼X ⅞	(1) 5/16-18 @90	2½	¾	4.60
18	TS618BS 1-1/4	20	3.000	3.333	B	1½	¼X ⅞	(1) 5/16-18 @90	2½	¾	4.60
21	TS621BS 1	20	3.500	3.833	B	1	¼X ⅞	(1) 5/16-18 @90	3	¾	6.60
21	TS621BS 1-1/8	20	3.500	3.833	B	1½	¼X ⅞	(1) 5/16-18 @90	3	¾	6.60
21	TS621BS 1-3/16	20	3.500	3.833	B	1⅞	¼X ⅞	(1) 5/16-18 @90	3	¾	6.60
21	TS621BS 1-1/4	20	3.500	3.833	B	1½	¼X ⅞	(1) 5/16-18 @90	3	¾	6.60

Martin

Steel & Cast Stock Spur Gears 20° Pressure Angle

8 DP 1 1/2" Face

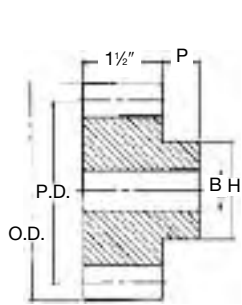

Type B

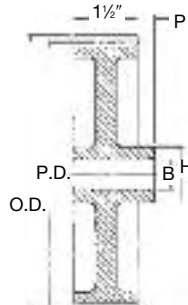

Type B₂, B₃



Type B
Plain With Hub All Steel



Type B₃
Web With Spokes Cast

Steel

No. Teeth	Catalog Number	Pressure Angle (Deg.)	Diameter		Type	Bore (Inches)		Hub (Inches)		Weight Lbs. (App.)
			Pitch	Outside		Stock	Max. *	Diameter	Proj.	
12	TS812	20	1.500	1.750	B	3/4	3/4	1 1/4	3/4	0.7
14	TS814	20	1.750	2.000	B	3/4	1 1/8	1 1/4	3/4	1.0
15	TS815	20	1.875	2.125	B	3/4	7/8	1 1/4	3/4	1.2
16	TS816	20	2.000	2.250	B	7/8	1 1/8	1 1/4	3/4	1.4
18	TS818	20	2.250	2.500	B	7/8	1 1/2	1 1/4	7/8	1.9
19	TS819	20	2.375	2.625	B	7/8	1 1/2	2	7/8	2.3
20	TS820	20	2.500	2.750	B	7/8	1 1/2	2 1/4	7/8	2.5
22	TS822	20	2.750	3.000	B	7/8	1 1/2	2 1/4	7/8	3.2
24	TS824	20	3.000	3.250	B	7/8	1 1/2	2 1/4	7/8	3.9
26	TS826	20	3.250	3.500	B	7/8	1 3/4	2 1/4	7/8	4.6
28	TS828	20	3.500	3.750	B	7/8	1 3/4	2 1/4	7/8	5.2
30	TS830	20	3.750	4.000	B	1	1 3/4	2 1/4	7/8	5.6
32	TS832	20	4.000	4.250	B	1	1 3/4	3 1/4	7/8	6.6
36	TS836	20	4.500	4.750	B	1	2 1/8	3 1/4	7/8	8.6
40	TS840	20	5.000	5.250	B	1	2 1/8	3 1/4	7/8	10.2
42	TS842	20	5.250	5.500	B	1	2 1/8	3 1/2	1	11.4
44	TS844	20	5.500	5.750	B	1	2 1/8	3 1/2	1	12.3
48	TS848	20	6.000	6.250	B	1	2 1/8	3 1/2	1	14.2

Cast

No. Teeth	Catalog Number	Pressure Angle (Deg.)	Diameter		Type	Bore (Inches)		Hub (Inches)		Weight Lbs. (App.)
			Pitch	Outside		Stock	Max. *	Diameter	Proj.	
52	TC852	20	6.500	6.750	B	1	1 1/2	3	1	11.9
56	TC856	20	7.000	7.250	B	1	1 1/2	3	1	13.0
60	TC860	20	7.500	7.750	B ₂	1	1 1/2	3	1	12.0
64	TC864	20	8.000	8.250	B ₃	1	1 1/2	3	1	12.1
72	TC872	20	9.000	9.250	B ₃	1	2 1/8	3 1/4	1	14.4
80	TC880	20	10.000	10.250	B ₃	1 1/4	2 1/8	3 1/4	1 1/4	17.0
88	TC888	20	11.000	11.250	B ₃	1 1/4	2 1/8	3 1/4	1 1/4	19.0
96	TC896	20	12.000	12.250	B ₃	1 1/4	2 1/8	3 1/2	1 1/4	23.7
112	TC8112	20	14.000	14.250	B ₃	1 1/4	2 1/8	3 1/2	1 1/4	25.0
120	TC8120	20	15.000	15.250	B ₃	1 1/4	2 1/8	3 1/2	1 1/4	25.8
128	TC8128	20	16.000	16.250	B ₃	1 1/4	2 1/8	3 1/2	1 1/4	28.0
144	TC8144	20	18.000	18.250	B ₃	1 1/4	2 1/4	3 1/2	1 1/4	32.0
160	TC8160	20	20.000	20.250	B ₃	1 1/4	2 1/4	3 1/2	1 1/4	34.8

Bored-to-Size

No. Teeth	Catalog Number	Pressure Angle (Deg.)	Diameter		Type	Bore (Inches)		Set Screw	Hub (Inches)		Weight Lbs. (App.)
			Pitch	Outside		Stock	Keyway		Diameter	Proj.	
12	TS812BS 3/4	20	1.500	1.750	B	3/4	3/16 X 3/32	(1) 10-24 @ 90	1 1/4	3/4	0.70
14	TS814BS 3/4	20	1.750	2.000	B	3/4	3/16 X 3/32	(1) 1/4-20 @ 90	1 1/4	3/4	1.00
15	TS815BS 3/4	20	1.875	2.125	B	3/4	3/16 X 3/32	(1) 1/4-20 @ 90	1 1/4	3/4	1.20
15	TS815BS 7/8	20	1.875	2.125	B	7/8	3/16 X 3/32	(1) 1/4-20 @ 90	1 1/4	3/4	1.20
16	TS816BS 7/8	20	2.000	2.250	B	7/8	3/16 X 3/32	(1) 1/4-20 @ 90	1 1/4	7/8	1.40
16	TS816BS 1	20	2.000	2.250	B	1	1/4 X 1/8	(1) 5/16-18 @ 90	1 1/4	7/8	1.40
18	TS818BS 7/8	20	2.250	2.500	B	7/8	3/16 X 3/32	(1) 1/4-20 @ 90	1 1/4	7/8	1.90
18	TS818BS 1	20	2.250	2.500	B	1	1/4 X 1/8	(1) 5/16-18 @ 90	1 1/4	7/8	1.90
18	TS818BS 1-1/8	20	2.250	2.500	B	1 1/8	1/4 X 1/8	(1) 5/16-18 @ 90	1 1/4	7/8	1.90
20	TS820BS 7/8	20	2.500	2.750	B	7/8	3/16 X 3/32	(1) 1/4-20 @ 90	2 1/4	7/8	2.50
20	TS820BS 1	20	2.500	2.750	B	1	1/4 X 1/8	(1) 5/16-18 @ 90	2 1/4	7/8	2.50
20	TS820BS 1-1/8	20	2.500	2.750	B	1 1/8	1/4 X 1/8	(1) 5/16-18 @ 90	2 1/4	7/8	2.50
22	TS822BS 7/8	20	2.750	3.000	B	7/8	3/16 X 3/32	(1) 1/4-20 @ 90	2 1/4	7/8	3.20
22	TS822BS 1	20	2.750	3.000	B	1	1/4 X 1/8	(1) 5/16-18 @ 90	2 1/4	7/8	3.20
22	TS822BS 1-1/8	20	2.750	3.000	B	1 1/8	1/4 X 1/8	(1) 5/16-18 @ 90	2 1/4	7/8	3.20
24	TS824BS 7/8	20	3.000	3.250	B	7/8	3/16 X 3/32	(1) 1/4-20 @ 90	2 1/4	7/8	3.90
24	TS824BS 1	20	3.000	3.250	B	1	1/4 X 1/8	(1) 5/16-18 @ 90	2 1/4	7/8	3.90
24	TS824BS 1-1/8	20	3.000	3.250	B	1 1/8	1/4 X 1/8	(1) 5/16-18 @ 90	2 1/4	7/8	3.90

* Recommended maximum bore with keyway and set screw.

20° P.A. Gears Will Not Operate With 14 1/2° P.A.

GEARS

10 DP 1 1/4" Face

Steel & Cast Stock Spur Gears 20° Pressure Angle

Martin



Type B
Plain With Hub
All Steel



Type B₃
Web With Spokes
Cast

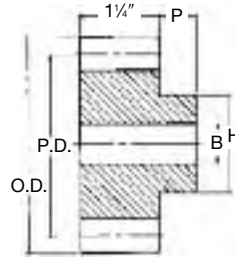

Type B

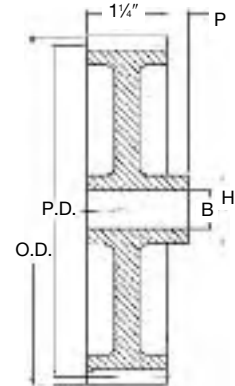

Type B₃

Steel

No. Teeth	Catalog Number	Pressure Angle (Deg.)	Diameter		Type	Bore (Inches)		Hub (Inches)		Weight Lbs. (App.)
			Pitch	Outside		Stock	Max.*	Diameter	Proj.	
12	TS1012	20	1.200	1.400	B	5/8	5/8	29/32	5/8	0.4
14	TS1014	20	1.400	1.600	B	3/4	3/4	1 1/64	5/8	0.6
15	TS1015	20	1.500	1.700	B	3/4	3/4	1 1/32	5/8	0.6
16	TS1016	20	1.600	1.800	B	3/4	3/4	1 1/16	5/8	0.7
18	TS1018	20	1.800	2.000	B	3/4	1 1/16	1 1/32	5/8	0.9
20	TS1020	20	2.000	2.200	B	7/8	7/8	1 3/64	5/8	1.2
22	TS1022	20	2.200	2.400	B	7/8	1 1/16	1 1/16	5/8	1.5
24	TS1024	20	2.400	2.600	B	7/8	1 1/8	2 1/64	5/8	1.8
25	TS1025	20	2.500	2.700	B	7/8	1 1/4	2 1/64	5/8	2.0
26	TS1026	20	2.600	2.800	B	7/8	1 1/2	2 1/4	5/8	2.2
28	TS1028	20	2.800	3.000	B	7/8	1 5/8	2 1/2	5/8	2.7
30	TS1030	20	3.000	3.200	B	7/8	1 3/4	2 1/2	7/8	3.4
32	TS1032	20	3.200	3.400	B	1	1 3/4	2 1/2	7/8	3.7
35	TS1035	20	3.500	3.700	B	1	1 3/4	2 1/2	7/8	4.2
36	TS1036	20	3.600	3.800	B	1	1 3/4	2 1/2	7/8	4.3
40	TS1040	20	4.000	4.200	B	1	2 1/8	3 1/2	7/8	6.4
45	TS1045	20	4.500	4.700	B	1	2 1/2	3 1/2	7/8	7.5
48	TS1048	20	4.800	5.000	B	1	2 3/4	3 3/4	7/8	8.7
50	TS1050	20	5.000	5.200	B	1	2 3/4	4	7/8	9.6
55	TS1055	20	5.500	5.700	B	1	2 3/4	4	1	11.5
60	TS1060	20	6.000	6.200	B	1	2 3/4	4	1	13.1

Cast

No. Teeth	Catalog Number	Pressure Angle (Deg.)	Diameter		Type	Bore (Inches)		Hub (Inches)		Weight Lbs. (App.)
			Pitch	Outside		Stock	Max.*	Diameter	Proj.	
70	TC1070	20	7.000	7.200	B ₃	1	1 11/16	2 3/4	1	8.2
80	TC1080	20	8.000	8.200	B ₃	1	1 11/16	2 3/4	1	11.2
90	TC1090	20	9.000	9.200	B ₃	1	1 13/16	3	1	11.7
100	TC10100	20	10.000	10.200	B ₃	1 1/2	1 13/16	3	1 1/2	12.2

* Recommended maximum bore with keyway and set screw.

20° P.A. Gears Will Not Operate With 14 1/2° P.A.

Bored-to-Size

No. Teeth	Catalog Number	Pressure Angle (Deg.)	Diameter		Type	Bore (Inches)		Set Screw	Hub (Inches)		Weight Lbs. (App.)
			Pitch	Outside		Stock	Keyway		Diameter	Proj.	
12	TS1012BS 5/8	20	1.200	1.400	B	5/8	3/16 X 3/32	(1) 10-24 @ 90	29/32	5/8	0.40
14	TS1014BS 5/8	20	1.400	1.600	B	5/8	3/16 X 3/32	(1) 1/4-20 @ 90	1 1/64	5/8	0.60
15	TS1015BS 3/4	20	1.500	1.700	B	3/4	3/16 X 3/32	(1) 1/4-20 @ 90	1 1/32	5/8	0.60
16	TS1016BS 3/4	20	1.600	1.800	B	3/4	3/16 X 3/32	(1) 1/4-20 @ 90	1 1/16	5/8	0.70
18	TS1018BS 7/8	20	1.800	2.000	B	7/8	3/16 X 3/32	(1) 1/4-20 @ 90	1 1/32	5/8	0.90
20	TS1020BS 7/8	20	2.000	2.200	B	7/8	3/16 X 3/32	(1) 1/4-20 @ 90	1 3/64	5/8	1.20
20	TS1020BS 1	20	2.000	2.200	B	1	1/4 X 1/8	(1) 5/16-18 @ 90	1 3/64	5/8	1.20
24	TS1024BS 7/8	20	2.400	2.600	B	7/8	3/16 X 3/32	(1) 1/4-20 @ 90	1 1/16	5/8	1.50
24	TS1024BS 1	20	2.400	2.600	B	1	1/4 X 1/8	(1) 5/16-18 @ 90	1 1/16	5/8	1.50
25	TS1025BS 7/8	20	2.500	2.700	B	7/8	3/16 X 3/32	(1) 1/4-20 @ 90	2 1/64	5/8	2.00
25	TS1025BS 1	20	2.500	2.700	B	1	1/4 X 1/8	(1) 5/16-18 @ 90	2 1/64	5/8	2.00
28	TS1028BS 7/8	20	2.800	3.000	B	7/8	3/16 X 3/32	(1) 1/4-20 @ 90	2 1/32	5/8	2.70
28	TS1028BS 1	20	2.800	3.000	B	1	1/4 X 1/8	(1) 5/16-18 @ 90	2 1/32	5/8	2.70

Martin

Steel & Cast Stock Spur Gears 20° Pressure Angle

12 DP 1" Face

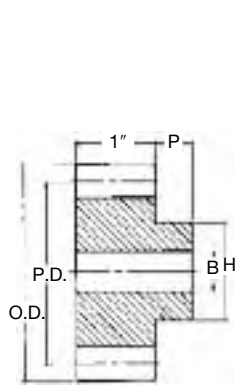

Type B

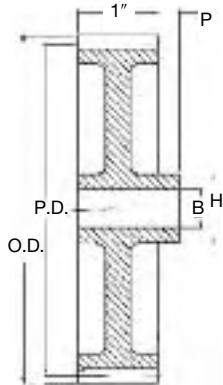

Type B₃



Type B
Plain With Hub All Steel



Type B₃
Web With Spokes Cast

Steel

No. Teeth	Catalog Number	Pressure Angle (Deg.)	Diameter		Type	Bore (Inches)		Hub (Inches)		Weight Lbs. (App.)
			Pitch	Outside		Stock	Max.*	Diameter	Proj.	
12	TS1212	20	1.000	1.167	B	1/8	1/8	3/16	5/16	0.21
13	TS1213	20	1.083	1.250	B	5/16	5/16	1/8	5/16	0.21
14	TS1214	20	1.167	1.333	B	5/16	5/16	29/32	5/16	0.28
15	TS1215	20	1.250	1.417	B	5/16	5/16	63/64	5/16	0.34
16	TS1216	20	1.333	1.500	B	5/16	5/16	1 1/16	5/16	0.41
18	TS1218	20	1.500	1.667	B	3/4	3/4	1 1/4	5/16	0.51
19	TS1219	20	1.583	1.750	B	3/4	3/4	1 1/16	5/16	0.59
20	TS1220	20	1.667	1.833	B	3/4	3/4	1 1/16	5/16	0.65
21	TS1221	20	1.750	1.917	B	3/4	1 1/16	1 5/16	5/16	0.75
22	TS1222	20	1.833	2.000	B	3/4	7/8	1 1/16	5/16	0.88
24	TS1224	20	2.000	2.166	B	3/4	1 1/16	1 5/16	5/16	1.06
25	TS1225	20	2.083	2.250	B	3/4	1 1/16	1 1/16	5/16	1.22
26	TS1226	20	2.167	2.333	B	3/4	1 1/8	1 1/8	5/16	1.33
28	TS1228	20	2.333	2.500	B	3/4	1 1/4	2 1/16	5/16	1.60
30	TS1230	20	2.500	2.667	B	3/4	1 1/2	2 1/2	5/16	1.83
32	TS1232	20	2.667	2.833	B	3/4	1 1/2	2 1/4	5/16	2.08
36	TS1236	20	3.000	3.167	B	3/4	1 3/4	2 1/2	7/8	2.98
42	TS1242	20	3.500	3.666	B	3/4	2 1/8	2 3/4	7/8	3.71
48	TS1248	20	4.000	4.166	B	7/8	1 7/8	3	7/8	4.99
54	TS1254	20	4.500	4.666	B	7/8	2 1/8	3 1/2	7/8	6.57
60	TS1260	20	5.000	5.166	B	7/8	2 1/2	3 3/8	7/8	7.63
66	TS1266	20	5.500	5.666	B	7/8	2 3/4	3 1/2	7/8	8.80
72	TS1272	20	6.000	6.166	B	7/8	2 3/4	3 1/2	7/8	10.08

Cast

No. Teeth	Catalog Number	Pressure Angle (Deg.)	Diameter		Type	Bore (Inches)		Hub (Inches)		Weight Lbs. (App.)
			Pitch	Outside		Stock	Max.*	Diameter	Proj.	
84	TC1284	20	7.000	7.166	B ₃	7/8	1 1/16	2 1/2	7/8	5.9
96	TC1296	20	8.000	8.166	B ₃	7/8	1 1/16	2 1/2	7/8	7.0
108	TC12108	20	9.000	9.166	B ₃	7/8	1 1/16	2 1/2	7/8	7.6
120	TC12120	20	10.000	10.166	B ₃	1	1 1/16	2 1/2	7/8	10.3
144	TC12144	20	12.000	12.166	B ₃	1	1 1/16	2 1/2	1	10.4

Bored-to-Size

No. Teeth	Catalog Number	Pressure Angle (Deg.)	Diameter		Type	Bore (Inches)		Set Screw	Hub (Inches)		Weight Lbs. (App.)
			Pitch	Outside		Stock	Keyway		Diameter	Proj.	
12	TS1212BS 1/2	20	1.000	1.167	B	1/8	NONE	(1) 10-24	3/16	5/16	0.21
13	TS1213BS 5/8	20	1.083	1.250	B	5/16	NONE	(1) 1/4-20 @ 90	1 1/16	5/16	0.21
14	TS1214BS 5/8	20	1.167	1.333	B	5/16	3/16 X 3/32	(1) 10-24 @ 90	29/32	5/16	0.28
15	TS1215BS 5/8	20	1.250	1.417	B	5/16	3/16 X 3/32	(1) 10-24 @ 90	63/64	5/16	0.34
16	TS1216BS 5/8	20	1.333	1.500	B	5/16	3/16 X 3/32	(1) 1/4-20 @ 90	1 1/16	5/16	0.41
18	TS1218BS 3/4	20	1.500	1.667	B	3/4	3/16 X 3/32	(1) 1/4-20 @ 90	1 1/4	5/16	0.51
20	TS1220BS 3/4	20	1.667	1.833	B	3/4	3/16 X 3/32	(1) 1/4-20 @ 90	1 1/16	5/16	0.65
21	TS1221BS 3/4	20	1.750	1.917	B	3/4	3/16 X 3/32	(1) 1/4-20 @ 90	1 25/64	5/16	0.75
21	TS1221BS 7/8	20	1.750	1.917	B	7/8	3/16 X 3/32	(1) 1/4-20 @ 90	1 25/64	5/16	0.75
24	TS1224BS 3/4	20	2.000	2.167	B	3/4	3/16 X 3/32	(1) 1/4-20 @ 90	1 11/64	5/16	1.06
24	TS1224BS 7/8	20	2.000	2.167	B	7/8	3/16 X 3/32	(1) 1/4-20 @ 90	1 11/64	5/16	1.06
24	TS1224BS 1	20	2.000	2.167	B	1	1/4 X 1/8	(1) 5/16-18 @ 90	1 11/64	5/16	1.06
28	TS1228BS 3/4	20	2.333	2.500	B	3/4	3/16 X 3/32	(1) 1/4-20 @ 90	2 1/16	5/16	1.60
28	TS1228BS 7/8	20	2.333	2.500	B	7/8	3/16 X 3/32	(1) 1/4-20 @ 90	2 1/16	5/16	1.60
28	TS1228BS 1	20	2.333	2.500	B	1	1/4 X 1/8	(1) 5/16-18 @ 90	2 1/16	5/16	1.60

* Recommended maximum bore with keyway and set screw.

GEARS

16 DP

3/4" Face

Steel & Cast Stock

Spur Gears

20° Pressure Angle

Martin



Type B
Plain With Hub All Steel



Type B₃
Web With Spokes Cast

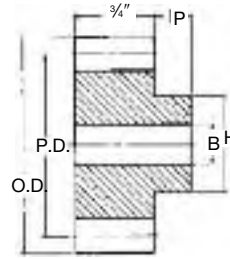

Type B

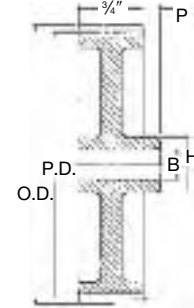

Type B₃

Steel

No. Teeth	Catalog Number	Pressure Angle (Deg.)	Diameter		Type	Bore (Inches)		Hub (Inches)		Weight Lbs. (App.)
			Pitch	Outside		Stock	Max.*	Diameter	Proj.	
12	TS1612	20	.750	.875	B	3/8	3/8	3/16	1/2	0.09
13	TS1613	20	.812	.938	B	3/8	3/8	3/16	1/2	0.11
14	TS1614	20	.875	1.000	B	3/8	3/8	1/16	1/2	0.14
15	TS1615	20	.937	1.063	B	3/8	1/2	3/16	1/2	0.17
16	TS1616	20	1.000	1.125	B	1/2	1/2	1/16	1/2	0.17
17	TS1617	20	1.062	1.188	B	1/2	1/2	3/16	1/2	0.20
18	TS1618	20	1.125	1.250	B	1/2	1/2	1/16	1/2	0.24
20	TS1620	20	1.250	1.375	B	3/4	3/4	1/16	1/2	0.28
21	TS1621	20	1.312	1.438	B	3/4	3/4	1/16	1/2	0.32
22	TS1622	20	1.375	1.500	B	3/4	3/4	1/16	1/2	0.36
24	TS1624	20	1.500	1.625	B	3/4	3/4	1/16	1/2	0.46
26	TS1626	20	1.625	1.750	B	3/4	3/4	1/16	1/2	0.56
28	TS1628	20	1.750	1.875	B	3/4	3/4	1/16	1/2	0.65
30	TS1630	20	1.875	2.000	B	3/4	1 1/16	1/16	1/2	0.77
32	TS1632	20	2.000	2.125	B	3/4	1	1/16	1/2	0.90
36	TS1636	20	2.250	2.375	B	3/4	1 1/4	2	1/2	1.18
40	TS1640	20	2.500	2.625	B	3/4	1 1/2	2	3/8	1.48
48	TS1648	20	3.000	3.125	B	3/4	1 1/2	2	3/8	1.94
56	TS1656	20	3.500	3.625	B	3/4	1 3/4	2 1/2	3/8	2.79
60	TS1660	20	3.750	3.875	B	3/4	1 1/2	2 1/4	3/8	3.28
64	TS1664	20	4.000	4.125	B	3/4	1 1/2	2 3/4	3/8	3.74
72	TS1672	20	4.500	4.625	B	3/4	1 3/4	3	3/8	4.69
80	TS1680	20	5.000	5.125	B	3/4	2 1/8	3 1/2	3/8	6.03
84	TS1684	20	5.250	5.375	B	3/4	2 1/8	3 1/2	3/8	6.46
96	TS1696	20	6.000	6.125	B	3/4	2 3/8	3 3/4	3/8	7.86
104	TS16104	20	6.500	6.625	B	3/4	2 3/8	3 3/4	3/8	8.91

Cast

No. Teeth	Catalog Number	Pressure Angle (Deg.)	Diameter		Type	Bore (Inches)		Hub (Inches)		Weight Lbs. (App.)
			Pitch	Outside		Stock	Max.*	Diameter	Proj.	
112	TC16112	20	7.000	7.125	B ₃	3/4	1 1/16	2 1/2	3/8	4.4
128	TC16128	20	8.000	8.125	B ₃	3/4	1 1/16	2 3/4	3/8	5.5
144	TC16144	20	9.000	9.125	B ₃	3/4	1 1/16	2 3/4	3/8	6.4
160	TC16160	20	10.000	10.125	B ₃	3/4	1 1/16	2 3/4	3/8	8.1
192	TC16192	20	12.000	12.125	B ₃	3/4	1 3/16	3	1	10.1

* Recommended maximum bore with keyway and set screw.

20° P.A. Gears Will Not Operate With 14 1/2° P.A.

Bored-to-Size

No. Teeth	Catalog Number	Pressure Angle (Deg.)	Diameter		Type	Bore (Inches)		Set Screw	Hub (Inches)		Weight Lbs. (App.)
			Pitch	Outside		Stock	Keyway		Diameter	Proj.	
12	TS1612BS 3/8	20	0.750	0.875	B	3/8	NONE	(1) 8-32	3/16	1/2	0.09
14	TS1614BS 3/8	20	0.875	1.000	B	3/8	NONE	(1) 10-24	1/16	1/2	0.14
15	TS1615BS 3/8	20	0.937	1.063	B	3/8	NONE	(1) 10-24	3/16	1/2	0.17
15	TS1615BS 1/2	20	0.937	1.063	B	1/2	NONE	(1) 10-24	3/16	1/2	0.17
16	TS1616BS 1/2	20	1.000	1.125	B	1/2	NONE	(1) 10-24	1/16	1/2	0.17
18	TS1618BS 1/2	20	1.125	1.250	B	1/2	NONE	(1) 1/4-20	1/16	1/2	0.24
20	TS1620BS 5/8	20	1.250	1.375	B	3/8	3/16 X 3/32	(1) 1/4-20 @ 90	1/16	1/2	0.28
24	TS1624BS 5/8	20	1.500	1.625	B	3/8	3/16 X 3/32	(1) 1/4-20 @ 90	1/16	1/2	0.46
24	TS1624BS 3/4	20	1.500	1.625	B	3/4	3/16 X 3/32	(1) 1/4-20 @ 90	1/16	1/2	0.46
28	TS1628BS 5/8	20	1.750	1.875	B	3/8	3/16 X 3/32	(1) 1/4-20 @ 90	1/16	1/2	0.65
28	TS1628BS 3/4	20	1.750	1.875	B	3/4	3/16 X 3/32	(1) 1/4-20 @ 90	1/16	1/2	0.65
30	TS1630BS 5/8	20	1.875	2.000	B	3/8	3/16 X 3/32	(1) 1/4-20 @ 90	1/16	1/2	0.77
30	TS1630BS 3/4	20	1.875	2.000	B	3/4	3/16 X 3/32	(1) 1/4-20 @ 90	1/16	1/2	0.77
30	TS1630BS 7/8	20	1.875	2.000	B	3/4	3/16 X 3/32	(1) 1/4-20 @ 90	1/16	1/2	0.77
32	TS1632BS 5/8	20	2.000	2.125	B	3/8	3/16 X 3/32	(1) 1/4-20 @ 90	1/16	1/2	0.90
32	TS1632BS 3/4	20	2.000	2.125	B	3/4	3/16 X 3/32	(1) 1/4-20 @ 90	1/16	1/2	0.90
32	TS1632BS 7/8	20	2.000	2.125	B	3/4	3/16 X 3/32	(1) 1/4-20 @ 90	1/16	1/2	0.90
32	TS1632BS 1	20	2.000	2.125	B	1	1/4 X 1/8	(1) 5/16-18 @ 90	1/16	1/2	0.90

Martin

Steel Stock Spur Gears 20° Pressure Angle

20 DP 1/2" Face

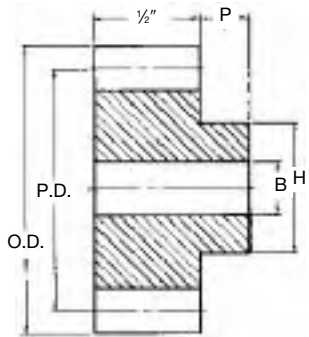

Type B



Type B
Plain With Hub
All Steel

Steel

No. Teeth	Catalog Number	Pressure Angle (Deg.)	Diameter		Type	Bore (Inches)		Hub (Inches)		Weight Lbs. (App.)
			Pitch	Outside		Stock	Max. *	Diameter	Proj.	
12	TS2012	20	.600	.700	B	5/16	5/16	15/32	7/16	0.04
14	TS2014	20	.700	.800	B	5/16	5/16	35/64	7/16	0.06
15	TS2015	20	.750	.850	B	3/8	3/8	39/64	7/16	0.07
16	TS2016	20	.800	.900	B	3/8	3/8	21/32	7/16	0.08
18	TS2018	20	.900	1.000	B	3/8	3/8	3/4	7/16	0.12
20	TS2020	20	1.000	1.100	B	1/2	1/2	59/64	7/16	0.13
21	TS2021	20	1.050	1.150	B	1/2	1/2	7/8	7/16	0.15
22	TS2022	20	1.100	1.200	B	1/2	1/2	31/32	7/16	0.17
24	TS2024	20	1.200	1.300	B	1/2	5/16	1 1/16	7/16	0.22
25	TS2025	20	1.250	1.350	B	1/2	3/8	1 1/64	7/16	0.24
28	TS2028	20	1.400	1.500	B	1/2	1 1/16	1 1/64	7/16	0.32
30	TS2030	20	1.500	1.600	B	1/2	1 3/16	1 23/64	7/16	0.38
32	TS2032	20	1.600	1.700	B	1/2	7/8	1 1/16	1/2	0.46
35	TS2035	20	1.750	1.850	B	1/2	7/8	1 1/16	1/2	0.56
36	TS2036	20	1.800	1.900	B	1/2	15/16	1 1/8	1/2	0.60
40	TS2040	20	2.000	2.100	B	1/2	1 1/16	1 3/16	1/2	0.76
45	TS2045	20	2.250	2.350	B	1/2	1 1/4	2	1/2	0.95
50	TS2050	20	2.500	2.600	B	1/2	1 1/4	2	1/2	1.08
60	TS2060	20	3.000	3.100	B	1/2	1 1/2	2 1/2	1/2	1.45
70	TS2070	20	3.500	3.600	B	1/2	1 1/2	2 3/4	1/2	1.93
72	TS2072	20	3.600	3.700	B	1/2	1 1/16	2 3/4	1/2	2.01
80	TS2080	20	4.000	4.100	B	3/4	1 1/2	2 1/2	3/8	2.35
84	TS2084	20	4.200	4.300	B	3/4	1 1/2	2 1/2	3/8	2.53
90	TS2090	20	4.500	4.600	B	3/4	1 1/2	2 1/2	3/8	2.82
96	TS2096	20	4.800	4.900	B	3/4	1 1/2	2 1/2	3/8	3.14
100	TS20100	20	5.000	5.100	B	3/4	1 1/2	2 1/2	3/8	3.35
120	TS20120	20	6.000	6.100	B	3/4	1 1/2	2 1/2	3/8	4.58

* Recommended maximum bore with keyway and set screw.

20° P.A. Gears Will Not Operate With 14 1/2° P.A.

Bored-to-Size

No. Teeth	Catalog Number	Pressure Angle (Deg.)	Diameter		Type	Bore (Inches)		Set Screw	Hub (Inches)		Weight Lbs. (App.)
			Pitch	Outside		Stock	Keyway		Diameter	Proj.	
12	TS2012BS 5/16	20	0.600	0.700	B	5/16	NONE	#35 P.H.	15/32	7/16	0.04
14	TS2014BS 5/16	20	0.700	0.800	B	5/16	NONE	#35 P.H.	35/64	7/16	0.06
15	TS2015BS 3/8	20	0.750	0.850	B	3/8	NONE	(1) 8-32	39/64	7/16	0.07
16	TS2016BS 3/8	20	0.800	0.900	B	3/8	NONE	(1) 8-32	21/32	7/16	0.08
18	TS2018BS 3/8	20	0.900	1.000	B	3/8	NONE	(1) 10-24	3/4	7/16	0.12
20	TS2020BS 1/2	20	1.000	1.100	B	1/2	NONE	(1) 10-24	59/64	7/16	0.13
24	TS2024BS 1/2	20	1.200	1.300	B	1/2	NONE	(1) 1/4-20	1 1/16	7/16	0.22
25	TS2025BS 1/2	20	1.250	1.350	B	1/2	NONE	(1) 1/4-20	1 1/64	7/16	0.24
30	TS2030BS 1/2	20	1.500	1.600	B	1/2	NONE	(1) 1/4-20	1 23/64	7/16	0.38
35	TS2035BS 1/2	20	1.750	1.850	B	1/2	NONE	(1) 1/4-20	1 1/16	1/2	0.56
40	TS2040BS 1/2	20	2.000	2.100	B	1/2	NONE	(1) 1/4-20	1 13/16	1/2	0.76
40	TS2040BS 5/8	20	2.000	2.100	B	3/4	3/16 X 3/32	(1) 1/4-20 @ 90	1 13/16	1/2	0.76
40	TS2040BS 3/4	20	2.000	2.100	B	3/4	3/16 X 3/32	(1) 1/4-20 @ 90	1 13/16	1/2	0.76

GEARS

20° Horsepower Ratings (Approximate)



For
Class I Service (Service Factor = 1.0)

4 Diametral Pitch

20° Pressure Angle

3 1/2" Face

No. Teeth	25 RPM		50 RPM		100 RPM		200 RPM		300 RPM		500 RPM		600 RPM		900 RPM		1200 RPM		1800 RPM	
	S	CI	S	CI	S	CI	S	CI	S	CI	S	CI	S	CI	S	CI	S	CI	S	CI
11	2.62		5.09		9.64		17.41		23.81		33.72		37.64		46.69		53.06			
12•	3.10		6.02		11.40		20.59		28.15		39.88		44.52		55.21		62.75			
13	3.62		7.03		13.30		24.03		32.86		46.55		51.97		64.45		73.25			
14•	4.07		7.91		14.98		27.06		37.00		52.41		58.51		72.57		82.48			
15•	4.57		8.88		16.80		30.35		41.51		58.80		65.64		81.41		92.53			
16•	4.97		9.67		18.30		33.05		45.20		64.03		71.47		88.64		100.75			
17	5.41		10.51		19.90		35.95		49.16		69.64		77.74		96.42					
18•	5.84		11.35		21.49		38.82		53.09		75.20		83.95		104.12					
19	6.29		12.22		23.13		41.77		57.13		80.93		90.33		112.04					
20•	6.74		13.11		24.81		44.81		61.29		86.81		96.91							
21	7.19		13.98		26.46		47.79		65.36		92.58		103.34							
22•	7.65		14.87		28.14		50.83		69.52		98.48		109.93							
24•	8.52		16.56		31.35		56.63		77.45		109.71		122.47							
25	8.96		17.41		32.95		59.52		81.39		115.30		128.70							
26	9.43		18.32		34.67		62.63		85.65		121.32		135.43							
27	9.90		19.24		36.42		65.79		89.97		127.45		142.27							
28•	10.39		20.18		38.21		69.01		94.38		133.69		149.24							
30•	11.32		22.00		41.63		75.20		102.84		145.69									
32•	12.27		23.85		45.15		81.56		111.54		158.00									
33	12.76		24.80		46.95		84.80		115.97		164.28									
35	13.79		26.81		50.74		91.66		125.35		177.56									
36•	14.30		27.79		52.61		95.03		129.96		184.10									
40•	16.40		31.87		60.32		108.95		149.00											
42	17.39		33.80		63.98		115.58		158.06											
44•	18.41		35.77		67.71		122.31		167.27											
45	18.92		36.77		69.60		125.72		171.93											
48•	20.54		39.91		75.54		136.46		186.61											
50	21.50		41.78		79.08		142.84		195.35											
52	22.52		43.77		82.85		149.65		204.66											
54	23.56		45.78		86.66		156.54		214.08											
55	24.00		46.63		88.26		159.44		218.04											
56•	24.49		47.59		90.09		162.73													
60•	26.62		51.73		97.92		176.87													
64•	28.60		55.57		105.19		190.01													
66	29.63		57.58		108.99		196.87													
70	31.65		61.50		116.41		210.27													
72•	32.55		63.26		119.73		216.28													
80•	36.76		71.43		135.21		244.23													
84	38.86		75.52		142.94		258.21													
88	40.80		79.30		150.09															
90	41.83		81.28		153.85															
96	44.92		87.29		165.23															
100	46.90		91.13		172.50															
108	50.87		98.87		187.14															
110	51.93		100.92		191.03															
112	52.88		102.76		194.50															
120	57.03		110.84		209.79															
144	54.18		105.28		199.28															
160	77.39		150.40		284.68															
200	97.58		189.64		358.95															

Ratings are based on strength calculation.

• Designates stock sizes for this pitch.

Note: 1. Ratings to right of heavy line are not recommended, as pitch line velocity exceeds 1000 feet per minute. They should be used for interpolation purposes only.

2. Non-metallic gears are most commonly used for the driving pinion of a pair of gears, with mating gear made of Cast Iron or Steel, where pitch line velocities exceed 1000 FPM and are not subjected to shock loads.



20° Horsepower Ratings (Approximate)

For
Class I Service (Service Factor = 1.0)

5 Diametral Pitch

20° Pressure Angle

2½" Face

No. Teeth	25 RPM		50 RPM		100 RPM		200 RPM		300 RPM		500 RPM		600 RPM		900 RPM		1200 RPM		1800 RPM	
	S	CI	S	CI	S	CI	S	CI	S	CI	S	CI	S	CI	S	CI	S	CI	S	CI
11•	1.20		2.35		4.50		8.28		11.49		16.67		18.78		23.82		27.50		32.54	
12	1.42		2.78		5.32		9.79		13.59		19.71		22.21		28.17		32.53			
13•	1.66		3.25		6.21		11.43		15.86		23.01		25.93		32.88		37.97			
14•	1.87		3.66		7.00		12.87		17.86		25.90		29.19		37.02		42.75			
15•	2.10		4.10		7.85		14.44		20.04		29.06		32.75		41.53		47.96			
16	2.29		4.47		8.55		15.72		21.82		31.64		35.66		45.22		52.22			
17•	2.49		4.86		9.30		17.10		23.73		34.42		38.79		49.19		56.80			
18	2.69		5.25		10.04		18.46		25.63		37.17		41.88		53.11		61.34			
19•	2.89		5.65		10.80		19.87		27.58		40.00		45.07		57.16		66.01			
20	3.10		6.06		11.59		21.31		29.58		42.91		48.35		61.31					
21	3.31		6.46		12.36		22.73		31.55		45.76		51.56		65.39					
22•	3.52		6.87		13.15		24.18		33.56		48.67		54.85		69.55					
24•	3.92		7.66		14.65		26.93		37.39		54.22		61.10		77.49					
25	4.12		8.05		15.39		28.30		39.29		56.98		64.21		81.43					
26	4.33		8.47		16.20		29.78		41.34		59.96		67.57							
27•	4.55		8.90		17.02		31.29		43.43		62.99		70.98							
28•	4.78		9.33		17.85		32.82		45.56		66.08		74.46							
30	5.20		10.17		19.45		35.76		49.64		72.00		81.14							
32	5.64		11.03		21.09		38.79		53.84		78.09		88.00							
33•	5.87		11.47		21.93		40.33		55.98		81.19		91.49							
35	6.34		12.40		23.70		43.59		60.51		87.76		98.89							
36•	6.58		12.85		24.58		45.19		62.73		90.99									
40	7.54		14.73		28.18		51.81		71.92		104.32									
42	8.00		15.63		29.89		54.96		76.30		110.66									
44•	8.46		16.54		31.63		58.17		80.74		117.11									
45	8.70		17.00		32.51		59.79		82.99											
48•	9.44		18.45		35.29		64.89		90.08											
50	9.89		19.32		36.94		67.93		94.30											
52	10.36		20.24		38.70		71.17		98.79											
54	10.83		21.17		40.48		74.44		103.34											
55	11.03		21.56		41.23		75.82		105.25											
56•	11.26		22.01		42.08		77.39		107.42											
60	12.24		23.92		45.74		84.11		116.76											
64	13.15		25.70		49.14		90.36		125.43											
66•	13.62		26.62		50.91		93.62		129.96											
70	14.55		28.44		54.38		100.00		138.81											
72•	14.97		29.25		55.93		102.85													
80	16.90		33.03		63.16		116.15													
84	17.87		34.92		66.78		122.79													
88•	18.76		36.67		70.12		128.93													
90	19.23		37.58		71.87		132.16													
96•	20.65		40.36		77.19		141.93													
100	21.56		42.14		80.58															
108•	23.39		45.71		87.42															
110	23.88		46.67		89.24															
112•	24.31		47.51																	
120	26.23		51.25																	
144	24.91		48.68																	
160	35.59		69.54																	
200	44.87		87.69																	

Ratings are based on strength calculation.

• Designates stock sizes for this pitch.

Note: 1. Ratings to right of heavy line are not recommended, as pitch line velocity exceeds 1000 feet per minute. They should be used for interpolation purposes only.

2. Non-metallic gears are most commonly used for the driving pinion of a pair of gears, with mating gear made of Cast Iron or Steel, where pitch line velocities exceed 1000 FPM and are not subjected to shock loads.

20° Horsepower Ratings (Approximate)



For
Class I Service (Service Factor = 1.0)

6 Diametral Pitch

20° Pressure Angle

2" Face

No. Teeth	25 RPM		50 RPM		100 RPM		200 RPM		300 RPM		500 RPM		600 RPM		900 RPM		1200 RPM		1800 RPM	
	S	CI	S	CI	S	CI	S	CI	S	CI	S	CI	S	CI	S	CI	S	CI	S	CI
11•	0.67		1.32		2.54		4.73		6.63		9.79		11.11		14.34		16.78		20.21	
12•	0.79		1.56		3.00		5.59		7.84		11.58		13.14		16.96		19.84		23.91	
13	0.93		1.82		3.50		6.52		9.15		13.51		15.34		19.80		23.16		27.91	
14•	1.04		2.05		3.94		7.35		10.31		15.21		17.27		22.29		26.08		31.42	
15•	1.17		2.30		4.43		8.24		11.56		17.07		19.37		25.01		29.26		35.25	
16•	1.28		2.50		4.82		8.97		12.59		18.58		21.10		27.23		31.85		38.38	
17	1.39		2.72		5.24		9.76		13.69		20.21		22.95		29.61		34.65			
18•	1.50		2.94		5.66		10.54		14.79		21.83		24.78		31.98		37.42			
19	1.61		3.16		6.09		11.34		15.91		23.49		26.66		34.41		40.26			
20	1.73		3.39		6.53		12.17		17.07		25.20		28.60		36.92		43.19			
21•	1.84		3.62		6.97		12.97		18.21		26.87		30.50		39.37		46.06			
22	1.96		3.85		7.41		13.80		19.37		28.59		32.45		41.88		49.00			
24•	2.19		4.29		8.26		15.38		21.57		31.85		36.15		46.65		54.59			
25	2.30		4.51		8.68		16.16		22.67		33.47		37.99		49.03					
26	2.42		4.74		9.13		17.00		23.86		35.22		39.97		51.59					
27•	2.54		4.98		9.59		17.86		25.06		37.00		41.99		54.20					
28	2.66		5.22		10.06		18.74		26.29		38.81		44.05		56.85					
30•	2.90		5.69		10.97		20.42		28.65		42.29		48.00		61.95					
32	3.15		6.17		11.89		22.14		31.07		45.86		52.06							
33•	3.27		6.42		12.36		23.02		32.31		47.69		54.13							
35	3.54		6.94		13.36		24.88		34.92		51.54		58.50							
36•	3.67		7.19		13.86		25.80		36.20		53.44		60.66							
40	4.21		8.25		15.89		29.58		41.51		61.27		69.54							
42•	4.46		8.75		16.85		31.38		44.03		64.99		73.77							
44	4.72		9.26		17.83		33.21		46.59		68.78		78.07							
45	4.85		9.52		18.33		34.13		47.89		70.70		80.25							
48•	5.27		10.33		19.90		37.05		51.98		76.73									
50	5.51		10.81		20.83		38.78		54.42		80.32									
52	5.78		11.33		21.82		40.63		57.01		84.15									
54•	6.04		11.85		22.82		42.50		59.63		88.02									
55	6.15		12.07		23.25		43.29		60.74											
56	6.28		12.32		23.73		44.18		61.99											
60•	6.83		13.39		25.79		48.02		67.38											
64•	7.33		14.39		27.70		51.59		72.38											
66•	7.60		14.91		28.71		53.45		75.00											
70	8.12		15.92		30.66		57.09		80.10											
72•	8.35		16.37		31.54		58.72		82.39											
80	9.43		18.49		35.61		66.31		93.04											
84•	9.97		19.55		37.65		70.10		98.36											
88	10.46		20.53		39.53		73.61		103.28											
90	10.73		21.04		40.52		75.45													
96•	11.52		22.60		43.52		81.03													
100	12.03		23.59		45.43		84.60													
108•	13.05		25.59		49.29		91.77													
110	13.32		26.12		50.31		93.68													
112	13.56		26.60		51.23		95.39													
120•	14.63		28.69		55.25															
144	13.89		27.25		52.49															
160	19.85		38.93		74.98															
200	25.03		49.09		94.54															

Ratings are based on strength calculation.

• Designates stock sizes for this pitch.

Note: 1. Ratings to right of heavy line are not recommended, as pitch line velocity exceeds 1000 feet per minute. They should be used for interpolation purposes only.

2. Non-metallic gears are most commonly used for the driving pinion of a pair of gears, with mating gear made of Cast Iron or Steel, where pitch line velocities exceed 1000 FPM and are not subjected to shock loads.



20° Horsepower Ratings (Approximate)

For
Class I Service (Service Factor = 1.0)

8 Diametral Pitch

20° Pressure Angle

1½" Face

No. Teeth	25 RPM		50 RPM		100 RPM		200 RPM		300 RPM		500 RPM		600 RPM		900 RPM		1200 RPM		1800 RPM	
	S	CI	S	CI	S	CI	S	CI	S	CI	S	CI	S	CI	S	CI	S	CI	S	CI
11	0.28		0.56		1.09		2.06		2.94		4.45		5.10		6.76		8.07		10.00	
12•	0.34		0.66		1.29		2.44		3.48		5.26		6.03		7.99		9.54		11.83	
13	0.39		0.78		1.51		2.85		4.06		6.14		7.04		9.33		11.14		13.81	
14•	0.44		0.87		1.70		3.21		4.57		6.91		7.93		10.50		12.54		15.55	
15•	0.50		0.98		1.90		3.60		5.13		7.76		8.90		11.78		14.07		17.45	
16•	0.54		1.07		2.07		3.92		5.58		8.44		9.69		12.83		15.31		18.99	
17	0.59		1.16		2.25		4.26		6.07		9.18		10.53		13.95		16.66		20.66	
18•	0.64		1.25		2.43		4.61		6.56		9.92		11.38		15.07		17.99		22.31	
19•	0.68		1.35		2.62		4.96		7.06		10.67		12.24		16.22		19.36		24.01	
20•	0.73		1.45		2.81		5.32		7.57		11.45		13.13		17.40		20.77		25.76	
21	0.78		1.54		3.00		5.67		8.07		12.21		14.00		18.55		22.14			
22•	0.83		1.64		3.19		6.03		8.59		12.99		14.90		19.73		23.56			
24•	0.93		1.83		3.55		6.72		9.56		14.47		16.60		21.98		26.24			
25	0.97		1.92		3.73		7.06		10.05		15.21		17.44		23.10		27.58			
26•	1.02		2.02		3.93		7.43		10.58		16.00		18.35		24.31		29.02			
27	1.08		2.12		4.12		7.80		11.11		16.81		19.28		25.54		30.49			
28•	1.13		2.23		4.33		8.19		11.66		17.63		20.22		26.79		31.98			
30•	1.23		2.43		4.71		8.92		12.70		19.21		22.04		29.19		34.85			
32•	1.33		2.63		5.11		9.68		13.77		20.84		23.90		31.66					
33	1.39		2.73		5.31		10.06		14.32		21.67		24.85		32.92					
35	1.50		2.96		5.74		10.87		15.48		23.42		26.86		35.58					
36•	1.56		3.06		5.96		11.27		16.05		24.28		27.85		36.89					
40•	1.78		3.51		6.83		12.92		18.40		27.84		31.93		42.29					
42•	1.89		3.73		7.24		13.71		19.52		29.53		33.87		44.86					
44•	2.00		3.94		7.67		14.51		20.66		31.25		35.84		47.48					
45	2.06		4.05		7.88		14.91		21.23		32.12		36.84							
48•	2.23		4.40		8.55		16.19		23.05		34.86		39.99							
50		1.12		2.21		4.30		8.13		11.58		17.52		20.09						
52•		1.18		2.32		4.50		8.52		12.13		18.35		21.05						
54		1.23		2.42		4.71		8.91		12.69		19.20		22.02						
55		1.25		2.47		4.80		9.08		12.93		19.55		22.43						
56•		1.28		2.52		4.90		9.27		13.19		19.96		22.89						
60•		1.39		2.74		5.32		10.07		14.34		21.69		24.88						
64•		1.49		2.94		5.72		10.82		15.40		23.30								
66		1.55		3.05		5.92		11.21		15.96		24.14								
70		1.65		3.26		6.33		11.97		17.05		25.79								
72•		1.70		3.35		6.51		12.32		17.53										
80•		1.92		3.78		7.35		13.91		19.80										
84		2.03		4.00		7.77		14.70		20.93										
88•		2.13		4.20		8.16		15.44		21.98										
90		2.18		4.30		8.36		15.82		22.53										
96•		2.34		4.62		8.98		16.99		24.20										
100		2.45		4.82		9.37		17.74		25.26										
108		2.66		5.23		10.17		19.25		27.40										
110		2.71		5.34		10.38		19.65		27.97										
112•		2.76		5.44		10.57		20.01		28.48										
120•		2.98		5.87		11.40		21.58		30.72										
144•		2.83		5.57		10.83		20.50												
160•		4.04		7.96		15.47		29.28												
200		5.09		10.04		19.51		36.92												

Ratings are based on strength calculation.

• Designates stock sizes for this pitch.

Note: 1. Ratings to right of heavy line are not recommended, as pitch line velocity exceeds 1000 feet per minute. They should be used for interpolation purposes only.

2. Non-metallic gears are most commonly used for the driving pinion of a pair of gears, with mating gear made of Cast Iron or Steel, where pitch line velocities exceed 1000 FPM and are not subjected to shock loads.

GEARS

20° Horsepower Ratings (Approximate)



For
Class I Service (Service Factor = 1.0)

10 Diametral Pitch

20° Pressure Angle

1¼" Face

No. Teeth	25 RPM		50 RPM		100 RPM		200 RPM		300 RPM		500 RPM		600 RPM		900 RPM		1200 RPM		1800 RPM	
	S	CI	S	CI	S	CI	S	CI	S	CI	S	CI	S	CI	S	CI	S	CI	S	CI
11	0.15		0.30		0.59		1.13		1.62		2.49		2.87		3.88		4.70		5.95	
12•	0.18		0.36		0.70		1.33		1.91		2.94		3.40		4.58		5.55		7.04	
13	0.21		0.42		0.81		1.55		2.23		3.43		3.97		5.35		6.48		8.22	
14•	0.24		0.47		0.91		1.75		2.51		3.87		4.47		6.02		7.30		9.25	
15•	0.27		0.53		1.03		1.96		2.82		4.34		5.01		6.76		8.19		10.38	
16•	0.29		0.57		1.12		2.14		3.07		4.72		5.45		7.36		8.91		11.30	
17	0.31		0.62		1.22		2.32		3.34		5.14		5.93		8.00		9.70		12.30	
18•	0.34		0.67		1.31		2.51		3.61		5.55		6.41		8.64		10.47		13.28	
19	0.37		0.72		1.41		2.70		3.88		5.97		6.89		9.30		11.27		14.29	
20•	0.39		0.78		1.52		2.90		4.16		6.40		7.40		9.98		12.09		15.33	
21	0.42		0.83		1.62		3.09		4.44		6.83		7.89		10.64		12.89		16.35	
22•	0.44		0.88		1.72		3.29		4.72		7.26		8.39		11.32		13.71		17.39	
24•	0.50		0.98		1.91		3.66		5.26		8.09		9.35		12.61		15.28		19.37	
25•	0.52		1.03		2.01		3.85		5.53		8.50		9.82		13.25		16.05		20.36	
26•	0.55		1.08		2.12		4.05		5.82		8.95		10.34		13.94		16.89			
27	0.58		1.14		2.22		4.25		6.11		9.40		10.86		14.65		17.75			
28•	0.60		1.19		2.33		4.46		6.41		9.86		11.39		15.37		18.61			
30•	0.66		1.30		2.54		4.86		6.99		10.74		12.41		16.74		20.28			
32•	0.71		1.41		2.76		5.27		7.58		11.65		13.46		18.16		22.00			
33	0.74		1.47		2.87		5.48		7.88		12.11		14.00		18.88		22.87			
35•	0.80		1.59		3.10		5.93		8.52		13.09		15.13		20.41		24.72			
36•	0.83		1.64		3.21		6.14		8.83		13.58		15.68		21.16		25.63			
40•	0.95		1.88		3.68		7.04		10.12		15.56		17.98		24.26					
42	1.01		2.00		3.91		7.47		10.74		16.51		19.07		25.73					
44	1.07		2.12		4.14		7.91		11.36		17.47		20.19		27.23					
45•	1.10		2.18		4.25		8.13		11.68		17.96		20.75		27.99					
48•	1.19		2.36		4.61		8.82		12.68		19.49		22.52		30.38					
50•	1.25		2.47		4.83		9.24		13.27		20.41		23.57							
52	1.31		2.59		5.06		9.68		13.90		21.38		24.70							
54	1.37		2.71		5.29		10.12		14.54		22.36		25.83							
55•	1.40		2.76		5.39		10.31		14.81		22.78		26.31							
56	1.42		2.82		5.50		10.52		15.12		23.25		26.86							
60•	1.55		3.06		5.98		11.44		16.43		25.27		29.19							
64		0.80		1.58		3.08		5.90		8.47		13.03		15.05						
66		0.83		1.63		3.19		6.11		8.78		13.50		15.60						
70•		0.88		1.75		3.41		6.53		9.38		14.42		16.66						
72		0.91		1.80		3.51		6.71		9.65		14.83		17.13						
80•		1.03		2.03		3.96		7.58		10.89		16.75								
84		1.08		2.14		4.19		8.01		11.52		17.71								
88		1.14		2.25		4.40		8.41		12.09		18.59								
90•		1.17		2.31		4.51		8.62		12.39		19.06								
96		1.25		2.48		4.84		9.26		13.31										
100•		1.31		2.59		5.06		9.67		13.90										
108		1.42		2.81		5.49		10.49		15.08										
110		1.45		2.87		5.60		10.71		15.39										
112		1.48		2.92		5.70		10.90		15.67										
120		1.59		3.15		6.15		11.76		16.90										
144		1.51		2.99		5.84		11.17		16.05										
160		2.16		4.27		8.35		15.96		22.93										
200		2.72		5.38		10.52		20.12		28.92										

Ratings are based on strength calculation.

• Designates stock sizes for this pitch.

Note: 1. Ratings to right of heavy line are not recommended, as pitch line velocity exceeds 1000 feet per minute. They should be used for interpolation purposes only.

2. Non-metallic gears are most commonly used for the driving pinion of a pair of gears, with mating gear made of Cast Iron or Steel, where pitch line velocities exceed 1000 FPM and are not subjected to shock loads.



20° Horsepower Ratings (Approximate)

For
Class I Service (Service Factor = 1.0)

12 Diametral Pitch

20° Pressure Angle

1" Face

No. Teeth	25 RPM		50 RPM		100 RPM		200 RPM		300 RPM		500 RPM		600 RPM		900 RPM		1200 RPM		1800 RPM	
	S	CI	S	CI	S	CI	S	CI	S	CI	S	CI	S	CI	S	CI	S	CI	S	CI
11	0.08		0.17		0.33		0.63		0.92		1.43		1.66		2.27		2.78		3.58	
12•	0.10		0.20		0.39		0.75		1.09		1.69		1.96		2.68		3.28		4.24	
13•	0.12		0.23		0.45		0.88		1.27		1.97		2.29		3.13		3.83		4.95	
14•	0.13		0.26		0.51		0.99		1.43		2.22		2.58		3.52		4.32		5.57	
15•	0.15		0.29		0.57		1.11		1.60		2.49		2.89		3.95		4.84		6.25	
16•	0.16		0.32		0.63		1.20		1.74		2.71		3.15		4.30		5.27		6.81	
17	0.18		0.35		0.68		1.31		1.90		2.95		3.42		4.68		5.74		7.40	
18•	0.19		0.37		0.73		1.42		2.05		3.18		3.70		5.06		6.19		7.99	
19•	0.20		0.40		0.79		1.52		2.20		3.43		3.98		5.44		6.67		8.60	
20•	0.22		0.43		0.85		1.63		2.36		3.68		4.27		5.84		7.15		9.23	
21•	0.23		0.46		0.90		1.74		2.52		3.92		4.55		6.22		7.63		9.84	
22•	0.25		0.49		0.96		1.85		2.68		4.17		4.84		6.62		8.11		10.47	
24•	0.28		0.55		1.07		2.06		2.99		4.64		5.39		7.38		9.04		11.66	
25•	0.29		0.57		1.13		2.17		3.14		4.88		5.67		7.75		9.50		12.26	
26•	0.31		0.60		1.19		2.28		3.30		5.14		5.96		8.16		9.99		12.90	
27	0.32		0.63		1.25		2.40		3.47		5.40		6.27		8.57		10.50		13.55	
28•	0.34		0.67		1.31		2.52		3.64		5.66		6.57		8.99		11.01		14.21	
30•	0.37		0.73		1.42		2.74		3.96		6.17		7.16		9.79		12.00		15.49	
32•	0.40		0.79		1.54		2.97		4.30		6.69		7.77		10.62		13.01			
33	0.41		0.82		1.61		3.09		4.47		6.95		8.08		11.05		13.53			
35	0.45		0.88		1.73		3.34		4.83		7.52		8.73		11.94		14.63			
36•	0.46		0.92		1.80		3.46		5.01		7.79		9.05		12.38		15.16			
40	0.53		1.05		2.06		3.97		5.74		8.94		10.38		14.19		17.39			
42•	0.56		1.12		2.19		4.21		6.09		9.48		11.01		15.05		18.44			
44	0.60		1.18		2.32		4.46		6.45		10.03		11.65		15.93		19.52			
45	0.61		1.21		2.38		4.58		6.63		10.31		11.97		16.37		20.06			
48•	0.66		1.32		2.58		4.97		7.19		11.19		13.00		17.77					
50	0.70		1.38		2.70		5.21		7.53		11.71		13.60		18.60					
52	0.73		1.44		2.83		5.45		7.89		12.27		14.25		19.49					
54•	0.76		1.51		2.96		5.71		8.25		12.84		14.91		20.39					
55	0.78		1.54		3.02		5.81		8.41		13.08		15.18		20.77					
56	0.79		1.57		3.08		5.93		8.58		13.35		15.50		21.19					
60•	0.86		1.71		3.35		6.45		9.33		14.51		16.84		23.04					
64	0.93		1.83		3.60		6.93		10.02		15.58		18.10		24.75					
66•	0.96		1.90		3.73		7.18		10.38		16.15		18.75							
70	1.02		2.03		3.98		7.66		11.09		17.24		20.03							
72•	1.05		2.09		4.09		7.88		11.40											
80		0.57		1.13		2.22		4.27		6.18		9.61		11.16						
84•		0.60		1.20		2.35		4.52		6.53		10.16		11.80						
88		0.63		1.26		2.46		4.74		6.86		10.67		12.39						
90		0.65		1.29		2.52		4.86		7.03		10.94								
96•		0.70		1.38		2.71		5.22		7.55		11.75								
100		0.73		1.44		2.83		5.45		7.89		12.27								
108•		0.79		1.57		3.07		5.91		8.55		13.31								
110		0.81		1.60		3.13		6.04		8.73		13.58								
112		0.82		1.63		3.19		6.15		8.89										
120•		0.89		1.76		3.44		6.63		9.59										
144•		0.84		1.67		3.27		6.30		9.11										
160		1.20		2.38		4.67		9.00		13.01										
200		1.52		3.00		5.89		11.34		16.41										

Ratings are based on strength calculation.

• Designates stock sizes for this pitch.

Note: 1. Ratings to right of heavy line are not recommended, as pitch line velocity exceeds 1000 feet per minute. They should be used for interpolation purposes only.

2. Non-metallic gears are most commonly used for the driving pinion of a pair of gears, with mating gear made of Cast Iron or Steel, where pitch line velocities exceed 1000 FPM and are not subjected to shock loads.

20° Horsepower Ratings (Approximate)



For
Class I Service (Service Factor = 1.0)

16 Diametral Pitch

20° Pressure Angle

3/4" Face

No. Teeth	25 RPM		50 RPM		100 RPM		200 RPM		300 RPM		500 RPM		600 RPM		900 RPM		1200 RPM		1800 RPM	
	S	CI	S	CI	S	CI	S	CI	S	CI	S	CI	S	CI	S	CI	S	CI	S	CI
11	0.04		0.07		0.14		0.27		0.40		0.63		0.73		1.02		1.28		1.69	
12•	0.04		0.08		0.17		0.32		0.47		0.74		0.87		1.21		1.51		2.00	
13•	0.05		0.10		0.19		0.38		0.55		0.87		1.01		1.41		1.76		2.33	
14•	0.06		0.11		0.22		0.42		0.62		0.98		1.14		1.59		1.98		2.63	
15•	0.06		0.12		0.24		0.48		0.69		1.10		1.28		1.79		2.22		2.95	
16•	0.07		0.14		0.27		0.52		0.76		1.19		1.40		1.94		2.42		3.21	
17•	0.07		0.15		0.29		0.56		0.82		1.30		1.52		2.12		2.63		3.49	
18•	0.08		0.16		0.31		0.61		0.89		1.40		1.64		2.28		2.84		3.77	
19	0.09		0.17		0.34		0.65		0.95		1.51		1.76		2.46		3.06		4.05	
20•	0.09		0.18		0.36		0.70		1.02		1.62		1.89		2.64		3.28		4.35	
21•	0.10		0.20		0.39		0.75		1.09		1.73		2.02		2.81		3.50		4.64	
22•	0.10		0.21		0.41		0.80		1.16		1.84		2.15		2.99		3.72		4.93	
24•	0.12		0.23		0.46		0.89		1.29		2.04		2.39		3.33		4.15		5.50	
25	0.12		0.24		0.48		0.93		1.36		2.15		2.51		3.50		4.36		5.78	
26•	0.13		0.26		0.50		0.98		1.43		2.26		2.64		3.69		4.59		6.08	
27	0.14		0.27		0.53		1.03		1.50		2.38		2.78		3.87		4.82		6.38	
28•	0.14		0.28		0.56		1.08		1.58		2.49		2.91		4.06		5.06		6.70	
30•	0.15		0.31		0.61		1.18		1.72		2.72		3.18		4.43		5.51		7.30	
32•	0.17		0.33		0.66		1.28		1.86		2.94		3.44		4.80		5.98		7.91	
33	0.17		0.35		0.68		1.33		1.94		3.06		3.58		4.99		6.21		8.23	
35	0.19		0.37		0.74		1.44		2.09		3.31		3.87		5.39		6.72		8.89	
36•	0.20		0.39		0.77		1.49		2.17		3.43		4.01		5.59		6.96		9.22	
40•	0.22		0.45		0.88		1.71		2.49		3.93		4.60		6.41		7.98		10.57	
42	0.24		0.47		0.93		1.81		2.64		4.17		4.88		6.80		8.47			
44	0.25		0.50		0.99		1.92		2.80		4.42		5.16		7.20		8.96			
45	0.26		0.51		1.01		1.97		2.87		4.54		5.31		7.40		9.21			
48•	0.28		0.56		1.10		2.14		3.12		4.93		5.76		8.03		10.00			
50	0.29		0.58		1.15		2.24		3.26		5.16		6.03		8.41		10.47			
52	0.31		0.61		1.21		2.34		3.42		5.40		6.32		8.81		10.96			
54	0.32		0.64		1.26		2.45		3.58		5.65		6.61		9.21		11.47			
55	0.33		0.65		1.29		2.50		3.64		5.76		6.73		9.38					
56•	0.34		0.67		1.31		2.55		3.72		5.88		6.87		9.58					
60•	0.36		0.72		1.43		2.77		4.04		6.39		7.47		10.41					
64•	0.39		0.78		1.53		2.98		4.34		6.86		8.02		11.18					
66	0.41		0.81		1.59		3.08		4.50		7.11		8.31		11.58					
70	0.43		0.86		1.70		3.29		4.81		7.59		8.88		12.37					
72•	0.45		0.88		1.74		3.39		4.94		7.81		9.13		12.73					
80•	0.50		1.00		1.97		3.83		5.58		8.82		10.31		14.37					
84•	0.53		1.06		2.08		4.05		5.90		9.32		10.90		15.19					
88•	0.56		1.11		2.19		4.25		6.20		9.79		11.45							
90	0.57		1.14		2.24		4.35		6.35		10.03		11.73							
96•	0.62		1.22		2.41		4.68		6.82		10.78		12.60							
100	0.64		1.27		2.51		4.88		7.12		11.25		13.16							
108		0.33		0.66		1.31		2.54		3.71		5.86		6.85						
110		0.34		0.68		1.34		2.60		3.79		5.98		6.99						
112•		0.35		0.69		1.36		2.64		3.85		6.09		7.12						
120		0.37		0.74		1.47		2.85		4.16		6.57		7.68						
144•		0.36		0.71		1.39		2.71		3.95		6.24								
160•		0.51		1.01		1.99		3.87		5.64		8.91								
200		0.64		1.27		2.51		4.88		7.11		11.24								

Ratings are based on strength calculation.

• Designates stock sizes for this pitch.

Note: 1. Ratings to right of heavy line are not recommended, as pitch line velocity exceeds 1000 feet per minute. They should be used for interpolation purposes only.

2. Non-metallic gears are most commonly used for the driving pinion of a pair of gears, with mating gear made of Cast Iron or Steel, where pitch line velocities exceed 1000 FPM and are not subjected to shock loads.



20° Horsepower Ratings (Approximate)

For
Class I Service (Service Factor = 1.0)

20 Diametral Pitch

20° Pressure Angle

½" Face

No. Teeth	25 RPM		50 RPM		100 RPM		200 RPM		300 RPM		500 RPM		600 RPM		900 RPM		1200 RPM		1800 RPM	
	S	CI	S	CI	S	CI	S	CI	S	CI	S	CI	S	CI	S	CI	S	CI	S	CI
11	0.02		0.03		0.06		0.12		0.17		0.28		0.32		0.46		0.57		0.78	
12•	0.02		0.04		0.07		0.14		0.20		0.33		0.38		0.54		0.68		0.92	
13	0.02		0.04		0.08		0.16		0.24		0.38		0.45		0.63		0.79		1.07	
14•	0.02		0.05		0.09		0.18		0.27		0.43		0.50		0.71		0.89		1.20	
15•	0.03		0.05		0.11		0.21		0.30		0.48		0.56		0.80		1.00		1.35	
16•	0.03		0.06		0.11		0.22		0.33		0.52		0.61		0.87		1.09		1.47	
17	0.03		0.06		0.12		0.24		0.36		0.57		0.67		0.94		1.19		1.60	
18•	0.03		0.07		0.13		0.26		0.38		0.61		0.72		1.02		1.28		1.73	
19	0.04		0.07		0.14		0.28		0.41		0.66		0.78		1.10		1.38		1.86	
20•	0.04		0.08		0.16		0.30		0.44		0.71		0.83		1.18		1.48		2.00	
21•	0.04		0.08		0.17		0.32		0.47		0.76		0.89		1.25		1.58		2.13	
22•	0.04		0.09		0.18		0.34		0.50		0.80		0.94		1.33		1.68		2.26	
24•	0.05		0.10		0.20		0.38		0.56		0.90		1.05		1.49		1.87		2.52	
25•	0.05		0.10		0.21		0.40		0.59		0.94		1.11		1.56		1.96		2.65	
26	0.06		0.11		0.22		0.42		0.62		0.99		1.16		1.64		2.07		2.79	
27	0.06		0.12		0.23		0.44		0.65		1.04		1.22		1.73		2.17		2.93	
28•	0.06		0.12		0.24		0.47		0.68		1.09		1.28		1.81		2.28		3.07	
30•	0.07		0.13		0.26		0.51		0.75		1.19		1.40		1.97		2.48		3.35	
32•	0.07		0.14		0.28		0.55		0.81		1.29		1.52		2.14		2.69		3.63	
33	0.07		0.15		0.29		0.57		0.84		1.34		1.58		2.22		2.80		3.78	
35•	0.08		0.16		0.32		0.62		0.91		1.45		1.70		2.40		3.03		4.08	
36•	0.08		0.17		0.33		0.64		0.94		1.50		1.77		2.49		3.14		4.23	
40•	0.10		0.19		0.38		0.74		1.08		1.72		2.02		2.86		3.60		4.85	
42	0.10		0.20		0.40		0.78		1.15		1.83		2.15		3.03		3.81		5.15	
44	0.11		0.21		0.42		0.83		1.21		1.93		2.27		3.21		4.04		5.45	
45•	0.11		0.22		0.44		0.85		1.25		1.99		2.34		3.30		4.15		5.60	
48	0.12		0.24		0.47		0.92		1.35		2.16		2.54		3.58		4.50		6.08	
50•	0.13		0.25		0.49		0.97		1.42		2.26		2.65		3.75		4.71		6.36	
52	0.13		0.26		0.52		1.01		1.48		2.37		2.78		3.92		4.94		6.66	
54	0.14		0.27		0.54		1.06		1.55		2.48		2.91		4.10		5.17			
55	0.14		0.28		0.55		1.08		1.58		2.52		2.96		4.18		5.26			
56	0.14		0.28		0.56		1.10		1.61		2.57		3.02		4.27		5.37			
60•	0.16		0.31		0.61		1.20		1.75		2.80		3.29		4.64		5.84			
64	0.17		0.33		0.66		1.28		1.88		3.01		3.53		4.98		6.27			
66	0.17		0.34		0.68		1.33		1.95		3.11		3.66		5.16		6.50			
70•	0.19		0.37		0.73		1.42		2.08		3.33		3.91		5.51		6.94			
72•	0.19		0.38		0.75		1.46		2.14		3.42		4.02		5.67		7.14			
80•	0.22		0.43		0.85		1.65		2.42		3.86		4.54		6.40					
84•	0.23		0.45		0.89		1.75		2.56		4.08		4.80		6.77					
88	0.24		0.47		0.94		1.83		2.69		4.29		5.04		7.11					
90•	0.24		0.49		0.96		1.88		2.76		4.40		5.16		7.29					
96•	0.26		0.52		1.03		2.02		2.96		4.72		5.55		7.83					
100•	0.27		0.55		1.08		2.11		3.09		4.93		5.79		8.17					
108	0.30		0.59		1.17		2.29		3.35		5.35		6.28							
110	0.30		0.60		1.19		2.33		3.42		5.46		6.41							
112	0.31		0.62		1.22		2.38		3.48		5.56		6.53							
120•	0.33		0.66		1.31		2.56		3.76		5.99		7.04							
144	0.32		0.63		1.25		2.43		3.57		5.69		6.69							
160	0.45		0.90		1.78		3.48		5.10		8.13		9.56							
200	0.57		1.14		2.24		4.38		6.43		10.26		12.05							

Ratings are based on strength calculation.

• Designates stock sizes for this pitch.

Note: 1. Ratings to right of heavy line are not recommended, as pitch line velocity exceeds 1000 feet per minute. They should be used for interpolation purposes only.

2. Non-metallic gears are most commonly used for the driving pinion of a pair of gears, with mating gear made of Cast Iron or Steel, where pitch line velocities exceed 1000 FPM and are not subjected to shock loads.

Machined Gear Rack

Standard Face Width Steel — 14½° & 20° Pressure Angle

Catalog Number		Pitch	Face Width (Inches)	Overall Thickness (Inches)	Pitch Line Backing	App. Weight Lbs./Pc
14½° P.A.	20° P.A.					
R3x2	TR3x2	3	3	1½	1.167	24.0
R3x4	TR3x4	3	3	1½	1.167	48.0
R3x6	TR3x6	3	3	1½	1.167	72.0
R4x2	TR4x2	4	2	1½	1.250	17.4
R4x4	TR4x4	4	2	1½	1.250	34.8
R4x6	TR4x6	4	2	1½	1.250	52.2
RA4x2		4	2	2	1.750	23.6
RA4x4		4	2	2	1.750	47.2
RA4x6		4	2	2	1.750	70.8
R5x2	TR5x2	5	1½	1½	1.050	12.8
R5x4	TR5x4	5	1½	1½	1.050	25.6
R5x6	TR5x6	5	1½	1½	1.050	38.4
RA5x2		5	1½	1½	1.300	16.0
RA5x4		5	1½	1½	1.300	32.0
RA5x6		5	1½	1½	1.300	48.0
R6x2		6	1½	1	.833	8.6
R6x4		6	1½	1	.833	17.2
R6x6		6	1½	1	.833	25.8
RA6x2	TR6x2	6	1½	1½	1.333	13.8
RA6x4	TR6x4	6	1½	1½	1.333	27.6
RA6x6	TR6x6	6	1½	1½	1.333	41.4
R8x2		8	1½	¾	.625	5.2
R8x4		8	1½	¾	.625	10.4
R8x6		8	1½	¾	.625	15.6
RA8x2	TR8x2	8	1½	1½	1.125	9.8
RA8x4	TR8x4	8	1½	1½	1.125	19.6
RA8x6	TR8x6	8	1½	1½	1.125	29.4
R10x2		10	1	¾	.525	3.6
R10x4		10	1	¾	.525	7.2
R10x6		10	1	¾	.525	10.8
RA10x2	TR10x2	10	1	1	.900	6.0
RA10x4	TR10x4	10	1	1	.900	12.0
RA10x6	TR10x6	10	1	1	.900	18.0
R12x2		12	¾	½	.417	2.0
R12x4		12	¾	½	.417	4.0
R12x6		12	¾	½	.417	6.0
RA12x2	TR12x2	12	¾	¾	.667	3.4
RA12x4	TR12x4	12	¾	¾	.667	6.8
RA12x6	TR12x6	12	¾	¾	.667	10.2
R16x2		16	⅝	⅝	.250	.50
R16x4		16	⅝	⅝	.250	1.00
R16x6		16	⅝	⅝	.250	1.50
RA16x2	TR16x2	16	½	½	.438	1.52
RA16x4	TR16x4	16	½	½	.438	3.04
RA16x6	TR16x6	16	½	½	.438	4.56
R20x2	TR20x2	20	¾	¾	.325	.84
R20x4	TR20x4	20	¾	¾	.325	1.68
R20x6	TR20x6	20	¾	¾	.325	2.52
R24x2		24	¾	¾	.208	.38
R24x4		24	¾	¾	.208	.76
R24x6		24	¾	¾	.208	1.14

Martin Rack is made from low carbon cold drawn steel. It is available in 14½° and 20° pressure angle in 2, 4, and 6 foot lengths. Allowance is made for cutting and machining. Pinions to run with the rack may be selected from the Spur Gear section of the catalog. Special rack can be supplied in other materials, sizes, and pitches.

Wide Face Width Steel — 20° Pressure Angle

Catalog Number	Pitch	Face Width (Inches)	Overall Thickness (Inches)	Pitch Line Backing	App. Weight Lbs./Pc
R204x2	4	3½	2	1.750	41.0
R204x4	4	3½	2	1.750	82.0
R204x6	4	3½	2	1.750	123.0
R205x2	5	2½	1½	1.300	22.4
R205x4	5	2½	1½	1.300	44.8
R205x6	5	2½	1½	1.300	67.2
R206x2	6	2	1½	1.333	17.0
R206x4	6	2	1½	1.333	34.0
R206x6	6	2	1½	1.333	51.0
R208x2	8	1½	1½	1.375	13.8
R208x4	8	1½	1½	1.375	27.6
R208x6	8	1½	1½	1.375	41.3
R2010x2	10	1¼	1¼	1.150	9.0
R2010x4	10	1¼	1¼	1.150	18.0
R2010x6	10	1¼	1¼	1.150	27.0
R2012x2	12	1	1	.917	6.4
R2012x4	12	1	1	.917	12.8
R2012x6	12	1	1	.917	19.2
R2016x2	16	¾	¾	.688	3.4
R2016x4	16	¾	¾	.688	6.8
R2016x6	16	¾	¾	.688	10.2
R2020x2	20	½	½	.450	.8
R2020x4	20	½	½	.450	1.6
R2020x6	20	½	½	.450	2.5

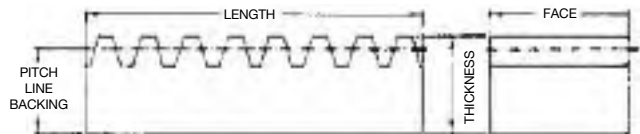

Martin Stocks
14½° Spur Gears.
&
20° Spur Gears

Bevel Gears 20° Pressure Angle

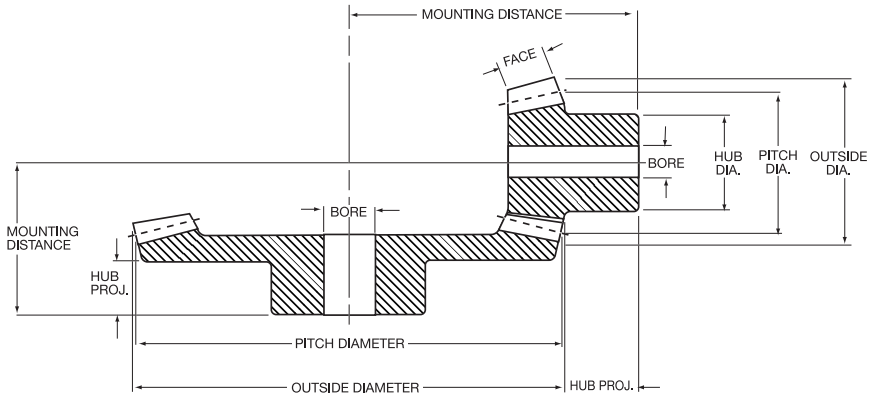

Bevel Gears are used as right angle drives where high efficiency is required. They are carried in stock as 1:1 to 6:1 ratios. Bevel Gears are cut with the long and short addendum system and 20 degree pressure angle to compensate for tooth undercut in gears and pinions having low numbers of teeth. Most all of *Martin* Bevel Gears are cut with the Coniflex tooth form to

allow for a slight misalignment at assembly and during operation. Gears should be mounted at the correct distance from the core of apex center with thrust bearings being used in back of hubs to absorb the backward thrust created in this type of gearing.

Cast Iron Gears With Steel Pinions

Number Teeth	Catalog Number	Diameter		Face (Inches)	Bore (Inches)		Mounting (Inches)	Hub (Inches)		Wt. Lbs. (App.)
		Pitch	Outside		Diameter	Length		Diameter	Proj. (App.)	

3 Pitch

30	B330-2	10.00	10.19	1.87	1 1/4	3 1/2	5 1/2	5	2	32.8
15	B315-2	5.00	5.80	1.87	1 1/4	4 1/2	7 1/4	3 3/4	1 1/8	13.4

4 Pitch

32	B432-2	8.00	8.10	1.40	1 1/8	2 1/16	4 1/4	3 3/4	1 1/16	14.7
16	B416-2	4.00	4.60	1.40	1 1/8	3 1/2	6	3 1/4	1 1/16	7.5
42	B442-3	10.50	10.59	1.42	1 1/8	2 1/16	4	3 3/4	1 1/2	20.5
14	B414-3	3.50	4.17	1.42	1 1/8	3 5/8	7 1/4	3 3/4	1 1/16	6.8
56	B456-4	14.00	14.07	1.69	1 1/4	2 1/8	4 1/4	4 1/4	1 1/8	37.8
14	B414-4	3.50	4.20	1.69	1 1/4	3 5/8	9	3 3/4	1 1/16	7.6

5 Pitch

30	B530-2	6.00	6.12	1.04	1 1/8	2 1/4	3 1/2	3 1/4	1 1/8	8.6
15	B515-2	3.00	3.48	1.04	1	2 3/8	4 3/8	2 1/2	1 1/2	3.1
45	B545-3	9.00	9.07	1.31	1 1/4	2 1/8	3 3/4	3 3/4	1 1/16	14.6
15	B515-3	3.00	3.54	1.31	1	2 1/16	5 1/8	2 5/8	1 1/16	3.6
60	B560-4	12.00	12.05	1.70	1 1/4	2 1/8	3 3/4	4	1 1/8	23.2
15	B515-4	3.00	3.56	1.70	1	3 3/8	7 1/2	3	1 1/16	5.0

6 Pitch

36	BS636-2	6.00	6.10	1.06	1 1/8	2 1/4	3 1/2	3 3/4	1 1/2	7.5
18	B618-2	3.00	3.42	1.06	1	2 3/8	4 3/8	2 1/2	1 1/2	3.3
42	B642-2	7.00	7.10	1.05	1 1/8	2 3/8	3 3/4	3 1/2	1 1/2	9.5
21	B621-2	3.50	3.90	1.05	1	2 3/8	5	2 1/2	1 1/4	3.8
45	B645-3	7.50	7.56	1.07	1 1/8	2 1/8	3	3 1/4	1 1/4	8.9
15	B615-3	2.50	2.94	1.07	3/8	2 1/16	5 1/4	2 1/8	1 1/16	2.2
48	B648-2	8.00	8.10	1.17	1 1/8	1 5/8	3 1/16	3 1/4	1	11.6
24	B624-2	4.00	4.40	1.17	1	2 3/8	5 1/8	2 1/8	1 1/4	4.9
60	B660-4	10.00	10.04	1.21	1 1/8	2 1/4	3 3/4	3 3/4	1 1/8	14.3
15	B615-4	2.50	2.97	1.21	1	2 1/2	6 3/4	2 1/2	1 3/8	3.2

Steel Bevel Gears may be furnished with hardened teeth at slight additional cost.

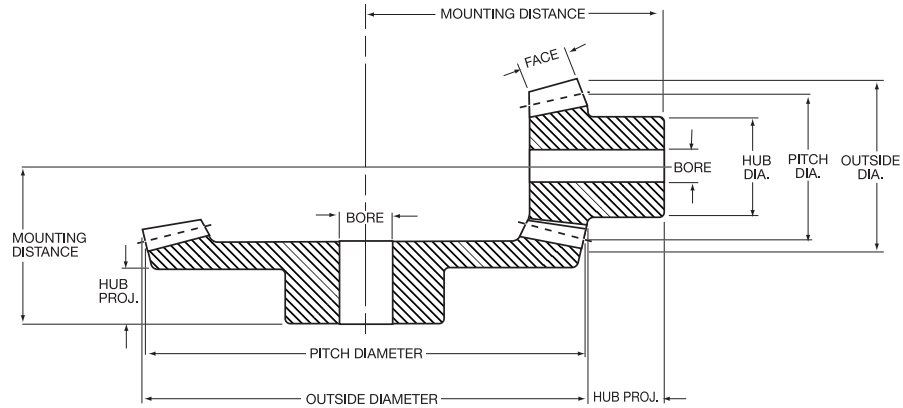

Cast Iron Gears With Steel Pinions

Number Teeth	Catalog Number	Diameter		Face (Inches)	Bore (Inches)		Mounting (Inches)	Hub (Inches)		Wt. Lbs. (App.)
		Pitch	Outside		Diameter	Length		Diameter	Proj. (App.)	

8 Pitch

40	BS840-2	5.00	5.07	.82	1	1 ² / ₃₂	2 ⁷ / ₈	3	1 ¹ / ₄	4.9
20	B820-2	2.50	2.80	.82	⁷ / ₈	2 ⁵ / ₃₂	4	2 ¹ / ₈	1 ¹ / ₃₂	1.9
48	B848-3	6.05	6.20	.84	⁷ / ₈	1 ¹ / ₈	2 ³ / ₈	2 ³ / ₈	1	4.5
16	B816-3	2.00	2.33	.84	³ / ₄	2 ³ / ₆₄	4 ¹ / ₄	1 ¹ / ₈	1 ¹ / ₁₆	1.2
64	B864-4	8.00	8.03	.84	1	1 ¹ / ₈	2 ³ / ₈	2 ³ / ₈	1 ¹ / ₄	9.0
16	B816-4	2.00	2.35	.84	⁷ / ₈	2 ⁵ / ₃₂	5 ¹ / ₄	1 ¹ / ₈	1 ¹ / ₃₂	1.3
72	B872-4	9.00	9.03	1.22	1 ¹ / ₈	2 ⁵ / ₁₆	3 ¹ / ₄	3	1 ¹ / ₁₆	12.2
18	B818-4	2.25	2.60	1.22	⁷ / ₈	2 ⁵ / ₃₂	5 ¹ / ₄	2 ¹ / ₈	1 ¹ / ₃₂	1.9

10 Pitch

60	B1060-3	6.00	6.04	.78	⁷ / ₈	1 ² / ₃₂	2 ³ / ₈	3	1 ³ / ₈	5.1
20	B1020-3	2.00	2.27	.78	³ / ₄	2 ⁵ / ₃₂	4 ³ / ₈	1 ¹ / ₄	1 ¹ / ₁₆	1.3
60	B1060-4	6.00	6.03	.72	⁷ / ₈	1 ¹ / ₈	2 ¹ / ₄	2 ¹ / ₈	1 ¹ / ₈	4.5
15	B1015-4	1.50	1.78	.72	⁵ / ₈	1 ³ / ₆₄	3 ³ / ₈	1 ¹ / ₁₆	2 ⁷ / ₃₂	.6
90	B1090-6	9.00	9.03	.86	1	1 ¹ / ₁₆	2 ¹ / ₂	2 ³ / ₈	1 ¹ / ₁₆	9.7
15	B1015-6	1.50	1.79	.86	⁵ / ₈	1 ⁵ / ₆₄	5 ¹ / ₂	1 ¹ / ₁₆	3 ¹ / ₃₂	.7

12 Pitch

36	B1236-2	3.00	3.05	.46	⁵ / ₈	⁷ / ₈	1 ¹ / ₂	1 ¹ / ₁₆	¹ / ₂	.8
18	B1218-2	1.50	1.70	.46	¹ / ₂	1 ³ / ₆₄	2 ¹ / ₄	1 ¹ / ₄	1 ¹ / ₁₆	.5
72	B1272-4	6.00	6.02	.60	³ / ₄	1 ¹ / ₁₆	2	2	8 ¹ / ₆₄	2.6
18	B1218-4	1.50	1.73	.60	¹ / ₂	1 ³ / ₆₄	3 ³ / ₈	1 ¹ / ₄	23 ³ / ₃₂	.4
72	B1272-6	6.00	6.02	.74	³ / ₄	1 ¹ / ₁₆	1 ¹ / ₄	2	8 ¹ / ₆₄	2.6
12	B1212-6	1.00	1.24	.74	¹ / ₂	1 ³ / ₆₄	3 ³ / ₈	1 ⁵ / ₁₆	23 ³ / ₃₂	.4

Steel Bevel Gears may be furnished with hardened teeth at slight additional cost.

Bevel Gears

20° Pressure Angle

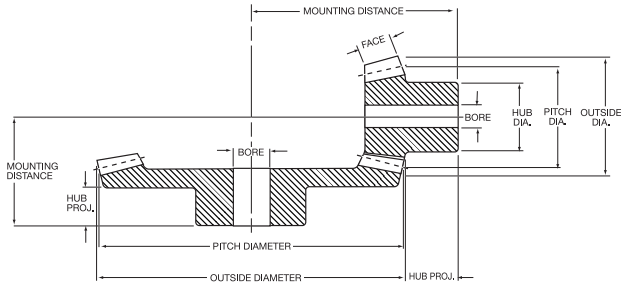

Steel Gears With Steel Pinions

Number Teeth	Catalog Number	Diameter		Face (Inches)	Bore (Inches)		Mounting (Inches)	Hub (Inches)		Wt. Lbs. (App.)
		Pitch	Outside		Diameter	Length		Diameter	Proj. (App.)	

6 Pitch

36	BS636-2	6.00	6.10	1.06	1 1/8	2 1/4	3 1/2	3 3/4	1 1/2	8.7
18	BS618-2	3.00	3.42	1.06	1 1/8	2 3/4	4%	2 1/2	1 1/2	3.2

8 Pitch

40	BS840-2	5.00	5.07	.82	1	1 7/8	2 1/2	3	1 1/4	4.9
20	BS820-2	2.50	2.80	.82	1	2 1/2	4	2 1/2	1 1/2	1.8

10 Pitch

30	BS1030-15	3.00	3.08	.57	3/4	1 1/8	2 1/4	2 1/2	1	2.0
20	BS1020-15	2.00	2.21	.57	3/4	1 3/4	2 1/2	1 3/4	29/32	.8
40	BS1040-2	4.00	4.06	.71	7/8	1 1/2	2 1/2	3	1 1/8	3.7
20	BS1020-2	2.00	2.24	.71	3/4	1 5/4	3 1/2	1 3/4	1 1/8	1.0
50	BS1050-2	5.00	5.06	.70	3/4	1 1/2	2%	2	1	4.0
25	B1025-2	2.50	2.74	.70	3/4	1 3/4	3%	2	3/4	1.5
60	BS1060-3	6.00	6.04	.78	1	1 3/4	2%	3	1%	6.0
20	BS1020-3	2.00	2.27	.78	3/4	2 1/2	4%	1 3/4	1 1/8	.9

12 Pitch

27	BS1227-15	2.25	2.32	.41	1/2	1 1/8	1%	1 1/2	25/32	.6
18	BS1218-15	1.50	1.67	.41	1/2	1 1/8	1%	1 1/4	21/32	.3
36	BS1236-2	3.00	3.05	.53	1	1 1/4	1%	2 1/2	7/8	1.3
18	BS1218-2	1.50	1.70	.53	3/4	1%	2%	1 1/8	13/16	.3
36	BS1236-2A	3.00	3.05	.53	5/8	1 1/4	1%	2 1/2	7/8	1.4
18	BS1218-2A	1.50	1.70	.53	1/2	1%	2%	1 1/8	13/16	.4
48	BS1248-2	4.00	4.05	.59	5/8	1 1/4	2	1%	3/4	1.6
24	B1224-2	2.00	2.20	.59	1/2	1 1/8	2 1/2	1 1/2	3/4	.8
54	BS1254-3	4.50	4.53	.60	5/8	1 1/8	1%	1%	3/4	1.9
18	B1218-3	1.50	1.72	.60	1/2	1 1/2	3	1 1/4	1 1/8	.4

14 Pitch

28	BS1428-2	2.00	2.04	.35	1/2	15/16	1%	1 1/2	21/32	.5
14	BS1414-2	1.00	1.17	.35	1/2	31/32	1%	1 3/16	9/16	.1

16 Pitch

24	BS1624-2	1.50	1.54	.19	1/2	5/8	1	1	7/16	.15
12	BS1612-2	.75	.91	.19	3/8	37/64	1 1/8	2 1/2	1 1/2	.08
24	BS1624-15	1.50	1.55	.25	1/2	3/4	1 1/8	1 1/8	9/16	.40
16	BS1616-15	1.00	1.13	.25	3/8	47/64	1 1/4	1 3/8	7/16	.09
32	BS1632-2	2.00	2.04	.35	1/2	49/64	1 1/8	1 1/8	1/2	.30
16	BS1616-2	1.00	1.15	.35	3/8	27/32	1 1/2	1 3/8	7/16	.04
48	BS1648-3	3.00	3.02	.42	5/8	7/8	1 1/8	1 1/2	9/16	.74
16	B1616-3	1.00	1.17	.42	7/16	59/64	2	7/8	15/32	.13
64	BS1664-4	4.00	4.02	.48	5/8	57/64	1 3/8	2 1/4	9/16	1.7
16	B1616-4	1.00	1.17	.48	1/2	63/64	2 1/2	1 3/8	15/32	.12

Steel Bevel Gears may be furnished with hardened teeth at slight additional cost.



Bevel Gears Horsepower Ratings

Cast Iron

Catalog Number	Revolutions per Minute							
	50	100	200	300	600	900	1200	1800
B330-2	2.5	4.5	7.7	10.0	15.3			
B315-2	2.5	4.5	7.7	10.0	15.3			
B432-2	1.33	2.3	4.0	5.3	8.0	9.5		
B416-2	1.33	2.3	4.0	5.3	8.0	9.5		
B442-3	1.10	2.0	3.7	5.0	7.5	9.0		
B414-3	1.10	2.0	3.7	5.0	7.5	9.0		
B456-4	1.4	2.5	4.4	6.0	9.0	10.9		
B414-4	1.4	2.5	4.4	6.0	9.0	10.9		
B530-2	.5	1.0	1.9	2.5	3.9	4.8	5.5	
B515-2	.5	1.0	1.9	2.5	3.9	4.8	5.5	
B545-3	.7	1.4	2.4	3.3	5.2	6.4	7.2	
B515-3	.7	1.4	2.4	3.3	5.2	6.4	7.2	
B560-4	1.0	1.8	3.3	4.4	6.9	8.4	9.5	
B515-4	1.0	1.8	3.3	4.4	6.9	8.4	9.5	
B636-2	.5	1.0	1.7	2.3	3.7	4.4	5.0	
B618-2	.5	1.0	1.7	2.3	3.7	4.4	5.0	
B642-2	.6	1.1	2.0	2.7	4.0	5.0		
B621-2	.6	1.1	2.0	2.7	4.0	5.0		
B645-3	.4	.8	1.4	2.0	3.2	3.9	4.6	
B615-3	.4	.8	1.4	2.0	3.2	3.9	4.6	
B648-2	.8	1.5	2.5	3.4	5.1	6.1		
B624-2	.8	1.5	2.5	3.4	5.1	6.1		
B660-4	.5	.9	1.7	2.3	3.7	4.6	5.2	
B615-4	.5	.9	1.7	2.3	3.7	4.6	5.2	
B840-2	.4	.7	1.3	1.8	2.9	3.7	4.2	
B820-2	.4	.7	1.3	1.8	2.9	3.7	4.2	
B848-3	.2	.4	.7	1.0	1.7	2.2	2.5	2.9
B816-3	.2	.4	.7	1.0	1.7	2.2	2.5	2.9
B864-4	.2	.4	.7	1.0	1.7	2.2	2.5	
B816-4	.2	.4	.7	1.0	1.7	2.2	2.5	
B872-4	.4	.7	1.2	1.8	2.8	3.6	4.2	
B818-4	.4	.7	1.2	1.8	2.8	3.6	4.2	
B1060-3	.17	.3	.6	.8	1.3	1.7	1.9	2.3
B1020-3	.17	.3	.6	.8	1.3	1.7	1.9	2.3
B1060-4	.1	.2	.4	.5	.9	1.2	1.4	1.8
B1015-4	.1	.2	.4	.5	.9	1.2	1.4	1.8
B1090-6	.14	.25	.5	.7	1.2	1.7	1.9	2.3
B1015-6	.14	.25	.5	.7	1.2	1.7	1.9	2.3
B1236-2	.05	.11	.2	.3	.5	.6	.8	1.0
B1218-2	.05	.11	.2	.3	.5	.6	.8	1.0
B1254-3	.07	.15	.3	.4	.7	.9	1.0	1.3
B1218-3	.07	.15	.3	.4	.7	.9	1.0	1.3
B1272-4	.07	.15	.3	.4	.7	.9	1.1	1.4
B1218-4	.07	.15	.3	.4	.7	.9	1.1	1.4
B1272-6	.06	.11	.2	.3	.6	.8	1.0	1.2
B1212-6	.06	.11	.2	.3	.6	.8	1.0	1.2

Steel

Catalog Number	Revolutions per Minute							
	50	100	200	300	600	900	1200	1800
BS636-2	.9	1.7	3.0	4.1	6.4	8.0	9.0	
BS618-2	.9	1.7	3.0	4.1	6.4	8.0	9.0	
BS840-2	.5	.9	1.5	2.1	3.5	4.4	5.0	
BS820-2	.5	.9	1.5	2.1	3.5	4.4	5.0	
BS1030-15	.2	.4	.7	1.0	1.7	2.1	2.3	2.9
BS1020-15	.2	.4	.7	1.0	1.7	2.1	2.3	2.9
BS1040-2	.25	.5	.9	1.3	2.1	2.7	3.0	3.7
BS1020-2	.25	.5	.9	1.3	2.1	2.7	3.0	3.7
BS1050-2	.33	.64	1.2	1.6	2.5	3.2	3.7	
B 1025-2	.33	.64	1.2	1.6	2.5	3.2	3.7	
BS1060-3	.3	.5	1.0	1.4	2.4	3.0	3.5	4.3
BS1020-3	.3	.5	1.0	1.4	2.4	3.0	3.5	4.3
BS1227-15	.09	.17	.33	.5	.8	1.0	1.2	1.6
BS1218-15	.09	.17	.33	.5	.8	1.0	1.2	1.6
BS1236-2	.12	.25	.4	.6	1.0	1.4	1.7	2.0
BS1218-2	.12	.25	.4	.6	1.0	1.4	1.7	2.0
BS1236-2A	.12	.25	.4	.6	1.0	1.4	1.7	2.0
BS1218-2A	.12	.25	.4	.6	1.0	1.4	1.7	2.0
BS1248-2	.18	.37	.7	.9	1.6	2.0	2.3	2.8
B1224-2	.18	.37	.7	.9	1.6	2.0	2.3	2.8
BS1254-3	.14	.28	.5	.7	1.2	1.6	1.9	2.3
B1218-3	.14	.28	.5	.7	1.2	1.6	1.9	2.3
BS1428-2	.05	.08	.16	.20	.40	.54	.7	.8
BS1414-2	.05	.08	.16	.20	.40	.54	.7	.8
BS1624-2	.02	.03	.05	.08	.14	.20	.25	.3
BS1612-2	.02	.03	.05	.08	.14	.20	.25	.3
BS1624-15	.03	.05	.09	.14	.25	.33	.4	.5
BS1612-15	.03	.05	.09	.14	.25	.33	.4	.5
BS1632-2	.03	.08	.14	.20	.37	.5	.6	.8
BS1616-2	.03	.08	.14	.20	.37	.5	.6	.8
BS1648-3	.05	.09	.17	.25	.50	.6	.8	1.0
BS1616-3	.05	.09	.17	.25	.50	.6	.8	1.0
BS1664-4	.05	.10	.20	.33	.50	.7	.9	1.1
BS1616-4	.05	.10	.20	.33	.50	.7	.9	1.1

Miter Gears

20° Pressure Angle

Martin



Miter Gears are ordinarily used as right angle drives, transmitting horsepower between intersecting shafts at a 1:1 ratio. They are used where high efficiency is required. Only miters of the same number of teeth, pitch, and pressure angle can be operated together. More than two miters may be used in sets, as in a differential.

The thrust of Miter Gears causes the gears to separate; therefore, ball bearings or roller bearings should be used rather than sleeve bearings. Provisions should be made using thrust bearings to absorb backward thrust.

All standard stock Miter Gears must be mounted at right angles (90 degrees) for proper tooth bearing.

All *Martin* Miter and Bevel Gears are generated with the Coniflex tooth form. A slight misalignment of gears is permissible because of the localized tooth bearing running lengthwise along the gear tooth.

The mounting distance must be held in order to maintain proper backlash between gears. This will also insure that the ends of the gear teeth will be flush with each other. The use of a straight mineral oil as a lubricant is recommended for most Miter Gear applications.

Martin Stock Miter Gears are manufactured from .40 carbon steel.

The "M" Series is furnished unhardened with plain bore. The "HM" Series is furnished hardened teeth with plain bore. The "HMK" Series is furnished hardened teeth with keyway and setscrew for installation on the shaft.

Hardened Miter Gears have approximately 50% more horsepower capacity and provide greater gear wear than untreated gears.

All *Martin* Miter Gears are cut with the 20° pressure angle system. They will not operate with any other pressure angle system.

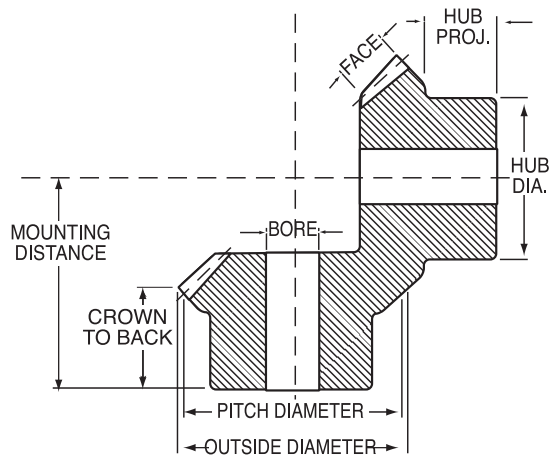

Steel - Plain Bore — Unhardened Teeth

Number Teeth	Catalog Number	Diameter		Face (Inches)	Bore (Inches)		Mounting (Inches)	Hub (Inches)		Wt. Lbs. (App.)
		Pitch	Outside		Diameter	Length		Diameter	Proj. (App.)	

4 Pitch

24	M424	6.00	6.36	1.33	1½	3 ³ / ₁₆	5½	4	1 ¹ / ₁₆	14.4
24	M424A	6.00	6.36	1.33	1½	3 ³ / ₁₆	5½	4	1 ¹ / ₁₆	13.7
28	M428	7.00	7.36	1.43	2	3 ³ / ₁₆	6	5	1 ¹ / ₁₆	21.1

5 Pitch

25	M525	5.00	5.29	1.10	1½	3	4 ⁵ / ₁₆	3½	1 ³ / ₁₆	8.5
25	M525A	5.00	5.29	1.10	1½	3	4 ⁵ / ₁₆	3½	1 ³ / ₁₆	8.3
25	M525B	5.00	5.29	1.10	1½	3	4 ⁵ / ₁₆	3½	1 ³ / ₁₆	7.8

6 Pitch

24	M624	4.00	4.24	.86	1½	2 ⁷ / ₁₆	3 ³ / ₁₆	3	1 ¹ / ₁₆	4.4
24	M624A	4.00	4.24	.86	1½	2 ⁷ / ₁₆	3 ³ / ₁₆	3	1 ¹ / ₁₆	4.3
27	M627	4.50	4.74	.96	1½	2 ⁷ / ₁₆	4 ¹ / ₁₆	3½	1½	6.3
27	M627A	4.50	4.74	.96	1½	2 ⁷ / ₁₆	4 ¹ / ₁₆	3½	1½	5.9

8 Pitch

24	M824	3.00	3.18	.64	¾	1 ³ / ₁₆	2 ¹ / ₁₆	1¾	1 ³ / ₁₆	1.5
24	M824A	3.00	3.18	.64	1	1 ³ / ₁₆	2 ¹ / ₁₆	2½	1	2.1
24	M824B	3.00	3.18	.64	1	1 ³ / ₁₆	2 ¹ / ₁₆	2½	1	1.9
28	M828	3.50	3.68	.75	1	2 ¹ / ₁₆	3 ¹ / ₁₆	2½	1¼	2.9
28	M828A	3.50	3.68	.75	1 ¹ / ₁₆	2 ¹ / ₁₆	3 ¹ / ₁₆	2½	1¼	2.8
28	M828B	3.50	3.68	.75	1¼	2 ¹ / ₁₆	3 ¹ / ₁₆	2½	1¼	2.6
32	M832	4.00	4.18	.84	1	2 ¹ / ₁₆	3 ¹ / ₁₆	3	1½	4.8

10 Pitch

20	M1020A	2.00	2.14	.44	½	1 ³ / ₁₆	2	1 ³ / ₁₆	1 ³ / ₁₆	.75
20	M1020B	2.00	2.14	.44	5 ¹ / ₁₆	1 ³ / ₁₆	2	1 ³ / ₁₆	1 ³ / ₁₆	.72
20	M1020	2.00	2.14	.44	¾	1 ³ / ₁₆	2	1 ³ / ₁₆	1 ³ / ₁₆	.67
20	M1020C	2.00	2.14	.44	7 ¹ / ₁₆	1 ³ / ₁₆	2	1 ³ / ₁₆	1 ³ / ₁₆	.58
25	M1025	2.50	2.64	.55	¾	1 ³ / ₁₆	2 ¹ / ₁₆	2	1 ⁵ / ₁₆	1.2
25	M1025A	2.50	2.64	.55	7 ¹ / ₁₆	1 ³ / ₁₆	2 ¹ / ₁₆	2	1 ⁵ / ₁₆	1.2
25	M1025B	2.50	2.64	.55	1	1 ³ / ₁₆	2 ¹ / ₁₆	2	1 ⁵ / ₁₆	1.2
30	M1030	3.00	3.14	.64	¾	1 ³ / ₁₆	2 ¹ / ₁₆	2	1	1.8

Miter Gears

20° Pressure Angle

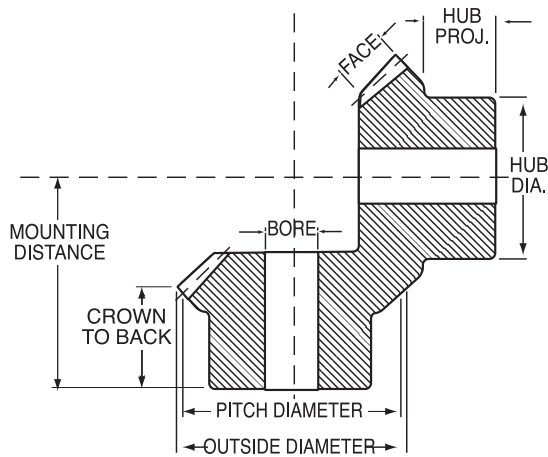

Steel - Plain Bore — Unhardened Teeth

Number Teeth	Catalog Number	Diameter		Face (Inches)	Bore (Inches)		Mounting (Inches)	Hub (Inches)		Wt. Lbs. (App.)
		Pitch	Outside		Diameter	Length		Diameter	Proj. (App.)	

12 Pitch

15	M1215	1.25	1.37	.27	$\frac{3}{8}$	$\frac{55}{64}$	$1\frac{1}{4}$	1	$\frac{1}{2}$.17
15	M1215A	1.25	1.37	.27	$\frac{7}{16}$	$\frac{55}{64}$	$1\frac{1}{4}$	1	$\frac{1}{2}$.16
15	M1215B	1.25	1.37	.27	$\frac{1}{2}$	$\frac{55}{64}$	$1\frac{1}{4}$	1	$\frac{1}{2}$.15
18	M1218	1.50	1.62	.32	$\frac{1}{2}$	$1\frac{1}{64}$	$1\frac{1}{2}$	$1\frac{1}{4}$	$\frac{5}{8}$.30
18	M1218A	1.50	1.62	.32	$\frac{5}{8}$	$1\frac{1}{64}$	$1\frac{1}{2}$	$1\frac{1}{4}$	$\frac{5}{8}$.25
18	M1218B	1.50	1.62	.32	$\frac{3}{4}$	$1\frac{1}{64}$	$1\frac{1}{2}$	$1\frac{1}{4}$	$\frac{5}{8}$.22
21	M1221	1.75	1.87	.39	$\frac{1}{2}$	$1\frac{3}{16}$	$1\frac{1}{2}$	$1\frac{1}{2}$	$1\frac{1}{16}$.45
21	M1221A	1.75	1.87	.39	$\frac{5}{16}$	$1\frac{3}{16}$	$1\frac{1}{2}$	$1\frac{1}{2}$	$1\frac{1}{16}$.45
21	M1221B	1.75	1.87	.39	$\frac{3}{8}$	$1\frac{3}{16}$	$1\frac{1}{2}$	$1\frac{1}{2}$	$1\frac{1}{16}$.43
21	M1221C	1.75	1.87	.39	$\frac{3}{4}$	$1\frac{3}{16}$	$1\frac{1}{2}$	$1\frac{1}{2}$	$1\frac{1}{16}$.38
24	M1224	2.00	2.12	.43	$\frac{1}{2}$	$1\frac{1}{2}$	$1\frac{1}{2}$	$1\frac{1}{2}$	$1\frac{1}{16}$.62
30	M1230	2.50	2.62	.54	$\frac{5}{8}$	$1\frac{3}{4}$	$2\frac{1}{16}$	$1\frac{1}{2}$	$2\frac{1}{32}$	1.10

14 Pitch

14	M1414	1.00	1.11	.19	$\frac{3}{8}$	$\frac{47}{64}$	$1\frac{1}{16}$	$\frac{7}{8}$	$\frac{1}{2}$.10
14	M1414A	1.00	1.11	.19	$\frac{7}{16}$	$\frac{47}{64}$	$1\frac{1}{16}$	$\frac{7}{8}$	$\frac{1}{2}$.09

16 Pitch

12	M1612	.75	.84	.16	$\frac{3}{16}$	$\frac{37}{64}$	$1\frac{1}{16}$	$\frac{5}{8}$	$\frac{3}{8}$.05
16	M1616	1.00	1.09	.22	$\frac{3}{8}$	$\frac{3}{4}$	$1\frac{1}{16}$	$\frac{3}{4}$	$\frac{7}{16}$.07
20	M1620	1.25	1.34	.27	$\frac{7}{16}$	$2\frac{1}{32}$	$1\frac{1}{4}$	1	$\frac{1}{2}$.16
24	M1624	1.50	1.59	.31	$\frac{1}{2}$	$\frac{7}{8}$	$1\frac{3}{8}$	1	$\frac{1}{2}$.20

20 Pitch

20	M2020	1.00	1.07	.23	$\frac{3}{8}$	$1\frac{13}{16}$	$1\frac{1}{8}$	$\frac{3}{4}$	$\frac{1}{2}$.06
25	M2025	1.25	1.32	.25	$\frac{3}{8}$	$\frac{3}{4}$	$1\frac{1}{8}$	1	$\frac{3}{8}$.14

24 Pitch

24	M2424	1.00	1.06	.20	$\frac{1}{4}$	$\frac{9}{16}$	$2\frac{1}{32}$	$\frac{5}{8}$	$\frac{3}{16}$.12
----	-------	------	------	-----	---------------	----------------	-----------------	---------------	----------------	-----

GEARS

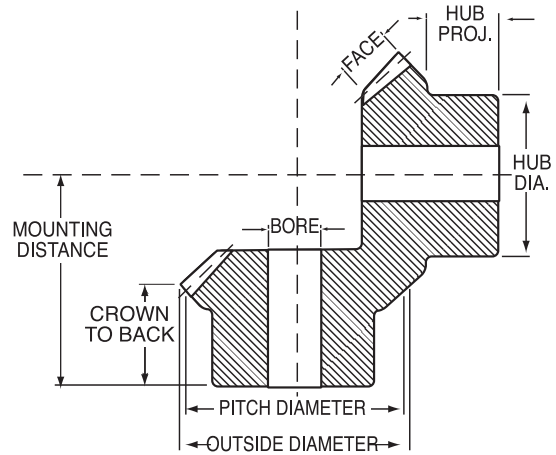

Steel - Plain Bore — Hardened Teeth

Number Teeth	Catalog Number	Diameter		Face (Inches)	Bore (Inches)		Mounting (Inches)	Hub (Inches)		Wt. Lbs. (App.)
		Pitch	Outside		Diameter	Length		Diameter	Proj. (App.)	

4 Pitch

24	HM424	6.00	6.36	1.33	1½	3⅞	5½	4	1⅝	14.4
24	HM424A	6.00	6.36	1.33	1¾	3⅞	5½	4	1⅝	13.7
28	HM428	7.00	7.36	1.43	2	3¾	6	5	1⅝	21.1

5 Pitch

25	HM525	5.00	5.29	1.10	1¾	3	4¾	3½	1¾	8.5
25	HM525A	5.00	5.29	1.10	1½	3	4¾	3½	1¾	8.3
25	HM525B	5.00	5.29	1.10	1¾	3	4¾	3½	1¾	7.5

6 Pitch

24	HM624	4.00	4.24	.86	1¼	2⅞	3¾	3	1⅝	4.4
24	HM624A	4.00	4.24	.86	1½	2⅞	3¾	3	1⅝	4.0
27	HM627	4.50	4.74	.96	1¼	2¾	4¼	3¼	1½	6.3
27	HM627A	4.50	4.74	.96	1½	2¾	4¼	3¼	1½	5.9

8 Pitch

24	HM824	3.00	3.18	.64	¾	1¾	2⅞	1¾	1⅜	1.5
24	HM824A	3.00	3.18	.64	1	1¾	2¾	2½	1	2.1
24	HM824B	3.00	3.18	.64	1¼	1¾	2¾	2½	1	2.6
28	HM828	3.50	3.68	.75	1	2⅞	3¼	2½	1¼	3.0
28	HM828A	3.50	3.68	.75	1⅜	2⅞	3¼	2½	1¼	2.8
28	HM828B	3.50	3.68	.75	1¼	2⅞	3¼	2½	1¼	2.6
32	HM832	4.00	4.18	.85	1	2⅞	3¾	3	1½	4.7

10 Pitch

20	HM1020A	2.00	2.14	.44	½	1¾	2	1¾	1⅜	.76
20	HM1020B	2.00	2.14	.44	¾	1¾	2	1¾	1⅜	.70
20	HM1020	2.00	2.14	.44	¾	1¾	2	1¾	1⅜	.64
20	HM1020C	2.00	2.14	.44	¾	1¾	2	1¾	1⅜	.58
25	HM1025	2.50	2.64	.55	¾	1¾	2⅞	2	1⅝	1.3
25	HM1025A	2.50	2.64	.55	¾	1¾	2⅞	2	1⅝	1.2
25	HM1025B	2.50	2.64	.55	1	1¾	2⅞	2	1⅝	1.2
30	HM1030	3.00	3.14	.64	¾	1¾	2¾	2	1	1.8

Miter Gears

20° Pressure Angle

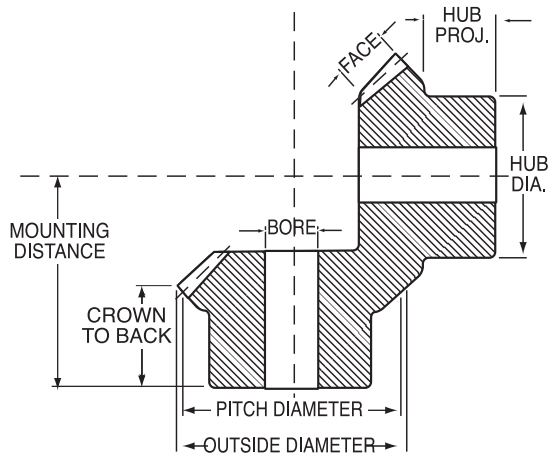

Steel - Plain Bore — Hardened Teeth

Number Teeth	Catalog Number	Diameter		Face (Inches)	Bore (Inches)		Mounting (Inches)	Hub (Inches)		Wt. Lbs. (App.)
		Pitch	Outside		Diameter	Length		Diameter	Proj. (App.)	

12 Pitch

15	HM1215	1.25	1.37	.27	$\frac{3}{8}$	$\frac{55}{64}$	$1\frac{1}{4}$	1	$\frac{1}{2}$.15
15	HM1215B	1.25	1.37	.27	$\frac{1}{2}$	$\frac{55}{64}$	$1\frac{1}{4}$	1	$\frac{1}{2}$.15
18	HM1218	1.50	1.62	.32	$\frac{1}{2}$	$1\frac{1}{64}$	$1\frac{1}{2}$	$1\frac{1}{4}$	$\frac{5}{8}$.30
18	HM1218A	1.50	1.62	.32	$\frac{3}{8}$	$1\frac{1}{64}$	$1\frac{1}{2}$	$1\frac{1}{4}$	$\frac{3}{8}$.25
18	HM1218B	1.50	1.62	.32	$\frac{3}{4}$	$1\frac{1}{64}$	$1\frac{1}{2}$	$1\frac{1}{4}$	$\frac{5}{8}$.22
21	HM1221	1.75	1.87	.39	$\frac{1}{2}$	$1\frac{1}{16}$	$1\frac{1}{4}$	$1\frac{3}{8}$	$1\frac{1}{16}$.22
21	HM1221B	1.75	1.87	.39	$\frac{5}{8}$	$1\frac{3}{16}$	$1\frac{3}{4}$	$1\frac{3}{8}$	$1\frac{1}{16}$.42
24	HM1224	2.00	2.12	.43	$\frac{1}{2}$	$1\frac{7}{32}$	$1\frac{1}{2}$	$1\frac{1}{2}$	$1\frac{1}{16}$.62

14 Pitch

14	HM1414	1.00	1.11	.19	$\frac{3}{8}$	$\frac{47}{64}$	$1\frac{1}{16}$	$\frac{7}{8}$	$\frac{1}{2}$.10
14	HM1414A	1.00	1.11	.19	$\frac{7}{16}$	$\frac{47}{64}$	$1\frac{1}{16}$	$\frac{7}{8}$	$\frac{1}{2}$.10

16 Pitch

16	HM1616	1.00	1.09	.22	$\frac{3}{8}$	$\frac{3}{4}$	$1\frac{1}{16}$	$\frac{3}{4}$	$\frac{7}{16}$.07
24	HM1624	1.50	1.59	.31	$\frac{1}{2}$	$\frac{7}{8}$	$1\frac{3}{8}$	1	$\frac{1}{2}$.20

24 Pitch

24	HM2424	1.00	1.06	.20	$\frac{1}{4}$	$\frac{9}{16}$	$2\frac{3}{32}$	$\frac{5}{8}$	$\frac{3}{32}$.06
----	--------	------	------	-----	---------------	----------------	-----------------	---------------	----------------	-----

GEARS

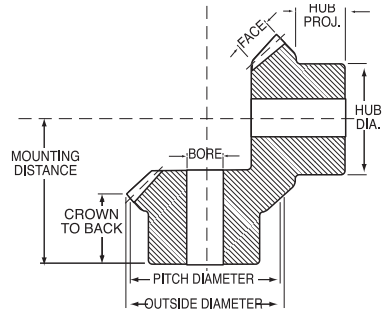

Steel - Furnished With Keyway and Set Screw — Hardened Teeth

Number Teeth	Catalog Number	Diameter		Face (Inches)	Bore (Inches)		Mounting (Inches)	Hub (Inches)		Wt. Lbs. (App.)
		Pitch	Outside		Diameter	Length		Diameter	Proj. (App.)	

4 Pitch

24	HMK424A	6.00	6.36	1.33	1 $\frac{1}{4}$	3 $\frac{3}{16}$	5 $\frac{1}{2}$	4	1 $\frac{1}{16}$	13.7
28	HMK428	7.00	7.36	1.43	2	3 $\frac{3}{8}$	6	5	1 $\frac{1}{8}$	20.4

5 Pitch

25	HMK525	5.00	5.29	1.10	1 $\frac{3}{8}$	3	4 $\frac{1}{2}$	3 $\frac{1}{2}$	1 $\frac{3}{8}$	8.5
25	HMK525B	5.00	5.29	1.10	1 $\frac{1}{4}$	3	4 $\frac{1}{2}$	3 $\frac{1}{2}$	1 $\frac{1}{4}$	7.5

6 Pitch

24	HMK624	4.00	4.24	.86	1 $\frac{1}{4}$	2 $\frac{1}{16}$	3 $\frac{3}{8}$	3	1 $\frac{1}{16}$	4.4
24	HMK624A	4.00	4.24	.86	1 $\frac{1}{2}$	2 $\frac{1}{16}$	3 $\frac{3}{8}$	3	1 $\frac{1}{16}$	4.0
27	HMK627	4.50	4.74	.96	1 $\frac{1}{4}$	2 $\frac{1}{2}$	4 $\frac{1}{8}$	3 $\frac{1}{4}$	1 $\frac{1}{2}$	6.3
27	HMK627A	4.50	4.74	.96	1 $\frac{1}{2}$	2 $\frac{1}{2}$	4 $\frac{1}{8}$	3 $\frac{1}{4}$	1 $\frac{1}{2}$	5.9

8 Pitch

24	HMK824	3.00	3.18	.64	$\frac{3}{4}$	1 $\frac{3}{4}$	2 $\frac{1}{16}$	1 $\frac{3}{4}$	1 $\frac{3}{16}$	1.5
24	HMK824A	3.00	3.18	.64	1	1 $\frac{3}{4}$	2 $\frac{1}{8}$	2 $\frac{1}{2}$	1	2.1
24	HMK824B	3.00	3.18	.64	1 $\frac{1}{4}$	1 $\frac{3}{4}$	2 $\frac{1}{4}$	2 $\frac{1}{2}$	1	1.8
28	HMK828	3.50	3.68	.75	1	2 $\frac{1}{32}$	3 $\frac{1}{4}$	2 $\frac{1}{2}$	1 $\frac{1}{4}$	2.9
28	HMK828A	3.50	3.68	.75	1 $\frac{1}{16}$	2 $\frac{1}{32}$	3 $\frac{1}{4}$	2 $\frac{1}{2}$	1 $\frac{1}{4}$	2.7
28	HMK828B	3.50	3.68	.75	1 $\frac{1}{4}$	2 $\frac{1}{32}$	3 $\frac{1}{4}$	2 $\frac{1}{2}$	1 $\frac{1}{4}$	2.6

10 Pitch

20	HMK1020A	2.00	2.14	.44	$\frac{1}{2}$	1 $\frac{3}{4}$	2	1 $\frac{1}{2}$	1 $\frac{13}{16}$.74
20	HMK1020B	2.00	2.14	.44	$\frac{5}{8}$	1 $\frac{3}{4}$	2	1 $\frac{1}{2}$	1 $\frac{13}{16}$.70
20	HMK1020	2.00	2.14	.44	$\frac{3}{4}$	1 $\frac{3}{4}$	2	1 $\frac{1}{2}$	1 $\frac{7}{16}$.63
20	HMK1020C	2.00	2.14	.44	$\frac{7}{8}$	1 $\frac{3}{4}$	2	1 $\frac{1}{2}$	1 $\frac{13}{16}$.58
25	HMK1025	2.50	2.64	.55	$\frac{3}{4}$	1 $\frac{1}{2}$	2 $\frac{1}{16}$	2	1 $\frac{15}{16}$	1.30
25	HMK1025A	2.50	2.64	.55	$\frac{7}{8}$	1 $\frac{1}{2}$	2 $\frac{1}{16}$	2	1 $\frac{15}{16}$	1.20
25	HMK1025B	2.50	2.64	.55	1	1 $\frac{1}{2}$	2 $\frac{1}{16}$	2	1 $\frac{15}{16}$	1.10

12 Pitch

15	HMK1215B	1.25	1.37	.27	$\frac{1}{2}$	$\frac{5}{16}$	1 $\frac{1}{2}$	1	$\frac{1}{2}$.14
18	HMK1218A	1.50	1.62	.32	$\frac{5}{8}$	1 $\frac{1}{4}$	1 $\frac{1}{2}$	1 $\frac{1}{4}$	$\frac{5}{8}$.25
21	HMK1221B	1.75	1.87	.39	$\frac{3}{4}$	1 $\frac{1}{8}$	1 $\frac{1}{2}$	1 $\frac{1}{2}$	1 $\frac{1}{16}$.41
30	HMK1230	2.50	2.62	.54	$\frac{3}{4}$	1 $\frac{3}{4}$	2 $\frac{1}{16}$	1 $\frac{1}{2}$	2 $\frac{1}{32}$	1.1

16 Pitch

16	HMK1616	1.00	1.09	.22	$\frac{3}{8}$	$\frac{3}{8}$	1 $\frac{1}{16}$	$\frac{3}{4}$	$\frac{7}{16}$.07
24	HMK1624	1.50	1.59	.31	$\frac{1}{2}$	$\frac{7}{8}$	1 $\frac{1}{8}$	1	$\frac{1}{2}$.20

Miter Gear Horsepower Ratings



Steel

Catalog Number	Revolutions Per Minute									
	10	25	50	100	200	300	600	900	1200	1800
M424	.80	1.90	3.6	6.4	10.6	13.5	18.8	21.5	23.0	
HM424	1.40	3.33	6.3	11.2	18.6	23.6	33.0	38.0	40.0	
M428	1.07	2.50	4.8	8.4	13.6	17.2	23.3	26.5	28.5	
HM428	1.90	4.50	8.4	14.7	23.8	30.0	40.0	46.0	50.0	
M525	.45	1.05	2.0	3.7	6.3	8.1	11.6	13.6	15.0	
HM525	.75	1.90	3.6	6.5	11.0	14.2	20.0	24.0	26.0	
M624	.25	.55	1.1	2.0	3.5	4.6	6.9	8.2	19.0	10.2
HM624	.40	1.00	1.9	3.5	6.1	8.0	12.0	14.5	16.0	18.0
M627	.30	.75	1.4	2.5	4.3	5.7	8.5	9.9	11.0	12.0
HM627	.50	1.33	2.5	4.4	7.5	10.0	1.5	17.5	19.0	21.0
M824	.10	.25	.5	.9	1.5	2.1	3.3	4.0	4.5	5.3
HM824	.20	.40	.8	1.5	2.6	3.7	5.8	7.0	8.0	9.3
M828	.15	.33	.7	1.2	2.2	2.9	4.4	5.3	6.0	6.8
HM828	.25	.60	1.2	2.1	3.9	5.0	7.7	9.3	10.5	12.0
M832	.20	.45	.9	1.6	2.8	3.7	5.5	6.5	7.2	8.0
HM832	.33	.80	1.5	2.8	4.9	6.5	9.6	11.4	12.5	14.2
M1020	.03	.08	.2	.3	.6	.8	1.3	1.7	2.0	2.4
HM1020	.05	.15	.3	.5	1.0	1.4	2.3	3.0	3.5	4.2
M1025	.06	.15	.3	.5	.9	1.3	2.0	2.5	2.9	3.5
HM1025	.10	.25	.5	.9	1.6	2.3	3.5	4.4	5.0	6.0
M1030	.08	.20	.4	.7	1.3	1.8	2.8	3.5	3.9	4.5
HM1030	.15	.33	.7	1.3	2.3	3.2	4.9	6.1	6.8	8.0
M1215	.01	.02	.05	.10	.20	.3	.5	.6	.8	.9
HM1215	.02	.04	.10	.17	.33	.4	.8	1.0	1.3	1.6
M1218	.01	.03	.08	.14	.25	.4	.7	.9	1.0	1.3
HM1218	.02	.05	.15	.25	.47	.7	1.1	1.5	1.8	2.2
M1221	.02	.05	.11	.20	.40	.5	.9	1.2	1.4	1.7
HM1221	.04	.10	.20	.33	.70	1.0	1.6	2.1	2.5	3.0
M1224	.03	.07	.15	.25	.50	.7	1.2	1.5	1.7	2.0
HM1224	.05	.12	.25	.47	.90	1.2	2.1	2.6	3.0	3.5
M1230	.05	.12	.25	.44	.80	1.1	1.8	2.2	2.5	3.0
HM1230	.09	.21	.40	.75	1.40	1.9	3.2	4.0	4.4	5.3
M1414	.01	.02	.05	.09	.16	.2	.4	.6	.7	.9
HM1414	.02	.04	.09	.16	.3	.4	.8	1.0	1.3	1.6
M1616	.01	.02	.05	.09	.16	.2	.4	.6	.7	.9
HM1616	.02	.04	.09	.16	.3	.4	.8	1.0	1.3	1.6
M1620	.02	.04	.08	.14	.2	.4	.8	1.0	1.3	1.6
HM1620	.04	.07	.15	.25	.4	.7	1.2	1.5	1.7	2.0
M1624	.03	.06	.12	.20	.3	.5	.9	1.2	1.4	1.8
HM1624	.05	.10	.21	.40	.6	1.0	1.6	2.1	2.5	3.0
M2020	.01	.02	.04	.08	.14	.2	.4	.6	.7	.9
HM2020	.02	.04	.08	.14	.2	.4	.8	1.0	1.3	1.6
M2025	.02	.03	.06	.12	.2	.3	.6	.8	1.0	1.3
HM2025	.04	.05	.10	.21	.4	.6	1.0	1.3	1.6	2.0

Ratings listed to right of dark line exceed recommended pitch line velocity.



Right Hand Worm and Gear



Single, Double, Quadruple Thread Worms

***NOTE: SELF-LOCKING ABILITY**

There is often some confusion as to the self-locking ability of a worm and gear set. *Martin* worm gear sets, under no condition should be considered to hold a load when at rest. The statement is made to cover the broad spectrum of variables affecting self-locking characteristics of a particular gear set in a specific application. Theoretically, a worm gear will not back drive if the friction angle is greater than the worm lead angle. However, the actual surface finish and lubrication may reduce this significantly. More important, vibration may cause motion at the point of mesh with further reduction in the friction angle.

Generally speaking, if the worm lead angle is less than 5°, there is reasonable expectation of self-locking. Again, no guarantee should be made and customer should be advised. **If safety is involved, a positive brake should be used.**

Originally, worm gearing was used to secure, by compact means, a large reduction of speed between driving and driven shafts with a proportionate increase (except for frictional loss) in the torque of the driven shaft. Worm gearing is still used for this purpose, and frequently the wheel is driven by a single-thread worm of such low helix angle that the drive cannot be reversed; that is the wheel cannot drive the worm as the gearing automatically locks itself against backward rotation. (*See note below.)

Although a multiple-threaded worm when applied under like conditions is much more efficient than a single-threaded worm, it does not follow that the multiple-threaded worm should always be used.

A single-threaded worm might be preferable when the most important requirement is to obtain a high ratio and especially if the worm must be self-locking.

When power is the primary factor, the multiple-threaded worms should be used.

LUBRICATION is an important factor when using worm gearing. An increase in heat generated means a decrease in efficiency. The amount of power which can be transmitted at a given temperature increases as the efficiency of the gearing increases.

MATERIALS for worm and worm gears are generally confined to steel for worms and bronze or cast iron for gears. When steel worms are run with bronze gears at high speeds, the worm is usually hardened with ground threads.

GEARS

Direction of Rotation and Thrust Right Hand

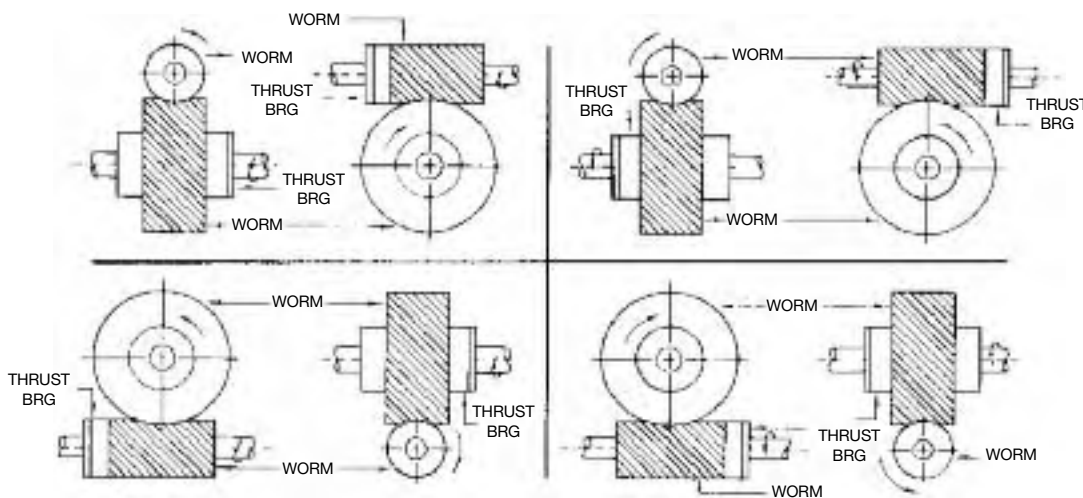

Worm and Worm Gears

3 Pitch • 2" Face • 14½° Pressure Angle



Right Hand Single Thread (Stocked Right Hand Only)

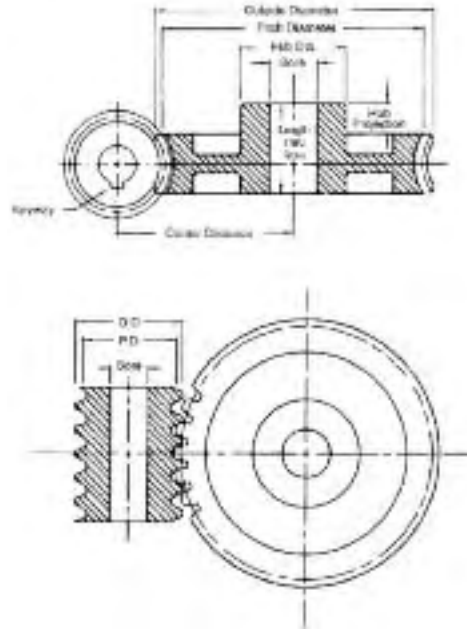

GEARS

Cast Iron

No. Teeth	Catalog Number Cast Iron	Wt. Lbs. (App.)	Pitch Dia.	Bore (Inches)	Hub (Inches)		Style
					Dia.	Proj.	
18	W318	16.2	6.000	1	3	1½	W
24	W324	22.8	8.000	1½	3½	1½	S
30	W330	30.2	10.000	1½	3½	1½	S
36	W336	36.4	12.000	1½	3½	1½	S
54	W354	60.2	18.000	1½	4	1½	S

W = WEB S = SPOKE



Steel — 4° 46' Helix Angle Worms

Catalog Number Soft	Wt. Lbs. (App.)	Catalog Number Hardened	Wt. Lbs. (App.)	Faces (Inches)	Pitch Dia.	Bore (Inches)	Keyway (Inches)
W3	12.2	WG3	12.0	4	4.000	1½	¾x¾

Case hardened worms have ground and polished threads (Indicated by letter "G" in catalog number).

Right Hand Single Thread (Stocked Right Hand Only)

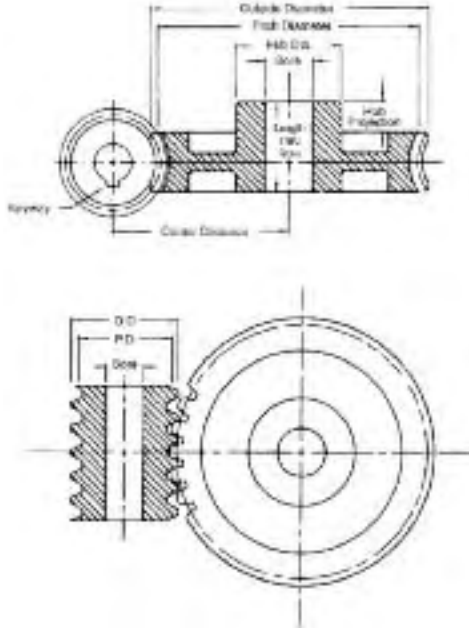

Cast Iron

No. Teeth	Catalog Number Cast Iron	Wt. Lbs. (App.)	Pitch Dia.	Bore (Inches)	Hub (Inches)		Style
					Dia.	Proj.	
20	W420	8.4	5.000	1	2½	1¼	W
24	W424	12.9	6.000	1	2½	1¼	W
32	W432	15.6	8.000	1¼	3	1¼	W
40	W440	27.5	10.000	1¼	3	1¼	W
48	W448	34.1	12.000	1¼	4	1¼	W
64	W464	43.9	16.000	1½	4	1¼	S

W = WEB S = SPOKE



Steel — 4° 46' Helix Angle Worms

Catalog Number Soft	Wt. Lbs. (App.)	Catalog Number Hardened	Wt. Lbs. (App.)	Faces (Inches)	Pitch Dia.	Bore (Inches)	Keyway (Inches)
W4	5.6	WG4	5.5	3½	3.000	1¼	⅝x⅜

Case hardened worms have ground and polished threads (Indicated by letter "G" in catalog number).

Worm and Worm Gears

6 Pitch • 1" Face • 14½° Pressure Angle

Right Hand Single Thread (Stocked Right Hand Only)

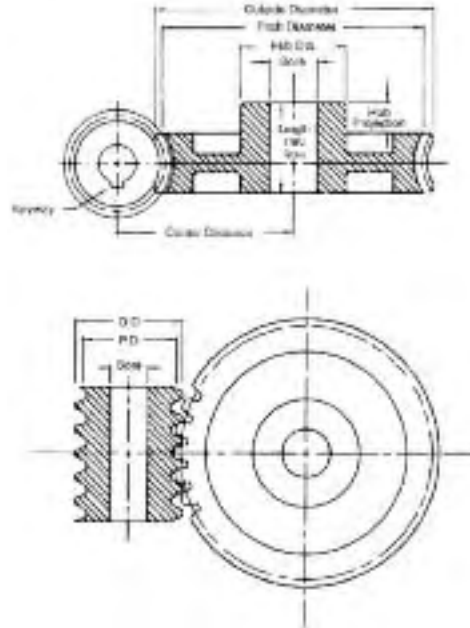

GEARS

Cast Iron

No. Teeth	Catalog Number Cast Iron	Wt. Lbs. (App.)	Pitch Dia.	Bore (Inches)	Hub (Inches)		Style
					Dia.	Proj.	
20	W620	2.5	3.333	¾	1⅞	⅞	W
24	W624	3.6	4.000	¾	1⅞	⅞	W
30	W630	5.0	5.000	⅞	2¼	⅞	W
36	W636	6.0	6.000	1	2½	⅞	W
40	W640	7.6	6.667	1	2½	⅞	W
48	W648	9.2	8.000	1¼	2¾	1	W
60	W660	13.7	10.000	1¼	3	1¼	W
72	W672	14.9	12.000	1¼	3	1¼	W

Has 2¾" hub diameter and 1¼" hub proj. W = WEB



Steel — 4° 46' Helix Angle Worms

Catalog Number Soft	Wt. Lbs. (App.)	Catalog Number Hardened	Wt. Lbs. (App.)	Face (Inches)	Pitch Dia.	Bore (Inches)	Hub (Inches)		Keyway (Inches)
							Dia.	Proj.	
W6	1.8	WG6	1.7	2½	2.000	⅞	1⅞	⅞	⅜x⅜
WH6	2.7			2½	2.000	⅞	1⅞	⅞	⅜x⅜

Case hardened worms have ground and polished threads (Indicated by letter "G" in catalog number).

Right Hand Double Thread (Stocked Right Hand Only)

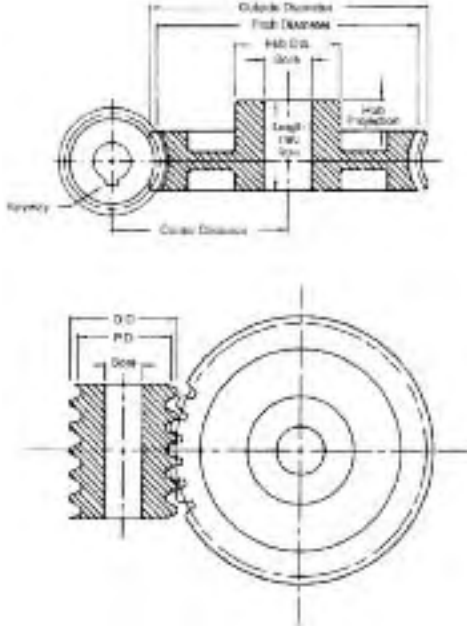

Cast Iron

Number Teeth	Catalog Number Cast Iron	Wt. Lbs. (App.)	Pitch Dia.	Bore (Inches)	Hub (Inches)		Style
					Dia.	Proj.	
20	W620D	3.3	3.333	1	2¾	1	PLAIN
24	W624D	4.1	4.000	1¼	2¾	1	PLAIN
30	W630D	5.2	5.000	1¼	2¾	1	W
40	W640D	7.6	6.667	1¼	2¾	1	W

W = WEB



Steel — 9° 28' Helix Angle Worms

Catalog Number Soft	Weight Pounds (App.)	Face (Inches)	Pitch Diameter	Bore (Inches)	Keyway (Inches)
W6D	1.6	2¾	2.000	1	¼x¼

Worm and Worm Gears

6 Pitch • 1" Face • 14½° Pressure Angle



Right Hand Quadruple Thread (Stocked Right Hand Only)

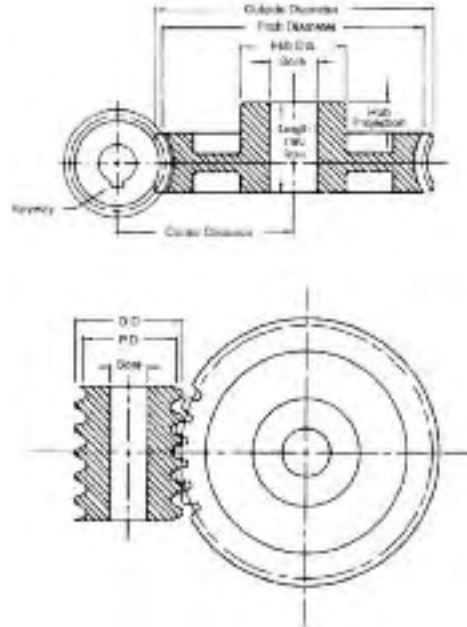

GEARS

Cast Iron

Number Teeth	Catalog Number Cast Iron	Wt. Lbs. (App.)	Pitch Dia.	Bore (Inches)	Hub (Inches)		Style
					Dia.	Proj.	
20	W620Q	3.4	3.333	1	2½	1	PLAIN
24	W624Q	4.1	4.000	1¼	2½	1	PLAIN



Steel — 18° 26' Helix Angle Worms

Catalog Number Soft	Wt. Lbs. (App.)	Face (Inches)	Pitch Diameter	Bore (Inches)	Keyway (Inches)
W6Q	1.6	2½	2.000	1	¼x¼

Right Hand Single Thread (Stocked Right Hand Only)

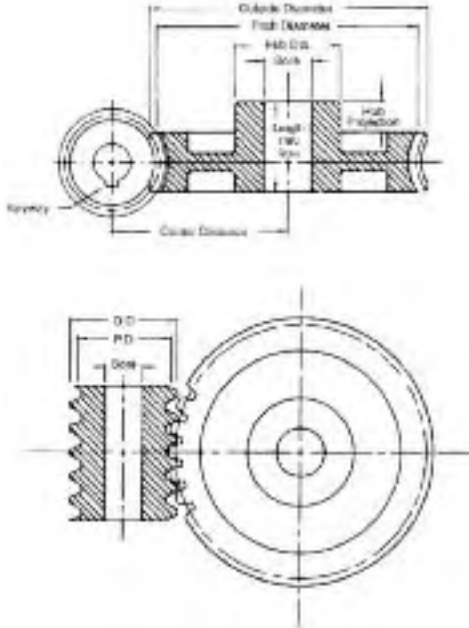

Cast Iron

Number Teeth	Catalog Number Cast Iron	Weight Pounds (App.)	Pitch Dia.	Bore (Inches)	Hub (Inches)		Style
					Dia.	Proj.	
20	W820	1.3	2.500	$\frac{3}{4}$	$1\frac{1}{4}$	$\frac{3}{4}$	PLAIN
30	W830	2.4	3.750	$\frac{3}{4}$	$1\frac{1}{4}$	$\frac{3}{4}$	W
40	W840	3.7	5.000	1	$2\frac{1}{2}$	$\frac{7}{8}$	W
48	W848	4.5	6.000	1	$2\frac{3}{8}$	$\frac{7}{8}$	W
50	W850	5.1	6.250	1	$2\frac{3}{8}$	$\frac{7}{8}$	W
60	W860	6.1	7.500	1	$2\frac{1}{2}$	$\frac{7}{8}$	W
80	W880	8.9	10.000	$1\frac{1}{4}$	3	$\frac{7}{8}$	W

W = WEB



Steel — $4^\circ 46'$ Helix Angle Worms

Catalog Number Soft	Weight Pounds (App.)	Catalog Number Hardened	Wt. Lbs. (App.)	Face (Inches)	Pitch Dia.	Bore (Inches)	Hub (Inches)		Keyway (Inches)
							Dia.	Proj.	
W8	.64	WG8	.62	$1\frac{1}{4}$	1.500	$\frac{3}{4}$	$1\frac{1}{6}$	$\frac{5}{8}$	$\frac{3}{16} \times \frac{3}{16}$
WH8	.74			$1\frac{1}{4}$	1.500	$\frac{3}{4}$	$1\frac{1}{6}$	$\frac{5}{8}$	

Case hardened worms have ground and polished threads (indicated by letter "G" in catalog number).

Worm and Worm Gears

8 Pitch • $\frac{3}{4}$ " Face • $14\frac{1}{2}^\circ$ Pressure Angle



Right Hand Double Thread (Stocked Right Hand Only)

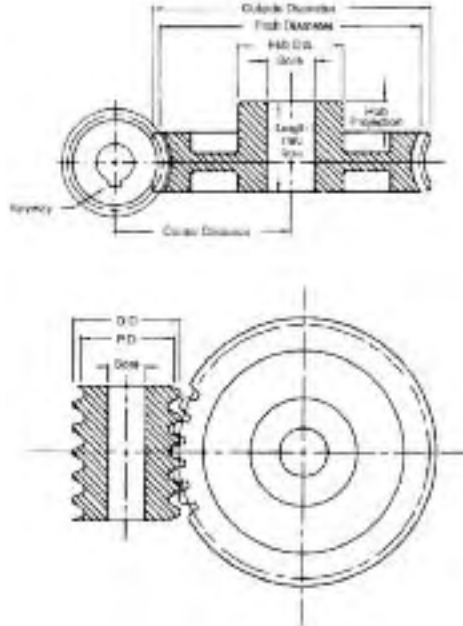

GEARS

Cast Iron

Number Teeth	Catalog Number Cast Iron	Weight Pounds (App.)	Pitch Dia.	Bore (Inches)	Hub (Inches)		Style
					Dia.	Proj.	
20	W820D	1.2	2.500	1	2	$\frac{3}{4}$	PLAIN
30	W830D	2.5	3.750	1	$2\frac{1}{4}$	$\frac{3}{4}$	W
40	W840D	3.4	5.000	1	$2\frac{1}{4}$	$\frac{3}{4}$	W

W = WEB



Steel — $9^\circ 28'$ Helix Angle Worms

Catalog Number Soft	Weight Pounds (App.)	Catalog Number Hardened	Wt. Lbs. (App.)	Face (Inches)	Pitch Dia.	Bore (Inches)	Hub (Inches)		Keyway (Inches)
							Dia.	Proj.	
W8D	.56	WG8D	.54	$1\frac{1}{4}$	1.500	$\frac{7}{8}$	$1\frac{1}{16}$	$\frac{3}{16} \times \frac{3}{32}$	
WH8D	.74			$1\frac{1}{4}$	1.500	$\frac{7}{8}$	$\frac{3}{4}$		

Case hardened worms have ground and polished threads (Indicated by letter "G" in catalog number).



Worm and Worm Gears

8 Pitch • $\frac{3}{4}$ " Face • $14\frac{1}{2}^\circ$ Pressure Angle

Right Hand Quadruple Thread (Stocked Right Hand Only)

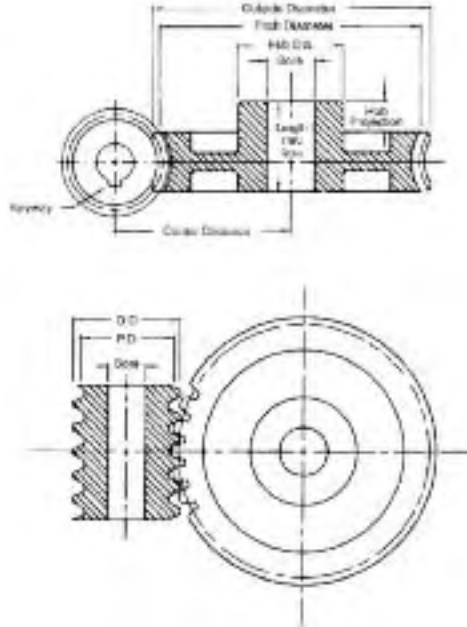

Cast Iron

Number Teeth	Catalog Number Cast Iron	Weight Pounds (App.)	Pitch Dia.	Bore (Inches)	Hub (Inches)		Style
					Dia.	Proj.	
20	W820Q	1.2	2.500	1	2	$\frac{3}{4}$	PLAIN
30	W830Q	2.5	3.750	1	2 $\frac{1}{4}$	$\frac{3}{4}$	W

W = WEB



Steel — $18^\circ 26'$ Helix Angle Worms

Catalog Number Cast Iron	Weight Pounds (App.)	Face (Inches)	Pitch Dia.	Bore (Inches)	Hub (Inches)		Keyway (Inches)
					Dia.	Proj.	
W8Q	.58	$1\frac{1}{4}$	1.500	$\frac{7}{8}$	$1\frac{1}{6}$	$\frac{5}{8}$	$\frac{3}{16} \times \frac{3}{32}$
WH8Q	.76	$1\frac{1}{4}$	1.500	$\frac{7}{8}$	$1\frac{1}{6}$	$\frac{5}{8}$	$\frac{3}{16} \times \frac{3}{32}$

Worm and Worm Gears

10 Pitch • $\frac{5}{8}$ " Face • $14\frac{1}{2}^\circ$ Pressure Angle



Right Hand Single Thread (Stocked Right Hand Only)

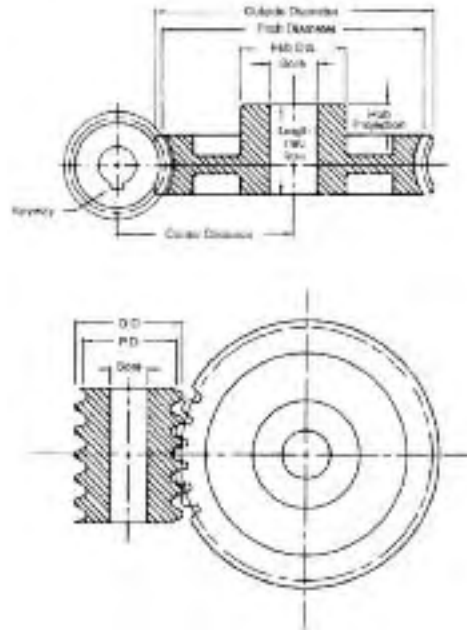

GEARS

Cast Iron and Bronze

Number Teeth	Catalog Number Cast Iron	Weight Pounds (App.)	Pitch Dia.	Bore (Inches)	Hub (Inches)		Style	Catalog Number Bronze	Weight Pounds (App.)
					Dia.	Proj.			
20	W1020	.7	2.000	$\frac{1}{2}$	$1\frac{1}{4}$	$\frac{3}{4}$	PLAIN	WB1020	.8
30	W1030	1.5	3.000	$\frac{3}{8}$	$1\frac{1}{2}$	$\frac{3}{4}$	PLAIN	WB1030	1.7
40	W1040	1.8	4.000	$\frac{3}{8}$	$1\frac{3}{4}$	$\frac{3}{4}$	W	WB1040	2.4
50	W1050	2.8	5.000	$\frac{3}{8}$	2	$\frac{3}{4}$	W		
60	W1060	3.6	6.000	$\frac{3}{8}$	2	$\frac{3}{4}$	W		
80	W1080	4.8	8.000	$\frac{3}{8}$	2	$\frac{3}{4}$	W		
100	W10100	6.0	10.000	$\frac{3}{8}$	$2\frac{1}{2}$	$\frac{3}{4}$	W		

W = WEB



Steel — $4^\circ 34'$ Helix Angle Worms

Catalog Number Soft	Weight Pounds (App.)	Catalog Number Hardened	Weight Pounds (App.)	Face (Inches)	Pitch Dia.	Bore (Inches)	Hub (Inches)		Keyway (Inches)
							Dia.	Proj.	
W10	.36	WG10	.32	$1\frac{1}{8}$	1.250	$\frac{3}{8}$	1	$\frac{1}{2}$	$\frac{3}{16} \times \frac{1}{2}$
WH10	.42		.38	$1\frac{1}{8}$	1.250	$\frac{3}{8}$	1	$\frac{1}{2}$	

Case hardened worms have ground and polished threads (Indicated by letter "G" in catalog number).



Worm and Worm Gears

10 Pitch • $\frac{5}{8}$ " Face • $14\frac{1}{2}^\circ$ Pressure Angle

Right Hand Double Thread (Stocked Right Hand Only)

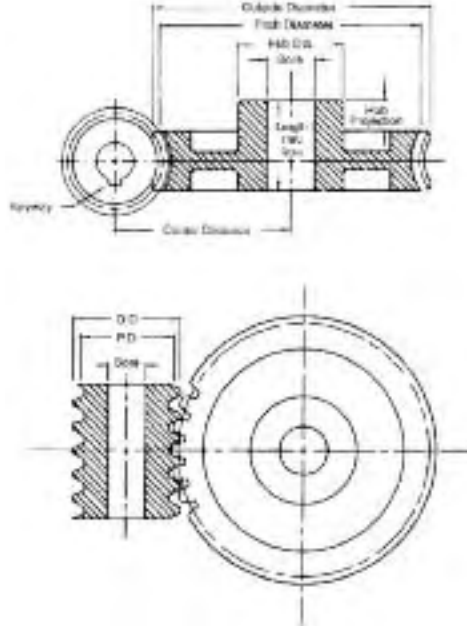

Cast Iron and Bronze

No. Teeth	Catalog Number Cast Iron	Wt. Lbs. (App.)	Pitch Dia.	Bore (Inches)	Hub (Inches)		Style	Catalog Number Bronze	Wt. Lbs. (App.)
					Dia.	Proj.			
20	W1020D	.65	2.000	$\frac{7}{8}$	1 $\frac{1}{2}$	$\frac{5}{8}$	PLAIN	WB1020D	.75
30	W1030D	1.3	3.000	$\frac{7}{8}$	1 $\frac{1}{2}$	$\frac{5}{8}$	W	WB1030D	1.3
40	W1040D	1.6	4.000	$\frac{7}{8}$	1 $\frac{3}{4}$	$\frac{5}{8}$	W		
50	W1050D	2.9	5.000	$\frac{7}{8}$	2	1	W		
60	W1060D	3.0	6.000	$\frac{7}{8}$	2	1	W		

W = WEB



Steel — $9^\circ 5'$ Helix Angle Worms

Catalog Number Soft	Weight Pounds (App.)	Face (Inches)	Pitch Dia.	Bore (Inches)	Hub (Inches)		Keyway (Inches)
					Dia.	Proj.	
W10D	.28	1 $\frac{1}{2}$	1.2500	$\frac{3}{4}$	1	$\frac{1}{2}$	$\frac{3}{16} \times \frac{3}{32}$
WH10D	.42	1 $\frac{1}{2}$	1.2500	$\frac{3}{4}$	1	$\frac{1}{2}$	

Worm and Worm Gears

10 Pitch • $\frac{5}{8}$ " Face • $14\frac{1}{2}^\circ$ Pressure Angle



Right Hand Quadruple Thread (Stocked Right Hand Only)

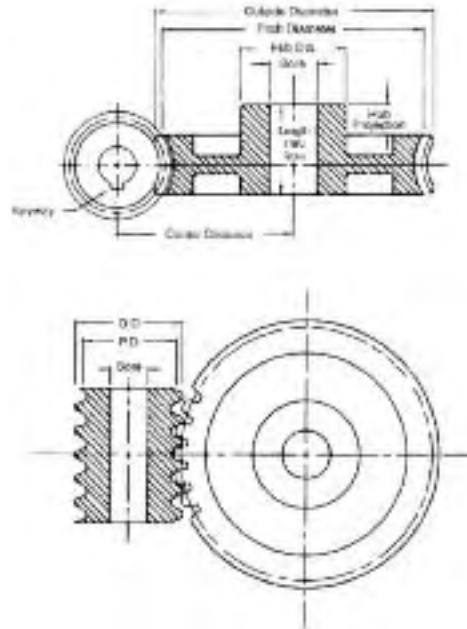

GEARS

Cast Iron

Number Teeth	Catalog Number Cast Iron	Weight Pounds (App.)	Pitch Dia.	Bore (Inches)	Hub (Inches)		Style
					Dia.	Proj.	
20	W1020Q	.64	2.000	$\frac{7}{8}$	$1\frac{1}{8}$	$\frac{5}{8}$	PLAIN
30	W1030Q	1.3	3.000	$\frac{7}{8}$	$1\frac{1}{8}$	$\frac{5}{8}$	W
40	W1040Q	1.6	4.000	$\frac{7}{8}$	$1\frac{1}{8}$	$\frac{5}{8}$	W

W = WEB



Steel — $17^\circ 45'$ Helix Angle Worms

Catalog Number Soft	Weight Pounds (App.)	Face (Inches)	Pitch Dia.	Bore (Inches)	Hub (Inches)		Keyway (Inches)
					Dia.	Proj.	
W10Q	.28	$1\frac{1}{8}$	1.250	$\frac{3}{4}$	1	$\frac{1}{2}$	$\frac{3}{16} \times \frac{1}{2}$
WH10Q	.40	$1\frac{1}{8}$	1.250	$\frac{3}{4}$	1	$\frac{1}{2}$	$\frac{3}{16} \times \frac{1}{2}$



Worm and Worm Gears

12 Pitch • 1/2" Face • 14 1/2° Pressure Angle

Right Hand Single Thread (Stocked Right Hand Only)

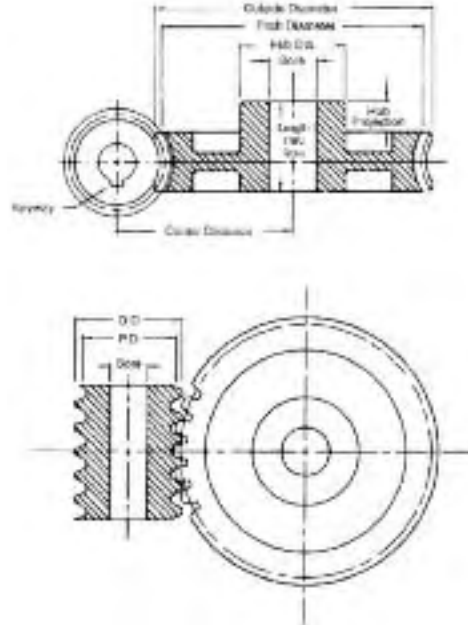

Cast Iron and Bronze

Number Teeth	Catalog Number Cast Iron	Weight Pounds (App.)	Pitch Dia.	Bore (Inches)	Hub (Inches)		Style	Catalog Number Bronze	Wt. Lbs. (App.)
					Dia.	Proj.			
18	W1218	.28	1.500	1/2	1 1/4	3/8	PLAIN	WB1220	.45
20	W1220	.35	1.667	1/2	1 1/4	3/8	PLAIN		
30	W1230	.71	2.500	1/2	1 1/4	3/8	W		
40	W1240	1.2	3.333	3/4	1 1/2	3/4	W		
50	W1250	1.5	4.166	3/4	1 1/2	3/4	W		
60	W1260	2.0	5.000	3/4	1 1/4	3/4	W		
80	W1280	3.9	6.666	3/4	2 1/2	3/4	W		
100	W12100	4.4	8.333	3/4	2	3/4	W		

W = WEB



Steel — 4° 46' Helix Angle Worms

Catalog Number Soft	Weight Pounds (App.)	Catalog Number Hardened	Weight Pounds (App.)	Face (Inches)	Pitch Dia.	Bore (Inches)	Hub (Inches)		Keyway (Inches)
							Dia.	Proj.	
W12	.17	WG12	.14	1 1/4	1.000	1/2	3/4	3/4	1/8 x 1/16
WH12	.20			1 1/4	1.000	1/2	3/4	3/4	

Case hardened worms have ground and polished threads (Indicated by letter "G" in catalog number).

Worm and Worm Gears

12 Pitch • 1/2" Face • 14 1/2° Pressure Angle



Right Hand Double Thread (Stocked Right Hand Only)

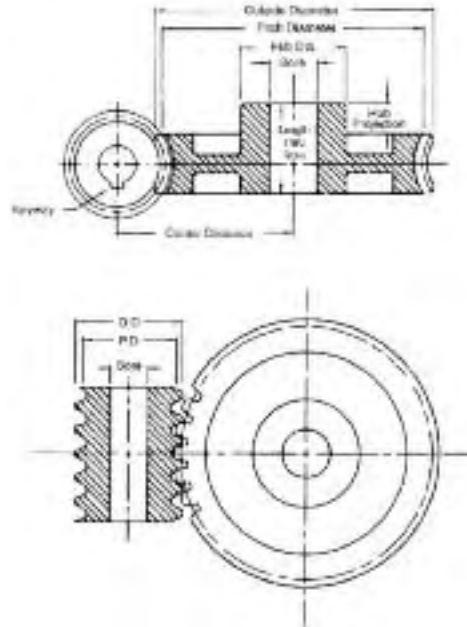

GEARS

Cast Iron and Bronze

Number Teeth	Catalog Number Cast Iron	Weight Pounds (App.)	Pitch Dia.	Bore (Inches)	Hub (Inches)		Style	Catalog Number Bronze	Wt. Lbs. (App.)
					Dia.	Proj.			
20	W1220D	.32	1.666	1/2	1 1/4	1/2	PLAIN	WB1220D	.40
30	W1230D	.78	2.500	3/4	1 1/2	5/8	PLAIN		
40	W1240D	1.3	3.333	1	1 3/4	3/4	W		

W = WEB



Steel — 9° 28' Helix Angle Worms

Catalog Number Soft	Weight Pounds (App.)	Catalog Number Hardened	Weight Pounds (App.)	Face (Inches)	Pitch Dia.	Bore (Inches)	Hub (Inches)		Keyway (Inches)
							Dia.	Proj.	
W12D	.14	WG12D	.14	1 1/4	1.000	3/8	1 1/4	1 1/4	1/8 x 1/16
WH12D	.20			1 1/2	1.000	1/2	1 1/2	1 1/2	

Case hardened worms have ground and polished threads (Indicated by letter "G" in catalog number).



Worm and Worm Gears

12 Pitch • 1/2" Face • 14 1/2° Pressure Angle

Right Hand Quadruple Thread (Stocked Right Hand Only)

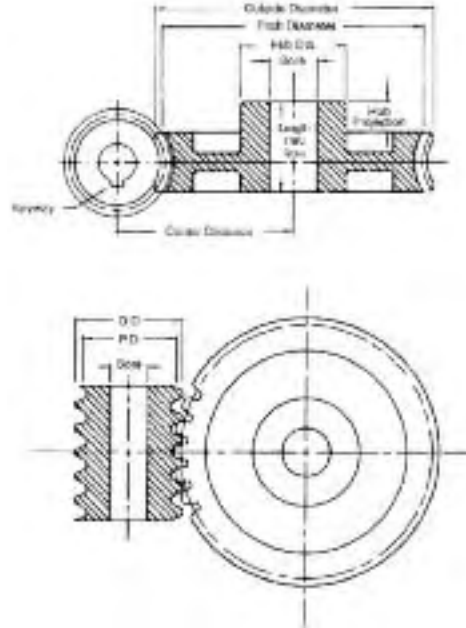

Cast Iron

Number Teeth	Catalog Number Cast Iron	Weight Pounds (App.)	Pitch Dia.	Bore (Inches)	Hub (Inches)		Style
					Dia.	Proj.	
20	W1220Q	.32	1.666	1/2	1 1/4	1/2	PLAIN
30	W1230Q	.38	2.500	3/4	1 1/2	5/8	PLAIN
40	W1240Q	.80	3.333	3/4	1 3/4	5/8	W

W = WEB



Steel — 18° 26' Helix Angle Worms

Catalog Number Soft	Weight Pounds (App.)	Catalog Number Hardened	Weight Pounds (App.)	Face (Inches)	Pitch Dia.	Bore (Inches)	Hub (Inches)		Keyway (Inches)
							Dia.	Proj.	
W12Q	.14	WG12Q	.14	1 1/2	1.000	3/4	1 1/4	1/2	1/8 x 1/16
WH12Q	.20			1 1/2	1.000	1/2	1 1/2	5/8	

Worm and Worm Gears

16 Pitch • $\frac{5}{16}$ " Face • $14\frac{1}{2}$ ° Pressure Angle



Right Hand Single Thread (Stocked Right Hand Only)

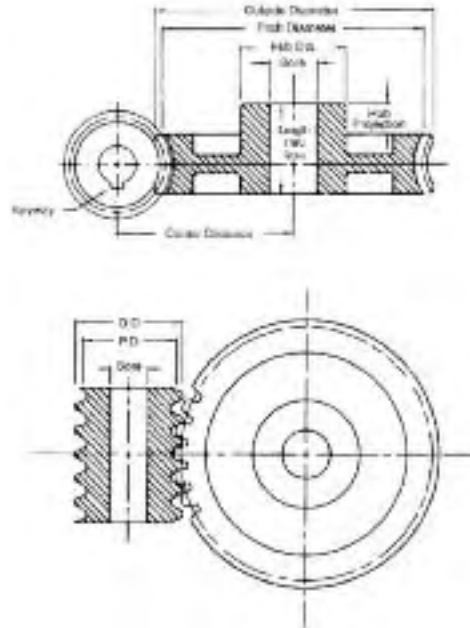

GEARS

Bronze

Number Teeth	Catalog Number	Weight Pounds (App.)	Pitch Dia.	Bore (Inches)	Hub (Inches)		Style
					Dia.	Proj.	
20	WB1620	.13	1.250	$\frac{1}{4}$	$\frac{3}{8}$	$\frac{5}{16}$	PLAIN
30	WB1630	.28	1.875	$\frac{5}{16}$	$\frac{3}{8}$	$\frac{3}{8}$	W
40	WB1640	.42	2.500	$\frac{5}{16}$	$\frac{3}{8}$	$\frac{3}{8}$	W
50	WB1650	.50	3.125	$\frac{3}{8}$	$\frac{3}{8}$	$\frac{7}{16}$	W

W = WEB



Steel — 5° 43' Helix Angle Worms

Catalog Number Soft	Weight Pounds (App.)	Catalog Number Hardened	Weight Pounds (App.)	Face (Inches)	Pitch Dia.	Bore (Inches)	Hub (Inches)	
							Dia.	Proj.
WH16	.08	WHG16	.07	1	.625	$\frac{1}{4}$.46	$\frac{1}{4}$
				1	.625	$\frac{5}{16}$.46	$\frac{1}{4}$

Case hardened worms have ground and polished threads (indicated by letter "G" in catalog number).



Worm and Worm Gears

16 Pitch • $\frac{5}{16}$ " Face • $14\frac{1}{2}^\circ$ Pressure Angle

Right Hand Double Thread (Stocked Right Hand Only)

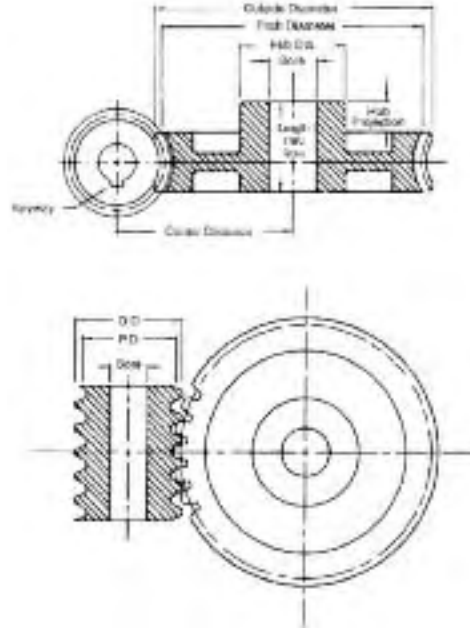

Bronze

Number Teeth	Catalog Number	Weight Pounds (App.)	Pitch Dia.	Bore (Inches)	Hub (Inches)		Style
					Dia.	Proj.	
20	WB1620D	.14	1.250	$\frac{1}{4}$	$\frac{5}{8}$	$\frac{5}{16}$	PLAIN



Steel — $11^\circ 19'$ Helix Angle Worms

Catalog Number Soft	Weight Pounds (App.)	Face (Inches)	Pitch Dia.	Bore (Inches)	Hub (Inches)	
					Dia.	Proj.
WH16D	.09	1	.625	$\frac{1}{4}$.46	$\frac{1}{4}$

Worm and Worm Gears

16 Pitch • $\frac{5}{16}$ " Face • $14\frac{1}{2}$ ° Pressure Angle



Right Hand Quadruple Thread (Stocked Right Hand Only)

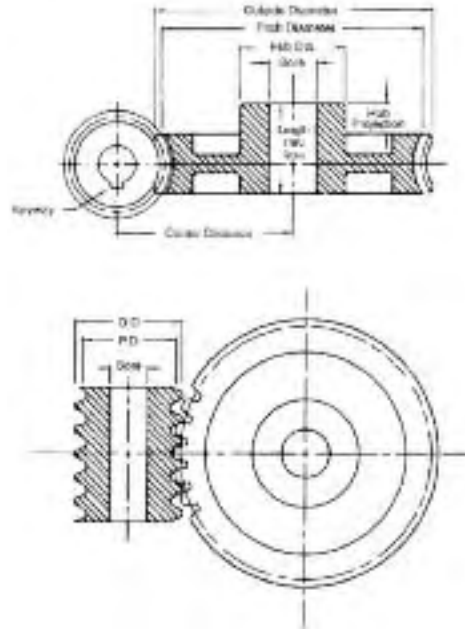

GEARS

Bronze

Number Teeth	Catalog Number	Weight Pounds (App.)	Pitch Dia.	Bore (Inches)	Hub (Inches)		Style
					Dia.	Proj.	
20	WB1620Q	.14	1.250	$\frac{1}{4}$	$\frac{5}{8}$	$\frac{5}{16}$	PLAIN



Steel — 21° 48' Helix Angle Worms

Catalog Number Soft	Weight Pounds (App.)	Face (Inches)	Pitch Dia.	Bore (Inches)	Hub (Inches)	
					Dia.	Proj.
WH16Q	.08	1	.625	$\frac{1}{4}$.46	$\frac{1}{4}$



Worm Gears

Ratio-Center Distance Listings With Approximate Horsepower and Torque† Ratings for Hardened and Ground Worms With Bronze Worm Gears

RPM of Worm		*Gear	1800		900		300		100	
Center			Input-Output		Input-Output		Input-Output		Input-Output	
Ratio	Distance		HP	Torque	HP	Torque	HP	Torque	HP	Torque
5	.938	WB1620Q	.37	60	.25	70	.09	80	.03	80
5	1.333	WB1220Q	.80	130	.55	170	.25	200	.08	215
5	1.625	WB1020Q	1.25	200	.90	275	.40	350	.15	370
5	2.000	WB820Q	2.00	315	1.50	460	.80	890	.33	965
5	2.667	WB620Q	3.70	600	2.75	880	1.40	1280	.55	1430
6	3.000	WB624Q	4.50	880	3.40	1300	1.75	1900	.70	2180
7.5	1.250	WB1630Q	.50	130	.33	160	.14	180	.05	185
7.5	1.750	WB1230Q	1.25	300	.85	390	.33	460	.13	490
7.5	2.125	WB1030Q	1.90	450	1.33	560	.60	790	.25	850
7.5	2.625	WB830Q	3.00	725	2.25	1060	1.00	1400	.40	1520
7.5	3.500	WB630Q	5.75	1400	4.33	2060	2.20	2960	.87	3330
9.67	4.050	WB529T	8.40	2615	6.25	3785	3.33	5730	1.33	6540
10	.938	WB1620D	.25	70	.15	85	.06	90	.02	95
10	1.333	WB1220D	.50	155	.33	205	.16	240	.06	250
10	1.562	WB1640Q	.75	240	.50	285	.18	320	.06	330
10	1.625	WB1020D	.80	230	.60	325	.25	400	.10	430
10	2.000	WB820D	1.25	365	.90	525	.45	690	.15	750
10	2.167	WB1240Q	1.67	530	1.10	700	.50	830	.17	880
10	2.625	WB1040Q	2.50	805	1.75	1120	.80	1400	.30	1500
10	2.667	WB620D	2.40	735	1.80	1075	.95	1540	.37	1700
10	3.250	WB840Q	4.00	1300	3.00	1880	1.40	2500	.50	2700
10	4.333	WB640Q	7.75	2500	5.75	3675	3.00	5333	1.15	5980
12	3.000	WB624D	2.85	1050	2.20	1550	1.15	2200	.45	2450
12.5	1.875	WB1650Q	.95	375	.60	445	.25	500	.08	515
12.5	2.583	WB1250Q	2.00	820	1.40	1080	.60	1300	.20	1370
12.5	3.125	WB1050Q	3.00	1250	2.25	1740	1.00	2200	.33	2340
12.5	3.875	WB850Q	4.90	2000	3.70	2900	1.70	3840	.65	4170
12.5	5.167	WB650Q	9.50	3800	7.00	5600	3.60	8200	1.40	9200
13.33	5.150	WB540T	11.00	4720	8.20	6830	4.40	10360	1.75	11800
15	1.250	WB1630D	.33	155	.25	180	.08	200	.03	210
15	1.750	WB1230D	.75	350	.50	450	.25	535	.07	560
15	2.125	WB1030D	1.20	520	.87	725	.37	900	.15	965
15	2.188	WB1660Q	1.10	570	.70	680	.25	760	.10	790
15	2.625	WB830D	1.67	750	1.25	1080	.60	1415	.25	1530
15	3.000	WB1260Q	2.50	1170	1.67	1540	.70	1800	.25	1930
15	3.500	WB630D	3.50	1620	2.70	2375	1.40	3370	.55	3770
15	3.625	WB1060Q	3.75	1700	2.67	2500	1.17	3100	.50	3300
15	4.500	WB860Q	5.75	2820	4.33	4100	2.00	5470	.75	6000
15	6.000	WB660Q	11.33	5550	8.50	8000	4.33	11700	1.70	13100
16.67	6.150	WB550T	13.50	7250	10.00	10500	5.40	16000	2.20	18000
18	5.000	WB318	6.00	3100	4.67	4570	3.00	8000	1.50	10000
18	7.000	WB672Q	13.50	7800	10.00	11400	5.00	16500	2.00	18500
20	.938	WB1620	.15	75	.10	90	.04	100	.02	105
20	1.333	WB1220	.33	170	.25	220	.10	260	.04	275
20	1.562	WB1640D	.50	270	.30	310	.10	350	.04	350
20	1.625	WB1020	.50	250	.33	350	.20	440	.07	470

* Ratings listed are for bronze worm gears operating with hardened and ground steel worms. For ratings of cast iron worm gears with hardened steel worm, multiply listed ratings by 30%. For cast iron with hardened and ground steel worm, multiply by 50%.

† Torque ratings in inch pounds.

GEARS

Worm Gears



Ratio-Center Distance Listings With Approximate Horsepower and Torque† Ratings for Hardened and Ground Worms With Bronze Worm Gears

RPM of Worm			1800		900		300		100	
Center		*Gear	Input-Output		Input-Output		Input-Output		Input-Output	
Ratio	Distance		HP	Torque	HP	Torque	HP	Torque	HP	Torque
20	2.000	WB820	.75	400	.60	600	.33	775	.12	850
20	2.167	WB1240D	1.00	600	.67	775	.33	920	.10	970
20	2.625	WB1040D	1.50	900	.85	1230	.50	1500	.20	1650
20	2.667	WB620	1.50	800	1.15	1170	.75	1660	.25	1850
20	2.812	WB1680Q	1.40	900	.90	1075	.33	1200	.12	1240
20	3.250	WB840D	2.30	1400	1.75	2000	.80	2580	.33	2800
20	3.833	WB1280Q	3.12	2000	2.12	2600	.90	3120	.33	3300
20	4.000	WB420	3.50	2000	2.75	2880	1.75	4700	.75	5600
20	4.333	WB640D	4.50	2780	3.40	4050	1.75	5800	.70	6500
20	4.625	WB1080Q	4.75	3000	3.40	4250	1.50	5340	.50	5700
20	5.750	WB880Q	7.50	4800	5.60	7000	2.60	9400	1.00	10200
20	7.667	WB680Q	15.00	9500	10.75	13800	5.50	20000	2.20	22500
24	3.000	WB624	1.75	1120	1.33	1630	.75	2300	.33	2600
24	4.500	WB424	4.00	2800	3.00	4000	2.00	6600	.90	7800
24	6.000	WB324	7.50	5300	5.90	7750	3.90	13500	1.90	17000
25	1.875	WB1650D	.50	370	.33	470	.12	520	.05	540
25	2.583	WB1250D	1.20	890	.80	1150	.33	1380	.12	1450
25	3.125	WB1050D	1.80	1340	1.33	1850	.60	2300	.25	2500
25	3.438	WB16100Q	1.75	1300	1.00	1575	.40	1750	.12	1800
25	3.875	WB850D	3.00	2200	2.25	3250	1.00	4200	.40	4500
25	4.667	WB12100Q	3.67	2800	2.50	3660	1.00	4400	.40	4630
25	5.167	WB650D	5.50	4000	4.00	6000	2.15	8700	.87	9700
25	5.625	WB10100Q	5.70	4500	4.10	6380	1.75	8000	.67	8500
25	7.000	WB8100Q	10.00	9700	7.00	11500	4.00	17500	1.25	19000
25	9.333	WB6100Q	17.50	14250	13.00	20750	6.66	30000	2.60	33000
29	4.050	WB529	3.50	2800	2.75	4200	1.50	6300	.67	7000
30	1.250	WB1630	.20	160	.12	190	.06	210	.02	215
30	1.750	WB1230	.50	350	.33	450	.15	540	.06	570
30	2.125	WB1030	.70	530	.50	750	.25	925	.10	1000
30	2.188	WB1660	.60	590	.40	700	.15	760	.05	800
30	2.625	WB830	1.00	870	.85	1260	.40	1600	.17	1750
30	3.000	WB1260D	1.33	1230	1.00	1600	.40	1900	.15	2000
30	3.500	WB630	2.00	1700	1.60	2430	.87	3500	.33	3800
30	3.625	WB1060D	2.00	1850	1.50	2500	.70	3200	.25	3430
30	4.500	WB860D	3.25	2900	2.50	4300	1.12	5650	.50	6000
30	6.000	WB660D	6.30	5800	4.80	6075	2.50	12110	1.00	13510
30	7.000	WB330	9.05	7880	7.00	11570	4.60	20280	2.25	25560
32	5.500	WB432	5.15	4680	4.00	6750	2.50	11140	1.10	13200
36	4.000	WB636	2.33	2310	1.80	3380	1.00	4800	.42	5360
36	7.000	WB672D	7.25	8010	5.50	11670	2.87	16700	1.15	18650
36	8.000	WB336	10.40	10900	8.10	15960	5.35	27950	2.60	35280
40	1.562	WB1640	.25	266	.12	330	.07	350	.02	360
40	2.167	WB1240	.55	580	.30	825	.18	900	.07	940
40	2.625	WB1040	.87	890	.65	1220	.30	1520	.12	1630
40	2.812	WB1680D	.75	910	.33	1140	.20	1200	.07	1230

* Ratings listed are for bronze worm gears operating with hardened and ground steel worms. For ratings of cast iron worm gears with hardened steel worm, multiply listed ratings by 30%. For cast iron with hardened and ground steel worm, multiply by 50%.

† Torque ratings in inch pounds.



Worm Gears

Ratio-Center Distance Listings With Approximate Horsepower and Torque† Ratings for Hardened and Ground Worms With Bronze Worm Gears

RPM of Worm			1800		900		300		100	
Center		*Gear	Input-Output		Input-Output		Input-Output		Input-Output	
Ratio	Distance		HP	Torque	HP	Torque	HP	Torque	HP	Torque
40	3.250	WB840	1.35	1440	.85	2350	.50	2700	.20	2900
40	3.833	WB1280D	1.70	2040	1.15	2675	.50	3160	.20	3330
40	4.333	WB640	2.50	2770	2.00	4033	1.00	5760	.45	6420
40	4.625	WB1080D	2.60	3070	1.90	4270	.85	5315	.33	5680
40	5.150	WB540	4.33	4930	3.40	7145	2.00	10725	.83	12170
40	5.750	WB880D	4.00	4740	3.00	6850	1.40	8940	.55	9680
40	6.500	WB440	6.00	5520	4.65	7950	3.00	13200	1.33	15480
40	7.667	WB680D	7.83	9600	6.00	14000	3.00	20025	1.25	22340
48	3.750	WB848	1.50	1950	1.20	2820	.60	3650	.25	3960
48	5.000	WB648	2.80	3730	2.25	5460	1.25	7750	.50	8640
48	7.500	WB448	6.80	9320	5.25	13400	3.33	22200	1.50	26160
48	10.000	WB348	12.70	17640	9.87	25920	6.50	45360	3.16	57120
50	1.875	WB1650	.30	380	.20	450	.08	490	.03	515
50	2.583	WB1250	.66	840	.50	1090	.20	1300	.08	1360
50	3.125	WB1050	1.00	1280	.75	1770	.33	2200	.14	2340
50	3.438	WB16100D	.90	1290	.50	1525	.25	1690	.08	1730
50	3.875	WB850	1.60	2140	1.25	3130	.66	4090	.25	4430
50	4.667	WB12100D	2.00	2875	1.33	3600	.50	4460	.22	4700
50	5.167	WB650	2.90	4000	2.25	5825	1.25	8310	.50	9260
50	5.625	WB10100D	3.00	4440	2.16	6110	1.00	7675	.33	8000
50	6.150	WB550	5.12	7120	4.00	10320	2.25	15480	1.00	17570
50	7.000	WB8100D	4.10	5000	2.75	7500	1.50	8000	.60	10000
50	9.333	WB6100D	9.00	13800	6.75	20200	3.50	28930	1.40	32280
54	11.000	WB354	13.50	21230	10.50	31200	7.00	54480	3.33	68760
59	7.050	WB559	5.50	9230	4.50	13900	2.50	20075	1.00	23160
60	2.188	WB1660	.33	550	.20	650	.08	720	.03	740
60	3.000	WB1260	.75	1100	.50	1440	.25	1700	.09	1790
60	3.625	WB1060	1.00	1690	.80	2330	.33	2890	.16	3080
60	4.500	WB860	1.66	2660	1.33	3900	.66	5090	.25	5500
60	6.000	WB660	3.20	5240	2.50	7670	1.40	1080	.60	1225
64	9.500	WB464	7.87	14280	6.00	20640	3.80	34080	1.70	40320
72	7.000	WB672	3.33	6610	2.50	9660	1.50	13700	.60	15360
80	2.812	WB1680	.33	705	.22	830	.09	920	.04	950
80	3.833	WB1280	.75	1550	.50	2030	.25	2375	.10	2520
80	4.625	WB1080	1.15	2375	.87	3275	.40	4050	.16	4330
80	5.750	WB880	1.80	3800	1.40	5500	.70	7140	.30	7750
80	7.667	WB680	3.33	7380	2.66	10750	1.50	15350	.60	17110
96	6.750	WB896	1.50	4200	1.00	6000	.50	7000	.20	8500
96	9.000	WB696	3.25	8490	2.50	12370	1.33	17660	.50	19680
100	3.438	WB16100	.33	810	.20	960	.09	1060	.33	1100
100	4.667	WB12100	.75	1790	.50	2330	.25	2730	.90	2800
100	5.625	WB10100	1.00	2780	.80	3850	.33	4775	.16	5100
100	7.000	WB8100	1.67	4450	1.25	6300	.67	8000	.24	9000
100	9.333	WB6100	3.20	8700	2.50	12675	1.33	18090	.55	20160

* Ratings listed are for bronze worm gears operating with hardened and ground steel worms. For ratings of cast iron worm gears with hardened steel worm, multiply listed ratings by 30%. For cast iron with hardened and ground steel worm, multiply by 50%.

† Torque ratings in inch pounds.

Gear Standards



Quality is the most important factor in buying a gear. We have established Standards and Tolerances to insure our customers of accurate, dependable and long-lasting gears. All gears are checked with precision pins to assure correct backlash and center distances.

BACKLASH: All stock gears are checked between centers for backlash. The recommended backlash for mating gears when assembled is:

3 DP.....	.009 — .014	10 DP003 — .005
4 DP.....	.007 — .011	12 DP003 — .005
5 DP.....	.006 — .009	16 DP002 — .004
6 DP.....	.005 — .008	20 DP002 — .004
8 DP.....	.004 — .006	24 DP002 — .004

CONCENTRICITY of pitch line with bore (Total Indicator Reading) is held within:

3 DP.....	.006	10 DP004
4 DP.....	.006	12 DP004
5 DP.....	.005	16 DP0025
6 DP.....	.005	20 DP0025
8 DP.....	.005	24 DP0025

Stock bores are reamed, honed or ground to a smooth finish and standard commercial tolerances or closer. For rust prevention on distributor's shelf and for better appearance when received by the user, all stock gears go through a special finishing process. They present a pleasing appearance when on display or on the shelf. They are not boxed. All gears are identified by part numbers.

**Gear
Engineering
Data**

**Spur Gear
Gear Formulas
Drive Selection
Horsepower and Torque
Tables**

Stock Spur Gear Drive Selection

When designing a stock gear drive using the horsepower tables in this catalog, the following steps must be taken:

I. Find out these five necessary things:

- a. Exact center distance in inches
- b. Ratio and speeds
- c. Service factor (from page G-84)
- d. Actual horsepower
- e. Bore sizes of both gears

II. Determine Design Horsepower using formula:

$$DHP = HP \times SF$$

Where: DHP = Design Horsepower

HP = Actual Horsepower

SF = Service Factor (from page G-84)

III. Determine Pitch Diameters using the formulas:

$$PD_1 = \frac{CD \times 2}{\text{Ratio} + 1}$$

$$PD_2 = PD_1 \times \text{Ratio}$$

Where: PD_1 = Pitch Diameter of Pinion (small gear)

PD_2 = Pitch Diameter of Gear (large gear)

CD = Center Distance

IV. Check the Center Distance:

$$CD = \frac{PD_1 + PD_2}{2}$$

V. Select Pitch from Horsepower tables on pages G-25 — G-27.

VI. Check Selected pitch for necessary Pitch Diameters.

VII. Check Horsepower capacity of Large Gear.

VIII. Check maximum bore capacity of selected Gears.

Spur Gear Drive Selection II (Other Than Stock)

When designing a gear drive when horsepower and speeds exceed the stock gear tables on pages G-25 — G-27, the following steps must be taken:

I. We must obtain all of the following data:

- a. Exact center distance in inches
- b. Ratio and speeds
- c. Service factor (from page G-84)
- d. Actual horsepower
- e. Bore sizes of both gears

II. Determine Design Horsepower using formula:

$$DHP = HP \times SF$$

Where: DHP = Design Horsepower

HP = Actual Horsepower

SF = Service Factor (from page G-84)

III. Determine Pitch Diameters using the formulas:

$$PD_1 = \frac{CD \times 2}{\text{Ratio} + 1}$$

$$PD_2 = PD_1 \times \text{Ratio}$$

Where: PD_1 = Pitch Diameter of Pinion (small gear)

PD_2 = Pitch Diameter of Gear (large gear)

CD = Center Distance

IV. Determine velocity using the formula:

$$V = .262 \times PD \times \text{RPM}$$

Where: V = Velocity in feet per minute @ pitch line

PD = Pitch Diameter

RPM = Revolutions per minute of either gear*

V. Determine approximate pitch using the formula:

$$DP = \sqrt{\frac{3.1416 \times S \times 3 \times V \times .25}{DHP \times 27.5 (1200 + V)}}$$

Where: DP = Diametral Pitch

S = Safe Static Stress per Square Inch of material
(see table one, page G-84)

V = Velocity in FPM

DHP = Design Horsepower

Note: To round off answers, go to the nearest DP
(standard DP's larger than 3 DP are: 1 DP, 1½ DP, 1¾ DP, 2 DP, 2½ DP)

VI. Determine number of teeth on both gears:

$$N = PD \times DP$$

Where: N = Number of teeth

PD = Pitch Diameter of gear

DP = Diametral Pitch of gear

NOTE: Velocities of both gears will always be the same. When using the above formula make sure to use the proper speed (RPM) with the proper pitch diameter.

Spur Gear Drive Selection II (Other Than Stock)

VII. Determine Face Width:

$$F = DP \left(\frac{DHP \times 33,000}{V} \right) \frac{1}{SY \left(\frac{600}{600 + V} \right)}$$

Where: F = Face Width

DP = Diametral Pitch

V = Velocity in FPM

S = Safe Static Stress per Square Inch of material
(Table 1, page G-84)

Y = Outline formula from Table 2, page G-84

Note: To round off each answer, go to the next one inch.

VIII. Check HP rating of selected pinion using the formula:

$$HP = \frac{LV}{33,000}$$

Where: $L = \frac{SYF}{DP} \times \frac{600}{600 + V}$

From horsepower formulas on page G-83.

Note: If the horsepower capacity is below the design horsepower, the following options can be taken:
A. Harden pinion (check gear HP capacity first)
B. Increase face
C. Increase pitch

Center Distance, Pitch Diameters and Ratios of Spur Gears

To determine the pitch diameters of a gear set, we must find two basic things:

1. Required ratio
2. Required center distance

Knowing this, first figure out the pitch diameter of the pinion (smaller gear) using the formula:

$$PD_1 = \frac{CD \times 2}{Ratio + 1}$$

Where: PD₁ = Pitch Diameter of the Pinion

CD = Center Distance

Then, find the pitch diameter of the larger gear, PD₂, by using the formula:

$$PD_2 = PD_1 \times Ratio$$

Then check the center distance by using the formula:

$$CD = \frac{PD_1 + PD_2}{2}$$

Horsepower Formulas

See page G-84 for tables one, two and three

Engineering Data

Lewis Formula (with Barth Revision)

L = Load in pounds at pitch line

S = Safe static stress per square inch of material
(see table one)

DP = Diametral Pitch

F = Face width of gear

Y = Strength factor based on Pressure Angle and
Number of Teeth (See table two)

V = Velocity in feet per minute
 $V = .262 \times PD \times RPM$

PD = Pitch Diameter

RPM = Revolutions Per Minute

HP = Horsepower

$$L = \frac{SFY}{DP} \times \frac{600}{600 + V}$$

Maximum allowable torque (T) that should be imposed on a gear will be the safe tooth load (L) multiplied by

$$\frac{DP}{2} \text{ or } T = \frac{L \times PD}{2}$$

The safe Horsepower capacity of the gear (at a given RPM) can be calculated from $HP = \frac{T \times RPM}{63,025}$ or directly from (L) and (V):

$$*HP = \frac{LV}{33,000}$$

$$\text{For a known HP, } T = \frac{63025 \times HP}{RPM}$$

For NON-METALLIC GEARS, the modified Lewis Formula shown below may be used with (S) values of 6000 PSI for Phenolic Laminated material.

$$L = \frac{SFY}{DP} \left(\frac{150}{200 + V} + .25 \right)$$

* Apply SERVICE FACTOR (table three) for required horsepower.

Gear Standards



Table One

(S) Average values in pounds per square inch

Material	S
Steel — .40 Carbon	25000
— .20 Carbon	20000
Steel — .40 Carbon Heat Treated	35000
Cast Iron	12000
Bronze	10000
Non-Metallic	6000

Table Two

Outline factor Y for use with Diametral Pitch

Number of Teeth	14½ P.A. Involute	20 P.A. Involute	Number of Teeth	14½ P.A. Involute	20 P.A. Involute
10	.176	.201	26	.308	.344
11	.192	.226	28	.314	.352
12	.210	.245	30	.318	.358
13	.223	.264	35	.327	.373
14	.235	.276	40	.336	.389
15	.245	.289	45	.340	.399
16	.255	.295	50	.346	.408
17	.264	.302	60	.355	.421
18	.270	.308	70	.360	.429
19	.277	.314	80	.363	.436
20	.283	.320	90	.366	.442
21	.289	.326	100	.368	.446
22	.292	.330	150	.375	.458
23	.296	.333	200	.378	.463
24	.302	.337	RACK	.390	.484
25	.305	.340			

Table Three

Service factors

Multiply required horsepower by service factor recommended for type of service

Type of Load	Intermittent or 3 Hours per Day	8-10 Hours per Day	Continuous 24 Hours per Day
UNIFORM	.80	1.00	1.25
LIGHT SHOCK	1.00	1.25	1.50
MEDIUM SHOCK	1.25	1.50	1.80
HEAVY SHOCK	1.50	1.80	2.00

Rules and Formulas For Spur Gear Calculations

Diametral Pitch
Diametral Pitch is the Number of Teeth to Each Inch of the Pitch Diameter.

To Find	Having	Rule	Formula
The Diametral Pitch	The Circular Pitch	Divide 3.1416 by the Circular Pitch	$DP = \frac{3.1416}{CP}$
The Diametral Pitch	The Pitch Diameter and the Number of Teeth	Divide the Number of Teeth by Pitch Diameter	$DP = \frac{N}{D}$
The Diametral Pitch	The Outside Diameter and Number of Teeth	Divide the Number of Teeth plus 2 by Outside Diameter	$DP = \frac{N+2}{D}$
Pitch Diameter	The Number of Teeth and the Diametral Pitch	Divide Number of Teeth by the Diametral Pitch	$D' = \frac{N}{P}$
Pitch Diameter	The Number of Teeth and Outside Diameter	Divide the product of Outside Diameter and Number of Teeth by Number of Teeth plus 2	$D' = \frac{DN}{N+2}$
Pitch Diameter	The Outside Diameter and the Diametral Pitch	Subtract from the Outside Diameter the Quotient of 2 Divided by the Diametral Pitch	$D' = D - \frac{2}{P}$
Pitch Diameter	Addendum and the Number of Teeth	Multiply Addendum by the Number of Teeth	$D' = sN$
Outside Diameter	The Number of Teeth and the Diametral Pitch	Divide number of Teeth plus 2 by the Diametral Pitch	$D = \frac{N+2}{P}$
Outside Diameter	The Pitch Diameter and the Diametral Pitch	Add to the Pitch Diameter the quotient of 2 divided by the Diametral Pitch	$D = D' + \frac{2}{P}$
Outside Diameter	The Pitch Diameter and the Number of Teeth	Divide the Number of Teeth plus 2 by the quotient of Number of Teeth divided by Pitch Diameter	$D = \frac{N+2}{N \div D'}$
Outside Diameter	The Number of Teeth and Addendum	Multiply the Number of Teeth plus 2 by Addendum	$D = (N+2)s$
Number of Teeth	The Pitch Diameter and the Diametral Pitch	Multiply the Pitch Diameter by the Diametral Pitch	$N = D'P$
Number of Teeth	The Outside Diameter and the Diametral Pitch	Multiply Outside Diameter by the Diametral Pitch and subtract 2	$N = DP - 2$
Thickness of Tooth	The Diametral Pitch	Divide 1.5708 by the Diametral Pitch	$t = \frac{1.5708}{P}$
Addendum	The Diametral Pitch	Divide 1 by the Diametral Pitch or $A = \frac{D'}{N}$	$A = \frac{1}{P}$
Dedendum	The Diametral Pitch	Divide 1.157 by the Diametral Pitch	$A+L = \frac{1.157}{P}$
Working Depth	The Diametral Pitch	Divide 2 by the Diametral Pitch	$WD = \frac{2}{P}$
Whole Depth	The Diametral Pitch	Divide 2.157 by the Diametral Pitch	$D'' = \frac{2.157}{P}$
Clearance	The Diametral Pitch	Divide .157 by the Diametral Pitch	$L = \frac{.157}{P}$
Clearance	Thickness of Tooth	Divide Thickness of Tooth at Pitch Line by 10	$L = \frac{t}{10}$

NOTE: Rules and Formulas Relating to Tooth Depth and Outside Diameter Apply to Full-Depth, Equal Addendum Gears.

Diametral Pitch Tooth Dimensions



Dimensions of Standard Full-depth Teeth

Diametral Pitches and Equivalent Circular Pitches

Diametral Pitch	Circular Pitch	Module	Arc Thickness of Tooth on Pitch Line	Addendum	Working Depth of Tooth	Dedendum or Depth of Space Below Pitch Line	Whole Depth of Tooth*
1/2	6.2832	50.8	3.1416	2.0000	4.0000	2.3142	4.3142
3/4	4.1888	33.8667	2.0944	1.3333	2.6666	1.5428	2.8761
1	3.1416	25.4	1.5708	1.0000	2.0000	1.1571	2.1571
1-1/4	2.5133	20.32	1.2566	0.8000	1.6000	0.9257	1.7257
1-1/2	2.0944	16.9333	1.0472	0.6666	1.3333	0.7714	1.4381
1-3/4	1.7952	14.5143	0.8976	0.5714	1.1429	0.6612	1.2326
2	1.5708	12.7	0.7854	0.5000	1.0000	0.5785	1.0785
2-1/4	1.3963	11.2889	0.6981	0.4444	0.8888	0.5143	0.9587
2-1/2	1.2566	10.16	0.6283	0.4000	0.8000	0.4628	0.8628
2-3/4	1.1424	9.2364	0.5712	0.3636	0.7273	0.4208	0.7844
3	1.0472	8.4667	0.5236	0.3333	0.6666	0.3857	0.7190
3-1/2	0.8976	7.2571	0.4488	0.2857	0.5714	0.3306	0.6163
4	0.7854	6.35	0.3927	0.2500	0.5000	0.2893	0.5393
5	0.6283	5.08	0.3142	0.2000	0.4000	0.2314	0.4314
6	0.5236	4.2333	0.2618	0.1666	0.3333	0.1928	0.3595
7	0.4488	3.6286	0.2244	0.1429	0.2857	0.1653	0.3081
8	0.3927	3.175	0.1963	0.1250	0.2500	0.1446	0.2696
9	0.3491	2.8222	0.1745	0.1111	0.2222	0.1286	0.2397
10	0.3142	2.54	0.1571	0.1000	0.2000	0.1157	0.2157
11	0.2856	2.3091	0.1428	0.0909	0.1818	0.1052	0.1961
12	0.2618	2.1167	0.1309	0.0833	0.1666	0.0964	0.1798
13	0.2417	1.9538	0.1208	0.0769	0.1538	0.0890	0.1659
14	0.2244	1.8143	0.1122	0.0714	0.1429	0.0826	0.1541
15	0.2094	1.6933	0.1047	0.0666	0.1333	0.0771	0.1438
16	0.1963	1.5875	0.0982	0.0625	0.1250	0.0723	0.1348
17	0.1848	1.4941	0.0924	0.0588	0.1176	0.0681	0.1269
18	0.1745	1.4111	0.0873	0.0555	0.1111	0.0643	0.1198
19	0.1653	1.3368	0.0827	0.0526	0.1053	0.0609	0.1135
20	0.1571	1.27	0.0785	0.0500	0.1000	0.0579	0.1079
22	0.1428	1.1545	0.0714	0.0455	0.0909	0.0526	0.0980
24	0.1309	1.0583	0.0654	0.0417	0.0833	0.0482	0.0898
26	0.1208	.9769	0.0604	0.0385	0.0769	0.0445	0.0829
28	0.1122	.9071	0.0561	0.0357	0.0714	0.0413	0.0770
30	0.1047	.8467	0.0524	0.0333	0.0666	0.0386	0.0719
32	0.0982	.7938	0.0491	0.0312	0.0625	0.0362	0.0674
34	0.0924	.7471	0.0462	0.0294	0.0588	0.0340	0.0634
36	0.0873	.7056	0.0436	0.0278	0.0555	0.0321	0.0599
38	0.0827	.6684	0.0413	0.0263	0.0526	0.0304	0.0568
40	0.0785	.635	0.0393	0.0250	0.0500	0.0289	0.0539

*NOTE: Dimensions listed are for HOB CUT TEETH ONLY. Shaper cut teeth may be slightly larger. Consult factory for exact measurement.

All Gears In Stock Are Diametral Pitch

Rules and Formulas For Spur Gear Calculations

Circular Pitch

Circular Pitch is the Distance from the Center of One Tooth to the Center of the Next Tooth, Measured Along the Pitch Circle.

To Find	Having	Rule	Formula
The Circular Pitch	The Diametral Pitch	Divide 3.1416 by the Diametral Pitch	$C' = \frac{3.1416}{DP}$
The Circular Pitch	The Pitch Diameter and the Number of Teeth	Divide Pitch Diameter by the product of .3183 and Number of Teeth	$C' = \frac{PD}{.3183N}$
The Circular Pitch	The Outside Diameter and the Number of Teeth	Divide Outside Diameter by the product of .3183 and Number of Teeth plus 2	$C' = \frac{OD}{.3183 N + 2}$
Pitch Diameter	The Number of Teeth and the Circular Pitch	The continued product of the Number of Teeth, the Circular Pitch and .3183	$D' = NC' .3183$
Pitch Diameter	The Number of Teeth and the Outside Diameter	Divide the product of Number of Teeth and Outside Diameter by Number of Teeth plus 2	$D = \frac{N \times OD}{N + 2}$
Pitch Diameter	The Outside Diameter and the Circular Pitch	Subtract from the Outside Diameter the product of the Circular Pitch and .6366	$D' = OD - (C' .6366)$
Pitch Diameter	Addendum and the Number of Teeth	Multiply the Number of Teeth by the Addendum	$D' = NA$
Outside Diameter	The Number of Teeth and the Circular Pitch	The continued product of the Number of Teeth plus 2, the Circular Pitch and .3183	$D = (N + 2) C' .3183$
Outside Diameter	The Pitch Diameter and the Circular Pitch	Add to the Pitch Diameter the product of the Circular Pitch and .6366	$D = PD + (C' .6366)$
Outside Diameter	The Number of Teeth and the Addendum	Multiply Addendum by Number of Teeth plus 2	$D = A (N + 2)$
Number of Teeth	The Pitch Diameter and the Circular Pitch	Divide the product of Pitch Diameter and 3.1416 by the Circular Pitch	$N = \frac{PD 3.1416}{C'}$
Thickness of Tooth	The Circular Pitch	One-half the Circular Pitch	$t = \frac{C'}{2}$
Addendum	The Circular Pitch	Multiply the Circular Pitch by .3183 or $s = \frac{D'}{N}$	$A = C' .3183$
Dedendum	The Circular Pitch	Multiply the Circular Pitch by .3683	$A + L = C' .3683$
Working Depth	The Circular Pitch	Multiply the Circular Pitch by .6366	$WD = C' .6366$
Whole Depth	The Circular Pitch	Multiply the Circular Pitch by .6866	$D'' = C' .6866$
Clearance	The Circular Pitch	Multiply the Circular Pitch by .05	$L = C' .05$
Clearance	Thickness of Tooth	One-Tenth the Thickness of Tooth at Pitch Line	$L = \frac{t}{10}$

NOTE: Rules and Formulas Relating to Tooth Depth and Outside Diameter Apply to Full-Depth, Equal Addendum Gears.

Circular Pitch Gears Made To Order Only

Circular Pitch Tooth Dimensions



Dimensions of Standard Full-depth Teeth

Circular Pitches and Equivalent Diametral Pitches

Circular Pitch	Diametral Pitch	Module	Arc Thickness of Tooth on Pitch Line	Addendum	Working Depth of Tooth	Dedendum or Depth of Space Below Pitch Line	Whole Depth of Tooth
4	0.7854	32.3402	2.0000	1.2732	2.5464	1.4732	2.7464
3-1/2	0.8976	28.2581	1.7500	1.1140	2.2281	1.2890	2.4031
3	1.0472	24.2552	1.5000	0.9549	1.9098	1.1049	2.0598
2-3/4	1.1424	22.2339	1.3750	0.8753	1.7506	1.0128	1.8881
2-1/2	1.2566	20.2117	1.2500	0.7957	1.5915	0.9207	1.7165
2-1/4	1.3963	18.1913	1.1250	0.7162	1.4323	0.8287	1.5448
2	1.5708	16.1701	1.0000	0.6366	1.2732	0.7366	1.3732
1-3/4	1.6755	15.1595	0.9375	0.5968	1.1937	0.6906	1.2874
1-3/4	1.7952	14.1488	0.8750	0.5570	1.1141	0.6445	1.2016
1-3/8	1.9333	13.1382	0.8125	0.5173	1.0345	0.5985	1.1158
1-1/2	2.0944	12.1276	0.7500	0.4775	0.9549	0.5525	1.0299
1-1/4	2.1855	11.6223	0.7187	0.4576	0.9151	0.5294	0.9870
1-3/8	2.2848	11.1169	0.6875	0.4377	0.8754	0.5064	0.9441
1-5/16	2.3936	10.6116	0.6562	0.4178	0.8356	0.4834	0.9012
1-1/4	2.5133	10.1062	0.6250	0.3979	0.7958	0.4604	0.8583
1-3/16	2.6456	9.6010	0.5937	0.3780	0.7560	0.4374	0.8154
1-1/8	2.7925	9.0958	0.5625	0.3581	0.7162	0.4143	0.7724
1-1/8	2.9568	8.5904	0.5312	0.3382	0.6764	0.3913	0.7295
1	3.1416	8.0851	0.5000	0.3183	0.6366	0.3683	0.6866
9/16	3.3510	7.5798	0.4687	0.2984	0.5968	0.3453	0.6437
7/8	3.5904	7.0744	0.4375	0.2785	0.5570	0.3223	0.6007
9/16	3.8666	6.5692	0.4062	0.2586	0.5173	0.2993	0.5579
3/4	4.1888	6.0639	0.3750	0.2387	0.4775	0.2762	0.5150
11/16	4.5696	5.5586	0.3437	0.2189	0.4377	0.2532	0.4720
3/4	4.7124	5.3903	0.3333	0.2122	0.4244	0.2455	0.4577
5/8	5.0265	5.0532	0.3125	0.1989	0.3979	0.2301	0.4291
9/16	5.5851	4.5479	0.2812	0.1790	0.3581	0.2071	0.3862
1/2	6.2832	4.0426	0.2500	0.1592	0.3183	0.1842	0.3433
7/16	7.1808	3.5373	0.2187	0.1393	0.2785	0.1611	0.3003
3/8	7.8540	3.2340	0.2000	0.1273	0.2546	0.1473	0.2746
3/8	8.3776	3.0319	0.1875	0.1194	0.2387	0.1381	0.2575
1/8	9.4248	2.6947	0.1666	0.1061	0.2122	0.1228	0.2289
9/16	10.0531	2.5266	0.1562	0.0995	0.1989	0.1151	0.2146
3/8	10.9956	2.3100	0.1429	0.0909	0.1819	0.1052	0.1962
1/4	12.5664	2.0213	0.1250	0.0796	0.1591	0.0921	0.1716
3/8	14.1372	1.7967	0.1111	0.0707	0.1415	0.0818	0.1526
1/8	15.7080	1.6170	0.1000	0.0637	0.1273	0.0737	0.1373
3/16	16.7552	1.5160	0.0937	0.0597	0.1194	0.0690	0.1287
1/8	18.8496	.5053	0.0833	0.0531	0.1061	0.0614	0.1144

All Circular Pitch Gears Are Made-To-Order

Rules and Formulas For Module (Metric) Spur Gear Calculations

(Module Represents the Amount of Pitch Diameter per Tooth)

To Find	Having	Rule	Formula
Metric Module	Pitch Diameter and Number of Teeth	Divide Pitch Diameter in Millimeters by the Number of Teeth	$M = \frac{PD \text{ (Millimeters)}}{N}$
Metric Module	Circular Pitch in Millimeter	Divide Circular Pitch in Millimeters by Pi (3.1416)	$M = \frac{C \text{ (Millimeters)}}{3.1416}$
Metric Module	Diametral Pitch	Divide 25.4 by Diametral Pitch	$M = \frac{25.4}{DP}$
Metric Module	Outside Diameter and Number of Teeth	Divide Outside Diameter (in Millimeters) by the Number of Teeth plus 2	$M = \frac{OD}{N + 2}$
Pitch Diameter	Module and Number of Teeth	Multiply Module by Number of Teeth	$D' \text{ (In MM)} = M \times N$
Pitch Diameter	Number of Teeth and Outside Diameter	Divide the product of Outside Diameter and No. of Teeth by No. of Teeth plus 2	$D' = \frac{OD \times N}{N + 2}$
Pitch Diameter	Outside Diameter and the Module	Multiply Module by 2 and Subtract from Outside Diameter	$D' = OD - 2M$
Outside Diameter	Module and Number of Teeth	Number of Teeth plus 2 Multiplied by Module	$OD \text{ (In MM)} = (N + 2) \times M$
Diametral Pitch	Module	Divide 25.4 by Module	$DP = \frac{25.4}{M}$
Circular Pitch	Module	Multiply Module by Pi (3.1416)	$C' \text{ (In MM)} = M \times 3.1416$
Addendum	Module Known	The Addendum equals the Module	$A = M$
Whole Depth	Module Known	Multiply 2.157 by Module	$D'' \text{ (In MM)} = 2.157 \times M$
Thickness of Tooth	Module and Outside Diameter	Multiply Pitch Diameter (in Millimeters) by the Sine of the Angle of 90 Divided by the Number of Teeth	$t \text{ (In MM)} = PD \text{ (MM)} \times \text{Sine } \frac{90}{N}$
English Module	Pitch Diameter in Inches and Number of Teeth	Divide Pitch Diameter in Inches by Number of Teeth	$M = \frac{PD \text{ (Inches)}}{N}$ (Answer in Fraction)

NOTE: Rules and Formulas Relating to Tooth Depth and Outside Diameter Apply to Full-Depth, Equal Addendum Gears.

Module Pitch Tooth Dimensions



Tooth Dimensions Based Upon Module System

(One millimeter equals 0.03937 inch)

Module, DIN Standard Series	Equivalent Diametral Pitch	Circular Pitch		Addendum, Millimeters	Dedendum, Millimeters†	Whole Depth, † Millimeters	Whole Depth, ‡ Millimeters
		Millimeters	Inches				
0.3	84.667	0.943	0.0371	0.30	0.35	0.650	0.647
0.4	63.500	1.257	0.0495	0.40	0.467	0.867	0.863
0.5	50.800	1.571	0.0618	0.50	0.583	1.083	1.079
0.6	42.333	1.885	0.0742	0.60	0.700	1.300	1.294
0.7	36.286	2.199	0.0865	0.70	0.817	1.517	1.510
0.8	31.750	2.513	0.0989	0.80	0.933	1.733	1.726
0.9	28.222	2.827	0.1113	0.90	1.050	1.950	1.941
1	25.400	3.142	0.1237	1.00	1.167	2.167	2.157
1.25	20.320	3.927	0.1546	1.25	1.458	2.708	2.697
1.5	16.933	4.712	0.1855	1.50	1.750	3.250	3.236
1.75	14.514	5.498	0.2164	1.75	2.042	3.792	3.774
2	12.700	6.283	0.2474	2.00	2.333	4.333	4.314
2.25	11.289	7.069	0.2783	2.25	2.625	4.875	4.853
2.5	10.160	7.854	0.3092	2.50	2.917	5.417	5.392
2.75	9.236	8.639	0.3401	2.75	3.208	5.958	5.932
3	8.466	9.425	0.3711	3.00	3.500	6.500	6.471
3.25	7.815	10.210	0.4020	3.25	3.791	7.041	7.010
3.5	7.257	10.996	0.4329	3.50	4.083	7.583	7.550
3.75	6.773	11.781	0.4638	3.75	4.375	8.125	8.089
4	6.350	12.566	0.4947	4.00	4.666	8.666	8.628
4.5	5.644	14.137	0.5566	4.50	5.25	9.750	9.707
5	5.080	15.708	0.6184	5.00	5.833	10.833	10.785
5.5	4.618	17.279	0.6803	5.50	6.416	11.916	11.864
6	4.233	18.850	0.7421	6.00	7.000	13.000	12.942
6.5	3.908	20.420	0.8035	6.50	7.583	14.083	14.021
7	3.628	21.991	0.8658	7.00	8.166	15.166	15.099
8	3.175	25.132	0.9895	8.00	9.333	17.333	17.256
9	2.822	28.274	1.1132	9.00	10.499	19.499	19.413
10	2.540	31.416	1.2368	10.00	11.666	21.666	21.571
11	2.309	34.558	1.3606	11.00	12.833	23.833	23.728
12	2.117	37.699	1.4843	12.00	14.000	26.000	25.884
13	1.954	40.841	1.6079	13.00	15.166	28.166	28.041
14	1.814	43.982	1.7317	14.00	16.332	30.332	30.198
15	1.693	47.124	1.8541	15.00	17.499	32.499	32.355
16	1.587	50.266	1.9790	16.00	18.666	34.666	34.512
18	1.411	56.549	2.2263	18.00	21.000	39.000	38.826
20	1.270	62.832	2.4737	20.00	23.332	43.332	43.142
22	1.155	69.115	2.7210	22.00	25.665	47.665	47.454
24	1.058	75.398	2.9685	24.00	28.000	52.000	51.768
27	0.941	84.823	3.339	27.00	31.498	58.498	58.239
30	0.847	94.248	3.711	30.00	35.000	65.000	64.713
33	0.770	103.673	4.082	33.00	38.498	71.498	71.181
36	0.706	113.097	4.453	36.00	41.998	77.998	77.652
39	0.651	122.522	4.824	39.00	45.497	84.497	84.123
42	0.605	131.947	5.195	42.00	48.997	90.997	90.594
45	0.564	141.372	5.566	45.00	52.497	97.497	97.065
50	0.508	157.080	6.184	50.00	58.330	108.330	107.855
55	0.462	172.788	6.803	55.00	64.163	119.163	118.635
60	0.423	188.496	7.421	60.00	69.996	129.996	129.426
65	0.391	204.204	8.040	65.00	75.829	140.829	140.205
70	0.363	219.911	8.658	70.00	81.662	151.662	150.997
75	0.339	235.619	9.276	75.00	87.495	162.495	161.775

† Dedendum and total depth when clearance = 0.1666 x module, or one-sixth module.

‡ Total Depth equivalent to American standard full-depth teeth. (Clearance = 0.157 x Module.)

To Find	Rule	Formula
Pitch Diameter	Divide Number of Teeth by Diametral Pitch	Pitch Diameter = $\frac{\text{Number of Teeth}}{\text{Diametral Pitch}}$
Tangent of Pitch Angle Of Driven	Divide Number of Teeth in Driven by Number of Teeth in Driver	Tangent Pitch Angle of Driven = $\frac{\text{Number of Teeth in Driven}}{\text{Number of Teeth in Driver}}$ = Ratio
Pitch Angle of Driver	Subtract Pitch Angle of Driven from 90 Degrees	Pitch Angle Of Driver = 90 Degrees - Pitch Angle of Driven
Pitch Cone Radius	Divide Pitch Diameter by Twice the Sine of the Pitch Angle	Pitch Cone Radius = $\frac{\text{Pitch Diameter}}{2 \times \text{Sine Pitch Angle}}$
Tangent of Addendum Angle	Divide Addendum by the Pitch Cone Radius	Tangent of Addendum Angle = $\frac{\text{Addendum}}{\text{Pitch Cone Radius}}$
Face Angle	Add Addendum Angle to Pitch Angle	Face Angle = Addendum Angle + Pitch Angle
Tangent of Dedendum Angle	Divide Dedendum by the Pitch Cone Radius	Tangent of Dedendum Angle = $\frac{\text{Dedendum}}{\text{Pitch Cone Radius}}$
Root Angle	Subtract Dedendum Angle from Pitch Angle	Root Angle = Pitch Angle - Dedendum Angle
Angular Addendum	Multiply Addendum by Cosine of Pitch Angle	Angular Addendum = Addendum x Cosine Pitch Angle
Outside Diameter	Add 2 Angular Addenda to Pitch Diameter	Outside Diameter = 2 Angular Addenda x Pitch Diameter
Mounting Distance	Add one-half the Pitch Diameter of Mating to Pitch Line	Mounting Distance = $\frac{\text{Pitch Diameter of Mate}}{2}$ + Backing to Pitch Line
Distance From Cone Center to Crown	Multiply one-half Outside Diameter by Co-tangent of Face Angle	Cone Center to Crown = $\frac{\text{Outside Diameter}}{2}$ x Co-Tangent Face Angle
Backing to Crown	Subtract Cone Center to Crown from Mounting Distance	Backing to Crown = Mounting Distance - Cone Center to Crown
Ratio	Divide Teeth in Driven by Teeth in Driver	Ratio = $\frac{\text{Number of Teeth in Driven}}{\text{Number of Teeth in Driver}}$

Formula For Worm Gears

(Based On Diametral Pitch)

To Find	Rule	Formula
Worm Gear Pitch Diameter	Divide Number of Teeth by Diametral Pitch	$\text{Pitch Diameter} = \frac{\text{Number of Teeth in Worm Gear}}{\text{Diametral Pitch}}$
Worm Gear Throat Diameter	Add 2 Addenda to Pitch Diameter	$\text{Throat Diameter} = (2 \times \text{Addendum}) + \text{Pitch Diameter}$
Worm Gear Outside Diameter	Add 3 Addenda to Pitch Diameter	$\text{Outside Diameter} = (3 \times \text{Addendum}) + \text{Pitch Diameter}$
Worm Pitch Diameter	Subtract the Worm Gear Pitch Diameter from Twice the Center Distance	$\text{Worm Pitch Diameter} = (2 \times \text{Center Distance}) - \text{Worm Gear Pitch Diameter}$
Worm Outside Diameter	Add 2 Addenda to Worm Pitch Diameter	$\text{Worm Outside Diameter} = \text{Worm Pitch Diameter} + 2 \times \text{Addendum}$
Worm Lead	Divide 3.1416 by Diametral Pitch and Multiply by Number of Threads in Worm	$\text{Worm Lead} = \frac{3.1416}{\text{Diametral Pitch}} \times \text{Number of Threads in Worm}$
Co-Tangent of Worm Helix Angle	Multiply Worm Pitch Diameter by Diametral Pitch and Divide by Number of Worm Threads	$\text{Co-Tangent Worm Helix Angle} = \frac{\text{Worm Pitch Diameter} \times \text{Diametral Pitch}}{\text{Number Worm Threads}}$
Center Distance	Add Worm Pitch Diameter to Worm Gear Pitch Diameter and Divide Sum by 2	$\text{Center Distance} = \frac{\text{Worm Pitch Diameter} + \text{Worm Gear Pitch Diameter}}{2}$
Ratio	Divide Number of Teeth in Worm Gear by Number of Worm Threads	$\text{Ratio} = \frac{\text{Number of Teeth in Worm Gear}}{\text{Number of Worm Threads}}$

NOTE: Tooth data (Addendum, Full Depth, Etc.) is same as for Spur Gears.

Comparative Sizes of Involute Gear Teeth

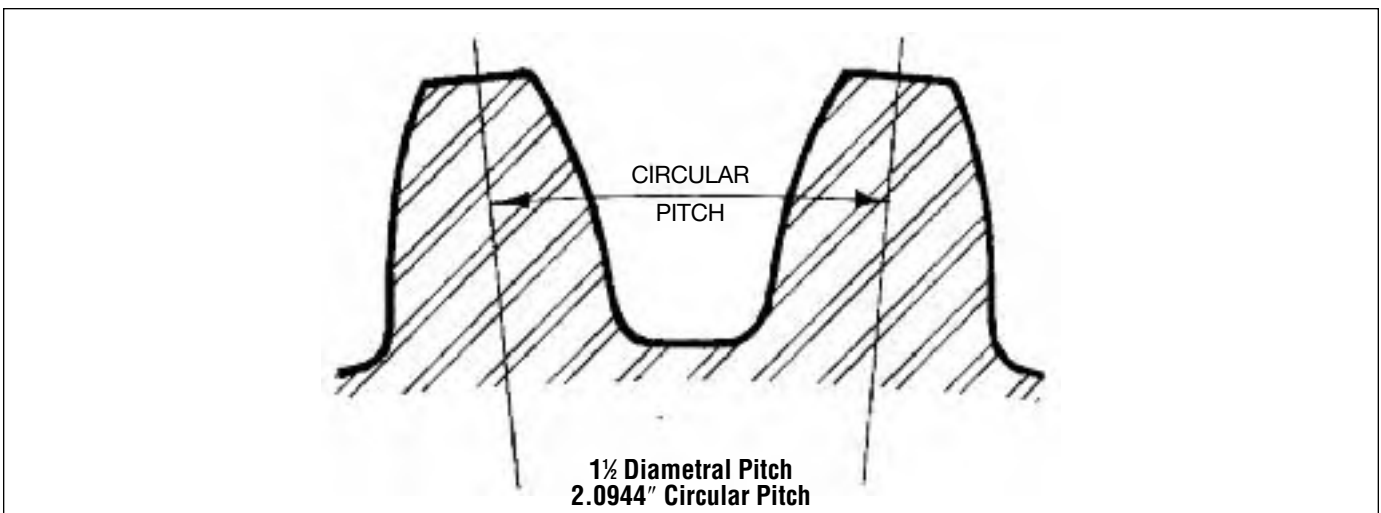
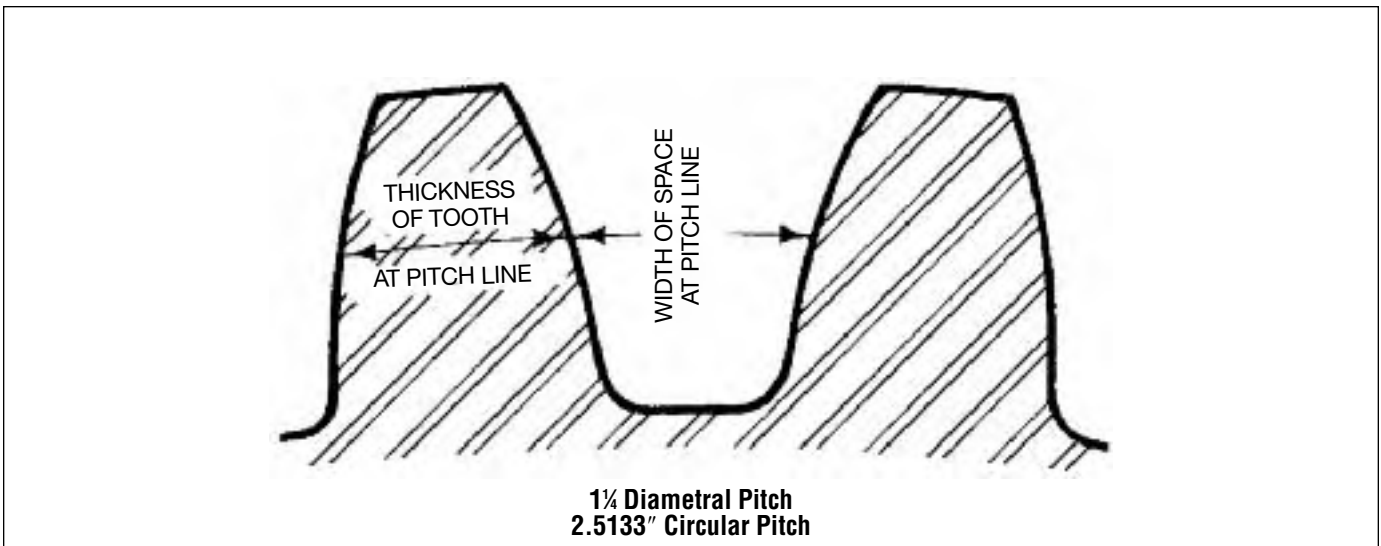
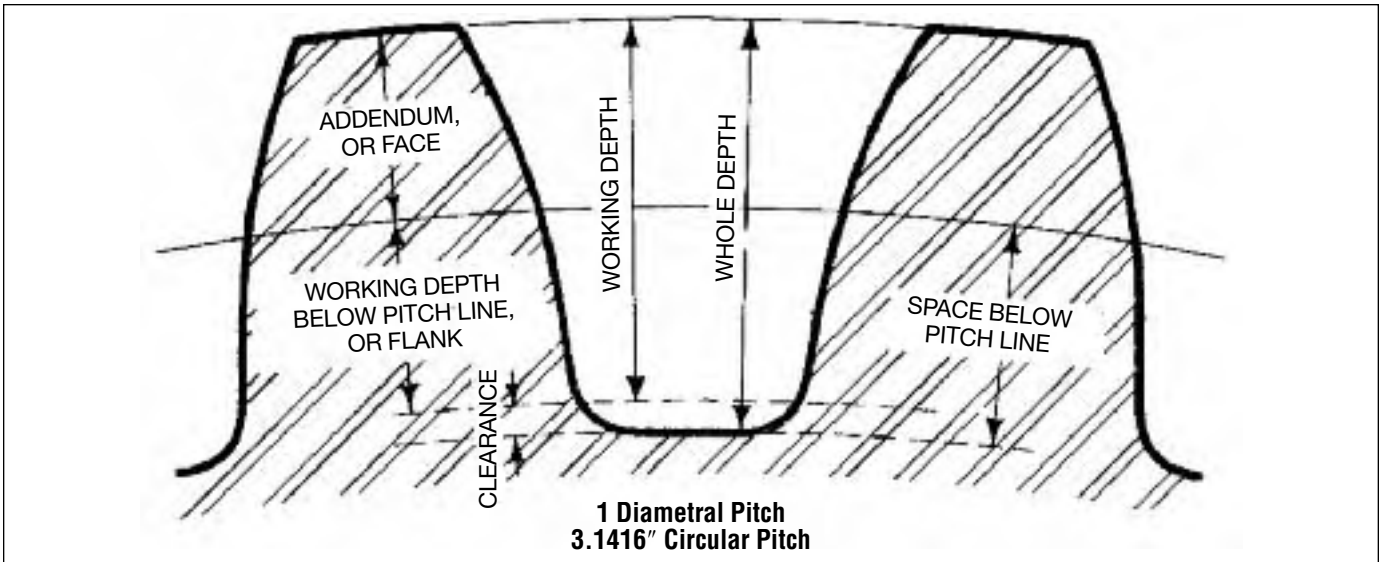

Cut Spur Gears

14½° P.A.



Comparative Sizes of Involute Gear Teeth

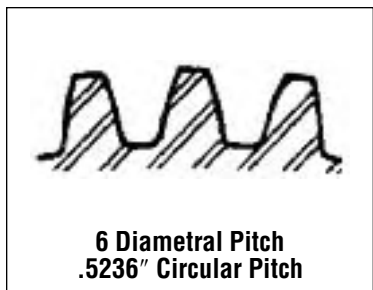
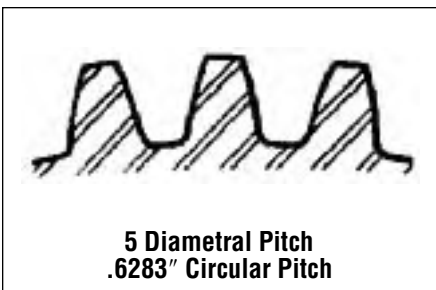
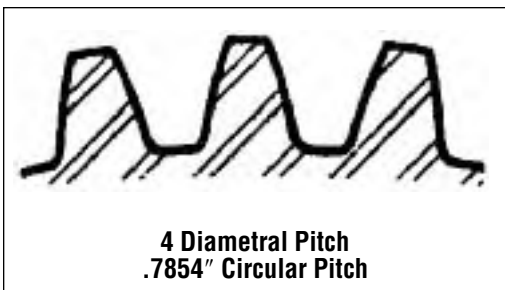
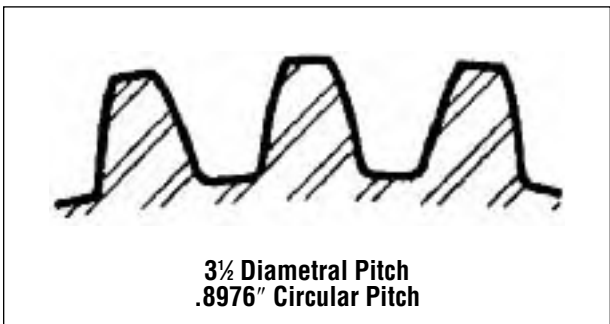
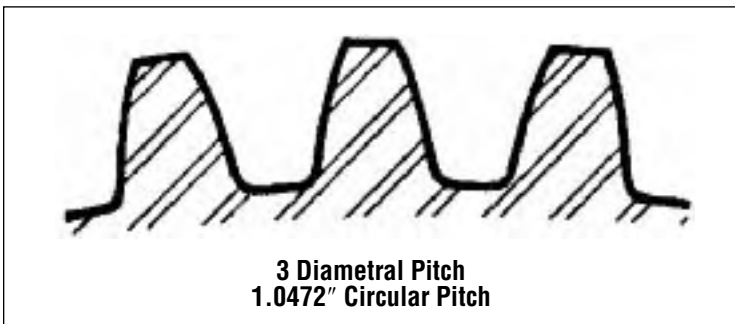
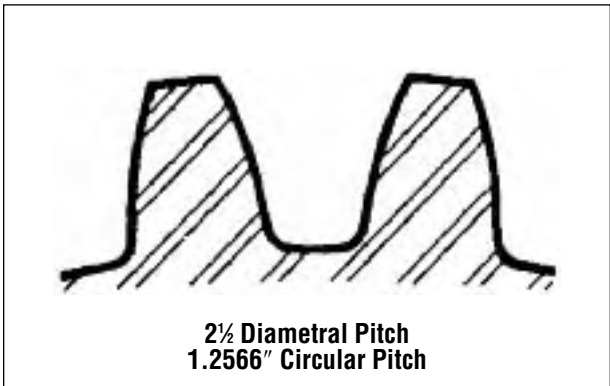
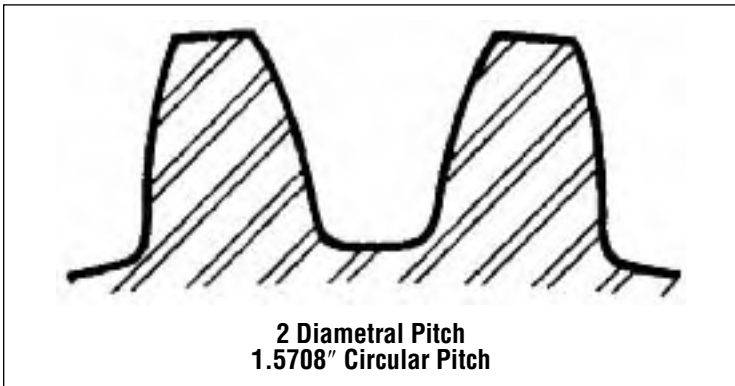
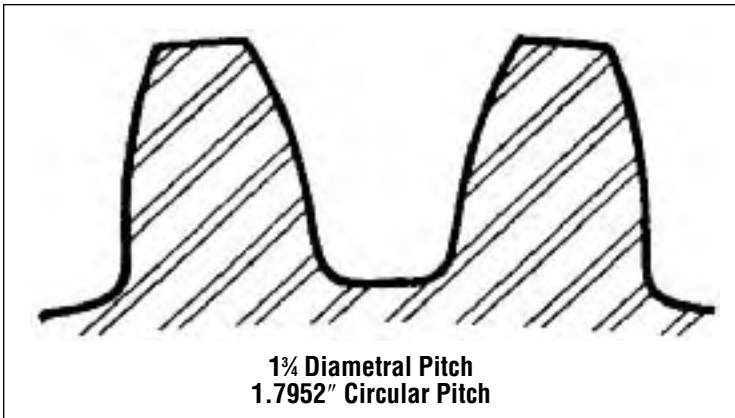

GEARS

Comparative Sizes of Involute Gear Teeth

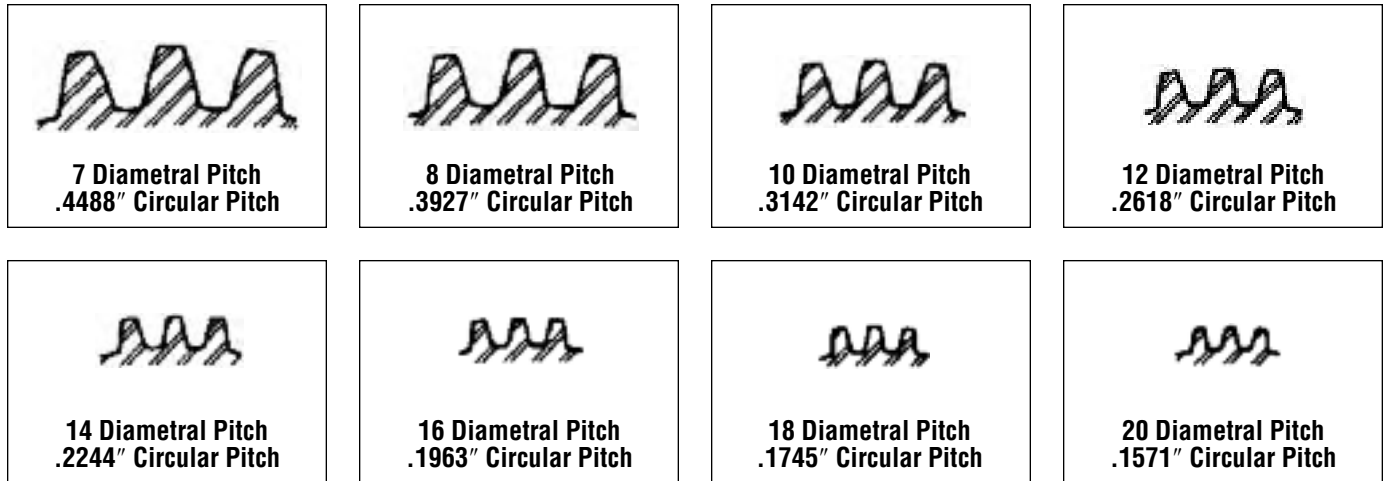

Gear Rack Comparison — 14½ and 20°

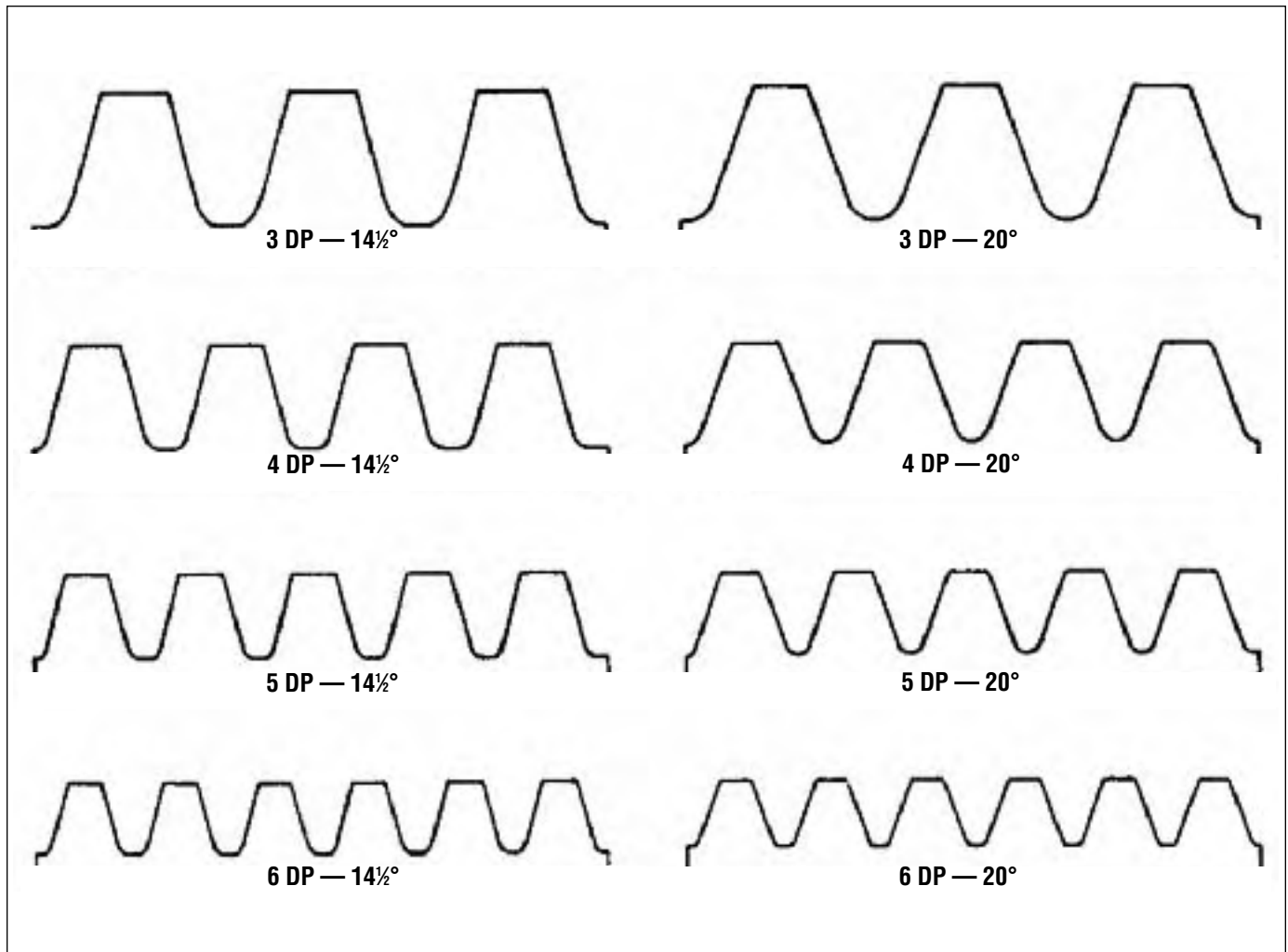

Stock Steel Gears

Martin steel gears are manufactured from high quality carbon steel material. This material is used for strength and good hardening characteristics. These gears may be hardened by any method acceptable to good practice such as flame or induction hardening. Flame hardening is preferred so that only the teeth are hardened. Distortion is virtually eliminated and the bore is left soft for subsequent work.

Cast Gears

Martin cast iron gears are manufactured from high quality close grained controlled specification irons.

Reboring of Stock Gears

Most of *Martin*'s Stock Gears may be rebored. The maximum recommended bore size is given for each gear. In reboring gears, care must be taken to hold the bore concentric with the pitch diameter. In most cases this would require a great amount of time. To cut costly set-up time when reboring, *Martin* holds the outside diameter of its gears concentric with the bore which in turn is concentric with the pitch diameter. The outside diameter is held to a closer total indicator reading than the pitch diameter. In the finer pitches, care should be taken not to distort the outside diameter when chucking.

Martin's steel gears are machined all over.

Rebore or rework may be accomplished by chucking on the hub. Concentricity must be controlled in order for gears to run at maximum efficiency.



PRODUCT	PAGE
GENERAL:	
Warning and Safety Reminder	H-2
Stock Material Handling Products	H-3
SCREW CONVEYORS:	H-4 – H-123
Engineering Section I	H-4
Design and Layout Section II.....	H-36
Component Section III.....	H-51
Special Features Section IV	H-108
Installation and Maintenance Section V	H-121
BUCKET ELEVATORS SECTION VI:	H-124 – H-143
DRAG CONVEYOR SECTION VII:	H-144 – H-154
VERTICAL SCREW ELEVATOR SECTION VIII:	H-155 – H-164
MODULAR PLASTIC SCREW CONVEYORS SECTION IX:	H-165 - H-168
SHAFTLESS SCREW CONVEYOR SECTION X:	H-169 - H-172
DATA SHEETS:	H-173



WARNING AND SAFETY REMINDERS FOR SCREW, DRAG, AND BUCKET ELEVATOR CONVEYORS

APPROVED FOR DISTRIBUTION BY THE SCREW CONVEYOR SECTION OF THE CONVEYOR EQUIPMENT MANUFACTURERS ASSOCIATION (CEMA)

It is the responsibility of the contractor, installer, owner and user to install, maintain and operate the conveyor, components and, conveyor assemblies in such a manner as to comply with the Williams-Steiger Occupational Safety and Health Act and with all state and local laws and ordinances and the American National Standards Institute (ANSI) B20.1 Safety Code.

In order to avoid an unsafe or hazardous condition, the assemblies or parts must be installed and operated in accordance with the following minimum provisions.

- Conveyors shall not be operated unless all covers and/or guards for the conveyor and drive unit are in place. If the conveyor is to be opened for inspection cleaning, maintenance or observation, the electric power to the motor driving the conveyor must be LOCKED OUT in such a manner that the conveyor cannot be restarted by anyone; however remote from the area, until conveyor or cover or guards and drive guards have been properly replaced.
- If the conveyor must have an open housing as a condition of its use and application, the entire conveyor is then to be guarded by a railing or fence in accordance with ANSI standard B20.1. (Request current edition and addenda)
- Feed openings for shovel, front loaders or other manual or mechanical equipment shall be constructed in such a way that the conveyor opening is covered by a grating. If the nature of the material is such that a grating cannot be used, then the exposed section of the conveyor is to be guarded by a railing or fence and there shall be a warning sign posted.
- Do not attempt any maintenance or repairs of the conveyor until power has been LOCKED OUT.
- Always operate conveyor in accordance with these instructions and those contained on the caution labels affixed to the equipment.
- Do not place hands, feet, or any part of your body, in the conveyor.
- Never walk on conveyor covers, grating or guards.
- Do not use conveyor for any purpose other than that for which it was intended.
- Do not poke or prod material into the conveyor with a bar or stick inserted through the openings.
- Keep area around conveyor drive and control station free of debris and obstacles.
- Eliminate all sources of stored energy (materials or devices that could cause conveyor components to move without power applied) before opening the conveyor
- Do not attempt to clear a jammed conveyor until power has been LOCKED OUT.
- Do not attempt field modification of conveyor or components.
- Conveyors are not normally manufactured or designed to handle materials that are hazardous to personnel. These materials which are hazardous include those that are explosive, flammable, toxic or otherwise dangerous to personnel. Conveyors may be designed to handle these materials. Conveyors are not manufactured or designed to comply with local, state or federal codes for unfired pressure vessels. If hazardous materials are to be conveyed or if the conveyor is to be subjected to internal or external pressure, manufacturer should be consulted prior to any modifications. CEMA insists that disconnecting and locking out the power to the motor driving the unit provides the only real protection against injury. Secondary safety devices are available; however, the decision as to their need and the type required must be made by the owner-assembler as we have no information regarding plant wiring, plant environment, the interlocking of the screw conveyor with other equipment, extent of plant automation, etc. Other devices should not be used as a substitute for locking out the power prior to removing guards or covers. We caution that use of the secondary devices may cause employees to develop a false sense of security and fail to lock out power before removing covers or guards. This could result in a serious injury should the secondary device fail or malfunction. There are many kinds of electrical devices for interlocking of conveyors and conveyor systems such that if one conveyor in a system or process is stopped other equipment feeding it, or following it can also be automatically stopped. Electrical controls, machinery guards, railings, walkways, arrangement of installation, training of personnel, etc., are necessary ingredients for a safe working place. It is the responsibility of the contractor, installer, owner and user to supplement the materials and services furnished with these necessary items to make the conveyor installation comply with the law and accepted standards. Conveyor inlet and discharge openings are designed to connect to other equipment or machinery so that the flow of material into and out of the conveyor is completely enclosed. One or more warning labels should be visible on conveyor housings, conveyor covers and elevator housings. If the labels attached to the equipment become illegible, please order replacement warning labels from the OEM or CEMA. The Conveyor Equipment Manufacturers Association (CEMA) has produced an audio-visual presentation entitled "Safe Operation of Screw Conveyors, Drag Conveyors, and Bucket Elevators." CEMA encourages acquisition and use of this source of safety information to supplement your safety program.

CONVEYORS



PROMINENTLY DISPLAY THESE SAFETY LABELS ON INSTALLED EQUIPMENT

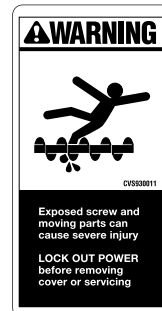
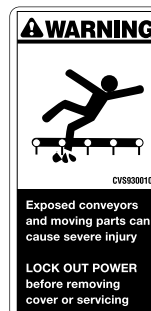

NOTICE: This document is provided by CEMA as a service to the industry in the interest of promoting safety. It is advisory only and it is not a substitute for a thorough safety program. Users should consult with qualified engineers and other safety professionals. CEMA makes no representations or warranties, either expressed or implied, and the users of this document assume full responsibility for the safe design and operation of equipment.



Stock & MTO Screw Conveyor Components

Screw Conveyor Components and Accessories



ANGLE FLANGED "U" TROUGH



FORM FLANGED "U" TROUGH



SECTIONAL SCREWS



SPECIALS



TUBULAR HOUSING



FLAT RACK AND PINION DISCHARGE GATE



TROUGH ENDS WITH AND WITHOUT FEET



SECTIONAL FLIGHTS



COUPLING SHAFTS



ELEVATOR BUCKETS



THRUST ASSEMBLY TYPE E WITH DRIVE SHAFT



INLETS AND DISCHARGE SPOUTS DISCHARGE



SPLIT GLAND



HANGER STYLE 220



HANGER STYLE 226



HANGER STYLE 216



HANGER STYLE 70



HANGER STYLE 19B



TROUGH END BEARINGS BALL AND ROLLER



PACKING GLAND SHAFT SEAL COMPRESSION TYPE



WASTE PACK SHAFT SEAL



PLATE SHAFT SEAL



DROP-OUT SHAFT SEAL FLANGED PRODUCT



HANGER BEARINGS STYLE 220/226

Martin HARD IRON
Martin BRONZE
NYLATRON
WHITE NYLON
WOOD
CERAMIC



SADDLES AND FEET



HELICOID SCREWS



HELICOID FLIGHTING RIGHT HAND AND LEFT HAND

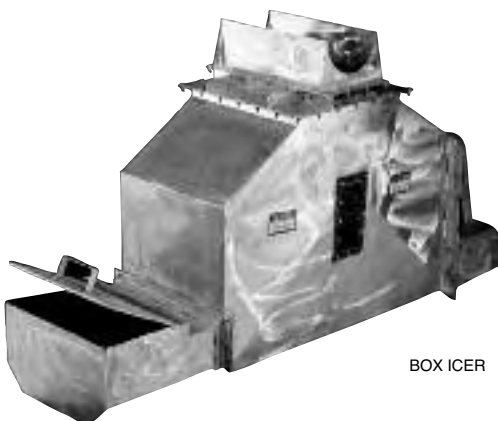

BOX ICER

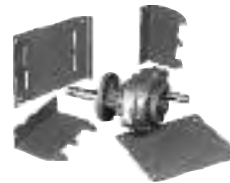

SCREW CONVEYOR DRIVE WITH ACCESSORIES

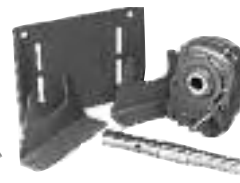

SPEED REDUCER SHAFT MOUNTED WITH ACCESSORIES.



FLANGED COVER WITH ACCESSORIES

Martin manufacturers the most complete line of stock components in the industry. We stock mild steel, stainless, galvanized, and many other items that are "special order" from the others in the industry.

SECTION I

ENGINEERING SECTION I

Introduction to Engineering Section	H-4
Screw Conveyor Design Procedure	H-5
Material Classification Code Chart.....	H-6
Material Characteristics Tables	H-7
Selection of Conveyor Size and Speed.....	H-17
Capacity Factor Tables	H-18
Capacity Table	H-19
Lump Size Limitations and Table	H-20
Component Group Selection.....	H-21
Hanger Bearing Selection	H-23
Horsepower Calculation.....	H-24
Torsional Ratings of Conveyor Components.....	H-27
Horsepower Ratings of Conveyor Components.....	H-28
Screw Conveyor End Thrust and Thermal Expansion	H-29
Screw Conveyor Deflection.....	H-30
Inclined and Vertical Screw Conveyors.....	H-32
Screw Feeders.....	H-33

Introduction

The following section is designed to present the necessary engineering information to properly design and layout most conveyor applications. The information has been compiled from many years of experience in successful design and application and from industry standards.

We hope that the information presented will be helpful to you in determining the type and size of screw conveyor that will best suit your needs.

The “Screw Conveyor Design Procedure” on the following page gives ten step-by-step instructions for properly designing a screw conveyor. These steps, plus the many following tables and formulas throughout the engineering section will enable you to design and detail screw conveyor for most applications.

If your requirements present any complications not covered in this section, we invite you to contact our Engineering Department for recommendations and suggestions.

SCREW CONVEYOR DESIGN PROCEDURE

SCREW CONVEYOR DESIGN PROCEDURE		
STEP 1	Establish Known Factors	<ol style="list-style-type: none"> 1. Type of material to be conveyed. 2. Maximum size of hard lumps. 3. Percentage of hard lumps by volume. 4. Capacity required, in cu.ft./hr. 5. Capacity required, in lbs./hr. 6. Distance material to be conveyed. 7. Any additional factors that may affect conveyor or operations.
STEP 2	Classify Material	Classify the material according to the system shown in Table 1-1. Or, if the material is included in Table 1-2, use the classification shown in Table 1-2.
STEP 3	Determine Design Capacity	Determine design capacity as described on pages H-17–H-19.
STEP 4	Determine Diameter and Speed	Using known capacity required in cu.ft./hr., material classification, and % trough loading (Table 1-2) determine diameter and speed from Table 1-6.
STEP 5	Check Minimum Screw Diameter for Lump Size Limitations	Using known screw diameter and percentage of hard lumps, check minimum screw diameter from Table 1-7.
STEP 6	Determine Type of Bearings	From Table 1-2, determine hanger bearing group for the material to be conveyed. Locate this bearing group in Table 1-11 for the type of bearing recommended.
STEP 7	Determine Horsepower	From Table 1-2, determine Horsepower Factor “F _m ” for the material to be conveyed. Refer to page H-24 and calculate horsepower by the formula method.
STEP 8	Check Torsional and/or Horsepower ratings of Standard Conveyor Components	Using required horsepower from step 7 refer to pages H-27 and H-28 to check capacities of standard conveyor pipe, shafts and coupling bolts.
STEP 9	Select Components	Select basic components from Tables 1-8, 1-9, and 1-10 in accordance with Component Group listed in Table 1-2 for the material to be conveyed. Select balance of components from the Components Section of catalogue.
STEP 10	Conveyor Layouts	Refer to pages H-40 and H-41 for typical layout details.

Table 1-1 Material Classification Code Chart



Major Class	Material Characteristics Included	Code Designation
Density	Bulk Density, Loose	Actual Lbs/PC
Size	Very Fine No. 200 Sieve (.0029") And Under No. 100 Sieve (.0059") And Under No. 40 Sieve (.016") And Under	A ₂₀₀ A ₁₀₀ A ₄₀
	Fine No. 6 Sieve (.132") And Under	B ₆
	Granular ½" And Under (6 Sieve to ½") 3" And Under (½ to 3") 7" And Under (3" to 7")	C _½ D ₃ D ₇
	Lumpy 16" And Under (0" to 16") Over 16" To Be Specified X=Actual Maximum Size	D ₁₆ D _X
	Irregular Stringy, Fibrous, Cylindrical, Slabs, Etc.	E
Flowability	Very Free Flowing	1
	Free Flowing	2
	Average Flowability	3
	Sluggish	4
Abrasiveness	Mildly Abrasive	5
	Moderately Abrasive	6
	Extremely Abrasive	7
Miscellaneous Properties Or Hazards	Builds Up and Hardens	F
	Generates Static Electricity	G
	Decomposes — Deteriorates in Storage	H
	Flammability	J
	Becomes Plastic or Tends to Soften	K
	Very Dusty	L
	Aerates and Becomes a Fluid	M
	Explosiveness	N
	Stickiness — Adhesion	O
	Contaminable, Affecting Use	P
	Degradable, Affecting Use	Q
	Gives Off Harmful or Toxic Gas or Fumes	R
	Highly Corrosive	S
	Mildly Corrosive	T
	Hygroscopic	U
	Interlocks, Mats or Agglomerates	V
	Oils Present	W
Packs Under Pressure	X	
Very Light and Fluffy — May Be Windswept	Y	
Elevated Temperature	Z	



Table 1-2 Material Characteristics

Material Characteristics

The material characteristics table (page H-8 or H-16) lists the following Design Data for many materials.

- A. The weight per cubic foot data may be used to calculate the required capacity of the conveyor in cubic feet per hour.
- B. The material code for each material is as described in Table 1-1, and as interpreted below.
- C. The Intermediate Bearing Selection Code is used to properly select the intermediate hanger bearing from Table 1-11 (Page H-23).
- D. The Component Series Code is used to determine the correct components to be used as shown on page H-22.
- E. The Material Factor F_m is used in determining horsepower as described on pages H-24 thru H-26.
- F. The Trough Loading column indicates the proper percent of cross section loading to use in determining diameter and speed of the conveyor.

For screw conveyor design purposes, conveyed materials are classified in accordance with the code system in Table 1-1, and listed in Table 1-2.

Table 1-2 lists many materials that can be effectively conveyed by a screw conveyor. If a material is not listed in Table 1-2, it must be classified according to Table 1-1 or by referring to a listed material similar in weight, particle size and other characteristics.

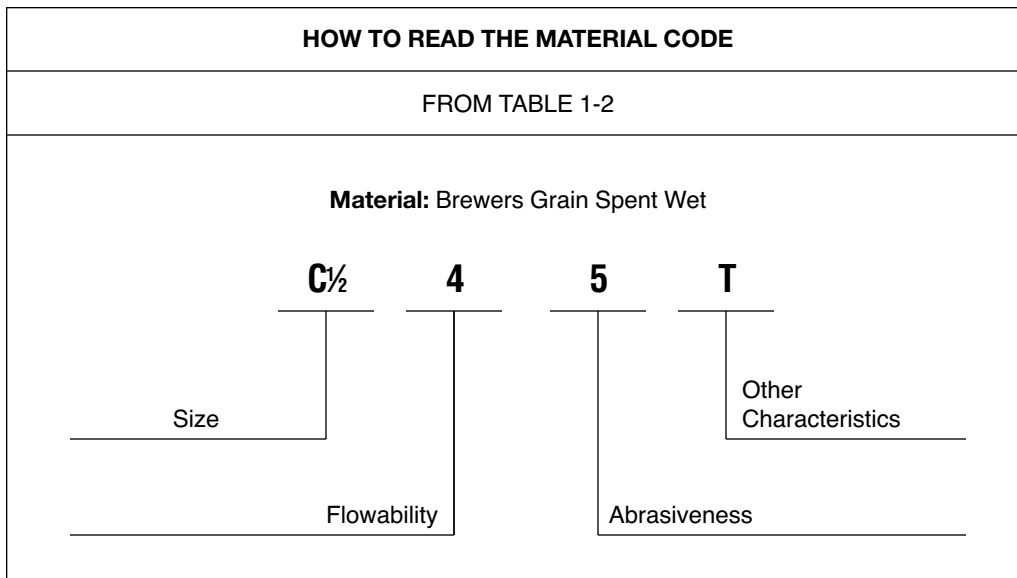

Table 1-2 Material Characteristics



Material	Weight lbs. per cu. ft.	Intermediate Material Code	Bearing Selection	Component Series	Mat'l Factor Fm	Trough Loading
Adipic Acid	45	A 100-35	S	2	.5	30A
Alfalfa Meal	14-22	B6-45WY	H	2	.6	30A
Alfalfa Pellets	41-43	C½-25	H	2	.5	45
Alfalfa Seed	6 10-15	B6-15N	L-S-B	1	.4	45
Almonds, Broken	27-30	C½-35Q	H	2	.9	30A
Almonds, Whole Shelled	28-30	C½-35Q	H	2	.9	30A
Alum, Fine	45-50	B6-35U	L-S-B	1	.6	30A
Alum, Lumpy	50-60	B6-25	L-S	2	1.4	45
Alumina	55-65	B6-27MY	H	3	1.8	15
Alumina, Fine	35	A100-27MY	H	3	1.6	15
Alumina Sized Or Briquette	65	D3-37	H	3	2.0	15
Aluminate Gel (Aluminate Hydroxide)	45	B6-35	H	2	1.7	30A
Aluminum Chips, Dry	7-15	E-45V	H	2	1.2	30A
Aluminum Chips, Oily	7-15	E-45V	H	2	.8	30A
Aluminum Hydrate	13-20	C½-35	L-S-B	1	1.4	30A
Aluminum Ore (See Bauxite)	—	—	—	—	—	—
Aluminum Oxide	60-120	A100-17M	H	3	1.8	15
Aluminum Silicate (Andalusite)	49	C½-35S	L-S	3	.8	30A
Aluminum Sulfate	45-58	C½-25	L-S-B	1	1.0	45
Ammonium Chloride, Crystalline	45-52	A100-45FRS	L-S	3	.7	30A
Ammonium Nitrate	45-62	A40-35NTU	H	3	1.3	30A
Ammonium Sulfate	45-58	C½-35FOTU	L-S	1	1.0	30A
Antimony Powder	—	A100-35	H	2	1.6	30A
Apple Pomace, Dry	15	C½-45Y	H	2	1.0	30A
Arsenate Of Lead (See Lead Arsenate)	—	—	—	—	—	—
Arsenic Oxide (Arsenolite)	100-120	A100-35R	L-S-B	—	—	30A
Arsenic Pulverized	30	A100-25R	H	2	.8	45
Asbestos — Rock (Ore)	81	D3-37R	H	3	1.2	15
Asbestos — Shredded	20-40	E-46XY	H	2	1.0	30B
Ash, Black Ground	105	B6-35	L-S-B	1	2.0	30A
Ashes, Coal, Dry — ½"	35-45	C½-46TY	H	3	3.0	30B
Ashes, Coal, Dry — 3"	35-40	D3-46T	H	3	2.5	30B
Ashes, Coal, Wet — ½"	45-50	C½-46T	H	3	3.0	30B
Ashes, Coal, Wet — 3"	45-50	D3-46T	H	3	4.0	30B
Ashes, Fly (See Fly Ash)	—	—	—	—	—	—
Asphalt, Crushed — ½"	45	C½-45	H	2	2.0	30A
Bagasse	7-10	E-45RVXY	L-S-B	2	1.5	30A
Bakelite, Fine	30-45	B6-25	L-S-B	1	1.4	45
Baking Powder	40-55	A100-35	S	1	.6	30A
Baking Soda (Sodium Bicarbonate)	40-55	A100-25	S	1	.6	45
Barite (Barium Sulfate) + ½" — 3"	120-180	D3-36	H	3	2.6	30B
Barite, Powder	120-180	A100-35X	H	2	2.0	30A
Barium Carbonate	72	A100-45R	H	2	1.6	30A
Bark, Wood, Refuse	10-20	E-45TVY	H	3	2.0	30A
Barley, Fine, Ground	24-38	B6-35	L-S-B	1	.4	30A
Barley, Malted	31	C½-35	L-S-B	1	.4	30A
Barley, Meal	28	C½-35	L-S-B	1	.4	30A
Barley, Whole	36-48	B6-25N	L-S-B	1	.5	45
Basalt	80-105	B6-27	H	3	1.8	15
Bauxite, Dry, Ground	68	B6-25	H	2	1.8	45
Bauxite, Crushed — 3"	75-85	D3-36	H	3	2.5	30B
Beans, Castor, Meal	35-40	B6-35W	L-S-B	1	.8	30A
Beans, Castor, Whole Shelled	36	C½-15W	L-S-B	1	.5	45
Beans, Navy, Dry	48	C½-15	L-S-B	1	.5	45
Beans, Navy, Steeped	60	C½-25	L-S-B	1	.8	45

Material	Weight lbs. per cu. ft.	Intermediate Material Code	Bearing Selection	Component Series	Mat'l Factor Fm	Trough Loading
Bentonite, Crude	34-40	D3-45X	H	2	1.2	30A
Bentonite, -100 Mesh	50-60	A100-25MXY	H	2	.7	45
Benzene Hexachloride	56	A100-45R	L-S-B	1	.6	30A
Bicarbonate of Soda (Baking Soda)	—	—	S	1	.6	—
Blood, Dried	35-45	D3-45U	H	2	2.0	30A
Blood, Ground, Dried	30	A100-35U	L-S	1	1.0	30A
Bone Ash (Tricalcium Phosphate)	40-50	A100-45	L-S	1	1.6	30A
Boneblack	20-25	A100-25Y	L-S	1	1.5	45
Bonechar	27-40	B6-35	L-S	1	1.6	30A
Bonemeal	50-60	B6-35	H	2	1.7	30A
Bones, Whole*	35-50	E-45V	H	2	3.0	30A
Bones, Crushed	35-50	D3-45	H	2	2.0	30A
Bones, Ground	50	B6-35	H	2	1.7	30A
Borate of Lime	60	A100-35	L-S-B	1	.6	30A
Borax, Fine	45-55	B6-25T	H	3	.7	30B
Borax Screening — ½"	55-60	C½-35	H	2	1.5	30A
Borax, 1½-2" Lump	55-60	D3-35	H	2	1.8	30A
Borax, 2"-3" Lump	60-70	D3-35	H	2	2.0	30A
Boric Acid, Fine	55	B6-25T	H	3	.8	30A
Boron	75	A100-37	H	2	1.0	30B
Bran, Rice — Rye — Wheat	16-20	B6-35NY	L-S-B	1	.5	30A
Braunite (Manganese Oxide)	120	A100-36	H	2	2.0	30B
Bread Crumbs	20-25	B6-35PQ	L-S-B	1	.6	30A
Brewer's Grain, Spent, Dry	14-30	C½-45	L-S-B	1	.5	30A
Brewer's Grain, Spent, Wet	55-60	C½-45T	L-S	2	.8	30A
Brick, Ground — ½"	100-120	B6-37	H	3	2.2	15
Bronze Chips	30-50	B6-45	H	2	2.0	30A
Buckwheat	37-42	B6-25N	L-S-B	1	.4	45
Calcine, Flour	75-85	A100-35	L-S-B	1	.7	30A
Calcium Carbide	70-90	D3-25N	H	2	2.0	30A
Calcium Carbonate (See Limestone)	—	—	—	—	—	—
Calcium Fluoride (See Fluorspar)	—	—	—	—	—	—
Calcium Hydrate (See Lime, Hydrated)	—	—	—	—	—	—
Calcium Hydroxide (See Lime, Hydrated)	—	—	—	—	—	—
Calcium Lactate	26-29	D3-45QTR	L-S	2	.6	30A
Calcium Oxide (See Lime, Unslaked)	—	—	—	—	—	—
Calcium Phosphate	40-50	A100-45	L-S-B	1	1.6	30A
Calcium Sulfate (See Gypsum)	—	—	—	—	—	—
Carbon, Activated, Dry Fine*	—	—	—	—	—	—
Carbon Black, Pelleted*	—	—	—	—	—	—
Carbon Black, Powder*	—	—	—	—	—	—
Carborundum	100	D3-27	H	3	3.0	15
Casein	36	B6-35	H	2	1.6	30A
Cashew Nuts	32-37	C½-45	H	2	.7	30A
Cast Iron, Chips	130-200	C½-45	H	2	4.0	30A
Caustic Soda	88	B6-35RSU	H	3	1.8	30A
Caustic Soda, Flakes	47	C½-45RSUX	L-S	3	1.5	30A
Celite (See Diatomaceous Earth)	—	—	—	—	—	—
Cement, Clinker	75-95	D3-36	H	3	1.8	30B
Cement, Mortar	133	B6-35Q	H	3	3.0	30A
Cement, Portland	94	A100-26M	H	2	1.4	30B
Cement, Aerated (Portland)	60-75	A100-16M	H	2	1.4	30B
Cerrusite (See Lead Carbonate)	—	—	—	—	—	—
Chalk, Crushed	75-95	D3-25	H	2	1.9	30A
Chalk, Pulverized	67-75	A100-25MXY	H	2	1.4	45
Charcoal, Ground	18-28	A100-45	H	2	1.2	30A

Table 1-2 Material Characteristics (Cont'd)



Material	Weight lbs. per cu. ft.	Intermediate Material Code	Bearing Selection	Component Series	Mat'l Factor Fm	Trough Loading
Charcoal, Lumps	18-28	D3-45Q	H	2	1.4	30A
Chocolate, Cake Pressed	40-45	D3-25	S	2	1.5	30A
Chrome Ore	125-140	D3-36	H	3	2.5	30B
Cinders, Blast Furnace	57	D3-36T	H	3	1.9	30B
Cinders, Coal	40	D3-36T	H	3	1.8	30B
Clay (See Bentonite, Diatomaceous Earth, Fuller's Earth, Kaolin & Marl)	—	—	—	—	—	—
Clay, Ceramic, Dry, Fines	60-80	A100-35P	L-S-B	1	1.5	30A
Clay, Calcined	80-100	B6-36	H	3	2.4	30B
Clay, Brick, Dry, Fines	100-120	C½-36	H	3	2.0	30B
Clay, Dry, Lumpy	60-75	D3-35	H	2	1.8	30A
Clinker, Cement (See Cement Clinker)	—	—	—	—	—	—
Clover Seed	45-48	B6-25N	L-S-B	1	.4	45
Coal, Anthracite (River & Culm)	55-61	B6-35TY	L-S	2	1.0	30A
Coal, Anthracite, Sized-½"	49-61	C½-25	L-S	2	1.0	45
Coal, Bituminous, Mined	40-60	D3-35LNXY	L-S	1	.9	30A
Coal, Bituminous, Mined, Sized	45-50	D3-35QV	L-S	1	1.0	30A
Coal, Bituminous, Mined, Slack	43-50	C½-45T	L-S	2	.9	30A
Coal, Lignite	37-45	D3-35T	H	2	1.0	30A
Cocoa Beans	30-45	C½-25Q	L-S	1	.5	45
Cocoa, Nibs	35	C½-25	H	2	.5	45
Cocoa, Powdered	30-35	A100-45XY	S	1	.9	30A
Cocoonut, Shredded	20-22	E-45	S	2	1.5	30A
Coffee, Chaff	20	B6-25MY	L-S	1	1.0	45
Coffee, Green Bean	25-32	C½-25PQ	L-S	1	.5	45
Coffee, Ground, Dry	25	A40-35P	L-S	1	.6	30A
Coffee, Ground, Wet	35-45	A40-45X	L-S	1	.6	30A
Coffee, Roasted Bean	20-30	C½-25PQ	S	1	.4	45
Coffee, Soluble	19	A40-35PUY	S	1	.4	45
Coke, Breeze	25-35	C½-37	H	3	1.2	15
Coke, Loose	23-35	D7-37	H	3	1.2	15
Coke, Petrol, Calcined	35-45	D7-37	H	3	1.3	15
Compost	30-50	D7-45TV	L-S	3	1.0	30A
Concrete, Pre-Mix Dry	85-120	C½-36U	H	3	3.0	30B
Copper Ore	120-150	DX-36	H	3	4.0	30B
Copper Ore, Crushed	100-150	D3-36	H	3	4.0	30B
Copper Sulphate, (Bluestone)	75-95	C½-35S	L-S	2	1.0	30A
Copperas (See Ferrous Sulphate)	—	—	—	—	—	—
Copra, Cake Ground	40-45	B6-45HW	L-S-B	1	.7	30A
Copra, Cake, Lumpy	25-30	D3-35HW	L-S-B	2	.8	30A
Copra, Lumpy	22	E-35HW	L-S-B	2	1.0	30A
Copra, Meal	40-45	B6-35HW	H	2	.7	30A
Cork, Fine Ground	5-15	B6-35JNY	L-S-B	1	.5	30A
Cork, Granulated	12-15	C½-35JY	L-S-B	1	.5	30A
Corn, Cracked	40-50	B6-25P	L-S-B	1	.7	45
Corn Cobs, Ground	17	C½-25Y	L-S-B	1	.6	45
Corn Cobs, Whole*	12-15	E-35	L-S	2		30A
Corn Ear*	56	E-35	L-S	2		30A
Corn Germ	21	B6-35PY	L-S-B	1	.4	30A
Corn Grits	40-45	B6-35P	L-S-B	1	.5	30A
Cornmeal	32-40	B6-35P	L-S	1	.5	30A
Corn Oil, Cake	25	D7-45HW	L-S	1	.6	30A
Corn Seed	45	C½-25PQ	L-S-B	1	.4	45
Corn Shelled	45	C½-25	L-S-B	1	.4	45
Corn Sugar	30-35	B6-35PU	S	1	1.0	30A
Cottonseed, Cake, Crushed	40-45	C½-45HW	L-S	1	1.0	30A

Material	Weight lbs. per cu. ft.	Intermediate Material Code	Bearing Selection	Component Series	Mat'l Factor Fm	Trough Loading
Cottonseed, Cake, Lumpy	40-45	D7-45HW	L-S	2	1.0	30A
Cottonseed, Dry, Delinted	22-40	C½-25X	L-S	1	.6	45
Cottonseed, Dry, Not Delinted	18-25	C½-45XY	L-S	1	.9	30A
Cottonseed, Flakes	20-25	C½-35HWY	L-S	1	.8	30A
Cottonseed, Hulls	12	B6-35Y	L-S	1	.9	30A
Cottonseed, Meal, Expeller	25-30	B6-45HW	L-S	3	.5	30A
Cottonseed, Meal, Extracted	35-40	B6-45HW	L-S	1	.5	30A
Cottonseed, Meats, Dry	40	B6-35HW	L-S	1	.6	30A
Cottonseed, Meats, Rolled	35-40	C½-45HW	L-S	1	.6	30A
Cracklings, Crushed	40-50	D3-45HW	L-S-B	2	1.3	30A
Cryolite, Dust	75-90	A100-36L	H	2	2.0	30B
Cryolite, Lumpy	90-110	D16-36	H	2	2.1	30B
Cullet, Fine	80-120	C½-37	H	3	2.0	15
Cullet, Lump	80-120	D16-37	H	3	2.5	15
Culm, (See Coal, Anthracite)	—	—	—	—	—	—
Cupric Sulphate (Copper Sulfate)	—	—	—	—	—	—
Detergent (See Soap Detergent)	—	—	—	—	—	—
Diatomaceous Earth	11-17	A40-36Y	H	3	1.6	30B
Dicalcium Phosphate	40-50	A40-35	L-S-B	1	1.6	30A
Disodium Phosphate	25-31	A40-35	H	3	.5	30A
Distiller's Grain, Spent Dry	30	B6-35	H	2	.5	30A
Distiller's Grain, Spent Wet	40-60	C½-45V	L-S	3	.8	30A
Dolomite, Crushed	80-100	C½-36	H	2	2.0	30B
Dolomite, Lumpy	90-100	DX-36	H	2	2.0	30B
Earth, Loam, Dry, Loose	76	C½-36	H	2	1.2	30B
Ebonite, Crushed	63-70	C½-35	L-S-B	1	.8	30A
Egg Powder	16	A40-35MPY	S	1	1.0	30A
Epsom Salts (Magnesium Sulfate)	40-50	A40-35U	L-S-B	1	.8	30A
Feldspar, Ground	65-80	A100-37	H	2	2.0	15
Feldspar, Lumps	90-100	D7-37	H	2	2.0	15
Feldspar, Powder	100	A200-36	H	2	2.0	30B
Feldspar, Screenings	75-80	C½-37	H	2	2.0	15
Ferrous Sulfide — ½"	120-135	C½-26	H	2	2.0	30B
Ferrous Sulfide — 100M	105-120	A100-36	H	2	2.0	30B
Ferrous Sulphate	50-75	C½-35U	H	2	1.0	30A
Fish Meal	35-40	C½-45HP	L-S-B	1	1.0	30A
Fish Scrap	40-50	D7-45H	L-S-B	2	1.5	30A
Flaxseed	43-45	B6-35X	L-S-B	1	.4	30A
Flaxseed Cake (Linseed Cake)	48-50	D7-45W	L-S	2	.7	30A
Flaxseed Meal (Linseed Meal)	25-45	B6-45W	L-S	1	.4	30A
Flour Wheat	33-40	A40-45LP	S	1	.6	30A
Flue Dust, Basic Oxygen Furnace	45-60	A40-36LM	H	3	3.5	30B
Flue Dust, Blast Furnace	110-125	A40-36	H	3	3.5	30B
Flue Dust, Boiler H. Dry	30-45	A40-36LM	H	3	2.0	30B
Fluorspar, Fine (Calcium Fluoride)	80-100	B6-36	H	2	2.0	30B
Fluorspar, Lumps	90-110	D7-36	H	2	2.0	30B
Fly Ash	30-45	A40-36M	H	3	2.0	30B
Foundry Sand, Dry (See Sand)	—	—	—	—	—	—
Fuller's Earth, Dry, Raw	30-40	A40-25	H	2	2.0	15
Fuller's Earth, Oily, Spent	60-65	C½-450W	H	3	2.0	30A
Fuller's Earth, Calcined	40	A100-25	H	3	2.0	15
Galena (See Lead Sulfide)	—	—	—	—	—	—
Gelatine, Granulated	32	B6-35PU	S	1	.8	30A
Gilsonite	37	C½-35	H	3	1.5	30A
Glass, Batch	80-100	C½-37	H	3	2.5	15
Glue, Ground	40	B6-45U	H	2	1.7	30A

Table 1-2 Material Characteristics (Cont'd)

Material	Weight lbs. per cu. ft.	Intermediate Material Code	Bearing Selection	Component Series	Mat'l Factor Fm	Trough Loading
Glue, Pearl	40	C½-35U	L-S-B	1	.5	30A
Glue, Veg. Powdered	40	A40-45U	L-S-B	1	.6	30A
Gluten, Meal	40	B6-35P	L-S	1	.6	30A
Granite, Fine	80-90	C½-27	H	3	2.5	15
Grape Pomace	15-20	D3-45U	H	2	1.4	30A
Graphite Flake	40	B6-25LP	L-S-B	1	.5	45
Graphite Flour	28	A100-35LMP	L-S-B	1	.5	30A
Graphite Ore	65-75	DX-35L	H	2	1.0	30A
Guano Dry*	70	C½-35	L-S	3	2.0	30A
Gypsum, Calcined	55-60	B6-35U	H	2	1.6	30A
Gypsum, Calcined, Powdered	60-80	A100-35U	H	2	2.0	30A
Gypsum, Raw — 1"	70-80	D3-25	H	2	2.0	30A
Hay, Chopped*	8-12	C½-35JY	L-S	2	1.6	30A
Hexanedioic Acid (See Adipic Acid)	—	—	—	—	—	—
Hominy, Dry	35-50	C½-25	L-S-B	1	.4	45
Hops, Spent, Dry	35	D3-35	L-S-B	2	1.0	30A
Hops, Spent, Wet	50-55	D3-45V	L-S	2	1.5	30A
Ice, Crushed	35-45	D3-35Q	L-S	2	.4	30A
Ice, Flaked*	40-45	C½-35Q	S	1	.6	30A
Ice, Cubes	33-35	D3-35Q	S	1	.4	30A
Ice, Shell	33-35	D3-45Q	S	1	.4	30A
Ilmenite Ore	140-160	D3-37	H	3	2.0	15
Iron Ore Concentrate	120-180	A40-37	H	3	2.2	15
Iron Oxide Pigment	25	A100-36LMP	H	2	1.0	30B
Iron Oxide, Millscale	75	C½-36	H	2	1.6	30B
Iron Pyrites (See Ferrous Sulfide)	—	—	—	—	—	—
Iron Sulphate (See Ferrous Sulfate)	—	—	—	—	—	—
Iron Sulfide (See Ferrous Sulfide)	—	—	—	—	—	—
Iron Vitriol (See Ferrous Sulfate)	—	—	—	—	—	—
Kafir (Corn)	40-45	C½-25	H	3	.5	45
Kaolin Clay	63	D3-25	H	2	2.0	30A
Kaolin Clay-Talc	32-56	A40-35LMP	H	2	2.0	30A
Kryolith (See Cryolite)	—	—	—	—	—	—
Lactose	32	A40-35PU	S	1	.6	30A
Lamp Black (See Carbon Black)	—	—	—	—	—	—
Lead Arsenate	72	A40-35R	L-S-B	1	1.4	30A
Lead Arsenite	72	A40-35R	L-S-B	1	1.4	30A
Lead Carbonate	240-260	A40-35R	H	2	1.0	30A
Lead Ore — ¼"	200-270	B6-35	H	3	1.4	30A
Lead Ore — ½"	180-230	C½-36	H	3	1.4	30B
Lead Oxide (Red Lead) — 100 Mesh	30-150	A100-35P	H	2	1.2	30A
Lead Oxide (Red Lead) — 200 Mesh	30-180	A200-35LP	H	2	1.2	30A
Lead Sulphide — 100 Mesh	240-260	A100-35R	H	2	1.0	30A
Lignite (See Coal Lignite)	—	—	—	—	—	—
Limnane, Ore, Brown	120	C½-47	H	3	1.7	15
Lime, Ground, Unslaked	60-65	B6-35U	L-S-B	1	.6	30A
Lime Hydrated	40	B6-35LM	H	2	.8	30A
Lime, Hydrated, Pulverized	32-40	A40-35LM	L-S	1	.6	30A
Lime, Pebble	53-56	C½-25HU	L-S	2	2.0	45
Limestone, Agricultural	68	B6-35	H	2	2.0	30A
Limestone, Crushed	85-90	DX-36	H	2	2.0	30B
Limestone, Dust	55-95	A40-46MY	H	2	1.6-2.0	30B
Lindane (Benzene Hexachloride)	—	—	—	—	—	—
Linseed (See Flaxseed)	—	—	—	—	—	—
Litharge (Lead Oxide)	—	—	—	—	—	—
Lithopone	45-50	A325-35MR	L-S	1	1.0	30A

Material	Weight lbs. per cu. ft.	Intermediate Material Code	Bearing Selection	Component Series	Mat'l Factor Fm	Trough Loading
Maize (See Milo)	—	—	—	—	—	—
Malt, Dry, Ground	20-30	B6-35NP	L-S-B	1	.5	30A
Malt, Meal	36-40	B6-25P	L-S-B	1	.4	45
Malt, Dry Whole	20-30	C½-35N	L-S-B	1	.5	30A
Malt, Sprouts	13-15	C½-35P	L-S-B	1	.4	30A
Magnesium Chloride (Magnesite)	33	C½-45	L-S	1	1.0	30A
Manganese Dioxide*	70-85	A100-35NRT	L-S	2	1.5	30A
Manganese Ore	125-140	DX-37	H	3	2.0	15
Manganese Oxide	120	A100-36	H	2	2.0	30B
Manganese Sulfate	70	C½-37	H	3	2.4	15
Marble, Crushed	80-95	B6-37	H	3	2.0	15
Marl, (Clay)	80	DX-36	H	2	1.6	30B
Meat, Ground	50-55	E-45HQTX	L-S	2	1.5	30A
Meat, Scrap (Wbone)	40	E-46H	H	2	1.5	30B
Mica, Flakes	17-22	B6-16MY	H	2	1.0	30B
Mica, Ground	13-15	B6-36	H	2	.9	30B
Mica, Pulverized	13-15	A100-36M	H	2	1.0	30B
Milk, Dried, Flake	5-6	B6-35PUY	S	1	.4	30A
Milk, Malted	27-30	A40-45PX	S	1	.9	30A
Milk, Powdered	20-45	B6-25PM	S	1	.5	45
Milk Sugar	32	A100-35PX	S	1	.6	30A
Milk, Whole, Powdered	20-36	B6-35PUX	S	1	.5	30A
Mill Scale (Steel)	120-125	E-46T	H	3	3.0	30B
Milo, Ground	32-36	B6-25	L-S-B	1	.5	45
Milo Maize (Kafir)	40-45	B6-15N	L-S-B	1	.4	45
Molybdenite Powder	107	B6-26	H	2	1.5	30B
Monosodium Phosphate	50	B6-36	H	2	.6	30B
Mortar, Wet*	150	E-46T	H	3	3.0	30B
Mustard Seed	45	B6-15N	L-S-B	1	.4	45
Naphthalene Flakes	45	B6-35	L-S-B	1	.7	30A
Niacin (Nicotinic Acid)	35	A40-35P	H	2	2.5	30A
Oats	26	C½-25MN	L-S-B	1	.4	45
Oats, Crimped	19-26	C½-35	L-S-B	1	.5	30A
Oats, Crushed	22	B6-45NY	L-S-B	1	.6	30A
Oats, Flour	35	A100-35	L-S-B	1	.5	30A
Oat Hulls	8-12	B6-35NY	L-S-B	1	.5	30A
Oats, Rolled	19-24	C½-35NY	L-S-B	1	.6	30A
Oleo Margarine (Margarine)	59	E-45HKPWX	L-S	2	.4	30A
Orange Peel, Dry	15	E-45	L-S	2	1.5	30A
Oxalic Acid Crystals — Ethane Diacid Crystals	60	B6-35QS	L-S	1	1.0	30A
Oyster Shells, Ground	50-60	C½-36T	H	3	1.6-2.0	30B
Oyster Shells, Whole	80	D3-36TV	H	3	2.1-2.5	30B
Paper Pulp (4% or less)	62	E-45	L-S	2	1.5	30A
Paper Pulp (6% to 15%)	60-62	E-45	L-S	2	1.5	30A
Paraffin Cake — ½"	45	C½-45K	L-S	1	.6	30A
Peanuts, Clean, in shell	15-20	D3-35Q	L-S	2	.6	30A
Peanut Meal	30	B6-35P	S	1	.6	30A
Peanuts, Raw, Uncleaned (unshelled)	15-20	D3-36Q	H	3	.7	30B
Peanuts, Shelled	35-45	C½-35Q	S	1	.4	30A
Peas, Dried	45-50	C½-15NQ	L-S-B	1	.5	45
Perlite — Expanded	8-12	C½-36	H	2	.6	30B
Phosphate Acid Fertilizer	60	B6-25T	L-S	2	1.4	45
Phosphate Disodium (See Sodium Phosphate)	—	—	—	—	—	—
Phosphate Rock, Broken	75-85	DX-36	H	2	2.1	30B
Phosphate Rock, Pulverized	60	B6-36	H	2	1.7	30B

Table 1-2 Material Characteristics (Cont'd)

Material	Weight lbs. per cu. ft.	Intermediate Material Code	Bearing Selection	Component Series	Mat'l Factor Fm	Trough Loading
Phosphate Sand	90-100	B6-37	H	3	2.0	15
Plaster of Paris (See Gypsum)	—	—	—	—	—	—
Plumbago (See Graphite)	—	—	—	—	—	—
Polystyrene Beads	40	B6-35PQ	S	1	.4	30A
Polyvinyl, Chloride Powder	20-30	A100-45KT	S	2	1.0	30A
Polyvinyl, Chloride Pellets	20-30	E-45KPQT	S	1	.6	30A
Polyethylene, Resin Pellets	30-35	C½-45Q	L-S	1	.4	30A
Potash (Muriate) Dry	70	B6-37	H	3	2.0	15
Potash (Muriate) Mine Run	75	DX-37	H	3	2.2	15
Potassium Carbonate	51	B6-36	H	2	1.0	30B
Potassium Chloride Pellets	120-130	C½-25TU	H	3	1.6	45
Potassium Nitrate — ½"	76	C½-16NT	H	3	1.2	30B
Potassium Nitrate — ⅜"	80	B6-26NT	H	3	1.2	30B
Potassium Sulfate	42-48	B6-46X	H	2	1.0	30B
Potato Flour	48	A200-35MNP	L-S	1	.5	30A
Pumice — ⅛"	42-48	B6-46	H	3	1.6	30B
Pyrite, Pellets	120-130	C½-26	H	3	2.0	30B
Quartz — 100 Mesh	70-80	A100-27	H	3	1.7	15
Quartz — ½"	80-90	C½-27	H	3	2.0	15
Rice, Bran	20	B6-35NY	L-S-B	1	.4	30A
Rice, Grits	42-45	B6-35P	L-S-B	1	.4	30A
Rice, Polished	30	C½-15P	L-S-B	1	.4	45
Rice, Hulled	45-49	C½-25P	L-S-B	1	.4	45
Rice, Hulls	20-21	B6-35NY	L-S-B	1	.4	30A
Rice, Rough	32-36	C½-35N	L-S-B	1	.6	30A
Rosin — ½"	65-68	C½-45Q	L-S-B	1	1.5	30A
Rubber, Reclaimed Ground	23-50	C½-45	L-S-B	1	.8	30A
Rubber, Pelleted	50-55	D3-45	L-S-B	2	1.5	30A
Rye	42-48	B6-15N	L-S-B	1	.4	45
Rye Bran	15-20	B6-35Y	L-S-B	1	.4	45
Rye Feed	33	B6-35N	L-S-B	1	.5	30A
Rye Meal	35-40	B6-35	L-S-B	1	.5	30A
Rye Middlings	42	B6-35	L-S	1	.5	30A
Rye, Shorts	32-33	C½-35	L-S	2	.5	30A
Safflower, Cake	50	D3-26	H	2	.6	30B
Safflower, Meal	50	B6-35	L-S-B	1	.6	30A
Safflower Seed	45	B6-15N	L-S-B	1	.4	45
Saffron (See Safflower)	—	—	—	—	—	—
Sal Ammoniac (Ammonium Chloride)	—	—	—	—	—	—
Salt Cake, Dry Coarse	85	B6-36TU	H	3	2.1	30B
Salt Cake, Dry Pulverized	65-85	B6-36TU	H	3	1.7	30B
Salicylic Acid	29	B6-37U	H	3	.6	15
Salt, Dry Coarse	45-60	C½-36TU	H	3	1.0	30B
Salt, Dry Fine	70-80	B6-36TU	H	3	1.7	30B
Saltpeter — (See Potassium Nitrate)	—	—	—	—	—	—
Sand Dry Bank (Damp)	110-130	B6-47	H	3	2.8	15
Sand Dry Bank (Dry)	90-110	B6-37	H	3	1.7	15
Sand Dry Silica	90-100	B6-27	H	3	2.0	15
Sand Foundry (Shake Out)	90-100	D3-37Z	H	3	2.6	15
Sand (Resin Coated) Silica	104	B6-27	H	3	2.0	15
Sand (Resin Coated) Zircon	115	A100-27	H	3	2.3	15
Sawdust, Dry	10-13	B6-45UX	L-S-B	1	1.4	15
Sea — Coal	65	B6-36	H	2	1.0	30B
Sesame Seed	27-41	B6-26	H	2	.6	30B
Shale, Crushed	85-90	C½-36	H	2	2.0	30B
Shellac, Powdered or Granulated	31	B6-35P	S	1	.6	30A

Material	Weight lbs. per cu. ft.	Material Code	Intermediate Bearing Selection	Component Series	Mat'l Factor F _m	Trough Loading
Silicon Dioxide (See Quartz)	—	—	—	—	—	—
Silica, Flour	80	A40-46	H	2	1.5	30B
Silica Gel + ½" - 3"	45	D3-37HKQU	H	3	2.0	15
Slag, Blast Furnace Crushed	130-180	D3-37Y	H	3	2.4	15
Slag, Furnace Granular, Dry	60-65	C½-37	H	3	2.2	15
Slate, Crushed, — ½"	80-90	B6-36	H	2	2.0	30B
Slate, Ground, — ½"	82-85	B6-36	H	2	1.6	30B
Sludge, Sewage, Dried	40-50	E-47TW	H	3	.8	15
Sludge, Sewage, Dry Ground	45-55	B-46S	H	2	.8	30B
Soap, Beads or Granules	15-35	B6-35Q	L-S-B	1	.6	30A
Soap, Chips	15-25	C½-35Q	L-S-B	1	.6	30A
Soap Detergent	15-50	B6-35FQ	L-S-B	1	.8	30A
Soap, Flakes	5-15	B6-35QXY	L-S-B	1	.6	30A
Soap, Powder	20-25	B6-25X	L-S-B	1	.9	45
Soapstone, Talc, Fine	40-50	A200-45XY	L-S-B	1	2.0	30A
Soda Ash, Heavy	55-65	B6-36	H	2	2.0	30B
Soda Ash, Light	20-35	A40-36Y	H	2	1.6	30B
Sodium Aluminate, Ground	72	B6-36	H	2	1.0	30B
Sodium Aluminum Fluoride (See Kryolite)	—	—	—	—	—	—
Sodium Aluminum Sulphate*	75	A100-36	H	2	1.0	30B
Sodium Bentonite (See Bentonite)	—	—	—	—	—	—
Sodium Bicarbonate (See Baking Soda)	—	—	—	—	—	—
Sodium Chloride (See Salt)	—	—	—	—	—	—
Sodium Carbonate (See Soda Ash)	—	—	—	—	—	—
Sodium Hydrate (See Caustic Soda)	—	—	—	—	—	—
Sodium Hydroxide (See Caustic Soda)	—	—	—	—	—	—
Sodium Borate (See Borax)	—	—	—	—	—	—
Sodium Nitrate	70-80	D3-25NS	L-S	2	1.2	30A
Sodium Phosphate	50-60	A-35	L-S	1	.9	30A
Sodium Sulfate (See Salt Cake)	—	—	—	—	—	—
Sodium Sulfite	96	B6-46X	H	2	1.5	30B
Sorghum, Seed (See Kafir or Milo)	—	—	—	—	—	—
Soybean, Cake	40-43	D3-35W	L-S-B	2	1.0	30A
Soybean, Cracked	30-40	C½-36NW	H	2	.5	30B
Soybean, Flake, Raw	18-25	C½-35Y	L-S-B	1	.8	30A
Soybean, Flour	27-30	A40-35MN	L-S-B	1	.8	30A
Soybean Meal, Cold	40	B6-35	L-S-B	1	.5	30A
Soybean Meal Hot	40	B6-35T	L-S	2	.5	30A
Soybeans, Whole	45-50	C½-26NW	H	2	1.0	30B
Starch	25-50	A40-15M	L-S-B	1	1.0	45
Steel Turnings, Crushed	100-150	D3-46WV	H	3	3.0	30B
Sugar Beet, Pulp, Dry	12-15	C½-26	H	2	.9	30B
Sugar Beet, Pulp, Wet	25-45	C½-35X	L-S-B	1	1.2	30A
Sugar, Refined, Granulated Dry	50-55	B6-35PU	S	1	1.0-1.2	30A
Sugar, Refined, Granulated Wet	55-65	C½-35X	S	1	1.4-2.0	30A
Sugar, Powdered	50-60	A100-35PX	S	1	.8	30A
Sugar, Raw	55-65	B6-35PX	S	1	1.5	30A
Sulphur, Crushed — ½"	50-60	C½-35N	L-S	1	.8	30A
Sulphur, Lumpy, — 3"	80-85	D3-35N	L-S	2	.8	30A
Sulphur, Powdered	50-60	A40-35MN	L-S	1	.6	30A
Sunflower Seed	19-38	C½-15	L-S-B	1	.5	45
Talcum, — ½"	80-90	C½-36	H	2	.9	30B
Talcum Powder	50-60	A200-36M	H	2	.8	30B
Tanbark, Ground*	55	B6-45	L-S-B	1	.7	30A
Timothy Seed	36	B6-35NY	L-S-B	1	.6	30A
Titanium Dioxide (See Ilmenite Ore)	—	—	—	—	—	—

Table 1-2 Material Characteristics (Cont'd)



Material	Weight lbs. per cu. ft.	Material Code	Intermediate Bearing Selection	Component Series	Mat'l Factor F _m	Trough Loading
Tobacco, Scraps	15-25	D3-45Y	L-S	2	.8	30A
Tobacco, Snuff	30	B6-45MQ	L-S-B	1	.9	30A
Tricalcium Phosphate	40-50	A40-45	L-S	1	1.6	30A
Triple Super Phosphate	50-55	B6-36RS	H	3	2.0	30B
Trisodium Phosphate	60	C½-36	H	2	1.7	30B
Trisodium Phosphate Granular	60	B6-36	H	2	1.7	30B
Trisodium Phosphate, Pulverized	50	A40-36	H	2	1.6	30B
Tung Nut Meats, Crushed	28	D3-25W	L-S	2	.8	30A
Tung Nuts	25-30	D3-15	L-S	2	.7	30A
Urea Prills, Coated	43-46	B6-25	L-S-B	1	1.2	45
Vermiculite, Expanded	16	C½-35Y	L-S	1	.5	30A
Vermiculite, Ore	80	D3-36	H	2	1.0	30B
Vetch	48	B6-16N	L-S-B	1	.4	30B
Walnut Shells, Crushed	35-45	B6-36	H	2	1.0	30B
Wheat	45-48	C½-25N	L-S-B	1	.4	45
Wheat, Cracked	40-45	B6-25N	L-S-B	1	.4	45
Wheat, Germ	18-28	B6-25	L-S-B	1	.4	45
White Lead, Dry	75-100	A40-36MR	H	2	1.0	30B
Wood Chips, Screened	10-30	D3-45VY	L-S	2	.6	30A
Wood Flour	16-36	B6-35N	L-S	1	.4	30A
Wood Shavings	8-16	E-45VY	L-S	2	1.5	30A
Zinc, Concentrate Residue	75-80	B6-37	H	3	1.0	15
Zinc Oxide, Heavy	30-35	A100-45X	L-S	1	1.0	30A
Zinc Oxide, Light	10-15	A100-45XY	L-S	1	1.0	30A

*Consult Factory

In order to determine the size and speed of a screw conveyor, it is necessary first to establish the material code number. It will be seen from what follows that this code number controls the cross-sectional loading that should be used. The various cross-sectional loadings shown in the Capacity Table (Table 1-6) are for use with the standard screw conveyor components indicated in the Component Group Selection Guide on page H-22 and are for use where the conveying operation is controlled with volumetric feeders and where the material is uniformly fed into the conveyor housing and discharged from it. Check lump size limitations before choosing conveyor diameter. See Table 1-7.

Capacity Table

The capacity table, (Table 1-6), gives the capacities in cubic feet per hour at one revolution per minute for various size screw conveyors for four cross-sectional loadings. Also shown are capacities in cubic feet per hour at the maximum recommended revolutions per minute.

The capacity values given in the table will be found satisfactory for most applications. Where the capacity of a screw conveyor is very critical, especially when handling a material not listed in Table 1-2, it is best to consult our Engineering Department.

The maximum capacity of any size screw conveyor for a wide range of materials, and various conditions of loading, may be obtained from Table 1-6 by noting the values of cubic feet per hour at maximum recommended speed.

Conveyor Speed

For screw conveyors with screws having standard pitch helical flights the conveyor speed may be calculated by the formula:

$$N = \frac{\text{Required capacity, cubic feet per hour}}{\text{Cubic feet per hour at 1 revolution per minute}}$$

N = revolutions per minute of screw, (but not greater than the maximum recommended speed.)

For the calculation of conveyor speeds where special types of screws are used, such as short pitch screws, cut flights, cut and folded flights and ribbon flights, an equivalent required capacity must be used, based on factors in the Tables 1-3, 4, 5.

Factor CF_1 relates to the pitch of the screw. Factor CF_2 relates to the type of the flight. Factor CF_3 relates to the use of mixing paddles within the flight pitches.

The equivalent capacity then is found by multiplying the required capacity by the capacity factors. See Tables 1-3, 4, 5 for capacity factors.

$$\left(\begin{array}{c} \text{Equiv. Capacity} \\ \text{Cubic Feet Per Hour} \end{array} \right) = \left(\begin{array}{c} \text{Required Capacity} \\ \text{Cubic Feet Per Hour} \end{array} \right) (CF_1) (CF_2) (CF_3)$$

Capacity Factors



Table 1-3

Special Conveyor Pitch Capacity Factor CF_1		
Pitch	Description	CF_1
Standard	Pitch = Diameter of Screw	1.00
Short	Pitch = $\frac{2}{3}$ Diameter of Screw	1.50
Half	Pitch = $\frac{1}{2}$ Diameter of Screw	2.00
Long	Pitch = $1\frac{1}{2}$ Diameter of Screw	0.67

Table 1-4

Special Conveyor Flight Capacity Factor CF_2			
Type of Flight	Conveyor Loading		
	15%	30%	45%
Cut Flight	1.95	1.57	1.43
Cut & Folded Flight	N.R.*	3.75	2.54
Ribbon Flight	1.04	1.37	1.62

*Not recommended
If none of the above flight modifications are used: $CF_2 = 1.0$

Table 1-5

Special Conveyor Mixing Paddle Capacity CF_3					
Standard Paddles at 45° Reverse Pitch	Paddles Per Pitch				
	None	1	2	3	4
Factor CF_3	1.00	1.08	1.16	1.24	1.32

(Consult Factory for Inclined Conveyors)

Table 1-6

	Trough Loading	Screw Dia. Inch	Capacity Cubic Feet Per Hour (Full Pitch)		Max. RPM
			At One RPM	At Max RPM	
45%		4	0.62	114	184
		6	2.23	368	165
		9	8.20	1270	155
		10	11.40	1710	150
		12	19.40	2820	145
		14	31.20	4370	140
		16	46.70	6060	130
		18	67.60	8120	120
		20	93.70	10300	110
		24	164.00	16400	100
		30	323.00	29070	90
30% A		4	0.41	53	130
		6	1.49	180	120
		9	5.45	545	100
		10	7.57	720	95
		12	12.90	1160	90
		14	20.80	1770	85
		16	31.20	2500	80
		18	45.00	3380	75
		20	62.80	4370	70
		24	109.00	7100	65
		30	216.00	12960	60
30% B		4	0.41	29	72
		6	1.49	90	60
		9	5.45	300	55
		10	7.60	418	55
		12	12.90	645	50
		14	20.80	1040	50
		16	31.20	1400	45
		18	45.00	2025	45
		20	62.80	2500	40
		24	109.00	4360	40
		30	216.00	7560	35
15%		4	0.21	15	72
		6	0.75	45	60
		9	2.72	150	55
		10	3.80	210	55
		12	6.40	325	50
		14	10.40	520	50
		16	15.60	700	45
		18	22.50	1010	45
		20	31.20	1250	40
		24	54.60	2180	40
		30	108.00	3780	35

Lump Size Limitations



The size of a screw conveyor not only depends on the capacity required, but also on the size and proportion of lumps in the material to be handled. The size of a lump is the maximum dimension it has. If a lump has one dimension much longer than its transverse cross-section, the long dimension or length would determine the lump size.

The character of the lump also is involved. Some materials have hard lumps that won't break up in transit through a screw conveyor. In that case, provision must be made to handle these lumps. Other materials may have lumps that are fairly hard, but degradable in transit through the screw conveyor, thus reducing the lump size to be handled. Still other materials have lumps that are easily broken in a screw conveyor and lumps of these materials impose no limitations.

Three classes of lump sizes are shown in TABLE 1-7 and as follows

Class 1

A mixture of lumps and fines in which not more than 10% are lumps ranging from maximum size to one half of the maximum; and 90% are lumps smaller than one half of the maximum size.

Class 2

A mixture of lumps and fines in which not more than 25% are lumps ranging from the maximum size to one half of the maximum; and 75% are lumps smaller than one half of the maximum size.

Class 3

A mixture of lumps only in which 95% or more are lumps ranging from maximum size to one half of the maximum size; and 5% or less are lumps less than one tenth of the maximum size.

Table 1-7

Maximum Lump Size Table					
Screw Diameter Inches	Pipe *O.D. Inches	Radial Clearance Inches \varnothing	Class I 10% Lumps Max. Lump, Inch	Class II 25% Lumps Max. Lump, Inch	Class III 95% Lumps Max. Lump, Inch
6	2 $\frac{5}{8}$	2 $\frac{5}{8}$	1 $\frac{1}{4}$	$\frac{3}{4}$	$\frac{1}{2}$
9	2 $\frac{5}{8}$	3 $\frac{3}{8}$	2 $\frac{1}{4}$	1 $\frac{1}{2}$	$\frac{3}{4}$
9	2 $\frac{7}{8}$	3 $\frac{3}{8}$	2 $\frac{1}{4}$	1 $\frac{1}{2}$	$\frac{3}{4}$
12	2 $\frac{7}{8}$	5 $\frac{1}{8}$	2 $\frac{3}{4}$	2	1
12	3 $\frac{1}{2}$	4 $\frac{3}{4}$	2 $\frac{3}{4}$	2	1
12	4	4 $\frac{1}{2}$	2 $\frac{3}{4}$	2	1
14	3 $\frac{1}{2}$	5 $\frac{3}{4}$	3 $\frac{1}{4}$	2 $\frac{1}{2}$	1 $\frac{1}{4}$
14	4	5 $\frac{1}{2}$	2 $\frac{1}{2}$	1 $\frac{1}{4}$	1 $\frac{1}{4}$
16	4	6 $\frac{1}{2}$	3 $\frac{3}{4}$	2 $\frac{3}{4}$	1 $\frac{1}{2}$
16	4 $\frac{1}{2}$	6 $\frac{1}{4}$	3 $\frac{3}{4}$	2 $\frac{3}{4}$	1 $\frac{1}{2}$
18	4	7 $\frac{1}{2}$	4 $\frac{1}{4}$	3	1 $\frac{1}{4}$
18	4 $\frac{1}{2}$	7 $\frac{1}{2}$	4 $\frac{1}{4}$	3	1 $\frac{1}{4}$
20	4	8 $\frac{1}{2}$	4 $\frac{3}{4}$	3 $\frac{1}{2}$	2
20	4 $\frac{1}{2}$	8 $\frac{1}{4}$	4 $\frac{3}{4}$	3 $\frac{1}{2}$	2
24	4 $\frac{1}{2}$	10 $\frac{1}{4}$	6	3 $\frac{3}{4}$	2 $\frac{1}{2}$
30	4 $\frac{1}{2}$	13 $\frac{1}{4}$	8	5	3

*For special pipe sizes, consult factory.

Δ Radial clearance is the distance between the bottom of the trough and the bottom of the conveyor pipe.

EXAMPLE: Lump Size Limitations

To illustrate the selection of a conveyor size from the Maximum Lump Size Table, Table 1-7, consider crushed ice as the conveyed material. Refer to the material charts Table 1-2 and find crushed ice and its material code D3-35Q and weight of 35-45 lbs./C.F. D3 means that the lump size is $\frac{1}{2}$ " to 3", this is noted by referring to the material classification code chart on page H-6. From actual specifications regarding crushed ice it is known that crushed ice has a maximum lump size of 1 $\frac{1}{2}$ " and only 25% of the lumps are 1 $\frac{1}{2}$ ". With this information refer to Table 1-7, Maximum Lump Size Table. Under the column Class II and 1 $\frac{1}{2}$ " Max. lump size read across to the minimum screw diameter which will be 9".

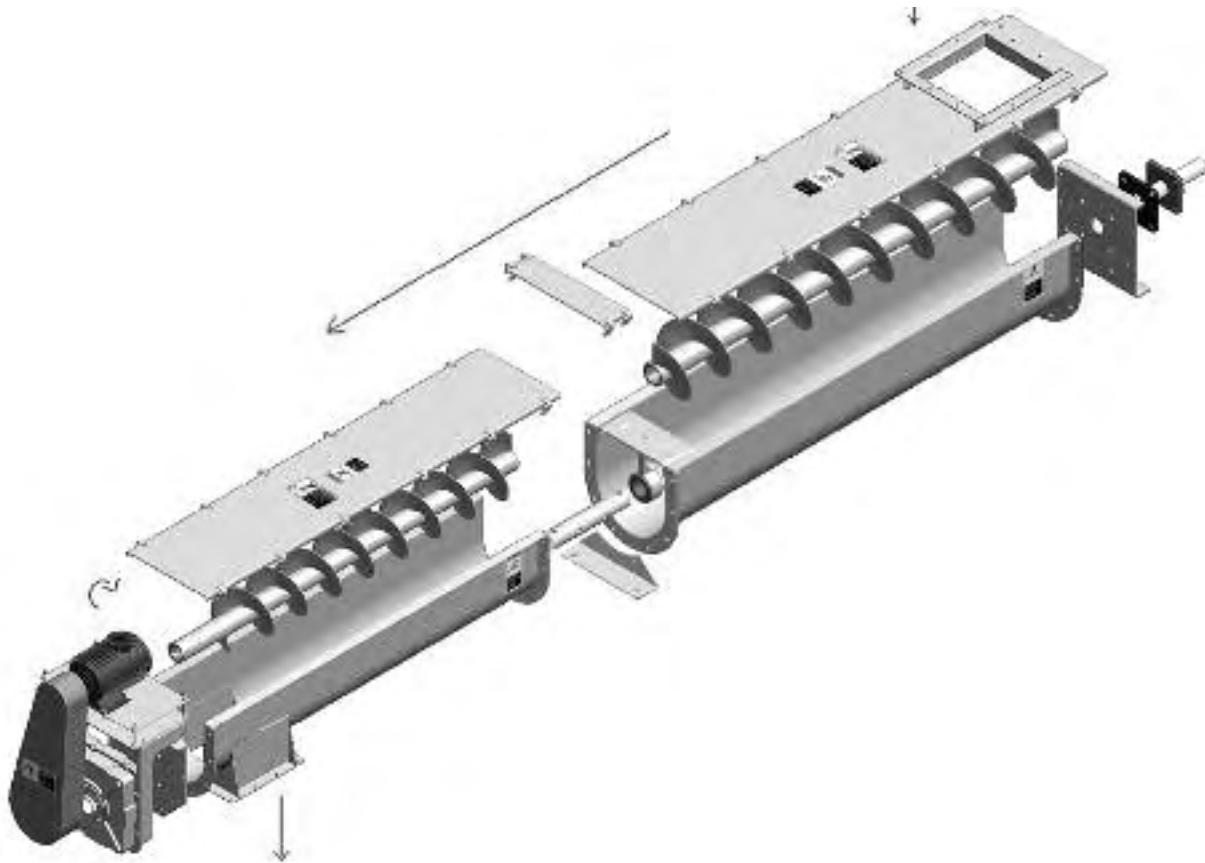

Component Groups

To facilitate the selection of proper specifications for a screw conveyor for a particular duty, screw conveyors are broken down into three Component Groups. These groups relate both to the Material Classification Code and also to screw size, pipe size, type of bearings and trough thickness.

Referring to Table 1-2, find the component series designation of the material to be conveyed.

Having made the Component Series selection, refer to Tables 1-8, 9, 10 which give the specifications of the various sizes of conveyor screws. (The tabulated screw numbers in this table refer to standard specifications for screws found on pages H-79 - H-83 Component Section.) These standards give complete data on the screws such as the length of standard sections, minimum edge thickness of screw flight, bushing data, bolt size, bolt spacing, etc.

EXAMPLE: For a screw conveyor to handle brewers grain, spent wet, refer to the material characteristics Table 1-2. Note that the component series column refers to series 2. Refer now to page H-22, component selection, Table 1-9, component group 2. The standard shaft sizes, screw flight designations, trough gauges and cover gauges are listed for each screw diameter.

Component Selection



Table 1-8

Component Group 1					
Screw Diameter Inches	Coupling Diameter Inches	Screw Number		Thickness, U.S. Standard Gauge or Inches	
		Helicoid Flights	Sectional Flights	Trough	Cover
6	1½	6H304	6S307	16 Ga.	16 Ga.
9	1½	9H306	9S307	14 Ga.	14 Ga.
9	2	9H406	9S409	14 Ga.	14 Ga.
12	2	12H408	12S409	12 Ga.	14 Ga.
12	2⅙	12H508	12S509	12 Ga.	14 Ga.
14	2⅙	14H508	14S509	12 Ga.	14 Ga.
16	3	16H610	16S612	12 Ga.	14 Ga.
18	3	—	18S612	10 Ga.	12 Ga.
20	3	—	20S612	10 Ga.	12 Ga.
24	3⅙	—	24S712	10 Ga.	12 Ga.
30	3⅙	—	30S712	10 Ga.	12 Ga.

Table 1-9

Component Group 2					
Screw Diameter Inches	Coupling Diameter Inches	Screw Number		Thickness, U.S. Standard Gauge or Inches	
		Helicoid Flights	Sectional Flights	Trough	Cover
6	1½	6H308	6S309	14 Ga..	16 Ga..
9	1½	9H312	9S309	10 Ga.	14 Ga.
9	2	9H412	9S412	10 Ga.	14 Ga.
12	2	12H412	12S412	⅝ In.	14 Ga.
12	2⅙	12H512	12S512	⅝ In.	14 Ga.
12	3	12H614	12S616	⅝ In.	14 Ga.
14	2⅙	—	14S512	⅝ In.	14 Ga.
14	3	14H614	14S616	⅝ In.	14 Ga.
16	3	16H614	16S616	⅝ In.	14 Ga.
18	3	—	18S616	⅝ In.	12 Ga.
20	3	—	20S616	⅝ In.	12 Ga.
24	3⅙	—	24S716	⅝ In.	12 Ga.
30	3⅙	—	30S716	⅝ In.	12 Ga.

Table 1-10

Component Group 3					
Screw Diameter Inches	Coupling Diameter Inches	Screw Number		Thickness, U.S. Standard Gauge or Inches	
		Helicoid Flights	Sectional Flights	Trough	Cover
6	1½	6H312	6S312	10 Ga.	16 Ga.
9	1½	9H312	9S312	⅝ In.	14 Ga.
9	2	9H414	9S416	⅝ In.	14 Ga.
12	2	12H412	12S412	¼ In.	14 Ga.
12	2⅙	12H512	12S512	¼ In.	14 Ga.
12	3	12H614	12S616	¼ In.	14 Ga.
14	3	—	14S624	¼ In.	14 Ga.
16	3	—	16S624	¼ In.	14 Ga.
18	3	—	18S624	¼ In.	12 Ga.
20	3	—	20S624	¼ In.	12 Ga.
24	3⅙	—	24S724	¼ In.	12 Ga.
30	3⅙	—	30S724	¼ In.	12 Ga.



Bearing Selection

The selection of bearing material for intermediate hangers is based on experience together with a knowledge of the characteristics of the material to be conveyed. By referring to the material characteristic tables, page H-8 thru H-16 the intermediate hanger bearing selection can be made by viewing the Bearing Selection column. The bearing selection will be made from one of the following types: B, L, S, H. The various bearing types available in the above categories can be selected from the following table.

Table 1-11

Hanger Bearing Selection				
Bearing Component Groups	Bearing Types	Recommended Coupling Shaft Material \emptyset	Max. Recommended Operating Temperature	F _b
B	Ball	Standard	180°	1.0
L	Bronze	Standard	300°F	
S	<i>Martin</i> Bronze*	Standard	850°F	2.0
	Graphite Bronze	Standard	500°F	
	Oil Impreg. Bronze	Standard	200°F	
	Oil Impreg. Wood	Standard	160°F	
	Nylatron	Standard	250°F	
	Nylon	Standard	160°F	
	Teflon	Standard	250°F	
	UHMW	Standard	225°F	
	Melamine (MCB)	Standard	250°F	
Urethane	Standard	200°F		
H	<i>Martin</i> Hard Iron*	Hardened	500°F	3.4
	Hard Iron	Hardened	500°F	4.4
	Hard Surfaced	Hardened or Special	500°F	
	Stellite	Special	500°F	
Ceramic	Special	1,000°F		

*Sintered Metal. Self-lubricating.

Δ OTHER TYPES OF COUPLING SHAFT MATERIALS

Various alloys, stainless steel, and other types of shafting can be furnished as required.

Horsepower Requirements



Horizontal Screw Conveyors

***Consult Factory for Inclined Conveyors or Screw Feeders**

The horsepower required to operate a horizontal screw conveyor is based on proper installation, uniform and regular feed rate to the conveyor and other design criteria as determined in this book.

The horsepower requirement is the total of the horsepower to overcome friction (HP_f) and the horsepower to transport the material at the specified rate (HP_m) multiplied by the overload factor F_o and divided by the total drive efficiency e , or:

$$HP_f = \frac{LN F_d f_b}{1,000,000} = \text{(Horsepower to run an empty conveyor)}$$

$$HP_m = \frac{CLW F_f F_m F_p}{1,000,000} = \text{(Horsepower to move the material)}$$

$$\text{Total HP} = \frac{(HP_f + HP_m) F_o}{e}$$

The following factors determine the horsepower requirement of a screw conveyor operating under the foregoing conditions.

- L = Total length of conveyor, feet
- N = Operating speed, RPM (revolutions per minute)
- F_d = Conveyor diameter factor (See Table 1-12)
- F_b = Hanger bearing factor (See Table 1-13)
- C = Capacity in cubic feet per hour
- W = Weight of material, lbs. per cubic foot
- F_f = Flight factor (See Table 1-14)
- F_m = Material factor (See Table 1-2)
- F_p = Paddle factor, when required. (See Table 1-15)
- F_o = Overload factor (See Table 1-16)
- e = Drive efficiency (See Table 1-17)

Table 1-12

Conveyor Diameter Factor, F_d			
Screw Diameter Inches	Factor F_d	Screw Diameter Inches	Factor F_d
4	12.0	14	78.0
6	18.0	16	106.0
9	31.0	18	135.0
10	37.0	20	165.0
12	55.0	24	235.0
		30	300

Table 1-13

Hanger Bearing Factor F_b		
Bearing Type		Hanger Bearing Factor F_b
B	Ball	1.0
L	<i>Martin</i> Bronze	2.0
S	*Graphite Bronze *Melamine *Oil Impreg. Bronze *Oil Impreg. Wood *Nylatron *Nylon *Teflon *UHMW *Urethane	2.0
	* <i>Martin</i> Hard Iron	3.4
H	*Hard Surfaced *Stellite * Ceramic	4.4

*Non lubricated bearings, or bearings not additionally lubricated.

Table 1-14
Flight Factor, F_f

Flight Type	F_f Factor for Percent Conveyor Loading			
	15%	30%	45%	95%
Standard	1.0	1.0	1.0	1.0
Cut Flight	1.10	1.15	1.20	1.3
Cut & Folded Flight	N.R.*	1.50	1.70	2.20
Ribbon Flight	1.05	1.14	1.20	—
*Not Recommended				

Table 1-15

Paddle Factor F_p					
Standard Paddles per Pitch, Paddles Set at 45° Reverse Pitch					
Number of Paddles per Pitch	0	1	2	3	4
Paddle Factor — F_p	1.0	1.29	1.58	1.87	2.16

Table 1-16

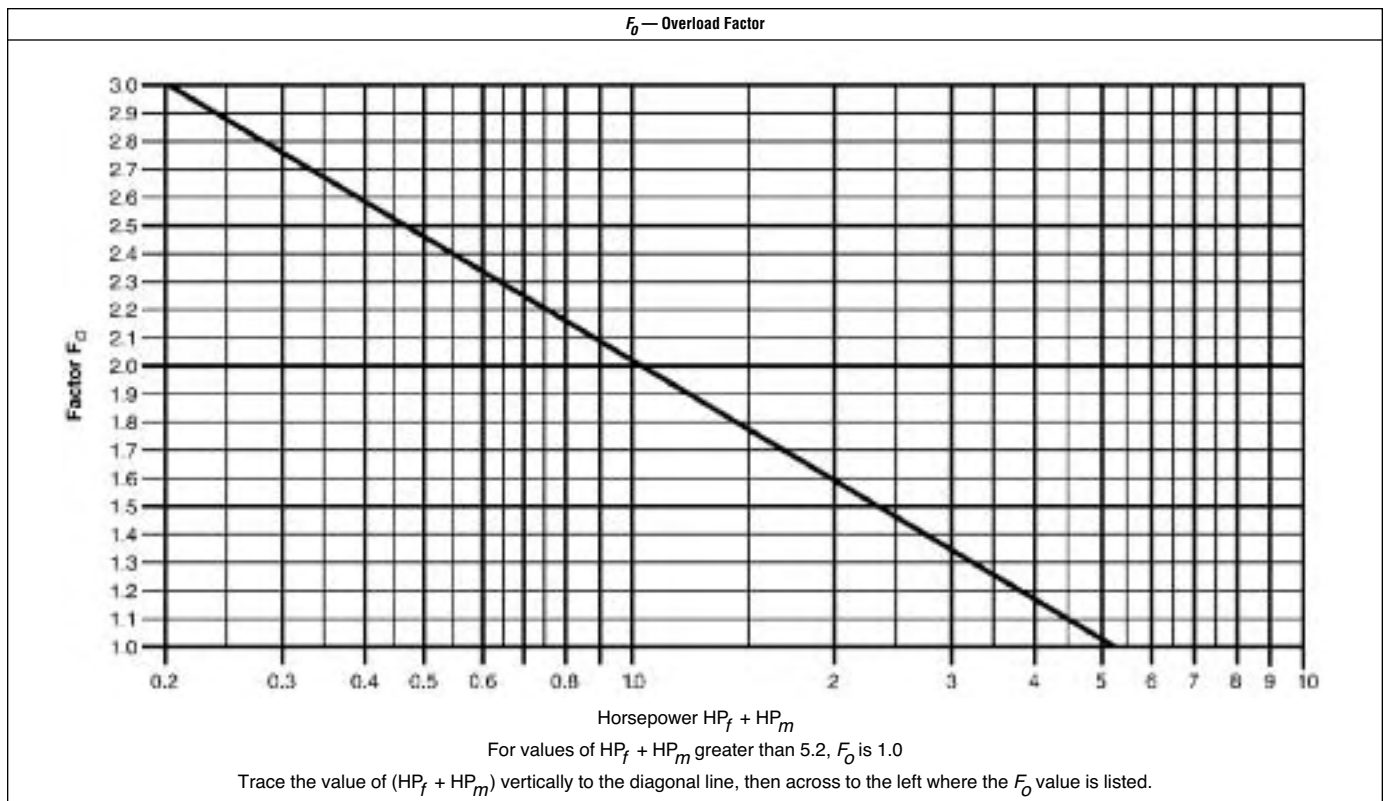

Table 1-17

e Drive Efficiency Factor				
Screw Drive or Shaft Mount w/ V-Belt Drive	V-Belt to Helical Gear and Coupling	Gearmotor w/ Coupling	Gearmotor w/ Chain Drive	Worm Gear
.88	.87	.95	.87	Consult Manufacturer

Horsepower

EXAMPLE: Horsepower Calculation (See page H-50 for sample worksheet)

PROBLEM: Convey 1,000 cubic feet per hour Brewers grain, spent wet, in a 25'-0" long conveyor driven by a screw conveyor drive with V-belts.

SOLUTION:

1. Refer to material characteristic table 1-2 for Brewers grain, spent wet and find:
 - A. wt/cf: 55 - 60
 - B. material code: C½ - 45T
Refer to Table 1-1, material classification code chart where:
C½ = Fine ½" and under
4 = Sluggish
5 = Mildly abrasive
T = Mildly corrosive
 - C. Intermediate bearing selection: L or S
Refer to Table 1-11 Bearing Selection, Find:
L = Bronze
S = Nylatron, Nylon, Teflon, UHMW Melamine, Graphite Bronze, Oil-impreg. Bronze, and oil-impreg. wood and Urethane.
 - D. Material Factor: $F_m = .8$
 - E. Trough Loading: 30%A
Refer to Table 1-6 capacity table and find 30%A which shows the various capacities per RPM of the standard size screw conveyors and the maximum RPM's for those sizes.
2. From Table 1-6, Capacity table under 30%A note that a 12" screw will convey 1,160 cubic feet per hour at 90 RPM maximum, therefore at 1 RPM a 12" screw will convey 12.9 cubic feet. For 1,000 CFH capacity at 12.9 CFH per RPM, the conveyor must therefore run 78RPM ($1000 \div 12.9 = 77.52$).
3. With the above information and factors from Tables 1-12 through 1-17 refer to the horsepower formulas on H-24 and calculate the required horsepower to convey 1000 CF/H for 25 feet in a 12" conveyor.

Using the known factors find that:

$L = 25'$	$C = 1000 \text{ CFH}$
$N = 78 \text{ RPM}$ from step 2 above	$W = 60\#/CF$ from step 1A
$F_d = 55$ see Table 1-12, for 12"	$F_f = 1$ see Table 1-14, standard 30%
$F_b = 2.0$ see Table 1-13 for L	$F_p = 1$ see Table 1-15
	$e = .88$ see Table 1-17

4. Solve the following horsepower equations:

$$A. \text{HP}_f = \frac{L N F_d F_b}{1,000,000} = \frac{25 \times 78 \times 55 \times 2.0}{1,000,000} = 0.215$$

$$B. \text{HP}_m = \frac{C L W F_f F_m F_p}{1,000,000} = \frac{1000 \times 25 \times 60 \times 1 \times .8 \times 1}{1,000,000} = 1.2$$

Find the F_o factor from 1-16; by adding HP_f and HP_m and matching this sum to the values on the chart.

$$C. \text{HP}_f = \frac{(\text{HP}_f + \text{HP}_m) (F_o)}{e} = \frac{(1.414) (1.9)}{.88} = 3.05$$

SOLUTION: 3.05 Horsepower is required to convey 1,000 CFH Brewers grain, spent wet in a 12" conveyor for 25 feet. A 5 H.P. motor should be used.



Torsional Ratings of Conveyor Screw Parts

Screw conveyors are limited in overall design by the amount of torque that can be safely transmitted through the pipes, couplings, and coupling bolts.

The table below combines the various torsional ratings of bolts, couplings and pipes so that it is easy to compare the torsional ratings of all the stressed parts of standard conveyor screws.

Table 1-18

Coupling	Pipe		Couplings		Bolts					
	Sch. 40		Torque in Lbs.*		Bolt Dia. In.	Bolts in Shear in Lbs. ▲		Bolts in Bearing in Lbs.		
	Shaft Dia. In.	Size In.	Torque In. Lbs.	CEMA Std. (C-1018)		Martin Std. (C-1045)	No. of Bolts Used		No. of Bolts Used	
							2	3	2	3
1	1½	3,140	820	999	⅜	1,380	2,070	1,970	2,955	
1½	2	7,500	3,070	3,727	½	3,660	5,490	5,000	7,500	
2	2½	14,250	7,600	9,233	⅝	7,600	11,400	7,860	11,790	
2⅞	3	23,100	15,090	18,247	¾	9,270	13,900	11,640	17,460	
3	3½	32,100	28,370	34,427	¾	16,400	24,600	15,540	23,310	
3	4	43,000	28,370	34,427	¾	16,400	24,600	25,000	37,500	
3⅞	4	43,300	42,550	51,568	7⁄8	25,600	38,400	21,800	32,700	

▲ Values shown are for A307-64, Grade 2 Bolts. Values for Grade 5 Bolts are above × 2.5
 *Values are for unheattreated shafts.

The lowest torsional rating figure for any given component will be the one that governs how much torque may be safely transmitted. For example, using standard unhardened two bolt coupling shafts, the limiting torsional strength of each part is indicated by the underlined figures in Table 1-18.

Thus it can be seen that the shaft itself is the limiting factor on 1", 1½" and 2" couplings. The bolts in shear are the limiting factors on the 2⅞" coupling and on the 3" coupling used in conjunction with 4" pipe. The bolts in bearing are the limiting factors for the 3" coupling used in conjunction with 3½" pipe, and for the 3⅞" coupling.

Formula: Horsepower To Torque (In. Lbs.)

$$\frac{63,025 \times \text{HP}}{\text{RPM}} = \text{Torque (In. Lbs.)}$$

EXAMPLE: 12" Screw, 78 RPM, 5 Horsepower

$$\frac{63,025 \times 5}{78} = 4,040 \text{ In. Lbs.}$$

From the table above 2" shafts with 2 bolt drilling and 2½" std. pipe are adequate (4,040 < 7600).

If the torque is greater than the values in the above table, such as in 2" couplings (torque > 7600), then hardened shafts can be used as long as the torque is less than the value for hardened couplings (torque < 9500). If the torque is greater than the 2 bolt in shear value but less than the 3 bolt in shear value then 3 bolt coupling can be used. The same applies with bolts in bearing. When the transmitted torque is greater than the pipe size value, then larger pipe or heavier wall pipe may be used. Other solutions include: high torque bolts to increase bolt in shear rating, external collars, or bolt pads welded to pipe to increase bolt in bearing transmission. For solutions other than those outlined in the above table please consult our Engineering Department.

CONVEYORS

Horsepower Ratings of Conveyor Screw Parts



Screw conveyors are limited in overall design by the amount of horsepower that can be safely transmitted through the pipes, couplings, and coupling bolts.

The table below combines the various horsepower ratings of bolts, couplings and pipes so that it is easy to compare the ratings of all the stressed parts of standard conveyor screws.

Table 1-19

Coupling		Pipe		Couplings		Bolts			
Shaft Dia. In.	Size In.	H.P. per R.P.M.	H.P. per R.P.M.		Bolt Dia. In.	Bolts in Shear H.P. per R.P.M. ▲		Bolts in Bearing H.P. per R.P.M.	
			CEMA Std. (C-1018)	Martin Std. (C-1045)		No. of Bolts Used		No. of Bolts Used	
						2	3	2	3
1	1¼	.049	.013	.016	⅜	.021	.032	.031	.046
1½	2	.119	.048	.058	½	.058	.087	.079	.119
2	2½	.226	.120	.146	⅝	.120	.180	.124	.187
2⅞	3	.366	.239	.289	⅝	.147	.220	.184	.277
3	3½	.509	.450	.546	¾	.260	.390	.246	.369
3	4	.682	.450	.546	¾	.260	.390	.396	.595
3⅞	4	.682	.675	.818	7⁄8	.406	.609	.345	.518

▲ Values shown are for A307-64, Grade 2 Bolts.

The lowest horsepower rating figure for any given component will be the one that governs how much horsepower may be safely transmitted. The limiting strength of each part is indicated by the underlined figures in the table above.

Formula: Horsepower To Horsepower @ 1 RPM

EXAMPLE: 12" Screw, 78 RPM, 5 Horsepower

$$\frac{5 \text{ HP}}{78 \text{ RPM}} = 0.06 \text{ HP at 1 RPM}$$

From the table above .038 is less than the lowest limiting factor for 2" couplings, so 2" standard couplings with 2 bolts may be used. Solutions to limitations are the same as shown on H-27.

End thrust in a Screw Conveyor is created as a reaction to the forces required to move the material along the axis of the conveyor trough. Such a force is opposite in direction to the flow of material. A thrust bearing and sometimes reinforcement of the conveyor trough is required to resist thrust forces. Best performance can be expected if the conveyor end thrust bearing is placed so that the rotating members are in tension; therefore, an end thrust bearing should be placed at the discharge end of a conveyor. Placing an end thrust bearing assembly at the feed end of a conveyor places rotating members in compression which may have undesirable effects, but this is sometimes necessary in locating equipment.

There are several methods of absorbing thrust forces, the most popular methods are:

1. Thrust washer assembly — installed on the shaft between the pipe end and the trough end plate, or on the outside of the end bearing.
2. Type “E” end thrust assembly, which is a Double Roller Bearing and shaft assembly.
3. Screw Conveyor Drive Unit, equipped with double roller bearing thrust bearings, to carry both thrust and radial loads.

Past experience has established that component selection to withstand end thrust is rarely a critical factor and thrust is not normally calculated for design purposes. Standard conveyor thrust components will absorb thrust without resorting to special design in most applications.

Expansion of Screw Conveyors Handling Hot Materials

Screw conveyors often are employed to convey hot materials. It is therefore necessary to recognize that the conveyor will increase in length as the temperature of the trough and screw increases when the hot material begins to be conveyed.

The recommended general practice is to provide supports for the trough which will allow movement of the trough end feet during the trough expansion, and during the subsequent contraction when handling of the hot material ceases. The drive end of the conveyor usually is fixed, allowing the remainder of the trough to expand or contract. In the event there are intermediate inlets or discharge spouts that cannot move, the expansion type troughs are required.

Furthermore, the conveyor screw may expand or contract in length at different rates than the trough. Therefore, expansion hangers are generally recommended. The trough end opposite the drive should incorporate an expansion type ball or roller bearing or sleeve bearing which will safely provide sufficient movement.

The change in screw conveyor length may be determined from the following formula:

$$\Delta L = L (t_1 - t_2) C$$

Where: ΔL = increment of change in length, inch

L = overall conveyor length in inches

t_1 = upper limit of temperature, degrees Fahrenheit

t_2 = limit of temperature, degrees Fahrenheit,
(or lowest ambient temperature expected)

C = coefficient of linear expansion, inches per inch per degree Fahrenheit. This coefficient has the following values for various metals:

(a) Hot rolled carbon steel, 6.5×10^{-6} , (.0000065)

(b) Stainless steel, 9.9×10^{-6} , (.0000099)

(c) Aluminum, 12.8×10^{-6} , (.0000128)

EXAMPLE:

A carbon steel screw conveyor 30 feet overall length is subject to a rise in temperature of 200°F, reaching a hot metal temperature of 260°F from an original metal temperature of 60°F.

$$t_1 = 260 \quad t_1 - t_2 = 200$$

$$t_2 = 60$$

$$L = (30) (12) = 360$$

$$\Delta L = (360) (200) (6.5 \times 10^{-6})$$

$$= 0.468 \text{ inches, or about } \frac{15}{32} \text{ inches.}$$

Conveyor Screw Deflection



When using conveyor screws of standard length, deflection is seldom a problem. However, if longer than standard sections of screw are to be used, without intermediate hanger bearings, care should be taken to prevent the screw flights from contacting the trough because of excessive deflection. The deflection at mid span may be calculated from the following formula.

$$D = \frac{5WL^3}{384 (29,000,000) (I)}$$

Where: D = Deflection at mid span in inches

W = Total screw weight in pounds, see pages H-81 to H-83

L = Screw length in inches

I = Movement of inertia of pipe or shaft, see table 1-20 or 1-21 below

Table 1-20 Schedule 40 Pipe

Pipe Size	2"	2½"	3"	3½"	4"	5"	6"	8"	10"
I	.666	1.53	3.02	4.79	7.23	15.2	28.1	72.5	161

Table 1-21 Schedule 80 Pipe

Pipe Size	2"	2½"	3"	3½"	4"	5"	6"	8"	10"
I	.868	1.92	3.89	6.28	9.61	20.7	40.5	106	212

EXAMPLE: Determine the deflection of a 12H512 screw conveyor section mounted on 3" sch 40 pipe, overall length is 16'-0".

W = 272#

L = 192"

I = 3.02 (From chart above)

$$D = \frac{5 (272\#) (192^3)}{384 (29,000,000) (3.02)} = .29 \text{ inches}$$

Applications where the calculated deflection of the screw exceeds .25 inches (¼") should be referred to our Engineering Department for recommendations. Very often the problem of deflection can be solved by using a conveyor screw section with a larger diameter pipe or a heavier wall pipe. Usually, larger pipe sizes tend to reduce deflection more effectively than heavier wall pipe.

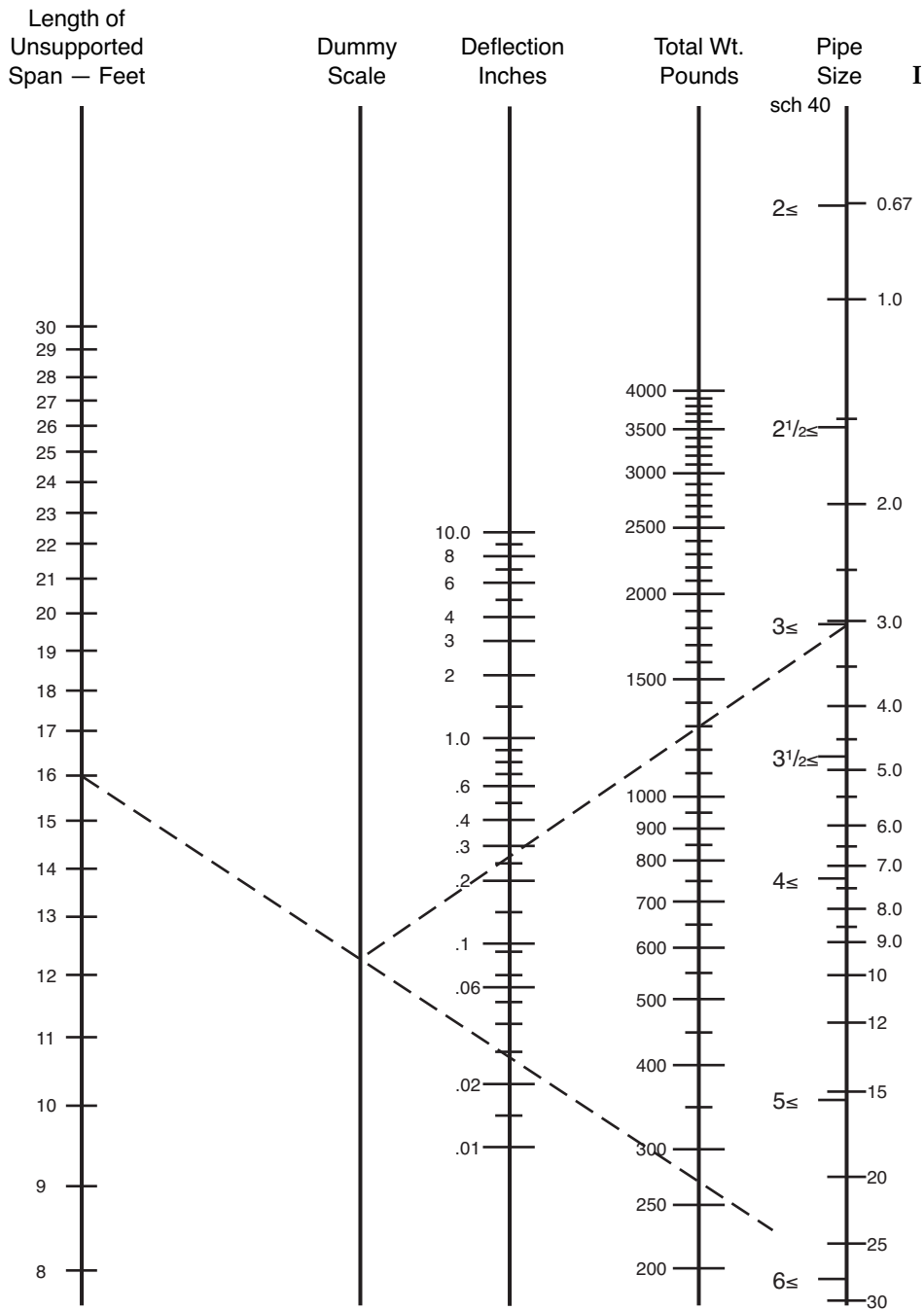

I = Moment of inertia of pipe or shaft, see Table 1-20 or 1-21

The above Nomograph can be used for a quick reference to check deflection of most conveyors.

Inclined and Vertical Screw Conveyors

Inclined
Screw
Conveyors

Inclined screw conveyors have a greater horsepower requirement and a lower capacity rating than horizontal conveyors. The amounts of horsepower increase and capacity loss depend upon the angle of incline and the characteristics of the material conveyed.

Inclined conveyors operate most efficiently when they are of tubular or shrouded cover design, and a minimum number of intermediate hanger bearings. Where possible, they should be operated at relatively high speeds to help prevent fallback of the conveyed material.

Consult our Engineering Department for design recommendations and horsepower requirements for your particular application.

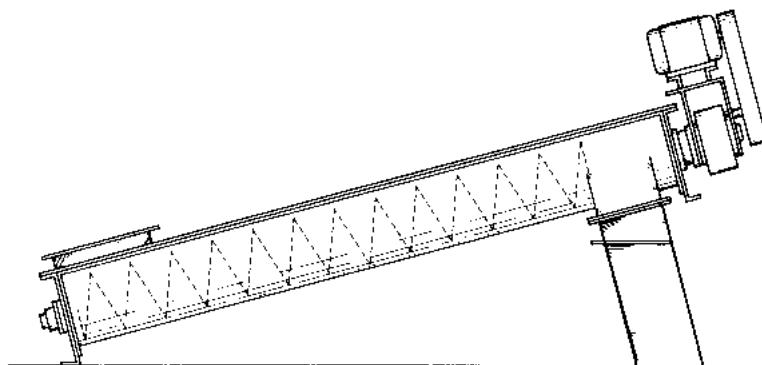

Vertical screw conveyors provide an efficient method of elevating most materials that can be conveyed in horizontal screw conveyors. Since vertical conveyors must be uniformly loaded in order to prevent choking, they are usually designed with integral feeders.

As with horizontal conveyors, vertical screw conveyors are available with many special features and accessories, including components of stainless steel or other alloys.

Consult our Engineering Department for design recommendations and horsepower requirements for your particular application.

SEE VERTICAL SCREW CONVEYOR SECTION OF CATALOG FOR ADDITIONAL INFORMATION.

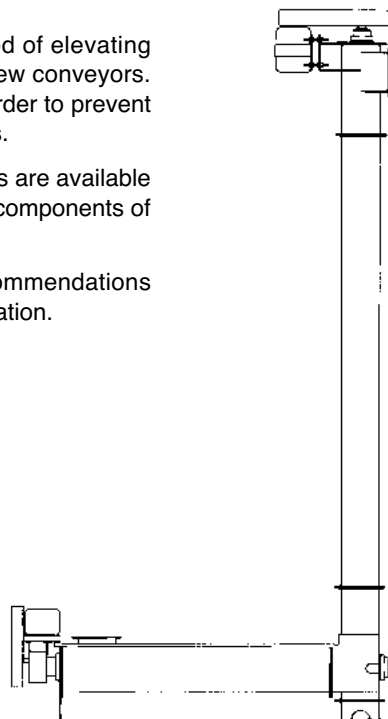

CONVEYORS

Vertical
Screw
Conveyors

Screw Feeders are designed to regulate the rate of material flow from a hopper or bin. The inlet is usually flooded with material (95% loaded). One or more tapered or variable pitch screws convey the material at the required rate. Screw feeders are regularly provided with shrouded or curved cover plates for a short distance beyond the end of the inlet opening, to obtain feed regulation. As the pitch or diameter increases beyond the shroud the level of the material in the conveyor drops to normal loading levels. Longer shrouds, extra short pitch screws and other modifications are occasionally required to reduce flushing of very free flowing material along the feeder screw.

Feeders are made in two general types: Type 1 with regular pitch flighting and Type 2 with short pitch flighting. Both types are also available with uniform diameter and tapering diameter screws. The various combinations are shown on pages H-34–H-35. Screw feeders with uniform screws, Types 1B, 1D, 2B, 2D are regularly used for handling fine free flowing materials. Since the diameter of the screw is uniform, the feed of the material will be from the forepart of the inlet and not across the entire length. Where hoppers, bins, tanks, etc. are to be completely emptied, or dead areas of material over the inlet are not objectionable, this type of feeder is entirely satisfactory, as well as economical. Screw feeders with tapering diameter screws will readily handle materials containing a fair percentage of lumps. In addition, they are used extensively where it is necessary or desirable to draw the material uniformly across the entire length of the inlet opening to eliminate inert or dead areas of material at the forepart of the opening. Types 1A, 1C, 2A, and 2C fall into this category. Variable pitch screws can be used in place of tapering diameter screws for some applications. They consist of screws with succeeding sectional flights increasing progressively in pitch. The portion of the screw with the smaller pitch is located under the inlet opening.

Screw feeders with extended screw conveyors are necessary when intermediate hangers are required, or when it is necessary to convey the material for some distance. A screw conveyor of larger diameter than the feeder screw is combined with the feeder to make the extension. See types 1C, 1D, 2C, 2D.

Multiple screw feeders are usually in flat bottom bins for discharging material which have a tendency to pack or bridge under pressure. Frequently, the entire bin bottom is provided with these feeders which convey the material to collecting conveyors. Such arrangements are commonly used for handling hogged fuel, wood shavings, etc.

Screw feeders are available in a variety of types to suit specific materials and applications. We recommend that you contact our Engineering Department for design information.

Screw Feeders

(For Inclined Applications Consult Factory)



Typical Type 1

Feeder Type	Inlet Opening	Material Removal	Pitch	Feeder Screw Diameter	Extended Screw
SF1A	Standard	Uniform Full Length of Inlet Opening	Standard	Tapered	None
SF1B	Standard	Forepart Only of Inlet Opening	Standard	Uniform	None
SF1C	Standard	Uniform Full Length of Inlet Opening	Standard	Tapered	As Required
SF1D	Standard	Forepart Only of Inlet Opening	Standard	Uniform	As Required

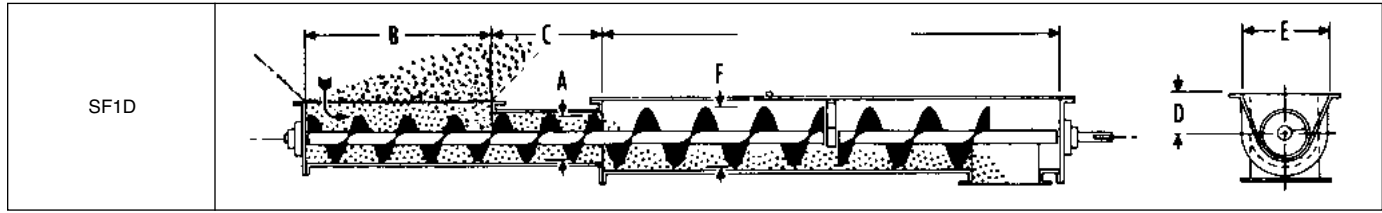
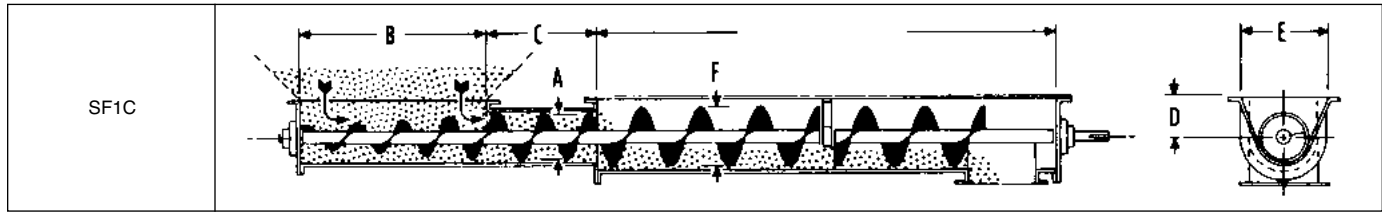
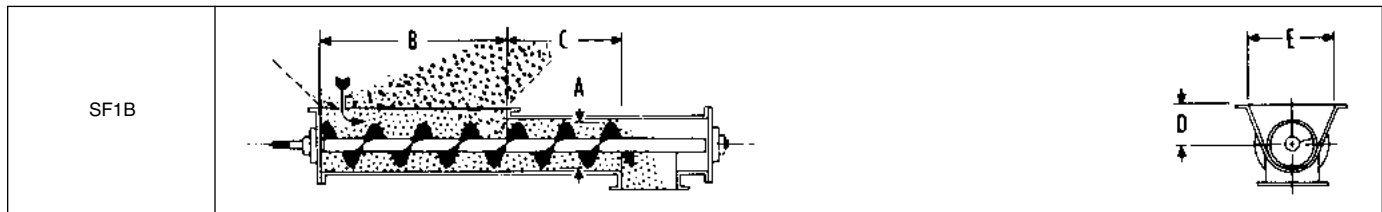
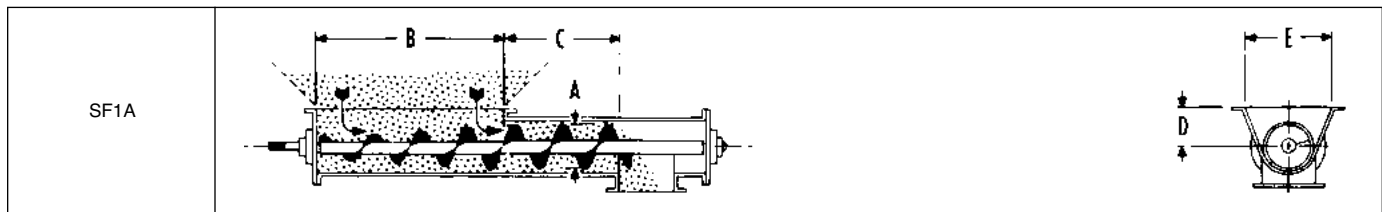

CONVEYORS

Feeder Diameter A	Maximum Lump Size	Maximum Speed RPM	Capacity Cubic Feet per Hour		B	C	D	E	Extended Screw Diameter F		
			At One RPM	At Maximum RPM					Trough Loading %		
									15	30	45
6	3/4"	70	4.8	336	36	12	7	14	12	9	9
9	1 1/2"	65	17	1105	42	18	9	18	18	14	12
12	2"	60	44	2640	48	24	10	22	24	18	16
14	2 1/2"	55	68	3740	54	28	11	24		20	18
16	3"	50	104	5200	56	32	11 1/2	28		24	20
18	3"	45	150	6750	58	36	12 1/2	31			24
20	3 1/2"	40	208	8320	60	40	13 1/2	34			
24	4"	30	340	10200	64	48	16 1/2	40			

*Consult factory if inlet exceeds these lengths.

Typical Type 2

Feeder Type	Inlet Opening	Material Removal	Pitch	Feeder Screw Diameter	Extended Screw
SF2A	Long	Uniform Full Length of Inlet Opening	Short (%)	Tapered	None
SF2B	Long	Forepart Only of Inlet Opening	Short (%)	Uniform	None
SF2C	Long	Uniform Full Length of Inlet Opening	Short (%)	Tapered	As Required
SF2D	Long	Forepart Only of Inlet Opening	Short (%)	Uniform	As Required

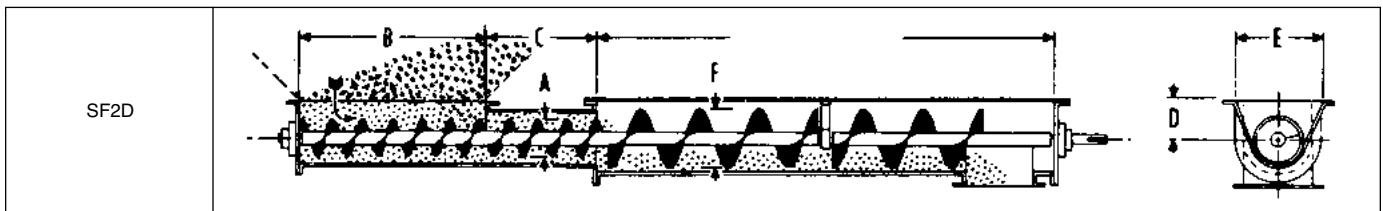
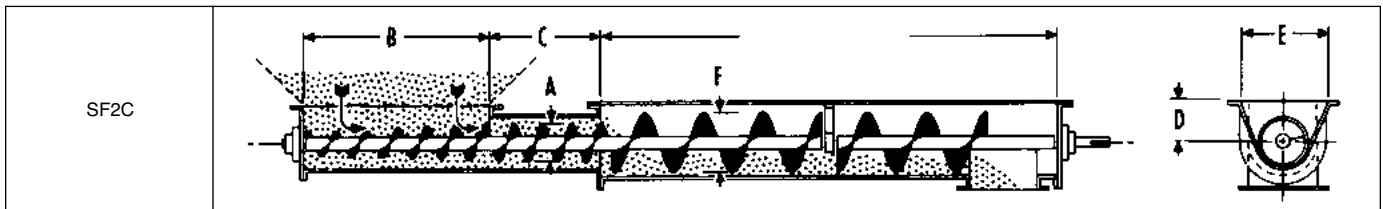
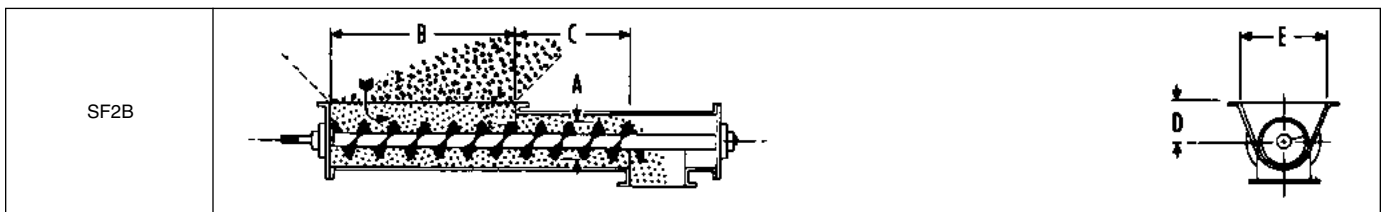
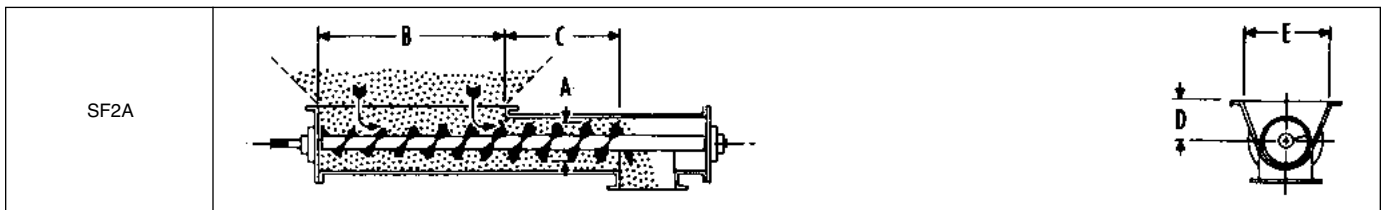

Feeder Diameter A	Maximum Lump Size	Maximum Speed RPM	Capacity Cubic Feet per Hour		B	C	D	E	Extended Screw Diameter F		
			At One RPM	At Maximum RPM					Trough Loading %		
									15	30	45
6	½"	70	3.1	217	60	18	7	14	10	9	9
9	¾"	65	11	715	66	26	9	18	14	12	10
12	1"	60	29	1740	72	36	10	22	20	16	14
14	1¼"	55	44	2420	76	42	11	24	24	18	16
16	1½"	50	68	3400	78	48	11½	28		20	18
18	1¾"	45	99	4455	80	54	12½	31		24	20
20	2"	40	137	5480	82	60	13½	34			24
24	2½"	30	224	6720	86	72	16½	40			

SECTION II

DESIGN AND LAYOUT SECTION II

Classification of Enclosure Types	H-36
Hand of Conveyors	H-38
Classification of Special Continuous Weld Finishes	H-39
Detailing of “U” Trough.....	H-40
Detailing of Tubular Trough.....	H-41
Detailing of Trough and Discharge Flanges.....	H-42
Bolt Tables	H-44
Pipe Sizes and Weights	H-46
Screw Conveyor Drive Arrangements.....	H-47
Standards Helicoid Screw.....	H-48
Standards Buttweld Screw.....	H-49
Screw Conveyor Sample Horsepower Worksheet.....	H-50

Classes of Enclosures

Conveyors can be designed to protect the material being handled from a hazardous surrounding or to protect the surroundings from a hazardous material being conveyed.

This section establishes recommended classes of construction for conveyor enclosures — without regard to their end use or application. These several classes call for specific things to be done to a standard conveyor housing to provide several degrees of enclosure protection.

Enclosure Classifications

- Class IE — Class IE enclosures are those provided primarily for the protection of operating personnel or equipment, or where the enclosure forms an integral or functional part of the conveyor or structure. They are generally used where dust control is not a factor or where protection for, or against, the material being handled is not necessary — although as conveyor enclosures a certain amount of protection is afforded.
- Class IIE — Class IIE enclosures employ constructions which provide some measure of protection against dust or for, or against, the material being handled.
- Class IIIIE — Class IIIIE enclosures employ constructions which provide a higher degree of protection in these classes against dust, and for or against the material being handled.
- Class IVE — Class IVE enclosures are for outdoor applications and under normal circumstances provide for the exclusion of water from the inside of the casing. They are not to be construed as being water-tight, as this may not always be the case.

When more than one method of fabrication is shown, either is acceptable.

Enclosure Construction				
Component Classification	Enclosure Classifications			
	I E	II E	III E	IV E
A. TROUGH CONSTRUCTION				
Formed & Angle Top Flange				
1. Plate type end flange				
a. Continuous arc weld	X	X	X	X
b. Continuous arc weld on top of end flange and trough top rail	X	X	X	X
2. Trough Top Rail Angles (Angle Top trough only)				
a. Staggered intermittent arc and spot weld	X			
b. Continuous arc weld on top leg of angle on inside of trough and intermittent arc weld on lower leg of angle to outside of trough		X	X	X
c. Staggered intermittent arc weld on top leg of angle on inside of trough and intermittent arc weld on lower leg of angle to outside of trough, or spot weld when mastic is used between leg of angle and trough sheet		X	X	X
B. COVER CONSTRUCTION				
1. Plain flat				
a. Only butted when hanger is at cover joint	X			
b. Lapped when hanger is not at cover joint	X			
2. Semi-Flanged				
a. Only butted when hanger is at cover joint	X	X	X	X
b. Lapped when hanger is not at cover joint	X			
c. With buttstrap when hanger is not at cover joint		X	X	X
3. Flanged				
a. Only butted when hanger is at cover joint		X	X	X
b. Buttstrap when hanger is not at cover joint		X	X	X
4. Hip Roof				
a. Ends with a buttstrap connection				X
C. COVER FASTENERS FOR STANDARD GA. COVERS				
1. Spring, screw or toggle clamp fasteners or bolted construction*				
a. Max. spacing plain flat covers	60"			
b. Max. spacing semi-flanged covers	60"	30"	18"	18"
c. Max. spacing flanged and hip-roof covers		40"	24"	24"
D. GASKETS				
1. Covers				
a. Red rubber or felt up to 230° F		X	X	
b. Neoprene rubber, when contamination is a problem		X	X	
c. Closed cell foam type elastic material to suit temperature rating of gasket		X	X	X
2. Trough End flanges				
a. Mastic type compounds		X	X	X
b. Red rubber up to 230° F		X	X	X
c. Neoprene rubber, when contamination is a problem		X	X	
d. Closed cell foam type elastic material to suit temperature rating of gasket		X	X	X
E. TROUGH END SHAFT SEALS*				
1. When handling non-abrasive materials			X	X
2. When handling abrasive materials	X	X	X	X
*Lip type seals for non-abrasive materials Felt type for mildly abrasive materials Waste type for highly abrasive materials Waste type for moderately abrasive Air purged <i>Martin</i> Super Pac for extremely abrasive Bulk Heads may be required for abrasive & hot materials				
NOTE: CHECK MATERIAL TEMPERATURE.				

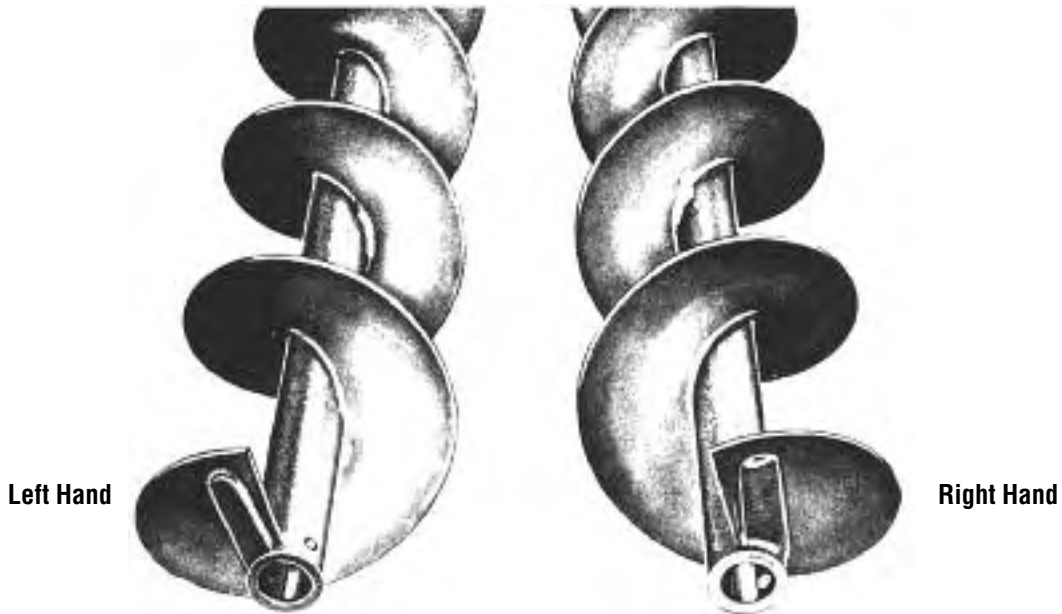

Right and Left Hand Screws

A conveyor screw is either right hand or left hand depending on the form of the helix. The hand of the screw is easily determined by looking at the end of the screw.

The screw pictured to the left has the flight helix wrapped around the pipe in a counter-clockwise direction, or to your left. Same as left hand threads on a bolt. This is arbitrarily termed a LEFT hand screw.

The screw pictured to the right has the flight helix wrapped around the pipe in a clockwise direction, or to your right. Same as right hand threads on a bolt. This is termed a RIGHT hand screw.

A conveyor screw viewed from either end will show the same configuration. If the end of the conveyor screw is not readily visible, then by merely imagining that the flighting has been cut, with the cut end exposed, the hand of the screw may be easily determined.

Conveyor Screw Rotation

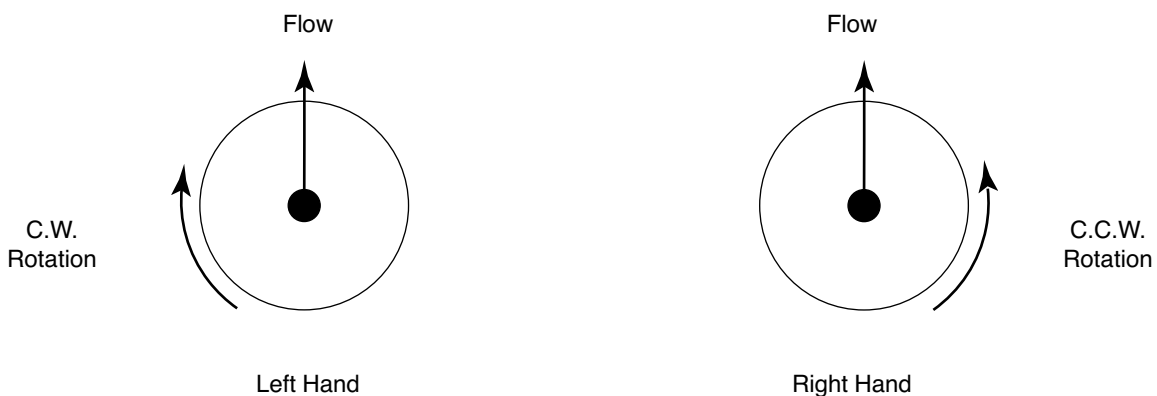

The above diagrams are a simple means of determining screw rotation. When the material flow is in the direction away from the end being viewed, a R.H. screw will turn counter clockwise and a L.H. screw will turn clockwise rotation as shown by the arrows.

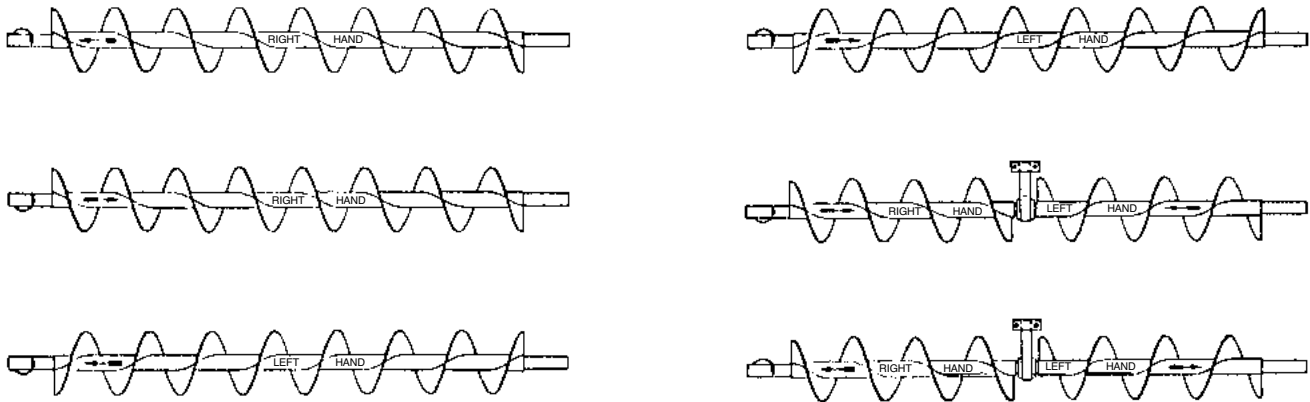

The above diagram indicates the hand of conveyor screw to use when direction of rotation and material flow are known.

Special Screw Conveyor Continuous Weld Finishes

Specifications on screw conveyor occasionally include the term “grind smooth” when referring to the finish on continuous welds. This specification is usually used for stainless steel, but occasionally it will appear in carbon steel specifications as well.

“Grind smooth” is a general term and subject to various interpretations. This Table establishes recommended classes of finishes, which should be used to help find the class required for an application.

Operation	Weld Finishes				
	I	II	III	IV	V
Weld spatter and slag removed	X	X	X	X	X
Rough grind welds to remove heavy weld ripple or unusual roughness (Equivalent to a 40-50 grit finish)		X			
Medium grind welds — leaving some pits and crevices (Equivalent to a 80-100 grit finish)			X		
Fine grind welds — no pits or crevices permissible (Equivalent to a 140-150 grit finish)				X	X
Polish to a bright uniform finish					X

Layout



Trough

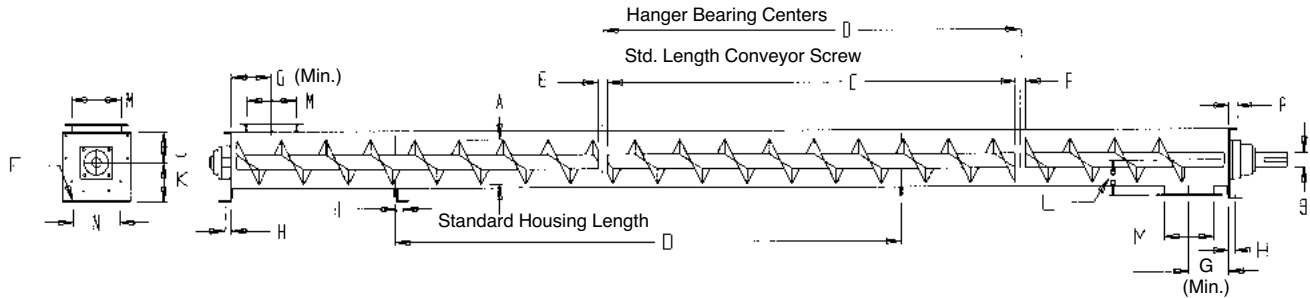

A Screw Diameter	B Coupling Diameter	C Length	D Length	E	F	G (Min.)	H	J	K	L	M	N	P	R
4	1	9-10½	10	1½	¾	4½	⅞	3⅝	4⅝	3¼	5	5¼	1⅞	1
6	1½	9-10	10	2	¾	6	1⅞	4½	5⅝	5	7	8⅝	1½	1
9	1½ 2	9-10	10	2	½	8	1⅞	6⅝	7⅞	7⅞	10	9⅞	1⅞	1½
10	1½ 2	9-10	10	2	½	9	1⅞	6⅝	8⅞	7⅞	11	9½	1¾	1¾
12	2 2⅞ 3	11-10 11-9 11-9	12	2 3 3	⅝	10½	1⅞	7⅞	9⅞	8⅞	13	12¼	2	1⅞
14	2⅞ 3	11-9	12	3	⅝	11½	1⅞	9⅞	10⅞	10⅞	15	13½	2	1⅞
16	3	11-9	12	3	⅝	13½	1⅞	10⅞	12	11⅞	17	14⅞	2½	2
18	3 3⅞	11-9 11-8	12	3 4	⅝	14½	1⅞	12⅞	13⅞	12⅞	19	16	2½	2
20	3 3⅞	11-9 11-8	12	3 4	¾	15½	2	13⅞	15	13⅞	21	19¼	2½	2¼
24	3⅞	11-8	12	4	¾	17½	2¼	16⅞	18⅞	15⅞	25	20	2½	2¼

Screw clearance at trough end is one half of dimension E

Typical Method of Detailing

9" x 2" x 25'-0" Conveyor

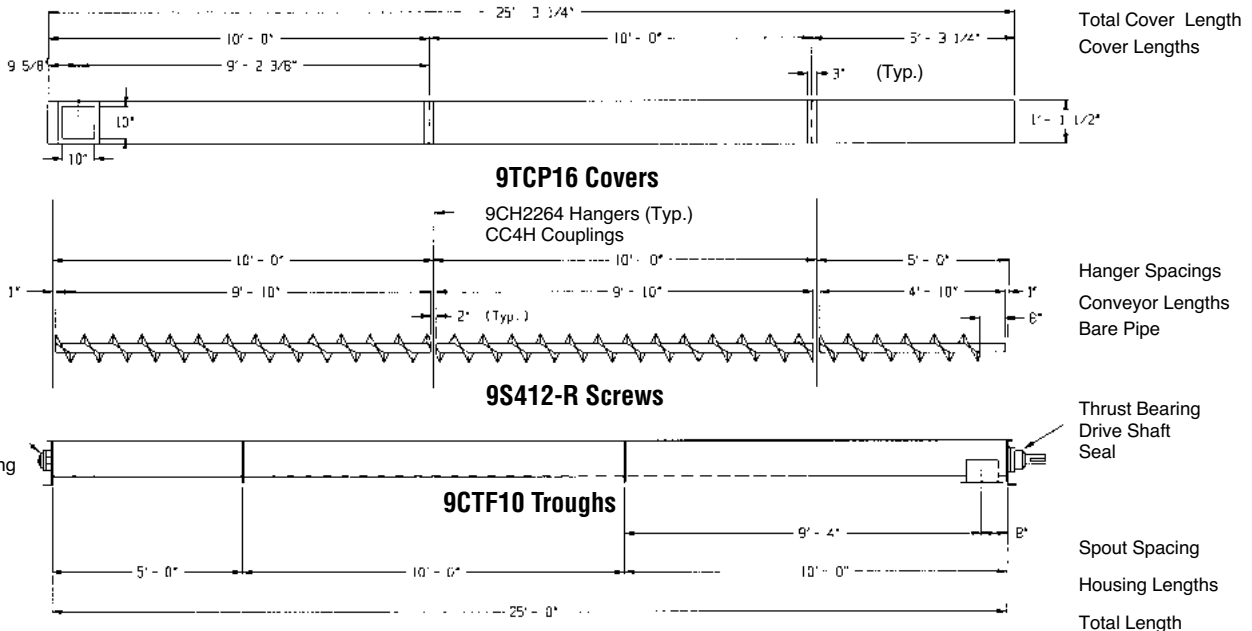

CONVEYORS

Tubular Housing

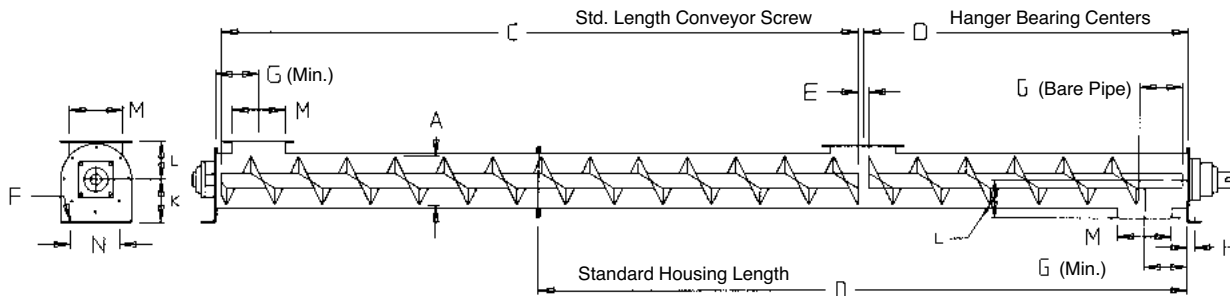

A Screw Dia.	B Coupling Dia.	C Length	D Length	E	F	G (Min.)	H	J	K	L	M	N	P	R
4	1	9-10½	10	1½	¾	4½	⅞	3⅝	4⅝	3¼	5	5¼	1⅞	1
6	1½	9-10	10	2	¾	6	1⅜	4½	5⅝	5	7	8⅝	1½	1
9	1½ 2	9-10	10	2	½	8	1⅞	6⅝	7⅞	7⅞	10	9⅞	1⅞	1½
10	1½ 2	9-10	10	2	½	9	1⅞	6⅝	8⅞	7⅞	11	9½	1¾	1¾
12	2 2⅞ 3	11-10 11-9 11-9	12	2 3 3	⅝	10½	1⅞	7⅞	9⅞	8⅞	13	12¼	2	1⅞
14	2⅞ 3	11-9	12	3	⅝	11½	1⅞	9⅞	10⅞	10⅞	15	13½	2	1⅞
16	3	11-9	12	3	⅝	13½	1⅞	10⅞	12	11⅞	17	14⅞	2½	2
18	3 3⅞	11-9 11-8	12	3 4	⅝	14½	1⅞	12⅞	13⅞	12⅞	19	16	2½	2
20	3 3⅞	11-9 11-8	12	3 4	¾	15½	2	13⅞	15	13⅞	21	19⅞	2½	2¼
24	3⅞	11-8	12	4	¾	17½	2¼	16⅞	18⅞	15⅞	25	20	2½	2¼

Screw clearance at trough end is one half of dimension E

Typical Method of Detailing

9" x 2" x 15'-0" Conveyor

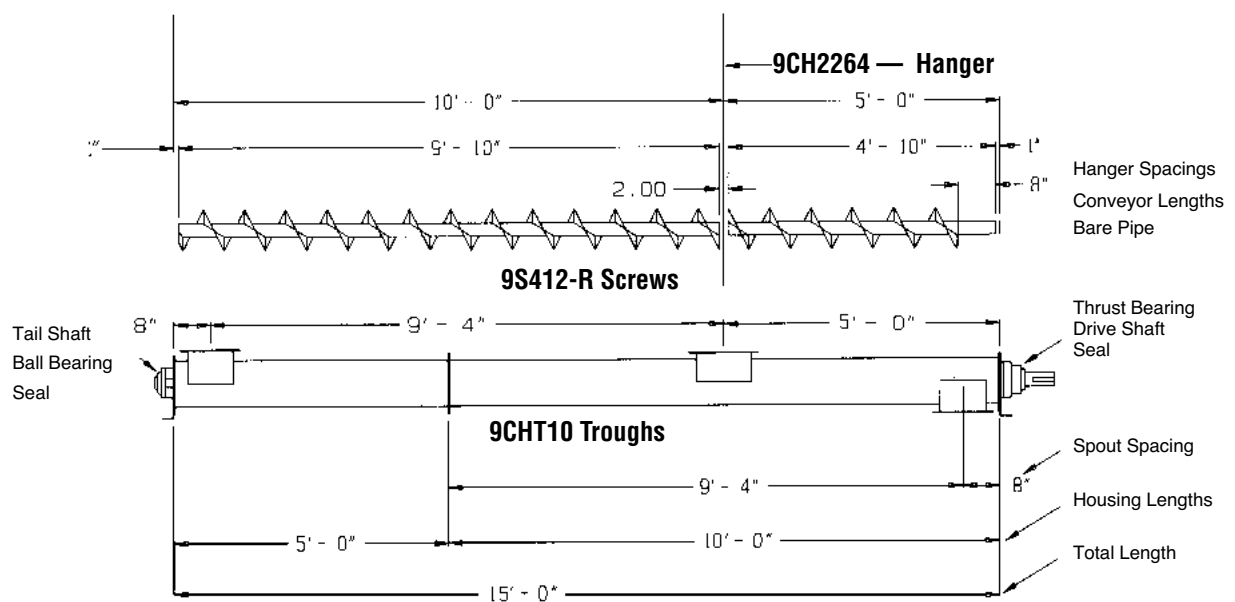

CONVEYORS

Bolt Patterns



U-Trough End Flanges

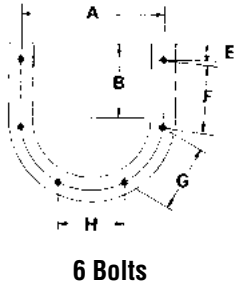

6 Bolts

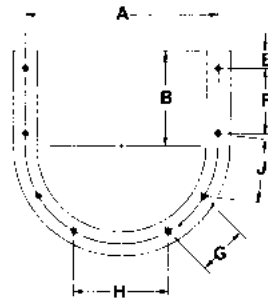

8 Bolts

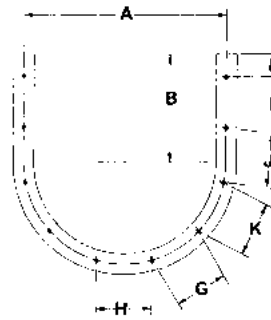

10 Bolts

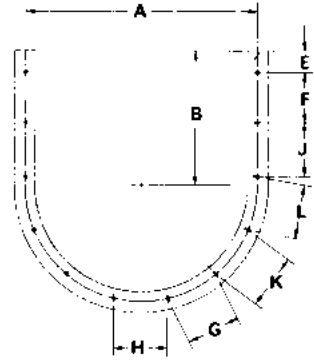

12 Bolts

Screw Diameter	Bolts		A	B	E	F	G	H	J	K	L
	Number	Diameter									
4	6	$\frac{3}{8}$	7	$3\frac{3}{8}$	$1\frac{1}{8}$	$3\frac{3}{8}$	$3\frac{3}{8}$	$3\frac{3}{8}$	X	X	X
6	6	$\frac{3}{8}$	$8\frac{7}{8}$	$4\frac{1}{2}$	$1\frac{1}{32}$	$4\frac{1}{8}$	$4\frac{1}{16}$	$4\frac{1}{16}$	X	X	X
9	8	$\frac{3}{8}$	$12\frac{1}{2}$	$6\frac{1}{8}$	$1\frac{1}{16}$	$4\frac{1}{8}$	$3\frac{3}{4}$	$5\frac{1}{8}$	$4\frac{1}{8}$	X	X
10	8	$\frac{3}{8}$	$13\frac{1}{4}$	$6\frac{3}{8}$	$2\frac{1}{4}$	$3\frac{1}{2}$	$4\frac{3}{16}$	$5\frac{1}{16}$	$4\frac{1}{8}$	X	X
12	8	$\frac{1}{2}$	$15\frac{5}{8}$	$7\frac{3}{4}$	$1\frac{1}{2}$	$5\frac{5}{16}$	$4\frac{1}{16}$	$7\frac{3}{4}$	$5\frac{5}{16}$	X	X
14	8	$\frac{1}{2}$	$17\frac{7}{8}$	$9\frac{1}{4}$	$2\frac{1}{32}$	$5\frac{1}{8}$	$5\frac{1}{16}$	6	$5\frac{1}{16}$	X	X
16	8	$\frac{5}{8}$	20	$10\frac{5}{8}$	$2\frac{1}{8}$	$6\frac{1}{8}$	$6\frac{1}{8}$	$7\frac{1}{2}$	$6\frac{1}{8}$	X	X
18	10	$\frac{5}{8}$	22	12 $\frac{1}{2}$	$2\frac{29}{32}$	$5\frac{1}{16}$	$5\frac{1}{8}$	$5\frac{1}{8}$	$5\frac{1}{8}$	$5\frac{1}{8}$	X
20	10	$\frac{5}{8}$	$24\frac{3}{8}$	$13\frac{1}{2}$	$2\frac{25}{32}$	$6\frac{1}{4}$	$6\frac{1}{16}$	$6\frac{1}{16}$	$6\frac{1}{16}$	$6\frac{1}{16}$	X
24	12	$\frac{5}{8}$	$28\frac{1}{2}$	$16\frac{1}{2}$	$2\frac{25}{32}$	$6\frac{1}{8}$	$6\frac{1}{8}$	$6\frac{1}{8}$	$6\frac{1}{8}$	$6\frac{1}{8}$	$6\frac{1}{8}$

Flared Trough End Flanges

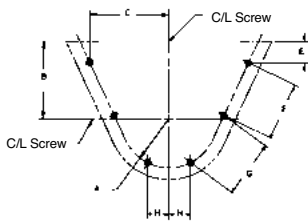

6 Bolts

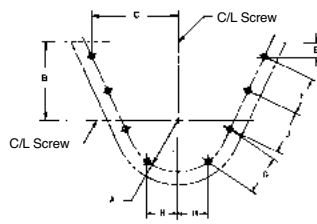

8 Bolts

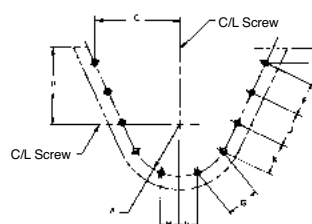

10 Bolts

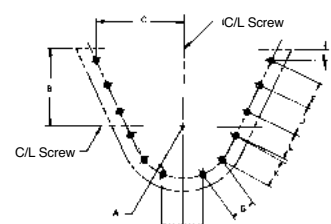

12 Bolts

Screw Diameter Inches	Bolts		A	B	C	E	F	G	H	J	K	L
	Diameter Number	Holes										
6	$\frac{3}{8}$	6	$4\frac{1}{16}$	7	$7\frac{7}{16}$	$1\frac{27}{32}$	$5\frac{1}{4}$	$5\frac{1}{4}$	$2\frac{1}{32}$	—	—	—
9	$\frac{3}{8}$	8	$6\frac{1}{4}$	9	$9\frac{21}{32}$	$1\frac{1}{64}$	5	5	$2\frac{1}{16}$	5	—	—
12	$\frac{1}{2}$	8	$7\frac{15}{16}$	10	$11\frac{13}{16}$	$1\frac{1}{16}$	$5\frac{1}{4}$	$5\frac{1}{4}$	$3\frac{3}{8}$	$5\frac{1}{4}$	—	—
14	$\frac{1}{2}$	10	$8\frac{15}{16}$	11	$12\frac{49}{64}$	$2\frac{1}{16}$	$5\frac{1}{8}$	$5\frac{1}{8}$	3	$5\frac{1}{8}$	$5\frac{1}{8}$	—
16	$\frac{5}{8}$	10	10	$11\frac{1}{2}$	$14\frac{11}{16}$	$2\frac{1}{64}$	$5\frac{1}{2}$	$5\frac{1}{2}$	$3\frac{3}{4}$	$5\frac{1}{2}$	$5\frac{1}{2}$	—
18	$\frac{5}{8}$	10	11	$12\frac{1}{2}$	16	$2\frac{1}{8}$	$6\frac{1}{16}$	$6\frac{1}{16}$	$2\frac{1}{16}$	$6\frac{1}{16}$	$6\frac{1}{16}$	—
20	$\frac{5}{8}$	10	$12\frac{3}{16}$	$13\frac{1}{2}$	$17\frac{1}{8}$	$2\frac{3}{32}$	7	7	$3\frac{1}{32}$	7	7	—
24	$\frac{5}{8}$	12	$14\frac{1}{4}$	$16\frac{1}{2}$	$20\frac{61}{64}$	$2\frac{1}{16}$	$6\frac{1}{8}$	$6\frac{1}{8}$	$3\frac{1}{16}$	$6\frac{1}{8}$	$6\frac{1}{8}$	$6\frac{1}{8}$

Tubular Housing Flanges

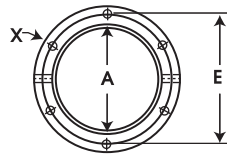

6 bolts

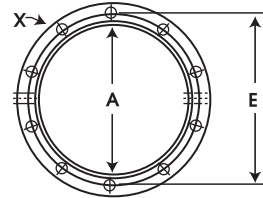

10 bolts

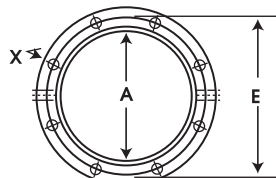

8 bolts

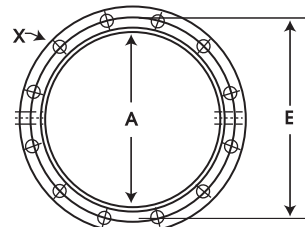

12 bolts

Intake & Discharge Flanges

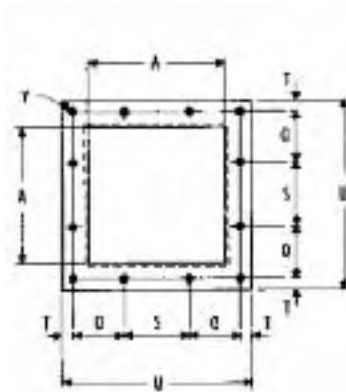

12 bolts

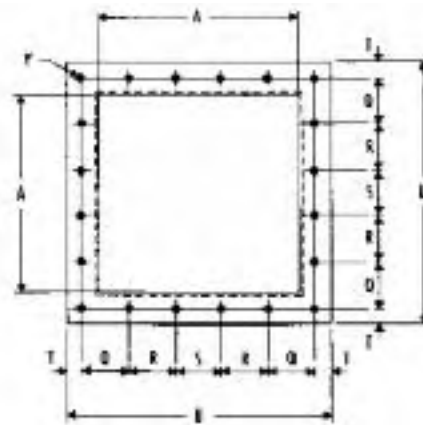

20 bolts

Screw Size	Flange Bolts		A	E	Q	R	S	T	U
	Tubular X	Discharge Y							
4	6-- ³ / ₈	12-- ¹ / ₄	5	7	2 ¹ / ₄	—	2 ¹ / ₄	³ / ₈	7 ¹ / ₂
6	8-- ³ / ₈	12-- ³ / ₈	7	8 ³ / ₈	2 ¹⁵ / ₁₆	—	3	¹ / ₁₆	10
9	8-- ³ / ₈	12-- ³ / ₈	10	11 ⁷ / ₈	4	—	4	¹ / ₂	13
10	8-- ³ / ₈	12-- ³ / ₈	11	13 ¹ / ₄	4 ⁵ / ₁₆	—	4 ³ / ₈	⁵ / ₈	14 ¹ / ₄
12	8-- ¹ / ₂	12-- ³ / ₈	13	15	5 ⁵ / ₈	—	5 ¹ / ₄	⁷ / ₈	17 ¹ / ₄
14	8-- ¹ / ₂	20-- ³ / ₈	15	17	3 ¹ / ₂	3 ¹ / ₂	3 ¹ / ₂	⁷ / ₈	19 ¹ / ₄
16	8-- ⁵ / ₈	20-- ³ / ₈	17	19 ¹ / ₂	3 ³ / ₄	4	4	⁷ / ₈	21 ¹ / ₄
18	10-- ⁵ / ₈	20-- ¹ / ₂	19	22	4 ⁷ / ₁₆	4 ³ / ₈	4 ³ / ₈	1 ¹ / ₈	24 ¹ / ₄
20	10-- ⁵ / ₈	20-- ¹ / ₂	21	24 ³ / ₄	4 ⁷ / ₈	4 ³ / ₄	4 ³ / ₄	1 ¹ / ₈	26 ¹ / ₄
24	12-- ⁵ / ₈	20-- ¹ / ₂	25	28 ¹ / ₂	5 ⁷ / ₈	5 ⁷ / ₈	5 ¹ / ₂	1 ¹ / ₈	30 ¹ / ₄

Bolt Requirements



Bolt Requirements Related to Conveyor Trough Sizes												
Part Name	Notes	4	6	9	10	12	14	16	18	20	24	
Flange, Trough		6-3/8 x 1	6-3/8 x 1	8-3/8 x 1	8-3/8 x 1	8-1/2 x 1 1/4	8-1/2 x 1 1/4	8-5/8 x 1 1/4	10-5/8 x 1 1/4	10-5/8 x 1 1/4	12-5/8 x 1 1/4	
Flange, Tubular Housing		6-3/8 x 1	8-3/8 x 1	8-3/8 x 1	8-3/8 x 1	8-1/2 x 1 1/4	8-1/2 x 1 1/4	8-5/8 x 1 1/4	10-5/8 x 1 1/4	10-5/8 x 1 1/4	12-5/8 x 1 1/4	
Ends, Trough												
Inside		6-1/4 x 3/4	6-3/16 x 3/4	8-3/8 x 1	8-3/8 x 1	8-1/2 x 1	8-1/2 x 1 1/4	8-5/8 x 1 1/4	10-5/8 x 1 1/4	10-5/8 x 1 1/4	12-5/8 x 1 1/4	
Inside Discharge		2-1/4 x 3/4	2-3/16 x 3/4	4-3/8 x 1	4-3/8 x 1	4-1/2 x 1	4-1/2 x 1 1/4	4-5/8 x 1 1/4	4-5/8 x 1 1/4	4-5/8 x 1 1/4	6-5/8 x 1 1/4	
Inside Rectangular		5-1/4 x 3/4	6-3/16 x 3/4	8-3/8 x 1	8-3/8 x 1	10-1/2 x 1	11-1/2 x 1 1/4	12-5/8 x 1 1/4	12-5/8 x 1 1/4	12-5/8 x 1 1/4	12-5/8 x 1 1/4	
Outside Type		6-3/8 x 1	6-3/8 x 1	8-3/8 x 1	8-3/8 x 1	8-1/2 x 1 1/4	8-1/2 x 1 1/4	8-5/8 x 1 1/4	10-5/8 x 1 1/4	10-5/8 x 1 1/4	12-5/8 x 1 1/4	
Outside Discharge		2-3/8 x 1	2-3/8 x 1	4-3/8 x 1	4-3/8 x 1	4-1/2 x 1 1/4	4-1/2 x 1 1/4	4-5/8 x 1 1/4	4-5/8 x 1 1/4	4-5/8 x 1 1/4	6-5/8 x 1 1/4	
Ends, Tubular Housing		6-3/8 x 1	8-3/8 x 1	8-3/8 x 1	8-3/8 x 1	8-1/2 x 1 1/4	8-1/2 x 1 1/4	8-5/8 x 1 1/4	10-5/8 x 1 1/4	10-5/8 x 1 1/4	12-5/8 x 1 1/4	
Hanger, Trough												
Style 60			2-1/8 x 2	2-1/8 x 2	2-1/8 x 2	2-1/2 x 2 1/2	2-1/2 x 2 1/2	2-5/8 x 2 1/2	2-5/8 x 2 1/2	2-5/8 x 2 1/2	2-5/8 x 2 1/2	
Style 70			4-3/8 x 1	4-3/8 x 1 1/4	4-3/8 x 1 1/4	4-1/2 x 1 1/4	4-1/2 x 1 1/4	4-1/2 x 1 1/4	4-1/2 x 1 1/4	4-5/8 x 2	4-5/8 x 2	
Style 216			4-3/8 x 1 1/4	4-3/8 x 1 1/4	4-3/8 x 1 1/4	4-1/2 x 1 1/4	4-1/2 x 1 1/4	4-5/8 x 1 1/4	4-5/8 x 1 1/4	4-5/8 x 2	4-5/8 x 2 1/2	
Style 220		4-1/4 x 1	4-3/8 x 1	4-3/8 x 1	4-3/8 x 1	4-1/2 x 1 1/4	4-1/2 x 1 1/4	4-1/2 x 1 1/4	4-5/8 x 1 1/4	4-5/8 x 1 1/4	4-5/8 x 1 1/4	
Style 226		4-1/4 x 1	4-3/8 x 1 1/4	4-3/8 x 1 1/4	4-3/8 x 1 1/4	4-1/2 x 1 1/4	4-1/2 x 1 1/4	4-1/2 x 1 1/4	4-5/8 x 1 1/4	4-5/8 x 2	4-5/8 x 2 1/2	
Style 230		4-1/4 x 1	4-3/8 x 1	4-3/8 x 1	4-3/8 x 1	4-1/2 x 1 1/4	4-1/2 x 1 1/4	4-1/2 x 1 1/4	4-5/8 x 1 1/4	4-5/8 x 1 1/4	4-5/8 x 1 1/4	
Style 316		4-1/4 x 1	4-3/8 x 1	4-3/8 x 1	4-3/8 x 1	4-1/2 x 1 1/4	4-1/2 x 1 1/4	4-1/2 x 1 1/4	4-5/8 x 1 1/4	4-5/8 x 1 1/4	4-5/8 x 1 1/4	
Style 326		4-1/4 x 1	4-3/8 x 1	4-3/8 x 1	4-3/8 x 1	4-1/2 x 1 1/4	4-1/2 x 1 1/4	4-1/2 x 1 1/4	5-5/8 x 1 1/4	4-5/8 x 1 1/4	4-5/8 x 1 1/4	
Covers, Trough (Std. 10 ft.)		10-3/16 x 3/4	10-3/16 x 3/4	10-3/16 x 3/4	10-3/16 x 3/4	10-3/16 x 3/4	10-3/16 x 3/4	10-3/16 x 3/4	10-3/16 x 3/4	10-3/16 x 3/4	10-3/16 x 3/4	
Saddle — Feet												
Flanged Feet		2-3/8 x 1 1/4	2-3/8 x 1 1/4	2-3/8 x 1 1/4	2-3/8 x 1 1/4	2-1/2 x 1 1/2	2-1/2 x 1 1/2	2-5/8 x 1 1/4	2-5/8 x 1 1/4	2-5/8 x 1 1/4	2-5/8 x 1 1/4	
Saddle		2-1/4 x 1	2-1/4 x 1	2-3/8 x 1	2-3/8 x 1	2-1/2 x 1 1/4	2-1/2 x 1 1/4	2-1/2 x 1 1/4	2-5/8 x 1 1/4	2-5/8 x 1 1/4	2-5/8 x 1 1/4	
Spouts, Discharge												
Attaching Bolts		8-3/8 x 1 1/2	8-3/8 x 1 1/2	8-3/8 x 1 1/2	8-3/8 x 1 1/2	8-3/8 x 1 1/2	12-3/8 x 1 1/2	12-3/8 x 1 1/2	12-1/2 x 1 1/2	12-1/2 x 1 1/2	12-1/2 x 1 1/2	
Flange		12-3/8 x 1	12-3/8 x 1	12-3/8 x 1	12-3/8 x 1	12-3/8 x 1	20-3/8 x 1	20-3/8 x 1	20-1/2 x 1	20-1/2 x 1	20-1/2 x 1	
Flange w/Slide		10-3/8 x 1	10-3/8 x 1	10-3/8 x 1	10-3/8 x 1	10-3/8 x 1	16-3/8 x 1	16-3/8 x 1	16-1/2 x 1 1/4	16-1/2 x 1 1/4	16-1/2 x 1 1/4	

All bolts hex head cap screws with hex nuts and lock washers.

Part Name	Bolt Requirements Related to Shaft Coupling Sizes				
	1	1½	2	2½	3
Bearings, End					
Discharge Bronze	3-3/8 x 1¼	3-½ x 1½	3-5/8 x 1¾ 3-5/8 x 1¾	3-3/4 x 2	3-3/4 x 2¼
Discharge Ball	3-3/8 x 1¼	3-½ x 1½	3-5/8 x 1½ 3-5/8 x 1¾	3-3/4 x 2	3-3/4 x 2¼
Flanged Bronze	4-3/8 x 1¼	4-½ x 1½	4-7/8 x 1¾ 4-7/8 x 1¾	4-3/4 x 2	4-3/4 x 2¼
Flanged Ball	4-3/8 x 1¼	4-½ x 1½	4-5/8 x 1½ 4-5/8 x 1¾	4-3/4 x 2	4-3/4 x 2¼
Flanged Roller		4-½ x 2	4-½ x 2¼ 4-5/8 x 2½	4-3/4 x 2¼	4-3/4 x 3¼
Pillow Block Bronze	2-3/8 x 1½	2-½ x 1¾	2-5/8 x 2 2-5/8 x 2¼	2-3/4 x 2½	2-7/8 x 2¼
Pillow Block Ball	2-3/8 x 1¾	2-½ x 2¼	2-5/8 x 2½ 2-5/8 x 2¾	2-7/8 x 3½	2-7/8 x 3¾
Pillow Block, Roller		2-½ x 2¼	2-5/8 x 2½ 2-5/8 x 2¾	2-3/4 x 3	2-7/8 x 3½
Bearings, Thrust					
Type "E" Roller		4-½ x 2¾	4-½ x 2¾ 4-5/8 x 3¼	4-3/4 x 3½	4-3/4 x 3¾
Coupling Bolts	3/8 x 2½	½ x 3	5/8 x 3 5/8 x 4¾		3/4 x 5-3/8" Pipe 7/8 x 5½" 3/4 x 5½-4" Pipe
Seals, Shafts					
Flanged Gland		4-½ x 1½	4-5/8 x 1½ 4-5/8 x 1½	4-3/4 x 1¾	4-3/4 x 1¾
Plate w/Ball or Bronze		4-½ x 2	4-5/8 x 2¼ 4-5/8 x 2¼	4-3/4 x 2¾	4-3/4 x 3
Plate w/Roller		4-½ x 2½	4-½ x 2¾ 4-5/8 x 3	4-3/4 x 3¼	4-3/4 x 3½
Split Gland		2-½ x 1½	2-½ x 1½ 2-5/8 x 1¾	2-5/8 x 1¾	2-5/8 x 2¼
Waste Pack, w/Ball or Bronze		4-½ x 3¼	4-5/8 x 3½ 4-5/8 x 3¾	4-3/4 x 4	4-3/4 x 4¾
Waste Pack, w/Roller		4-½ x 3¾	4-½ x 4 4-5/8 x 4	4-3/4 x 4¼	4-3/4 x 4½

*See page H-87 for special coupling bolts.
All other bolts hex head cap screws with hex nuts and lock washers.

Pipe Sizes, Dimensions and Weights

Nominal Pipe Size Inches	Outside Diameter Inches	I.P.S. Schedule	Wall Inches	Inside Diameter Inches	Wt./Ft. Pounds	Nominal Pipe Size Inches	Outside Diameter Inches	I.P.S. Schedule	Wall Inches	Inside Diameter Inches	Wt./Ft. Pounds
⅝	.405	10S	.049	.307	.1863	3	3.500	5S	.083	3.334	3.029
		40 40S Est.	.068	.269	.2447			10S	.120	3.260	4.332
		80 80S Ex. Hvy.	.095	.215	.3145			40 40S Est.	.216	3.068	7.576
¾	.540	10S	.065	.410	.3297	3½	4.000	80 80S Ex. Hvy.	.300	2.900	10.25
		40 40S Est.	.088	.364	.4248			160	.438	2.624	14.32
		80 80S Ex. Hvy.	.119	.302	.5351			XX Hvy.	.600	2.300	18.58
⅞	.675	10S	.065	.545	.4235	4	4.500	5S	.083	3.834	3.472
		40 40S Std.	.091	.493	.5676			10S	.120	3.760	4.973
		80 80S Ex. Hvy.	.126	.423	.7388			40 40S Std.	.226	3.548	9.109
1	.840	5S	.065	.710	.5383	5	5.563	80 80S Ex. Hvy.	.318	3.364	12.50
		40 40S Est.	.109	.622	.8510			5S	.109	5.345	6.349
		80 80S Ex. Hvy.	.147	.546	1.088			10S	.134	5.295	7.770
1¼	1.050	160	.187	.466	1.304	6	6.625	40 40S Est.	.237	4.026	10.79
		XX Hvy.	.294	.252	1.714			80 80S Ex. Hvy.	.337	3.826	14.98
		5S	.065	.920	.6838			120	.438	3.624	19.00
1½	1.315	10S	.083	.884	.8572	8	8.625	160	.531	3.438	22.51
		40 40S Std.	.113	.824	1.131			XX Hvy.	.674	3.152	27.54
		80 80S Ex. Hvy.	.154	.742	1.474			5S	.109	6.407	7.585
2	1.660	160	.218	.614	1.937	10	10.750	40 40S Std.	.280	6.065	18.97
		XX Hvy.	.308	.434	2.441			80 80S Ex. Hvy.	.375	4.813	20.78
		5S	.065	1.185	.8678			120	.500	4.563	27.04
2½	1.900	10S	.109	1.097	1.404	10	10.750	160	.625	4.313	32.96
		40 40S Std.	.133	1.049	1.679			XX Hvy.	.750	4.063	38.55
		80 80S Ex. Hvy.	.179	.957	2.172			5S	.148	8.407	9.914
3	2.375	160	.250	.815	2.844	10	10.750	10S	.134	6.357	9.289
		XX Hvy.	.358	.599	3.659			40 40S Std.	.280	6.065	18.97
		5S	.065	1.530	1.107			80 80S Ex. Hvy.	.432	5.761	28.57
3½	2.875	10S	.109	1.442	1.806	10	10.750	120	.562	5.491	36.39
		40 40S Std.	.140	1.380	2.273			160	.718	5.189	45.30
		80 80S Ex. Hvy.	.191	1.278	2.997			XX Hvy.	.864	4.897	53.16
4	3.315	160	.250	1.160	3.765	10	10.750	5S	.109	8.407	9.914
		XX Hvy.	.382	.896	5.214			10S	.148	8.329	13.40
		5S	.065	1.770	1.274			20	.250	8.125	22.36
4½	3.815	10S	.109	1.682	2.085	10	10.750	30	.277	8.071	24.70
		40 40S Std.	.145	1.610	2.718			40 40S Est.	.322	7.981	28.55
		80 80S Ex. Hvy.	.200	1.500	3.631			60	.406	7.813	35.64
5	4.315	160	.281	1.338	4.859	10	10.750	80 80S Ex. Hvy.	.500	7.625	43.39
		XX Hvy.	.400	1.100	6.408			100	.593	7.439	50.87
		5S	.065	2.245	1.604			120	.718	7.189	60.63
5½	4.815	10S	.109	2.157	2.638	10	10.750	140	.812	7.001	67.76
		40 40S Std.	.154	2.067	3.653			160	.906	6.813	74.69
		80 80S Ex. Hvy.	.218	1.939	5.022			5S	.134	10.482	15.19
6	5.315	160	.343	1.689	7.444	10	10.750	10S	.165	10.420	18.70
		XX Hvy.	.436	1.503	9.029			20	.250	10.250	28.04
		5S	.065	2.709	2.475			30	.307	10.136	34.24
6½	5.815	10S	.120	2.635	3.531	10	10.750	40 40S Std.	.365	10.020	40.48
		40 40S Std.	.203	2.469	5.793			60 80S Ex. Hvy.	.500	9.750	54.74
		80 80S Ex. Hvy.	.276	2.323	7.661			80	.593	9.564	64.33
7	6.315	160	.375	2.125	10.01	10	10.750	100	.718	9.224	76.93
		XX Hvy.	.552	1.771	13.69			120	.843	9.064	89.20
		5S	.083	2.709	2.475			140	1.000	8.750	104.1
7½	6.815	10S	.120	2.635	3.531	10	10.750	160	1.125	8.500	115.7
		40 40S Std.	.203	2.469	5.793						
		80 80S Ex. Hvy.	.276	2.323	7.661						

NOTE:
Weights shown are in pounds per foot, based on the average wall of the pipe. The following formula was used in calculating the weight per foot.

W = 10.68 (D - t)t
W = Weight in pounds per foot (to 4 digits)
D = Outside Diameter in inches (to 3 decimal places)
t = Wall thickness in decimals (to 3 decimal places)

All weights are carried to four digits only, the fifth digit being carried forward if five or over, or dropped if under five.

The most common types of drives for Screw Conveyors are illustrated below.

In addition to those shown, other types available are: variable speed drives, hydraulic drives, and take-off drives for connection to other equipment.

For special drive requirements, consult our Engineering Department.

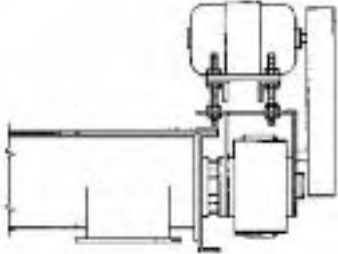
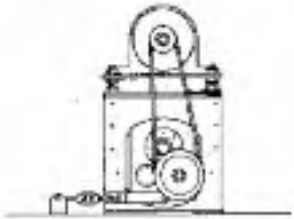
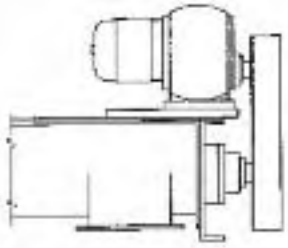
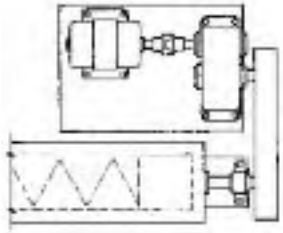
<p>Screw Driver Reducer</p>	 <p>(Side View)</p>	<p>Reducer mounts on trough end, and is directly connected to the conveyor screw and includes integral thrust bearing, seal gland, and drive shaft. Motor mount may be positioned at top, either side, or below. Separate drive shaft, end bearing, and seal are not required.</p>
<p>Shaft Mounted Reducer</p>	 <p>(End View)</p>	<p>Reducer mounts on conveyor drive shaft. Motor and "V"-Belt drive may be in any convenient location. The torque arm may be fastened to the floor, or fitted to trough end. Requires extended drive shaft, end bearing, and seal.</p> <p>Note: Requires thrust unit or collars to hold thrust.</p>
<p>Gearmotor Drive</p>	 <p>(Side View)</p>	<p>Integral motor-reducer with chain drive to conveyor drive shaft. Usually mounted to top of trough by means of an adapter plate.</p>
<p>Base Type Reducer Drive</p>	 <p>(Top View)</p>	<p>Motor direct-coupled to base type reducer, with chain drive to conveyor drive shaft. Usually mounted on floor or platform as close as possible to conveyor.</p>

Helicoid Screw Conveyors

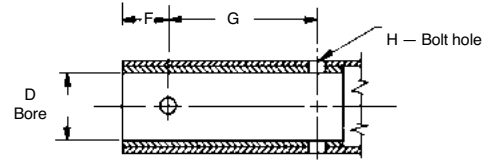
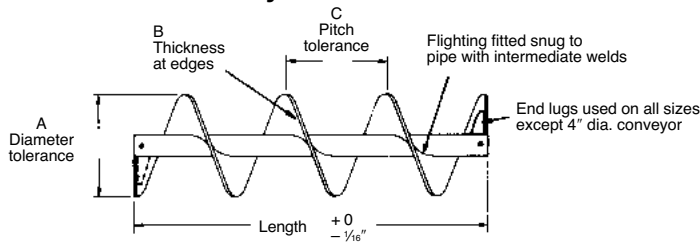

Listed Screw Diameter and Pitch	Coupling Diameter	Size Designation	Pipe Size Schedule 40	Length Feet and Inches	A		B		C		D		F	G	H
					Diameter Tolerance		Thickness		Pitch Tolerance		Bushing Bore Inside Diameter		Spacing 1st Bolt Hole	Centers 2nd Bolt Hole	Nominal Bolt Hole Size
					Plus	Minus	Inner Edge	Outer Edge	Plus	Minus	Minimum	Maximum			
4	1	4H206	1 1/4	9-10 1/2	1/16	1/8	3/16	3/32	1/2	1/4	1.005	1.016	1/2	2	13/32
6	1 1/2	6H304	2	9-10	1/16	3/16	1/8	1/16	1/2	1/4	1.505	1.516	7/8	3	17/32
6	1 1/2	6H308	2	9-10	1/16	3/16	1/4	1/8	3/4	1/4	1.505	1.516	7/8	3	17/32
6	1 1/2	6H312	2	9-10	1/16	3/16	3/8	3/16	3/4	1/4	1.505	1.516	7/8	3	17/32
9	1 1/2	9H306	2	9-10	1/16	3/16	3/16	3/32	3/4	1/4	1.505	1.516	7/8	3	17/32
9	1 1/2	9H312	2	9-10	1/16	3/16	3/8	3/16	3/4	1/4	1.505	1.516	7/8	3	17/32
9	2	9H406	2 1/2	9-10	1/16	3/16	3/16	3/32	3/4	1/4	2.005	2.016	7/8	3	21/32
9	2	9H412	2 1/2	9-10	1/16	1/4	3/8	3/16	3/4	1/4	2.005	2.016	7/8	3	21/32
9	2	9H414	2 1/2	9-10	1/16	1/4	7/16	7/32	3/4	1/4	2.005	2.016	7/8	3	21/32
10	1 1/2	10H306	2	9-10	1/16	3/16	3/16	3/32	3/4	1/4	1.505	1.516	7/8	3	17/32
10	2	10H412	2 1/2	9-10	1/16	1/4	3/8	3/16	3/4	1/4	2.005	2.016	7/8	3	21/32
12	2	12H408	2 1/2	11-10	1/8	5/16	1/4	1/8	1	1/4	2.005	2.016	7/8	3	21/32
12	2	12H412	2 1/2	11-10	1/8	5/16	3/8	3/16	1	1/4	2.005	2.016	7/8	3	21/32
12	2 1/8	12H508	3	11-9	1/8	5/16	1/4	1/8	1	1/4	2.443	2.458	15/16	3	21/32
12	2 1/8	12H512	3	11-9	1/8	5/16	3/8	3/16	1	1/4	2.443	2.458	15/16	3	21/32
12	3	12H614	3 1/2	11-9	1/8	3/8	7/16	7/32	1	1/4	3.005	3.025	1	3	25/32
14	2 1/8	14H508	3	11-9	1/8	5/16	1/4	1/8	1	1/4	2.443	2.458	15/16	3	21/32
14	3	14H614	3 1/2	11-9	1/8	3/8	7/16	7/32	1	1/4	3.005	3.025	1	3	25/32
16	3	16H610	3 1/2	11-9	1/8	3/8	5/16	3/32	1 1/2	1/4	3.005	3.025	1	3	25/32
16	3	16H614	4	11-9	1/8	3/8	7/16	7/32	1 1/2	1/4	3.005	3.025	1	3	25/32

NOTE: All dimensions in inches.

Cut Flight/Cut & Folded Flight Conveyors

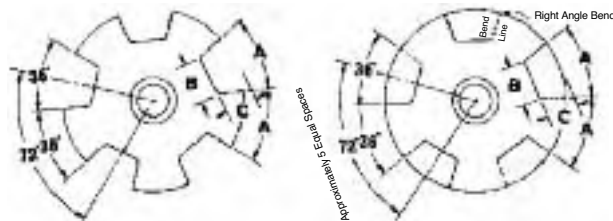

Depth of cut "C" is one half the flight width for normal maximum pipe size. Lengths "A" and "B" are calculated from the developed O.D. for standard pitch.

Screw Diameter	A	B	C
4	1 3/8	1	5/8
6	2	1 1/2	7/8
9	3	2 1/2	1 1/2
10	3 3/8	2 1/4	1 3/4
12	4	2 3/4	2
14	4 5/8	3 1/8	2 1/2
16	5 1/4	3 1/2	3
18	6	3 3/8	3 3/8
20	6 5/8	4 1/4	3 3/8
24	7 5/8	4 7/8	4 7/8

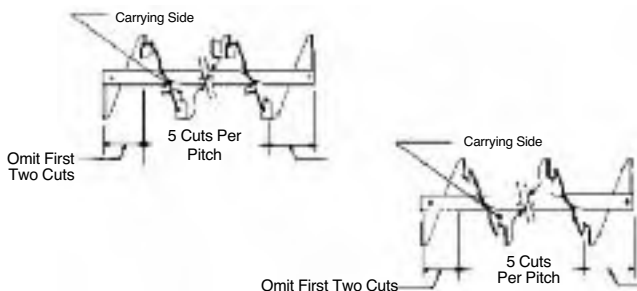

Sectional Screw Conveyors

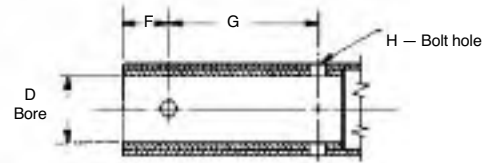
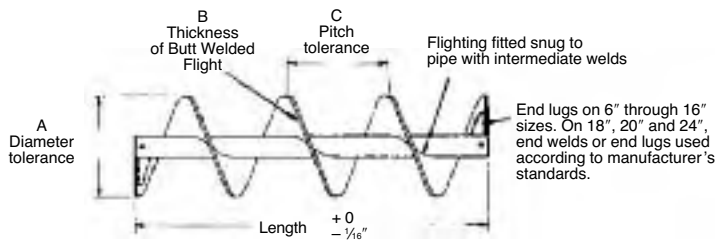

Listed Screw Diameter and Pitch	Cplng. Dia.	Size Designation	Pipe Size Schedule 40	Length Feet and Inches	A		B	C		D		F	G	H
					Diameter Tolerance			Pitch Tolerance	Bushing Bore Inside Diameter					
					Plus	Minus	Plus		Minus	Minimum	Maximum	Spacing 1st Bolt Hole	Centers 2nd Bolt Hole	Nominal Bolt Hole Size
6	1½	6S312	2	9-10	⅛	⅜	⅜	⅜	¼	1.505	1.516	⅞	3	17/32
	1½	9S312	2	9-10	⅛	⅜	⅜	½	¼	1.505	1.516	⅞	3	17/32
9	2	9S412	2½	9-10	⅛	⅜	⅜	½	¼	2.005	2.016	⅞	3	21/32
	2	9S416	2½	9-10	⅛	¼	¼	½	¼	2.005	2.016	⅞	3	21/32
10	2	10S412	2½	9-10	⅛	⅜	⅜	½	¼	2.005	2.016	⅞	3	21/32
12	2	12S412	2½	11-10	⅛	⅜	⅜	¾	¼	2.005	2.016	⅞	3	21/32
	2½	12S512	3	11-9	⅛	⅜	⅜	¾	¼	2.443	2.458	15/16	3	21/32
	2½	12S516	3	11-9	⅛	⅜	¼	¾	¼	2.443	2.458	15/16	3	21/32
	3	12S616	3½	11-9	⅛	⅜	¼	¾	¼	3.005	3.025	1	3	25/32
14	3	14S616	3½	11-9	⅛	⅜	¾	¾	¼	3.005	3.025	1	3	25/32
	3	14S624	3½	11-9	⅛	⅜	¾	¾	¼	3.005	3.025	1	3	25/32
	3	14S612	3½	11-9	⅛	⅜	¾	¾	¼	3.005	3.025	1	3	25/32
16	3	16S616	3½	11-9	⅛	⅜	¾	¾	¼	3.005	3.025	1	3	25/32
	3	16S624	3½	11-9	⅛	⅜	¾	¾	¼	3.005	3.025	1	3	25/32
	3	16S632	3½	11-9	⅛	½	½	¾	¼	3.005	3.025	1	3	25/32
	3	18S612	3½	11-9	⅜	⅜	¾	¾	½	3.005	3.025	1	3	25/32
18	3	18S616	3½	11-9	⅜	⅜	¾	¾	½	3.005	3.025	1	3	25/32
	3	18S624	3½	11-9	⅜	⅜	¾	¾	½	3.005	3.025	1	3	25/32
	3	18S632	3½	11-9	⅜	½	½	¾	½	3.005	3.025	1	3	25/32
	3	20S612	3½	11-9	⅜	⅜	¾	¾	½	3.005	3.025	1	3	25/32
20	3	20S616	3½	11-9	⅜	⅜	¾	¾	½	3.005	3.025	1	3	25/32
	3	20S624	3½	11-9	⅜	⅜	¾	¾	½	3.005	3.025	1	3	25/32
	3	24S712	4	11-8	⅜	⅜	¾	¾	½	3.443	3.467	1½	4	29/32
24	3	24S716	4	11-8	⅜	⅜	¾	¾	½	3.443	3.467	1½	4	29/32
	3	24S724	4	11-8	⅜	⅜	¾	¾	½	3.443	3.467	1½	4	29/32
	3	24S732	4	11-8	⅜	½	½	¾	½	3.443	3.467	1½	4	29/32
	3	24S712	4	11-8	⅜	⅜	¾	¾	½	3.443	3.467	1½	4	29/32

NOTE: All dimensions in inches.

Sample Work Sheet



Client: _____ Date Quote Due: _____
 Conveyor No.: _____ Inquiry No.: _____

Table 1-2
 _____ Dia. x Length **L** = _____ Recommended % Trough Loading: _____
 Material: _____ Material HP Factor: **FM** = _____
 Capacity: _____ Component Series: _____
 Density: **W** = _____ Lbs/Ft³ Intermediate Hanger Bearing Series: _____
 Lumps: Max. Size _____ in. Class (I) (II) (III) _____ Notes: _____

Required Capacity = **C** = _____ CFH (cubic feet per hour)
 $CFH = \frac{TPH \times 2000}{W}$ CFH = Bushels per Hour x 1.24
 $CFH = \frac{\text{Pounds per Hour}}{W}$

Tables 1-3, 1-4, 1-5
 Equivalent Capacity = $\frac{\text{Req'd Capacity}}{CF_1} \times CF_2 \times CF_3 =$ _____ CFH Equivalent Capacity

Table 1-6
 Screw Diameter = _____ Select Diameter from 'at max RPM' column where capacity listed equals or exceeds equivalent capacity
 $Screw\ RPM = N = \frac{\text{Equivalent Capacity}}{\text{Capacity 'at one RPM' for diameter selected}}$

Table 1-7
 Check lump size and lump class for diameter selected. If larger screw diameter recommended, recalculate RPM per instructions above for selected diameter.

Tables 1-12, 1-13, 1-14, 1-15, 1-16, 1-17
 Values to be substituted in formula: **Fd Fb Ff Fp e**
 $HPf = \frac{L}{1,000,000} \left(\frac{N}{1,000,000} \right) \left(\frac{Fd}{1,000,000} \right) \left(\frac{Fb}{1,000,000} \right) =$ _____
 $HPm = \frac{C}{1,000,000} \left(\frac{L}{1,000,000} \right) \left(\frac{W}{1,000,000} \right) \left(\frac{Ff}{1,000,000} \right) \left(\frac{Fm}{1,000,000} \right) \left(\frac{Fp}{1,000,000} \right) =$ _____
 If HPf + HPm is less than 5.2, select overload factor $F_O =$ _____ (If HPf + HPm is greater than 5.2, $F_O = 1.0$)
 Total HP = $\frac{(HPf + HPm) F_O}{e} =$ _____

DRIVE: Use _____ HP motor with AGMA Class (I) (II) (III) Drive at _____ Screw RPM

Tables 1-18, 1-19
 Torque = $\frac{\text{Motor HP} \times 63,025}{\text{Screw RPM}} =$ _____ in.-lbs.
 List Minimum Size: Shaft Dia. _____ Pipe _____ Bolt/Shear _____ Bolt/Bearing _____

Tables 1-8, 1-9, 1-10, 1-11
 Select Components:
 Trough _____ Screw _____ Hanger Style _____ Hanger Bearing _____ Cover _____

CONVEYORS



SECTION III

COMPONENT SECTION III	PAGE
Component Selection	H-52
Trough	H-54
Discharges and Gates	H-58
Trough Ends	H-64
Saddles and Feet/Trough End Flanges	H-71
End Bearings	H-72
Thrust Bearings	H-74
Seals	H-76
Conveyor Screws	H-79
Coupling Bolts, Internal Collars and Lugs	H-87
Shafts	H-88
Hangers	H-93
Hanger Bearings	H-101
Covers	H-103
Cover Accessories	H-105
Conveyor Shrouds	H-106

CONVEYORS

**SEE PRICE LIST FOR ITEMS CARRIED
IN STOCK**

Required Information

- Screw diameter
- Shaft diameter
- Material component group
- Unusual material characteristics

Conveyor Screws

Standard length conveyor screws should be used whenever possible to reduce the number of hanger bearings required.

The recommended screws listed in the Component Series Table are standard helicoid and sectional screw conveyors. The use of helicoid or sectional conveyors is largely a matter of individual preference.

Right hand screw conveyors pull material toward the end which is being rotated in a clockwise direction. If the rotation is reversed (counterclockwise), the material is pushed away from that end.

In left hand screw conveyors, the material flow is opposite to that of right hand screws, the direction of rotation being unchanged.

To determine hand of screw see pages H-38 and H-39.

The material is carried on one face of the conveyor flighting in conveyors which are required to transport material in one direction, therefore, conveyor end lugs are located on the opposite face to facilitate unimpeded flow of the material. Conveyor sections must be installed in such a manner that all end lugs are toward the inlet end of the conveyor. Conveyor sections must not be turned end for end without reversing the direction of rotation, or conversely, the direction of rotation must not be reversed without turning the conveyor sections end for end.

Requirements for reversible conveyor screws intended for material transport in either direction should be referred to our Engineering Department.

Flighting should be omitted from the conveyor pipe over the last discharge opening to ensure complete discharge of material without carryover.

Continuity of material flow at hanger points is accomplished by opposing adjacent flight ends approximately 180°. (As close to 180° as the predrilled holes will allow.)

Conveyor Trough and Tubular Housing

Standard trough and housing sections are available in five, six, ten, and 12 foot lengths. Standard five and six foot lengths should be used when connecting flanges coincide with discharge openings or hanger bearings.

Shafts

The primary consideration in determining the type and size of coupling and drive shafts is whether the shafts selected are adequate to transmit the horsepower required, including any overload. Normally, cold-rolled shafts are adequate. However, high-tensile shafts may be required due to torque limitations. Also, stainless steel shafts may be necessary when corrosive or contaminable materials are to be handled. Conveyors equipped with non-lubricated hard iron hanger bearings require hardened coupling shafts. Specific shaft size determination is covered in the Torsional Rating Section, page H-27.

Shaft Seals

Several conveyor end seal types are available to prevent contamination of the conveyed material or to prevent the escape of material from the system.

Bearings

Hanger Bearing — The purpose of hanger bearings is to provide intermediate support when multiple screw sections are used. Hanger bearings are designed primarily for radial loads. Therefore, adequate clearance should be allowed between the bearings and the conveyor pipe ends to prevent damage by the thrust load which is transmitted through the conveyor pipe.

The hanger bearing recommendations listed in the Material Characteristic Tables are generally adequate for the material to be handled. Often, however, unusual characteristics of the material or the conditions under which the conveyor must operate make it desirable to use special bearing materials. Regarding the use of special bearing materials, consult our Engineering Department.

End Bearings — Several end bearing types are available, and their selection depends on two basic factors: Radial load and thrust load. The relative values of these loads determines end bearing types.

Radial load is negligible at the conveyor tail shaft. However, drive ends (unless integrated with the conveyor end plate) are subject to radial loading due to overhung drive loads, such as chain sprockets or shaft-mounted speed reducers. Screw Conveyor Drive Reducers at the drive end will adequately carry both thrust and radial loads.

Discharge Spouts and Gates

Standard discharge spouts and gates are available for either conveyor trough or tubular housing in several designs, operated either manually or by remote controls.

In installations where it is possible to overfill the device to which material is being transported, an additional overflow discharge opening or overflow relief device should be provided. Consult our Engineering Department for suggested electrical interlock and safety devices to prevent overflow or damage to equipment.

It is sometimes found that the material characteristics are such that standard component specifications are inadequate. Should unusual material characteristics or severe conditions exist, our Engineering Department should be consulted.

Conveyor Ends

A complete line of conveyor ends are available as standard for either conveyor trough or tubular housing with a choice of many bearing types and combinations.

Special Applications

More common of the unusual material characteristics which require other than the recommended components are:

Corrosive Materials — Components may be fabricated from alloys not affected by the material or may be coated with a protective substance.

Contaminable Materials — Require the use of oil impregnated, sealed, or dry type hanger bearings. End shafts should be sealed to prevent entrance of contaminants from the outside. Due to the necessity for frequent cleaning conveyor components should be designed for convenient disassembly.

Abrasive Materials — These materials may be handled in conveyors, troughs, or housings constructed of abrasion resistant alloys with hard surfaced screws. Lining of all exposed surfaces with rubber or special resins also materially reduces abrasive damage.

Interlocking or Matting Materials — Conveying with standard components is sometimes possible by the use of special feeding devices at the conveyor inlet.

Hygroscopic Materials — Frequently these materials may be handled successfully in a conveyor which is substantially sealed from the exterior atmosphere. In extreme cases it is necessary to provide jacketed trough or housing with an appropriate circulating medium to maintain the material at an elevated temperature. Purging of the conveyor with a suitable dry gas is also used in some installations.

Viscous or Sticky Materials — Ribbon flight conveyor screws are most frequently used for conveying these materials although standard components may be specially coated to improve the flow of material.

Harmful Vapors or Dusts — These materials may be safely handled in dust sealed trough, plain tubular housing, or gasketed flanged tubular housing with particular attention to shaft sealing. Trough or housing exhaust systems have also been successfully used in some installations.

Blending in Transit — Ribbon, cut flight, paddle, or a combination of these screw types may be designed to produce the desired degree of blending, aeration or mixing.

Explosive Dusts — The danger of this condition may be minimized in most installations by the use of components which are fabricated from non-ferrous materials and proper conveyor sealing techniques observed. Exhaust systems are also advisable for the removal of explosive dusts.

Materials Subject to Packing — This condition requires the use of aerating devices at the conveyor inlet when materials are pulverulent and a special feeder device when material particles are large or fibrous.

Materials which are Fluid when Aerated — This condition may be used to advantage in some installations by declining the conveyor system toward the discharge end.

Degradable Materials — Some particles that are easily broken or distorted may usually be handled in screw conveyors by reducing the speed and selecting a larger conveyor size sufficient to deliver the required volume of material.

Elevated Temperature — Components should be fabricated from high temperature alloys. Should the process be such that cooling of the material in the conveyor is permissible, jacketed trough or housing may be used at the inlet end to cool the material and standard components used after the point where material temperature has been reduced to a safe degree.

Conveyor Trough

FORMED FLANGE U-TROUGH		Commonly used economical trough. One piece construction. Standard lengths in stock.
ANGLE FLANGE U-TROUGH		Rigid construction. Standard lengths in stock.
FORMED FLANGE TUBULAR TROUGH		Loadable to full cross section for feeder applications. Minimizes fall back in inclined applications. Easily taken apart for maintenance. Can be gasketed for dust tight enclosure. Hanger pockets required for use with standard hangers.
SOLID TUBULAR TROUGH		One piece construction for totally enclosed or inclined applications. Hanger pockets required for use with standard hangers.
FLARED TROUGH		Used where materials tend to bridge or when flared inlets are needed.
CHANNEL TROUGH		Adds structural support for longer than standard spans.
DROP BOTTOM TROUGH		Used when complete material clean-out is critical. Can be furnished with hinges either side and bolts or clamps opposite side.
FORMED FLANGE RECTANGULAR TROUGH		Material being conveyed forms its own trough thereby reducing trough wear. One piece construction.
ANGLE FLANGE RECTANGULAR TROUGH		The same as formed flange rectangular except top flanges are made from structural angle.
JACKETED TROUGH		Jacket allows heating or cooling of material being conveyed.

Standard conveyor troughs have a U-shaped steel body with angle iron top flanges or formed top flanges and jig drilled end flanges.

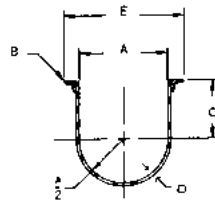
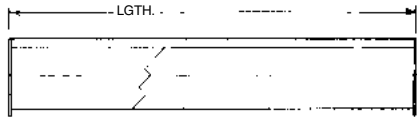

Angle Flange

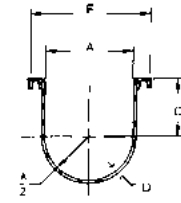

Formed Flange

Conveyor Diameter	D	Angle Flanged	Angle Flanged Trough				Formed Flanged Trough ▲				A	B	C	E	F	
			Weight		Weight		Part Number	Weight		Weight						
			10' Length	5' Length	12' Length	6' Length		10' Length	5' Length	12' Length						6' Length
4	□ 16 GA.	4CTA16	53	29	—	—	4CTF16	41	23	—	—	5	1¼	3⅞	7⅞	7¼
4	14	4CTA14	60	33	—	—	4CTF14	50	28	—	—				7⅞	7¼
4	12	4CTA12	78	42	—	—	4CTF12	70	38	—	—				7⅞	7¼
6	□ 16 GA.	6CTA16	67	44	—	—	6CTF16	55	32	—	—	7	1¼	4½	9⅞	9⅞
6	14	6CTA14	78	49	—	—	6CTF14	67	38	—	—				9⅞	9⅞
6	12	6CTA12	101	60	—	—	6CTF12	91	50	—	—				9¾	9¾
6	10	6CTA10	123	73	—	—	6CTF10	117	64	—	—				9¾	9¾
6	⅜	6CTA7	164	86	—	—	6CTF7	150	79	—	—				9¾	9¾
9	□ 16 GA.	9CTA16	113	66	—	—	9CTF16	83	51	—	—	10	1½	6⅞	13⅞	13¼
9	14	9CTA14	127	73	—	—	9CTF14	99	59	—	—				13⅞	13¼
9	12	9CTA12	156	87	—	—	9CTF12	132	75	—	—				13¾	13¾
9	10	9CTA10	176	102	—	—	9CTF10	164	91	—	—				13⅞	13¾
9	⅜	9CTA7	230	124	—	—	9CTF7	214	116	—	—				13⅞	13¾
9	¼	9CTA3	286	152	—	—	9CTF3	276	147	—	—				13½	13½
10	□ 16 GA.	10CTA16	118	69	—	—	10CTF16	88	54	—	—	11	1½	6⅞	14⅞	14¼
10	14	10CTA14	133	76	—	—	10CTF14	105	62	—	—				14⅞	14¼
10	12	10CTA12	164	92	—	—	10CTF12	140	80	—	—				14¼	14¼
10	10	10CTA10	178	102	—	—	10CTF10	167	91	—	—				14⅞	14¼
10	⅜	10CTA7	233	131	—	—	10CTF7	217	123	—	—				14⅞	14¼
10	¼	10CTA3	306	163	—	—	10CTF3	296	158	—	—				14½	14½
12	□ 12 GA.	12CTA12	197	113	236	135	12CTF12	164	95	197	114	13	2	7¾	17¼	17½
12	10	12CTA10	234	133	281	160	12CTF10	187	117	224	140				17⅞	17⅞
12	⅜	12CTA7	294	164	353	197	12CTF7	272	150	326	180				17⅞	17⅞
12	¼	12CTA3	372	203	446	244	12CTF3	357	194	428	233				17½	17½
14	□ 12 GA.	14CTA12	214	121	257	145	14CTF12	183	102	219	122	15	2	9¼	19¼	19⅞
14	10	14CTA10	258	143	309	172	14CTF10	207	127	248	152				19⅞	19⅞
14	⅜	14CTA7	328	180	394	216	14CTF7	304	168	365	202				19⅞	19⅞
14	¼	14CTA3	418	224	501	269	14CTF3	403	215	483	258				19½	19½
16	□ 12 GA.	16CTA12	238	133	285	160	16CTF12	206	107	247	128	17	2	10⅞	21¼	21⅞
16	10	16CTA10	288	159	345	191	16CTF10	234	144	281	173				21⅞	21⅞
16	⅜	16CTA7	368	200	442	240	16CTF7	345	188	414	226				21⅞	21⅞
16	¼	16CTA3	471	243	565	291	16CTF3	455	228	546	273				21½	21½
18	□ 12 GA.	18CTA12	252	159	302	191	18CTF12	240	133	288	160	19	2½	12⅞	24¼	24½
18	10	18CTA10	353	170	423	204	18CTF10	269	165	323	198				24⅞	24⅞
18	⅜	18CTA7	444	243	533	291	18CTF7	394	217	473	260				24⅞	24⅞
18	¼	18CTA3	559	298	671	358	18CTF3	520	275	624	330				24½	24½
20	□ 10 GA.	20CTA10	383	228	460	274	20CTF10	296	190	355	228	21	2½	13½	26⅞	26½
20	⅜	20CTA7	484	271	581	325	20CTF7	434	247	521	296				26⅞	26½
20	¼	20CTA3	612	334	734	401	20CTF3	573	315	687	378				26½	26½
24	□ 10 GA.	24CTA10	443	255	531	306	24CTF10	384	227	461	272	25	2½	16½	30⅞	30½
24	⅜	24CTA7	563	319	676	383	24CTF7	514	293	617	352				30⅞	30½
24	¼	24CTA3	717	363	860	435	24CTF3	678	339	813	406				30½	30½

□ Standard Gauge Bolt Patterns Page H-42

All troughs available in other materials such as stainless, aluminum, abrasion resistant, etc.

▲ Double formed flange standard on all sizes through 10 ga.

Tubular Housing

Tubular conveyor housings are inherently dust and weather-tight, and may be loaded to a full cross section. Conveyors with tubular housings are rigid and are highly suitable for conveying material on an incline. Three types shown are available.

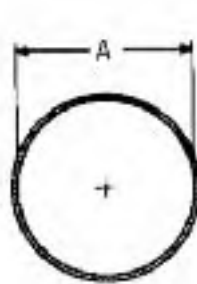

Tubular housing

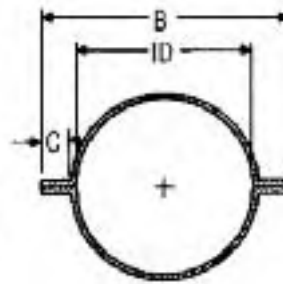

Flanged tubular housing

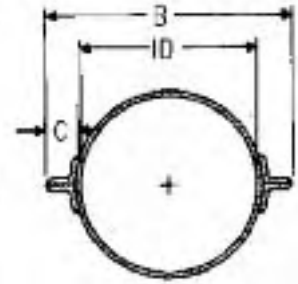

Angle flanged tubular housing

Conveyor Diameter	Trough Thickness	Tubular Housing			Formed Flange		Angle Flange		A	B	C
		Part Number	Weight		Part Number	Weight 10'	Part Number	Weight 10'			
			10' Length	5' Length							
4	□ 16 GA.	4CHT16			4CHT16-F	43	4CHT16-A	81	5	7 7/8	1
4	14	4CHT14	60	31	4CHT14-F	53	4CHT14-A	89			
4	12	4CHT12			4CHT12-F	74	4CHT12-A	106			
6	□ 16 GA.	6CHT16	50	27	6CHT16-F	60	6CHT16-A	110	7	9 9/16	1 1/4
6	14	6CHT14	62	33	6CHT14-F	75	6CHT14-A	122			
6	12	6CHT12	85	44	6CHT12-F	103	6CHT12-A	145			
6	10	6CHT10	109	56	6CHT10-F	133	6CHT10-A	187			
6	3/16	6CHT7	145	74	6CHT7-F	168	6CHT7-A	205			
6	1/4										
9	16 GA.	9CHT16	72	39	9CHT16-F	84	9CHT16-A	131	10	12 1/2	1 1/4
9	□ 14	9CHT14	89	47	9CHT14-F	104	9CHT14-A	148			
9	12	9CHT12	122	64	9CHT12-F	143	9CHT12-A	181			
9	10	9CHT10	155	80	9CHT10-F	182	9CHT10-A	214			
9	3/16	9CHT7	208	107	9CHT7-F	245	9CHT7-A	267			
9	1/4	9CHT3	275	140	9CHT3-F	324	9CHT3-A	334			
9											
10	16 GA.	10CHT16	79	42	10CHT16-F	91	10CHT16-A	138	11	13 3/8	1 1/4
10	□ 14	10CHT14	97	52	10CHT14-F	112	10CHT14-A	156			
10	12	10CHT12	133	70	10CHT12-F	154	10CHT12-A	192			
10	10	10CHT10	169	88	10CHT10-F	196	10CHT10-A	228			
10	3/16	10CHT7	227	117	10CHT7-F	264	10CHT7-A	286			
10	1/4	10CHT3	301	154	10CHT3-F	350	10CHT3-A	360			
10											
12	□ 12 GA.	12CHT12	163	88	12CHT12-F	193	12CHT12-A	235	13	16 1/4	1 1/2
12	10	12CHT10	208	111	12CHT10-F	247	12CHT10-A	280			
12	3/16	12CHT7	275	144	12CHT7-F	328	12CHT7-A	347			
12	1/4	12CHT3	362	188	12CHT3-F	432	12CHT3-A	434			
12											
14	□ 12 GA.	14CHT12	187	101	14CHT12-F	217	14CHT12-A	259	15	18 3/4	1 1/2
14	10	14CHT10	236	126	14CHT10-F	275	14CHT10-A	308			
14	3/16	14CHT7	316	166	14CHT7-F	369	14CHT7-A	388			
14	1/4	14CHT3	416	216	14CHT3-F	486	14CHT3-A	488			
14											
16	□ 12 GA.	16CHT12	212	114	16CHT12-F	242	16CHT12-A	310	17	21 1/4	2
16	10	16CHT10	268	142	16CHT10-F	307	16CHT10-A	366			
16	3/16	16CHT7	358	187	16CHT7-F	411	16CHT7-A	456			
16	1/4	16CHT3	472	244	16CHT3-F	542	16CHT3-A	570			
16											
18	□ 12 GA.	18CHT12	242	133	18CHT12-F	280	18CHT12-A	340	19	23 3/8	2
18	10	18CHT10	304	164	18CHT10-F	352	18CHT10-A	402			
18	3/16	18CHT7	405	214	18CHT7-F	471	18CHT7-A	503			
18	1/4	18CHT3	533	278	18CHT3-F	621	18CHT3-A	631			
18											
20	□ 10 GA.	20CHT10	335	188	20CHT10-F	381	20CHT10-A	433	21	25 5/8	2
20	3/16	20CHT7	446	237	20CHT7-F	510	20CHT7-A	544			
20	1/4	20CHT3	586	307	20CHT3-F	671	20CHT3-A	684			
24	□ 10 GA.	24CHT10	399	215	24CHT10-F	445	24CHT10-A	497	25	29 9/16	2
24	3/16	24CHT7	531	281	24CHT7-F	594	24CHT7-A	629			
24	1/4	24CHT3	699	365	24CHT3-F	784	24CHT3-A	797			

□ Standard Gauge
For Bolt Patterns See Page H-43

CONVEYORS

Flared troughs are used primarily to convey materials which are not free-flowing or which have a tendency to stick to the trough.

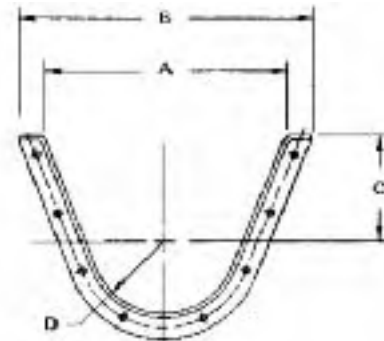

Conveyor Diameter	Trough Thickness	Part Number	Weight Per Foot	A	B	C	D	Standard Length Foot																																																																																																																																																															
6	□ 14 GA.	6FCT14	9	14	16 ⁵ / ₁₆	7	3 ¹ / ₂	10																																																																																																																																																															
6	12	6FCT12	12		16 ³ / ₁₆				9	□ 14 GA.	9FCT14	13	18	21 ³ / ₁₆	9	5	10	9	12 GA.	9FCT12	14	21 ¹ / ₄	9	10	9FCT10	19	21 ¹ / ₄	9	³ / ₁₆	9FCT7	22	21 ³ / ₁₆	9	¹ / ₄	9FCT3	25	21 ¹ / ₂	12	□ 12 GA.	12FCT12	20	22	26 ¹ / ₄	10	6 ¹ / ₂	12	12	10	12FCT10	24	26 ¹ / ₄	12	³ / ₁₆	12FCT7	32	26 ³ / ₁₆	12	¹ / ₄	12FCT3	43	26 ¹ / ₂	14	□ 12 GA.	14FCT12	23	24	28 ¹ / ₄	11	7 ¹ / ₂	12	14	10	14FCT10	27	28 ¹ / ₄	14	³ / ₁₆	14FCT7	37	28 ³ / ₁₆	14	¹ / ₄	14FCT3	49	28 ¹ / ₂	16	□ 12 GA.	16FCT12	25	28	32 ¹ / ₄	11 ¹ / ₂	8 ¹ / ₂	12	16	10	16FCT10	31	32 ¹ / ₄	16	³ / ₁₆	16FCT7	39	32 ³ / ₁₆	16	¹ / ₄	16FCT3	52	32 ¹ / ₂	18	□ 12 GA.	18FCT12	27	31	36 ¹ / ₄	12 ¹ / ₂	9 ¹ / ₂	12	18	10	18FCT10	35	36 ¹ / ₄	18	³ / ₁₆	18FCT7	45	36 ³ / ₁₆	18	¹ / ₄	18FCT3	56	36 ¹ / ₂	20	□ 10 GA.	20FCT10	36	34	39 ¹ / ₄	13 ¹ / ₂	10 ¹ / ₂	12	20	³ / ₁₆	20FCT7	48	39 ³ / ₁₆	20	¹ / ₄	20FCT3	60	39 ¹ / ₂	24	□ 10 GA.	24FCT10	41	40	45 ¹ / ₄	16 ¹ / ₂	12 ¹ / ₂	12	24	³ / ₁₆	24FCT7	54	45 ³ / ₁₆	24
9	□ 14 GA.	9FCT14	13	18	21 ³ / ₁₆	9	5	10																																																																																																																																																															
9	12 GA.	9FCT12	14		21 ¹ / ₄																																																																																																																																																																		
9	10	9FCT10	19		21 ¹ / ₄																																																																																																																																																																		
9	³ / ₁₆	9FCT7	22		21 ³ / ₁₆																																																																																																																																																																		
9	¹ / ₄	9FCT3	25		21 ¹ / ₂																																																																																																																																																																		
12	□ 12 GA.	12FCT12	20	22	26 ¹ / ₄	10	6 ¹ / ₂	12																																																																																																																																																															
12	10	12FCT10	24		26 ¹ / ₄																																																																																																																																																																		
12	³ / ₁₆	12FCT7	32		26 ³ / ₁₆																																																																																																																																																																		
12	¹ / ₄	12FCT3	43		26 ¹ / ₂																																																																																																																																																																		
14	□ 12 GA.	14FCT12	23	24	28 ¹ / ₄	11	7 ¹ / ₂	12																																																																																																																																																															
14	10	14FCT10	27		28 ¹ / ₄																																																																																																																																																																		
14	³ / ₁₆	14FCT7	37		28 ³ / ₁₆																																																																																																																																																																		
14	¹ / ₄	14FCT3	49		28 ¹ / ₂																																																																																																																																																																		
16	□ 12 GA.	16FCT12	25	28	32 ¹ / ₄	11 ¹ / ₂	8 ¹ / ₂	12																																																																																																																																																															
16	10	16FCT10	31		32 ¹ / ₄																																																																																																																																																																		
16	³ / ₁₆	16FCT7	39		32 ³ / ₁₆																																																																																																																																																																		
16	¹ / ₄	16FCT3	52		32 ¹ / ₂																																																																																																																																																																		
18	□ 12 GA.	18FCT12	27	31	36 ¹ / ₄	12 ¹ / ₂	9 ¹ / ₂	12																																																																																																																																																															
18	10	18FCT10	35		36 ¹ / ₄																																																																																																																																																																		
18	³ / ₁₆	18FCT7	45		36 ³ / ₁₆																																																																																																																																																																		
18	¹ / ₄	18FCT3	56		36 ¹ / ₂																																																																																																																																																																		
20	□ 10 GA.	20FCT10	36	34	39 ¹ / ₄	13 ¹ / ₂	10 ¹ / ₂	12																																																																																																																																																															
20	³ / ₁₆	20FCT7	48		39 ³ / ₁₆																																																																																																																																																																		
20	¹ / ₄	20FCT3	60		39 ¹ / ₂																																																																																																																																																																		
24	□ 10 GA.	24FCT10	41	40	45 ¹ / ₄	16 ¹ / ₂	12 ¹ / ₂	12																																																																																																																																																															
24	³ / ₁₆	24FCT7	54		45 ³ / ₁₆																																																																																																																																																																		
24	¹ / ₄	24FCT3	69		45 ¹ / ₂																																																																																																																																																																		

□ Standard Gauge

See Page H-42 for Bolt Pattern

Discharges and Gates



Índice de Boquillas de Descarga

14	TSD	12
----	-----	----

Diámetro del Transportador

TSD: Boquilla Sencilla, Fija
 TSDS: Boquilla Sencilla Fija con Compuerta Deslizable
 TSDF: Boquilla de Descarga a Nivel
 RPF: Compuerta Plana de Cremallera y Piñón

Tipos

RFPD: Compuerta Plana de Cremallera y Piñón Resistente al Polvo
 RPC: Compuerta Curva de Cremallera y Piñón
 RPF: Compuerta Curva de Cremallera y Piñón Resistente al Po

Grosor de
 14 - Cal. 1
 12 - Cal. 1
 10 - Cal. 1
 7 - 3/16

STANDARD DISCHARGE SPOUT		<p>Most commonly used. Flanged hole drilling is per CEMA Standards. Select spout thickness according to trough thickness.</p>
STANDARD DISCHARGE SPOUT WITH HAND SLIDE		<p>Standard spout shown above with the addition of the slide and side guides. Select spout thickness according to trough thickness.</p>
FLUSH END DISCHARGE SPOUT		<p>Reduces distance from centerline of discharge to end of the conveyor which eliminates ledge at end of trough and product build-up. Special flush-end trough ends required when this style of discharge is used.</p>
FLAT SLIDE GATE		<p>Rack & pinion type available with hand wheel, rope wheel, pocket wheel and chain. Discharge spout is included when fitted. Flat slide (less rack & pinion) can be furnished with pneumatic, hydraulic, or electric actuators. (Not dust-tight).</p>
CURVED SLIDE GATE		<p>Contoured shape of slide eliminates pocket found in flat slide type. Rack & pinion type available with handwheel, or rope wheel, or pocket wheel with chain. Curved slide (less rack & pinion) can be furnished with pneumatic, hydraulic, or electric actuators. (Standard curved slide gate is not dust-tight.) All curved slide gates should be <u>installed at factory</u>.</p>
DUST TIGHT RACK AND PINION FLAT SLIDE		<p>Dust tight rack and pinions are totally enclosed and can be furnished with either flat or curved slide. Handwheel is normally furnished but is also available with chain or rope wheel.</p>

Plain Opening



Plain spout openings are cut in the trough permitting free material discharge.

Fixed Spout with Slide Gate



Fixed spouts with slide gates are used where distribution of material is to be controlled. Bolted flange permits slide to be operated from any side.

Fixed Spout

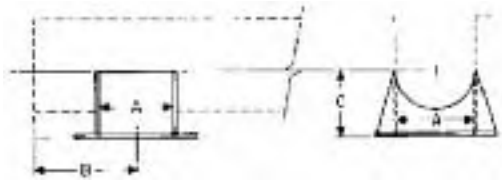

Fixed spouts are fabricated in proportion to size and thickness of trough. Can be furnished loose or welded to trough.

Flush End Spout

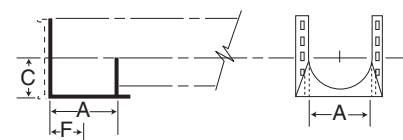

Flush end discharge spouts are designed for use at the final discharge point. The end of the spout is comprised of a housing end with bottom flange drilled with standard discharge flange bolt pattern. Because it is located at the extreme end of the conveyor, there is no carryover of material past the final discharge point. The flush end arrangement eliminates the unnecessary extension of trough and interior components beyond the actual discharge point.

Screw Diameter	A	B	C	D	G	H	F
4	5	4½	3¾	⅝	5⅝	11	2½
6	7	6	5	⅝	6⅝	14	3½
9	10	8	7⅞	⅝	8	19	5
10	11	9	7⅞	⅝	8⅝	20	5⅝
12	13	10½	8⅞	⅝	10⅝	24	6½
14	15	11½	10⅞	⅝	11¼	27	7½
16	17	13½	11⅞	⅝	12⅝	30	8½
18	19	14½	12⅞	⅝	13⅝	33	9½
20	21	15½	13⅞	⅝	14⅝	36	10½
24	25	17½	15⅞	⅝	16⅝	42	12½

Screw Diameter	Trough Thickness Gauge	Spout and Gate Thickness Gauge	Part Number			Weight		
			Fixed Spout		Flush End Spout	Fixed Spout		Flush End Spout
			Plain	With Slide		Plain	Slide	
4	16-14	□ 14	4TSD14	4TSDS14	4TSDF14	2	6	1.5
4	12	12	4TSD12	4TSDS12	4TSDF12	3	7	2.25
6	14-12	□ 14	6TSD14	6TSDS14	6TSDF14	4	11	3.0
6	⅝	12	6TSD12	6TSDS12	6TSDF12	6	13	4.50
9	16-14-12-10	□ 14	9TSD14	9TSDS14	9TSDF14	8	18	6.0
9	⅝-¼	10	9TSD10	9TSDS10	9TSDF10	13	22	9.75
10	14-12-10	□ 14	10TSD14	10TSDS14	10TSDF14	10	21	7.5
10	⅝-¼	10	10TSD10	10TSDS10	10TSDF10	16	27	12.0
12	12-10	□ 12	12TSD12	12TSDS12	12TSDF12	17	36	12.75
12	⅝-¼	⅝	12TSD7	12TSDS7	12TSDF7	29	48	21.75
14	12-10	□ 12	14TSD12	14TSDS12	14TSDF12	22	46	16.50
14	⅝-¼	⅝	14TSD7	14TSDS7	14TSDF7	38	62	28.50
16	12-10	□ 12	16TSD12	16TSDS12	16TSDF12	21	49	15.75
16	⅝-¼	⅝	16TSD7	16TSDS7	16TSDF7	40	68	30.0
18	12-10	□ 12	18TSD12	18TSDS12	18TSDF12	32	69	24.0
18	⅝-¼	⅝	18TSD7	18TSDS7	18TSDF7	60	97	45.0
20	10	□ 12	20TSD12	20TSDS12	20TSDF12	40	91	30.0
20	⅝-¼	⅝	20TSD7	20TSDS7	20TSDF7	67	118	50.25
24	10	□ 12	24TSD12	24TSDS12	24TSDF12	52	116	39.0
24	⅝-¼	⅝	24TSD7	24TSDS7	24TSDF7	87	151	65.25

□ Standard Gauge
For Bolt Patterns See Page H-43

① Add -F for Fitted

Discharge Gates



Flat rack and pinion slide gates can be bolted to standard discharge spouts at any of the four positions desired. Hand wheel is normally furnished but is also available with chain or rope wheel.

Rack and Pinion Flat Slide

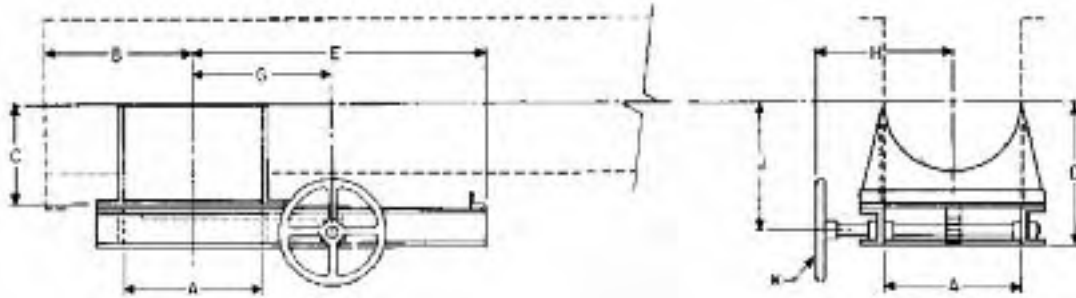

Screw Diameter	A	B	C	D	E	G	H	J	K Diameter
4	5	4½	3¾	7	13½	6½	5	5½	12
6	7	6	5	8¾	16	7½	6	6¾	12
9	10	8	7½	10½	20¼	9	9½	8½	12
10	11	9	7½	11½	23½	10½	10	9½	12
12	13	10½	8½	12½	25½	11	12¼	10½	12
14	15	11½	10½	13¾	31¼	12½	13¼	12	12
16	17	13½	11½	14¾	33¾	13½	14¼	13	12
18	19	14½	12½	15¾	37¾	14½	15¼	14½	12
20	21	15½	13¾	16½	40¾	15½	16¼	15½	12
24	25	17½	15¾	18½	46½	17½	18¼	17½	12

Screw Diameter	Trough Thickness Gauge	Spout and Gate Thickness Gauge	Part Number Rack and Pinion† ①	Weight Rack and Pinion
4	16-14	□ 14	4RPF14	18
4	12	12	4RPF12	21
6	16-14-12	□ 14	6RPF14	28
6	⅜	12	6RPF12	31
9	14-12-10	□ 14	9RPF14	49
9	⅜-¼	10	9RPF10	54
10	14-12-10	□ 14	10RPF14	56
10	⅜-¼	10	10RPF10	62
12	12-10	□ 12	12RPF12	94
12	⅜-¼	⅜	12RPF7	106
14	12-10	□ 12	14RPF12	107
14	⅜-¼	⅜	14RPF7	123
16	12-10	□ 12	16RPF12	112
16	⅜-¼	⅜	16RPF7	131
18*	12-10	□ 12	18RPF12	157
18*	⅜-¼	⅜	18RPF7	185
20*	10	□ 12	20RPF12	185
20*	⅜-¼	⅜	20RPF7	212
24*	10	□ 12	24RPF12	233
24*	⅜-¼	⅜	24RPF7	268

* Handwheel supplied as Standard Assembly
 — C Chain Wheel
 — R Rope Wheel

□ Standard Gauge
 For Bolt Patterns See Page H-43

① Add -F for Fitted

† All Rack & Pinion Gates 18" and Larger Have Double Rack & Pinion.

Rack and Pinion Curved Slide

Curved rack and pinion slide gates are contoured to the shape of the trough thus eliminating pocket caused by flat slide. Slide operates parallel to the trough only. Hand wheel is normally furnished but is also available with chain or rope wheel.

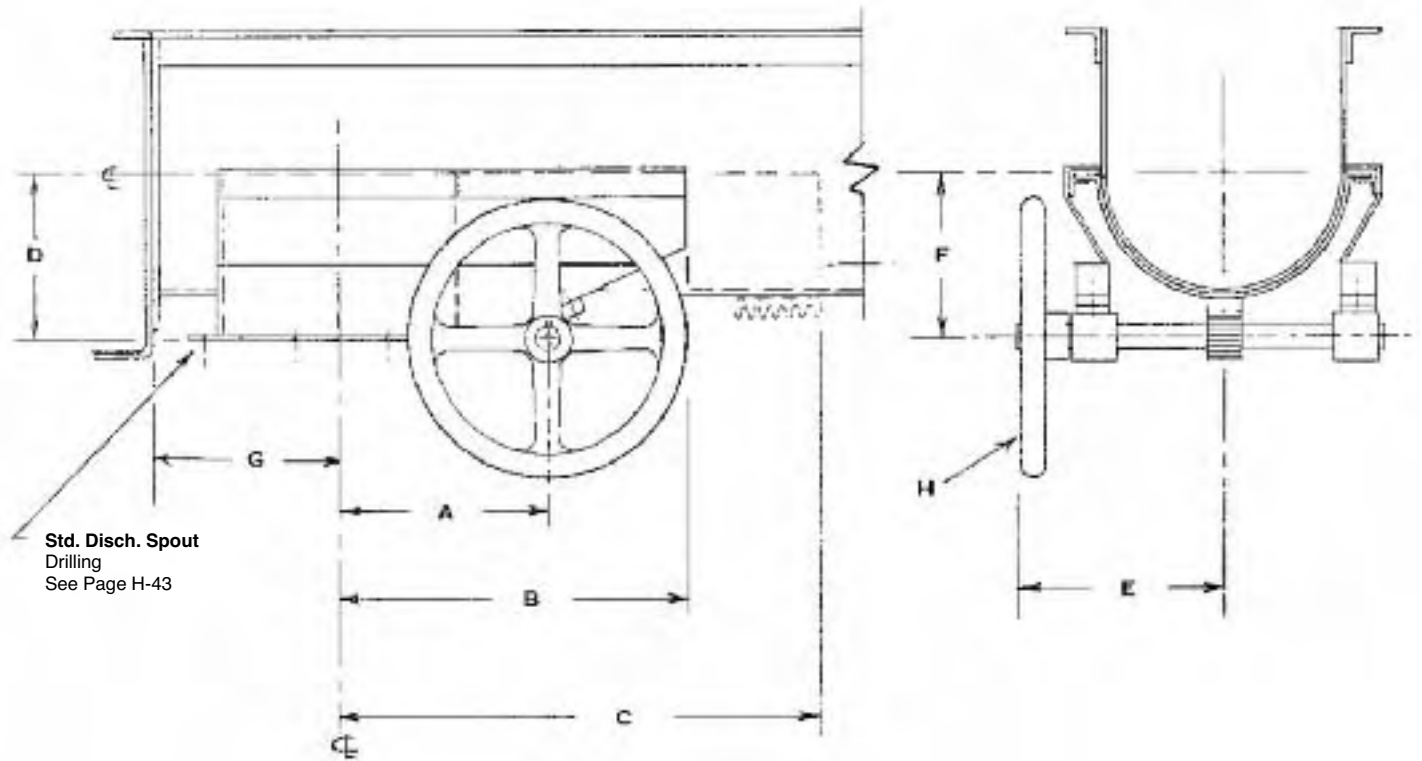

Conveyor Diameter	Trough Thickness	Spout Thickness	Part Number* ^①	Weight Pounds	A	B	C	D	E	F	G	H Diameter
4	14,16 Cal.	□ 14 Cal.	4RPC14	20	6¼	8¼	12	3¼	6	4½	4½	12
4	12 Cal.	12 GA.	4RPC12	22	6¼	8¼	12	3¼	6	4%		
6	16,14,12 GA.	□ 14 GA.	6RPC14	25	7½	10½	15	5	8	5½	6	12
6	¾"	12 GA.	6RPC12	28	7½	10½	15	5	8	5%		
9	14,12,10 GA.	□ 14 GA.	9RPC14	46	9	15	20½	7½	8¼	7	8	12
9	¾",¼"	10 GA.	9RPC10	54	9	15	20½	7½	8¼	7½		
10	14,12,10 GA.	□ 14 GA.	10RPC14	53	9½	14½	21	7½	9%	7½	9	12
10	¾",¼"	10 GA.	10RPC10	62	9½	14½	21	7½	9%	7%		
12	12,10 GA.	□ 12 GA.	12RPC12	81	11%	17½	25¼	8%	11	8½	10½	12
12	¾",¼"	¾"	12RPC7	97	11%	17½	25¼	8%	11	8%		
14	10,12 GA.	□ 12 GA.	14RPC12	95	12%	20½	30¼	10%	12	9½	11½	12
14	¾",¼"	¾"	14RPC7	114	12%	20½	30¼	10%	12	9%		
16	10,12 GA.	□ 12 GA.	16RPC12	103	14%	23½	36	11%	13	10½	13½	12
16	¾",¼"	¾"	16RPC7	116	14%	23½	36	11%	13	10%		
18	10,12 GA.	□ 12 GA.	18RPC12	157	15%	25½	37¼	12%	15%	11½	14½	12
18	¾",¼"	¾"	18RPC7	187	15%	25½	37¼	12%	15%	11%		
20	12 GA.	□ 12 GA.	20RPC12	175	17%	28½	39	13%	16%	12½	15½	12
20	¾",¼"	¾"	20RPC7	208	17%	28½	39	13%	16%	12%		
24	10 GA.	□ 12 GA.	24RPC12	220	19%	35½	47	15%	18%	14½	17½	12
24	¾",¼"	¾"	24RPC7	265	19%	35½	47	15%	18%	14%		

* Hand wheel supplied as Standard Assembly
 — C Chain Wheel
 — R Rope Wheel

□ Standard Gauge

① Add -F for Fitted

Discharge Gates



Dust Tight Rack and Pinion Flat Slide

Dust tight rack and pinions are totally enclosed and can be furnished with either flat or curved slide. Handwheel is normally furnished but is also available with chain or rope wheel.

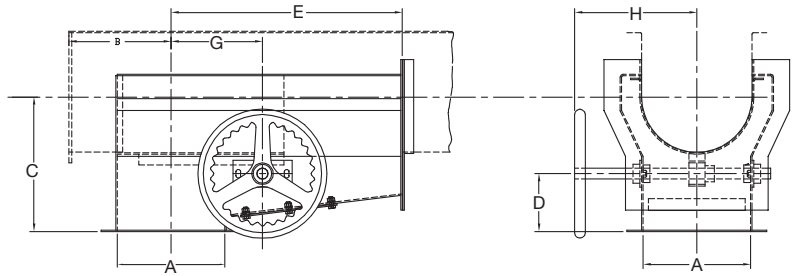

Dust Tight Rack and Pinion Curved Slide

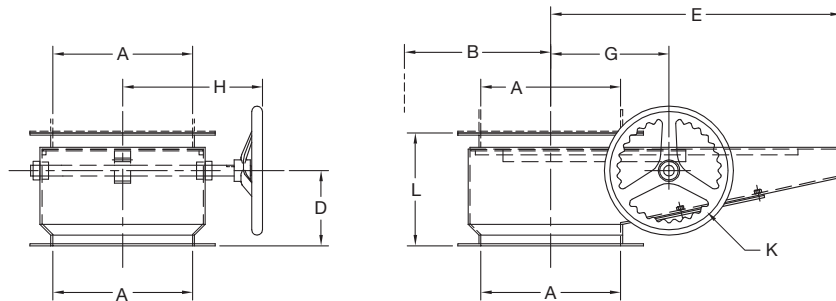

Screw Diameter	A	B	C	D	E	G	H	K Diameter	L
4	5	4½	7½	2½	12	6	7	12	7½
6	7	6	10	4	18½	7½	8	12	9
9	10	8	12½	5	23	9	11	12	10
10	11	9	13	5	25	10	11½	12	10½
12	13	10½	15	5	28	11½	13	12	10½
14	15	11½	15½	5½	31	12½	14	12	10½
16	17	13½	16½	5½	34	13½	15	12	10½
18	19	14½	18½	6½	38½	15	16½	12	11½
20	21	15½	20	7	40½	16	17½	12	12
24	25	17½	23	8	47½	18	19½	12	13

Screw Diameter	Trough Thickness Gauge	Spout and Slide Thickness Gauge	Part Number			
			Flat Slide * ①	Weight	Curved Slide * ①	Weight
4	16-14	14	4RPF14	27	4RPCD16	30
4	12	12	4RPF12	32	4RPCD12	35
6	16-14-12 ⅜	14	6RPF14	42	6RPCD16	46
6		12	6RPF12	47	6RPCD12	52
9	14-12-10	14	9RPF12	74	9RPCD12	81
9	⅜-¼	10	9RPF10	81	9RPCD10	89
10	14-12-10	14	10RPF14	84	10RPCD14	92
10	⅜-¼	10	10RPF10	93	10RPCD10	102
12	12-10	12	12RPF12	141	12RPCD12	155
12	⅜-¼	⅜	12RPF7	158	12RPCD7	174
14	12-10	12	14RPF12	160	14RPCD12	176
14	⅜-¼	⅜	14RPF7	185	14RPCD7	204
16	12-10	12	16RPF12	168	16RPCD12	185
16	⅜-¼	⅜	16RPF7	197	16RPCD7	217
18	12-10	12	18RPF12	240	18RPCD12	264
18	⅜-¼	⅜	18RPF7	277	18RPCD7	305
20	10	12	20RPF12	278	20RPCD12	306
20	⅜-¼	⅜	20RPF7	318	20RPCD7	350
24	10	12	24RPF12	350	24RPCD12	385
24	⅜-¼	⅜	24RPF7	402	24RPCD7	442

* Handwheel supplied as standard assembly
 — C Chain Wheel
 — R Rope Wheel

Flange drilling is standard. See page H-43
 ① Add -F for Fitted

CONVEYORS

Hand Wheel

Dimensions in Inches and Weight in Pounds

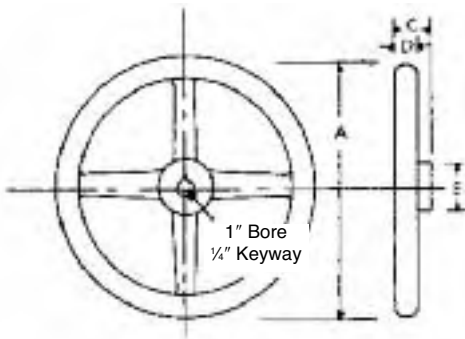

Wheel Diameter	Part No.	Weight	C	D	E
12	12HW1	11	2	1½	1½

The hand wheel is regularly furnished to rotate the pinion shaft when the slide gate is readily accessible.

NOTE: Zinc or nickel plated hand wheels available on request.

Pocket Wheel & Rope Wheel

Dimensions in Inches and Average Weights in Pounds

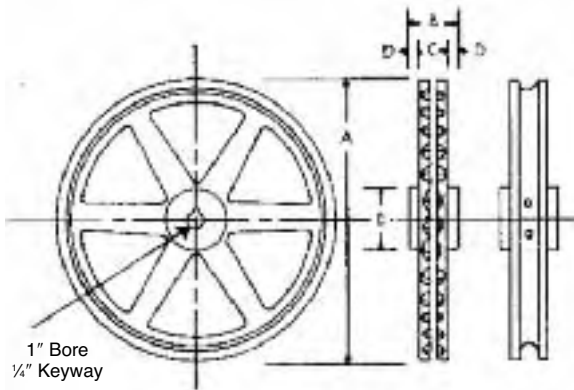

Wheel Diameter	Part No.	Weight	A	B	C	D	E
Chain Wheel	20PW1	11	12¾	2	1½	¾	2
Rope Wheel	12RW1	13	12%	2¼	1½	1¼	1½

Pocket chain and rope wheels are used to rotate pinion shaft where remote operation is desired. It is designed to be used with number ¾ pocket chain.

NOTE: Zinc or nickel plated hand wheels available on request.

316 PC Pocket Chain in Stock

Hanger Pockets

Hanger pockets are used with tubular trough and are mounted on the trough at bearing connections. The hanger pocket forms a "U" shaped section for a short distance, allowing the use of standard hangers and providing easy access to them.

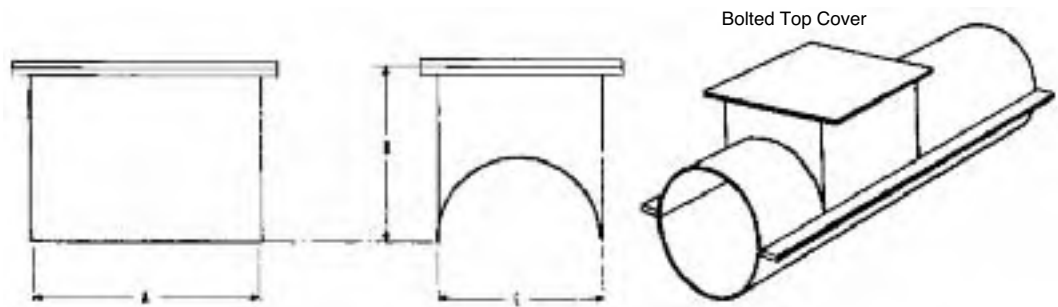

Conveyor Diameter	Part Number	A	B	C	Weight Each
4	4CPH16	8	3¾	5	2
6	6CPH16	12	4¾	7	3
9	9CPH14	12	6%	10	4
10	10CPH14	12	6%	11	9
12	12CPH12	18	8	13	18
14	14CPH12	18	9½	15	24
16	16CPH12	18	10%	17	26
18	18CPH12	18	12%	19	55
20	20CPH10	18	13%	21	70
24	24CPH10	18	16%	25	85

Trough Ends

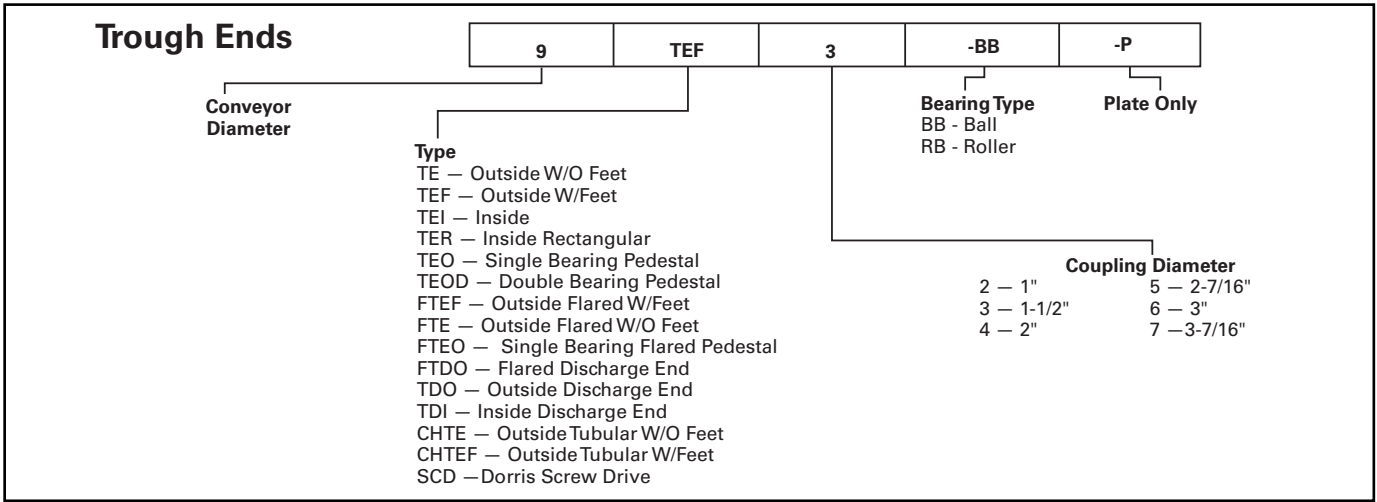

CONVEYORS

	U-TROUGH	TUBULAR TROUGH	FLARED TROUGH	RECTANGULAR TROUGH	
OUTSIDE TROUGH ENDS WITH FEET					Most common type used as trough support is included.
OUTSIDE TROUGH ENDS WITHOUT FEET					Trough support not included.
INSIDE PATTERN TROUGH ENDS		Available on application	Available on application		Used where space is limited or trough does not have end flange.
DISCHARGE TROUGH ENDS		Available on application			For end discharge conveyors. Special flange bearing required.
OUTBOARD BEARING TROUGH ENDS SINGLE					Used when compression type packing gland seal or split gland seal required.

Outside Less Feet

Outside trough ends less feet are used to support end bearing and cover when no trough support is required. Drilling for bronze bearing or flanged ball bearing is standard.

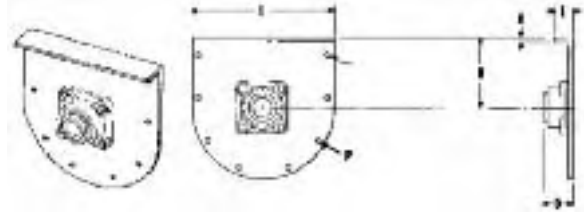

Conveyor Diameter	Shaft Diameter	▲ Part Number	B	D			E	K	L	N	Weight	P Slot
				Friction Bearing	Ball Bearing	Roller Bearing						
4	1	4TE2-*	3 $\frac{3}{8}$	2 $\frac{1}{8}$	1 $\frac{1}{8}$		1 $\frac{1}{8}$	$\frac{1}{4}$	8 $\frac{1}{8}$	$\frac{3}{8}$	3	$\frac{1}{8}$ x $\frac{9}{16}$
6	1 $\frac{1}{2}$	6TE3-*	4 $\frac{1}{2}$	3 $\frac{3}{8}$	2 $\frac{3}{8}$	3 $\frac{1}{4}$	1 $\frac{1}{2}$	$\frac{1}{4}$	10 $\frac{1}{8}$	$\frac{3}{8}$	4	$\frac{1}{8}$ x $\frac{9}{16}$
9	1 $\frac{1}{2}$	9TE3-*	6 $\frac{1}{8}$	3 $\frac{3}{4}$	2 $\frac{3}{8}$	3 $\frac{1}{4}$	1 $\frac{1}{8}$	$\frac{1}{4}$	13 $\frac{3}{8}$	$\frac{3}{8}$	9	$\frac{1}{8}$ x $\frac{9}{16}$
	2	9TE4-*	6 $\frac{1}{8}$	4 $\frac{1}{4}$	2 $\frac{1}{2}$	3 $\frac{3}{8}$	1 $\frac{1}{8}$	$\frac{1}{4}$	13 $\frac{3}{8}$	$\frac{3}{8}$	9	$\frac{1}{8}$ x $\frac{9}{16}$
10	1 $\frac{1}{2}$	10TE3-*	6 $\frac{3}{8}$	3 $\frac{3}{4}$	2 $\frac{3}{8}$	3 $\frac{1}{4}$	1 $\frac{3}{4}$	$\frac{1}{4}$	14 $\frac{1}{4}$	$\frac{3}{8}$	11	$\frac{1}{8}$ x $\frac{9}{16}$
	2	10TE4-*	6 $\frac{3}{8}$	4 $\frac{1}{4}$	2 $\frac{1}{2}$	3 $\frac{3}{8}$	1 $\frac{3}{4}$	$\frac{1}{4}$	14 $\frac{1}{4}$	$\frac{3}{8}$	11	$\frac{1}{8}$ x $\frac{9}{16}$
12	2	12TE4-*	7 $\frac{1}{4}$	4 $\frac{1}{4}$	2 $\frac{3}{8}$	3 $\frac{3}{8}$	2	$\frac{1}{4}$	17 $\frac{1}{4}$	$\frac{1}{2}$	20	
	2 $\frac{1}{8}$	12TE5-*	7 $\frac{1}{4}$	5 $\frac{1}{4}$	2 $\frac{1}{2}$	4 $\frac{1}{8}$	2	$\frac{1}{4}$	17 $\frac{1}{4}$	$\frac{1}{2}$	20	$\frac{9}{16}$ x $\frac{1}{16}$
	3	12TE6-*	7 $\frac{1}{4}$	6 $\frac{1}{4}$	3 $\frac{1}{4}$	4 $\frac{1}{8}$	2	$\frac{1}{4}$	17 $\frac{1}{4}$	$\frac{1}{2}$	20	
14	2 $\frac{1}{8}$	14TE5-*	9 $\frac{1}{4}$	5 $\frac{5}{8}$	2 $\frac{1}{2}$	4 $\frac{1}{8}$	2	$\frac{1}{4}$	19 $\frac{1}{4}$	$\frac{1}{2}$	35	$\frac{9}{16}$ x $\frac{1}{16}$
	3	14TE6-*	9 $\frac{1}{4}$	5 $\frac{5}{8}$	3 $\frac{1}{4}$	4 $\frac{1}{8}$	2	$\frac{1}{4}$	19 $\frac{1}{4}$	$\frac{1}{2}$	35	
16	3	16TE6-*	10 $\frac{1}{8}$	6 $\frac{1}{8}$	3 $\frac{3}{8}$	5	2 $\frac{1}{2}$	$\frac{5}{8}$	21 $\frac{1}{4}$	$\frac{5}{8}$	42	$\frac{1}{16}$ x $\frac{1}{16}$
18	3	18TE6-*	12 $\frac{1}{8}$	6 $\frac{3}{8}$	3 $\frac{3}{8}$	5	2 $\frac{1}{2}$	$\frac{3}{8}$	24 $\frac{1}{4}$	$\frac{5}{8}$	60	$\frac{1}{16}$ x $\frac{1}{16}$
	3 $\frac{1}{8}$	18TE7-*	12 $\frac{1}{8}$	7 $\frac{3}{8}$	4 $\frac{1}{8}$	5 $\frac{1}{8}$	2 $\frac{1}{2}$	$\frac{3}{8}$	24 $\frac{1}{4}$	$\frac{5}{8}$	60	
20	3	20TE6-*	13 $\frac{1}{2}$	6 $\frac{3}{8}$	3 $\frac{3}{8}$	5 $\frac{1}{8}$	2 $\frac{1}{2}$	$\frac{3}{8}$	26 $\frac{1}{4}$	$\frac{5}{8}$	90	$\frac{1}{16}$ x $\frac{1}{16}$
	3 $\frac{1}{8}$	20TE7-*	13 $\frac{1}{2}$	7 $\frac{3}{8}$	4 $\frac{1}{8}$	5 $\frac{1}{8}$	2 $\frac{1}{2}$	$\frac{3}{8}$	26 $\frac{1}{4}$	$\frac{5}{8}$	90	
24	3 $\frac{1}{8}$	24TE7-*	16 $\frac{1}{2}$	7 $\frac{3}{8}$	4 $\frac{1}{8}$	5 $\frac{1}{8}$	2 $\frac{1}{2}$	$\frac{3}{8}$	30 $\frac{1}{4}$	$\frac{5}{8}$	120	$\frac{1}{16}$ x $\frac{1}{16}$

Outside With Feet

Outside trough ends with feet are used to support end bearing, cover and trough. Drilling for bronze bearing or flanged ball bearing is standard.

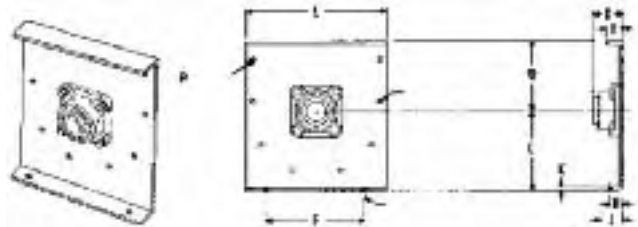

Conveyor Diameter	Shaft Diameter	▲ Part Number	B	C	D			E	F	H	J	K	L	M	N	Weight	P Slot
					Friction Bearing	Ball Bearing	Roller Bearing										
4	1	4TEF2-*	3 $\frac{3}{8}$	4 $\frac{5}{8}$	2 $\frac{1}{8}$	1 $\frac{1}{8}$	—	1 $\frac{1}{8}$	5 $\frac{1}{4}$	1	1 $\frac{1}{8}$	$\frac{1}{4}$	8 $\frac{1}{8}$	$\frac{3}{8}$	$\frac{3}{8}$	4	$\frac{1}{8}$ x $\frac{9}{16}$
6	1 $\frac{1}{2}$	6TEF3-*	4 $\frac{1}{2}$	5 $\frac{5}{8}$	3 $\frac{3}{8}$	2 $\frac{3}{8}$	3 $\frac{1}{4}$	1 $\frac{1}{2}$	8 $\frac{1}{8}$	1	1 $\frac{1}{4}$	$\frac{1}{4}$	10 $\frac{1}{8}$	$\frac{3}{8}$	$\frac{3}{8}$	7	$\frac{1}{8}$ x $\frac{9}{16}$
9	1 $\frac{1}{2}$	9TEF3-*	6 $\frac{1}{8}$	7 $\frac{1}{8}$	3 $\frac{3}{8}$	2 $\frac{3}{8}$	3 $\frac{1}{4}$	1 $\frac{1}{8}$	9 $\frac{3}{8}$	1 $\frac{1}{2}$	2 $\frac{3}{8}$	$\frac{1}{4}$	13 $\frac{3}{8}$	$\frac{1}{2}$	$\frac{3}{8}$	12	$\frac{1}{8}$ x $\frac{9}{16}$
	2	9TEF4-*	6 $\frac{1}{8}$	7 $\frac{1}{8}$	4 $\frac{1}{8}$	2 $\frac{1}{2}$	3 $\frac{3}{8}$	1 $\frac{1}{8}$	9 $\frac{3}{8}$	1 $\frac{1}{2}$	2 $\frac{3}{8}$	$\frac{1}{4}$	13 $\frac{3}{8}$	$\frac{1}{2}$	$\frac{3}{8}$	12	$\frac{1}{8}$ x $\frac{9}{16}$
10	1 $\frac{1}{2}$	10TEF3-*	6 $\frac{3}{8}$	8 $\frac{1}{8}$	3 $\frac{3}{8}$	2 $\frac{3}{8}$	3 $\frac{1}{4}$	1 $\frac{3}{4}$	9 $\frac{1}{2}$	1 $\frac{3}{4}$	2 $\frac{3}{8}$	$\frac{1}{4}$	14 $\frac{3}{4}$	$\frac{1}{2}$	$\frac{3}{8}$	14	$\frac{1}{8}$ x $\frac{9}{16}$
	2	10TEF4-*	6 $\frac{3}{8}$	8 $\frac{1}{8}$	4 $\frac{1}{8}$	2 $\frac{1}{2}$	3 $\frac{3}{8}$	1 $\frac{3}{4}$	9 $\frac{1}{2}$	1 $\frac{3}{4}$	2 $\frac{3}{8}$	$\frac{1}{4}$	14 $\frac{3}{4}$	$\frac{1}{2}$	$\frac{3}{8}$	14	$\frac{1}{8}$ x $\frac{9}{16}$
12	2	12TEF4-*	7 $\frac{1}{4}$	9 $\frac{1}{8}$	5	2 $\frac{3}{8}$	3 $\frac{3}{8}$	2	12 $\frac{1}{4}$	1 $\frac{1}{8}$	2 $\frac{3}{4}$	$\frac{1}{4}$	17 $\frac{1}{4}$	$\frac{5}{8}$	$\frac{1}{2}$	23	$\frac{9}{16}$ x $\frac{1}{16}$
	2 $\frac{1}{8}$	12TEF5-*	7 $\frac{1}{4}$	9 $\frac{1}{8}$	5 $\frac{1}{2}$	2 $\frac{1}{2}$	4 $\frac{1}{8}$	2	12 $\frac{1}{4}$	1 $\frac{1}{8}$	2 $\frac{3}{4}$	$\frac{1}{4}$	17 $\frac{1}{4}$	$\frac{5}{8}$	$\frac{1}{2}$	23	$\frac{9}{16}$ x $\frac{1}{16}$
	3	12TEF6-*	7 $\frac{1}{4}$	9 $\frac{1}{8}$	5 $\frac{1}{2}$	3 $\frac{3}{4}$	4 $\frac{1}{8}$	2	12 $\frac{1}{4}$	1 $\frac{1}{8}$	2 $\frac{3}{4}$	$\frac{1}{4}$	17 $\frac{1}{4}$	$\frac{5}{8}$	$\frac{1}{2}$	23	$\frac{9}{16}$ x $\frac{1}{16}$
14	2 $\frac{1}{8}$	14TEF5-*	9 $\frac{1}{4}$	10 $\frac{1}{8}$	5 $\frac{1}{2}$	2 $\frac{1}{2}$	4 $\frac{1}{8}$	2	13 $\frac{1}{2}$	1 $\frac{1}{8}$	2 $\frac{3}{8}$	$\frac{1}{4}$	19 $\frac{1}{4}$	$\frac{5}{8}$	$\frac{1}{2}$	38	$\frac{9}{16}$ x $\frac{1}{16}$
	3	14TEF6-*	9 $\frac{1}{4}$	10 $\frac{1}{8}$	5 $\frac{1}{2}$	3 $\frac{3}{4}$	4 $\frac{1}{8}$	2	13 $\frac{1}{2}$	1 $\frac{1}{8}$	2 $\frac{3}{8}$	$\frac{1}{4}$	19 $\frac{1}{4}$	$\frac{5}{8}$	$\frac{1}{2}$	38	$\frac{9}{16}$ x $\frac{1}{16}$
16	3	16TEF6-*	10 $\frac{1}{8}$	12	5 $\frac{1}{8}$	3 $\frac{3}{8}$	5	2 $\frac{1}{2}$	14 $\frac{3}{8}$	2	3 $\frac{1}{4}$	$\frac{5}{8}$	21 $\frac{1}{4}$	$\frac{5}{8}$	$\frac{5}{8}$	45	$\frac{1}{16}$ x $\frac{1}{16}$
18	3	18TEF6-*	12 $\frac{1}{8}$	13 $\frac{3}{8}$	5 $\frac{1}{8}$	3 $\frac{3}{8}$	5	2 $\frac{1}{2}$	16	2	3 $\frac{1}{4}$	$\frac{3}{8}$	24 $\frac{1}{4}$	$\frac{5}{8}$	$\frac{5}{8}$	67	$\frac{1}{16}$ x $\frac{1}{16}$
	3 $\frac{1}{8}$	18TEF7-*	12 $\frac{1}{8}$	13 $\frac{3}{8}$	6 $\frac{1}{8}$	4 $\frac{1}{8}$	5 $\frac{1}{8}$	2 $\frac{1}{2}$	16	2	3 $\frac{1}{4}$	$\frac{3}{8}$	24 $\frac{1}{4}$	$\frac{5}{8}$	$\frac{5}{8}$	67	$\frac{1}{16}$ x $\frac{1}{16}$
20	3	20TEF6-*	13 $\frac{1}{2}$	15	5 $\frac{1}{4}$	3 $\frac{3}{8}$	5 $\frac{1}{8}$	2 $\frac{1}{2}$	19 $\frac{1}{4}$	2 $\frac{1}{4}$	3 $\frac{3}{4}$	$\frac{3}{8}$	26 $\frac{1}{4}$	$\frac{3}{4}$	$\frac{5}{8}$	120	$\frac{1}{16}$ x $\frac{1}{16}$
	3 $\frac{1}{8}$	20TEF7-*	13 $\frac{1}{2}$	15	7	4 $\frac{1}{8}$	5 $\frac{1}{8}$	2 $\frac{1}{2}$	19 $\frac{1}{4}$	2 $\frac{1}{4}$	3 $\frac{3}{4}$	$\frac{3}{8}$	26 $\frac{1}{4}$	$\frac{3}{4}$	$\frac{5}{8}$	120	$\frac{1}{16}$ x $\frac{1}{16}$
24	3 $\frac{1}{8}$	24TEF7-*	16 $\frac{1}{2}$	18 $\frac{1}{8}$	7	4 $\frac{1}{8}$	5 $\frac{1}{8}$	2 $\frac{1}{2}$	20	2 $\frac{1}{2}$	4 $\frac{1}{8}$	$\frac{3}{8}$	30 $\frac{1}{4}$	$\frac{3}{4}$	$\frac{5}{8}$	162	$\frac{1}{16}$ x $\frac{1}{16}$

▲ Can be furnished with CSP, CSW, or CSFP seals

-*BB Ball Bearing
-*BR Bronze Bearing

-*RB Roller Bearing
-*P Less Bearing

Trough Ends

Inside

Inside trough ends are used in place of outside type where no trough end flanges are required. Drilling for bronze bearings or flanged ball bearing is standard.

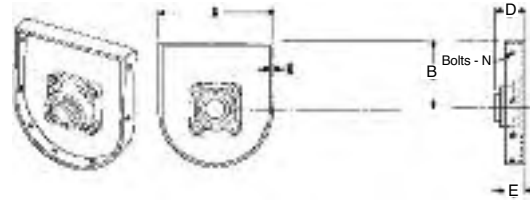

Conveyor Diameter	Shaft Diameter	▲ Part Number	A	B	D			E	K	N	Weight
					Friction Bearing	Ball Bearing	Roller Bearing				
4	1	4TEI2-*	5	3 $\frac{3}{8}$	2 $\frac{3}{16}$	1 $\frac{1}{8}$	—	2	$\frac{1}{4}$	$\frac{1}{4}$	3
6	1 $\frac{1}{2}$	6TEI3-*	7	4 $\frac{1}{2}$	3 $\frac{3}{16}$	2 $\frac{3}{16}$	3 $\frac{1}{16}$	2	$\frac{1}{4}$	$\frac{5}{16}$	5
9	1 $\frac{1}{2}$	9TEI3-*	10	6 $\frac{1}{8}$	3 $\frac{1}{4}$	2 $\frac{3}{16}$	3 $\frac{1}{16}$	2	$\frac{1}{4}$	$\frac{3}{8}$	9
	2	9TEI4-*	10	6 $\frac{1}{8}$	4 $\frac{1}{4}$	2 $\frac{1}{2}$	3 $\frac{3}{16}$	2	$\frac{1}{4}$	$\frac{3}{8}$	9
10	1 $\frac{1}{2}$	10TEI3-*	11	6 $\frac{1}{8}$	3 $\frac{1}{4}$	2 $\frac{3}{16}$	3 $\frac{1}{16}$	2	$\frac{1}{4}$	$\frac{3}{8}$	11
	2	10TEI4-*	11	6 $\frac{1}{8}$	4 $\frac{1}{4}$	2 $\frac{1}{2}$	3 $\frac{3}{16}$	2	$\frac{1}{4}$	$\frac{3}{8}$	11
12	2	12TEI4-*	13	7 $\frac{1}{4}$	4 $\frac{1}{4}$	2 $\frac{3}{16}$	3 $\frac{3}{8}$	2	$\frac{1}{4}$	$\frac{1}{2}$	19
	2 $\frac{7}{16}$	12TEI5-*	13	7 $\frac{1}{4}$	5 $\frac{1}{4}$	2 $\frac{3}{16}$	4 $\frac{1}{16}$	2	$\frac{1}{4}$	$\frac{1}{2}$	19
	3	12TEI6-*	13	7 $\frac{1}{4}$	6 $\frac{1}{4}$	3 $\frac{3}{16}$	4 $\frac{1}{16}$	2	$\frac{1}{4}$	$\frac{1}{2}$	19
14	2 $\frac{7}{16}$	14TEI5-*	15	9 $\frac{1}{4}$	5 $\frac{1}{16}$	2 $\frac{3}{16}$	4 $\frac{7}{16}$	2	$\frac{1}{4}$	$\frac{1}{2}$	34
	3	14TEI6-*	15	9 $\frac{1}{4}$	6 $\frac{3}{16}$	3 $\frac{3}{4}$	4 $\frac{1}{16}$	2	$\frac{1}{4}$	$\frac{1}{2}$	34
16	3	16TEI6-*	17	10 $\frac{3}{8}$	6 $\frac{3}{16}$	3 $\frac{3}{16}$	5	2	$\frac{5}{16}$	$\frac{3}{8}$	40
	3	18TEI6-*	19	12 $\frac{1}{2}$	6 $\frac{3}{8}$	3 $\frac{3}{16}$	5	2	$\frac{3}{8}$	$\frac{3}{8}$	58
18	3 $\frac{3}{16}$	18TEI7-*	19	12 $\frac{1}{2}$	7 $\frac{1}{8}$	4 $\frac{1}{16}$	5 $\frac{1}{16}$	2	$\frac{3}{8}$	$\frac{3}{8}$	58
	3	20TEI6-*	21	13 $\frac{1}{2}$	6 $\frac{3}{8}$	3 $\frac{3}{8}$	5 $\frac{1}{16}$	2	$\frac{3}{8}$	$\frac{3}{8}$	83
20	3 $\frac{3}{16}$	20TEI7-*	21	13 $\frac{1}{2}$	7 $\frac{1}{8}$	4 $\frac{3}{8}$	5 $\frac{3}{8}$	2	$\frac{3}{8}$	$\frac{3}{8}$	83
	3 $\frac{3}{16}$	24TEI7-*	25	16 $\frac{1}{2}$	7 $\frac{3}{8}$	4 $\frac{3}{8}$	5 $\frac{3}{8}$	2	$\frac{3}{8}$	$\frac{3}{8}$	116

Inside Rectangular

Rectangular trough ends are used inside of rectangular trough. Drilling for bronze bearing or flanged ball bearing is standard.

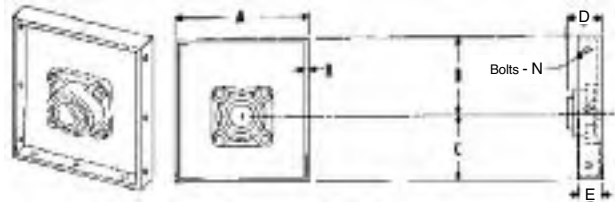

Conveyor Diameter	Shaft Diameter	▲ Part Number	A	B	C	D			E	K	N	Weight
						Friction Bearing	Ball Bearing	Roller Bearing				
4	1	4TER2-*	5	3 $\frac{3}{8}$	2 $\frac{1}{2}$	2 $\frac{3}{16}$	1 $\frac{1}{8}$	—	2	$\frac{1}{4}$	$\frac{1}{4}$	4
6	1 $\frac{1}{2}$	6TER3-*	7	4 $\frac{1}{2}$	3 $\frac{1}{2}$	3 $\frac{3}{16}$	2 $\frac{3}{16}$	3 $\frac{1}{16}$	2	$\frac{1}{4}$	$\frac{5}{16}$	6
9	1 $\frac{1}{2}$	9TER3-*	10	6 $\frac{1}{8}$	5	3 $\frac{1}{4}$	2 $\frac{3}{16}$	3 $\frac{1}{16}$	2	$\frac{1}{4}$	$\frac{3}{8}$	9
	2	9TER4-*	10	6 $\frac{1}{8}$	5	4 $\frac{1}{4}$	2 $\frac{1}{2}$	3 $\frac{3}{16}$	2	$\frac{1}{4}$	$\frac{3}{8}$	9
10	1 $\frac{1}{2}$	10TER3-*	11	6 $\frac{1}{8}$	5 $\frac{1}{2}$	3 $\frac{1}{4}$	2 $\frac{3}{16}$	3 $\frac{1}{16}$	2	$\frac{1}{4}$	$\frac{3}{8}$	12
	2	10TER4-*	11	6 $\frac{1}{8}$	5 $\frac{1}{2}$	4 $\frac{1}{4}$	2 $\frac{1}{2}$	3 $\frac{3}{16}$	2	$\frac{1}{4}$	$\frac{3}{8}$	12
12	2	12TER4-*	13	7 $\frac{1}{4}$	6 $\frac{1}{2}$	4 $\frac{1}{4}$	2 $\frac{3}{16}$	3 $\frac{3}{8}$	2	$\frac{1}{4}$	$\frac{1}{2}$	21
	2 $\frac{7}{16}$	12TER5-*	13	7 $\frac{1}{4}$	6 $\frac{1}{2}$	5 $\frac{1}{4}$	2 $\frac{3}{16}$	4 $\frac{7}{16}$	2	$\frac{1}{4}$	$\frac{1}{2}$	21
	3	12TER6-*	13	7 $\frac{1}{4}$	6 $\frac{1}{2}$	6 $\frac{1}{4}$	3 $\frac{3}{16}$	4 $\frac{1}{16}$	2	$\frac{1}{4}$	$\frac{1}{2}$	21
14	2 $\frac{7}{16}$	14TER5-*	15	9 $\frac{1}{4}$	7 $\frac{1}{2}$	5 $\frac{1}{16}$	2 $\frac{3}{16}$	4 $\frac{7}{16}$	2	$\frac{1}{4}$	$\frac{1}{2}$	35
	3	14TER6-*	15	9 $\frac{1}{4}$	7 $\frac{1}{2}$	6 $\frac{3}{16}$	3 $\frac{3}{4}$	4 $\frac{1}{16}$	2	$\frac{1}{4}$	$\frac{1}{2}$	35
16	3	16TER6-*	17	10 $\frac{3}{8}$	8 $\frac{1}{2}$	6 $\frac{3}{16}$	3 $\frac{3}{16}$	5	2	$\frac{5}{16}$	$\frac{3}{8}$	41
	3	18TER6-*	19	12 $\frac{1}{2}$	9 $\frac{1}{2}$	6 $\frac{3}{8}$	3 $\frac{3}{16}$	5	2	$\frac{3}{8}$	$\frac{3}{8}$	60
18	3 $\frac{3}{16}$	18TER7-*	19	12 $\frac{1}{2}$	9 $\frac{1}{2}$	7 $\frac{1}{8}$	4 $\frac{1}{16}$	5 $\frac{1}{16}$	2	$\frac{3}{8}$	$\frac{3}{8}$	60
	3	20TER6-*	21	13 $\frac{1}{2}$	10 $\frac{1}{2}$	6 $\frac{3}{8}$	3 $\frac{3}{8}$	5 $\frac{1}{16}$	2	$\frac{3}{8}$	$\frac{3}{8}$	88
20	3 $\frac{3}{16}$	20TER7-*	21	13 $\frac{1}{2}$	10 $\frac{1}{2}$	7 $\frac{1}{8}$	4 $\frac{3}{8}$	5 $\frac{3}{8}$	2	$\frac{3}{8}$	$\frac{3}{8}$	88
	3 $\frac{3}{16}$	24TER7-*	25	16 $\frac{1}{2}$	12 $\frac{1}{2}$	7 $\frac{3}{8}$	4 $\frac{3}{8}$	5 $\frac{3}{8}$	2	$\frac{3}{8}$	$\frac{3}{8}$	125

▲ Can be furnished with CSP, CSW, or CSS seals

-*BB Ball Bearing
-*BP Bronze Bearing

-*RB Roller Bearing
-*P Less Bearing

Single Bearing

Single bearing pedestal type trough ends are constructed with base for mounting pillow block bearings and shaft seal or packing gland.

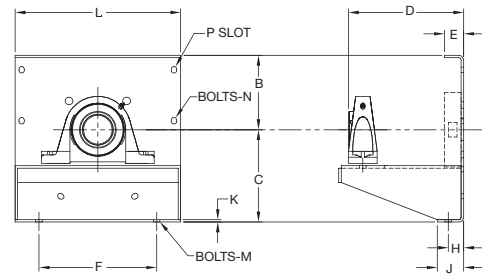

Conveyor Diameter	Shaft Diameter	Part Number	B	C	D	E	F	H	J	K	L	M	N	P Slot	Weight
6	1½	6TEO3													
9	1½ 2	9TEO3 9TEO4													
10	1½ 2	10TEO3 10TEO4													
12	2 2 ² / ₁₆ 3	12TEO4 12TEO5 12TEO6													
14	2 ² / ₁₆ 3	14TEO5 14TEO6													
16	3	16TEO6													
18	3 3 ³ / ₁₆	18TEO6 18TEO7													
20	3 3 ³ / ₁₆	20TEO6 20TEO7													
24	3 ³ / ₁₆	24TEO7													

Consult
Factory

Double Bearing

Double bearing pedestal type trough ends are for use with pillow block bearing in conjunction with a flanged bearing providing extra shaft support.

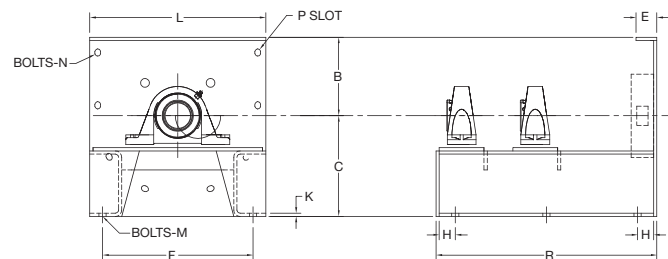

Conveyor Diameter	Shaft Diameter	Part Number	B	C	E	F	H	K	L	M	N	R	P Slot	Weight
6	1½	6TEOD3												
9	1½ 2	9TEOD3 9TEOD4												
10	1½ 2	10TEOD3 10TEOD4												
12	2 2 ² / ₁₆ 3	12TEOD4 12TEOD5 12TEOD6												
14	2 ² / ₁₆ 3	14TEOD5 14TEOD6												
16	3	16TEOD6												
18	3 3 ³ / ₁₆	18TEOD6 18TEOD7												
20	3 3 ³ / ₁₆	20TEOD6 20TEOD7												
24	3 ³ / ₁₆	24TEOD7												

Consult
Factory

Trough Ends

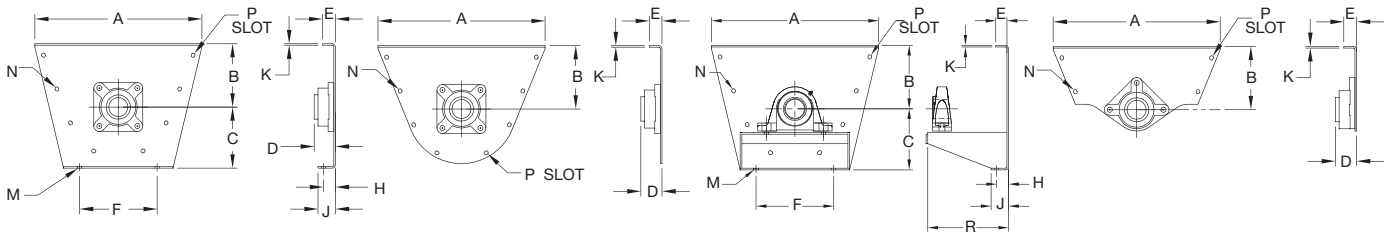

Outside With Feet

Outside Less Feet

Outboard Bearing

Discharge

Application: same as standard trough ends except for flared trough.

Conveyor Diameter	Shaft Diameter	A	B	C	D			E	F	H	J	K	M	N	R	P Slot
					Friction Bearing	Ball Bearing	Roller Bearing									
6	1½	16½	7	5½	3⅜	2⅜	3¼	1½	8½	1	1¼	¼	¾	¾	Consult Factory	7/16 x 9/16
9	1½ 2	21¼ 21¼	9 9	7½ 7½	¾ 4¼	2⅜ 2½	¾	1½ 1½	9½ 9½	1½ 1½	2½ 2½	¼ ¼	½ ½	¾ ¾		7/16 x 9/16 7/16 x 9/16
12	2	26½	10	9½	4¼	2⅜	3½	2	12¼	1½	2¼	¼	5/8	½		9/16 x 11/16
	2⅜ 3	26½ 26½	10 10	9½ 9½	5¼ 6¼	2⅜ 3¼	4½ 5	2 2	12¼ 12¼	1½ 1½	2¼ 2¼	¼ ¼	5/8 5/8	½ ½		9/16 x 11/16 9/16 x 11/16
14	2⅜ 3	28½ 28½	11 11	10½ 10½	5⅜ 6⅜	2⅜ 3¼	4½ 5	2 2	13½ 13½	1½ 1½	2½ 2½	¼ ¼	5/8 5/8	½ ½		9/16 x 11/16 9/16 x 11/16
	3	32½	11½	12	6⅜	3⅜	5	2½	14½	2	3¼	5/16	5/8	5/8		11/16 x 13/16
18	3 3⅜	36½ 36½	12½ 12½	13½ 13½	6½ 7½	3⅜ 4⅜	5 5½	2½ 2½	16 16	2 2	3¼ 3¼	¾ ¾	5/8 5/8	5/8 5/8		11/16 x 13/16 11/16 x 13/16
	3 3⅜	39½ 39½	13½ 13½	15 15	6½ 7½	3½ 4½	5 5½	2½ 2½	19¼ 19¼	2¼ 2¼	3¼ 3¼	¾ ¾	¾ ¾	5/8 5/8		11/16 x 13/16 11/16 x 13/16
24	3⅜	45½	16½	18½	7½	4½	5½	2½	20	2½	4½	¾	¾	5/8	11/16 x 13/16	

CONVEYORS

Conveyor Diameter	Shaft Diameter	Part Number							
		Outside With Feet	Weight	Outside Less Feet	Weight	Outboard Bearing	Weight	Discharge	Weight
6	1½	6FTEF3-*	15	6FTE3-*	13	6FTEO3-*	22	6FTDO3-**	11
9	1½	9FTEF3-*	22	9FTE3-*	19	9FTEO3-*	31	9FTDO3-**	15
	2	9FTEF4-*	27	9FTE4-*	24	9FTEO4-*	36	9FTDO4-**	20
12	2	12FTEF4-*	43	12FTE4-*	36	12FTEO4-*	63	12FTDO4-**	28
	2⅜	12FTEF5-*	44	12FTE5-*	37	12FTEO5-*	64	12FTDO5-**	29
	3	12FTEF6-*	56	12FTE6-*	49	12FTEO6-*	76	12FTDO6-**	41
14	2⅜	14FTEF5-*	52	14FTE5-*	43	14FTEO5-*	75	14FTDO5-**	33
	3	14FTEF6-*	64	14FTE6-*	55	14FTEO6-*	87	14FTDO6-**	45
16	3	16FTEF6-*	85	16FTE6-*	72	16FTEO6-*	125	16FTDO6-**	56
18	3	18FTEF6-*	98	18FTE6-*	83	18FTEO6-*	138	18FTDO6-**	63
	3⅜	18FTEF7-*	104	18FTE7-*	89	18FTEO7-*	144	18FTDO7-**	69
20	3	20FTEF6-*	133	20FTE6-*	103	20FTEO6-*	196	20FTDO6-**	75
	3⅜	20FTEF7-*	139	20FTE7-*	109	20FTEO7-*	202	20FTDO7-**	81
24	3⅜	24FTEF7-*	179	24FTE7-*	132	24FTEO7-*	250	24FTDO7-**	96

- *BB Ball Bearing
- *BR Bronze Bearing
- *RB Roller Bearing
- *P Less Bearing

For Bolt Pattern see Page H-42

Outside Discharge

Outside discharge trough ends are used to support end bearing and will allow material to discharge or overflow through the end of the trough. Drilling for three bolt bronze or flanged ball bearing is standard.

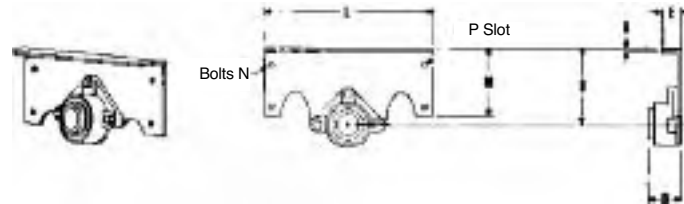

Conveyor Diameter	Shaft Diameter	Part Number	B	D			E	K	L	M	N	P Slot	Weight
				Friction Bearing	Ball Bearing	Roller Bearing							
4	1	4TDO2-*	3 ³ / ₈	2 ¹ / ₁₆	1 ¹ / ₈		2	1/4	8	3 ³ / ₈	3/8	7/16 x 9/16	2
6	1 1/2	6TDO3-*	4 1/2	3 ³ / ₁₆	2 ¹ / ₁₆	3 1/16	2	1/4	9 3/4	4 1/2	3/8	7/16 x 9/16	3
9	1 1/2 2	9TDO3-* 9TDO4-*	6 ¹ / ₈ 6 ¹ / ₈	3 ¹ / ₄ 4 ¹ / ₄	2 ¹ / ₁₆ 2 ¹ / ₂	3 1/16 3 3/16	2 2	1/4 1/4	13 ³ / ₈ 13 ³ / ₈	6 ¹ / ₈ 6 ¹ / ₈	3/8 3/8	7/16 x 9/16 7/16 x 9/16	5 5
10	1 1/2 2	10TDO3-* 10TDO4-*	6 ³ / ₈ 6 ³ / ₈	3 ¹ / ₄ 4 ¹ / ₄	2 ¹ / ₁₆ 2 ¹ / ₂	3 1/16 3 3/16	2 2	1/4 1/4	14 ³ / ₈ 14 ³ / ₈	6 ³ / ₈ 6 ³ / ₈	3/8 3/8	7/16 x 9/16 7/16 x 9/16	6 6
12	2 2 1/16 3	12TDO4-* 12TDO5-* 12TDO6-*	7 3/4 7 3/4 7 3/4	4 3/4 5 1/4 6 1/4	2 ¹ / ₁₆ 2 ¹ / ₁₆ 3 ¹ / ₄	3 ³ / ₈ 4 ¹ / ₁₆ 4 15/16	2 2 2	1/4 1/4 1/4	17 1/2 17 1/2 17 1/2	7 3/4 7 3/4 7 3/4	1/2 1/2 1/2	7/16 x 3/4 7/16 x 3/4 7/16 x 3/4	12 12 12
14	2 1/16 3	14TDO5-* 14TDO6-*	9 3/4 9 3/4	5 5/16 6 5/16	2 ¹ / ₁₆ 3 ¹ / ₄	4 ¹ / ₁₆ 4 15/16	2 2	1/4 1/4	19 3/4 19 3/4	9 3/4 9 3/4	1/2 1/2	7/16 x 3/4 7/16 x 3/4	17 17
16	3	16TDO6-*	10 5/8	6 5/16	3 15/16	5	2	5/16	21 1/8	10 5/8	5/8	7/16 x 7/8	26
18	3 3 1/16	18TDO6-* 18TDO7-*	12 1/2 12 1/2	6 3/8 7 3/8	3 3/16 4 1/16	5 5 5/16	2 2	3/8 3/8	23 1/2 23 1/2	12 1/2 12 1/2	5/8 5/8	7/16 x 7/8 7/16 x 7/8	33 33
20	3 3 1/16	20TDO6-* 20TDO7-*	13 1/2 13 1/2	6 3/8 7 3/8	3 3/8 4 3/8	5 1/16 5 5/8	2 2	3/8 3/8	26 3/8 26 3/8	13 1/2 13 1/2	5/8 5/8	7/16 x 7/8 7/16 x 7/8	55 55
24	3 1/16	24TDO7-*	16 1/2	7 3/8	4 3/8	5 5/8	2	3/8	30 1/2	16 1/2	5/8	7/16 x 7/8	81

Inside Discharge

Inside discharge trough ends are used to support end bearing and will allow material to discharge or overflow through the end of the trough. This trough end is used inside the trough where no trough end flanges are required. Drilling for three bolt bronze or flanged ball bearing is standard.

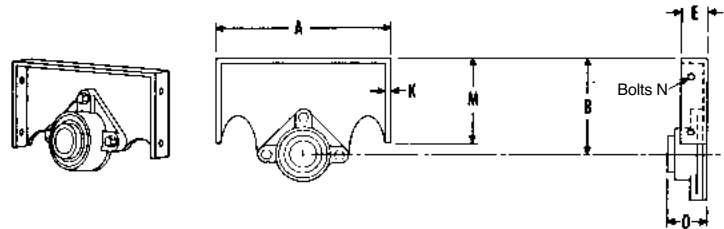

Conveyor Diameter	Shaft Diameter	Part Number	A	B	D			E	K	M	N	Weight
					Friction Bearing	Ball Bearing	Roller Bearing					
4	1	4TDI2-*	5	3 ³ / ₈	2 ¹ / ₁₆	1 ¹ / ₈	2	1/4	3 ³ / ₈	3/8	2	
6	1 1/2	6TDI3-*	7	4 1/2	3 ³ / ₁₆	2 ¹ / ₁₆	3 1/16	2	1/4	4 1/2	3/8	3
9	1 1/2 2	9TDI3-* 9TDI4-*	10 10	6 ¹ / ₈ 6 ¹ / ₈	3 ¹ / ₄ 4 ¹ / ₄	2 ¹ / ₁₆ 2 ¹ / ₂	3 1/16 3 3/16	2 2	1/4 1/4	6 ¹ / ₈ 6 ¹ / ₈	3/8 3/8	5 5
10	1 1/2 2	10TDI3-* 10TDI4-*	11 11	6 ³ / ₈ 6 ³ / ₈	3 ¹ / ₄ 4 ¹ / ₄	2 ¹ / ₁₆ 2 ¹ / ₂	3 1/16 3 3/16	2 2	1/4 1/4	6 ³ / ₈ 6 ³ / ₈	3/8 3/8	6 6
12	2 2 1/16 3	12TDI4-* 12TDI5-* 12TDI6-*	13 13 13	7 3/4 7 3/4 7 3/4	4 3/4 5 1/4 6 1/4	2 ¹ / ₁₆ 2 ¹ / ₁₆ 3 ¹ / ₄	3 ³ / ₈ 4 ¹ / ₁₆ 4 15/16	2 2 2	1/4 1/4 1/4	7 3/4 7 3/4 7 3/4	1/2 1/2 1/2	12 12 12
14	2 1/16 3	14TDI5-* 14TDI6-*	15 15	9 3/4 9 3/4	5 5/16 6 5/16	2 ¹ / ₁₆ 3 ¹ / ₄	4 ¹ / ₁₆ 4 15/16	2 2	1/4 1/4	9 3/4 0.9 3/4	5/8 5/8	16 16
16	3	16TDI6-*	17	10 5/8	6 5/16	3 3/16	5	2	5/16	10 5/8	5/8	25
18	3 3 1/16	18TDI6-* 18TDI7-*	19 19	12 1/2 12 1/2	6 3/8 7 3/8	3 3/16 4 1/16	5 5 5/16	2 2	3/8 3/8	12 1/2 12 1/2	5/8 5/8	32 32
20	3 3 1/16	20TDI6-* 20TDI7-*	21 21	13 1/2 13 1/2	6 3/8 7 3/8	3 3/8 4 3/8	5 1/16 5 5/8	2 2	3/8 3/8	13 1/2 13 1/2	5/8 5/8	50 50
24	3 1/16	24TDI7-*	25	16 1/2	7 3/8	4 3/8	5 5/8	2	3/8	16 1/2	5/8	76

-*BB Ball Bearing
-*BR Bronze Bearing
-*RB Roller Bearing
-*P Less Bearing

Trough Ends



Outside

Outside tubular trough ends less feet are used to support end bearings on tubular trough where no foot or support is required. Drilling for bronze or flanged ball bearing is standard.

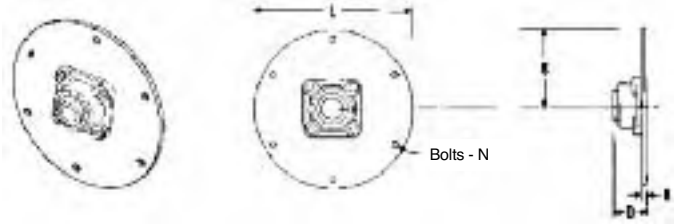

Conveyor Diameter	Shaft Diameter	Part Number	B	D			K	L	N	Weight
				Friction Bearing	Ball Bearing	Roller Bearing				
4	1	4CHTE2-*	4	2 ³ / ₁₆	1 ⁵ / ₁₆		1/4	8	3/8	2
6	1 1/2	6CHTE3-*	5 1/16	3 ³ / ₁₆	2 ³ / ₁₆	3 ¹ / ₁₆	1/4	10 1/8	3/8	3
9	1 1/2	9CHTE3-*	6 5/8	3 3/4	2 ³ / ₁₆	3 ¹ / ₁₆	1/4	13 3/4	3/8	6
	2	9CHTE4-*	6 5/8	4 1/4	2 1/2	3 ³ / ₁₆	1/4	13 3/4	3/8	6
10	1 1/2	10CHTE3-*	7 5/8	3 3/4	2 ³ / ₁₆	3 ¹ / ₁₆	1/4	14 3/4	3/8	7
	2	10CHTE4-*	7 5/8	4 1/4	2 1/2	3 ³ / ₁₆	1/4	14 3/4	3/8	7
12	2	12CHTE4-*	8 5/8	4 1/4	2 ³ / ₁₆	3 ³ / ₈	1/4	16 1/4	1/2	13
	2 1/16	12CHTE5-*	8 5/8	5 1/4	2 ³ / ₁₆	4 ⁷ / ₁₆	1/4	16 1/4	1/2	13
	3	12CHTE6-*	8 5/8	6 1/4	3 ³ / ₈	4 ¹⁵ / ₁₆	1/4	16 1/4	1/2	13
14	2 1/16	14CHTE5-*	9 5/8	5 5/16	2 ³ / ₁₆	4 ⁷ / ₁₆	1/4	18 1/4	1/2	19
	3	14CHTE6-*	9 5/8	6 5/16	3 3/4	4 ¹⁵ / ₁₆	1/4	18 1/4	1/2	19
16	3	16CHTE6-*	10 5/8	6 5/16	3 ³ / ₁₆	5	5/16	21 1/4	5/8	29
	3 3/16	18CHTE6-*	12 1/2	7 5/8	4 ¹ / ₁₆	5 5/16	3/8	24 1/4	5/8	39
18	3	18CHTE7-*	12 1/2	7 5/8	4 ¹ / ₁₆	5 5/16	3/8	24 1/4	5/8	39
	3 3/16	20CHTE6-*	13 1/2	6 5/8	3 3/8	5 1/16	3/8	26 1/4	5/8	63
20	3	20CHTE7-*	13 1/2	7 5/8	4 3/8	5 5/8	3/8	26 1/4	5/8	63
	3 3/16	24CHTE7-*	15 1/2	7 5/8	4 3/8	5 5/8	3/8	30 1/4	5/8	87

Outside with Feet

Outside tubular trough ends with feet are used to support end bearing where trough support is required. Drilling for bronze bearing or flanged ball bearing is standard.

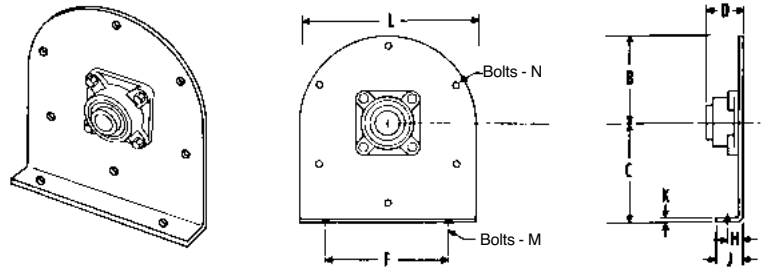

Conveyor Diameter	Shaft Diameter	Part Number	B	C	D			F	H	J	K	L	M	N	Weight
					Friction Bearing	Ball Bearing	Roller Bearing								
4	1	4CHTEF2-*	4	4 5/8	2 ³ / ₁₆	1 ⁵ / ₁₆		5 3/4	1	1 1/8	1/4	8	3/8	3/8	3
6	1 1/2	6CHTEF3-*	5 1/16	5 5/8	3 ³ / ₁₆	2 ³ / ₁₆	3 ¹ / ₁₆	8 5/8	1	1 1/4	1/4	10 1/8	3/8	3/8	5
9	1 1/2	9CHTEF3-*	6 5/8	7 5/8	3 3/4	2 ³ / ₁₆	3 ¹ / ₁₆	9 5/8	1 1/2	2 1/8	1/4	13 3/4	1/2	3/8	10
	2	9CHTEF4-*	6 5/8	7 5/8	4 1/4	2 1/2	3 ³ / ₁₆	9 5/8	1 1/2	2 1/8	1/4	13 3/4	1/2	3/8	10
10	1 1/2	10CHTEF3-*	7 5/8	8 5/8	3 3/4	2 ³ / ₁₆	3 ¹ / ₁₆	9 1/2	1 1/4	2 1/8	1/4	14 3/4	1/2	3/8	12
	2	10CHTEF4-*	7 5/8	8 5/8	4 1/4	2 1/2	3 ³ / ₁₆	9 1/2	1 1/4	2 1/8	1/4	14 3/4	1/2	3/8	12
12	2	12CHTEF4-*	8 5/8	9 5/8	4 1/4	2 ³ / ₁₆	3 ³ / ₈	12 1/4	1 5/8	2 3/4	1/4	16 1/4	5/8	1/2	22
	2 1/16	12CHTEF5-*	8 5/8	9 5/8	5 1/4	2 ³ / ₁₆	4 ⁷ / ₁₆	12 1/4	1 5/8	2 3/4	1/4	16 1/4	5/8	1/2	22
	3	12CHTEF6-*	8 5/8	9 5/8	6 1/4	3 ³ / ₈	4 ¹⁵ / ₁₆	12 1/4	1 5/8	2 3/4	1/4	16 1/4	5/8	1/2	22
14	2 1/16	14CHTEF5-*	9 5/8	10 5/8	5 5/16	2 ³ / ₁₆	4 ⁷ / ₁₆	13 1/2	1 5/8	2 3/4	1/4	18 1/4	5/8	1/2	24
	3	14CHTEF6-*	9 5/8	10 5/8	6 5/16	3 3/4	4 ¹⁵ / ₁₆	13 1/2	1 5/8	2 3/4	1/4	18 1/4	5/8	1/2	24
16	3	16CHTEF6-*	10 5/8	12	6 5/16	3 ³ / ₁₆	5	14 5/8	2	3 3/4	5/16	21 1/4	5/8	5/8	44
	3 3/16	18CHTEF6-*	12 1/2	13 5/8	6 5/8	3 ³ / ₁₆	5	16	2	3 3/4	3/8	24 1/4	5/8	5/8	56
18	3	18CHTEF7-*	12 1/2	13 5/8	7 5/8	4 ¹ / ₁₆	5 5/16	16	2	3 3/4	3/8	24 1/4	5/8	5/8	56
	3 3/16	20CHTEF6-*	13 1/2	15	6 5/8	3 3/8	5 1/16	19 1/4	2 1/4	3 3/4	3/8	26 1/4	3/4	3/8	92
20	3	20CHTEF7-*	13 1/2	15	7 5/8	4 3/8	5 5/8	19 1/4	2 1/4	3 3/4	3/8	26 1/4	3/4	3/8	92
	3 3/16	24CHTEF7-*	15 1/2	18 1/2	7 5/8	4 3/8	5 5/8	20	2 1/2	4 3/8	3/8	30 1/4	3/4	3/8	134

-*BB Ball Bearing
-*RB

-*BR Bronze Bearing
Roller Bearing

For Bolt Pattern see Page H-43

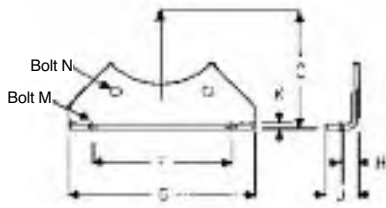

Flange Foot

Trough feet are used to support trough at trough connections.

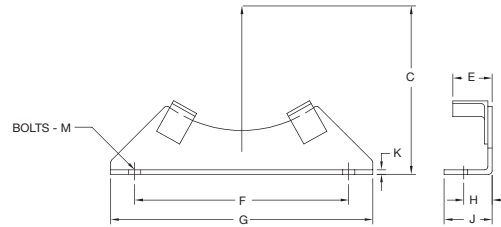

Saddle

Trough saddles are used to support trough where flange feet cannot be used at connections.

Conveyor Diameter	Part Number				Weight				
	Saddle		Flange Foot		Saddle		Flange Foot		
4	4TS		4TFF		1.5		1.5		
6	6TS		6TFF		2.0		2.0		
9	9TS		9TFF		4.5		4.5		
10	10TS		10TFF		5.0		5.0		
12	12TS		12TFF		6.0		6.0		
14	14TS		14TFF		7.0		7.0		
16	16TS		16TFF		8.0		7.5		
18	18TS		18TFF		10		9.5		
20	20TS		20TFF		13		12.5		
24	24TS		24TFF		15		14.5		

Conveyor Diameter	C	E	F	G	H	J	K	M*	N
4	4 $\frac{5}{8}$	1 $\frac{1}{16}$	5 $\frac{5}{8}$	7 $\frac{7}{8}$	1	1 $\frac{1}{8}$	$\frac{3}{16}$	$\frac{3}{8}$	$\frac{3}{8}$
6	5 $\frac{1}{8}$	1 $\frac{3}{16}$	8 $\frac{1}{8}$	10	1 $\frac{1}{4}$	2	$\frac{3}{16}$	$\frac{3}{8}$	$\frac{3}{8}$
9	7 $\frac{1}{8}$	1 $\frac{1}{2}$	9 $\frac{1}{8}$	12	1 $\frac{1}{2}$	2 $\frac{5}{8}$	$\frac{3}{16}$	$\frac{1}{2}$	$\frac{3}{8}$
10	8 $\frac{1}{8}$	1 $\frac{1}{2}$	9 $\frac{1}{2}$	12 $\frac{1}{2}$	1 $\frac{1}{4}$	2 $\frac{1}{2}$	$\frac{3}{16}$	$\frac{1}{2}$	$\frac{3}{8}$
12	9 $\frac{1}{8}$	1 $\frac{1}{2}$	12 $\frac{1}{4}$	15	1 $\frac{1}{8}$	2 $\frac{3}{4}$	$\frac{1}{4}$	$\frac{3}{8}$	$\frac{1}{2}$
14	10 $\frac{1}{8}$	1 $\frac{3}{4}$	13 $\frac{1}{2}$	16 $\frac{1}{2}$	1 $\frac{3}{8}$	2 $\frac{1}{2}$	$\frac{1}{4}$	$\frac{5}{8}$	$\frac{1}{2}$
16	12	1 $\frac{1}{4}$	14 $\frac{1}{4}$	18	2	3 $\frac{1}{4}$	$\frac{1}{4}$	$\frac{5}{8}$	$\frac{5}{8}$
18	13 $\frac{1}{8}$	1 $\frac{3}{4}$	16	19 $\frac{1}{8}$	2	3 $\frac{1}{4}$	$\frac{1}{4}$	$\frac{5}{8}$	$\frac{5}{8}$
20	15	2 $\frac{1}{4}$	19 $\frac{1}{4}$	22 $\frac{3}{4}$	2 $\frac{1}{4}$	3 $\frac{3}{4}$	$\frac{1}{4}$	$\frac{5}{8}$	$\frac{5}{8}$
24	18 $\frac{1}{8}$	2 $\frac{1}{4}$	20	24	2 $\frac{1}{4}$	4	$\frac{1}{4}$	$\frac{5}{8}$	$\frac{5}{8}$

*Holes for Bolt M Slotted

① Add -F for Fitted

CONVEYORS

Trough End Flanges

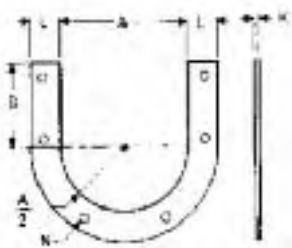

Size		A		B	K	L	N	Weight	Red Rubber Gasket
		Trough Thickness							
		Thru 10 Ga.	$\frac{3}{16}$ & $\frac{1}{4}$						
4	4TF*	5 $\frac{1}{4}$	5 $\frac{3}{8}$	3 $\frac{3}{8}$	$\frac{1}{4}$	1 $\frac{1}{4}$	$\frac{3}{8}$.09	4TFG
6	6TF*	7 $\frac{1}{4}$	7 $\frac{3}{8}$	4 $\frac{1}{4}$	$\frac{1}{4}$	1 $\frac{1}{2}$	$\frac{3}{8}$	1.5	6TFG
9	9TF*	10 $\frac{1}{4}$	10 $\frac{3}{8}$	5 $\frac{1}{4}$	$\frac{1}{4}$	1 $\frac{3}{4}$	$\frac{3}{8}$	2.4	9TFG
10	10TF*	11 $\frac{1}{4}$	11 $\frac{3}{8}$	6 $\frac{1}{4}$	$\frac{1}{4}$	1 $\frac{3}{4}$	$\frac{3}{8}$	2.6	10TFG
12	12TF*	13 $\frac{1}{4}$	13 $\frac{3}{8}$	7 $\frac{1}{2}$	$\frac{1}{4}$	2	$\frac{1}{2}$	5.6	12TFG
14	14TF*	15 $\frac{1}{4}$	15 $\frac{3}{8}$	9	$\frac{1}{4}$	2	$\frac{1}{2}$	6.5	14TFG
16	16TF*	17 $\frac{1}{4}$	17 $\frac{3}{8}$	10 $\frac{3}{8}$	$\frac{1}{4}$	2	$\frac{5}{8}$	7.4	16TFG
18	18TF*	19 $\frac{1}{4}$	19 $\frac{3}{8}$	11 $\frac{3}{16}$	$\frac{1}{4}$	2 $\frac{1}{2}$	$\frac{5}{8}$	10.2	18TFG
20	20TF*	21 $\frac{1}{4}$	21 $\frac{3}{8}$	13 $\frac{3}{16}$	$\frac{1}{4}$	2 $\frac{1}{2}$	$\frac{5}{8}$	11.3	20TFG
24	24TF*	25 $\frac{1}{4}$	25 $\frac{3}{8}$	16 $\frac{1}{2}$	$\frac{1}{4}$	2 $\frac{1}{2}$	$\frac{5}{8}$	15.5	24TFG

*-10 used for troughs through 10 ga., -3 used for troughs $\frac{3}{16}$ and $\frac{1}{4}$ thick.

**Subtract 1/8 when using plate trough.

End Bearings



KEEP THE HOUSING REPLACE THE INSERT.

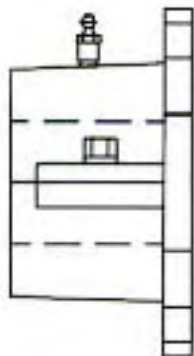
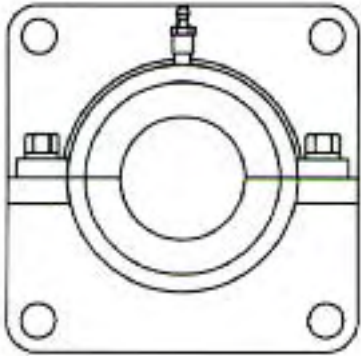

TEBH- Split Bearing Housings will help cut down on a plant's repair parts inventory, as well as the cost of the bearing. The rugged cast iron housing is not subject to wear, only the Style 220 Hanger bearing insert needs to be replaced.

The housings match CEMA standard ball bearing bolt pattern, so they can be used with most seals.

Split bearing housings are stocked in all *Martin* stocking facilities. Call your *Martin* distributor for more information.

TROUGH END BEARING HOUSINGS

Martin Split Bearing Housings utilize *Martin* Style 220 Hanger Bearings.

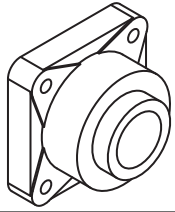
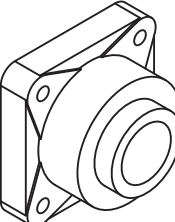
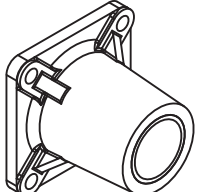
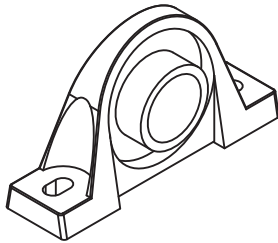
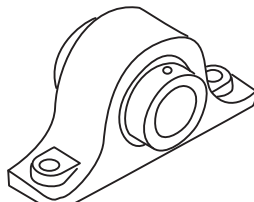
FLANGE UNITS	Mounted on trough end plate.		Ball Bearing Flange Unit
			Roller Bearing Flange Unit
			Bronze Sleeve Bearing Flange Unit
PILLOW BLOCKS	Mounted on pedestal of outboard bearing trough end.		Ball Bearing Pillow Block
			Roller Bearing Pillow Block

CONVEYORS

Bronze Flange Unit

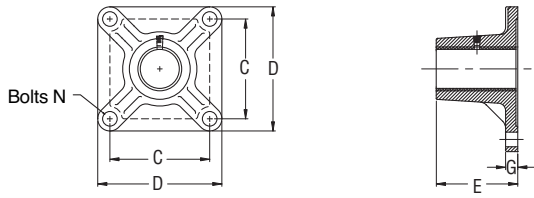

Bore	Part Number	C	D	E	G	N
1	TEB2BR	2 $\frac{3}{4}$	3 $\frac{3}{4}$	2	$\frac{7}{16}$	$\frac{3}{8}$
1 $\frac{1}{2}$	TEB3BR	4	5 $\frac{5}{8}$	3 $\frac{1}{4}$	$\frac{3}{4}$	$\frac{1}{2}$
2	TEB4BR	5 $\frac{1}{2}$	6 $\frac{1}{2}$	4 $\frac{1}{8}$	$\frac{7}{8}$	$\frac{5}{8}$
2 $\frac{1}{8}$	TEB5BR	5 $\frac{5}{8}$	7 $\frac{1}{8}$	4 $\frac{15}{16}$	1	$\frac{5}{8}$
3	TEB6BR	6	7 $\frac{3}{4}$	5 $\frac{11}{16}$	1 $\frac{1}{8}$	$\frac{3}{4}$
3 $\frac{1}{8}$	TEB7BR	6 $\frac{3}{4}$	9 $\frac{1}{4}$	6 $\frac{1}{4}$	1 $\frac{1}{4}$	$\frac{3}{4}$

Ball Bearing Discharge Unit

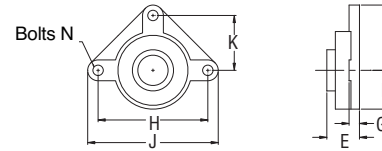

Bore	Part Number	E	G	H	J	K	L	M	N
1	TDB2BB	1 $\frac{1}{2}$	$\frac{1}{2}$	3 $\frac{3}{8}$	5 $\frac{3}{8}$	1 $\frac{15}{16}$	2 $\frac{11}{16}$	2	$\frac{3}{8}$
1 $\frac{1}{2}$	TDB3BB	2	$\frac{9}{16}$	5 $\frac{5}{8}$	7 $\frac{1}{4}$	2 $\frac{13}{16}$	3 $\frac{3}{8}$	2 $\frac{1}{2}$	$\frac{1}{2}$
2	TDB4BB	2 $\frac{1}{2}$	$\frac{5}{8}$	7 $\frac{1}{4}$	8	3 $\frac{3}{8}$	4	3	$\frac{5}{8}$
2 $\frac{1}{8}$	TDB5BB	2 $\frac{1}{2}$	$\frac{11}{16}$	8	9 $\frac{1}{8}$	4	4 $\frac{15}{16}$	3 $\frac{1}{2}$	$\frac{5}{8}$
3	TDB6BB	3 $\frac{1}{2}$	$\frac{7}{8}$	8 $\frac{1}{2}$	11	4 $\frac{1}{4}$	5 $\frac{1}{2}$	4	$\frac{3}{4}$
3 $\frac{1}{8}$	TDB7BB	4	1	9 $\frac{1}{2}$	12	4 $\frac{3}{4}$	6	4 $\frac{1}{2}$	$\frac{3}{4}$

Ball Bearing Flange Unit

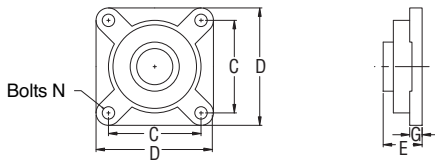

Bore	Part Number	C	D	E	G	N
1	TEB2BB	2 $\frac{3}{4}$	3 $\frac{3}{4}$	1 $\frac{1}{2}$	$\frac{1}{2}$	$\frac{3}{8}$
1 $\frac{1}{2}$	TEB3BB	4	5 $\frac{5}{8}$	2	$\frac{9}{16}$	$\frac{1}{2}$
2	TEB4BB	5 $\frac{1}{2}$	6 $\frac{1}{2}$	2 $\frac{1}{2}$	1 $\frac{1}{16}$	$\frac{5}{8}$
2 $\frac{1}{8}$	TEB5BB	5 $\frac{5}{8}$	7	2 $\frac{1}{2}$	1 $\frac{1}{16}$	$\frac{5}{8}$
3	TEB6BB	6	7 $\frac{3}{4}$	3 $\frac{1}{2}$	$\frac{7}{8}$	$\frac{3}{4}$
3 $\frac{1}{8}$	TEB7BB	6 $\frac{3}{4}$	8 $\frac{1}{8}$	4	1	$\frac{3}{4}$

Trough End Bearing Housing

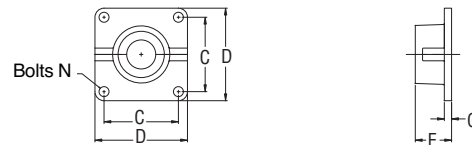

Bore	Part Number	C	D	E	G	N
1 $\frac{1}{2}$	TEBH3	4	5 $\frac{1}{4}$	2 $\frac{1}{2}$	$\frac{1}{2}$	$\frac{1}{2}$
2	TEBH4	5 $\frac{1}{2}$	6 $\frac{1}{2}$	2 $\frac{1}{2}$	$\frac{1}{2}$	$\frac{5}{8}$
2 $\frac{1}{8}$	TEBH5	5 $\frac{5}{8}$	6 $\frac{3}{8}$	3 $\frac{3}{8}$	$\frac{9}{16}$	$\frac{5}{8}$
3	TEBH6	6	7 $\frac{3}{4}$	3 $\frac{3}{8}$	$\frac{5}{8}$	$\frac{3}{4}$
3 $\frac{1}{8}$	TEBH7	7	9 $\frac{1}{4}$	4 $\frac{1}{4}$	$\frac{3}{4}$	$\frac{3}{4}$

Use #220 Type Hanger Bearings, See Page H-93.

Roller Bearing Flange Unit

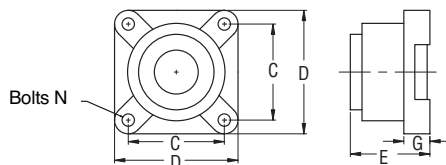

Bore	Part Number	C	D	E	G	N
1 $\frac{1}{2}$	TEB3R	4 $\frac{1}{8}$	5 $\frac{5}{8}$	3 $\frac{1}{2}$	1 $\frac{1}{16}$	$\frac{1}{2}$
2	TEB4R	4 $\frac{3}{4}$	5 $\frac{5}{8}$	3 $\frac{3}{8}$	1 $\frac{3}{16}$	$\frac{1}{2}$
2 $\frac{1}{8}$	TEB5R	5 $\frac{1}{8}$	6 $\frac{1}{8}$	4 $\frac{1}{8}$	1 $\frac{1}{2}$	$\frac{5}{8}$
3	TEB6R	6	7 $\frac{3}{4}$	4 $\frac{11}{16}$	1 $\frac{1}{8}$	$\frac{3}{4}$
3 $\frac{1}{8}$	TEB7R	7	9 $\frac{1}{4}$	5 $\frac{1}{4}$	1 $\frac{1}{8}$	$\frac{3}{4}$

Ball Bearing Pillow Block

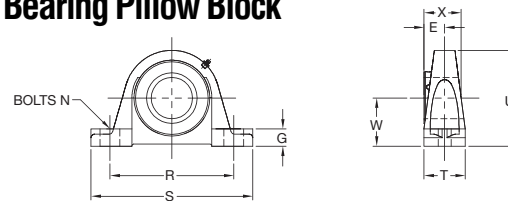

Bore	Part Number	E	G	N	R	S	T	U	W	X
1	TPB2BB	$\frac{49}{64}$	$\frac{37}{64}$	$\frac{3}{8}$	4 $\frac{1}{8}$	5 $\frac{1}{2}$	1 $\frac{13}{32}$	2 $\frac{25}{32}$	1 $\frac{1}{16}$	1 $\frac{1}{16}$
1 $\frac{1}{2}$	TPB3BB	1 $\frac{1}{32}$	$\frac{15}{16}$	$\frac{1}{2}$	5 $\frac{1}{2}$	7 $\frac{1}{4}$	1 $\frac{15}{16}$	4 $\frac{1}{16}$	2 $\frac{1}{8}$	1 $\frac{11}{16}$
2	TPB4BB	1 $\frac{1}{32}$	$\frac{3}{4}$	$\frac{5}{8}$	6 $\frac{1}{8}$	8 $\frac{1}{4}$	2 $\frac{1}{4}$	4 $\frac{17}{32}$	2 $\frac{1}{4}$	1 $\frac{1}{4}$
2 $\frac{1}{8}$	TPB5BB	1 $\frac{1}{16}$	$\frac{7}{8}$	$\frac{5}{8}$	7 $\frac{1}{8}$	9 $\frac{1}{2}$	2 $\frac{3}{8}$	5 $\frac{13}{32}$	2 $\frac{1}{4}$	1 $\frac{63}{64}$
3	TPB6BB	1 $\frac{1}{2}$	1 $\frac{1}{4}$	$\frac{7}{8}$	9	11 $\frac{1}{4}$	3	6 $\frac{31}{32}$	3 $\frac{1}{2}$	2 $\frac{31}{32}$
3 $\frac{1}{8}$	TPB7BB	1 $\frac{1}{16}$	1 $\frac{1}{16}$	$\frac{7}{8}$	11	14	3 $\frac{3}{8}$	8	4	2 $\frac{31}{64}$

Bronze Discharge Unit

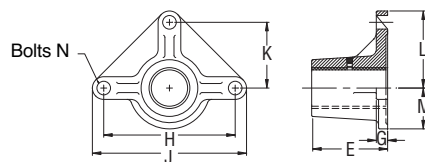

Bore	Part Number	E	G	H	J	K	L	M	N
1	TDB2BR	2	$\frac{1}{2}$	3 $\frac{3}{8}$	5 $\frac{3}{8}$	1 $\frac{15}{16}$	2 $\frac{11}{16}$	1	$\frac{3}{8}$
1 $\frac{1}{2}$	TDB3BR	3 $\frac{3}{4}$	$\frac{9}{16}$	5 $\frac{5}{8}$	7 $\frac{1}{4}$	2 $\frac{13}{16}$	3 $\frac{3}{8}$	1 $\frac{1}{4}$	$\frac{1}{2}$
2	TDB4BR	4 $\frac{3}{8}$	$\frac{5}{8}$	7 $\frac{1}{4}$	8	3 $\frac{3}{8}$	4	1 $\frac{1}{8}$	$\frac{5}{8}$
2 $\frac{1}{8}$	TDB5BR	4 $\frac{15}{16}$	$\frac{11}{16}$	8	9 $\frac{1}{8}$	4	4 $\frac{15}{16}$	1 $\frac{1}{8}$	$\frac{5}{8}$
3	TDB6BR	5 $\frac{11}{16}$	$\frac{7}{8}$	8 $\frac{1}{2}$	11	4 $\frac{1}{4}$	5 $\frac{1}{2}$	2 $\frac{1}{8}$	$\frac{3}{4}$
3 $\frac{1}{8}$	TDB7BR	6 $\frac{1}{4}$	1	9 $\frac{1}{2}$	12	4 $\frac{3}{4}$	6	2 $\frac{1}{2}$	$\frac{3}{4}$

Roller Bearing Pillow Block

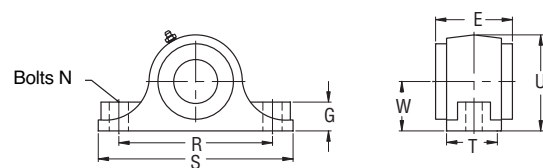

Bore	Part Number	E	G	N	R	S	T	U	W
1 $\frac{1}{2}$	TPB3R	3 $\frac{3}{8}$	1 $\frac{1}{4}$	$\frac{1}{2}$	6 $\frac{1}{4}$	7 $\frac{1}{8}$	2 $\frac{3}{8}$	4 $\frac{1}{4}$	2 $\frac{1}{8}$
2	TPB4R	3 $\frac{1}{2}$	1 $\frac{3}{8}$	$\frac{5}{8}$	7	8 $\frac{3}{8}$	2 $\frac{1}{2}$	4 $\frac{1}{2}$	2 $\frac{1}{4}$
2 $\frac{1}{8}$	TPB5R	4	1 $\frac{1}{8}$	$\frac{5}{8}$	8 $\frac{1}{2}$	10 $\frac{1}{2}$	2 $\frac{1}{8}$	5 $\frac{1}{2}$	2 $\frac{1}{4}$
3	TPB6R	4 $\frac{1}{2}$	1 $\frac{1}{8}$	$\frac{3}{4}$	9 $\frac{1}{2}$	12	3 $\frac{1}{8}$	6 $\frac{1}{4}$	3 $\frac{3}{8}$
3 $\frac{1}{8}$	TPB7R	5	2 $\frac{1}{4}$	$\frac{7}{8}$	11	14	3 $\frac{3}{8}$	7 $\frac{1}{2}$	3 $\frac{3}{4}$

Thrust Bearings

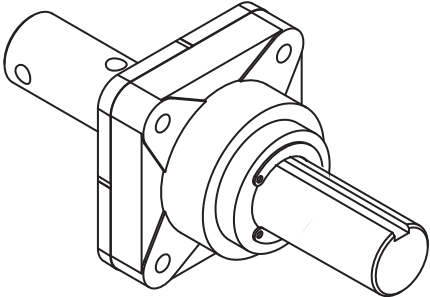
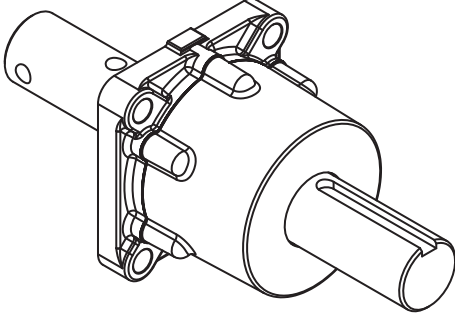
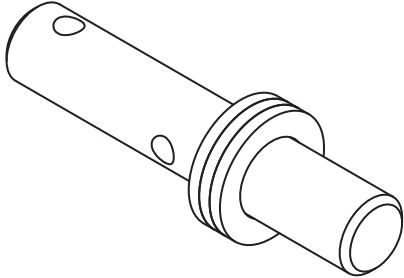

<p>TYPE E THRUST BEARINGS</p>	 A technical drawing of a Type E thrust bearing. It consists of a cylindrical shaft with a central hole, mounted on a rectangular housing. The housing has four mounting holes on its side and a circular flange at the end of the shaft.	<p>Most common and economical thrust unit when a screw conveyor type drive is not being used.</p>
<p>TYPE H THRUST BEARINGS</p>	 A technical drawing of a Type H thrust bearing. It features a cylindrical shaft with a central hole, mounted on a more complex housing. The housing has a circular flange and several mounting points, including a small bracket-like structure on top.	<p>For heavy duty thrust requirements.</p>
<p>BRONZE WASHER</p>	 A technical drawing of a bronze washer. It is a cylindrical component with a central hole and a slightly wider, flanged section in the middle.	<p>Light duty applications only. Used inside the trough and when screw used in compression.</p>

Type E Thrust Assembly

Type E roller thrust bearings are designed to carry thrust in both directions and carry radial load under normal conditions. This double roller bearing is furnished with a lip type seal plate and either drive or tail shaft whichever is applicable to conveyor design.

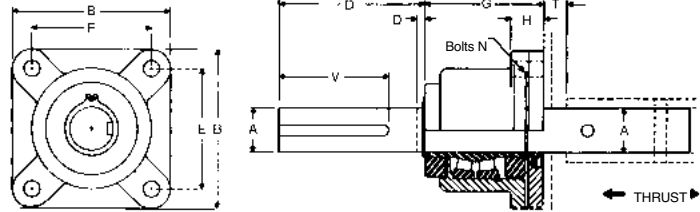

A Shaft Diameter	Part Number		B	D		E	G	H	N	T	V	Weight	
	Drive Shaft	End Shaft		Drive Shaft	End Shaft							Drive Shaft	End Shaft
1½	CT3D	CT3E	5½	4¼	¾	4½	4	1½/16	½	1¼	4	22	20
2	CT4D	CT4E	5½	5	¾	4½	4½	1½/16	½	1¼	4½	32	29
2½/16	CT5D	CT5E	6½	5½	¾	5½	4½/16	2	¾	1½/16	5	50	44
3	CT6D	CT6E	7¼	6½	¾	6	5½/16	2½	¾	1½	6	73	60
3½/16	CT7D	CT7E	9¼	7½	¾	7	6	2½	¾	2½	7	111	88

Heavy Duty RB End Thrust Bearings

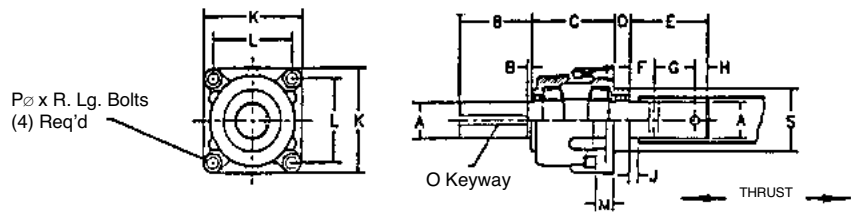

Dimensions in inches and average weight in pounds

A Shaft Dia.	With Drive Shaft		With Tail Shaft		B		C	D	E	F	G	H	J	K	L	M	O Keyway	P	R	S
	Part No.	Weight	Part No.	Weight	Drive Shaft	End Shaft														
1½	CTH3D	60	CTH3E	52	4½	¼	6¼	1½	4½	1	3	¾	½	7¼	5¼	1½/16	¾ x 4¼	¾	2½	4¾
2	CTH4D	65	CTH4E	56	4½	¼	6¼	1½	4½	1	3	¾	½	7¼	5¼	1½/16	½ x 4¼	¾	2½	4¾
2½/16	CTH5D	80	CTH5E	66	5½/16	¾/16	6¼	1¼	5½/16	1½	3	¾/16	¾/16	8	6¼	1½	¾ x 5¼	¾	3	5½
3	CTH6D	145	CTH6E	119	6½	¼	8¼	1½	5½	1½	3	1	¾	10	8	1¼	¾ x 5¼	1	3½	6
3½/16	CTH7D	170	CTH7E	140	7½	¾	8¼	1½	7½	2½	4	1¼	¾	10	8	1¼	¾ x 6¼	1	3½	6

Other shaft sizes available are 3½/16", 4½/16" & 4¾/16". Please consult factory.

Thrust Washers

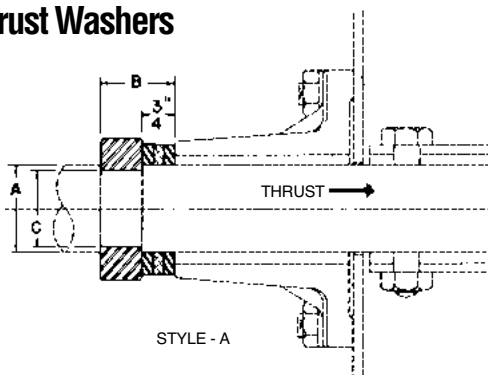

STYLE - A

Thrust washers are designed for use where light thrust loads prevail. Style A or B mounting may be used depending on direction of thrust. This unit consists of two steel washers separated by one bronze washer, and Style B is not recommended for use in conveyors handling abrasive materials.

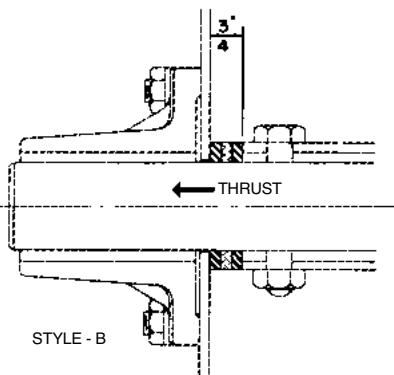

STYLE - B

A Size Shaft	Washers & Collar Style A		Washer Set Style B		B	C
	Part No.	Weight	Part No.	Weight		
1½	CTCW3	2.4	CTW3	1	1¼	1¼
2	CTCW4	2.8	CTW4	1.25	1½/16	1½
2½/16	CTCW5	3.9	CTW5	1.5	1½	2½
3	CTCW6	4.6	CTW6	2	1½	2¾
3½/16	CTCW7	6.1	CTW7	3	1½	3¼

Shaft Seals

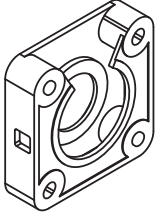
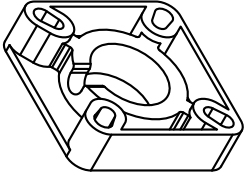
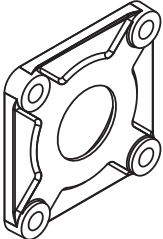
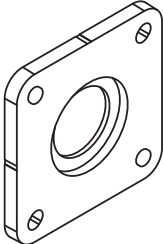
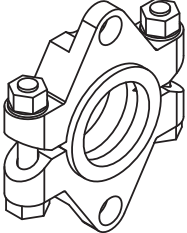
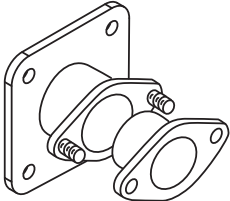
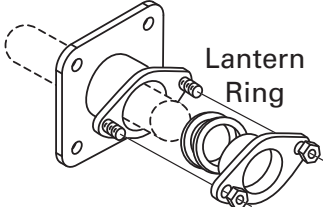
<p>WASTE PACK SEAL</p>		<p>Waste pack seals can be furnished with waste packing or in combination with lip seal. This type seal is normally installed between the trough end and bearing, but may be used separately on pedestal type trough ends. An opening is provided at top for repacking without removing seal from trough end. Can be used with flanged ball, roller or other standard 4-bolt bearings.</p>
<p><i>Martin</i> SUPER PACK SEAL</p>		<p><i>Martin</i> Super Pack Seal combines the heavy duty waste pack housing with the superior sealing characteristics of a Super Pack Seal. Seal may also be air or grease purged for difficult sealing applications.</p>
<p>PRODUCT DROP OUT SEAL</p>		<p>This flange type dust seal is designed for insertion between trough end and flanged ball bearing. The cast iron housing is open on all four sides for exit of material that might work past seal or lubricant from bearing.</p>
<p>PLATE SEAL</p>		<p>Plate seals are the most common and economical seal. It is normally furnished with a lip seal. This type seal is normally installed between the trough end and bearing, but may be used separately on pedestal type trough ends. Can be used with flanged ball, roller or other standard 4-bolt bearings.</p>
<p>SPLIT GLAND SEAL</p>		<p>Split gland compression type seals provide for easy replacement and adjustment of packing pressure on the shaft without removal of the conveyor. These seals can be installed inside or outside the end plates.</p>
<p>COMPRESSION TYPE PACKING GLAND SEAL</p>		<p>Flanged packing gland seals consist of an external housing and an internal gland which is forced into the housing to compress the packing. This is the most positive type shaft seal and may be used where minor pressure requirements are desired.</p>
<p>AIR PURGED SEAL</p>		<p>Air purge shaft seals are arranged for attaching to standard or special trough ends. A constant air pressure is maintained to prevent material from escaping from the trough along the shaft. The air purge seal is desirable for sealing highly abrasive materials. May be purged with grease or water.</p>

Compression Type Packing Gland Seal

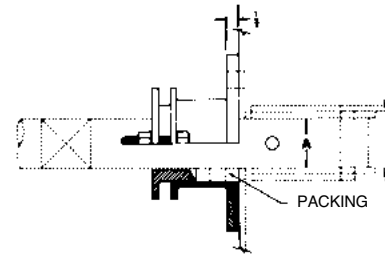
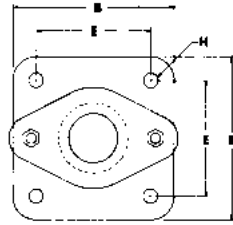

A Shaft Diameter	Part Number	B	E	H Bolts	Weight
1½	PGC3	5	4	½	14
2	PGC4	7½	5½	⅝	18
2⅞	PGC5	7½	5½	⅝	21
3	PGC6	8½	6	¾	27
3⅞	PGC7	9¼	6¾	¾	30

*Braided rope graphite packing is standard. Other types available on request.

Flanged gland seals consist of an external housing and an internal gland which is forced into the housing to compress the packing. This is the most positive type shaft seal and may be used where pressure requirements are desired.

Split Gland Seal

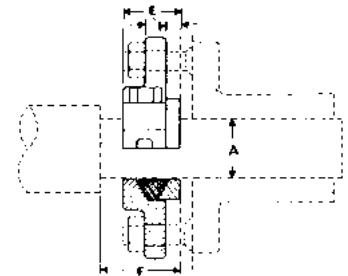
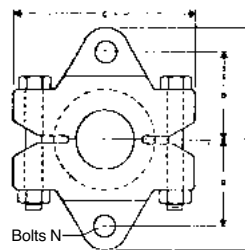

A Shaft Diameter	Part Number	C	D	E	F	G	H	N	Weight
1½	CSS3	4¼	2⅞	1⅞	2½	5⅞	⅞	½	5
2	CSS4	6¼	2⅞	1½	2½	6½	⅞	½	10
2⅞	CSS5	6⅞	3⅞	1⅞	3¼	7⅞	1	⅝	15
3	CSS6	7½	3⅞	1⅞	3¼	8⅞	1	⅝	22
3⅞	CSS7	8¼	4⅞	2⅞	3¼	10¼	1¼	¾	30

Split gland compression type seals provide for easy replacement and adjustment of packing pressure on the shaft without removal of the conveyor. These seals are normally installed inside the end plates.

Flanged Product Drop-Out Seal

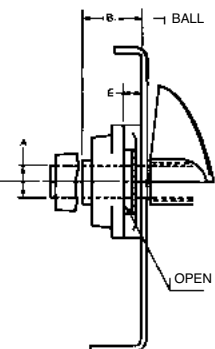
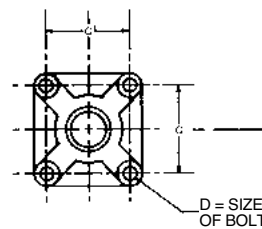

Dimensions in inches and average weight in pounds

A Shaft Diameter	Part Number	Weight	B ₁	C	E	D
1	CSFP2	1.75	2⅞	2¼	1⅞	⅝
1½	CSFP3	3.4	2 ⁵⁷ / ₆₄	4	⅞	½
2	CSFP4	5.3	3⅞	5⅞	⅞	⅝
2⅞	CSFP5	5.8	3⅞	5⅞	⅞	⅝
3	CSFP6	7.2	4⅞	6	⅞	¾
3⅞	CSFP7	—	4 ³¹ / ₃₂	6¾	1	¾

This flange type dust seal is designed for insertion between trough end and flanged bearing. The cast iron housing is open on all four sides for exit of material that might work past seal or lubricant from bearing.

Shaft Seals



Super Pack Seal

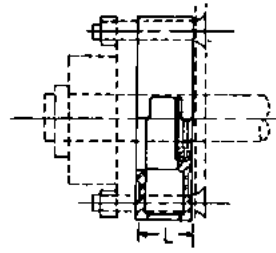
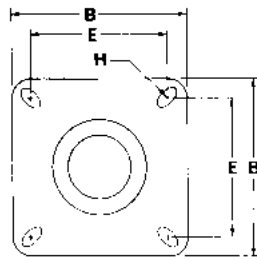

With Super Pack Seal

A Shaft	Part Number	B	L	E		H Bolts		Weight
				(-B)	(-R)	(-B)	(-R)	
1½	MSP3	5%	1¾	4	4½	½	½	6
2	MSP4	6½	1¾	5½	4%	¾	½	8
2⅞	MSP5	7%	1¾	5%	5%	¾	¾	10
3	MSP6	7%	1¾	6	6	¾	¾	13
3⅞	MSP7	9%	2¼	6%	7	¾	¾	16

Martin Super Pack Seal combines the heavy duty waste pack housing with the superior sealing characteristics of a Super Pack Seal. Seal may also be air or grease purged for difficult sealing applications.

Waste Pack Seal

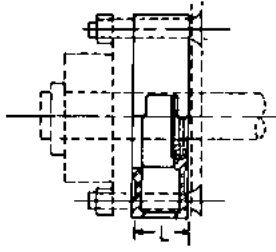
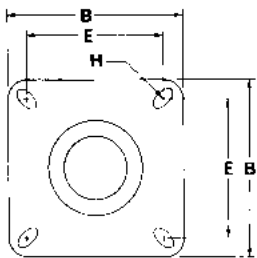

With Lip Seal

A Shaft	Part Number	B	L	E		H Bolts		Weight
				(-B)	(-R)	(-B)	(-R)	
1½	CSW3	5%	1¾	4	4½	½	½	6
2	CSW4	6½	1¾	5½	4%	¾	½	8
2⅞	CSW5	7%	1¾	5%	5%	¾	¾	10
3	CSW6	7%	1¾	6	6	¾	¾	13
3⅞	CSW7	9%	2¼	6%	7	¾	¾	16

Waste pack seals are furnished with waste packing in combination with lip seal. This type seal is normally installed between the trough end and bearing, but may be used separately on pedestal type trough ends. An opening is provided at top for repacking without removing seal from trough end.

Plate Seal

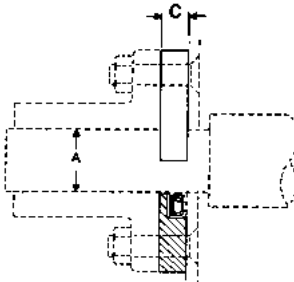
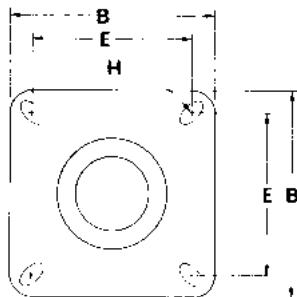
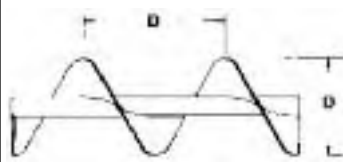

Plate seals are the most common and economical seal. They are furnished with a lip seal. This type seal is normally installed between the trough end and bearing, but may be used separately on pedestal type trough ends. Slotted mounting holes allow use with both ball and roller flanged bearings.

A Shaft Diameter	Part Number	B	C	E		H Bolts		Weight
				(-B)	(-R)	(-B)	(-R)	
1½	CSP3	5%	½	4	4½	½	½	2
2	CSP4	6½	½	5½	4%	¾	½	3
2⅞	CSP5	7%	½	5%	5%	¾	¾	4
3	CSP6	7%	½	6	6	¾	¾	5
3⅞	CSP7	9%	¾	6%	7	¾	¾	8

STANDARD PITCH, SINGLE FLIGHT



Conveyor screws with pitch equal to screw diameter are considered standard. They are suitable for a whole range of materials in most conventional applications.

TAPERED, STANDARD PITCH, SINGLE FLIGHT

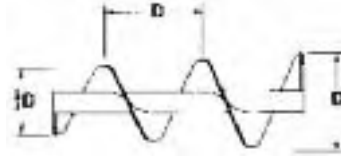

Price on Application

Screw flights increase from 2/3 to full diameter. Used in screw feeders to provide uniform withdrawal of lumpy materials. Generally equivalent to and more economical than variable pitch.

SHORT PITCH, SINGLE FLIGHT

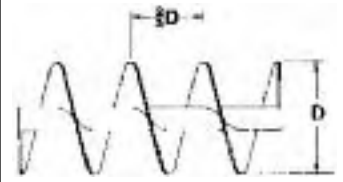

Flight pitch is reduced to 2/3 diameter. Recommended for inclined or vertical applications. Used in screw feeders. Shorter pitch reduces flushing of materials which fluidize.

SINGLE CUT-FLIGHT, STANDARD PITCH

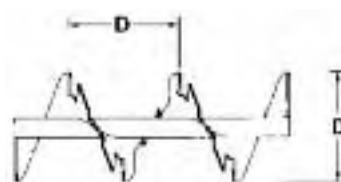

Screws are notched at regular intervals at outer edge. Affords mixing action and agitation of material in transit. Useful for moving materials which tend to pack.

HALF PITCH, SINGLE FLIGHT

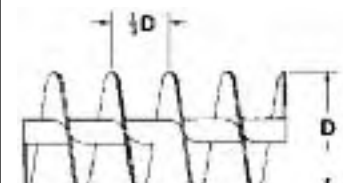

Similar to short pitch except pitch is reduced to 1/2 standard pitch. Useful for inclined applications, for screw feeders and for handling extremely fluid materials.

CUT & FOLDED FLIGHT, STANDARD PITCH

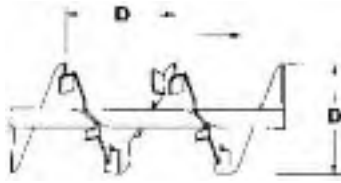

Folded flight segments lift and spill the material. Partially retarded flow provides thorough mixing action. Excellent for heating, cooling or aerating light substances.

END DISC ON CONVEYOR SCREW

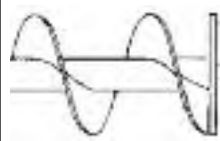

Price on Application

An end disc is the same diameter as the screw and is welded flush with the end of the pipe shaft at its discharge end and, of course, rotates with the screw. The end disc helps to keep discharging material away from the trough end seal.

SINGLE FLIGHT RIBBON

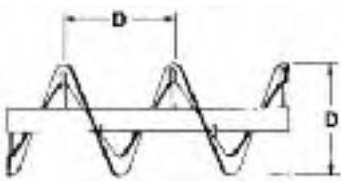

Price on Application

Excellent for conveying sticky or viscous materials. Open space between flighting and pipe eliminate collection and build-up of material.

VARIABLE PITCH, SINGLE FLIGHT

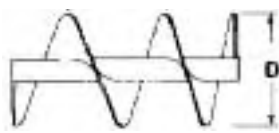

Price on Application

Flights have increasing pitch and are used in screw feeders to provide uniform withdrawal of fine, free flowing materials over the full length of the inlet opening.

STANDARD PITCH WITH PADDLES

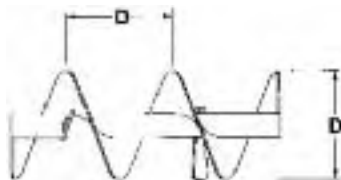

Adjustable paddles positioned between screw flights opposed flow to provide gentle but thorough mixing action.

DOUBLE FLIGHT, STANDARD PITCH

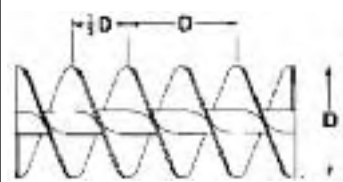

Double flight, standard pitch screws provide smooth regular material flow and uniform movement of certain types or materials.

PADDLE

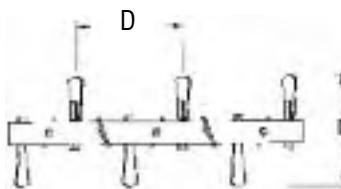

Adjustable paddles provide complete mixing action, and controlled material flow.

Conveyor Screws

Helicoid flights are formed in a special rolling machine by forming a steel strip into a continuous one-piece helix of the desired diameter, pitch and thickness to fit conveyor screw pipes. The helicoid flight is tapered in cross section, with the thickness at the inner edge approximately twice the thickness of the outer edge.

Sectional flights are individual flights or turns blanked from steel plates and formed into a spiral or helix of the desired diameter and pitch to fit conveyor screw pipes. The flights are butt welded together to form a continuous conveyor screw. Modifications can be furnished, such as, fabrication from various metals, different flight thicknesses, other diameters and pitches. The butt weld flight is the same thickness in the full cross section.



Helicoid Flight



Sectional Flight

Key to Conveyor Size Designation

The letter "H" indicates screw conveyor with helicoid flighting. The figures to the left of the letters indicate the nominal outside diameter of the conveyor in inches. The first figure following the letters is twice the diameter of the couplings in inches. The last two figures indicate the nominal thickness of flighting at the outer edge in $\frac{1}{64}$ ". Thus conveyor 12H408 indicates 12" diameter helicoid conveyor for 2" couplings with flighting $\frac{3}{64}$ " or $\frac{1}{8}$ " thickness at outer edge. Hand of conveyor is indicated by "R" or "L" following the designation.

Comparison Table • helicoid flight and sectional flight conveyor screws

Screw Diameter, Inches	Helicoid Flight						Sectional Flight			
	Conveyor Screw Size Designation ▲	Former Designation	Coupling Diameter, Inches	Nominal Inside Diameter of Pipe, Inches	Thickness of Flight, Inches		Conveyor Screw Size Designation ▲	Coupling Diameter, Inches	Nominal Inside Diameter of Pipe, Inches	Thickness of Flight
					Inner Edge	Outer Edge				
4	4H206	4X	1	1¼	⅜	⅝				
6	6H304	6 Standard	1½	2	¼	⅙	6S309 6S312	1½	2	10 ga. ⅙ in.
	6H308	6 X	1½	2	¼	⅙				
	6H312	6 XX	1½	2	⅜	⅙				
9	9H306	9 Standard	1½	2	⅜	⅝	9S307 9S407 9S312 9S412 9S416	1½	2	12 ga. 12 ga. ⅜ in. ⅜ in. ¼ in.
	9H406	9 Special	2	2½	⅜	⅝				
	9H312	9 X	1½	2	⅜	⅙				
	9H412	9 XX	2	2½	⅜	⅙				
	9H414	—	2	2½	⅞	⅝				
10	10H306	10 Standard	1½	2	⅜	⅝	10S309 10S412	1½	2	10 ga. ⅜ in.
	10H412	10 XX	2	2½	⅜	⅙				
12	12H408	12 Standard	2	2½	¼	⅙	12S409 12S509 12S412 12S512 12S616	2	2½	10 ga. 10 ga. ⅜ in. ⅜ in. ¼ in.
	12H508	12 Special	2⅞	3	¼	⅙				
	12H412	12 X	2	2½	⅜	⅙				
	12H512	12 XX	2⅞	3	⅜	⅙				
	12H614	—	3	3½	⅞	⅝				
	14H508	14 Standard	2⅞	3	¼	⅙				
14H614	14 XX	3	3½	⅞	⅝					
16	16H610	16 Standard	3	3½	⅜	⅝	16S609 16S616	3	3½	10 ga. ¼ in.
	16H614	—	3	4	⅞	⅝				

▲ Size designation: Examples: 12H412 and 12S412.
 12 = screw diameter in inches
 H = helicoid flight
 S = sectional flight
 4 = 2 times 2" coupling diameter
 12 = thickness of flight at periphery in increments of $\frac{1}{64}$ "

CONVEYORS

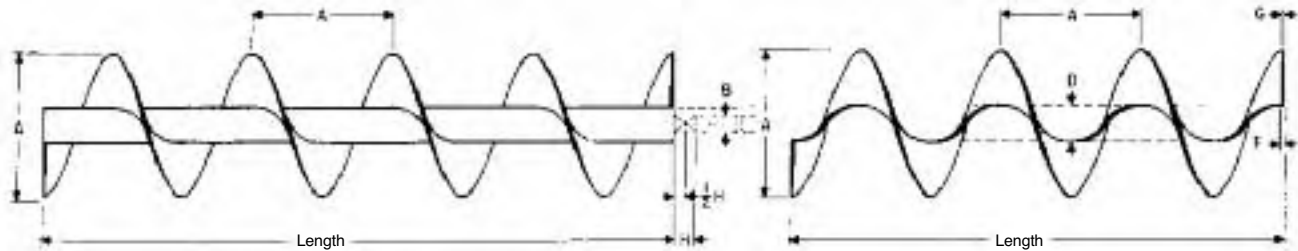

Helicoid Conveyor Screw

Flighting

Screw Diameter	Coupling Diameter	Size Part No. Conveyor Mounted	Size Part No. Flighting Only	D Pipe Size		Flight Thickness		H Coupling Bearing Length	Standard Length Feet-Inches	Average Weight			
				Nominal Inside	Outside	F	G			Complete Screw		Flighting Only	
						Inside	Outside			Standard Length	Per Foot	Standard Length	Per Foot
4	1	4H206 ^{-*}	4HF206 ^{-*}	1¼	1½	⅜	⅜	1½	9-10½	40	4	16	1.3
6	1½	6H304 ^{-*}	6HF304 ^{-*}	2	2½	⅜	⅜	2	9-10	52	5	14	1.4
	1½	6H308 ^{-*}	6HF308 ^{-*}	2	2½	¼	⅜	2	9-10	62	6	28	2.8
	1½	6H312 ^{-*}	6HF312 ^{-*}	2	2½	⅜	⅜	2	9-10	72	7	42	4.3
9	1½	9H306 ^{-*}	9HF306 ^{-*}	2	2½	⅜	⅜	2	9-10	70	7	31	3.2
	1½	9H312 ^{-*}	9HF312 ^{-*}	2	2½	⅜	⅜	2	9-10	101	10	65	6.1
	2	9H406 ^{-*}	9HF406 ^{-*}	2½	2½	⅜	⅜	2	9-10	91	9	30	3.0
	2	9H412 ^{-*}	9HF412 ^{-*}	2½	2½	⅜	⅜	2	9-10	121	12	60	6.6
	2	9H414 ^{-*}	9HF414 ^{-*}	2½	2½	⅜	⅜	2	9-10	131	13	70	6.3
10	1½	10H306 ^{-*}	10HF306 ^{-*}	2	2½	⅜	⅜	2	9-10	81	8	48	4.9
	2	10H412 ^{-*}	10HF412 ^{-*}	2½	2½	⅜	⅜	2	9-10	130	13	76	7.7
12	2	12H408 ^{-*}	12HF408 ^{-*}	2½	2½	¼	⅜	2	11-10	140	12	67	5.7
	2	12H412 ^{-*}	12HF412 ^{-*}	2½	2½	⅜	⅜	2	11-10	180	15	102	8.6
	2½	12H508 ^{-*}	12HF508 ^{-*}	3	3½	¼	⅜	3	11-9	168	14	64	5.4
	2½	12H512 ^{-*}	12HF512 ^{-*}	3	3½	⅜	⅜	3	11-9	198	17	96	8.2
14	3	12H614 ^{-*}	12HF614 ^{-*}	3½	4	⅜	⅜	3	11-9	220	18	112	9.3
	2½	14H508 ^{-*}	14HF508 ^{-*}	3	3½	¼	⅜	3	11-9	170	14	84	7.1
16	3	14H614 ^{-*}	14HF614 ^{-*}	3½	4	⅜	⅜	3	11-9	254	22	132	11.2
	3	16H610 ^{-*}	16HF610 ^{-*}	3½	4	⅜	⅜	3	11-9	228	19	120	10.0
▲	3	16H614 ^{-*}	16HF614 ^{-*}	4	4½	⅜	⅜	3	11-9	285	24	154	11.7
18 ▲	3	18H610 ^{-*}	18HF610 ^{-*}	3½	4	⅜	⅜	3	11-9	282	24	167	13.9

^{-*} R For Right Hand

^{-*} L For Left Hand

▲ Offered only in full pitch helicoid flighting.

Conveyor Screws (Sectional)

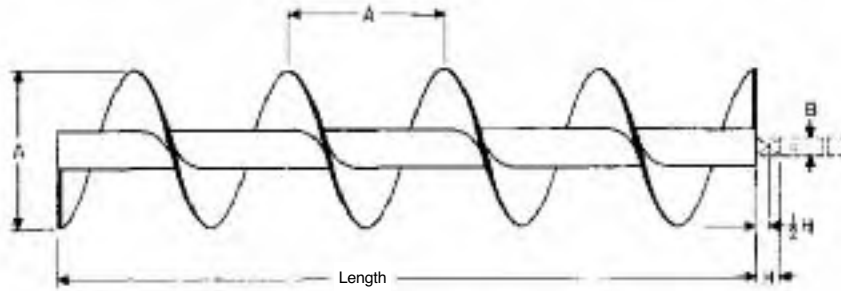

Sectional Conveyor Screw

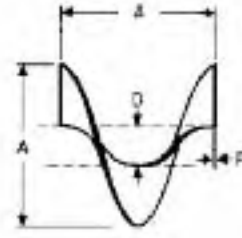

Flight

A	B	Size Part No. Mounted Conveyor	Size Part No. Fighting Only	Pipe Size		F	H	Standard Length Feet-Inches	Average Weight			Approx. Flights Per Foot
				Inside	D Outside	Flight Thickness	Coupling Bearing Length		Standard Length	Per Foot	Flight Each	
6	1½	6S312-*	6SF312-*	2	2¾	⅜	2	9-10	75	7.5	1.7	2.0
	1½	6S316-*	6SF316-*	2	2¾	¼	2	9-10	90	8.0	2.2	2.0
9	1½	9S312-*	9SF312-*	2	2¾	⅜	2	9-10	95	9.5	4.3	1.33
	1½	9S316-*	9SF316-*	2	2¾	¼	2	9-10	130	13.0	5.5	1.33
	1½	9S324-*	9SF324-*	2	2¾	⅜	2	9-10	160	16.0	7.9	1.33
	2	9S412-*	9SF412-*	2½	2¾	⅜	2	9-10	115	11.5	4.3	1.33
	2	9S416-*	9SF416-*	2½	2¾	¼	2	9-10	130	13.0	5.5	1.33
	2	9S424-*	9SF424-*	2½	2¾	⅜	2	9-10	160	16.0	7.9	1.33
10	1½	10S312-*	10SF312-*	2	2¾	⅜	2	9-10	120	12.0	5.0	1.2
	1½	10S316-*	10SF316-*	2	2¾	¼	2	9-10	135	13.5	6.7	1.2
	1½	10S324-*	10SF324-*	2	2¾	⅜	2	9-10	165	16.5	8.7	1.2
	2	10S412-*	10SF412-*	2½	2¾	⅜	2	9-10	120	12.0	5.0	1.2
	2	10S416-*	10SF416-*	2½	2¾	¼	2	9-10	135	13.5	6.7	1.2
	2	10S424-*	10SF424-*	2½	2¾	⅜	2	9-10	165	16.5	8.7	1.2
12	2	12S412-*	12SF412-*	2½	2¾	⅜	2	11-10	156	13.0	7.2	1.0
	2	12S416-*	12SF416-*	2½	2¾	¼	2	11-10	204	17.0	9.7	1.0
	2	12S424-*	12SF424-*	2½	2¾	⅜	2	11-10	268	22.3	12.7	1.0
	2⅞	12S509-*	12SF509-*	3	3½	10 Ga.	3	11-9	160	14.0	5.7	1.0
	2⅞	12S512-*	12SF512-*	3	3½	⅜	3	11-9	178	14.8	7.2	1.0
	2⅞	12S516-*	12SF516-*	3	3½	¼	3	11-9	210	17.5	9.7	1.0
	2⅞	12S524-*	12SF524-*	3	3½	⅜	3	11-9	274	22.5	12.7	1.0
	3	12S612-*	12SF612-*	3½	4	⅜	3	11-9	198	16.5	7.2	1.0
	3	12S616-*	12SF616-*	3½	4	¼	3	11-9	216	18.0	9.7	1.0
	3	12S624-*	12SF624-*	3½	4	⅜	3	11-9	280	24.0	12.7	1.0

-* R For Right Hand
-* L For Left Hand

CONVEYORS

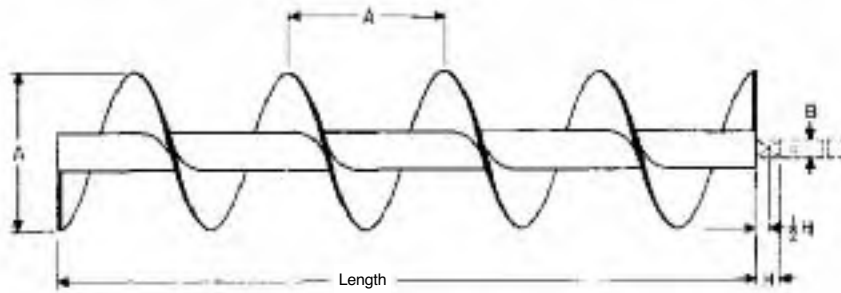

Sectional Conveyor Screw

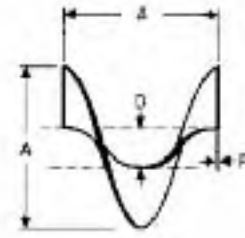

Flight

Screw Diameter	Coupling Diameter	Size Part No. Mounted Conveyor	Size Part No. Fighting Only	Pipe Size		F Flight Thickness	H Coupling Bearing Length	Standard Length Feet-Inches	Average Weight			Approx. Flights Per Foot
				Inside	D Outside				Standard Length	Per Foot	Flight Each	
14	2 ⁷ / ₁₆	14S512-*	14SF512-*	3	3 ¹ / ₂	³ / ₁₆	3	11-9	214	18.0	9.9	.86
		14S516-*	14SF516-*	3	3 ¹ / ₂	¹ / ₄	3	11-9	240	20.0	13.2	.86
		14S524-*	14SF524-*	3	3 ¹ / ₂	⁵ / ₁₆	3	11-9	330	27.5	19.8	.86
	3	14S612-*	14SF612-*	3 ¹ / ₂	4	³ / ₁₆	3	11-9	222	19.0	9.9	.86
		14S616-*	14SF616-*	3 ¹ / ₂	4	¹ / ₄	3	11-9	246	21.0	13.2	.86
16	3	14S624-*	14SF624-*	3 ¹ / ₂	4	⁵ / ₁₆	3	11-9	342	29.0	19.8	.86
		16S612-*	16SF612-*	3 ¹ / ₂	4	³ / ₁₆	3	11-9	234	20.0	14.0	.75
		16S616-*	16SF616-*	3 ¹ / ₂	4	¹ / ₄	3	11-9	282	24.0	18.0	.75
		16S624-*	16SF624-*	3 ¹ / ₂	4	⁵ / ₁₆	3	11-9	365	31.0	25.5	.75
18	3	16S632-*	16SF632-*	3 ¹ / ₂	4	¹ / ₂	3	11-9	402	33.5	36.0	.75
		18S612-*	18SF612-*	3 ¹ / ₂	4	³ / ₁₆	3	11-9	246	21.0	18.0	.67
		18S616-*	18SF616-*	3 ¹ / ₂	4	¹ / ₄	3	11-9	294	25.0	24.0	.67
		18S624-*	18SF624-*	3 ¹ / ₂	4	⁵ / ₁₆	3	11-9	425	36.0	34.5	.67
	3 ⁷ / ₁₆	18S632-*	18SF632-*	3 ¹ / ₂	4	¹ / ₂	3	11-9	530	44.0	46.0	.67
		18S712-*	18SF712-*	4	4 ¹ / ₂	³ / ₁₆	4	11-8	293	24.4	18.0	.67
		18S716-*	18SF716-*	4	4 ¹ / ₂	¹ / ₄	4	11-8	345	28.8	24.0	.67
20	3	18S724-*	18SF724-*	4	4 ¹ / ₂	⁵ / ₁₆	4	11-8	470	39.2	34.5	.67
		18S732-*	18SF732-*	4	4 ¹ / ₂	¹ / ₂	4	11-8	570	47.5	46.0	.67
		20S612-*	20SF612-*	3 ¹ / ₂	4	³ / ₁₆	3	11-9	300	26.0	20.0	.60
24	3 ⁷ / ₁₆	20S616-*	20SF616-*	3 ¹ / ₂	4	¹ / ₄	3	11-9	360	31.0	28.0	.60
		20S624-*	20SF624-*	3 ¹ / ₂	4	⁵ / ₁₆	3	11-9	410	33.4	40.0	.60
		20S632-*	20SF632-*	3 ¹ / ₂	4	¹ / ₂	3	11-9	506	42.2	56.0	.60
		20S712-*	20SF712-*	4	4 ¹ / ₂	³ / ₁₆	4	11-8	310	27.0	20.0	.60
	20S716-*	20SF716-*	4	4 ¹ / ₂	¹ / ₄	4	11-8	370	32.0	28.0	.60	
	20S724-*	20SF724-*	4	4 ¹ / ₂	⁵ / ₁₆	4	11-8	475	40.0	40.0	.60	
	20S732-*	20SF732-*	4	4 ¹ / ₂	¹ / ₂	4	11-8	525	45.0	56.0	.60	
24	3 ⁷ / ₁₆	24S712-*	24SF712-*	4	4 ¹ / ₂	³ / ₁₆	4	11-8	440	37.0	32.0	.50
		24S716-*	24SF716-*	4	4 ¹ / ₂	¹ / ₄	4	11-8	510	43.0	42.0	.50
		24S724-*	24SF724-*	4	4 ¹ / ₂	⁵ / ₁₆	4	11-8	595	50.0	63.0	.50
		24S732-*	24SF732-*	4	4 ¹ / ₂	¹ / ₂	4	11-8	690	60.0	84.0	.50

-* R For Right Hand
-* L For Left Hand

Conveyor Screws (Ribbon)

Ribbon flight conveyor screws consist of sectional flights, butt-welded together to form a continuous helix. Flights are secured to the pipe by supporting legs. Both ends of the pipe are prepared with internal collars and drilling to accept couplings, drive shafts, and end shafts. They are used to convey sticky, gummy, or viscous substances, or where the material tends to adhere to flighting and pipe.

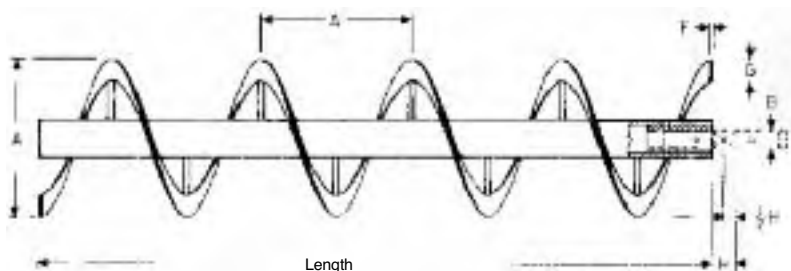

Ribbon Conveyor Screw

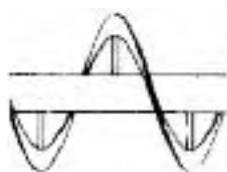

Post

**Integral (Int)
Leg**

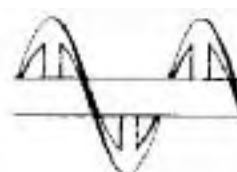

A Screw Diameter	B Coupling Diameter	Size Part No. Mounted Conveyor	Pipe Size		Flight Size		H Coupling Bearing Length	Standard Length Feet-Inches	Weight	
			Inside	Outside	F Thickness	G Width			Complete Screw	
									Standard Length	Per Foot
6	1½	6R312-*	2	2½	⅜	1	2	9-10	65	6.5
9	1½	9R316-*	2	2½	¼	1½	2	9-10	100	10
10	1½	10R316-*	2	2½	¼	1½	2	9-10	110	11
12	2	12R416-*	2½	2½	¼	2	2	11-10	180	15
	2	12R424-*	2½	2½	⅜	2½	2	11-10	216	19
	2⅝	12R524-*	3	3½	⅜	2½	3	11-9	240	21
14	2⅝	14R516-*	3	3½	¼	2½	3	11-9	228	19
	2⅝	14R524-*	3	3½	⅜	2½	3	11-9	264	22
	3	14R624-*	3½	4	⅜	2½	3	11-9	288	25
16	3	16R616-*	3½	4	¼	2½	3	11-9	276	24
	3	16R624-*	3½	4	⅜	2½	3	11-9	324	28
18	3	18R624-*	3½	4	⅜	3	3	11-9	384	33
20	3⅝	20R724-*	4	4½	⅜	3	4	11-8	408	35
24	3⅝	24R724-*	4	4½	⅜	3	4	11-8	424	36

-* R For Right Hand
-* L For Left Hand

CONVEYORS

Quick Detachable (QD) Helicoid Conveyor

Q.D. — Quick Detachable conveyor screws are designed for convenient removal from the conveyor assembly. Each section of screw has a Q.D. cap at one end of the pipe. By removing this cap, a conveyor screw section can quickly and easily be removed and returned to the conveyor assembly without disturbing the other screw sections. Quick Detachable conveyor can be furnished both in helicoid and butt weld construction.

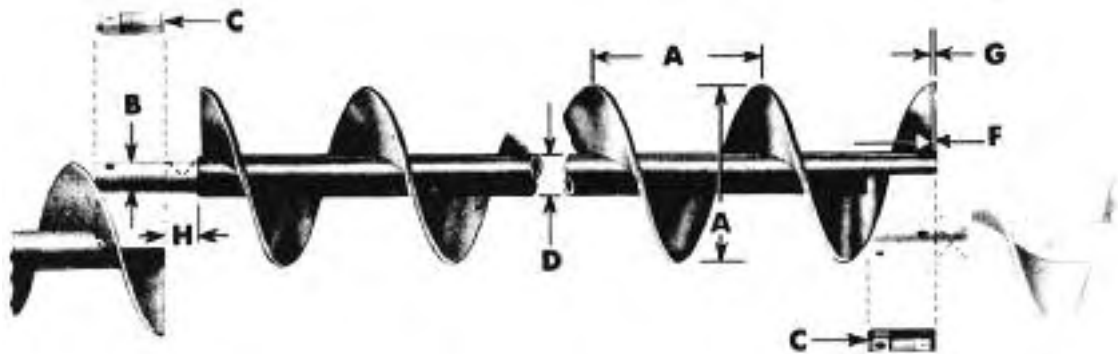

R.H. Shown

A Nominal Conveyor Diameter	Size Part No. Mounted Conveyor	B Coupling Diameter	Standard-Length Feet-Inches End to End of Pipe	C Cap Part Number	D Pipe Size		Flight Thickness		H Coupling Bearing Length	Average Weight	
					Inside	Outside	F Inside	G Outside		Standard Length	Per Foot
6	6HQ304-*	1½	9'-10	3QDC2	2	2¾	⅛	⅜	2	52	5
	6HQ308-*						¼	⅝		62	6
	6HQ312-*						⅜	⅞		72	7
9	9HQ306-*	1½	9'-10	3QDC2	2	2¾	⅜	⅝	2	70	7
	9HQ312-*						⅝	⅞		101	10
	9HQ406-*	2	9'-10	4QDC25	2½	2¾	⅜	⅝	2	91	9
	9HQ412-*						⅝	⅞		121	12
9HQ414-*	⅞						⅞	131		13	
10	10HQ306-*	1½	9'-10	3QDC2	2	2¾	⅜	⅝	2	81	8
	10HQ412-*	2	9'-10	4QDC25	2½	2¾	⅝	⅞	2	130	13
12	12HQ408-*	2	11'-10	4QDC25	2½	2¾	¼	⅝	2	140	12
	12HQ412-*						⅜	⅞		180	15
	12HQ508-*	2⅞	11'-9	5QDC3	3	3½	¼	⅝	3	168	14
	12HQ512-*						⅝	⅞		198	17
12HQ614-*	3	11'-9	6QDC35	3½	4	⅞	⅞	3	220	18	
14	14HQ508-*	2⅞	11'-9	5QDC3	3	3½	¼	⅝	3	170	14
	14HQ614-*	3	11'-9	6QDC35	3½	4	⅞	⅞	3	254	22
16	16HQ610-*	3	11'-9	6QDC35	3½	4	⅝	⅞	3	228	19
	16HQ614-*	3	11'-9	6QDC4	4	4½	⅞	⅞	3	285	23.8

Note: Q.D. caps are not recommended on the drive shaft end.

—* R For Right Hand

—* L For Left Hand

Conveyor Screws

Quick Detachable (QD) Sectional Spiral Conveyors

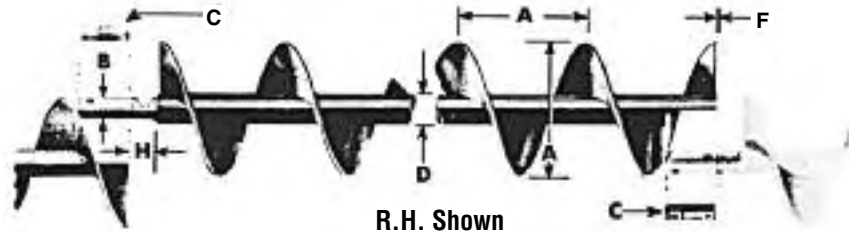

R.H. Shown

A Nominal Conveyor Diameter	Size Part No. Mounted Conveyor	B Coupling Diameter	Standard Length Feet-Inches End to End of Pipe	C Cap Part Number	D Pipe Size		F Flight Thickness	H Coupling Bearing Length	Average Weight	
					Inside	Outside			Standard Length	Per Foot
6	6SQ307-*	1½	9'-10	3QDC2	2	2%	12	2	62	6.2
	6SQ309-*						10		65	6.5
	6SQ312-*						⅜		75	7.5
	6SQ316-*						¼		90	8.0
9	9SQ307-*	1½	9'-10	3QDC2	2	2%	12	2	73	7.3
	9SQ309-*						10		80	8.0
	9SQ312-*						⅜		95	9.5
	9SQ316-*						¼		120	13
	9SQ407-*	2	9'-10	4QDC25	2½	2%	12	2	90	9
	9SQ409-*						10		100	10
	9SQ412-*						⅜		115	11.5
	9SQ416-*						¼		130	13.0
	9SQ424-*						⅜		160	16
10	10SQ309-*	1½	9'-10	3QDC2	2	2%	10	2	85	8.5
	10SQ412-*	2	9'-10	4QDC25	2½	2%	⅜	2	120	12.0
	10SQ416-*						¼		135	13.5
12	12SQ409-*	2	11'-10	4QDC25	2½	2%	10	2	140	12.0
	12SQ412-*						⅜		156	13.0
	12SQ416-*						¼		204	17
	12SQ509-*	2⅞	11'-9	5QDC3	3	3½	10	3	160	14
	12SQ512-*						⅜		178	15
12SQ612-*	3	11'-9	6QDC35	3½	4	⅜	3	191	16.5	
12SQ616-*						¼		216	18.0	
12SQ624-*						⅜		280	24	
14	14SQ509-*	2⅞	11'-9	5QDC3	3	3½	10	3	185	16
	14SQ512-*						⅜		214	18
	14SQ612-*	3	11'-9	6QDC35	3½	4	⅜	3	222	19
	14SQ616-*						¼		246	21
14SQ624-*						⅜		342	29	
16	16SQ609-*	3	11'-9	6QDC35	3½	4	10	3	210	18
	16SQ612-*						⅜		234	20
	16SQ616-*						¼		282	24
	16SQ624-*						⅜		365	31
18	18SQ612-*	3	11'-9	6QDC35	3½	4	⅜	3	246	21
	18SQ616-*						¼		294	25
	18SQ624-*						⅜		425	36
20	20SQ612-*	3	11'-9	6QDC35	3½	4	⅜	3	300	26
	20SQ616-*						¼		360	31
	20SQ724-*	3⅞	11'-8	7QDC4	4	4½	⅜	4	475	40
24	24SQ712-*	3⅞	11'-8	7QDC4	4	4½	⅜	4	410	37
	24SQ716-*						¼		510	43
	24SQ724-*						⅜		595	50

* R For Right Hand
* L For Left Hand

Coupling Bolts

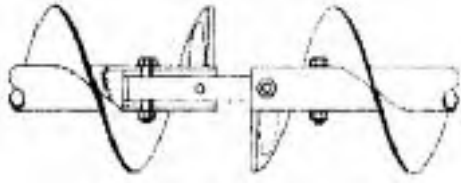

Conveyor coupling bolts are manufactured from special analysis high-torque steel. Close tolerance for a minimum of wear. Lock nuts are furnished with each bolt.

Coupling Diameter	Outside Pipe Diameter	Bolt Size	Part Number Standard	Weight Each Lbs.
1	1½	¾ × 2½	CCB2	.13
1½	2	½ × 3	CCB3	.2
2	2½	⅝ × 3½	CCB4	.45
2⅞	3½	⅝ × 4	CCB5	.5
3	4	¾ × 5	CCB6	.85
3	4½	¾ × 5½	CCB6A	.9
3⅞	4½	⅞ × 5½	CCB7	1.29

Internal Collar

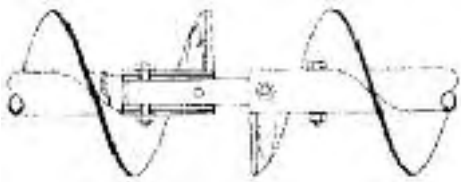

Internal collars are made from seamless tubing machined for a press fit in the conveyor pipe. When installed at the factory collars are jig drilled and plug welded into the pipe. No drilling in replacement collars is furnished allowing for field drilling to match existing bolt holes.

Coupling Diameter	Inside Pipe Diameter	Part Number Standard	Weight Each Lbs.
1	1¼	CIC2	.58
1½	2	CIC3	2.06
2	2½	CIC4	2.16
2⅞	3	CIC5	3.72
3	3½	CIC6	4.03
3	4	CIC6A	8.03
3⅞	4	CIC7	6.52

Discharge End

End Lugs

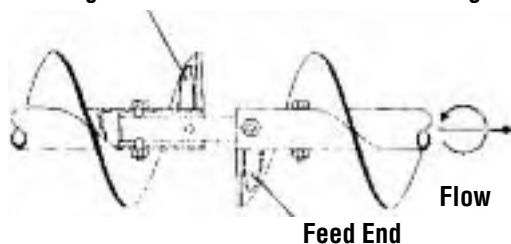

End lugs are welded opposite the carrying side of the conveyor flight and provide maximum support with minimum obstruction of material flow.

Conveyor Diameter	Part Number		Weight Each Lbs.
	Intake End Standard	Discharge End Standard	
6	6CELI-*	6CELD-*	.06
9	9CELI-*	9CELD-*	.15
10	9CELI-*	9CELD-*	.15
12	12CELI-*	12CELD-*	.2
14	12CELI-*	12CELD-*	.2
16	16CELI-*	16CELD-*	.4
18	16CELI-*	16CELD-*	.4
20	16CELI-*	16CELD-*	.4
24	16CELI-*	16CELD-*	.4

-* R For Right Hand Flight
-* L For Left Hand Flight

Shaft



Coupling Shafts		CC	5								
Coupling Part		Coupling Diameter									
CC — Coupling Shaft Std.*		2 — 1"	5 — 2-7/16"	* Add suffix H if Hardened							
CCC — Close Coupling Shaft		3 — 1-1/2"	6 — 3"								
CHE — Hanger End Shaft*		4 — 2"	7 — 3-7/16"								
COUPLING		Conveyor couplings are used to join individual lengths of conveyor screws and allow for rotation within the hanger bearing. C-1045 steel couplings are normally furnished; however couplings with hardened bearing surfaces may be furnished where highly abrasive materials are being conveyed. Jig drilling allows for ease of installation.									
CLOSE		Close couplings are used to adjoin conveyor screws where no hanger is required. Jig drilling allows for ease of installation.									
Drive & End Shafts		1	CD	5	BB	W	Seal Type				
Drive Shaft Number		Type		Coupling Diameter		Bearing Type					
1 — #1	2 — #2 Single Bearing Pedestal	3 — #3 Double Bearing Pedestal	CD — Drive Shaft CE — End Shaft	2 — 1"	3 — 1-1/2"	4 — 2"	5 — 2-7/16"	6 — 3"	7 — 3-7/16"	BB — Ball RB — Roller	(Delete if without seal) P — Plate W — Waste Pack
END		End shafts serve only to support the end conveyor section and are therefore usually supplied in cold rolled steel. End shafts are jig drilled for ease of assembly and close diametral tolerances are held for proper bearing operation.									
HANGER END		Hanger end shafts are designed to connect only one conveyor section to a hanger bearing. These shafts may also be used in pairs to divide an excessively long conveyor assembly between two drives.									
#1 DRIVE		No. 1 drive shafts are normally used where standard end plates are furnished. Jig drilling allows for ease of installation.									
SPECIAL DRIVE		Length, bearing location, seals and keyway location and size as required.									

CONVEYORS

No. 1 drive shafts are normally used where standard end plates are furnished. Jig drilling allows for ease of installation.

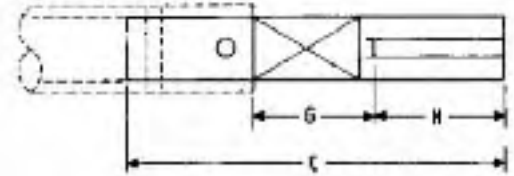

No. 1 Drive Shaft Used Without Seal*

Bronze Bearing						Ball Bearing					
Shaft Diameter	Part Number	C	G	H	Weight	Shaft Diameter	Part Number	C	G	H	Weight
1	1CD2B	9½	3½	3	2.0	1	1CD2BB	9	3	3	1.8
1½	1CD3B	12¾	4¾	3¼	6.3	1½	1CD3BB	11½	3½	3¼	5.6
2	1CD4B	15	5¾	4½	13.3	2	1CD4BB	13¾	3¾	4½	11.5
2⅝	1CD5B	17¾	7	5½	21.0	2⅝	1CD5BB	15¾	4¾	5½	18.0
3	1CD6B	19¾	8¾	6	37.0	3	1CD6BB	16¾	5¾	6	32.0
3⅝	1CD7B	23	9	7¼	60.4	3⅝	1CD7BB	20¾	6¾	7¼	52.5

**Consult Factory

No. 1 Drive Shaft Used With Plate or Product Drop Out Seals*

Bronze Bearing						Ball Bearing					
Shaft Diameter	Part Number	C	G	H	Weight	Shaft Diameter	Part Number	C	G	H	Weight
1	1CD2B-P	10	4	3	2.1	1	1CD2BB-P	9½	3½	3	2.0
1½	1CD3B-P	13¾	5¾	3¼	6.6	1½	1CD3BB-P	12¾	4¾	3¼	6.2
2	1CD4B-P	15¾	6¾	4½	14.1	2	1CD4BB-P	14	4¾	4½	12.5
2⅝	1CD5B-P	18¾	8	5½	24.3	2⅝	1CD5BB-P	15¾	5¾	5½	21
3	1CD6B-P	19¾	8¾	6	38.0	3	1CD6BB-P	17¾	6¾	6	35
3⅝	1CD7B-P	24¾	10¾	7¼	61.0	3⅝	1CD7BB-P	21¾	7¾	7¼	56.5

**Consult Factory

No. 1 Drive Shaft Used With Waste Pack Seal*

Bronze Bearing						Ball Bearing					
Shaft Diameter	Part Number	C	G	H	Weight	Shaft Diameter	Part Number	C	G	H	Weight
1	1CD2B-W	11	4¾	3	2.2	1	1CD2BB-W	10½	3¾	3	2.0
1½	1CD3B-W	14½	6½	3¼	7.2	1½	1CD3BB-W	13¾	5¼	3¼	6.4
2	1CD4B-W	16¾	7½	4½	14.9	2	1CD4BB-W	14¾	5¾	4½	13.0
2⅝	1CD5B-W	19¾	8¾	5½	23.3	2⅝	1CD5BB-W	16¾	6¾	5½	20.5
3	1CD6B-W	20¾	9¾	6	40.5	3	1CD6BB-W	18¾	7¾	6	35.5
3⅝	1CD7B-W	25¾	11¾	7¼	66.3	3⅝	1CD7BB-W	22¾	8¾	7¼	58.4

*Shaft length allows for ½ hanger bearing length as clearance between end plate and screw

**Consult Factory

No. 2 and No. 3 Drive Shafts



No. 2 Drive Shaft

No. 2 drive shafts are used where pedestal type trough ends with single bearing are furnished. Jig drilling allows for ease of installation.

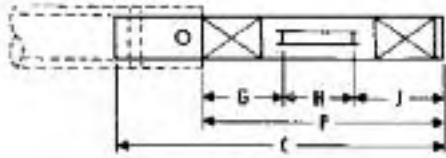

Shaft Diameter	Part Number	C	G	H	J	P	Weight
1	2CD2	11	3¼	2¼	2½	8	2.5
1½	2CD3	16½	5	3¼	3½	11¾	8.3
2	2CD4	18¾	5¼	4¼	4½	14	17.0
2⅞	2CD5	21¾	6	5½	5½	17	29.0
3	2CD6	23½	6½	5½	6½	18½	49.0
3⅞	2CD7	27	6¾	6	7½	20¾	75.0

No. 3 Drive Shaft

No. 3 drive shafts are used where pedestal type trough ends with double bearings are furnished. Jig drilling allows for ease of installation.



Shaft Diameter	Part Number	C	G	H	P	Weight
1	3CD2	15½	9¼	3	12¼	3
1½	3CD3	20¾	12½	3¼	15¾	10
2	3CD4	22	12¾	4½	17¾	21
2⅞	3CD5	24¾	14¼	5½	19¾	36
3	3CD6	25¾	14¾	6	20¾	62
3⅞	3CD7	29¾	15¾	7¼	23¾	95

CONVEYORS

Drive Shaft Keyways

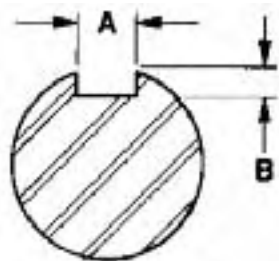

Shaft Diameter	A	B
1	¼	⅙
1½	⅝	⅜
2	½	¼
2⅞	⅝	⅜
3	¾	⅝
3⅞	⅞	⅞

Coupling

Conveyor couplings are used to join individual lengths of conveyor screws and allow for rotation within the hanger bearing. Mild steel couplings are normally furnished; however induction hardened bearing area couplings may be furnished where highly abrasive materials are being conveyed. Jig drilling allows for ease of installation.

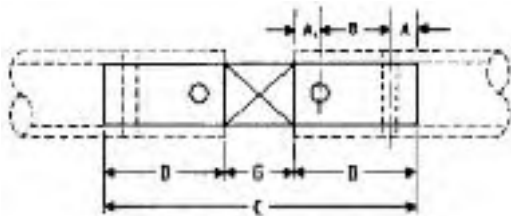

Shaft Diameter	Part Number*	A ₁	A	B	C	D	G	Weight
1	CC2	½	½	2	7½	3	1½	1.5
1½	CC3	¾	¾	3	11½	4¾	2	5.6
2	CC4	¾	¾	3	11½	4¾	2	9.8
2⅞	CC5	1⅝	1⅝	3	12¾	4⅞	3	15.4
3	CC6	1	1	3	13	5	3	23.8
3⅞	CC7	1½	1¼	4	17½	6¾	4	44.5

*Add — H for Hardened Shaft.

Shaft is induction hardened in bearing area only to 40-50 RC.

Close Coupling

Close couplings are used to adjoin conveyor screws where no hanger is required. Jig drilling allows for ease of installation.

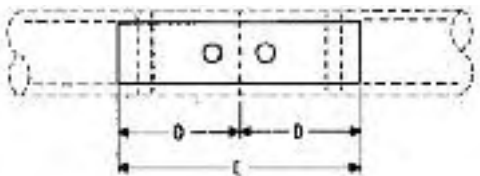

Shaft Diameter	Part Number	C	D	Weight
1	CCC2	6	3	1.3
1½	CCC3	9½	4¾	4.8
2	CCC4	9½	4¾	8.5
2⅞	CCC5	9¾	4⅞	12.9
3	CCC6	10	5	20.0
3⅞	CCC7	13½	6¾	37.0

Hanger End

Hanger end shafts are designed to connect only one conveyor section to a hanger bearing. These shafts may also be used in pairs to divide an excessively long conveyor assembly between two drives.

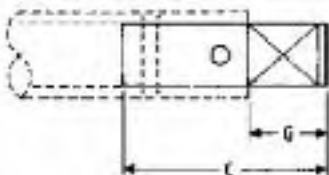

Shaft Diameter	Part Number*	C	G	Weight
1	CHE2	4¾	1¾	1.0
1½	CHE3	6¾	2¾	3.5
2	CHE4	6¾	2¾	6.2
2⅞	CHE5	8¾	3¾	10.6
3	CHE6	8¾	3¾	16.5
3⅞	CHE7	11¾	4¾	29.7

*Add — H for Hardened Shaft
Shaft is induction hardened in bearing area only to 40-50 RC.

End Shaft



End shafts serve only to support the end conveyor section and are therefore usually supplied in cold rolled steel. End shafts are jig drilled for ease of assembly and close diametrical tolerances are held for proper bearing operation.

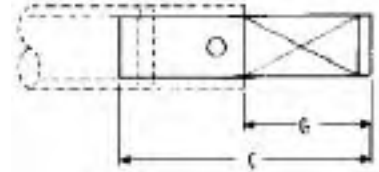

End Shaft Used Without Seal**									
Bronze Bearing					Ball Bearing				
Shaft Diameter	Part Number*	C	G	Weight	Shaft Diameter	Part Number*	C	G	Weight
1	CE2B	6½	3½	1.4	1	CE2BB	6	3	1.2
1½	CE3B	9¼	4½	4.5	1½	CE3BB	8¼	3½	3.8
2	CE4B	10¾	5½	9.0	2	CE4BB	8¾	3¾	7.5
2⅝	CE5B	11¾	7	15.4	2⅝	CE5BB	9¾	4¾	12.4
3	CE6B	13¾	8¾	25.6	3	CE6BB	10¾	5¾	20.8
3⅝	CE7B	16¾	9¾	42.4	3⅝	CE7BB	13¾	6¾	34.4

***Consult Factory

End Shaft Used With Plate or Product Drop Out Seal**									
Bronze Bearing					Ball Bearing				
Shaft Diameter	Part Number*	C	G	Weight	Shaft Diameter	Part Number*	C	G	Weight
1	CE2B-P	7	4	1.5	1	CE2BB-P	6½	3½	1.4
1½	CE3B-P	10¼	5½	5.1	1½	CE3BB-P	9	4¼	4.5
2	CE4B-P	11¼	6½	10.0	2	CE4BB-P	9¾	4¾	8.3
2⅝	CE5B-P	12¾	8	17.0	2⅝	CE5BB-P	10¾	5¼	13.1
3	CE6B-P	13¾	8¾	29.8	3	CE6BB-P	11½	6½	23.0
3⅝	CE7B-P	16¾	10¾	44.0	3⅝	CE7BB-P	14¾	7¾	37.1

***Consult Factory

End Shaft Used With Waste Pack Seal**									
Bronze Bearing					Ball Bearing				
Shaft Diameter	Part Number*	C	G	Weight	Shaft Diameter	Part Number*	C	G	Weight
1	CE2B-W	8	4¼	1.6	1	CE2BB-W	7½	3¾	1.4
1½	CE3B-W	11	6¼	5.2	1½	CE3BB-W	10	5¼	4.8
2	CE4B-W	12	7¼	10.4	2	CE4BB-W	10¾	5¾	9.0
2⅝	CE5B-W	13¾	8¾	17.6	2⅝	CE5BB-W	11¾	6½	14.8
3	CE6B-W	14¾	9¾	28.2	3	CE6BB-W	12¾	7¾	24.0
3⅝	CE7B-W	18¾	11¾	48.0	3⅝	CE7BB-W	15¾	8¾	40.2

*Add - H for Hardened Shaft.

**Shaft length allows for ½ hanger bearing length, clearance between end plate and screw.

***Consult Factory

CONVEYORS

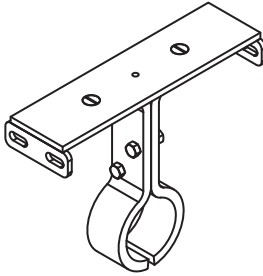
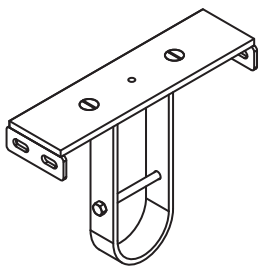
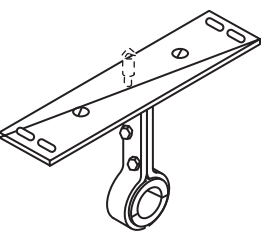
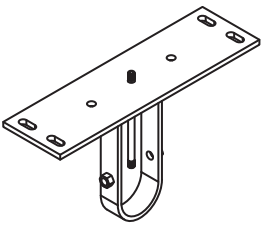
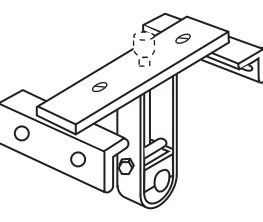
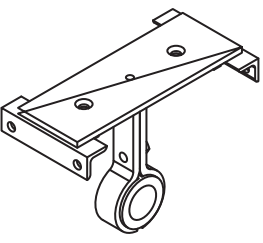
<p>Style 226</p>		<p>No. 226 hangers are designed for flush mounting inside the trough permitting dust-tight or weather-proof operation. This type hanger allows for minimum obstruction of material flow in high capacity conveyors. Available with friction type bearing.</p>
<p>Style 216</p>		<p>No. 216 hangers are designed for heavy duty applications. This hanger is flush mounted inside the trough permitting dust tight or weather proof operation. Hard iron or bronze bearings are normally furnished; however, the hanger can be furnished with other bearings.</p>
<p>Style 220</p>		<p>No. 220 hangers are designed for mount on top of the trough flanges and may be used where dust-tight or weather proof operation is not required. This type hanger allows for minimum obstruction of material flow in high capacity conveyors. Available with friction type bearing.</p>
<p>Style 230</p>		<p>No. 230 hangers are designed for heavy duty applications where mounting on top of the trough flanges is required. Hard iron or bronze bearings are normally furnished; however, other bearings are available.</p>
<p>Style 316</p>		<p>No. 316 hangers are designed for heavy duty use in conveyors where abnormal heat requires unequal expansion between the screw and conveyor trough. Hard iron or bronze bearings are normally furnished; however, this hanger can be furnished with other bearings.</p>
<p>Style 326</p>		<p>No. 326 hangers are designed to permit minimum obstruction of material flow and are used in conveyors where abnormal heat requires unequal expansion between the screw and the conveyor trough. Hard iron or bronze bearings are normally furnished, but other type bearings are available.</p>

Hangers

<p>Style 60</p>		<p>No. 60 hangers are furnished with a heavy duty, permanently lubricated and sealed, self aligning ball bearing which permits temperatures up to 245° F. and will allow for up to 4° shaft misalignment. This hanger is mounted on top of the trough flanges. Grease fitting can be furnished if specified.</p>
<p>Style 70</p>		<p>No. 70 hangers are furnished with a heavy duty, permanently lubricated and sealed, self aligning ball bearing which permit temperatures up to 245° F. and will allow for up to 4° shaft misalignment. This hanger is mounted inside the trough. Grease fittings can be furnished if specified.</p>
<p>Style 30</p>		<p>No. 30 hangers are designed for side mounting within the conveyor trough on the noncarrying side and permit a minimum of obstruction of material flow. Available with friction type bearing.</p>
<p>Style 216F</p>		<p>No. 216F hangers are designed for heavy duty applications and are mounted inside of flared trough. Hard iron or bronze bearings are normally furnished; however, other bearings are available.</p>
<p>Style 19B</p>		<p>The No. 19B hanger is similar in construction to the No. 18B except they are mounted on top of the trough angles. Built-in ledges provide supports for the ends of the cover. They are streamline in design and permit free passage of the material. They are regularly furnished with Arguto oil impregnated wood, hard iron, bronze, or other special caps can be furnished.</p>
<p>Air Purged Hanger</p>		<p>Air purged hangers are recommended when handling dusty and abrasive materials which contribute to shutdowns and hanger bearing failures. Air-swept hangers are available for 9"-24" conveyors. They should not be used when handling hot materials (over 250° F) or wet sticky materials or when handling non abrasive materials when an inexpensive hanger will do the job satisfactorily. In service, air-purged hangers deliver relatively trouble-free operation. They help solve noise nuisance problems, and they help reduce power requirement because of the low coefficient of friction. Maximum trough loading should not exceed 15%. The air, at approximately 1-1/4 PSI enters the housing at the top, passes over and around the bearing, and is dissipated around the coupling shaft on both sides of the housing. Thus the bearing is protected from dust and the material in the trough at all times. Only 3 to 7 cu. ft. of air per minute is required to keep each hanger bearing clean.</p>

Style 220

No. 220 hangers are designed for mounting on top of the trough flanges and may be used where dust-tight or weather proof operation is not required. This type hanger allows for minimum obstruction of material flow in high capacity conveyors. Available with friction type bearing.

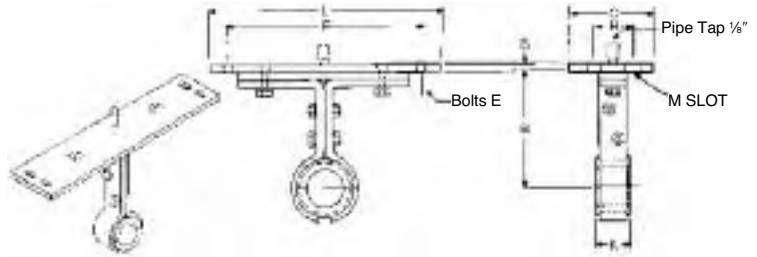

Conveyor Diameter	Coupling Size	Part Number*	B	C	D	E	F	H	K	L	M Slot	Weight Each
4	1	4CH2202	3 ¹ / ₁₆	3 ¹ / ₂	³ / ₁₆	¹ / ₄	6 ¹ / ₂	2	1 ¹ / ₂	7 ¹ / ₄	⁵ / ₁₆ × ³ / ₄	5
6	1 ¹ / ₂	6CH2203	4 ¹ / ₂	4 ¹ / ₂	³ / ₁₆	³ / ₈	8 ³ / ₄	2 ¹ / ₂	2	9 ³ / ₄	⁷ / ₁₆ × 1 ¹ / ₁₆	7
9	1 ¹ / ₂	9CH2203	6 ¹ / ₈	4 ¹ / ₂	¹ / ₄	³ / ₈	12 ³ / ₄	2 ¹ / ₂	2	13 ³ / ₄	⁷ / ₁₆ × 1 ¹ / ₁₆	9
	2	9CH2204	6 ¹ / ₈	4 ¹ / ₂	¹ / ₄	³ / ₈	12 ¹ / ₂	2 ¹ / ₂	2	13 ¹ / ₂		11
10	1 ¹ / ₂	10CH2203	6 ³ / ₈	4 ¹ / ₂	¹ / ₄	³ / ₈	13 ³ / ₄	2 ¹ / ₂	2	14 ¹ / ₂	⁷ / ₁₆ × 1 ¹ / ₁₆	10
	2	10CH2204	6 ³ / ₈	4 ¹ / ₂	¹ / ₄	³ / ₈	13 ³ / ₄	2 ¹ / ₂	2	14 ¹ / ₂		12
	2 ¹ / ₁₆	12CH2204	7 ³ / ₄	5	³ / ₈	¹ / ₂	15 ³ / ₄	2 ¹ / ₂	2	17 ¹ / ₂	⁹ / ₁₆ × 1 ¹ / ₁₆	16
12	2 ¹ / ₁₆	12CH2205	7 ³ / ₄	5	³ / ₈	¹ / ₂	15 ³ / ₄	2 ¹ / ₂	3	17 ¹ / ₂		21
	3	12CH2206	7 ³ / ₄	5	³ / ₈	¹ / ₂	15 ³ / ₄	2 ¹ / ₂	3	17 ¹ / ₂		28
	2 ⁷ / ₁₆	14CH2205	9 ¹ / ₄	5	¹ / ₂	¹ / ₂	17 ³ / ₄	2 ¹ / ₂	3	19 ¹ / ₂	⁹ / ₁₆ × 1 ¹ / ₁₆	26
14	3	14CH2206	9 ¹ / ₄	5	¹ / ₂	¹ / ₂	17 ¹ / ₂	2 ¹ / ₂	3	19 ¹ / ₂		33
	3	16CH2206	10 ³ / ₈	5	¹ / ₂	¹ / ₂	19 ³ / ₄	2 ¹ / ₂	3	21 ¹ / ₂	⁹ / ₁₆ × 1 ¹ / ₁₆	39
18	3	18CH2206	12 ¹ / ₈	6	¹ / ₂	⁵ / ₈	22 ¹ / ₄	3 ¹ / ₂	3	24 ¹ / ₂	¹ / ₁₆ × 1 ¹ / ₁₆	41
	3 ⁷ / ₁₆	18CH2207	12 ¹ / ₈	6	¹ / ₂	⁵ / ₈	22 ¹ / ₄	3 ¹ / ₂	4	24 ¹ / ₂		49
20	3	20CH2206	13 ¹ / ₂	6	¹ / ₂	⁵ / ₈	24 ¹ / ₄	3 ¹ / ₂	3	26 ¹ / ₂	¹ / ₁₆ × 1 ¹ / ₁₆	43
	3 ⁷ / ₁₆	20CH2207	13 ¹ / ₂	6	¹ / ₂	⁵ / ₈	24 ¹ / ₄	3 ¹ / ₂	4	26 ¹ / ₂		51
24	3 ⁷ / ₁₆	24CH2207	16 ¹ / ₂	6	¹ / ₂	⁵ / ₈	28 ¹ / ₄	3 ¹ / ₂	4	30 ¹ / ₂	¹ / ₁₆ × 1 ¹ / ₁₆	57

*Refer to Page H-101 for bearings

NOTE: For hangers with oil pipe add -0 to part number

Style 226

No. 226 hangers are designed for flush mounting inside the trough permitting dust-tight or weather-proof operation. This type hanger allows for minimum obstruction of material flow in high capacity conveyors. Also available with friction type bearing.

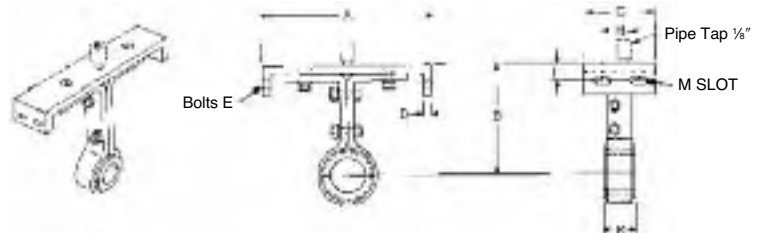

Conveyor Diameter	Coupling Size	Part Number*	A	B	C	D	E	F	H	K	M Slot	Weight Each
4	1	4CH2262	5	3 ³ / ₈	3 ¹ / ₂	³ / ₁₆	¹ / ₄	1 ¹ / ₁₆	2	1 ¹ / ₂	⁵ / ₁₆ × ³ / ₄	5
6	1 ¹ / ₂	6CH2263	7	4 ¹ / ₂	4 ¹ / ₂	³ / ₁₆	³ / ₈	³ / ₄	2 ¹ / ₂	2	⁷ / ₁₆ × 1 ¹ / ₁₆	7
9	1 ¹ / ₂	9CH2263	10	6 ¹ / ₈	4 ¹ / ₂	¹ / ₄	³ / ₈	1	2 ¹ / ₂	2	⁷ / ₁₆ × 1 ¹ / ₁₆	9
	2	9CH2264	10	6 ¹ / ₈	4 ¹ / ₂	¹ / ₄	³ / ₈	1	2 ¹ / ₂	2		11
10	1 ¹ / ₂	10CH2263	11	6 ³ / ₈	4 ¹ / ₂	¹ / ₄	³ / ₈	1	2 ¹ / ₂	2	⁷ / ₁₆ × 1 ¹ / ₁₆	10
	2	10CH2264	11	6 ³ / ₈	4 ¹ / ₂	¹ / ₄	³ / ₈	1	2 ¹ / ₂	2		12
	2 ¹ / ₁₆	12CH2264	13	7 ³ / ₄	5	³ / ₈	¹ / ₂	1 ¹ / ₄	2 ¹ / ₂	2	⁹ / ₁₆ × 1 ¹ / ₁₆	16
12	2 ¹ / ₁₆	12CH2265	13	7 ³ / ₄	5	³ / ₈	¹ / ₂	1 ¹ / ₄	2 ¹ / ₂	3		21
	3	12CH2266	13	7 ³ / ₄	5	³ / ₈	¹ / ₂	1 ¹ / ₄	2 ¹ / ₂	3		28
	2 ⁷ / ₁₆	14CH2265	15	9 ¹ / ₄	5	¹ / ₂	¹ / ₂	1 ³ / ₈	2 ¹ / ₂	3	⁹ / ₁₆ × 1 ¹ / ₁₆	26
14	3	14CH2266	15	9 ¹ / ₄	5	¹ / ₂	¹ / ₂	1 ³ / ₈	2 ¹ / ₂	3		33
	3	16CH2266	17	10 ³ / ₈	5	¹ / ₂	¹ / ₂	1 ³ / ₈	2 ¹ / ₂	3	⁹ / ₁₆ × 1 ¹ / ₁₆	39
18	3	18CH2266	19	12 ¹ / ₈	6	¹ / ₂	⁵ / ₈	1 ¹ / ₂	3 ¹ / ₂	3	¹ / ₁₆ × 1 ¹ / ₁₆	41
	3 ⁷ / ₁₆	18CH2267	19	12 ¹ / ₈	6	¹ / ₂	⁵ / ₈	1 ¹ / ₂	3 ¹ / ₂	4		49
20	3	20CH2266	21	13 ¹ / ₂	6	¹ / ₂	⁵ / ₈	1 ¹ / ₂	3 ¹ / ₂	3	¹ / ₁₆ × 1 ¹ / ₁₆	43
	3 ⁷ / ₁₆	20CH2267	21	13 ¹ / ₂	6	¹ / ₂	⁵ / ₈	1 ¹ / ₂	3 ¹ / ₂	4		51
24	3 ⁷ / ₁₆	24CH2267	25	16 ¹ / ₂	6	¹ / ₂	⁵ / ₈	1 ³ / ₈	3 ¹ / ₂	4	¹ / ₁₆ × 1 ¹ / ₁₆	57

*Refer to Page H-101 for bearings

*For hangers with oil pipe add -0 to part number

Hangers

Style 216

No. 216 hangers are designed for heavy duty applications. This hanger is flush mounted inside the trough permitting dust tight or weather proof operation. Hard iron or bronze bearings are normally furnished; however, the hanger can be furnished with other bearings.

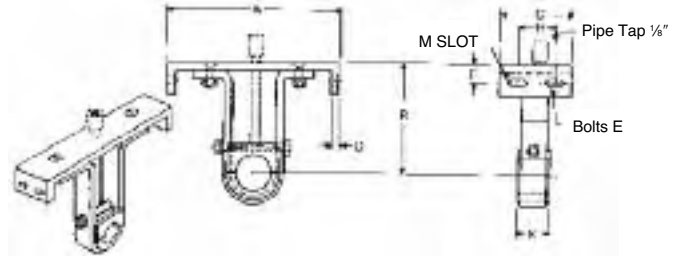

Conveyor Diameter	Coupling Size	Part Number*	A	B	C	D	E	F	H	K	M Slot	Weight Each
6	1½	6CH2163	7	4½	4½	¾	¾	¾	2½	2	7/16 x 1 1/16	5
9	1½	9CH2163	10	6%	4½	¼	¾	1	2½	2	7/16 x 1 1/16	7
	2	9CH2164	10	6%	4½	¼	¾	1	2½	2	7/16 x 1 1/16	9
10	1½	10CH2163	11	6%	4½	¼	¾	1	2½	2	7/16 x 1 1/16	8
	2	10CH2164	11	6%	4½	¼	¾	1	2½	2	7/16 x 1 1/16	10
	2 7/16	12CH2164	13	7%	5	¾	½	1¼	2½	2	7/16 x 1 1/16	14
12	2 7/16	12CH2165	13	7%	5	¾	½	1¼	2½	3	7/16 x 1 1/16	18
	3	12CH2166	13	7%	5	¾	½	1¼	2½	3	7/16 x 1 1/16	21
	2 7/16	14CH2165	15	9%	5	½	½	1%	2½	3	7/16 x 1 1/16	23
14	3	14CH2166	15	9%	5	½	½	1%	2½	3	7/16 x 1 1/16	25
	3	16CH2166	17	10%	5	½	½	1%	2½	3	7/16 x 1 1/16	28
18	3	18CH2166	19	12%	6	½	¾	1½	3½	3	7/16 x 1 1/16	34
	3 7/16	18CH2167	19	12%	6	½	¾	1½	3½	4	7/16 x 1 1/16	44
20	3	20CH2166	21	13½	6	½	¾	1½	3½	3	7/16 x 1 1/16	36
	3 7/16	20CH2167	21	13½	6	½	¾	1½	3½	4	7/16 x 1 1/16	47
24	3 7/16	24CH2167	25	16½	6	¾	¾	1%	3½	4	7/16 x 1 1/16	53

*Refer to Page H-101 for bearings

*For hangers with oil pipe add -0 to part number

Style 230

No. 230 hangers are designed for heavy duty applications where mounting on top of the trough flange is required. Hard iron or bronze bearings are normally furnished; however, other bearings are available.

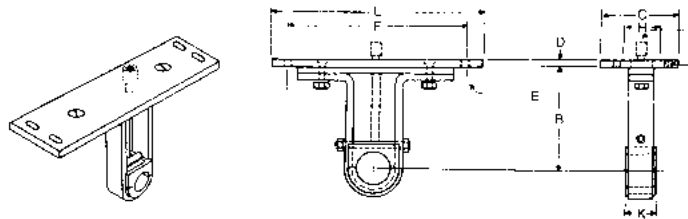

Conveyor Diameter	Coupling Size	Part Number*	B	C	D	E	F	H	K	L	M Slot	Weight Each
6	1½	6CH2303	4½	4½	¼	¾	8¾	2½	2	9¾	7/16 x 1 1/16	6
9	1½	9CH2303	6%	4½	¼	¾	12¼	2½	2	13½	7/16 x 1 1/16	8
	2	9CH2304	6%	4½	¼	¾	12¼	2½	2	13½	7/16 x 1 1/16	10
10	1½	10CH2303	6%	4½	¼	¾	13¾	2½	2	14½	7/16 x 1 1/16	9
	2	10CH2304	6%	4½	¼	¾	13¾	2½	2	14½	7/16 x 1 1/16	11
12	2	12CH2304	7%	5	¾	½	15%	2½	2	17½	7/16 x 1 1/16	15
	2 7/16	12CH2305	7%	5	¾	½	15%	2½	3	17½	7/16 x 1 1/16	20
	3	12CH2306	7%	5	¾	½	15%	2½	3	17½	7/16 x 1 1/16	25
14	2 7/16	14CH2305	9%	5	¾	½	17%	2½	3	19½	7/16 x 1 1/16	24
	3	14CH2306	9%	5	¾	½	17%	2½	3	19½	7/16 x 1 1/16	29
16	3	16CH2306	10%	5	¾	½	19%	2½	3	21½	7/16 x 1 1/16	35
18	3	18CH2306	12%	6	½	¾	22¼	3½	3	24½	7/16 x 1 1/16	34
	3 7/16	18CH2307	12%	6	½	¾	22¼	3½	4	24½	7/16 x 1 1/16	47
20	3	20CH2306	13½	6	½	¾	24¼	3½	3	26½	7/16 x 1 1/16	40
	3 7/16	20CH2307	13½	6	½	¾	24¼	3½	4	26½	7/16 x 1 1/16	49
24	3 7/16	24CH2307	16½	6	¾	¾	28¾	3%	4	30½	7/16 x 1 1/16	55

*Refer to Page H-101 for bearings

*For hangers with oil pipe add -0 to part number

Style 316

No. 316 hangers are designed for heavy duty use in conveyors where abnormal heat requires unequal expansion between the screw and conveyor trough. Hard iron or bronze bearings are normally used; however, this hanger can be furnished with other bearings.

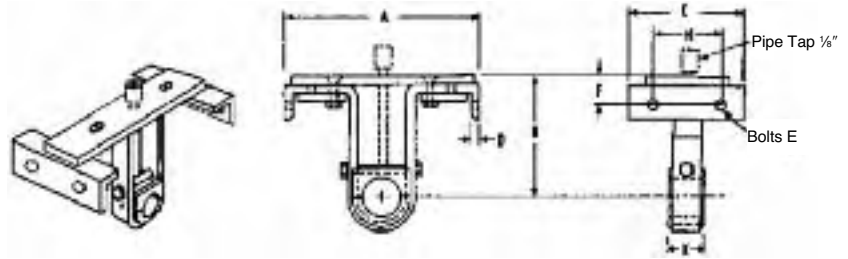

Style 326

No. 326 hangers are designed to permit minimum obstruction of material flow and are used in conveyors where abnormal heat requires unequal expansion between the screw and the conveyor trough. Hard iron or bronze bearings are normally used, but other type bearings are available.

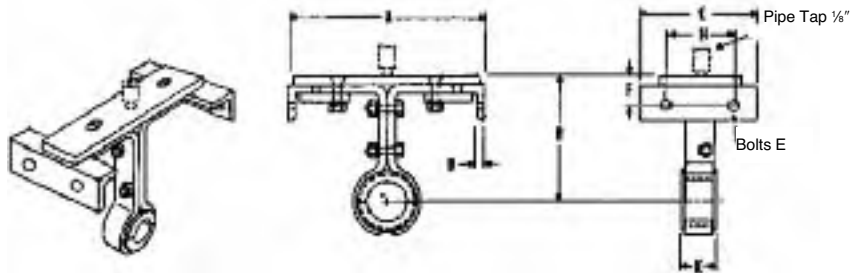

Conveyor Diameter	Coupling Size	Part Number		A	B	C	D	E	F	H	K
		Style 316*	Style 326*								
6	1½	6CH3163	6CH3263	7	4½	6	¾	¾	¾	4½	2
9	1½	9CH3163	9CH3263	10	6¾	6	¾	¾	1	4½	2
	2	9CH3164	9CH3264	10	6¾	6	¾	¾	1	4½	2
10	1½	10CH3163	10CH3263	11	6¾	6	¾	¾	1	4½	2
	2	10CH3164	10CH3264	11	6¾	6	¾	¾	1	4½	2
12	2	12CH3164	12CH3264	13	7¾	6½	¼	½	1¼	5	2
	2⅞	12CH3165	12CH3265	13	7¾	6½	¼	½	1¼	5	3
	3	12CH3166	12CH3266	13	7¾	6½	¼	½	1¼	5	3
14	2⅞	14CH3165	14CH3265	15	9¼	6½	¼	½	1¾	5	3
	3	14CH3166	14CH3266	15	9¼	6½	¼	½	1¾	5	3
16	3	16CH3166	16CH3266	17	10¾	6½	¼	½	1¾	5	3
18	3	18CH3166	18CH3266	19	12¾	6½	¼	¾	1¾	5¼	3
	3⅞	18CH3167	18CH3267	19	12¾	7	¼	¾	1¾	5¼	4
20	3	20CH3166	20CH3266	21	13¾	7	¼	¾	1¾	5¼	3
	3⅞	20CH3167	20CH3267	21	13¾	7	¼	¾	1¾	5¼	4
24	3⅞	24CH3167	24CH3267	25	16¾	7	¼	¾	1¾	5¼	4

*Refer to Page H-101 for bearings

*For hangers with oil pipe add -0 to part number

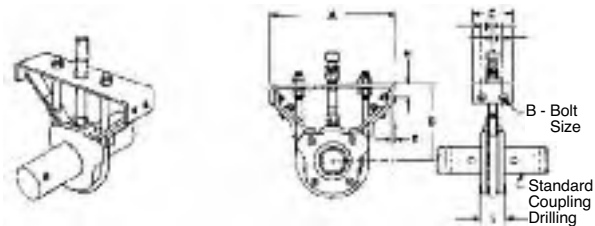

Air Purged Hanger

Air purged hangers are recommended when handling dusty and abrasive materials which contribute to shut-downs and hanger bearing failures. They should not be used when handling hot materials (over 250°F) or wet sticky materials or when handling nonabrasive materials when an inexpensive hanger will do the job satisfactorily. Maximum trough loading should not exceed 15%. The air, at approximately 1¼ PSI, enters the housing at the top, passes over and around the bearing, and is dissipated around the coupling shaft on both sides of the housing. Only 3 to 7 cu. ft. of air per minute is required to keep each hanger bearing clean.

Screw Diameter	Part Number	Shaft Dia.	Weight Each	A	B	C	D	F	H	L	T
9	9CHAPH3	1½	15	10	¾	4½	6¾	1¼	1	2	¼
	9CHAPH4	2	20		¾						
12	12CHAPH4	2	30	13	½	5	7¾	1¼	1¼	2	¼
	12CHAPH5	2⅞	52							3	
	12CHAPH6	3	68							3	
14	14CHAPH5	2⅞	60	15	½	5	9¼	1¼	1¾	3	¾
	14CHAPH6	3	74							3	
16	16CHAPH6	3	77	17	½	5	10¾	1¼	1¾	3	⅞
18	18CHAPH6	3	91	19	¾	6	12¾	1¾	1¾	3	½
20	20CHAPH6	3	105	21	¾	6	13½	1¾	1¾	3	½
	20CHAPH7	3⅞	140							4	
24	24CHAPH7	3⅞	155	25	¾	6	16½	1¾	1¾	4	½

Space required on coupling for hanger. Air supply should be clean and dry.

Dimensions in inches. Weight in pounds.

Hangers

Style 30

No. 30 hangers are designed for side mounting within the conveyor trough on the non-carrying side and permit a minimum of obstruction of material flow. Available with friction type bearing.

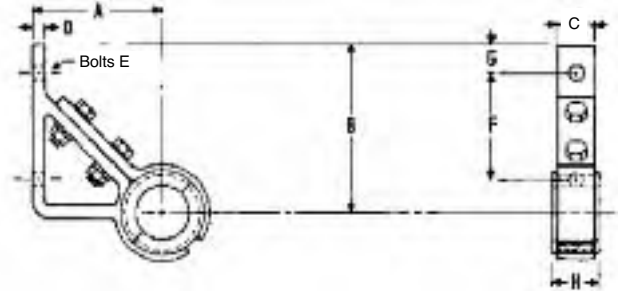
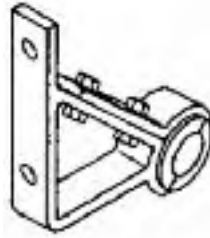

Conveyor Diameter	Coupling Diameter	Part Number*	A	B	C	D	E	F	G	H	Weight Each
6	1½	6CH303	3½	4¼	1½	¾	⅝	3¾	½	2	3
9	1½	9CH303	5	5⅝	1½	¾	¾	4¼	½	2	6
	2	9CH304	5	5⅝	1½	½	¾	4¼	½	2	8
10	1½	10CH303	5½	6⅝	1½	¾	½	4¾	¾	2	8
	2	10CH304	5½	6⅝	1½	½	½	4¾	¾	2	9
12	2	12CH304	6½	7⅞	1½	½	½	5½	¾	2	12
	2⅞	12CH305	6½	7⅞	2	½	½	5½	¾	3	18
	3	12CH306	6½	7⅞	2	½	½	5½	¾	3	20
14	2⅞	14CH305	7½	9	2	½	¾	6⅝	⅞	3	20
	3	14CH306	7½	9	2	½	¾	6⅝	⅞	3	22
16	3	16CH306	8½	10⅞	2	¾	¾	8	1	3	32
18	3	18CH306	9½	11⅞	2	¾	¾	9	1¼	3	30
	3⅞	18CH307	9½	11⅞	3	¾	¾	9	1¼	4	33
20	3	20CH306	10½	13¼	2	¾	¾	10¼	1¼	3	32
	3⅞	20CH307	10½	13¼	3	¾	¾	10¼	1¼	4	38
24	3⅞	24CH307	12½	16¼	3	¾	¾	12¾	1½	4	46

*Refer to Page H-101 for bearings
NOTE: For hangers with oil pipe add -0 to part number

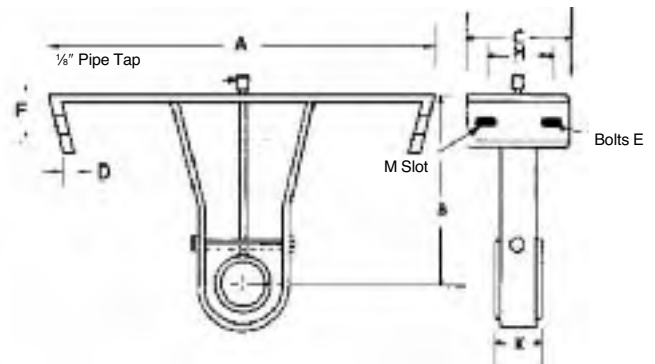
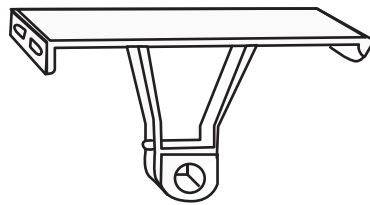

Style 216F

No. 216F hangers are designed for heavy duty applications and are mounted inside of flared trough. Hard iron or bronze bearings are normally furnished; however, other bearings are available.

Conveyor Diameter	Coupling Diameter	Part Number*	A	B	C	D	E	F	H	K	Weight Each	M Slot
6	1½	6CH216F3	14	7	4	¾	¾	⅞	2½	2	9	⅞ × ¼
9	1½	9CH216F3	18	9	4	¾	¾	⅞	2½	2	14	⅞ × ¼
	2	9CH216F4									17	
12	2	12CH216F4	22	10	5	¾	½	1⅞	2½	2	24	¾ × ¼
	2⅞	12CH216F5								28		
	3	12CH216F6								32		
14	2⅞	14CH216F5	24	11	5	¾	½	1⅞	2½	3	31	¾ × ¼
	3	14CH216F6								34		
16	3	16CH216F6	28	11½	5	¾	½	1⅞	2½	3	38	¾ × ¼
18	3	18CH216F6	31	12⅞	5	½	¾	1½	3½	3	52	1⅞ × ⅞
	3⅞	18CH216F7								4	61	
20	3	20CH216F6	34	13½	5	½	¾	1½	3½	3	55	1⅞ × ⅞
	3⅞	20CH216F7								4	64	
24	3⅞	24CH216F7	40	16½	5	½	¾	1½	3½	4	71	1⅞ × ⅞

*Refer to Page H-101 for bearings
NOTE: For hangers with oil pipe add -0 to part number

Style 60

No. 60 hangers are furnished with a heavy duty, permanently lubricated and sealed, self-aligning ball bearing which permits temperatures up to 245° F. and will allow for up to 4° shaft misalignment. This hanger is mounted on top of the trough flanges. Grease fitting can be furnished if specified.

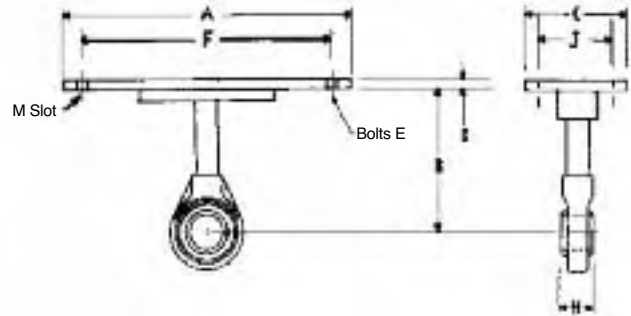
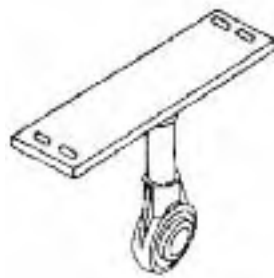

Conveyor Diameter	Coupling Size	Part Number*	A	B	C	D	E	F	H	J	Weight Each	M Slot
6	1½	6CH603	9¾	4½	4	¾	¾	8¾	1⅞	2	7	⅞ × 1⅞
9	1½	9CH603	13½	6⅞	4	¼	¾	12¼	1⅞	2	8	⅞ × 1⅞
	2	9CH604	13½	6⅞	4	¼	¾	12¼	1¾	2	9	⅞ × 1⅞
10	1½	10CH603	14½	6⅞	4	¼	¾	13¼	1⅞	2	9	⅞ × 1⅞
	2	10CH604	14½	6⅞	4	¼	¾	13¼	1¾	2	10	⅞ × 1⅞
12	2	12CH604	17½	7¾	5	¾	½	15¾	1¾	2½	12	⅞ × 1⅞
	2⅞	12CH605	17½	7¾	5	¾	½	15¾	1⅞	2½	20	⅞ × 1⅞
	3	12CH606	17½	7¾	5	¾	½	15¾	2⅞	2½	30	⅞ × 1⅞
14	2⅞	14CH605	19½	9¾	5	½	½	17¾	1⅞	2½	21	⅞ × 1⅞
	3	14CH606	19½	9¾	5	½	½	17¾	2⅞	2½	32	⅞ × 1⅞
16	3	16CH606	21½	10⅞	5	½	½	19¾	2⅞	2½	35	⅞ × 1⅞
18	3	18CH606	24½	12⅞	6	½	¾	22¼	2⅞	3½	40	⅞ × 1⅞
20	3	20CH606	26½	13½	6	½	¾	24¼	2⅞	3½	45	⅞ × 1⅞
24	3⅞	24CH607	30½	16½	6	¾	¾	28¼	2⅞	3¾	58	⅞ × 1⅞

*For hangers with oil pipe add -0 to part number

Style 70

No. 70 hangers are furnished with a heavy duty, permanently lubricated and sealed, self-aligning ball bearing which permits temperatures up to 245° F. and will allow for up to 4° shaft misalignment. This hanger is mounted inside the trough. Grease fitting can be furnished if specified.

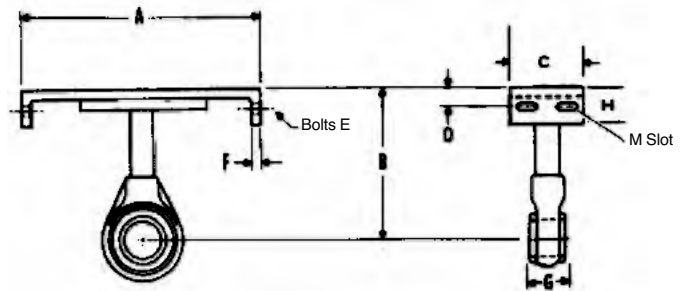

Conveyor Diameter	Coupling Size	Part Number*	A	B	C	D	E	F	G	H	Weight Each	M Slot
6	1½	6CH703	7	4½	4½	¾	¾	¾	1⅞	1½	7	⅞ × 1⅞
9	1½	9CH703	10	6⅞	4½	1	¾	¼	1⅞	1¾	8	⅞ × 1⅞
	2	9CH704	10	6⅞	4½	1	¾	¼	1¾	1¾	9	⅞ × 1⅞
10	1½	10CH703	11	6⅞	4½	1	¾	¼	1⅞	1¾	9	⅞ × 1⅞
	2	10CH704	11	6⅞	4½	1	¾	¼	1¾	1¾	10	⅞ × 1⅞
12	2	12CH704	13	7¾	5	1¼	½	¾	1¾	2½	12	⅞ × 1⅞
	2⅞	12CH705	13	7¾	5	1¼	½	¾	1⅞	2½	20	⅞ × 1⅞
	3	12CH706	13	7¾	5	1¼	½	¾	2⅞	2½	30	⅞ × 1⅞
14	2⅞	14CH705	15	9¾	5	1¾	½	½	1⅞	2¼	21	⅞ × 1⅞
	3	14CH706	15	9¾	5	1¾	½	½	2⅞	2¼	32	⅞ × 1⅞
16	3	16CH706	17	10⅞	5	1¾	½	½	2⅞	2¼	35	⅞ × 1⅞
18	3	18CH706	19	12⅞	6	1½	¾	½	2⅞	2½	40	⅞ × 1⅞
20	3	20CH706	21	13½	6	1½	¾	½	2⅞	2½	45	⅞ × 1⅞
24	3⅞	24CH707	25	16½	6	1¾	¾	¾	2⅞	2½	58	⅞ × 1⅞

*For hangers with oil pipe add -0 to part number

Hangers



Style 18B

The No. 18-B Hanger has streamlined cast iron frame and bearing cap held in place by a U-bolt. It is mounted inside the trough below the cover. Holes are located for bolting through the top angle of the conveyor trough. This hanger is regularly furnished with Babbitt bearings. Arguto oil impregnated wood, hard iron, bronze, or other special caps can be furnished.

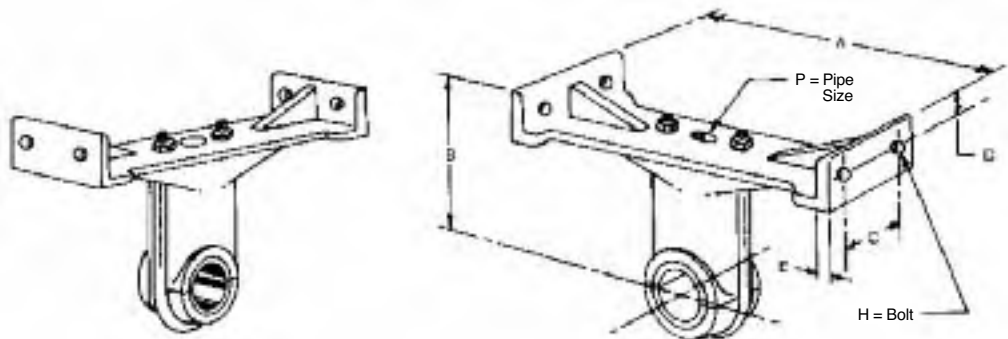

Conveyor Diameter	Bearing Bore	Thru Bore	Part Number	Weight	A	B	C	D	E	H Bolt	P
6	1½	2	6CH18B3	5	7	4¾	1½	¾	⅝	¾	⅝
9	1½ 2	2	9CH18B3	9	10	6	2¾	¾	¾	¾	⅝
		2	9CH18B4	—	10	6	2¾	¾	¾	¾	⅝
10 OBSOLETE	1½ 2	2	10CH18B3	11	11	6¼	2¾	¾	¾	¾	⅝
		2	10CH18B4	—	11	6¼	2¾	¾	¾	¾	⅝
12	2 2⅝ 3	2	12CH18B4	15	13	7¾	2¾	1	½	½	⅝
		3	12CH18B5	29	13	7¾	2¾	1	½	½	⅝
		3	12CH18B6	—	13	7¾	2¾	1	½	½	⅝
14	2⅝ 3	3	14CH18B5	25	15	9¾	2¾	1	¾	½	⅝
		3	14CH18B6	27	15	9¾	2¾	1	¾	½	⅝
16	3	3	16CH18B6	30	17	10½	2¾	1	¾	½	⅝
18	3	3	18CH18B6	35	19	12	3	1¼	¾	½	⅝

**Consult Factory

Style 19B

The No. 19-B Hanger is similar in construction to the No. 18-B except they are mounted on top of the trough angles. Built-in ledges provide supports for the ends of the cover. They are streamlined in design and permit free passage of the material.

Top hole is furnished with bronze bearing. Bottom hole can be supplied in oil impregnated wood, hard iron, or other special caps may be furnished on request.

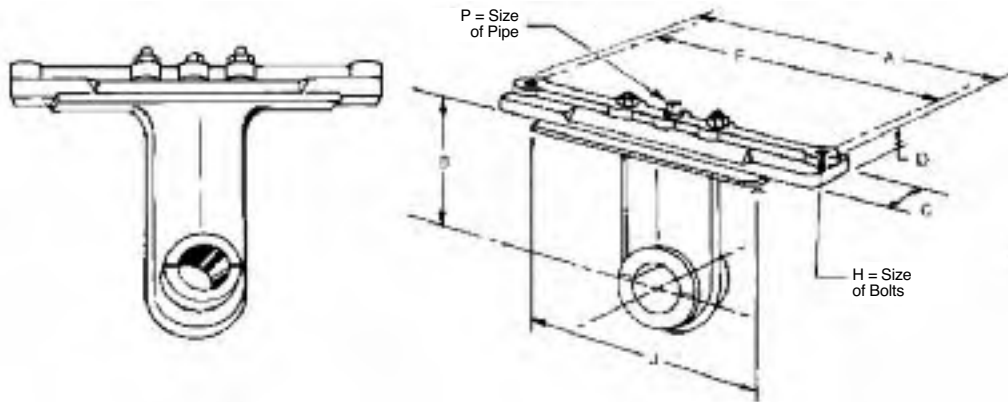

Conveyor Diameter	Bearing Bore	Part Number	Weight	A	B	C	D	F	H Bolt	J	P Pipe
6	1½	6CH19B3	8.5	9¾	4½	1⅝	¾	8¾	½	6½	¼
9	1½ 2	9CH19B3	13	13¾	6¾	1¾	1	12¼	½	9½	¼
		9CH19B4	15.5	13¾	6¾	1¾	1	12¼	½	9½	¼
10	1½ 2	10CH19B3	14	14½	6¾	1¾	1	13¾	½	10½	¼
		10CH19B4	—	14½	6¾	1¾	1	13¾	½	10½	¼
12	2 2⅝ 3	12CH19B4	24	17	7¾	2	1¼	15¾	½	12½	¼
		12CH19B5	24.5	17	7¾	2¾	1½	15¾	½	12½	¼
		12CH19B6	—	17	7¾	2¾	1½	15¾	½	12½	¼
14	2⅝ 3	14CH19B5	37	19¼	9¾	2¾	1¾	17¾	¾	14¾	¼
		14CH19B6	—	19¼	9¾	2¾	1¾	17¾	¾	14¾	¼
16	3	16CH19B6	45	21¼	10¾	3	1¾	19¾	¾	16½	¼
18	3	18CH19B6	48.5	23¼	12¾	3	1¾	22¼	¾	18½	¼
20	3⅝	20CH19B7	60.0	26¼	13¾	4	1⅞	24¼	¾	20	¼



Screw Conveyor Hanger Bearing Selection Application

BEARING MATERIAL	MAXIMUM	STYLES AVAILABLE	MATERIAL	SELF LUBE	SOME SUGGESTED USES	COMMENTS
FOOD GRADE	300°	220, 216	Yes		Food	Sugar
Gatke	400°	220, 216			Chemical	Fiberglass fabric. Good for
Martin HARD IRON	500°	220		Yes	Ghemical, Cement,	Requires Hardened Shaft
CAST HARD IRON	500°	220, 216, 19B			Liime, Cement, Salt, Gypsum	Requires hardened shaft. Can be noisy. Lubrication required in some applica-
WOOD	160°	220, 216, 19B		Yes	Grain, Feed, Fertilizer	Good general purpose.
Martin BRONZE	850°	220		Yes	Grain, Feed, Processing	High quality bearings. High load capacity.
NYLON	250°	220	Yes	Yes	Food and Grain	For dry applications.
NYLATRON	250°	220, 19B		Yes	Chemical, Handling, Grain,	Very low load capacity.
UHMW	225°	220, 216	Yes	Yes	Food	Material USDA approved. Does not swell in water.
STELLITE	1000°	220, 216			Chemical, Cement, Aggregate	Requires Stellite insert in shaft.
INDUSTRIAL GRADE ENGINEERED NYLON	160°	220		Yes	Grain, Feed, Fertilizer	Economical replacement for wood.
WHITE MELAMINE	190°	220	Yes		Food & Sugar	Suitable for repeat use in food contact applications at temps not exceeding 190°F.
FOOD GRADE ENGINEERED	300°	220	Yes	Yes	Food, Grain, Fertilizer	For dry application.
BALL BEARING	180°	60, 70			Non-abrasive applications	General purpose use.
Martin HDPE	200°	220	Yes	Yes	Grain, Feed, Chemical Handling	Recommended for non-abrasive applications
CERAMIC 1	1,000°	220, 216	Yes		Chemical, Cement, Food	Requires hardened shafts.
Martin URETHANE	200°	220		YES	Grain, Chemical, Fertilizer	Good general purpose.

CONVEYORS

¹ Higher temperature ceramics are available.

Hanger Bearings



Hanger Type	Shaft	Part Number	Bearing
216	1½	CHB2163*	
	2	CHB2164*	
230	2½	CHB2165*	
	3	CHB2166*	
316	3¾	CHB2167*	

*H—Hard Iron *W—Wood *O—Oil Hole Top Cap *BR—Bronze *U—UHMW *G—Gatke *C—Ceramic *St—Stellite *UR—Urethane
 *MSB-PTFE
 * Oil hole is furnished on hard iron and bronze standard.

Hanger Type	Shaft	Part Number	Bearing
220	1½	CHB2203*	
	2	CHB2204*	
226	2½	CHB2205*	
326	3	CHB2206*	
30	3¾	CHB2207*	

*H—Cast Hard Iron with oil hole *W—Wood *N—Nylatron *P—HDPE *Gatke
 MHI—*Martin* Hard iron (oil impregnated) *MCB—Melamine *C—Ceramic *WN—White Nylon
 *MBR—*Martin* Bronze (oil impregnated) *U—UHMW *UR—Urethane *MSB-PTFE

CONVEYORS

Hanger Type	Shaft	Part Number	Bearing
60 Ball Bearing	1½	CHB603	
	2	CHB604	
70 Ball Bearing	2½	CHB605	
	3	CHB606	
	3¾	CHB607	

Note: New style bearings are available with slinger shield one side.



Hanger Type	Shaft	Part Number	Bearing
18B	1½	CHB18B3*	
	2	CHB18B4*	
	2½	CHB18B5*	
19B	3	CHB18B6*	
	3¾	CHB18B7*	

*W—Wood *H—Hard Iron *N—Nylatron *G—Gatke

Note: Furnished as bottom cap only

Trough Cover	14	TCP	14	-12	— Length of Cover
	Conveyor Diameter	Type			Cover Thickness
		TCP — Plain			16 — 16 GA.
		TCS — Semi Flanged			14 — 14 GA.
		TCF — Flanged			12 — 12 GA.
		TCH — Hip Roof			10 — 10 GA.
		TSC — Shroud			

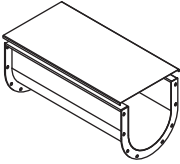
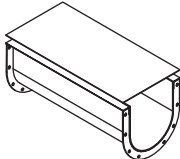
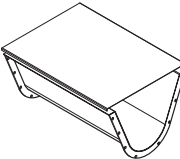
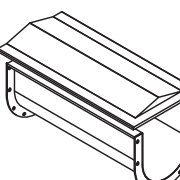
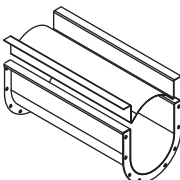
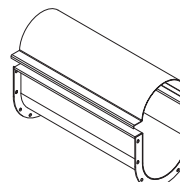
It is the responsibility of the contractor, installer, owner and user to install, maintain and operate the conveyor components and conveyor assemblies manufactured and supplied by *Martin* in such a manner as to comply with the Williams-Steiger Occupational Safety and Health Act and with all state and local laws and ordinances and the American National Standard Institute Safety Code.

Flanged Covers		Most commonly used. Can be supplied with gaskets and butt straps for dust tight applications. Semi-flanged must be furnished if spring clamps are used.
Flat Covers		Usually used only to cover conveyor for safety.
Flared Trough Covers		Usually flanged type and heavier gauges because of span.
Hip Roof Covers		Hip roof covers are similar to conventional flanged covers except they are peaked slightly to form a ridge along the center of the cover. A welded end plate closes the peaked section at each end of the trough while intermediate joints are usually buttstrap connected. Hip roof covers are usually recommended for outdoor installations to prevent accumulation of moisture. They are also often used in applications where a more rigid cover is required.
Shroud Covers		Used to approximate tubular cross section for inclined or feeder applications.
Domed Covers		Domed covers are half circle domes rolled to the same inside diameter as the trough bottom and are flanged for bolting to the trough top rails. They are used where venting of fumes or heat from the material being conveyed is required. End sections have a welded end plate and intermediate joints are buttstrap connected. Vent pipes or suction lines can be attached to the cover.
Feeder Shrouds		Shrouds are used in trough sections of screw feeders to decrease the clearance between the cover and feeder screw to obtain proper feed regulation. Lengths are sufficient to prevent flushing of the majority of materials being handled and gauges are proportioned to trough size and gauge.

Trough Cover

Plain Cover

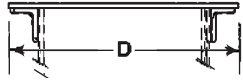

Semi-flanged Cover

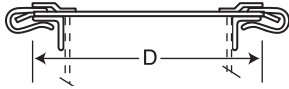

All conveyor troughs should have some type of cover not only to keep material inside the trough and to protect material in the trough from outside elements, **but trough definitely should be covered as a safety measure**, preventing injuries by keeping workers clear of the moving parts inside the conveyor trough. See H-123, Safety.

Flanged Cover



Hip Roof Cover

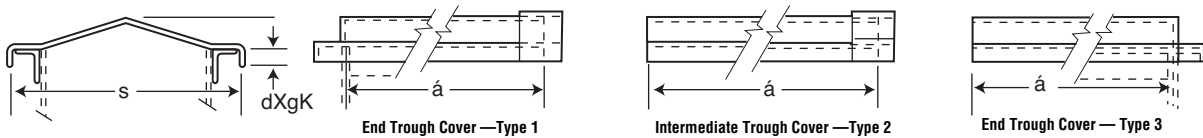

Conveyor Diameter	Plain Cover				Plain Semi-Flanged Cover				Flanged Cover				Hip Roof Cover			
	Part Number	Thick-ness Ga.	Wt. Per Ft.	D	Part Number	Thick-ness Ga.	Wt. Per Ft.	D	Part Number	Thick-ness Ga.	Wt. Per Ft.	D	Part Number	Thick-ness Ga.	Wt. Per Ft.	D
4	4TCP16	16	1.5	8	4TCS16	□ 16	2.1	7¼	4TCF16	□ 16	1.9	8%	4TCH16	□ 16	2.0	8%
*					4TCS14	14	2.6		4TCF14	14	2.4		4TCH14	14	2.5	
6	6TCP16	16	2.0	9¾	6TCS16	□ 16	2.3	9¾	6TCF16	□ 16	2.1	10%	6TCH16	□ 16	2.3	10%
*					6TCS14	14	3.8		6TCF14	14	2.6		6TCH14	14	2.8	
9	9TCP14	14	3.5	13%	9TCS14	□ 14	4.1	13%	9TCF16	16	3.2	14	9TCH16	16	3.3	14
*					9TCS12	12	5.7		9TCF14	□ 14	3.9		9TCH14	□ 14	4.1	
					9TCS10	10	7.3		9TCF12	12	5.5					
									9TCF10	10	7.1					
10	10TCP14	14	3.8	14%	10TCS14	□ 14	4.4	14%	10TCF16	16	3.4	15	10TCH16	16	3.5	15
*					10TCS12	12	6.1		10TCF14	□ 14	4.2		10TCH14	□ 14	4.3	
					10TCS10	10	7.8		10TCF12	12	5.9					
									10TCF10	10	7.6					
12	12TCP14	14	4.6	17½	12TCS14	□ 14	5.1	17%	12TCF14	□ 14	4.9	18	12TCH14	□ 14	5.0	18
**					12TCS12	12	7.1		12TCF12	12	6.9		12TCH12	12	7.1	
					12TCS10	10	9.0		12TCF10	10	8.8					
14	14TCP14	14	5.1	19½	14TCS14	□ 14	5.6	19%	14TCF14	□ 14	5.4	19%	14TCH14	□ 14	5.5	19%
**					14TCS12	12	7.8		14TCF12	12	7.6		14TCH12	12	7.7	
					14TCS10	10	9.9		14TCF10	10	9.7					
16	16TCP14	14	5.6	21½	16TCS14	□ 14	6.1	21%	16TCF14	□ 14	5.9	21%	16TCH14	□ 14	6.1	21%
**					16TCS12	12	8.5		16TCF12	12	8.3		16TCH12	12	8.5	
					16TCS10	10	10.8		16TCF10	10	10.6					
18	18TCP12	12	8.9	24½	18TCS12	□ 12	9.6	24½	18TCF14	14	6.7	25	18TCH14	14	6.8	25
**					18TCS10	10	12.3		18TCF12	□ 12	9.4		18TCH12	□ 12	9.5	
									18TCF10	10	12.1					
20	20TCP12	12	9.7	26½	20TCS12	□ 12	10.3	26½	20TCF14	14	7.2	27	20TCH14	14	7.4	27
**					20TCS10	10	13.3		20TCF12	□ 12	10.1		20TCH12	□ 12	10.4	
									20TCF10	10	13.1					
24	24TCP12	12	11.1	30½	24TCS12	□ 12	11.8	30½	24TCF14	14	8.3	31	24TCH14	14	8.4	31
**					24TCS10	10	15.1		24TCF12	□ 12	11.6		24TCH12	□ 12	11.8	
									24TCF10	10	14.9					

For average applications where dust confinement is not a problem, 2'-0" centers or 10 fasteners per 10'-0" section are generally satisfactory. For commercially dust tight 1'-0" centers or 20 fasteners per 10'-0" section are suggested.

*L — Standard lengths are 5'-0" & 10'-0"

**L — Standard lengths are 5', 6', 10' & 12'-0"

□ — Standard gauge

Flanged Conveyor Inlets

The two styles of flanged conveyor inlets are designed for either bolting or welding to flat or flanged conveyor trough cover. The inlet size and bolt arrangement is the same as the standard conveyor discharge spout.

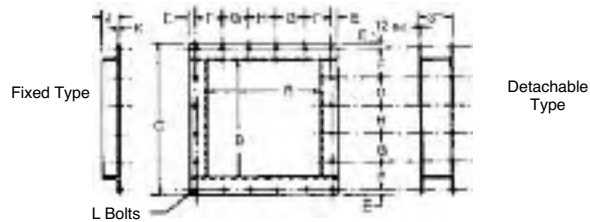

Conveyor Diameter	Part Number		Weight	B	C		E		F	G	H	J	K	L
	Fixed Inlet	Detachable Inlet			Fixed Inlet	Detachable Inlet	Fixed Inlet	Detachable Inlet						
4	4CIF	4CID	1.8	5	7½	7½	¾	¾	2¼	—	2¼	1¼	⅜	¼
6	6CIF	6CID	5.0	7	10	10	1¼	1¼	2⅞	—	3	1½	⅜	⅜
9	9CIF	9CID	6.8	10	13	13	½	½	4	—	4	1½	⅜	⅜
10	10CIF	10CID	7.4	11	14¼	14¼	½	½	4⅞	—	4⅞	1½	⅜	⅜
12	12CIF	12CID	12.1	13	17¼	17¼	¾	¾	5½	—	5¼	2	⅜	⅜
14	14CIF	14CID	13.7	15	19¼	19¼	¾	¾	3½	3½	3½	2	⅜	⅜
16	16CIF	16CID	15.8	17	21¼	21¼	¾	¾	3¾	4	4	2	⅜	⅜
18	18CIF	18CID	29.0	19	24¼	24¼	1	1½	4⅞	4¾	4¾	2½	⅜	½
20	20CIF	20CID	31.8	21	26¼	26¼	1	1½	4¾	4¾	4¾	2½	⅜	½
24	24CIF	24CID	37.2	25	30¼	30¼	1	1½	5	5	5½	2½	⅜	½

Spring Clamps

Spring Clamps are used to attach plain and semi-flanged covers to trough. These clamps are normally riveted to the trough flange and will pivot to allow removal of cover.

Spring Clamp

Clamp No.	A	B	C	D	E	F	G	H	J	Wt.
SPC—1	⅝	⅝	¼	1¼	1¾	1½	3	1	⅝	.38

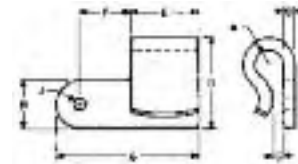

Spring Clamps

Spring Clamps with Cover Bracket

Spring Clamps with cover brackets are designed to attach to the top side of semi-flanged and plain covers.

Spring Clamp with Cover Bracket

Clamp No.	A	B	C	D	E	F	G	H	J	Wt.
SPCA—1	1¼	¾	⅝	1¼	1¾	¾	¾	¾	1¼	.50

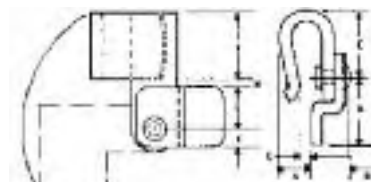

Spring Clamps with Brackets

Screw Clamps

Screw Clamps are a simple and effective means of attaching flanged or flat covers to trough. Screw Clamps available in mild steel, stainless steel and zinc plated.

Screw Clamp

Clamp No.	A	B	C	D	E	F	G	Wt.
CSC—2	2¼	1	1¼	1¼	⅝	¾	¾	.42

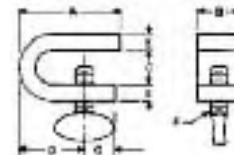

Screw Clamps

Cover Gaskets

	Red Rubber	Sponge Rubber	White Rubber
Conv. Dia.	Size	Size	Size
4.6	RR125• ⅝ X 1¼	SP75• ⅝ X ¾	WN125• ⅝ X 1¼
9, 10	RR150• ⅝ X 1½	SP100• ⅝ X 1	WN150• ⅝ X 1½
12, 14, 16	RR200• ⅝ X 2	SP150• ⅝ X 1½	WN250• ⅝ X 2
18, 20, 24	RR250• ⅝ X 2½	SP200• ⅝ X 2	WN250• ⅝ X 2½

Toggle Clamps

Quick acting toggle clamps are used to attach covers for quick accessibility. Normally this type clamp is attached by welding the front or top of clamp to the trough and can be adjusted to fit all sizes of trough, while allowing 90° to clear working area.

Conveyor	Part Number	No. Required per 10' Section	A	B	C	D	E	F	G
4—24	QTC	6 to 8	7⅞	2⅞	1⅞	2	1¼	⅝	⅝

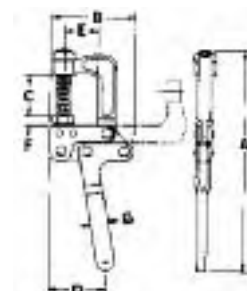

Toggle Clamps

Feeder Shrouds



Feeder Shrouds

Shrouds are used in trough sections of screw feeders to decrease the clearance between the cover and feeder screw to obtain proper feed regulation. Lengths are sufficient to prevent flushing of the majority of materials being handled and gauges are proportioned to trough size and gauge.

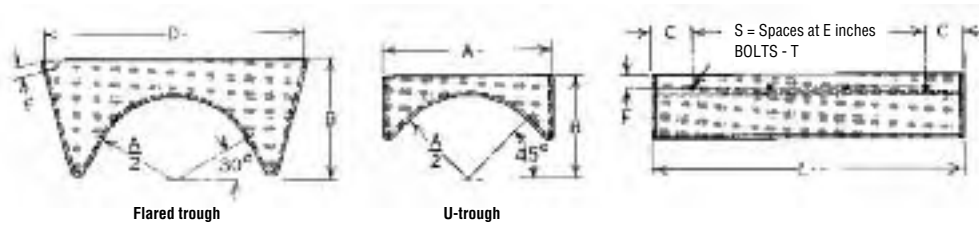

Screw Diameter Inches	Part No.		Shroud Thickness	A	B		C	D	E	F		L	T	S
	U	Flared			U	Flared				U	Flared			
4	4TFS14	4FFS14	14 Ga.	5	3%	—	2	—	4	3/8	—	8	1/4	1
6	6TFS14	6FFS14	14 Ga.	7	4 1/2	7	3	14	6	3/4	3/4	12	5/16	1
	6TFS12	6FFS12	12 Ga.	7	4 1/2	7	3	14	6	3/4	3/4	12	5/16	1
9	9TFS14	9FFS14	14 Ga.	10	6%	9	3	18	6	7/8	3/4	18	3/8	2
	9TFS7	9FFS7	3/16"	10	6%	9	3	18	6	7/8	3/4	18	3/8	2
10	10TFS14	10FFS14	14 Ga.	11	6%	—	2 1/2	—	5	7/8	—	20	3/8	3
	10TFS7	10FFS7	3/16"	11	6%	—	2 1/2	—	5	7/8	—	20	3/8	3
12	12TFS12	12FFS12	12 Ga.	13	7%	10	3	22	6	1 1/8	1	24	3/8	3
	12TFS7	12FFS7	3/16"	13	7%	10	3	22	6	1 1/8	1	24	3/8	3
14	14TFS12	14FFS12	12 Ga.	15	9%	11	3 1/2	24	7	1 1/8	1	28	3/8	3
	14TFS7	14FFS7	3/16"	15	9%	11	3 1/2	24	7	1 1/8	1	28	3/8	3
16	16TFS12	16FFS12	12 Ga.	17	10%	11 1/2	4	28	8	1 1/8	1	32	3/8	3
	16TFS7	16FFS7	3/16"	17	10%	11 1/2	4	28	8	1 1/8	1	32	3/8	3
18	18TFS12	18FFS12	12 Ga.	19	12%	12%	4 1/2	31	9	1 1/8	1 1/8	36	3/8	3
	18TFS7	18FFS7	3/16"	19	12%	12%	4 1/2	31	9	1 1/8	1 1/8	36	3/8	3
20	20TFS10	20FFS10	10 Ga.	21	13 1/2	13 1/2	4	34	8	1 1/8	1 1/8	40	3/8	4
	20TFS7	20FFS7	3/16"	21	13 1/2	13 1/2	4	34	8	1 1/8	1 1/8	40	3/8	4
24	24TFS10	24FFS10	10 Ga.	25	16 1/2	16 1/2	4	40	8	1 1/8	1 1/8	48	3/8	5
	24TFS7	24FFS7	3/16"	25	16 1/2	16 1/2	4	40	8	1 1/8	1 1/8	48	3/8	5

CONVEYORS

Conveyor Shrouds

Conveyor shroud covers are used to form a tubular cross section within the conveyor trough. This arrangement gives the features of a tubular housing while allowing removal of the shroud for easy access and cleaning. Flat or flanged covers can be used over the shroud cover when it is objectionable for the recess in the shroud to be exposed to dust or weather. Various types of shrouds are furnished to fit various applications. These types are described below.



Type 1

Type 1 Shroud cover has flanged sides over top rail and flanged ends at both ends. This type is used when shroud is full length of trough or between hangers.



Type 2

Type 2 Shroud cover has flanged sides over top rails and flanged ends on one end over trough end; other end is plain. This type shroud is used at an inlet opening or next to a hanger at the plain end.



Type 3

Type 3 Shroud cover has flanged sides over top rail and both ends closed and no flanges over ends. This type shroud is used between hangers.

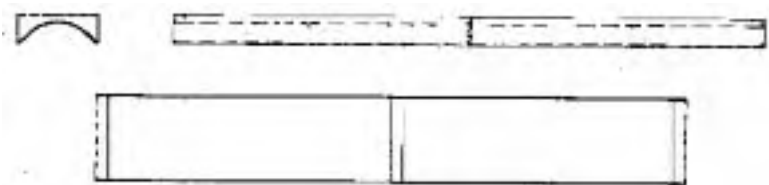

Type 4

Type 4 Shroud cover has no flanges at sides or ends. Bolt holes are provided along sides, for bolting through side of trough. This allows flush mounting with top of trough and a cover may be used over the shroud. This shroud is used mostly for short lengths when installed ahead of an inlet opening.

SECTION IV

SPECIAL FEATURES SECTION IV

Covers	H-109
Trough Ends.....	H-110
Trough	H-111
Conveyor Screws	H-114
Discharges	H-119
Inlets	H-120

Special Features

The information presented in this section gives descriptions and functions of the most commonly used special features available in the design of conveyor systems.

These special features will greatly broaden the range of uses for screw conveyor when added to the many standard features available. Standard features and components are always more desirable and practical in the design of a screw conveyor system; however, one or more of these special features may sometimes be required in special applications for a workable or more efficient system.



OVERFLOW COVER sections are used as a safety relief to handle overflow over the discharge in cases where the discharge may become plugged. It is a short section of flanged or flat cover hinged across the width to the adjoining cover. The cover is not attached to the trough in order that it can be raised by pressure from within the trough.

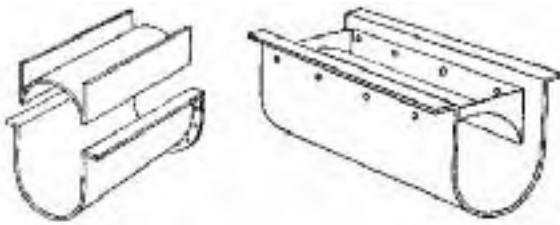

SHROUD COVERS are designed to fit inside a standard conveyor trough of a Screw Feeder or inclined conveyor, and create a tubular trough effect. This cover has an advantage over tubular trough in that ease of access is combined with the convenience of using standard hangers and accessories. An additional flat cover may be required over the shroud to prevent accumulation of dust or water in the recessed portion of the shroud cover.



EXPANDED METAL COVERS can be furnished where cover is required for safety but constant visual inspection is required. STANDARD COVERS of any design can be furnished in heavier gauges, when needed to support weight.



DOMES COVERS are half circle domes rolled to the same inside diameter as the trough bottom and are flanged for bolting to the trough top rails. They are used where venting of fumes or heat from the material being conveyed is required. End sections have a welded end plate and intermediate joints are buttstrap connected. Vent pipes or suction lines can be attached to the



DUST SEAL COVERS are flanged down on all four sides to match channel sections fabricated on the sides, ends, and cross channels of special dust seal troughs. The length of the cover should not exceed one-half the length of the trough section.



HINGED COVERS may be constructed from conventional flat covers or most special covers. They are equipped with a hinge on one side for attaching to the trough and are bolted or clamped to the trough on the other side. Hinged covers are used in applications where it is not desirable to have a loose cover, such as in high areas above walkways where the cover might fall.

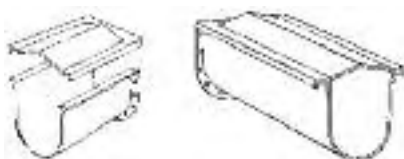

HIP ROOF COVERS are similar to conventional flanged covers except they are peaked slightly to form a ridge along the center of the cover. A welded end plate closes the peaked section at each end of the trough while intermediate joints are usually buttstrap connected. Hip roof covers are usually recommended for outdoor installations to prevent accumulation of moisture. They are also often used in applications where a more rigid cover is required.

Trough Ends

Martin

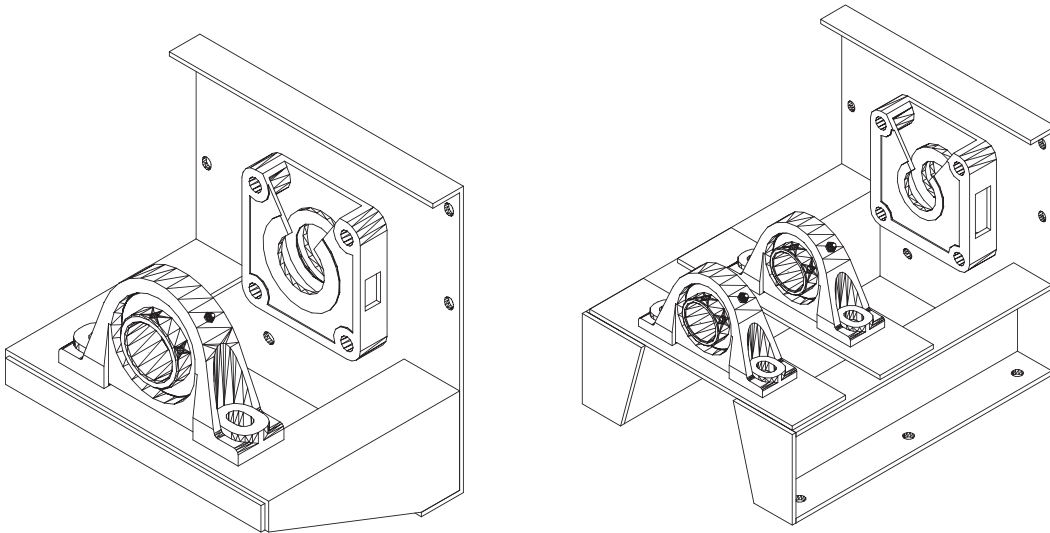

SHELF-TYPE TROUGH ENDS are furnished with outboard bearing pedestals for mounting pillow block bearings. The bearings are mounted away from the trough end plate allowing ample room to protect the bearing when handling abrasive or hot materials. This arrangement allows the use of most any type shaft seal desired. Either one or two bearings can be used.

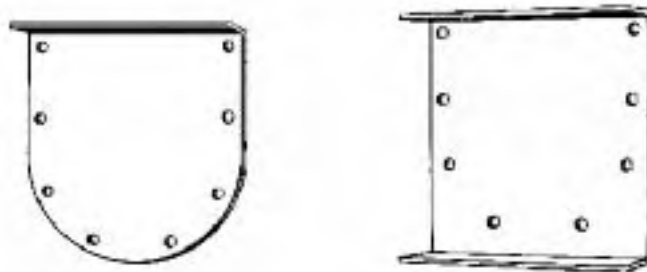

BLIND TROUGH ENDS are used on the tail end (normally the inlet end) of a conveyor, when sealing the end shaft is extremely difficult. A hanger is used inside the trough to support the tail shaft without the shaft projecting through the trough end.

A blind trough end plate can also be furnished with a dead shaft welded to the end plate. For this type the screw is bushed with an antifriction bearing to carry the radial load of the screw. When required, a grease fitting can be furnished through the dead shaft for lubricating the bearing.

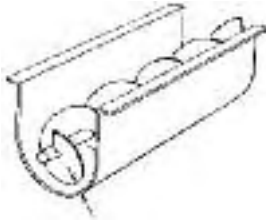

WIDE CLEARANCE TROUGH is of conventional construction except with a wider clearance between the outside of the conveyor screw and the inside of the trough. This type trough is used when it is desirable to form a layer of conveyed material in the trough. The material thus moves on itself, protecting the trough from undue wear. By using a wide clearance or oversize trough, a greater capacity than using a standard conveyor screw can be obtained for some materials that travel as a mass. When wide clearance trough is required, it is more economical to use a standard conveyor screw and the next larger size standard

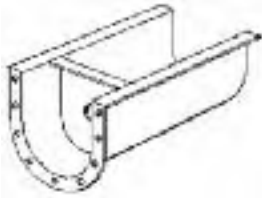

BULK HEAD is a plate or baffle shaped to the contour of the inside of the trough and is normally welded or bolted six to twelve inches from the trough end. The bulk head protects the end bearing and drive unit from heat while handling hot materials, when the pocket formed is filled with packing or insulation. The bulk head can be used in the same manner to prevent damage to seals and bearings when handling extremely abrasive materials.

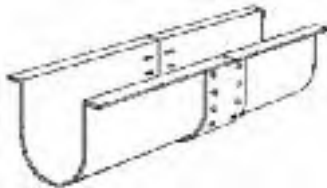

EXPANSION JOINT is a connection within a length of trough to allow for expansion caused by hot materials being conveyed. The expansion joint is constructed with bolts fastened in slots to allow for expansion or with a telescoping type slip joint. The number of joints and amount of expansion will depend on the application.

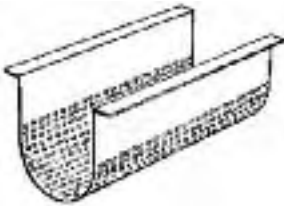

PERFORATED BOTTOM TROUGH is equipped with a perforated bottom, and is used as a screening operation or drain section when liquids are present in the conveyed material. The size of the perforations in the trough will vary depending on the material and application.

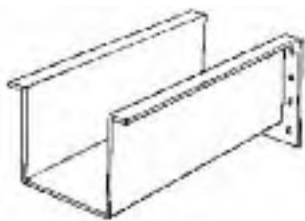

RECTANGULAR TROUGH is made with a flat bottom and can be formed from a single sheet or with sides and bottom of separate pieces. This type trough is frequently used in handling abrasive materials capable of forming a layer of material on the bottom of the trough. The material thus moves on itself, protecting the trough from undue wear. Also in handling hot materials, the material will form its own internal insulation with this type trough.



TAPERED BOTTOM TROUGH is used to prevent a dead space in the trough at the small end of a tapered conveyor screw. With some materials the tapered trough is necessary to prevent bridging in the trough, or contamination of the material.



TUBULAR TROUGH is furnished in either solid tube construction or split tube construction with flanges for bolting or clamping the two halves together. This trough is a complete tube enclosure and is used for weather-tight applications, for loading to full cross sections, and for inclined or vertical applications where fall back necessitates the housing to operate at a full loading.

Trough

Martin

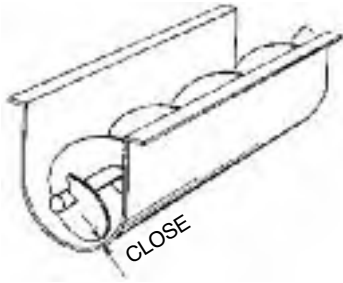

CLOSE CLEARANCE TROUGH is of conventional construction except with a closer clearance between the outside of the conveyor screw and the inside of the trough. This type trough leaves less material in the trough and is often used when a greater clean-out of conveyed material is required. This type trough also minimizes fall back of certain materials in an inclined

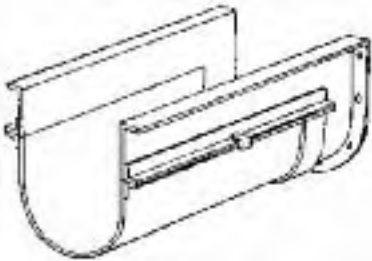

DROP BOTTOM TROUGH is equipped with either a bolted or clamped and completely removable drop bottom, or hinged on one side with bolts or clamps on the opposite side. This design offers ease in cleaning of the trough and screw conveyor, and is often used when handling food products where internal inspection and cleaning of the screw conveyor is necessary.

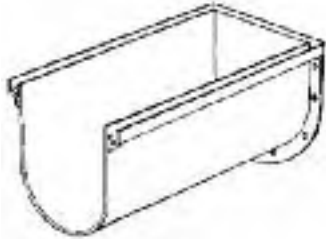

DUST SEAL TROUGH (Sometimes referred to as SAND SEAL TROUGH) has Z-bar top flanges and formed channel cross members making a continuous channel pocket around the top of the trough into which a special flanged cover is set. The channel is filled with sand or dust of the product being conveyed, thus creating an effective seal against the escape of dust from within the conveyor.

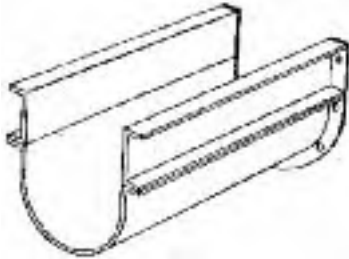

CHANNEL SIDE TROUGH is made with separate detachable trough bottoms, bolted or clamped to formed or rolled steel channels. The channels may be of any reasonable length to span widely spaced supports. This type of trough is occasionally used for easy replacement of trough bottoms, and to facilitate repairs when conveyor screw and hangers are not accessible from the top. The channel side trough can also be used without a bottom for filling bins and hoppers.

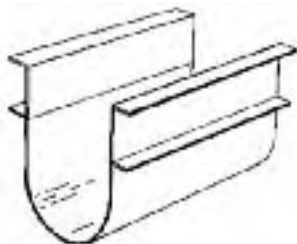

HIGH SIDE TROUGH is of conventional construction except that the trough sides extend higher than standard from the center line to the top of the trough. This type trough is frequently used in conveying materials which mat together and travel as a mass on top of the conveyor screw. High side trough will confine this type material in the trough, but still affords the necessary expansion room.

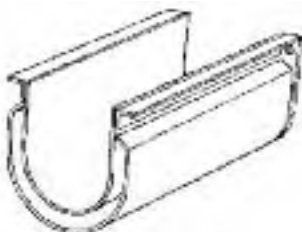

JACKETED TROUGH consists of a formed jacket continuously welded to the trough. This type trough is widely used for heating, drying or cooling of materials. Pipe connections are provided for supply and discharge of the heating or cooling media. Special construction must be provided for higher pressures.

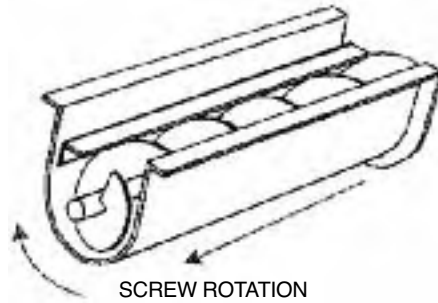

HOLD DOWN ANGLES are used to hold the conveyor screw in the trough when the conveyor is operated without intermediate hangers or when chunks of material may tend to ride under the conveyor screw and push it up. The angle is constructed of formed or regular angle iron and is attached to one side of the full length of trough far enough above the conveyor screw to allow approximately one-half inch clearance between the bottom angle and the conveyor screw.

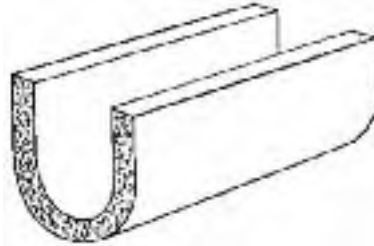

INSULATED CONVEYOR TROUGH is used when handling hot or cold materials. There are many types of insulation materials and arrangements that can be used.

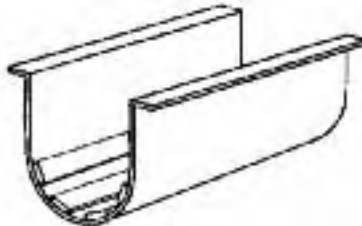

RIDER BARS are flat bars one to one and one-half inches in width running part of length or full length of the trough. Two or four bars are normally used and are spaced an equal distance apart along the curved bottom of the trough. The bars are used to support the conveyor screw to prevent wear on the trough when internal hanger bearings are not used. Rider bars are sometimes referred to as Riffing Bars when they are used to assist in conveying materials that tend to stick to the conveyor screw and rotate with it.

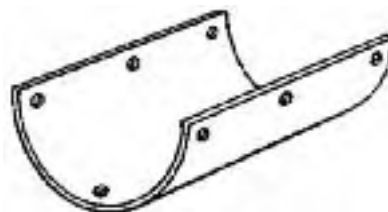

SADDLE TYPE WEAR PLATES are plates curved to the contour of the inside of the trough and of slightly less thickness than the clearance between the conveyor screw and trough. The plates are made in lengths of approximately one and one-half times the pitch of the conveyor screw and are normally spaced at intervals equal to the distance between hangers. They are used to support the conveyor screw to prevent damage to the trough when internal hanger bearings are not used.

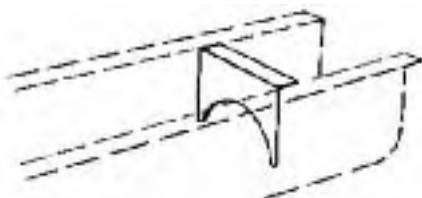

STRIKE OFF PLATE (Shroud Baffle) is a single plate bolted vertically to the upper portion of the trough and is cut out to the contour of the screw. This plate is used to regulate the flow of material from an inlet by preventing flooding across the top of the conveyor screw.

Conveyor Screws

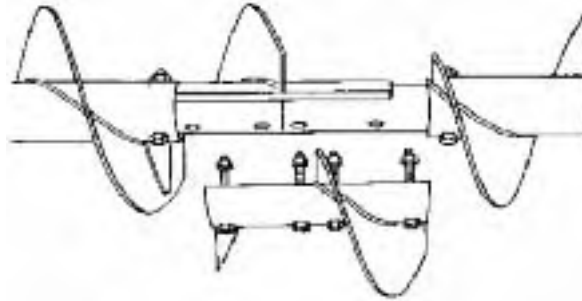

SPLIT FLIGHT COUPLINGS permit installation or removal of individual sections of conveyor screw without disturbing adjoining sections. When they are installed on both sides of each hanger, sections of screw can be removed without disturbing the hangers. These must be furnished complete with matching shafts.



WEAR FLIGHTS, or wearing shoes, attached with countersunk bolts to the carrying side of conveyor screw flights are used for handling highly abrasive materials and are easily replaceable.

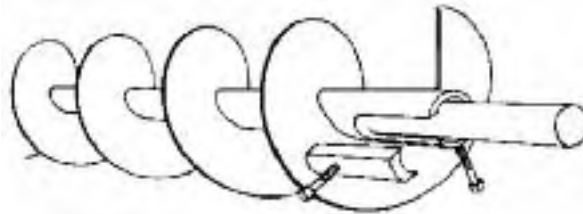

QUICK DETACHABLE KEY CONVEYOR SCREW is designed for easy removal from the conveyor trough. Each section of screw is provided with a removable key located at one end of the pipe. By removing this key, a conveyor screw section and coupling with a hanger can be quickly removed without disturbing other components.

Width of Application Chart

Screw Diameter	Standard Width of Application
6	1
9	1½
12	2
14	2
16	2½
18	2½
20	3
24	3



Helicoid



Sectional

NOTE: Weld-on type normally 1/16" thick.

HARD SURFACED FLIGHTS sometimes called abrasive resistant conveyors can be furnished using one of many hardsurfacing processes. The hard surfaced area is normally an outer portion of the face of the flight on the carrying side of the conveyor screw. This process is applied to the conveyor screw to resist wear when handling highly abrasive materials.

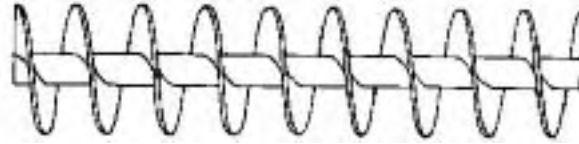

SHORT PITCH CONVEYOR SCREWS are of regular construction except that the pitch of the flights is reduced. They are recommended for use in inclined conveyors of 20 degrees slope and over, and are extensively used as feeder screws, and for controlling cross sectional loading in the balance of a conveyor when short pitch is used at the inlet opening.



TAPERING FLIGHT CONVEYOR SCREWS are frequently used as feeder screws for handling friable lumpy material from bins or hoppers and also to draw the material uniformly from the entire length of the feed opening.

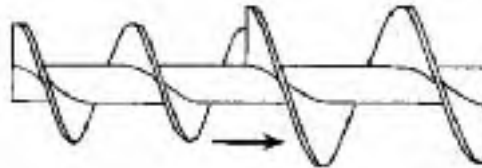

STEPPED DIAMETER CONVEYOR SCREWS consist of flights of different diameters, each with its regular pitch, mounted in tandem on one pipe or shaft. They are frequently used as feeder screws, with the smaller diameter located under bins or hoppers to regulate the flow of material.

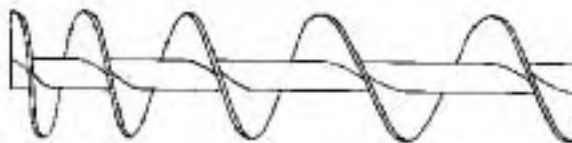

STEPPED PITCH CONVEYOR SCREWS are screws with succeeding single or groups of flights increasing in pitch and are used as feeder screws to draw free-flowing materials uniformly from the entire length of the feed opening.

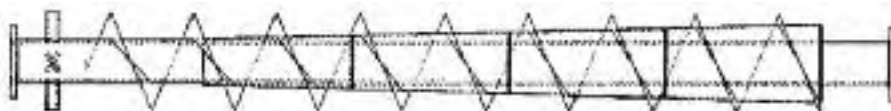

CONE SCREW to withdraw material evenly from a hopper or bin. Constant pitch reduces bridging. Requires less start-up horsepower.

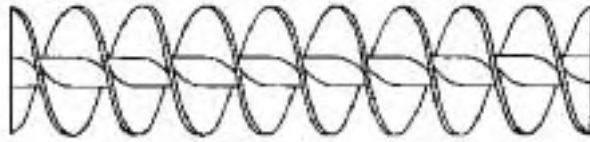

DOUBLE FLIGHT CONVEYOR SCREWS of regular pitch promote a smooth gentle flow and discharge of certain materials. Double flight can be used at hanger points only, for smooth flow past hangers.

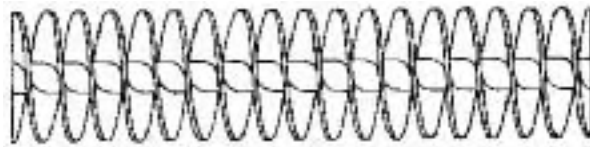

DOUBLE FLIGHT SHORT PITCH CONVEYOR SCREWS assure more accurate regulation of feed and flow in screw feeders and effectively deter flushing action of fluid materials.

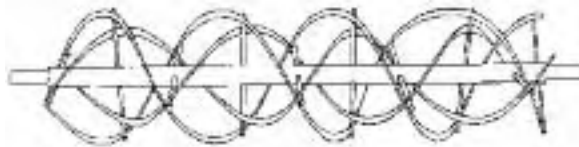

MULTIPLE RIBBON FLIGHT CONVEYOR SCREWS. This type of screw consists of two or more ribbon flights of different diameters and opposite hand, mounted one within the other on the same pipe or shaft by rigid supporting lugs. Material is moved forward by one flight and backward by the other, thereby inducing positive and thorough mixing. (Made per customer specifications.)

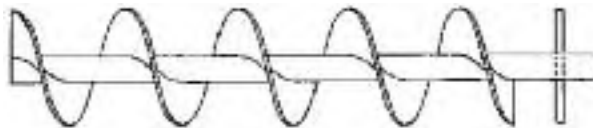

BREAKER PINS. The breaker pin is a rod approximately the same in length as the diameter of the conveyor screw and is inserted through the diameter of the pipe over the discharge to help break up lump materials.

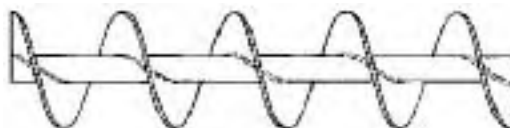

CONTINUOUS WELDING of the conveyor screw flight to the pipe can be furnished with welding one side or both sides. This welding is added to prevent stripping of flight from the pipe under extreme loads. The continuous welding can also be added to fill the slight crack between the flight and pipe for sanitary purposes.

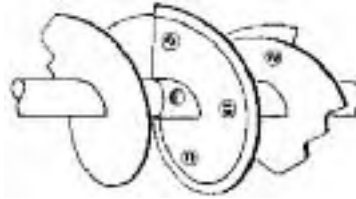

BEARING SHOES (Nylon, Teflon, Brass, and other bearing type materials.) Bearing shoes are used in place of internal bearings and are bolted to the conveyor screw. They are made from bearing type material, and when attached to the conveyor screw flight, the bearing shoe projects beyond the outer edge of flighting and rotates with the screw thereby preventing metal to metal contact between the conveyor screw and the trough. The bearing shoes extend around the helix slightly more than one pitch and are spaced along the screw at approximately the same intervals as internal bearings.

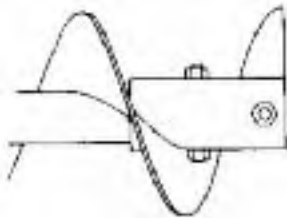

External Sleeves

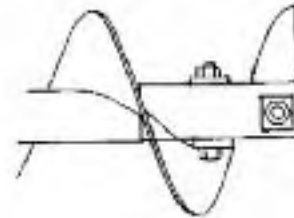

Bolt Pads

EXTERNAL SLEEVES OR BOLT PADS are added to the outside diameter of conveyor screw pipe at the end where the couplings are attached to reinforce the pipe at the bolt area.

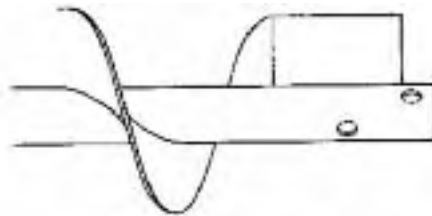

KICKER BARS are flat bars projecting from the conveyor screw pipe extending to the outside diameter of the screw over the discharge spout and are used to assist the discharge of materials.

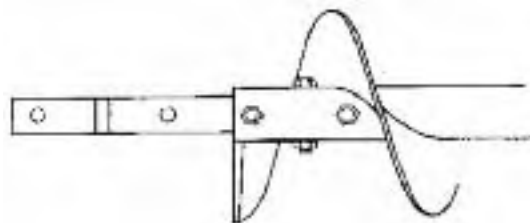

MULTIPLE HOLE DRILLING of the conveyor screw pipe and shafts will increase the torque rating of the bolted sections.

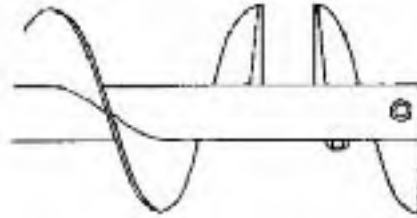

OPPOSITE HAND FLIGHTS are short sections (approximately one-half pitch) of flight added to the conveyor screw beyond the discharge point and are the opposite hand of the rest of the screw. This flight opposes the flow of material that tends to carry past the discharge spout and pack at the end plate and forces the material back to the spout for discharge.

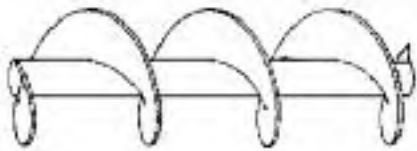

ODD DIAMETER CONVEYOR SCREW is of conventional construction except oversize or undersize in diameter. This type conveyor screw is used to provide a close clearance or wide clearance between the screw and trough and enable the use of standard component parts.



END DISC ON CONVEYOR SCREW. This disc is welded flush with the end of the conveyor screw pipe and is the same diameter as the screw. It rotates with the conveyor screw and assists in relieving the thrust of the conveyed material against the end plate shaft seal.

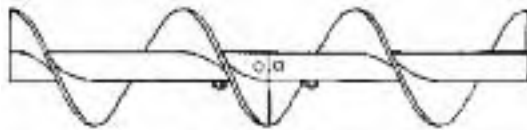

CLOSE COUPLED CONVEYOR SCREW. This type screw forms a continuous helix when two or more conveyor screws are close coupled by drilling the shaft of each to align the connecting flight.

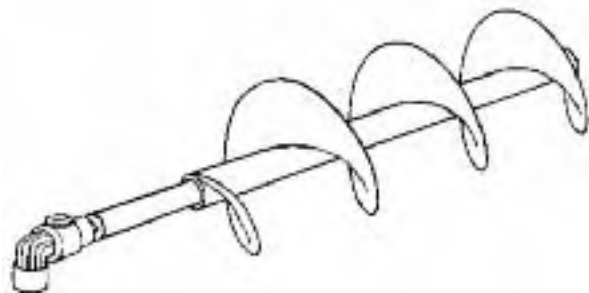

ROTARY JOINTS FOR COOLING AND HEATING are attached to one or both end shafts to provide a flow of heating or cooling media through the conveyor screw pipe.



ANGULAR DISCHARGES can be furnished when necessary for certain applications. This type discharge is normally used on inclined conveyors when it is necessary that the discharge be parallel to ground level, or at other times when material must be discharged to one side.

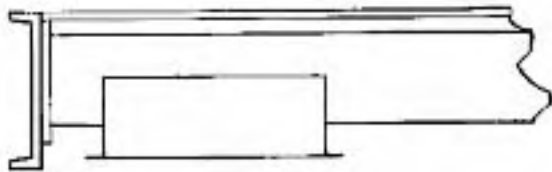

LONGER THAN STANDARD DISCHARGE SPOUTS are approximately one and one-half times the length of the standard discharge spouts. This discharge is used with materials hard to discharge due to the material trying to convey past the discharge opening. This discharge is also used when operating high speed conveyors.

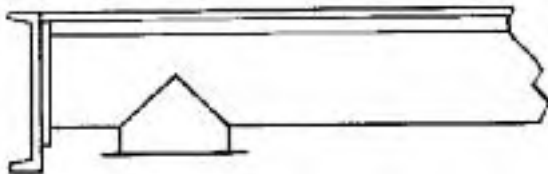

ROUND DISCHARGE SPOUTS are furnished where required for attaching tubular attachments, or when one conveyor discharges into another conveyor at an angle other than a right angle. By using a round discharge and round inlet the connection is easily made.

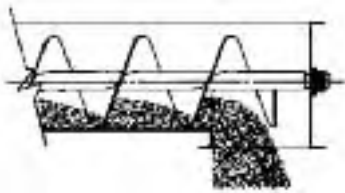

FLUSH END DISCHARGE SPOUTS are furnished with a special trough end plate constructed on trough end side of the spout. This type spout offers a complete discharge without a ledge at the end plate for material build up. It is used primarily in handling food products, where infestation may occur.



AIR OPERATED FLAT SLIDE GATES are similar in action and purpose to rack and pinion gates. The gate movement is accomplished by an air cylinder. These gates are usually employed when remote control and automatic operation is desired.

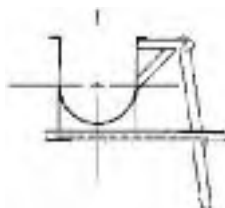

LEVER OPERATED GATES are a modification of standard slide discharges with a lever attached for opening and closing the gates. This attachment provides a leverage for ease of operation and a convenient means for quick opening and closing.

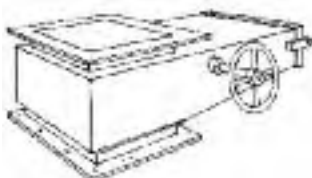

ENCLOSED DUST-TIGHT OR WEATHER-PROOF rack and pinion discharge spouts can be furnished in either flat or curved slide and are similar in construction to conventional rack and pinion slide gates except that the slide, rack, and pinion are fully enclosed in a housing.

Discharges and Inlets

Martin

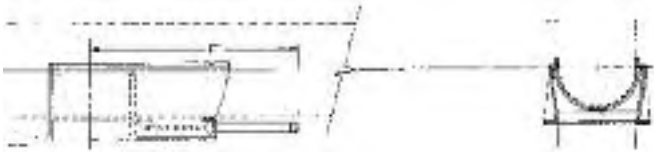

AIR OPERATED CURVED SLIDE GATES are similar to standard rack and pinion gates except they are operated with an air cylinder. The air operated gate is usually used for remote control and automatic operation. These gates can also be furnished in dust-tight or weather-proof construction with the cylinder and gate fully enclosed in the housing.

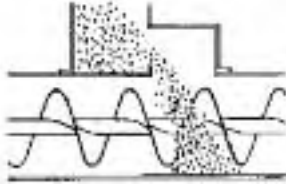

CUSHION CHAMBER INLETS (DEAD BED INLETS) serve the same purpose as the deflector plate inlet, but are constructed with a ledge that forms a cushion for materials fed into the conveyor.

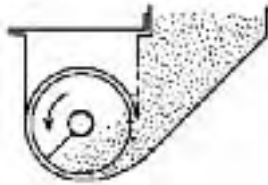

SIDE INLETS are equipped with a gate to furnish a means of regulating or stopping the inlet flow to relieve the conveyor screw from excessive material pressures. When using the side inlet, the screw rotation should be toward the inlet opening to assure a constant flow rate.

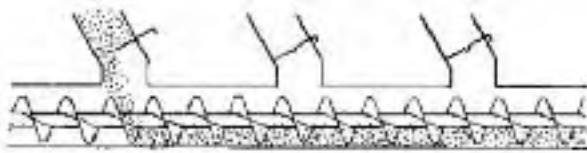

HAND SLIDE INLET GATES are normally used when multiple inlets are required. These inlets must be adjusted or closed manually to assure proper feed to the conveyor.

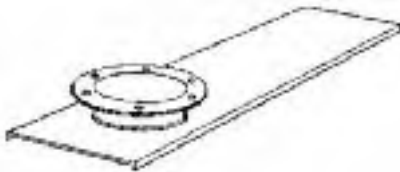

ROUND INLET SPOUTS are used for tubular attachments or when connecting the discharge of one conveyor to the inlet of another at other than a right angle. This type connection is easily made with round discharges and inlets.



DEFLECTOR PLATE INLETS are used when materials fall vertically into the inlet creating the possibility of impact damage or abrasion to the conveyor screw. The rectangular inlet is equipped with deflector plates, or baffles, that dampen the impact of the material in order to feed the conveyor more gently.

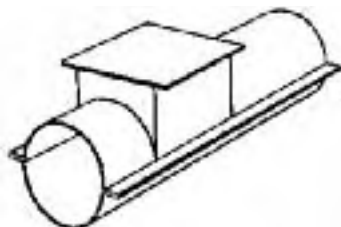

HANGER POCKETS are used with tubular trough, mounted on top of the tubular trough at hanger bearing points. The hanger pocket forms a U-shape section for a short length, allowing the use of standard conveyor hangers and providing easy access to the hanger.



INSTALLATION AND MAINTENANCE SECTION V

Installation and Erection.....	H-121
Operation and Maintenance.....	H-122
Hazardous Operations.....	H-122
Warning & Safety Reminder.....	H-123

SECTION V General

All standard screw conveyor components are manufactured in conformity with Industry Standards. Special components are usually designed and manufactured to the particular job specifications.

Screw conveyors may be ordered either as complete units or by individual components. Complete units are normally shop assembled and then match marked and disassembled for shipment and field re-assembly. When components only are ordered, shipment is made as ordered, and these components must be sorted out and aligned in field assembly.

Because shop assembled screw conveyors are pre-aligned and match marked at the factory, they are easier to assemble in the field and require the minimum installation time. When individual components are ordered, more careful alignment and assembly are required. More time is required for field installation. Assembly bolts are not included with parts orders but are included with pre-assembled units.

Caution: All *Martin* Conveyors must be assembled and maintained in accordance with this section. Failure to follow these instructions may result in serious personal injury or property damage.

Installation

Receiving

Check all assemblies or parts with shipping papers and inspect for damage. Specifically check for dented or bent trough, bent flanges, bent flighting, bent pipe or hangers or damaged bearings. If any components are severely damaged in shipment, claims should be filed immediately with the carrier. NOTE: Handle Carefully! Fork lifts should have spreader bars to lift max. 24' lengths of assembled conveyors. Lift points should not exceed 10 - 12 feet.

Erection

For shop assembled conveyors, units are match marked and shipped in longest sections practical for shipment. Field assembly can be accomplished by connecting match marked joints, and in accordance with packing list, and/or drawing if applicable. In field erection, the mounting surfaces for supporting the conveyor must be level and true so there is no distortion in the conveyor. Shims or grout should be used when required. Check for straightness as assembly is made.

For conveyor assemblies purchased as parts or merchandise, assemble as follows: Place conveyor troughs in proper sequence with inlet and discharge spout properly located. Connect the trough flanges loosely. Do not tighten bolts. Align the trough bottom center-lines perfectly using piano wire (or equivalent) then tighten flange bolts. Tighten all anchor bolts.

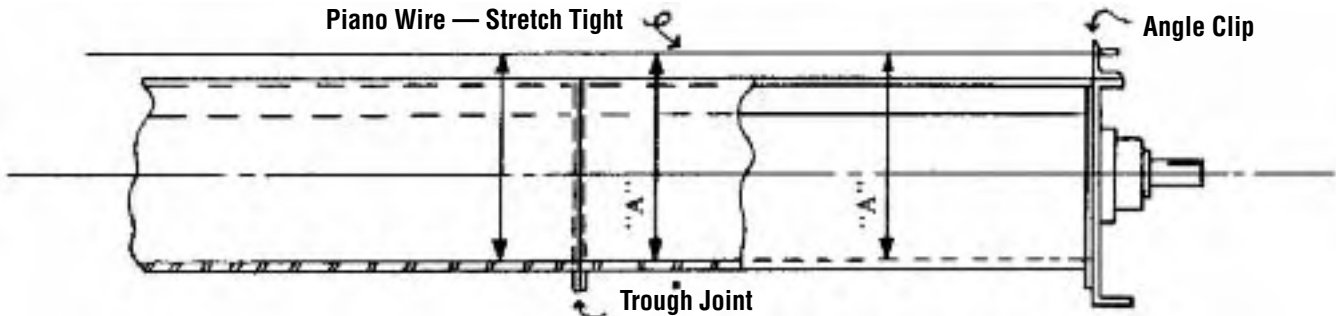

Assembly of conveyor screws should always begin at the thrust end. If the unit does not require a thrust unit, assembly should begin at the drive end. If a thrust end is designated, assemble trough end and thrust bearing. Insert the end, or drive shaft, in the end bearing. Do not tighten set screws until conveyor assembly is completed.

Place the first screw section in the trough, slipping the end, or drive shaft, into the pipe end. Secure tightly with coupling bolts. Install so that conveyor end lugs are opposite the carrying side of the flight.

Place a coupling shaft into the opposite end of conveyor pipe. Tighten coupling bolts.

Insert coupling shaft into hanger bearing and clamp hanger to trough.

Assemble alternately, conveyor screws, couplings and hangers until all screws are installed.

CONVEYORS

Installation & Maintenance



1) **With Hangers:** Assemble screw section so that flighting at each end is approximately 180° from ends of flighting of adjacent sections. Also, adjust conveyor screw and thrust unit so that hangers are equally spaced between adjacent screws.

2) **Without Hangers:** (close coupled) Assemble screws so that flighting at adjoining ends of screw sections align to produce a continuous helix surface. (Note coupling holes have been drilled in assembly to allow for flight alignment.)

Remove hanger clamps and bolt hanger to trough with the bearing centered between conveyor screws.

Install trough covers in proper sequence. Properly locate inlet openings. Handle covers with reasonable care to avoid warping or bending.

Attach covers to trough with fasteners provided.

Install drive at proper location and in accordance with separate instructions or drawing provided.

Check screw rotation for proper direction of material travel after electrical connections have been made but before attempting to handle material. Incorrect screw rotation can result in serious damage to the conveyor and to related conveying and drive equipment.

If necessary, reconnect electrical leads to reverse rotation of conveyor and direction of material flow.

Operation

Lubricate all bearings and drives per service instructions. Gear reducers are normally shipped without lubricant. Refer to service instructions for lubrication.

In start-up of the conveyor, operate several hours empty as a break in period. Observe for bearing heat up, unusual noises or drive misalignment. Should any of these occur, check the following and take necessary corrective steps. (Non-lubricated hanger bearings may cause some noise.)

1) When anti-friction bearings are used, check for proper lubrication. Insufficient or excess lubricant will cause high operating temperatures.

2) Misalignment of trough ends, screws, hangers and trough end can cause excessive maintenance and poor life expectancy.

3) Check assembly and mounting bolts; tighten if necessary.

Do not overload conveyor. Do not exceed conveyor speed, capacity, material density or rate of flow for which the conveyor and drive were designed.

If the conveyor is to be inoperative for a prolonged period of time, operate conveyor until cleared of all material. This is particularly important when the material conveyed tends to harden or become more viscous or sticky if allowed to stand for a period of time.

It may be necessary to recenter hanger bearings after running material in conveyor.

Maintenance

Practice good housekeeping. Keep the area around the conveyor and drive clean and free of obstacles to provide easy access and to avoid interference with the function of the conveyor and drive.

Establish routine periodic inspections of the entire conveyor to insure continuous maximum operating performance.

To replace conveyor screw section, proceed as follows:

1) Removal of a section, or sections, usually must proceed from the end opposite the drive. Make sure drive and electrical power are disconnected before starting to disassemble.

2) Remove the trough end, sections of screws, coupling shafts and hangers until all sections have been removed or until the damaged or worn section is reached and removed.

3) To reassemble follow the above steps in reverse order.

4) Quick detachable conveyor screws can be removed at intermediate locations without first removing adjacent sections.

Replacement parts can be identified from a copy of the original packing list or invoice.

The coupling bolt contains a lock nut that may become damaged when removed. It is recommended practice to replace them rather than re-use them when changing conveyor screw sections.

Hazardous Operations

Screw conveyors are not normally manufactured or designed to operate handling hazardous materials or in a hazardous environment.

Hazardous materials can be those that are explosive, flammable, toxic or otherwise dangerous to personnel if they are not completely and thoroughly contained in the conveyor housing. Special construction of screw and conveyor housing with gaskets and special bolted covers can sometimes be used for handling this type of material.

Special conveyors are not made or designed to comply with local, state or federal codes for unfired pressure vessels.



WARNING AND SAFETY REMINDERS FOR SCREW, DRAG, AND BUCKET ELEVATOR CONVEYORS

APPROVED FOR DISTRIBUTION BY THE SCREW CONVEYOR SECTION OF THE CONVEYOR EQUIPMENT MANUFACTURERS ASSOCIATION (CEMA)

It is the responsibility of the contractor, installer, owner and user to install, maintain and operate the conveyor, components and, conveyor assemblies in such a manner as to comply with the Williams-Steiger Occupational Safety and Health Act and with all state and local laws and ordinances and the American National Standards Institute (ANSI) B20.1 Safety Code.

In order to avoid an unsafe or hazardous condition, the assemblies or parts must be installed and operated in accordance with the following minimum provisions.

1. Conveyors shall not be operated unless all covers and/or guards for the conveyor and drive unit are in place. If the conveyor is to be opened for inspection cleaning, maintenance or observation, the electric power to the motor driving the conveyor must be LOCKED OUT in such a manner that the conveyor cannot be restarted by anyone; however remote from the area, until conveyor or cover or guards and drive guards have been properly replaced.
2. If the conveyor must have an open housing as a condition of its use and application, the entire conveyor is then to be guarded by a railing or fence in accordance with ANSI standard B20.1. (Request current edition and addenda)
3. Feed openings for shovel, front loaders or other manual or mechanical equipment shall be constructed in such a way that the conveyor opening is covered by a grating. If the nature of the material is such that a grating cannot be used, then the exposed section of the conveyor is to be guarded by a railing or fence and there shall be a warning sign posted.
4. Do not attempt any maintenance or repairs of the conveyor until power has been LOCKED OUT.
5. Always operate conveyor in accordance with these instructions and those contained

on the caution labels affixed to the equipment.

6. Do not place hands, feet, or any part of your body, in the conveyor.
7. Never walk on conveyor covers, grating or guards.
8. Do not use conveyor for any purpose other than that for which it was intended.
9. Do not poke or prod material into the conveyor with a bar or stick inserted through the openings.
10. Keep area around conveyor drive and control station free of debris and obstacles.
11. Eliminate all sources of stored energy (materials or devices that could cause conveyor components to move without power applied) before opening the conveyor
12. Do not attempt to clear a jammed conveyor until power has been LOCKED OUT.
13. Do not attempt field modification of conveyor or components.
14. Conveyors are not normally manufactured or designed to handle materials that are hazardous to personnel. These materials which are hazardous include those that are explosive, flammable, toxic or otherwise dangerous to personnel. Conveyors may be designed to handle these materials. Conveyors are not manufactured or designed to comply with local, state or federal codes for unfired pressure vessels. If hazardous materials are to be conveyed or if the conveyor is to be subjected to internal or external pressure, manufacturer should be consulted prior to any modifications.

CEMA insists that disconnecting and locking out the power to the motor driving the unit provides the only real protection against injury. Secondary safety devices are available; however, the decision as to their need and the type required must be made by the owner-assem-

bler as we have no information regarding plant wiring, plant environment, the interlocking of the screw conveyor with other equipment, extent of plant automation, etc. Other devices should not be used as a substitute for locking out the power prior to removing guards or covers. We caution that use of the secondary devices may cause employees to develop a false sense of security and fail to lock out power before removing covers or guards. This could result in a serious injury should the secondary device fail or malfunction.

There are many kinds of electrical devices for interlocking of conveyors and conveyor systems such that if one conveyor in a system or process is stopped other equipment feeding it, or following it can also be automatically stopped.

Electrical controls, machinery guards, railings, walkways, arrangement of installation, training of personnel, etc., are necessary ingredients for a safe working place. It is the responsibility of the contractor, installer, owner and user to supplement the materials and services furnished with these necessary items to make the conveyor installation comply with the law and accepted standards.

Conveyor inlet and discharge openings are designed to connect to other equipment or machinery so that the flow of material into and out of the conveyor is completely enclosed.

One or more warning labels should be visible on conveyor housings, conveyor covers and elevator housings. If the labels attached to the equipment become illegible, please order replacement warning labels from the OEM or CEMA.

The Conveyor Equipment Manufacturers Association (CEMA) has produced an audio-visual presentation entitled "Safe Operation of Screw Conveyors, Drag Conveyors, and Bucket Elevators." CEMA encourages acquisition and use of this source of safety information to supplement your safety program.



PROMINENTLY DISPLAY THESE SAFETY LABELS ON INSTALLED EQUIPMENT

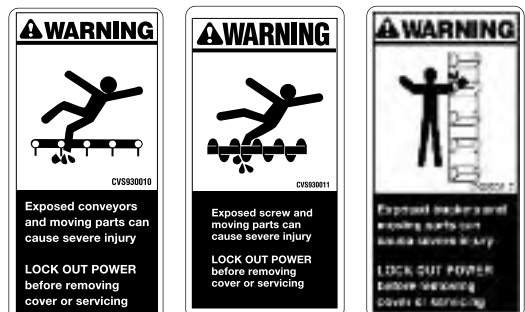

NOTICE: This document is provided by CEMA as a service to the industry in the interest of promoting safety. It is advisory only and it is not a substitute for a thorough safety program. Users should consult with qualified engineers and other safety professionals. CEMA makes no representations or warranties, either expressed or implied, and the users of this document assume full responsibility for the safe design and operation of equipment.

CONVEYORS

SECTION VI

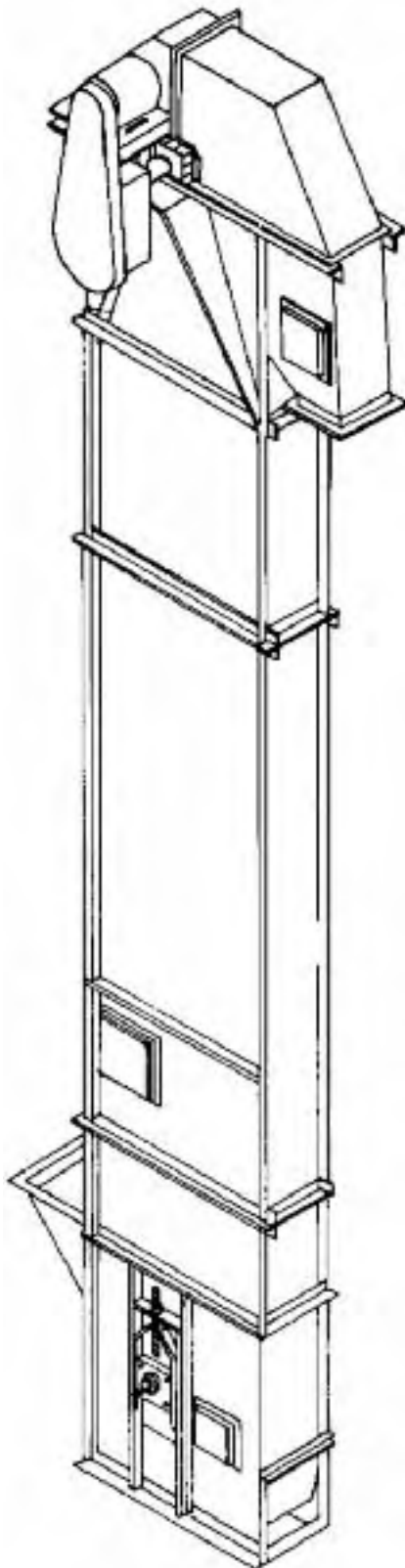

BUCKET ELEVATORS SECTION VI

Warning & Safety Reminder	H-125
Introduction.....	H-126
Standard Features Series 100 & 700	H-127
Elevator Selection Procedure	H-128
Materials Table	H-129
Centrifugal Discharge Elevator	
Series 100 and 200 Chain.....	H-130
Series 100 and 200 Belt.....	H-131
Continuous Discharge Elevators	
Series 700 and 800 Chain.....	H-132
Series 700 and 800 Belt.....	H-133
Mill duty Centrifugal Discharge Elevators	
Series MDC26 and MDC30 Chain	H-134
Series MDB30 Belt.....	H-135
Series DRB30 Belt	H-136
Super Capacity Continuous Discharge Elevators	
Series SC700 Chain.....	H-137
Bucket Elevator Dimensions	
Elevator Sketch.....	H-138
Dimensions, 100 & 700 Belt & Chain	H-139
Buckets and Chain	H-140
Bucket Punching.....	H-141
Calculations for Numbers of Buckets	H-142
High Speed Grain Centrifugal Disc. Elevator	
Series 500 Belt.....	H-143



WARNING AND SAFETY REMINDERS FOR SCREW, DRAG, AND BUCKET ELEVATOR CONVEYORS

APPROVED FOR DISTRIBUTION BY THE SCREW CONVEYOR SECTION OF THE CONVEYOR EQUIPMENT MANUFACTURERS ASSOCIATION (CEMA)

It is the responsibility of the contractor, installer, owner and user to install, maintain and operate the conveyor, components and conveyor assemblies in such a manner as to comply with the Williams-Steiger Occupational Safety and Health Act and with all state and local laws and ordinances and the American National Standards Institute (ANSI) B20.1 Safety Code.

In order to avoid an unsafe or hazardous condition, the assemblies or parts must be installed and operated in accordance with the following minimum provisions.

1. Conveyors shall not be operated unless all covers and/or guards for the conveyor and drive unit are in place. If the conveyor is to be opened for inspection cleaning, maintenance or observation, the electric power to the motor driving the conveyor must be LOCKED OUT in such a manner that the conveyor cannot be restarted by anyone; however remote from the area, until conveyor cover or guards and drive guards have been properly replaced.
2. If the conveyor must have an open housing as a condition of its use and application, the entire conveyor is then to be guarded by a railing or fence in accordance with ANSI standard B20.1. (Request current edition and addenda)
3. Feed openings for shovel, front loaders or other manual or mechanical equipment shall be constructed in such a way that the conveyor opening is covered by a grating. If the nature of the material is such that a grating cannot be used, then the exposed section of the conveyor is to be guarded by a railing or fence and there shall be a warning sign posted.
4. Do not attempt any maintenance or repairs of the conveyor until power has been LOCKED OUT.
5. Always operate conveyor in accordance with these instructions and those contained

on the caution labels affixed to the equipment.

6. Do not place hands, feet, or any part of your body, in the conveyor.
7. Never walk on conveyor covers, grating or guards.
8. Do not use conveyor for any purpose other than that for which it was intended.
9. Do not poke or prod material into the conveyor with a bar or stick inserted through the openings.
10. Keep area around conveyor drive and control station free of debris and obstacles.
11. Eliminate all sources of stored energy (materials or devices that could cause conveyor components to move without power applied) before opening the conveyor
12. Do not attempt to clear a jammed conveyor until power has been LOCKED OUT.
13. Do not attempt field modification of conveyor or components.
14. Conveyors are not normally manufactured or designed to handle materials that are hazardous to personnel. These materials which are hazardous include those that are explosive, flammable, toxic or otherwise dangerous to personnel. Conveyors may be designed to handle these materials. Conveyors are not manufactured or designed to comply with local, state or federal codes for unfired pressure vessels. If hazardous materials are to be conveyed or if the conveyor is to be subjected to internal or external pressure, manufacturer should be consulted prior to any modifications.

CEMA insists that disconnecting and locking out the power to the motor driving the unit provides the only real protection against injury. Secondary safety devices are available; however, the decision as to their need and the type required must be made by the owner-assembler as we have no information regarding plant wiring, plant environment, the interlocking of the screw conveyor with other equipment, extent of plant automation, etc. Other devices should not be used as a substitute for locking out the power prior to removing guards or covers. We caution that use of the secondary devices may cause employees to develop a false sense of security and fail to lock out power before removing covers or guards. This could result in a serious injury should the secondary device fail or malfunction.

There are many kinds of electrical devices for interlocking of conveyors and conveyor systems such that if one conveyor in a system or process is stopped other equipment feeding it, or following it can also be automatically stopped.

Electrical controls, machinery guards, railings, walkways, arrangement of installation, training of personnel, etc., are necessary ingredients for a safe working place. It is the responsibility of the contractor, installer, owner and user to supplement the materials and services furnished with these necessary items to make the conveyor installation comply with the law and accepted standards.

Conveyor inlet and discharge openings are designed to connect to other equipment or machinery so that the flow of material into and out of the conveyor is completely enclosed.

One or more warning labels should be visible on conveyor housings, conveyor covers and elevator housings. If the labels attached to the equipment become illegible, please order replacement warning labels from the OEM or CEMA.

The Conveyor Equipment Manufacturers Association (CEMA) has produced an audio-visual presentation entitled "Safe Operation of Screw Conveyors, Drag Conveyors, and Bucket Elevators." CEMA encourages acquisition and use of this source of safety information to supplement your safety program.



PROMINENTLY DISPLAY THESE SAFETY LABELS ON INSTALLED EQUIPMENT

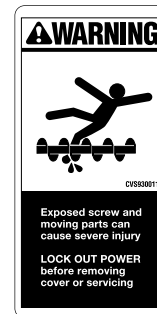

NOTICE: This document is provided by CEMA as a service to the industry in the interest of promoting safety. It is advisory only and it is not a substitute for a thorough safety program. Users should consult with qualified engineers and other safety professionals. CEMA makes no representations or warranties, either expressed or implied, and the users of this document assume full responsibility for the safe design and operation of equipment.

Introduction

Martin

Martin designs and manufactures various types of bucket elevators to efficiently handle most varieties of dry, free-flowing bulk materials. High design standards, quality manufacturing, the best possible service through many branch locations and an excellent distributor network assure many years of economical, trouble-free service.

This catalog is designed to make a preliminary selection of a bucket elevator. It shows the variety of elevators manufactured by *Martin*. Contact your local *Martin* Service Center or *Martin* distributor for a recommendation.

Types

Centrifugal Discharge

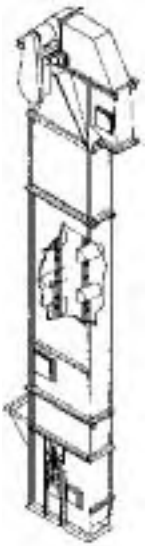

Centrifugal discharge type elevators are offered as: Series 100 (boot take up) and Series 200 (head take up). Either series is available with buckets mounted on chain or belt and will handle free-flowing materials with small to medium size lumps. The standard inlet chute and standard curved bottom plate direct the material into the buckets and reduce the “digging” action. The speed of the elevator is sufficient to discharge the material by centrifugal force.

Many types of drives and elevator materials of construction are available.

Continuous Discharge

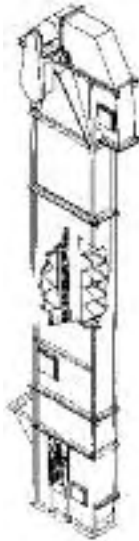

Continuous discharge elevators are offered as: Series 700 (boot take up) and Series 800 (head take up). Either series is available with buckets mounted on chain or belt and will handle free-flowing material, sluggish material or materials that are abrasive. The closely spaced fabricated buckets, with extended sides, form a “chute” to direct material into the bucket. At the discharge, the bucket configuration allows the material to discharge by gravity over the back of the proceeding bucket.

Various materials of construction and thicknesses are available.

High-Speed Centrifugal Grain



Series 500 (double leg) and Series 400 (single leg) high-speed centrifugal discharge bucket elevators are specially designed to economically handle grain and other free-flowing materials. These elevators are *not* self-supporting; therefore, intermediate supports must be provided by others.

Although the charts in this catalog are based on one type of bucket, many other styles are available. For specific recommendations contact your local *Martin* Service Center or *Martin* Conveyor Division distributor for a recommendation.

Centrifugal Discharge - Mill Duty

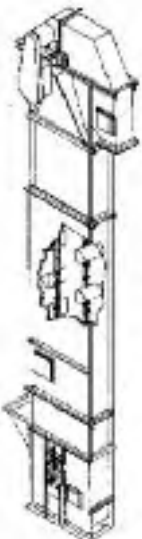

Centrifugal Mill Duty type elevators are offered with style “AC” centrifugal discharge buckets mounted on a single strand of chain, or on a belt. Chain units have a single row of buckets mounted on a single strand of chain. Belt type units may have a single or double row of buckets bolted to heavy duty rubber covered belting. Product is centrifugally discharged as material passes over the head wheel or pulley. A head mounted traction wheel is utilized in the chain type units, where practical. Lagged pulleys are standard for belt type units. Housing construction is heavy duty for severe service.

Continuous Discharge - Super Capacity



Continuous Discharge Super Capacity type elevators are offered with style “SC” continuous discharge buckets mounted between two strands of chain. These units are used where higher capacities, severe duty, or higher shaft centers are required. Housing construction is heavy duty for severe service.

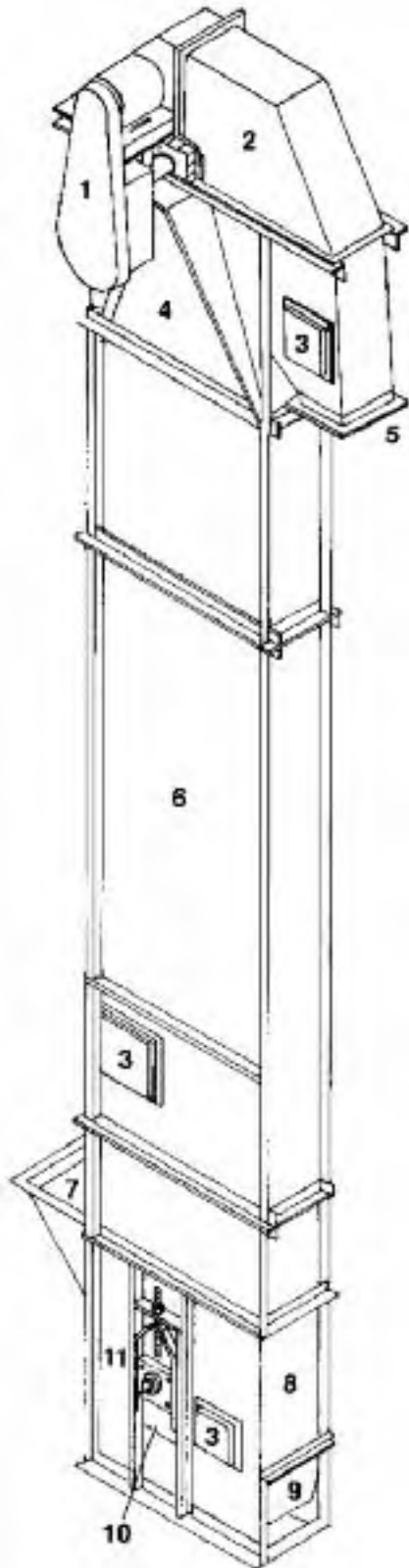

1. **Shaft Mount Type Drive** Furnished as standard. Other types available. Backstops are required to prevent reverse rotation. Various types are available.
2. **Split Hood** 14 gauge
3. **Inspection Door** Near side
4. **Head Section** Fabricated of 12 gauge steel with bearing pedestal structurally reinforced
5. **Discharge Spout (Style 1 shown)** . . . Fabricated of 10 gauge plate steel with externally adjustable 4-ply belting throat lip (not shown). Style 2 (45°) available. Wear liners available.
6. **Intermediate Section** Fixture welded 12 gauge casing continuously welded for dust tight construction. Sides are cross crimped for additional stiffness. Vertical corner angles are full length.
7. **Inlet** Fabricated of $\frac{3}{16}$ inch thick plate steel
8. **Clean Out Door** Bolted for easy removal
9. **Curved Bottom Plate** Reduces build-up in boot
10. **Take-Up Ball Bearing Screw Type** . . For positive take-up tension. Available with roller bearings. Internal gravity type also available.
11. **Boot** Fabricated of $\frac{3}{16}$ inch thick plate steel.

Elevator Number 100 thru 800 Series

Example — B43-139

Mounting	Bucket Size	Series	Unit No.
 B 	 43 	 1 	 39
B = Belt C = Chain	43 = 4 x 3 64 = 6 x 4 85 = 8 x 5 106 = 10 x 6 Etc.	1 = 100 2 = 200 5 = 500 7 = 700 8 = 800	Unit 39

B43-139 is a belt (B) elevator with 4" x 3" (43) buckets, centrifugal discharge type with boot take up (Series 100), Unit 39. Specifications may be found on pages H-131.

Elevator Selection



General

To properly select a bucket elevator, the following factors must be determined:

- Volumetric Capacity** — in cubic feet per hour. Bucket elevators must be uniformly and continuously fed. The volumetric capacity used for selection must be the maximum the elevator will experience. Use Table 1-1 for conversions if necessary.
- Centers or Lift** — in feet
- Lump Size and Lump Class** — Lump size is the largest particle dimension, and lump class is the percentage these lumps represent of the whole.
- Material Characteristics** — See Material Classification Code Chart.
- Operating Conditions** — Conditions affecting operation include location (indoors, outdoors), number of hours per day operation, etc.

Procedure

The following steps should be followed to select an elevator:

- Determine proper elevator series** — See material table for recommendation.
- Select Elevator Number** — For the series selected, refer to the Capacity chart, and select an elevator number for which the capacity in cubic feet per hour listed equals or exceeds the required volumetric capacity. If the required volumetric capacity of centers exceed those listed, contact the *Martin* for a recommendation.
- Check Lump Size/Lump Class** — Check actual lump size/lump class against that listed for the elevator number selected. If the actual lump size/lump class is larger than that listed, choose a larger elevator where the actual is equal to or less than that listed.
- Determine Horsepower Requirements** — Consult *Martin*.
- List Specifications** — Refer to capacity, horsepower and dimension charts for the elevator number selected. List the specifications for the preliminary selection of the elevator.

TABLE 1-1

To convert	To cubic feet per hour (CF or FT ³ /HR)
Tons per hour (short) TPH	CFH = $\frac{\text{TPH} \times 2000}{\text{Density (in pounds per cubic foot; PCF or LBS/FT}^3)}$
Pounds per hour Lbs/hour	CFH = $\frac{\text{Pounds per hour}}{\text{Density (in pounds per cubic foot; PCF or LBS/FT}^3)}$
Bushels per hour BPH	CFH = BPH \times 1.24

Contact your local *Martin* Service Center or *Martin*, distributor for a recommendation.

Material Classification Code Chart		
Major Class	Material Characteristics Included	Code Description
Density	Bulk Density, Loose	Actual Lbs/CF
Size	Very Fine No. 200 Sieve (.0029") and Under No. 100 Sieve (.0059") and Under No. 40 Sieve (.016") and Under	A ₂₀₀ A ₁₀₀ A ₄₀
	Fine No. 6 Sieve (.132") and Under	B ₆
	Granular ½" and Under (6 Sieve to ½") 3" and Under (½ to 3") 7" and Under (3" to 7")	C _½ D ₃ D ₇
	Lumpy 16" and Under (0" to 16") Over 16" To Be Specified X = Actual Maximum Size	D ₁₆ D _x
	Irregular Stringy, Fibrous, Cylindrical, Slabs, Etc.	E
Flowability	Very Free Flowing	1
	Free Flowing	2
	Average Flowability	3
	Sluggish	4
Abrasiveness	Mildly Abrasive	5
	Moderately Abrasive	6
	Extremely Abrasive	7
Miscellaneous Properties or Hazards	Builds Up and Hardens	F
	Generates Static Electricity	G
	Decomposes — Deteriorates in Storage	H
	Flammability	J
	Becomes Plastic or Tends to Soften	K
	Very Dusty	L
	Aerates and Becomes a Fluid	M
	Explosiveness	N
	Stickiness — Adhesion	O
	Contaminable, Affecting Use	P
	Degradable, Affecting Use	Q
	Gives Off Harmful or Toxic Gas or Fumes	R
	Highly Corrosive	S
	Mildly Corrosive	T
	Hygroscopic	U
	Interlocks, Mats or Agglomerates	V
	Oils Present	W
Very Light and Fluffy — May Be Windswept	Y	
Elevated Temperature	Z	

Material	Density LBS/FT ³	Material Code	Recommended Elevator Series*
Alfalfa Meal	14-22	B6-45WY	F, H
Almonds, Broken	27-30	C½-35Q	C, F, H
Almonds, Whole Shelled	28-30	C½-35Q	F
Alum, Fine	45-50	B6-35U	A, F
Alum, Lumpy	50-60	B6-25	A, F
Alumina	55-65	B6-27MY	G
Aluminum Chips, Dry	7-15	E-45V	F
Aluminum Oxide	60-120	A100-17M	F
Ashes, Coal, Dry — 3"	35-40	D3-46T	C
Asphalt, Crushed — ½"	45	C½-45	A, C, F
Bakelite, Fine	30-45	B6-25	F
Baking Powder	40-55	A100-35	F
Bauxite, Crushed — 3"	75-85	D3-36	A, C, F
Beans, Castor, Whole Shelled	36	C½-15W	A, C, F, H
Beans, Navy, Dry	48	C½-15	A, C, F, H
Bentonite, Crude	34-40	D3-45X	A, C
Bentonite — 100 Mesh	50-60	A100-25MY	A, C
Boneblack	20-25	A100-25Y	F
Bonemeal	50-60	B6-35	A, C
Bones, Crushed	35-50	D3-45	A, C, F, H
Bones, Ground	50	B6-35	A, C, F, H
Borax, Fine	45-55	B6-25T	A, C
Bran, Rice-Rye-Wheat	16-20	B6-35NY	A, C
Brewer's Grain, spent, dry	14-30	C½-45	A, C
Brewer's Grain, spent, wet	55-60	C½-45T	A, C
Buckwheat	37-42	B6-25N	E
Calcium Oxide (See Lime, unslaked)	—	—	—
Cast Iron, Chips	130-200	C½-45	F
Cement, Clinker	75-95	D3-36	A, F
Cement, Portland	94	A100-26M	A, F
Chalk, Crushed	75-95	D3-25	A, F
Chalk, Pulverized	67-75	A100-25MY	A, F
Charcoal, Lumps	18-28	D3-45Q	F
Cinders, Coal	40	D3-36T	A, F
Clay, Brick, Dry, Fines	100-120	C½-36	B
Coal, Anthracite, Sized — ½"	49-61	C½-25	A, F
Coal, Bituminous, Mined, Slack	43-50	C½-45T	A, F
Coffee, Green Bean	25-32	C½-25PQ	A, F
Coffee, Roasted Bean	20-30	C½-25PQ	A, F
Coke, Breeze	25-35	C½-37	B, D
Coke, Loose	23-35	D7-37	D
Coke, Petrol, Calcined	35-45	D7-37	D
Copra, Cake, Ground	40-45	B6-45HW	A, C, F, G
Copra, Cake, Lumpy	25-30	D3-35HW	A, C, F
Copra, Lumpy	22	E-35HW	A, C, F
Copra, Meal	40-45	B6-35HW	A, C, F, G
Cork, Granulated	12-15	C½-35JY	F, H
Corn, Cracked	40-50	B6-25P	F, H
Corn Germ	21	B6-35PY	A, C
Corn Grits	40-45	B6-35P	A, C
Cornmeal	32-40	B6-35P	A, C
Corn Shelled	45	C½-25	E
Corn Sugar	30-35	B6-35PU	A, C
Cottonseed, Cake, Lumpy	40-45	D7-45HW	A, C
Cottonseed, Dry, Delinted	22-40	C½-25X	B, D
Cottonseed, Dry, Not Delinted	18-25	C½-45XY	B, D
Cottonseed, Hulls	12	B6-35Y	F, G
Cottonseed, Meal, Extracted	35-40	B6-45HW	A, C
Cottonseed, Meats, Dry	40	B6-35HW	A, C
Distiller's Grain, Spent Dry	30	B6-35	A, C
Dolomite, Crushed	80-100	C½-36	A, F
Ebonite, Crushed	63-70	C½-35	F
Feldspar, Ground	65-80	A100-37	A, C, F,

Material	Density LBS/FT ³	Material Code	Recommended Elevator Series*
Feldspar, Powder	100	A200-36	F, H
Flaxseed	43-45	B6-35X	E
Flaxseed Cake (Linseed Cake)	48-50	D7-45W	C
Flaxseed Meal (Linseed Meal)	25-45	B6-45W	A, C
Fuller's Earth, Dry, Raw	30-40	A40-25	B, D
Fuller's Earth, Oily, Spent	60-65	C½-450W	B, D
Glass, Batch	80-100	C½-37	B, D
Granite, Fine	80-90	C½-27	F
Gypsum, Calcined	55-60	B6-35U	A, C, F, H
Gypsum, Calcined, Powdered	60-80	A100-35U	A, F
Gypsum, Raw — 1"	70-80	D3-25	F
Hops, Spent, Dry	35	D3-35	A, C
Hops, Spent, Wet	50-55	D3-45V	A, C
Ice, Crushed	35-45	D3-35Q	A, F
Ilmenite Ore	140-160	D3-37	A, C, F, G
Lime, Ground, Unslaked	60-65	B6-35U	A, C, F, G
Lime, Hydrated	40	B6-35LM	F
Lime, Pebble	53-56	C½-25HU	A, F
Limestone, Agricultural	68	B6-35	A, C, F, H
Limestone, Crushed	85-90	DX-36	F, H
Malt, Dry, Ground	20-30	B6-35NP	A, C
Malt, Meal	36-40	B6-25P	A, C
Malt, Dry Whole	20-30	C½-35N	A, C
Marble, Crushed	80-95	B6-37	F
Milk, Malted	27-30	A40-45PX	A
Oats	26	C½-25MMN	E
Oats, Rolled	19-24	C½-35NY	A, C
Oxalic Acid Crystals — Ethane Diacid Crystals	60	B6-35QS	B, D
Phosphate Rock, Broken	75-85	DX-36	A, C, F, H
Phosphate Rock, Pulverized	60	B6-36	A, C, F, H
Potash (Muriate) Dry	70	B6-37	A, C, F
Pumice — ½"	42-48	B6-46	F
Rice, Bran	20	B6-35NY	E
Rice, Grits	42-45	B6-35P	A, C
Rice, Hulled	45-49	C½-25P	E
Rye	42-48	B6-15N	E
Salt Cake, Dry Coarse	85	B6-36TU	A, C, F, H
Salt, Dry Fine	70-80	B6-36TU	F, H
Sand Dry Bank (Damp)	110-130	B6-47	B, G
Sand Dry Bank (Dry)	90-110	B6-37	B, G
Sand Foundry (Shake Out)	90-100	D3-37Z	B, G
Shale, Crushed	85-90	C½-36	B, H
Slag, Blast Furnace Crushed	130-180	D3-37Y	F
Slate, Crushed — ½"	80-90	C½-36	F
Soda Ash, Heavy	55-65	B6-36	A, C
Soda Ash, Light	20-35	A40-36Y	F, H
Sodium Phosphate	50-60	A-35	A, F
Soybean, Cake	40-43	D3-35W	C
Soybean, Cracked	30-40	C½-36NW	A
Soybean, Flake, Raw	18-25	C½-35Y	A, C
Soybean, Flour	27-30	A40-35Mn	B, D
Soybean Meal, Cold	40	B6-35	A, C
Soybean Meal, Hot	40	B6-35T	A, C
Soybeans, Whole	45-50	C½-26NW	E
Sugar Beet, Pulp, Dry	12-15	C½-26	F, H
Sugar Beet, Pulp, Wet	25-45	C½-35X	F, H
Sugar, Raw	55-65	B6-35PX	A, C
Trisodium Phosphate, Granular	60	B6-36	A, F
Wheat	45-48	C½-25N	E
Wheat, Cracked	40-45	B6-25N	A, C
Wheat, Germ	18, 28	B6-25	A, C
Wood Chips, Screened	10-30	D3-45VY	B, D

***Elevator Series Designation**
 A = Series 100 Chain
 B = Series 100 Belt
 C = Series 200 Chain

D = Series 200 Belt
 E = Series 500 Belt
 F = Series 700 Chain

G = Series 700 Belt
 H = Series 800 Chain

Centrifugal Discharge Chain

Series 100 Chain (Series 200 is for Head Take-up)

Centrifugal discharge chain type elevators handle a variety of relatively free-flowing dry materials with small to medium lump sizes that are mildly to moderately abrasive.

Buckets

Capacities and horsepower listed are for style "AA" buckets. Style "A", "AA-RB" and "Salem" can be furnished. Style "C" may also be used to handle wet or sticky materials. Consult the factory for a specific recommendation.

Chain

Centrifugal discharge chain type elevators are furnished with either combination chain for light to medium service or all steel (steel knuckle) chain for medium to severe service or when a higher chain working load is required.

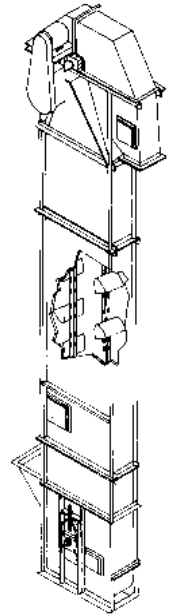

#100 Chain Centrifugal Discharge Bucket Elevator

ELEVATOR	CAPACITY	BUCKETS				CHAIN			MAX. LUMP SIZE		NOM. CASING SIZE		HEAD SPROCKET			BOOT SPROCKET		
		Number	Max. C.F.H.	Width	Proj.	Depth	Spacing	No.	Pitch	F.P.M.	100%	10%	Width	Depth	Number Teeth	Pitch Dia.	RPM	Number Teeth
C43-101	73	4	2 3/4	3	9.25	977	2.308	125	1/2	1	8	18	10	7.50	63.7	10	7.50	1.5000
C64-102	280	6	4	4 1/4	13	C188	2.609	225	1/2	2 1/2	9 3/4	35	24	20.00	43	18	15.00	1.5000
C85-103	473	8	5	5 1/2	16	N102B	4.000	200	3/4	3	11 3/4	35	14	18.00	42.4	10	13.00	1.5000
C85-104	532	8	5	5 1/2	16	N102B	4.000	225	3/4	3	11 3/4	39	16	20.50	41.9	10	13.00	1.5000
C85-105	532	8	5	5 1/2	16	HSB102B	4.000	225	3/4	3	11 3/4	39	16	20.50	41.9	10	13.00	1.5000
C85-107	591	8	5	5 1/2	16	N102B	4.000	250	3/4	3	11 3/4	42	19	24.25	39.4	14	18.00	2.0000
C85-108	591	8	5	5 1/2	16	HSB102B	4.000	250	3/4	3	11 3/4	42	19	24.25	39.4	14	18.00	2.0000
C106-110	891	10	6	6 1/4	16	N102B	4.000	220	1	3 1/2	13 3/4	42	16	20.50	41	12	15.50	2.0000
C106-111	891	10	6	6 1/4	16	HSB102B	4.000	220	1	3 1/2	13 3/4	42	16	20.50	41	12	15.50	2.0000
C106-112	900	10	6	6 1/4	18	N110	6.000	250	1	3 1/2	13 3/4	48	13	25.00	38.2	11	21.25	2.0000
C106-113	900	10	6	6 1/4	18	HSB110	6.000	250	1	3 1/2	13 3/4	48	13	25.00	38.2	11	21.25	2.0000
C106-116	1013	10	6	6 1/4	16	N102B	4.000	250	1	3 1/2	13 3/4	48	19	24.25	39.4	16	20.50	2.0000
C127-117	1425	12	7	7 1/4	18	HSB110	6.000	250	1 1/4	4	15 3/4	48	13	25.00	38.2	9	17.50	2.0000
C127-120	1568	12	7	7 1/4	18	HSB110	6.000	275	1 1/4	4	15 3/4	54	16	30.75	34.2	12	23.25	2.4375
C147-123	1569	14	7	7 1/4	19	N111	4.760	240	1 1/4	4	17 3/4	48	16	24.50	37.4	12	18.25	2.4375
C127-119	1603	12	7	7 1/4	16	N102B	4.000	250	1 1/4	4	15 3/4	48	19	24.25	39.4	14	18.00	2.0000
C147-124	1656	14	7	7 1/4	18	HSB110	6.000	240	1 1/4	4	17 3/4	48	13	25.00	36.7	9	17.50	2.4375
C127-122	1763	12	7	7 1/4	16	N102B	4.000	275	1 1/4	4	15 3/4	54	24	30.50	34.4	19	24.25	2.4375
C147-127	1798	14	7	7 1/4	19	N111	4.760	275	1 1/4	4	17 3/4	54	20	30.50	34.4	16	24.25	2.4375
C147-126	1863	14	7	7 1/4	16	N102B	4.000	240	1 1/4	4	17 3/4	48	19	24.25	37.8	14	18.00	2.4375
C147-128	1898	14	7	7 1/4	18	HSB110	6.000	275	1 1/4	4	17 3/4	54	16	30.75	34.2	12	23.25	2.4375
C147-130	2135	14	7	7 1/4	16	N102B	4.000	275	1 1/4	4	17 3/4	54	24	30.50	34.4	19	24.25	2.4375
C168-131	2319	16	8	8 1/2	19	N111	4.760	240	1 1/2	4 1/2	19 3/4	48	16	24.50	37.4	11	17.00	2.4375
C168-132	2448	16	8	8 1/2	18	HSB110	6.000	240	1 1/2	4 1/2	19 3/4	48	12	23.00	39.9	9	17.50	2.4375
C168-133	2657	16	8	8 1/2	19	N111	4.760	275	1 1/2	4 1/2	19 3/4	54	20	30.50	34.4	14	21.25	2.4375
C168-134	2805	16	8	8 1/2	18	HSB110	6.000	275	1 1/2	4 1/2	19 3/4	54	16	30.75	34.2	11	21.25	2.4375
C188-136	2808	18	8	8 1/2	18	HSB110	6.000	240	1 1/2	4 1/2	21 3/4	48	12	23.00	39.9	9	17.50	2.4375
C188-138	3218	18	8	8 1/2	18	HSB110	6.000	275	1 1/2	4 1/2	21 3/4	54	16	30.75	34.2	11	21.25	2.4375
C208-140	3024	20	8	8 1/2	18	HSB110	6.000	240	1 1/2	4 1/2	23 3/4	48	12	23.00	39.9	9	17.50	2.4375
C208-142	3465	20	8	8 1/2	18	HSB110	6.000	275	1 1/2	4 1/2	23 3/4	54	16	30.75	34.2	11	21.25	2.4375
C248-146	4703	24	8	8 1/2	18	HSB833	6.000	275	1 1/2	4 1/2	28 3/4	54	16	30.75	34.2	11	21.25	2.4375
C2410-150	6518	24	10	10 1/2	18	HSB833	6.000	275	2	4 1/2	30 3/4	60	16	30.75	34.2	11	21.25	2.4375

All Dimensions in inches.

Max. CFH capacity is at 75% bucket load.

Consult *Martin* for head shaft size and horsepower requirements.

Other chain may be substituted based on chain pull requirements.

Series 100 Belt (Series 200 is for Head Take-up)

Centrifugal discharge belt type elevators handle a variety of relatively free-flowing dry materials with small to medium lump sizes that are mildly, moderately or extremely abrasive.

Buckets

Capacities listed are for style "AA" buckets. Style "A", "AA-RB" and "Salem" can be furnished. Style "C" may also be used to handle wet or sticky materials. Consult the factory for a specific recommendation.

Belt

Centrifugal discharge belt type elevators are furnished with 100% polyester carcass PVC belting or rubber covered ply belts specifically designed for elevator service. Many other types of belts and covers are available.

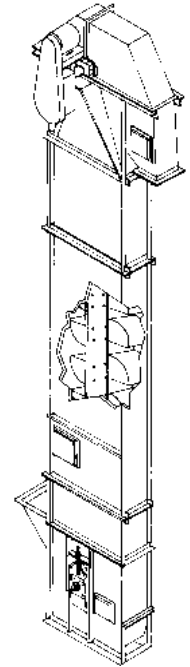

#100 Belt Centrifugal Discharge Bucket Elevator

ELEVATOR Number	CAPACITY Max.C.F.H.	BUCKETS				BELT		MAX. LUMP SIZE		NOM. CASING SIZE		HEAD PULLEY		BOOT PULLEY	
		Width	Proj.	Depth	Spacing	Width	F.P.M.	100%	10%	Width	Depth	Diameter	RPM	Diameter	Shaft Dia.
B43-139	95	4	2 3/4	3	8	5	140	1/4	1	8	18	8.00	62.9	8.00	1.5000
B64-141	293	6	4	4.25	13	7	235	1/2	2 1/2	11 3/4	35	20.00	43.8	16.00	1.5000
B64-140	324	6	4	4.25	13	7	260	1/2	2 1/2	11 3/4	39	24.00	40.5	16.00	1.5000
B85-142	543	8	5	5.5	16	9	230	3/4	3	13 3/4	39	20.00	42.9	14.00	2.0000
B85-143	591	8	5	5.5	16	9	250	3/4	3	13 3/4	42	24.00	39	16.00	2.0000
B106-144	911	10	6	6.25	16	11	225	1	3 1/2	15 3/4	42	20.00	41.9	16.00	2.0000
B106-145	1013	10	6	6.25	16	11	250	1	3 1/2	15 3/4	48	24.00	39	20.00	2.0000
B127-146	1425	12	7	7.25	18	13	250	1 1/4	4	17 3/4	48	24.00	39	20.00	2.4375
B127-147	1596	12	7	7.25	18	13	280	1 1/4	4	17 3/4	54	30.00	35.1	24.00	2.4375
B147-148	1691	14	7	7.25	18	15	245	1 1/4	4	19 3/4	48	24.00	38.2	20.00	2.4375
B147-149	1932	14	7	7.25	18	15	280	1 1/4	4	19 3/4	54	30.00	35.1	24.00	2.4375
B168-150	2550	16	8	8.5	18	17	250	1 1/2	4 1/2	22 3/4	48	24.00	39	20.00	2.4375
B168-152	2856	16	8	8.5	18	17	280	1 1/2	4 1/2	22 3/4	54	30.00	35.1	24.00	2.4375
B188-160	2925	18	8	8.5	18	19	250	1 1/2	4 1/2	24 3/4	48	24.00	39	20.00	2.4375
B208-164	3150	20	8	8.5	18	21	250	1 1/2	4 1/2	26 3/4	48	24.00	39	20.00	2.4375
B188-162	3276	18	8	8.5	18	19	280	1 1/2	4 1/2	24 3/4	54	30.00	35.1	24.00	2.4375
B208-166	3528	20	8	8.5	18	21	280	1 1/2	4 1/2	26 3/4	54	30.00	35.1	24.00	2.4375
B127-146S	4489	12	7	7.25	16	24	350	1 1/4	4	28	66	42.00	31.5	30.00	2.4375
B248-168	4788	24	8	8.5	18	25	280	1 1/2	4 1/2	30 3/4	54	30.00	35.1	24.00	2.4375
B2410-170	6636	24	10	10.5	18	25	280	1 1/2	4 1/2	30 3/4	60	30.00	35.1	24.00	2.4375

All Dimensions in inches.

Max. CFH capacity is at 75% bucket load.

Consult *Martin* for head shaft size and horsepower requirements.

Continuous Discharge Chain

Series 700 Chain (Series 800 is for Head Take-up)

Continuous discharge chain type elevators will handle various free-flowing dry or sluggish materials which contain medium to large lumps and are mildly, moderately, or extremely abrasive.

Buckets

Capacities listed are for a medium-front, non-overlapping style fabricated steel bucket. High front style buckets are available. Consult the factory for a specific recommendation.

Chain

Continuous discharge chain type elevators are furnished with combination chain for mild to moderate service or all steel (steel knuckle) chain for moderate to severe service or when a higher chain working load is required.

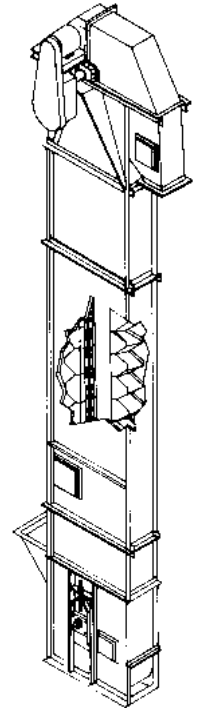

#700 Chain Continuous Discharge Bucket Elevator

ELEVATOR Number	CAPACITY Max. C.F.H.	BUCKETS				CHAIN			MAX. LUMP SIZE		NOM. CASING SIZE		HEAD SPROCKET			BOOT SPROCKET		
		Width	Proj.	Depth	Spacing	No.	Pitch	F.P.M.	100%	10%	Width	Depth	Number Teeth	Pitch Dia.	RPM	Number Teeth	Pitch Diameter	Shaft Diameter
C85-766	567	8	5	7 3/4	8	N102B	4.000	120	3/4	2 1/2	11 3/4	39	16	20.50	22.4	11	14.25	1.5000
C85-767	567	8	5	7 3/4	8	HSB102B	4.000	120	3/4	2 1/2	11 3/4	39	16	20.50	22.4	11	14.25	1.5000
C105-768	729	10	5	7 3/4	8	N102B	4.000	120	3/4	2 1/2	11 3/4	39	16	20.50	22.4	11	14.25	2.0000
C105-769	729	10	5	7 3/4	8	HSB102B	4.000	120	3/4	2 1/2	13 3/4	39	16	20.50	22.4	11	14.25	2.0000
C107-770	1013	10	7	11 5/8	12	N110	6.000	125	1	3	13 3/4	48	13	25.00	19.1	10	19.50	2.0000
C107-771	1013	10	7	11 5/8	12	HSB110	6.000	125	1	3	13 3/4	48	13	25.00	19.1	10	19.50	2.0000
C127-772	1226	12	7	11 5/8	12	N110	6.000	125	1	3	15 3/4	48	13	25.00	19.1	10	19.50	2.4375
C127-773	1226	12	7	11 5/8	12	HSB110	6.000	125	1	3	15 3/4	48	13	25.00	19.1	10	19.50	2.4375
C147-774	1423	14	7	11 5/8	12	N110	6.000	125	1	3	17 3/4	48	13	25.00	19.1	10	19.50	2.4375
C147-775	1423	14	7	11 5/8	12	HSB110	6.000	125	1	3	17 3/4	48	13	25.00	19.1	10	19.50	2.4375
C128-776	1547	12	8	11 5/8	12	N110	6.000	125	1 1/4	4	15 3/4	48	13	25.00	19.1	9	17.50	2.4375
C128-777	1547	12	8	11 5/8	12	HSB110	6.000	125	1 1/4	4	15 3/4	48	13	25.00	19.1	9	17.50	2.4375
C148-778	1828	14	8	11 5/8	12	N110	6.000	125	1 1/4	4	17 3/4	48	13	25.00	19.1	9	17.50	2.4375
C148-779	1828	14	8	11 5/8	12	HSB110	6.000	125	1 1/4	4	17 3/4	48	13	25.00	19.1	9	17.50	2.4375
C168-781	2109	16	8	11 5/8	12	HSB110	6.000	125	1 1/2	4 1/2	19 3/4	48	13	25.00	19.1	9	17.50	2.4375
C188-783	2363	18	8	11 5/8	12	HSB110	6.000	125	1 1/2	4 1/2	22 3/4	48	13	25.00	19.1	9	17.50	2.4375
C208-785	2784	20	8	11 5/8	12	HSB833	6.000	125	1 1/2	4 1/2	24 3/4	48	13	25.00	19.1	9	17.50	2.4375
C248-787	3375	24	8	11 5/8	12	HSB833	6.000	125	1 1/2	4 1/2	28 3/4	48	13	25.00	19.1	9	17.50	2.4375
C2010-786	3881	20	10	11 5/8	12	HSB833	6.000	125	2	4 1/2	24 3/4	54	13	25.00	19.1	9	17.50	2.4375
C2410-788	4669	24	10	11 5/8	12	HSB833	6.000	125	2	4 1/2	28 3/4	54	13	25.00	19.1	9	17.50	2.4375

All Dimensions in inches.

Max. CFH capacity is at 75% bucket load.

Consult *Martin* for head shaft size and horsepower requirements.

Other chain may be substituted based on chain pull requirements.

CONVEYORS

Series 700 Belt (Series 800 is for Head Take-up)

Continuous discharge belt type elevators will handle various free-flowing dry or sluggish materials which contain medium to large lumps and are mildly, moderately, or extremely abrasive.

Buckets

Capacities listed are for a medium front, non-overlapping style fabricated steel bucket. High front style buckets are available. Consult the factory for a specific recommendation.

Belt

Continuous discharge belt type elevators are furnished with 100% polyester carcass PVC belting or rubber covered ply belts specifically designed for elevator service. Many other types of belt and covers are available.

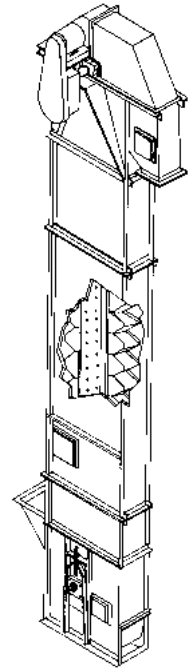

#700 Belt Continuous Discharge Bucket Elevator

ELEVATOR Number	CAPACITY Max. C.F.H.	BUCKETS			BELT			MAX. LUMP SIZE		NOM. CASING SIZE		HEAD PULLEY		BOOT PULLEY	
		Width	Proj.	Depth	Spacing	Width	F.P.M.	100%	10%	Width	Depth	Diameter	RPM	Diameter	Shaft Dia.
B85-790	756	8	5	7 3/4	8	9	160	3/4	2 1/2	11 3/4	39	20.00	29.8	14.00	1.5000
B105-791	972	10	5	7 3/4	8	11	160	3/4	2 1/2	13 3/4	39	20.00	29.8	14.00	1.5000
B107-792	1296	10	7	11 5/8	12	11	160	1	3	13 3/4	48	24.00	24.9	20.00	2.0000
B127-793	1570	12	7	11 5/8	12	13	160	1	3	15 3/4	48	24.00	24.9	20.00	2.0000
B147-794	1822	14	7	11 5/8	12	15	160	1	3	17 3/4	48	24.00	24.9	20.00	2.0000
B128-795	1980	12	8	11 5/8	12	13	160	1 1/4	4	15 3/4	48	24.00	24.9	20.00	2.0000
B148-796	2340	14	8	11 5/8	12	15	160	1 1/4	4	17 3/4	48	24.00	24.9	20.00	2.4375
B168-797	2700	16	8	11 5/8	12	17	160	1 1/2	4 1/2	19 3/4	48	24.00	24.9	20.00	2.4375
B188-798	3024	18	8	11 5/8	12	19	160	1 1/2	4 1/2	22 3/4	48	24.00	24.9	20.00	2.4375
B208-720	3564	20	8	11 5/8	12	21	160	1 1/2	4 1/2	24 3/4	48	24.00	24.9	20.00	2.4375
B248-722	4320	24	8	11 5/8	12	25	160	1 1/2	4 1/2	28 3/4	48	24.00	24.9	20.00	2.4375
B2010-724	4968	20	10	11 5/8	12	21	160	1 1/2	4 1/2	24 3/4	54	24.00	24.9	20.00	2.4375
B2410-726	5976	24	10	11 5/8	12	25	160	1 1/2	4 1/2	28 3/4	54	24.00	24.9	20.00	2.4375

All Dimensions in inches.

Max. CFH capacity is at 75% bucket load.

Consult *Martin* for head shaft size and horsepower requirements.

Mill Duty Centrifugal Discharge Chain



Series MDC26 & MDC30 Chain

Mill duty centrifugal discharge chain type bucket elevators handle a variety of relatively free flowing dry materials with small to medium lump sizes that are mildly to moderately abrasive. Extensively used in the cement industry.

Buckets

Capacities listed are for style "AC" buckets. Buckets may be vented for handling light, fluffy materials.

Chain

Mill duty centrifugal discharge chain type bucket elevators are furnished with heavy duty steel knuckle chain for medium to severe service, selected for required work loads.

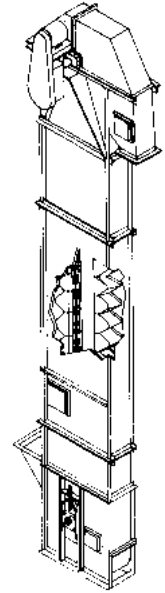

Mill Duty Chain Centrifugal Discharge Bucket Elevator

ELEVATOR Number	CAPACITY Max. C.F.H.	BUCKETS				CHAIN			MAX. LUMP SIZE		NOM. CASING SIZE		HEAD SPROCKET			BOOT SPROCKET		
		Width	Proj.	Depth	Spacing	No.	Pitch	F.P.M.	100%	10%	Width	Depth	Number Teeth	Pitch Dia.	RPM	Number Teeth	Pitch Diameter	Shaft Diameter
MDC26 -128A	2226	12	8	8 1/2	18	HSB833	6.000	265	1 1/2	4	20	56	26	27.00	37.5	13	25.03	3.000
MDC26 -148A	2624	14	8	8 1/2	18	HSB833	6.000	265	1 1/2	4	22	56	26	27.00	37.5	13	25.03	3.000
MDC26 -168A	3021	16	8	8 1/2	18	HSB833	6.000	265	1 3/4	4 1/2	24	56	26	27.00	37.5	13	25.03	3.000
MDC26 -128B	3339	12	8	8 1/2	12	HSB833	6.000	265	1 1/2	4	20	56	26	27.00	37.5	13	25.03	3.000
MDC26 -148B	3935	14	8	8 1/2	12	HSB833	6.000	265	1 1/2	4	22	56	26	27.00	37.5	13	25.03	3.000
MDC26 -168B	4532	16	8	8 1/2	12	HSB833	6.000	265	1 3/4	4 1/2	24	56	26	27.00	37.5	13	25.03	3.000
MDC26-1810A	4929	18	10	10 1/2	18	HSB856	6.000	265	2	5	26	64	26	27.25	37.1	13	25.05	3.000
MDC30 - 168B	5387	16	8	8 1/2	12	HSB833	6.000	315	1 3/4	4 1/2	24	60	30	31.00	38.8	15	28.81	3.000
MDC26-2010A	5470	20	10	10 1/2	18	HSB856	6.000	265	2	5	28	64	26	27.25	37.1	13	25.05	3.000
MDC30-1810A	5859	18	10	10 1/2	18	HSB856	6.000	315	2	5	26	68	30	31.25	38.5	15	28.82	3.000
MDC30-2010A	6502	20	10	10 1/2	18	HSB856	6.000	315	2	5	28	68	30	31.25	38.5	15	28.82	3.000
MDC26-2410A	6758	24	10	10 1/2	18	HSB856	6.000	265	2	5	32	64	26	27.25	37.1	13	25.05	3.000
MDC26-1810B	7394	18	10	10 1/2	12	HSB859	6.000	265	2	5	26	64	26	28.00	36.2	13	25.05	3.000
MDC30-2410A	8033	24	10	10 1/2	18	HSB856	6.000	315	2	5	32	68	30	31.25	38.5	15	28.82	3.000
MDC26-2010B	8204	20	10	10 1/2	12	HSB859	6.000	265	2	5	28	64	26	28.00	36.2	13	25.05	3.000
MDC30-1810B	8789	18	10	10 1/2	12	HSB859	6.000	315	2	5	26	68	30	32.00	37.6	15	28.82	3.000
MDC30-2010B	9752	20	10	10 1/2	12	HSB859	6.000	315	2	5	28	68	30	32.00	37.6	15	28.82	3.000
MDC26-2410B	10136	24	10	10 1/2	12	HSB859	6.000	265	2	5	32	64	26	28.00	36.2	13	25.05	3.000
MDC30-2410B	12049	24	10	10 1/2	12	HSB859	6.000	315	2	5	32	68	30	32.00	37.6	15	28.82	3.000

All Dimensions in inches.

Max. CFH capacity is at 75% bucket load.

Consult *Martin* for head shaft size and horsepower requirements.

Other chain may be substituted based on chain pull requirements.

Internal gravity take-ups are standard.

Series MDB30 Belt

Mill duty centrifugal discharge belt type bucket elevators handle high capacities of various relatively free flowing dry materials with small to medium lump sizes that are mildly to moderately abrasive.

Buckets

Capacities listed are for style "AC" buckets. Buckets may be vented for handling light, fluffy materials.

Belt

Mill duty centrifugal discharge belt type bucket elevators are furnished with heavy duty rubber covered ply belts or 100% polyester carcass PVC belts specifically selected for elevator service.

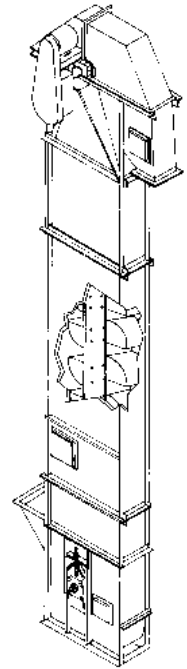

Mill Duty Belt Centrifugal Discharge Bucket Elevator

ELEVATOR Number	CAPACITY Max. C.F.H.	BUCKETS			BELT			MAX. LUMP SIZE		NOM. CASING SIZE		HEAD PULLEY		BOOT PULLEY	
		Width	Proj.	Depth	Spacing	Width	F.P.M.	100%	10%	Width	Depth	Diameter	RPM	Diameter	Shaft Dia.
MDB30-128A	2520	12	8	8 1/2	18	14	300	1 1/2	4	22	58	30.00	37.6	24.00	3.0000
MDB30-148A	2970	14	8	8 1/2	18	16	300	1 1/2	4	24	58	30.00	37.6	24.00	3.0000
MDB30-168A	3420	16	8	8 1/2	18	18	300	1 3/4	4 1/2	26	58	30.00	37.6	24.00	3.0000
MDB30-128B	3780	12	8	8 1/2	12	14	300	1 1/2	4	22	58	30.00	37.6	24.00	3.0000
MDB30-148B	4455	14	8	8 1/2	12	16	300	1 1/2	4	24	58	30.00	37.6	24.00	3.0000
MDB30-168B	5130	16	8	8 1/2	12	18	300	1 3/4	4 1/2	26	58	30.00	37.6	24.00	3.0000
MDB30-1810A	5580	18	10	10 1/2	18	20	300	2	5	28	64	30.00	37.6	24.00	3.0000
MDB30-2010A	6192	20	10	10 1/2	18	22	300	2	5	30	64	30.00	37.6	24.00	3.0000
MDB30-2410A	7650	24	10	10 1/2	18	26	300	2	5	34	64	30.00	37.6	24.00	3.0000
MDB30-1810B	8370	18	10	10 1/2	12	20	300	2	5	28	64	30.00	37.6	24.00	3.0000
MDB30-2010B	9288	20	10	10 1/2	12	22	300	2	5	30	64	30.00	37.6	24.00	3.0000
MDB30-2410B	11475	24	10	10 1/2	12	26	300	2	5	34	64	30.00	37.6	24.00	3.0000

All Dimensions in inches.

Max. CFH capacity is at 75% bucket load.

Consult *Martin* for head shaft size and horsepower requirements.

Screw take-ups are standard.

Double Row Mill Duty Centrifugal Discharge Belt

Series DRB30 Belt

Double row mill duty centrifugal discharge belt type bucket elevators handle high capacities of various relatively free flowing dry materials with small to medium lump sizes that are mildly to moderately abrasive.

Buckets

Capacities listed are for a double row of style "AC" buckets. Buckets may be vented for handling light, fluffy materials.

Belt

Double row mill duty centrifugal discharge belt type bucket elevators are furnished with heavy duty rubber covered ply belts or 100% polyester carcass PVC belts specifically selected for elevator service.

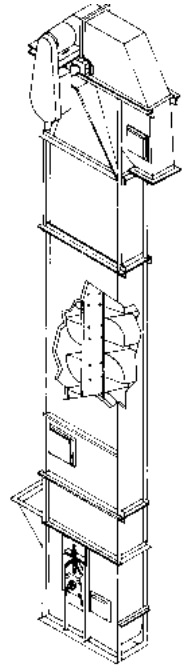

Double Row Mill Duty Belt Centrifugal Discharge Bucket Elevator

ELEVATOR		BUCKETS			BELT			MAX. LUMP SIZE		NOM. CASING SIZE		HEAD PULLEY		BOOT PULLEY	
Number	Max. C.F.H.	Width	Proj.	Depth	Spacing	Width	F.P.M.	100%	10%	Width	Depth	Diameter	RPM	Diameter	Shaft Dia.
DRB30-128A	8316	12	8	8 1/2	10	26	275	1 1/2	4	34	58	30.00	34.4	30.00	3.000
DRB30-1210A	9207	12	10	10 1/2	12	26	275	1 1/2	4	34	62	30.00	34.4	30.00	3.000
DRB30-148A	9801	14	8	8 1/2	10	30	275	1 1/2	4	38	58	30.00	34.4	30.00	3.000
DRB30-1410A	10841	14	10	10 1/2	12	30	275	1 1/2	4	38	62	30.00	34.4	30.00	3.000
DRB30-168A	11286	16	8	8 1/2	10	34	275	1 3/4	4 1/2	42	58	30.00	34.4	30.00	3.000
DRB30-1610A	12499	16	10	10 1/2	12	34	275	1 3/4	4 1/2	42	62	30.00	34.4	30.00	3.000
DRB30-1810A	15345	18	10	10 1/2	12	38	275	2	4 1/2	46	62	30.00	34.4	30.00	3.000
DRB30-2010A	17028	20	10	10 1/2	12	42	275	2 1/4	4 3/4	50	62	30.00	34.4	30.00	3.000
DRB30-2410A	21038	24	10	10 1/2	12	50	275	2 1/2	5	58	62	30.00	34.4	30.00	3.000

All Dimensions in inches.

Max. CFH capacity is at 75% bucket load.

Consult *Martin* for head shaft size and horsepower requirements.

Screw take-ups are standard.

CONVEYORS

j139

Series SC700 Chain

Super Capacity continuous discharge chain type bucket elevators handle high capacities of various free flowing dry materials ranging from fines to lumps, moderate to extremely abrasive, and those that tend to pack.

Buckets

Capacities listed are for style "SC" continuous fabricated steel buckets, mounted between two strand of chain.

Chain

Super Capacity continuous discharge chain type bucket elevators are furnished with two strands of heavy duty steel knuckle chain for moderate to severe service, selected for required work loads.

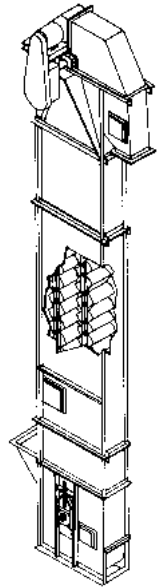

ELEVATOR Number	CAPACITY Max. C.F.H.	BUCKETS				CHAIN			MAX. LUMP SIZE		NOM. CASING SIZE		HEAD SPROCKET			BOOT SPROCKET		
		Width	Proj.	Depth	Spacing	No.	Pitch	F.P.M.	100%	10%	Width	Depth	Number Teeth	Pitch Dia.	RPM	Number Teeth	Pitch Diameter	Shaft Diameter
SC700-128	2250	12	8.75	11.625	12	6102 1/2	12	100	2	4	26	56	8	31.36	12.2	6	23.96	2.4375
SC700-148	2700	14	8.75	11.625	12	6102 1/2	12	100	2	4	28	56	8	31.36	12.2	6	23.96	2.4375
SC700-168	3150	16	8.75	11.625	12	6102 1/2	12	100	2 1/2	6	30	56	8	31.36	12.2	6	23.96	3.0000
SC700-188	3600	18	8.75	11.625	12	6102 1/2	12	100	2 1/2	6	32	56	8	31.36	12.2	6	23.96	3.0000
SC700-208	4050	20	8.75	11.625	12	6102 1/2	12	100	2 1/2	6	34	56	8	31.36	12.2	6	23.96	3.0000
SC700-1612	5625	16	12.75	17.625	18	9124	9	125	3 1/2	8	33	68	12	34.77	13.7	12	34.77	3.0000
SC700-2012	7125	20	12.75	17.625	18	9124	9	125	3 1/2	8	37	68	12	34.77	13.7	12	34.77	3.0000
SC700-2412	8250	24	12.75	17.625	18	9124	9	125	3 1/2	8	41	68	12	34.77	13.7	12	34.77	3.0000
SC700-3012	10500	30	12.75	17.625	18	9124	9	125	3 1/2	8	47	68	12	34.77	13.7	12	34.77	3.0000
SC700-3612	12375	36	12.75	17.625	18	9124	9	125	3 1/2	8	53	68	12	34.77	13.7	12	34.77	3.4375
SC700-4212	14437.5	42	12.75	17.625	18	9150	9	125	3 1/2	8	60	68	12	34.77	13.7	12	34.77	3.4375
SC700-4812	16500	48	12.75	17.625	18	9150	9	125	3 1/2	8	66	68	12	34.77	13.7	12	34.77	3.4375

All Dimensions in inches.

Max. CFH capacity is at 75% bucket load.

Consult *Martin* for head shaft size and horsepower requirements.

Internal gravity take-ups are standard.

Bucket Elevator Dimensions

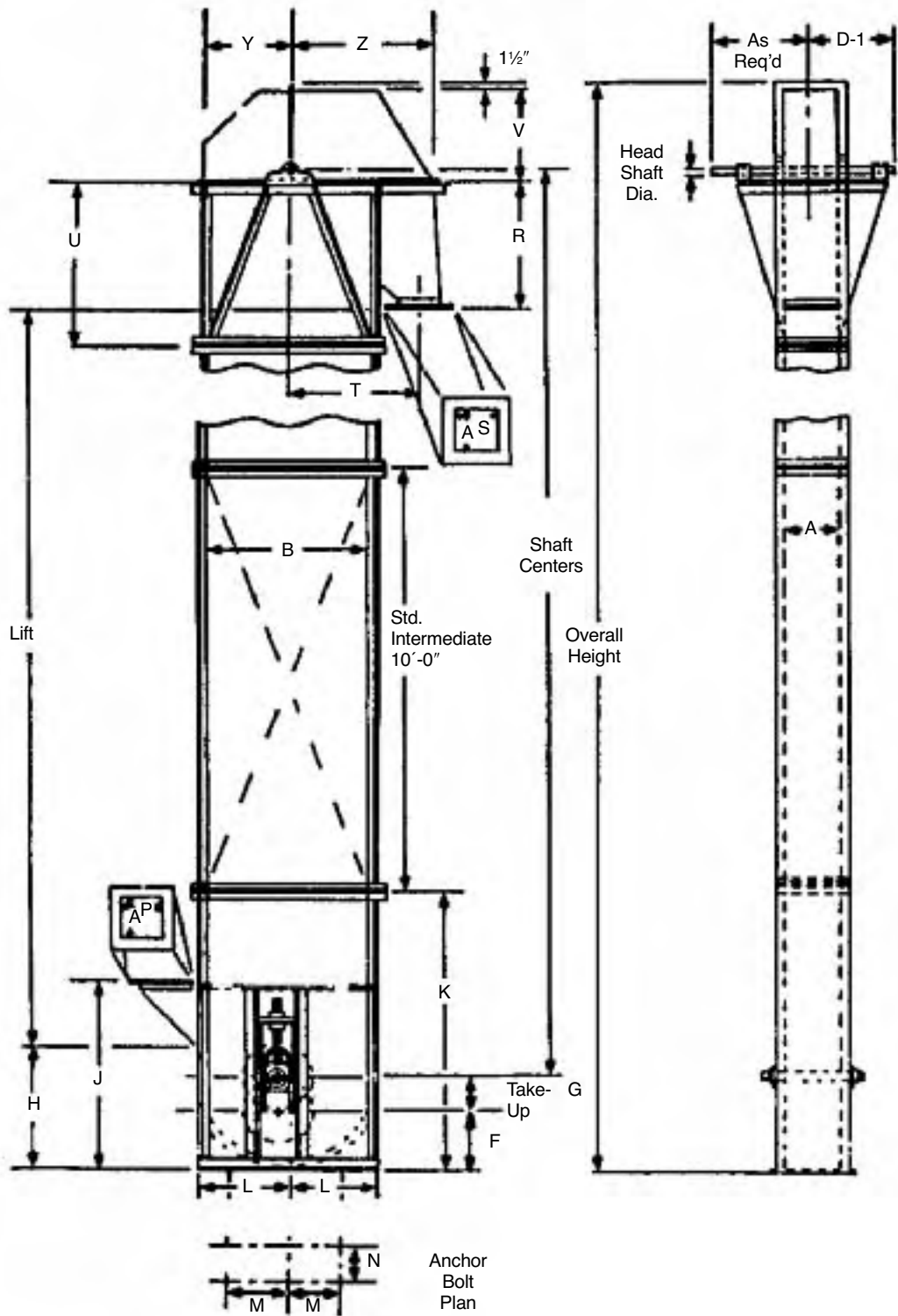

CONVEYORS



Bucket Elevator Dimensions

100 & 700 Belt & Chain

				Dimensions [®] (In Inches)																			
Elevator Number Chain	Elevator Number Belt	Elevator Number Belt	Elevator Number Chain	Casing		Boot								Head									
				A	B	F	G	H	J	K	L	M	N	P	R	S	T	U	V	Y	Z	D-1 [®]	
C43-101		B43-139		8	18	9	6	27¼	36¾	42	9	6	10	6	15	8	17½	36	14	9	20¼	13	
C64-102				9¾	35	13	9	26½	43	72	17½	14½	13½	13	29¾	10	28½	42	19½	17½	30½	13	
		B64-140		11¾	39	14	9	26½	43	72	19½	16½	15½	13	31½	10	30½	42	21½	19½	32½	14	
C85-103		B64-141		11¾	35	13	9	26½	43	72	17½	14½	15½	13	29¾	10	28½	42	19½	17½	30½	14	
C85-104	B85-790		C85-766	11¾	39	14	9	26½	43	72	19½	16½	15½	13	31½	10	30½	42	21½	19½	32½	14	
C85-105			C85-767	11¾	39	14	9	26½	43	72	19½	16½	15½	13	31½	10	30½	42	21½	19½	32½	14	
C85-107					11¾	42	16	9	32½	50	72	21	18	15½	13	32¾	10	33¼	42	24	21	36¼	14½
C85-108				11¾	42	16	9	32½	50	72	21	18	15½	13	32¾	10	33¼	42	24	21	36¼	14½	
	B105-791	B85-142	C105-768	13¾	39	14	9	26½	43	72	19½	16½	17½	13	31½	10	30½	42	21½	19½	32½	15	
C106-110				13¾	42	16	9	32½	50	72	21	18	17½	13	32¾	10	33¼	42	24	21	36¼	15½	
C106-111		B85-143		13¾	42	16	9	32½	50	72	21	18	17½	13	32¾	10	33¼	42	24	21	36¼	15½	
C106-112	B107-792		C107-770	13¾	48	19	9	40½	60	72	24	21	17½	15	35¾	13	36½	48	27½	24	40%	16	
C106-113			C107-771	13¾	48	19	9	40½	60	72	24	21	17½	15	35¾	13	36½	48	27½	24	40%	16	
C106-116					15¾	42	16	9	32½	50	72	21	18	19½	13	32¼	10	33¼	42	24	21	36¼	17
			B106-144		15¾	42	16	9	32½	50	72	21	18	19½	13	32¼	10	33¼	42	24	21	36¼	17
C127-117	B127-793 B128-795		C127-772	15¾	48	19	9	40½	60	72	24	21	19½	15	35¾	13	36½	48	27½	24	40%	17	
C127-119			B106-145	C127-773	15¾	48	19	9	40½	60	72	24	21	19½	15	35¾	13	36½	48	27½	24	40%	17
C127-120			C128-776	15¾	54	21	10	39	60½	72	27	24	19½	17	38¼	17	41½	48	31	27	45	18¼	
C127-122			C128-777	15¾	54	21	10	39	60½	72	27	24	19½	17	38¼	17	41½	48	31	27	45	18¼	
		B127-146 S		28	64	26	10	29¾	60½	72	32	29	30½	26¼	36	17	46½	48	36½	32	53	24	
C147-123	B147-794 B147-796		C147-774	17¾	48	19	10	40½	60	72	24	21	21½	15	35¾	13	36½	48	27½	24	40%	18	
C147-124			C147-775	17¾	48	19	10	40½	60	72	24	21	21½	15	35¾	13	36½	48	27½	24	40%	18	
C147-126			B127-146	C148-778	17¾	48	19	10	40½	60	72	24	21	21½	15	35¾	13	36½	48	27½	24	40%	18
C147-127				C148-779	17¾	48	19	10	40½	60	72	24	21	21½	15	35¾	13	36½	48	27½	24	40%	18
C147-128				17¾	54	21	10	39	60½	72	27	24	21½	17	38¼	17	41½	48	31	27	45	19¼	
C147-130		B127-147		17¾	54	21	10	39	60½	72	27	24	21½	17	38¼	17	41½	48	31	27	45	19¼	
C168-131	B168-797		C168-780	19¾	48	20	10	40½	60	72	24	21	23½	15	35¾	13	36½	48	27½	24	40%	19	
C168-132			B147-148	C168-781	19¾	48	20	10	40½	60	72	24	21	23½	15	35¾	13	36½	48	27½	24	40%	19
C168-133					19¾	54	21	10	39	60½	72	27	24	23½	17	38¼	17	41½	48	31	27	45	20
C168-134			B147-149		19¾	54	21	10	39	60½	72	27	24	23½	17	38¼	17	41½	48	31	27	45	20
	B188-798	B168-150	C188-782 C188-783	22¾	48	19	10	40½	60	72	24	21	26½	15	35¾	13	36½	48	27½	24	40%	21	
		B168-152		22¾	54	21	10	39	60½	72	27	24	26½	17	38¼	17	41½	48	31	27	45	22	

¹NOT certified for construction.

²Normal maximum for largest headshaft listed.

For units not shown, contact *Martin*.

Buckets and Chain



Style AA

Ductile iron buckets for general use with most types of relatively free flowing material in centrifugal discharge elevators. Can be mounted on chain or belt and furnished in various plastic materials.

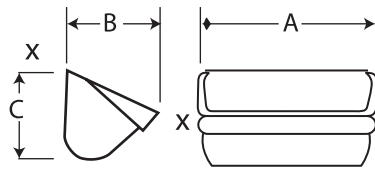

Bucket Size			Weight Lbs.	Capacity cu. ft. X—X
A	B	C		
4	2 $\frac{3}{4}$	3	1.0	.01
6	4	4 $\frac{1}{4}$	2.7	.03
8	5	5 $\frac{1}{2}$	4.8	.07
10	6	6 $\frac{1}{4}$	7.7	.12
12	7	7 $\frac{1}{4}$	12.0	.19
14	7	7 $\frac{1}{4}$	13.9	.23
16	8	8 $\frac{1}{2}$	21.8	.34

Style C

Fabricated buckets are used in centrifugal discharge elevators to handle materials that tend to pack or stick, such as sugar, clay, salt or wet grains.

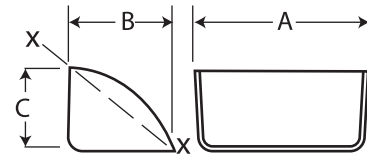

Bucket Size			Weight Lbs.	Capacity cu. ft. X—X
A	B	C		
6	4 $\frac{1}{2}$	4	2.0	.026
8	4 $\frac{1}{2}$	4	2.8	.035
10	5	4	4.0	.052
12	5	4	4.8	.061
14	7	5 $\frac{1}{2}$	8.5	.138
16	7	5 $\frac{1}{2}$	10.5	.158

Continuous

Medium front non-overlapping fabricated steel buckets are used in continuous discharge elevators for general service. Heavier gauges should be used when handling abrasive materials. Available fabricated from various materials. High front continuous buckets are available also. Plastic buckets available in most sizes.

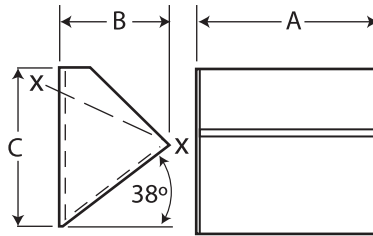

Bucket Size			Weight Lbs.				Capacity cu. ft. X—X
A	B	C	12 Ga.	10 Ga.	$\frac{3}{16}$ "	$\frac{1}{4}$ "	
8	5	7 $\frac{1}{4}$	5.1	6.3	8.7	—	.070
10	5	7 $\frac{1}{4}$	5.9	7.4	10.2	—	.090
10	7	11 $\frac{1}{2}$	9.3	11.9	16.5	—	.180
12	7	11 $\frac{1}{2}$	10.4	13.4	18.6	—	.218
14	7	11 $\frac{1}{2}$	11.6	14.9	20.7	—	.253
12	8	11 $\frac{1}{2}$	11.2	14.4	20.0	26.1	.275
14	8	11 $\frac{1}{2}$	12.4	16.0	22.2	29.1	.325
16	8	11 $\frac{1}{2}$	13.7	17.6	24.5	32.0	.375
18	8	11 $\frac{1}{2}$	14.9	19.2	26.7	35.0	.420

AC Welded Steel

High front for greater capacity. Hooded back for closer spacing. Typical in cement, gypsum powder or other powdery materials. Venting available for clean filling and discharge. Mounted on chain or belt.

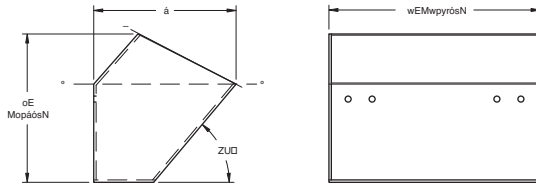

*Weights do not include bolt reinforcing plates. Bolt reinforcing plates are recommended if less than 8 bolts are used. Vent holes in bottom are optional in style "AC" buckets.

Bucket Size, Inches			Weight		Cap. Cu. Feet [^]	
L Length	P Proj.	D Depth	3/16" Steel	1/4" Steel	Filled to Line X-X	Filled to Line X-Y
12	8	8 $\frac{1}{2}$	18.25	24.30	.231	.303
14	8	8 $\frac{1}{2}$	20.30	27.00	.271	.356
16	8	8 $\frac{1}{2}$	22.48	29.98	.311	.408
18	10	10 $\frac{1}{2}$	31.15	38.95	.488	.691
20	10	10 $\frac{1}{2}$	33.68	42.10	.542	.768
24	10	10 $\frac{1}{2}$	39.67	52.69	.651	.921
27	12	12 $\frac{1}{2}$	53.84	71.46	1.072	1.474

SC Welded Steel

Mounted between two strands of chain. Suitable for the heaviest materials. Designed for super capacity elevators. Typical in asphalt and concrete applications. Design offers increased capacity.

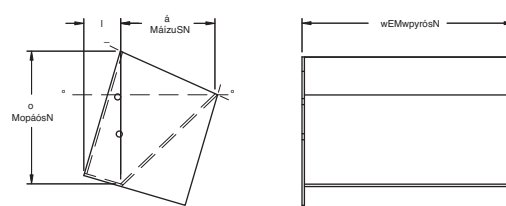

*Note: Actual capacity depends on angle of repose of material handled and inclination of elevator.

Bucket Size, Inches				Weight				Cap. Cu. Feet [^]	
L Length	P Proj.	D Depth	A Inches	10 Gauge Steel	3/16" Steel	1/4" Steel	5/16" Steel	Filled to Line X-X	Filled to Line X-Y
12	8 $\frac{1}{4}$	11 $\frac{1}{2}$	4 $\frac{1}{16}$	22	29	39	49	.35	.54
14	8 $\frac{1}{4}$	11 $\frac{1}{2}$	4 $\frac{1}{16}$	23	31	41	51	.41	.63
16	8 $\frac{1}{4}$	11 $\frac{1}{2}$	4 $\frac{1}{16}$	25	34	45	56	.46	.72
16	12	17 $\frac{1}{2}$	6 $\frac{1}{2}$	43	58	76	95	1.11	1.55
18	8 $\frac{1}{4}$	11 $\frac{1}{2}$	4 $\frac{1}{16}$	27	36	48	60	.52	.81
20	8 $\frac{1}{4}$	11 $\frac{1}{2}$	4 $\frac{1}{16}$	29	39	52	65	.58	.90
20	12	17 $\frac{1}{2}$	6 $\frac{1}{2}$	49	67	88	110	1.40	1.94
24	12	17 $\frac{1}{2}$	6 $\frac{1}{2}$	55	75	104	130	1.68	2.33
30	12	17 $\frac{1}{2}$	6 $\frac{1}{2}$	65	88	117	146	2.11	2.91
36	12	17 $\frac{1}{2}$	6 $\frac{1}{2}$	73	99	132	165	2.53	3.49

Chain

Combination chains, C-, have cast block links and steel connecting side bars. All steel (steel knuckle), SS, are fabricated of steel. Attachments are available either on the connecting side bars or block link.

Chain No.	Pitch in Inches	Average Ultimate Strength Lbs.	Rated Working Value Lbs.	Wt. Per Ft. Lbs Attachment Every Other Pitch	Attachment Number	Dimension in Inches		
						Pin Diameter	Side Bar	Barrel or Knuckle Dia.
C-977	2.308	11,000	1830	2.2	K-1	$\frac{7}{16}$	$\frac{3}{16} \times \frac{7}{8}$	$\frac{7}{8}$
C-188	2.609	14,000	1950	4.8	K-2	$\frac{1}{2}$	$\frac{1}{4} \times 1\frac{1}{8}$	$\frac{7}{8}$
C-102B	4.0	24,000	4000	7.8	K-2	$\frac{5}{8}$	$\frac{3}{8} \times 1\frac{1}{2}$	1 $\frac{1}{32}$
C-110	6.0	24,000	4000	7.3	K-2	$\frac{5}{8}$	$\frac{3}{8} \times 1\frac{1}{2}$	1 $\frac{1}{16}$
C-111	4.76	36,000	5,950	10.7	K-2	$\frac{3}{4}$	$\frac{3}{8} \times 1\frac{1}{4}$	1 $\frac{15}{32}$
SS-102B	4.0	40,000	6,290	9.0	K-2	$\frac{5}{8}$	$\frac{3}{8} \times 1\frac{1}{2}$	1
SS-110	6.0	40,000	6290	8.6	K-2	$\frac{5}{8}$	$\frac{3}{8} \times 1\frac{1}{2}$	1 $\frac{1}{4}$

NOTE: All dimensions are inside to inside of bucket.

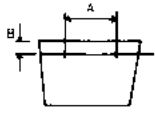

B1

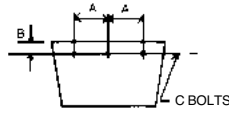

B2

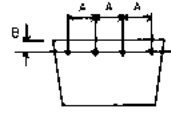

B3

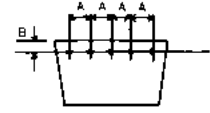

B4

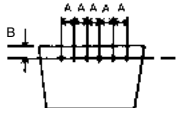

B5

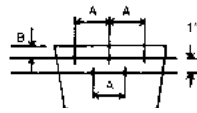

B6

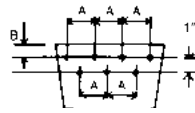

B7

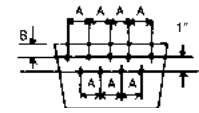

B8

Bucket Length	Salem and Other Similar Light Buckets				M.I. & Steel Buckets Style A, AA, AA-RB, B, C, etc.				Continuous Buckets			
	Punch	A	B	C*	Punch	A	B	C*	Punch	A	B	C*
6	B-1	4 ³ / ₁₆	5 ⁵ / ₈	1 ¹ / ₄	B-1	4- ³ / ₁₆	1	1 ¹ / ₄	—	—	—	—
8	B-2	3 ¹ / ₁₆	7 ⁷ / ₈	1 ¹ / ₄ - ⁵ / ₁₆	B-6	3	7 ⁷ / ₈	1 ¹ / ₄ - ⁵ / ₁₆	B-6	3	DEPTH 1 2	1 ¹ / ₄ - ⁵ / ₁₆
10	B-2	4 ¹ / ₁₆	7 ⁷ / ₈	1 ¹ / ₄ - ⁵ / ₁₆	B-6	3 ¹ / ₂	7 ⁷ / ₈	1 ¹ / ₄ - ⁵ / ₁₆	B-6	3 ¹ / ₂		1 ¹ / ₄ - ⁵ / ₁₆
12	B-3	3 ³ / ₁₆	7 ⁷ / ₈	1 ¹ / ₄ - ⁵ / ₁₆	B-6	4 ¹ / ₂	7 ⁷ / ₈	1 ¹ / ₄ - ⁵ / ₁₆	B-6	4 ¹ / ₂		1 ¹ / ₄ - ⁵ / ₁₆
14	B-4	3	7 ⁷ / ₈	1 ¹ / ₄ - ⁵ / ₁₆	B-7	4	7 ⁷ / ₈	5 ⁵ / ₁₆	B-7	4		5 ⁵ / ₁₆
16	B-5	2 ⁷ / ₁₆	7 ⁷ / ₈	1 ¹ / ₄ - ⁵ / ₁₆	B-7	4 ¹ / ₂	7 ⁷ / ₈	5 ⁵ / ₁₆	B-7	4 ¹ / ₂		5 ⁵ / ₁₆
18	—	—	—	—	—	—	—	—	B-7	5	5 ⁵ / ₁₆	

*C = Bolt Diameter. See Chart on Page H-142.

Bucket Punching — Chain

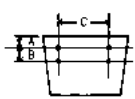

Style AA, C, SC, etc.

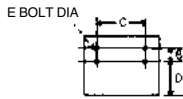

Continuous

Chain Number	Attachment Number	A	B	C	D	E
C-977	K-1	1	—	3	—	3 ³ / ₈
C-188	K-2	1	1 ¹ / ₄	4 ³ / ₁₆	2 ³ / ₄	3 ³ / ₈
C-102B	K-2	3 ³ / ₄	1 ³ / ₄	5 ⁵ / ₁₆	2	3 ³ / ₈
C-110	K-2	7 ⁷ / ₈	1 ³ / ₄	5 ⁵ / ₁₆	3 ³ / ₈	3 ³ / ₈
C-111	K-2	3 ³ / ₄	2 ³ / ₁₆	6 ¹ / ₄	2 ¹ / ₈	3 ³ / ₈
SS-102B	K-2	3 ³ / ₄	1 ³ / ₄	5 ⁵ / ₁₆	2	3 ³ / ₈
SS-110	K-2	7 ⁷ / ₈	1 ³ / ₄	5 ⁵ / ₁₆	3 ³ / ₈	3 ³ / ₈

Bucket Size	High Speed Grain			
	Punch	A	B	C
7 x 5	B2	2 ¹ / ₁₆	1 ³ / ₄	1 ¹ / ₄
9 x 5	B2	3 ³ / ₁₆	1 ³ / ₄	1 ¹ / ₄
9 x 6	B2	3 ³ / ₁₆	2	1 ¹ / ₄
11 x 6	B3	3	2	1 ¹ / ₄
12 x 6	B3	3 ³ / ₁₆	2	1 ¹ / ₄
14 x 7	B4	3	2	5 ⁵ / ₁₆

Consult *Martin* for "AC" and "SC" Bucket Punching.



Platforms

Head section service platforms are of structural steel, angle hand rails and heavy non-skid grating. The platform mounts securely to the elevator head section. Various sizes and configurations are available. Rest platforms are also available and required at 30' intervals.

Ladders/Safety Cages

Ladders with safety cages are available. They are constructed of heavy gauge steel and sized to provide easy access to platforms. Ladders with safety cage are easily bolted to the elevator casings.

Formulas for Calculating Number of Buckets, Bucket Bolts, Washers and Length of Chain or Belt



Centrifugal Discharge Chain Series 100

Number of Buckets, Bucket Bolts, Washers and Length of Chain.

Elevator Number	Buckets Style AA Malleable			Bucket Bolts and Lock Washers Hex Head Cap Screws		Chain		
	Size (Inches)	Spacing (Inches)	Quantity	Size (Inches)	Quantity	Number	Attachment Every Link	Length (Feet)
C43-101	4 x 3	9 1/4	1.5 + (2.58 x Shaft Ctrs)	1/4 x 1	2 x (No. of Buckets)	C-77	K1-4th	2.31' + (2 x Shaft Ctrs)
C64-102	6 x 4	13	4.4 + (1.85 x Shaft Ctrs)	1/4 x 1	2 x (No. of Buckets)	C-188	K1-5th	4.79' + (2 x Shaft Ctrs)
C85-103	8 x 5	16	2.75 + (1.5 x Shaft Ctrs)	3/8 x 1 1/4	4 x (No. of Buckets)	C-102B	K2-4th	3.66' + (2 x Shaft Ctrs)
C85-104	8 x 5	16	3.5 + (1.5 x Shaft Ctrs)	3/8 x 1 1/4	4 x (No. of Buckets)	C-102B	K2-4th	4.66' + (2 x Shaft Ctrs)
C85-105	8 x 5	16	3.5 + (1.5 x Shaft Ctrs)	3/8 x 1 1/4	4 x (No. of Buckets)	SS-102B	K2-4th	4.66' + (2 x Shaft Ctrs)
C85-107	8 x 5	16	4.25 + (1.5 x Shaft Ctrs)	3/8 x 1 1/4	4 x (No. of Buckets)	C-102B	K2-4th	5.66' + (2 x Shaft Ctrs)
C85-108	8 x 5	16	4.25 + (1.5 x Shaft Ctrs)	3/8 x 1 1/4	4 x (No. of Buckets)	SS-102B	K2-4th	5.66' + (2 x Shaft Ctrs)
C106-110	10 x 6	16	3.75 + (1.5 x Shaft Ctrs)	3/8 x 1 1/4	4 x (No. of Buckets)	C-102B	K2-4th	5.0' + (2 x Shaft Ctrs)
C106-111	10 x 6	16	3.75 + (1.5 x Shaft Ctrs)	3/8 x 1 1/4	4 x (No. of Buckets)	SS-102B	K2-4th	5.0' + (2 x Shaft Ctrs)
C106-112	10 x 6	18	4.33 + (1.33 x Shaft Ctrs)	3/8 x 1 1/4	4 x (No. of Buckets)	C-110	K2-3rd	6.5' + (2 x Shaft Ctrs)
C106-113	10 x 6	18	4.33 + (1.33 x Shaft Ctrs)	3/8 x 1 1/4	4 x (No. of Buckets)	SS-110	K2-3rd	6.5' + (2 x Shaft Ctrs)
C106-116	10 x 6	18	4.5 + (1.5 x Shaft Ctrs)	3/8 x 1 1/4	4 x (No. of Buckets)	C-102B	K2-4th	6.0' + (2 x Shaft Ctrs)
C127-117	12 x 7	18	4.0 + (1.33 x Shaft Ctrs)	3/8 x 1 1/4	4 x (No. of Buckets)	SS-110	K2-3rd	6.0' + (2 x Shaft Ctrs)
C127-119	12 x 7	18	4.25 + (1.5 x Shaft Ctrs)	3/8 x 1 1/4	4 x (No. of Buckets)	C-102B	K2-4th	5.66' + (2 x Shaft Ctrs)
C127-120	12 x 7	18	5.0 + (1.33 x Shaft Ctrs)	3/8 x 1 1/4	4 x (No. of Buckets)	SS-110	K2-3rd	7.5' + (2 x Shaft Ctrs)
C127-122	12 x 7	18	5.5 + (1.5 x Shaft Ctrs)	3/8 x 1 1/4	4 x (No. of Buckets)	C-102B	K2-4th	7.33' + (2 x Shaft Ctrs)
C147-123	14 x 7	19	3.79 + (1.26 x Shaft Ctrs)	1/2 x 1 1/4	4 x (No. of Buckets)	C-111	K2-4th	6.0' + (2 x Shaft Ctrs)
C147-124	14 x 7	18	4.0 + (1.33 x Shaft Ctrs)	3/8 x 1 1/4	4 x (No. of Buckets)	SS-110	K2-3rd	6.0' + (2 x Shaft Ctrs)
C147-126	14 x 7	16	4.25 + (1.5 x Shaft Ctrs)	3/8 x 1 1/4	4 x (No. of Buckets)	C-102B	K2-4th	5.66' + (2 x Shaft Ctrs)
C147-127	14 x 7	19	4.74 + (1.26 x Shaft Ctrs)	3/8 x 1 1/4	4 x (No. of Buckets)	C-111	K2-4th	7.5' + (2 x Shaft Ctrs)
C147-128	14 x 7	18	5.0 + (1.33 x Shaft Ctrs)	3/8 x 1 1/4	4 x (No. of Buckets)	SS-110	K2-3rd	7.5' + (2 x Shaft Ctrs)
C147-130	14 x 7	16	5.5 + (1.5 x Shaft Ctrs)	3/8 x 1 1/4	4 x (No. of Buckets)	C-102B	K2-4th	7.33' + (2 x Shaft Ctrs)
C168-131	16 x 8	19	3.48 + (1.26 x Shaft Ctrs)	1/2 x 1 1/4	4 x (No. of Buckets)	C-111	K2-4th	5.55' + (2 x Shaft Ctrs)
C168-132	16 x 8	18	3.66 + (1.33 x Shaft Ctrs)	3/8 x 1 1/4	4 x (No. of Buckets)	SS-110	K2-3rd	5.5' + (2 x Shaft Ctrs)
C168-133	16 x 8	19	4.51 + (1.26 x Shaft Ctrs)	1/2 x 1 1/4	4 x (No. of Buckets)	C-111	K2-4th	7.13' + (2 x Shaft Ctrs)
C168-134	16 x 8	18	4.66 + (1.33 x Shaft Ctrs)	3/8 x 1 1/4	4 x (No. of Buckets)	SS-110	K2-3rd	7.0' + (2 x Shaft Ctrs)

Centrifugal Discharge Belt Series 100

Number of Buckets, Bucket Bolts, Washers and Length of Belt.

Elevator Number	Buckets Style AA Malleable			Bucket Bolts and Lock Washers (Norway Elevator Bolts)		Belt (Including 3 Buckets Overlap)	
	Size (Inches)	Spacing (Inches)	Quantity	Size (Inches)	Quantity	No. of Holes to be Punched in Belt	Length (Feet)
B43-139	4 x 3	8	3.12 + (3 x Shaft Ctrs)	1/4 x 1	2 x (No. of Buckets)	6 + (No. of Bolts)	5' + (2 x Shaft Ctrs)
B64-140	6 x 4	13	4.85 + (1.85 x Shaft Ctrs)	1/4 x 1	2 x (No. of Buckets)	6 + (No. of Bolts)	9' + (2 x Shaft Ctrs)
B64-141	6 x 4	13	4.34 + (1.85 x Shaft Ctrs)	1/4 x 1	2 x (No. of Buckets)	6 + (No. of Bolts)	9' + (2 x Shaft Ctrs)
B85-142	8 x 5	16	3.34 + (1.5 x Shaft Ctrs)	1/4 x 1 1/4	5 x (No. of Buckets)	15 + (No. of Bolts)	9' + (2 x Shaft Ctrs)
B85-143	8 x 5	16	4.13 + (1.5 x Shaft Ctrs)	1/4 x 1 1/4	5 x (No. of Buckets)	15 + (No. of Bolts)	10' + (2 x Shaft Ctrs)
B106-144	10 x 6	16	3.53 + (1.5 x Shaft Ctrs)	3/8 x 1 1/4	5 x (No. of Buckets)	15 + (No. of Bolts)	9' + (2 x Shaft Ctrs)
B106-145	10 x 6	16	4.34 + (1.5 x Shaft Ctrs)	3/8 x 1 1/4	5 x (No. of Buckets)	15 + (No. of Bolts)	10' + (2 x Shaft Ctrs)
B127-146	12 x 7	18	3.86 + (1.33 x Shaft Ctrs)	3/8 x 1 1/4	5 x (No. of Buckets)	15 + (No. of Bolts)	11' + (2 x Shaft Ctrs)
B127S-146S	12 x 7	16	6.28 + (3 x Shaft Ctrs)	1/2 x 1 1/4	5 x (No. of Buckets)	15 + (No. of Bolts)	15' + (2 x Shaft Ctrs)
B127-147	12 x 7	18	4.72 + (1.33 x Shaft Ctrs)	3/8 x 1 1/4	5 x (No. of Buckets)	15 + (No. of Bolts)	13' + (2 x Shaft Ctrs)
B147-148	14 x 7	18	3.86 + (1.33 x Shaft Ctrs)	3/8 x 1 1/4	7 x (No. of Buckets)	21 + (No. of Bolts)	11' + (2 x Shaft Ctrs)
B147-149	14 x 7	18	4.72 + (1.33 x Shaft Ctrs)	3/8 x 1 1/4	7 x (No. of Buckets)	21 + (No. of Bolts)	13' + (2 x Shaft Ctrs)
B168-150	16 x 8	18	3.31 + (1.33 x Shaft Ctrs)	3/8 x 1 1/4	7 x (No. of Buckets)	21 + (No. of Bolts)	10' + (2 x Shaft Ctrs)
B168-152	16 x 8	18	4.72 + (1.33 x Shaft Ctrs)	3/8 x 1 1/4	7 x (No. of Buckets)	21 + (No. of Bolts)	13' + (2 x Shaft Ctrs)

Continuous Discharge Chain Series 700

Number of Buckets, Bucket Bolts, Washers and Length of Chain.

Elevator Number	Buckets Medium Front Continuous Steel Buckets			Bucket Bolts and Lock Washers Hex Head Cap Screws		Chain		
	Size (Inches)	Spacing (Inches)	Quantity	Size (Inches)	Quantity	Number	Attachment Every Link	Length (Feet)
C85-766	8 x 5 x 7 1/4	8	6.57 + (3 x Shaft Ctrs)	3/8 x 1 1/4	4 x (No. of Buckets)	C-102B	K2-2nd	4.66' + (2 x Shaft Ctrs)
C85-767	8 x 5 x 7 1/4	8	6.57 + (3 x Shaft Ctrs)	3/8 x 1 1/4	4 x (No. of Buckets)	SS-102B	K2-2nd	4.66' + (2 x Shaft Ctrs)
C105-768	10 x 5 x 7 1/4	8	8.25 + (3 x Shaft Ctrs)	3/8 x 1 1/4	4 x (No. of Buckets)	C-102B	K2-2nd	5.0' + (2 x Shaft Ctrs)
C105-769	10 x 5 x 7 1/4	8	8.25 + (3 x Shaft Ctrs)	3/8 x 1 1/4	4 x (No. of Buckets)	SS-102B	K2-2nd	5.0' + (2 x Shaft Ctrs)
C107-770	10 x 7 x 11 1/4	12	6.06 + (2 x Shaft Ctrs)	3/8 x 1 1/4	4 x (No. of Buckets)	C-110	K2-2nd	6.5' + (2 x Shaft Ctrs)
C107-771	10 x 7 x 11 1/4	12	6.06 + (2 x Shaft Ctrs)	3/8 x 1 1/4	4 x (No. of Buckets)	SS-110	K2-2nd	6.5' + (2 x Shaft Ctrs)
C127-772	12 x 7 x 11 1/4	12	5.60 + (2 x Shaft Ctrs)	3/8 x 1 1/4	4 x (No. of Buckets)	C-110	K2-2nd	6.0' + (2 x Shaft Ctrs)
C127-773	12 x 7 x 11 1/4	12	5.60 + (2 x Shaft Ctrs)	3/8 x 1 1/4	4 x (No. of Buckets)	SS-110	K2-2nd	6.0' + (2 x Shaft Ctrs)
C147-774	14 x 7 x 11 1/4	12	5.60 + (2 x Shaft Ctrs)	3/8 x 1 1/4	4 x (No. of Buckets)	C-110	K2-2nd	6.0' + (2 x Shaft Ctrs)
C147-775	14 x 7 x 11 1/4	12	5.60 + (2 x Shaft Ctrs)	3/8 x 1 1/4	4 x (No. of Buckets)	SS-110	K2-2nd	6.0' + (2 x Shaft Ctrs)
C128-776	12 x 8 x 11 1/4	12	5.60 + (2 x Shaft Ctrs)	3/8 x 1 1/4	4 x (No. of Buckets)	C-110	K2-2nd	6.0' + (2 x Shaft Ctrs)
C128-777	12 x 8 x 11 1/4	12	5.60 + (2 x Shaft Ctrs)	3/8 x 1 1/4	4 x (No. of Buckets)	SS-110	K2-2nd	6.0' + (2 x Shaft Ctrs)
C148-778	14 x 8 x 11 1/4	12	5.60 + (2 x Shaft Ctrs)	3/8 x 1 1/4	4 x (No. of Buckets)	C-110	K2-2nd	6.0' + (2 x Shaft Ctrs)
C148-779	14 x 8 x 11 1/4	12	5.60 + (2 x Shaft Ctrs)	3/8 x 1 1/4	4 x (No. of Buckets)	SS-110	K2-2nd	6.0' + (2 x Shaft Ctrs)
C168-781	16 x 8 x 11 1/4	12	5.33 + (2 x Shaft Ctrs)	3/8 x 1 1/4	4 x (No. of Buckets)	SS-110	K2-2nd	5.5' + (2 x Shaft Ctrs)
C168-783	16 x 8 x 11 1/4	12	5.33 + (2 x Shaft Ctrs)	3/8 x 1 1/4	4 x (No. of Buckets)	SS-110	K2-2nd	5.5' + (2 x Shaft Ctrs)

Continuous Discharge Belt Series 700

Number of Buckets, Bucket Bolts, Washers and Length of Chain.

Elevator Number	Buckets Medium Front Continuous Steel Buckets			Bucket Bolts and Lock Washers (Norway Elevator Bolts)		Belt (Including 3 Buckets Overlap)		
	Size (Inches)	Spacing (Inches)	Quantity	Size (Inches)	Quantity	Width (Inches)	No. of Holes to be Punched in Belt	Length (Feet)
B85-790	8 x 5 x 7 1/4	8	7.88 + (3 x Shaft Ctrs)	1/2 x 3/4	5 x (No. of Buckets)	9	15 + (No. of Bolts)	8' + (2 x Shaft Ctrs)
B105-791	10 x 5 x 7 1/4	8	6.5 + (3 x Shaft Ctrs)	3/8 x 1	5 x (No. of Buckets)	11	15 + (No. of Bolts)	7' + (2 x Shaft Ctrs)
B107-792	10 x 7 x 11 1/4	12	5.75 + (2 x Shaft Ctrs)	3/8 x 1	5 x (No. of Buckets)	11	15 + (No. of Bolts)	10' + (2 x Shaft Ctrs)
B127-793	12 x 7 x 11 1/4	12	5.75 + (2 x Shaft Ctrs)	3/8 x 1 1/4	5 x (No. of Buckets)	13	15 + (No. of Bolts)	10' + (2 x Shaft Ctrs)
B147-794	14 x 7 x 11 1/4	12	5.75 + (2 x Shaft Ctrs)	3/8 x 1 1/4	7 x (No. of Buckets)	15	21 + (No. of Bolts)	10' + (2 x Shaft Ctrs)
B128-795	12 x 8 x 11 1/4	12	5.75 + (2 x Shaft Ctrs)	3/8 x 1 1/4	5 x (No. of Buckets)	13	15 + (No. of Bolts)	10' + (2 x Shaft Ctrs)
B148-796	14 x 8 x 11 1/4	12	5.75 + (2 x Shaft Ctrs)	3/8 x 1 1/4	7 x (No. of Buckets)	15	21 + (No. of Bolts)	10' + (2 x Shaft Ctrs)
B168-797	16 x 8 x 11 1/4	12	5.75 + (2 x Shaft Ctrs)	3/8 x 1 1/4	7 x (No. of Buckets)	17	21 + (No. of Bolts)	10' + (2 x Shaft Ctrs)
B163-798	16 x 8 x 11 1/4	12	4.96 + (2 x Shaft Ctrs)	3/8 x 1 1/4	7 x (No. of Buckets)	19	21 + (No. of Bolts)	9' + (2 x Shaft Ctrs)

☆ If answer is a fraction, go to next whole number. Consult *Martin* for units not shown.



High Speed Grain Centrifugal Discharge Belt Series 500

Martin Model Number	No. Bucket Rows	Capacity				Buckets Standard Duty Plastic				Belt Width	Pulley Width	Head Pulley	Boot Pulley	Boot Pulley	Hd. & Bt. Casing Dimensions		Intermediate Casing Dimensions		Casing Thicknesses							
		C.F.H.		at Speed		Typical Style	Width In.	Proj. In.	Spacing In.						Inches	Inches	Dia. In.	Dia. In.	Dia. In.	Depth "C" In.	Width "A" In.	Depth "C" In.	Width "B" In.	Head	Boot	Int.
		@ "Y-Y +5 Deg." Max. Useable	@ "Y - Y" (W.L.)	Belt FPM	H.S. RPM																					
B64-508 *	1	782	697	265	119	HD-MAX	6.250	4.500	7	7	7	8	8	1-3/16	9	20	8	20 *	12 ga.	12 ga.	12 ga.					
B65-512A	1	1,078	980	350	107	HD-MAX	6.250	5.625	10	7	8	12	12	1-7/16	9	27	9	8	12 ga.	12 ga.	12 ga.					
B65-512B	1	1,541	1,400	350	107	HD-MAX	6.250	5.625	7	7	8	12	12	1-7/16	9	27	9	8	12 ga.	12 ga.	12 ga.					
B95-518A	1	1,852	1,640	440	90	HD-MAX	9.375	5.625	12	10	11	18	18	1-7/16	12	34	12	9	12 ga.	10 ga.	12 ga.					
B95-518B	1	2,470	2,187	440	90	HD-MAX	9.375	5.625	9	10	11	18	18	1-7/16	12	34	12	9	12 ga.	10 ga.	12 ga.					
B95-518C	1	3,176	2,812	440	90	HD-MAX	9.375	5.625	7	10	11	18	18	1-7/16	12	34	12	9	12 ga.	10 ga.	12 ga.					
B96-524	1	3,973	3,599	460	70	HD-MAX	9.375	6.625	8	10	11	24	24	1-15/16	13	42	13	10	10 ga.	10 ga.	12 ga.					
B96-530	1	4,405	3,991	510	63	HD-MAX	9.375	6.625	8	10	11	30	30	1-15/16	15	48	15	10	10 ga.	3/16"	12 ga.					
B106-530	1	4,930	4,533	510	63	HD-MAX	10.375	6.625	8	11	12	30	30	1-15/16	15	48	15	10	10 ga.	3/16"	12 ga.					
B136-530	1	6,387	5,864	510	63	HD-MAX	13.375	6.625	8	14	15	30	30	1-15/16	18	48	18	10	10 ga.	3/16"	12 ga.					
B127-536	1	8,878	8,122	600	62	HD-MAX	12.500	7.750	9	13	15	36	36	2-7/16	18	56	18	11	10 ga.	3/16"	12 ga.					
B147-536	1	10,747	9,900	600	62	HD-MAX	14.500	7.750	9	15	16	36	36	2-7/16	21	56	21	11	10 ga.	3/16"	12 ga.					
B167-536	1	12,000	11,288	600	62	HD-MAX	16.500	7.750	9	17	19	36	36	2-7/16	21	56	21	11	10 ga.	3/16"	12 ga.					
B168-542	1	14,750	13,797	620	55	HD-MAX	16.500	8.750	10	17	19	42	42	2-7/16	23	68	23	14	3/16"	3/16"	12 ga.					
B188-542	1	16,740	15,763	620	55	HD-MAX	18.500	8.750	10	20	22	42	42	2-7/16	26	68	26	14	3/16"	3/16"	12 ga.					
B2108-548	2	20,648	19,163	700	55	HD-MAX	10.500	8.750	10	22	24	48	48	2-15/16	28	74	28	14	3/16"	1/4"	10 ga.					
B2138-548	2	26,411	23,706	700	55	HD-MAX	13.500	8.750	10	28	30	48	48	2-15/16	34	74	34	14	3/16"	1/4"	10 ga.					
B2168-548	2	33,314	31,680	700	55	HD-MAX	16.500	8.750	10	34	36	48	48	2-15/16	40	74	40	14	3/16"	1/4"	10 ga.					
B2188-548	2	37,800	35,595	700	55	HD-MAX	18.500	8.750	10	38	40	48	48	3-7/16	44	74	44	14	3/16"	1/4"	10 ga.					
B3168-548	3	49,971	47,521	700	55	HD-MAX	16.500	8.750	10	50	52	48	48	3-7/16	56	74	56	14	3/16"	1/4"	10 ga.					
B4158-548	4	63,221	59,651	700	55	HD-MAX	15.500	8.750	10	62	64	48	48	3-7/16	68	74	68	14	3/16"	1/4"	10 ga.					
B4188-548	4	75,600	71,190	700	55	HD-MAX	18.500	8.750	10	74	76	48	48	3 7/16	80	74	80	14	3/16"	1/4"	10 ga.					

* Single Leg intermediate casing; 50' maximum height.
 Head shaft diameter to be determined by customer's application and specifications.
 Plastic buckets are available as Nylon, HDP, or Urethane. Steel is available on special request.

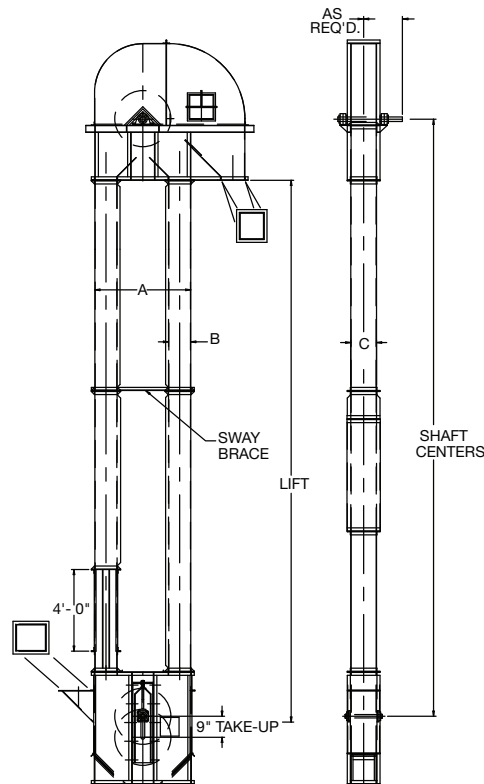

Elevator Number	Dimensions ¹ (In Inches)																			Boot Shaft Diameter
	A	B	C	D	E	F	H	J	K	N*	Q	R	T	V	W	Y	Z ₁	A ₁	A ₂	
B75-506 and B75-508	41	9½	11	44	14	38½	33½	30%	34%	9	32	12%	6	23%	20	40	12½	11	10	1½
B95-514 and B95-515	47	11	13	50	16	46½	41	35%	41%	10	38	14%	6	29%	22	45	15½	13	13	1½
B96-526 and B96-528	49	11	13	52	16	47½	42	36%	42%	13	40	14%	6	29%	22	45	15½	13	13	1½
B116-536 and B116-538	56	12½	15	59	18	56%	47%	44%	49%	13	47	16%	6	35%	27	51	19	15	15	2
B126-546 and B126-548	56	12½	16	59	19	56%	47%	44%	49%	13	47	17%	6	35%	27	51	19	16	15	2
B147-556 and B147-558	63	13	18	65	21	68%	53	55%	57%	15	52	19%	6	41½	33	57	25½	18	17	2

* Approximate. ¹ Not certified for construction.

CONVEYORS

Drag Conveyors Section VII

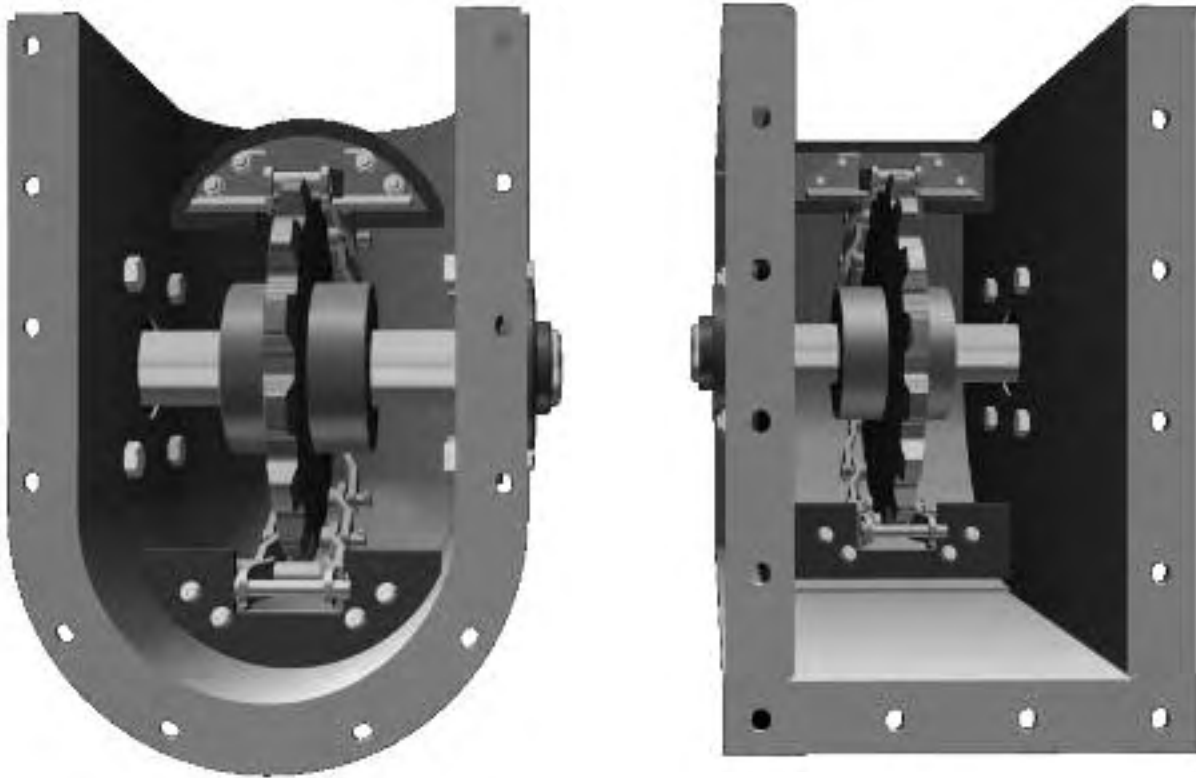

SECTION VII

DRAG CONVEYOR SECTION VII

Safety	H-145
Round Bottom Drag Conveyor	H-146
Flat Bottom Drag Conveyor	H-149
L & S Path Drag Conveyor.....	H-153

CONVEYORS



WARNING AND SAFETY REMINDERS FOR SCREW, DRAG, AND BUCKET ELEVATOR CONVEYORS

APPROVED FOR DISTRIBUTION BY THE SCREW CONVEYOR SECTION OF THE CONVEYOR EQUIPMENT MANUFACTURERS ASSOCIATION (CEMA)

It is the responsibility of the contractor, installer, owner and user to install, maintain and operate the conveyor, components and, conveyor assemblies in such a manner as to comply with the Williams-Steiger Occupational Safety and Health Act and with all state and local laws and ordinances and the American National Standards Institute (ANSI) B20.1 Safety Code.

In order to avoid an unsafe or hazardous condition, the assemblies or parts must be installed and operated in accordance with the following minimum provisions.

1. Conveyors shall not be operated unless all covers and/or guards for the conveyor and drive unit are in place. If the conveyor is to be opened for inspection cleaning, maintenance or observation, the electric power to the motor driving the conveyor must be LOCKED OUT in such a manner that the conveyor cannot be restarted by anyone; however remote from the area, until conveyor cover or guards and drive guards have been properly replaced.
2. If the conveyor must have an open housing as a condition of its use and application, the entire conveyor is then to be guarded by a railing or fence in accordance with ANSI standard B20.1. (Request current edition and addenda)
3. Feed openings for shovel, front loaders or other manual or mechanical equipment shall be constructed in such a way that the conveyor opening is covered by a grating. If the nature of the material is such that a grating cannot be used, then the exposed section of the conveyor is to be guarded by a railing or fence and there shall be a warning sign posted.
4. Do not attempt any maintenance or repairs of the conveyor until power has been LOCKED OUT.
5. Always operate conveyor in accordance with these instructions and those contained on the caution labels affixed to the equipment.
6. Do not place hands, feet, or any part of your body, in the conveyor.
7. Never walk on conveyor covers, grating or guards.
8. Do not use conveyor for any purpose other than that for which it was intended.
9. Do not poke or prod material into the conveyor with a bar or stick inserted through the openings.
10. Keep area around conveyor drive and control station free of debris and obstacles.
11. Eliminate all sources of stored energy (materials or devices that could cause conveyor components to move without power applied) before opening the conveyor
12. Do not attempt to clear a jammed conveyor until power has been LOCKED OUT.
13. Do not attempt field modification of conveyor or components.
14. Conveyors are not normally manufactured or designed to handle materials that are hazardous to personnel. These materials which are hazardous include those that are explosive, flammable, toxic or otherwise dangerous to personnel. Conveyors may be designed to handle these materials. Conveyors are not manufactured or designed to comply with local, state or federal codes for unfired pressure vessels. If hazardous materials are to be conveyed or if the conveyor is to be subjected to internal or external pressure, manufacturer should be consulted prior to any modifications.

blender as we have no information regarding plant wiring, plant environment, the interlocking of the screw conveyor with other equipment, extent of plant automation, etc. Other devices should not be used as a substitute for locking out the power prior to removing guards or covers. We caution that use of the secondary devices may cause employees to develop a false sense of security and fail to lock out power before removing covers or guards. This could result in a serious injury should the secondary device fail or malfunction.

There are many kinds of electrical devices for interlocking of conveyors and conveyor systems such that if one conveyor in a system or process is stopped other equipment feeding it, or following it can also be automatically stopped.

Electrical controls, machinery guards, railings, walkways, arrangement of installation, training of personnel, etc., are necessary ingredients for a safe working place. It is the responsibility of the contractor, installer, owner and user to supplement the materials and services furnished with these necessary items to make the conveyor installation comply with the law and accepted standards.

Conveyor inlet and discharge openings are designed to connect to other equipment or machinery so that the flow of material into and out of the conveyor is completely enclosed.

One or more warning labels should be visible on conveyor housings, conveyor covers and elevator housings. If the labels attached to the equipment become illegible, please order replacement warning labels from the OEM or CEMA.

The Conveyor Equipment Manufacturers Association (CEMA) has produced an audio-visual presentation entitled "Safe Operation of Screw Conveyors, Drag Conveyors, and Bucket Elevators." CEMA encourages acquisition and use of this source of safety information to supplement your safety program.

PROMINENTLY DISPLAY THESE SAFETY LABELS ON INSTALLED EQUIPMENT

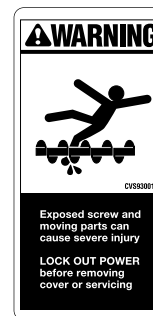

NOTICE: This document is provided by CEMA as a service to the industry in the interest of promoting safety. It is advisory only and it is not a substitute for a thorough safety program. Users should consult with qualified engineers and other safety professionals. CEMA makes no representations or warranties, either expressed or implied, and the users of this document assume full responsibility for the safe design and operation of equipment.

CONVEYORS

Round Bottom Drag Conveyor

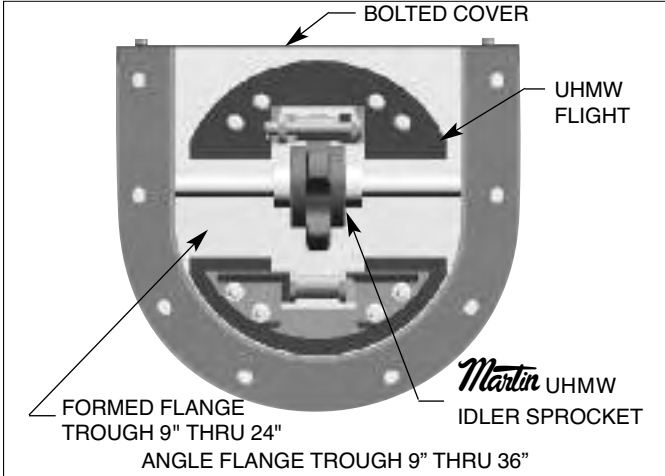

Idler Return

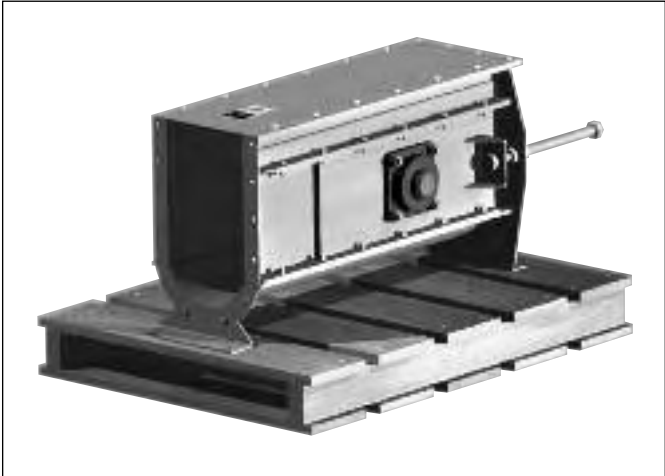

Round Bottom Tail Take-up

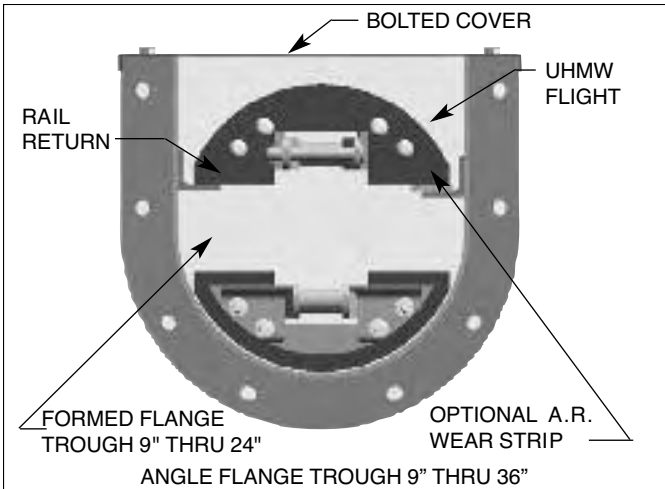

Rail Return

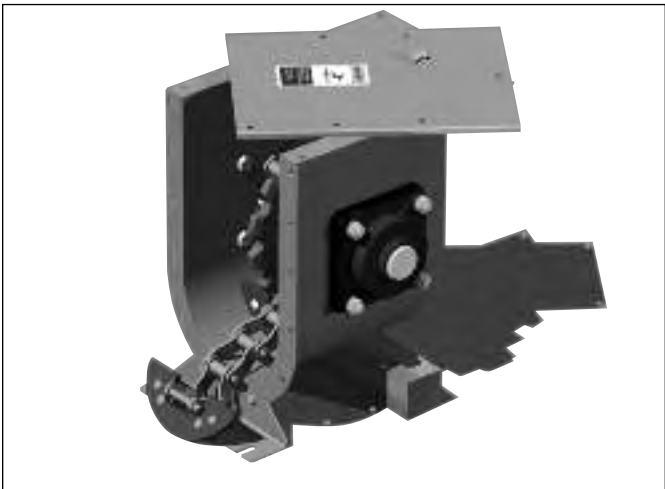

Self-Cleaning Tail

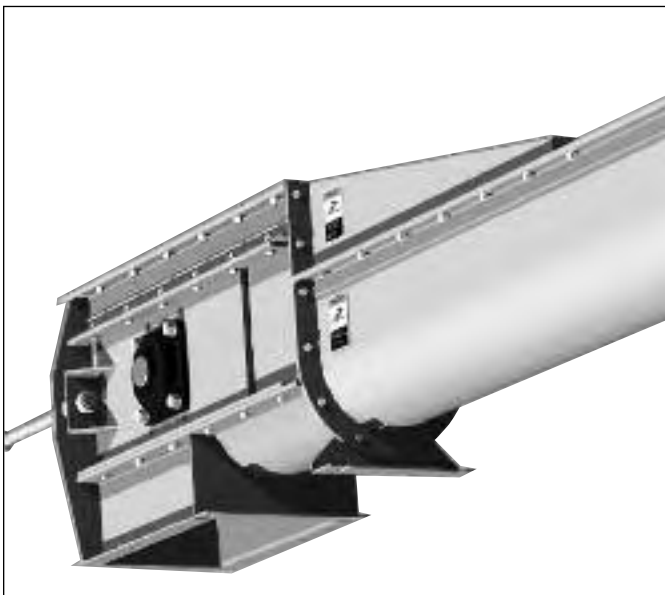

Head Take-up

Standard Features

- Bolted Flanged Covers
- Welded Steel Chain
- Jig Welded Flight Attachment
- UHMW Flights
- Heavy Duty Form Flange Trough
- Heat Treated Sprockets
- Rail Return System
- Flow Through Inlets
- Heavy Duty Backing Plate

Popular Options

- By-Pass Inlets
- Hip Roof Cover
- Self-Cleaning Tail Section
- Intermediate Discharge
- Bend Section
- Flight Saver Idler Return System
- Optional A.R. Wear Strip
- Split Sprockets

CONVEYORS

ROUND BOTTOM CONVEYOR



Capacity FPM/RPM

Series	Size	100 FPM		125 FPM		150 FPM		175 FPM		200FPM	
		CFH	RPM	CFH	RPM	CFH	RPM	CFH	RPM	CFH	RPM
900	9"	2040	33	2600	41	3050	50	3500	58	4080	66
1200	12"	3475	33	4300	41	5200	50	6075	58	6950	66
1400	14"	4750	33	5900	40	7100	50	8300	58	9500	66
1600	16"	6050	32	7600	40	9150	48	10600	56	12100	64
1800	18"	8100	32	10150	40	12300	48	14300	56	16200	64
2000	20"	10500	23	13000	29	15650	35	18200	40	21000	46
2400	24"	14800	23	18150	29	22000	35	25750	40	29600	46

Note: Dimensions not certified for construction.

NOTES:

1. Capacities are based on 100% loading with free-flowing grains at 48 pounds per cubic foot.
2. Selection of conveyors should be based upon material characteristics.
3. Capacities and speeds will vary for other types of materials and for materials conveyed at an incline.

Please consult *Martin* if you have any questions concerning your application.

Material Thickness and Approximate Shipping Weights

Series	Adj. Tail	Weight ¹	Bypass	Weight	Fixed Head	Weight	Intermediate				Cover
							Standard Duty	Weight ²	Specific Duty	Weight ³	
							900	3/16"	367	3/16"	
1200	3/16"	394	3/16"	127	3/16"	210	12 ga.	285	3/16"	420	14 ga.
1400	3/16"	412	3/16"	140	3/16"	221	12 ga.	310	3/16"	460	14 ga.
1600	3/16"	475	3/16"	160	3/16"	257	12 ga.	365	3/16"	520	14 ga.
1800	3/16"	575	3/16"	238	3/16"	281	10 ga.	507	3/16"	640	12 ga.
2000	1/4"	856	3/16"	295	3/16"	486	10 ga.	578	3/16"	705	12 ga.
2400	1/4"	899	3/16"	370	3/16"	665	10 ga.	742	3/16"	870	12 ga.

NOTES:

1. Tail and head weights shown include bearings, shafts, and standard sprockets.
2. Intermediate weights include return rails and bolted covers.

6", 30", and 36" Drag conveyors are also available upon request. Please contact *Martin* for quote.

Martin has designed its Round Bottom with the user in mind. We have incorporated larger heat-treated sprockets into our designs to reduce noise, vibration and chordal action while increasing chain and sprocket life. Our goal is to reduce maintenance and operating costs for the user.

either a rail return or optional Flight Saver Idler return system. Both systems assure long life and quiet operation.

All drag flights are a (food safe) white UHMW polyethylene material attached to welded steel chain, with exception of the 6" drag conveyor which uses combination chain.

We offer the *Martin* Round Bottom Drag with

Round Bottom Drag Conveyor

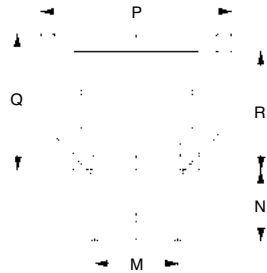
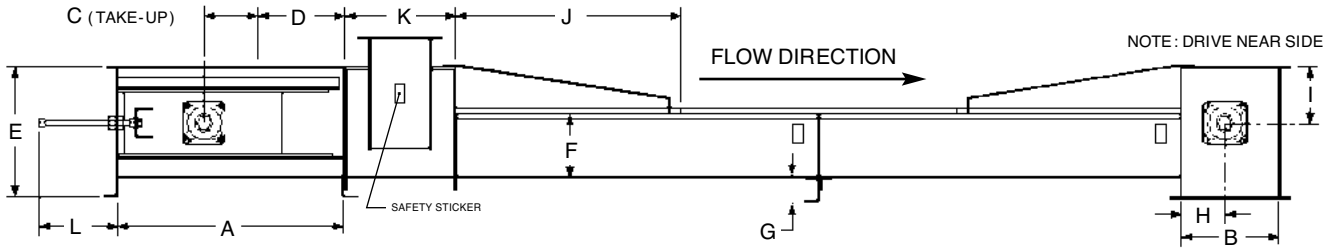

BY-PASS INLET

SERIES	A	B	C	D	E	F	G	H	I	J	K	L	M	N	P	Q	R
900	38	18	9	14¼	21⅝	11⅞	3⅞	9	9⅞	36	18	13	9⅞	8⅞	20⅞	15⅞	13⅞
1200	38	20	9	14¼	23¾	14¼	2⅞	10	9⅞	36	21	13	12¼	9½	24⅞	15⅞	13⅞
1400	38	20	9	14¼	24	16¾	3⅞	10	10⅞	36	23	13	13½	10¾	24⅞	15⅞	13⅞
1600	38	24	9	14¼	26	19⅞	3⅞	12	11⅞	36	25	13	14⅞	11⅞	28⅞	16¼	14¼
1800	38	24	9	14¼	27½	21⅞	3⅞	22	11⅞	24	27	13	16	13¼	29	16	14¼
2000	41	29	12	16	33¾	24	4¼	14½	14⅞	24	29	16	19¼	14⅞	34	20½	18½
2400	41	34	12	16	36½	29	5⅞	17	15⅞	24	33	16	20	18⅞	39	20⅞	18⅞

CONVEYORS

SERIES	A	B	C	D	E	F	G	H	J
900	10	7/16	1	4	—	4	4	18	2
1200	13	7/16	1¼	5⅞	—	5¼	5¼	20	2
1400	15	7/16	1¼	3½	3½	3½	5¼	20	2
1600	17	7/16	1¼	3¾	4	4	3⅞	24	2
1800	19	7/16	1¼	4⅞	4⅞	4⅞	3⅞	24	2
2000	21	9/16	1½	4⅞	4¼	4¼	4	29	4
2400	25	9/16	1½	5⅞	5⅞	5½	6⅞	34	4

NOTE: Dimensions not certified for construction.

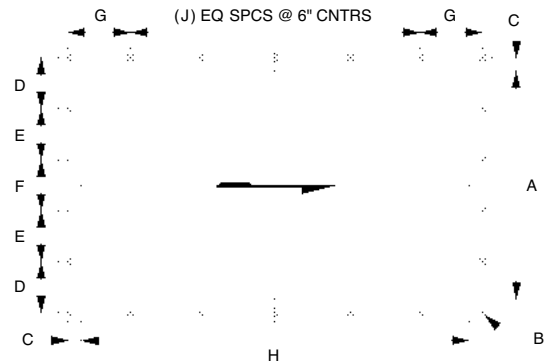

BY-PASS INLET, HEAD & INTERMEDIATE DISCHARGE

WARNING AND SAFETY REMINDER

LOCK OUT POWER before removing covers, guards or before servicing. Exposed moving parts can cause severe injury.

Note: Dimensions not certified for construction.

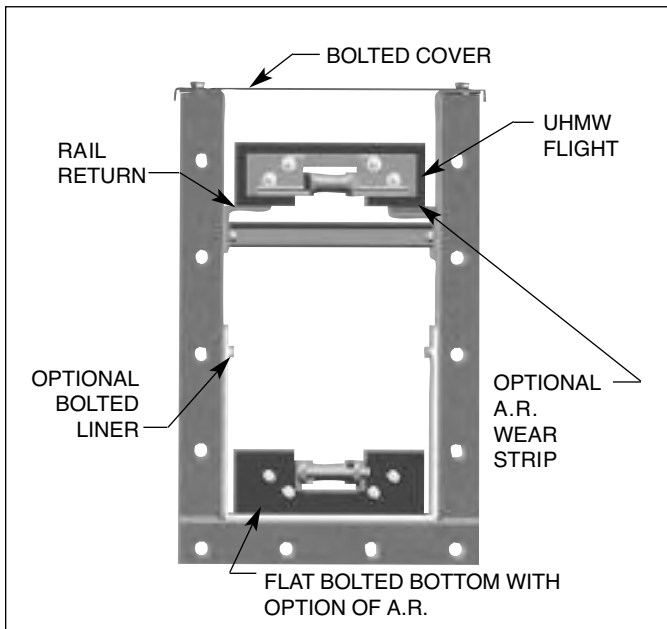

Rail Return

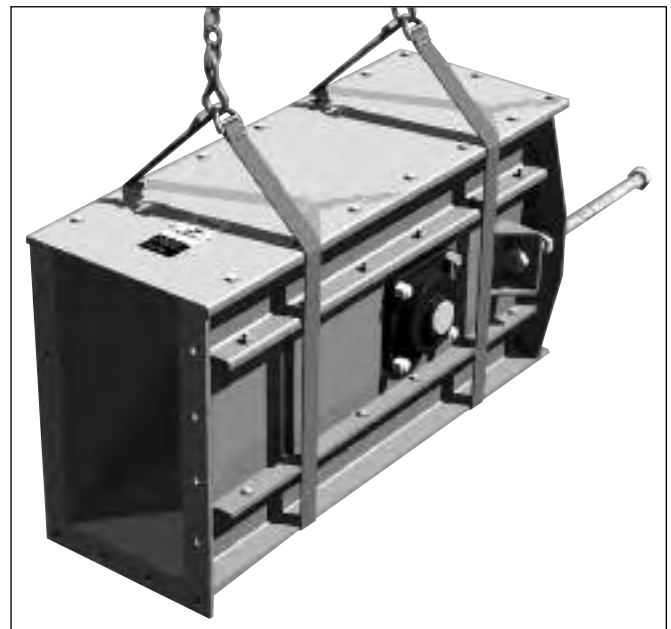

Flat Bottom Tail Take-Up

Standard Features

- Bolted Replaceable Bottom
- Bolted Flanged Covers
- Jig Welded Flight Attachment
- UHMW Flights
- Heat Treated Sprockets
- Rail Return System
- Flow Through Inlets
- Heavy Duty Backing Plate

Popular Options

- Intermediate Discharge
- Liners of Various Materials
- A.R. Steel Bottom Plate
- Controlled Feed Inlets
- Split Sprockets

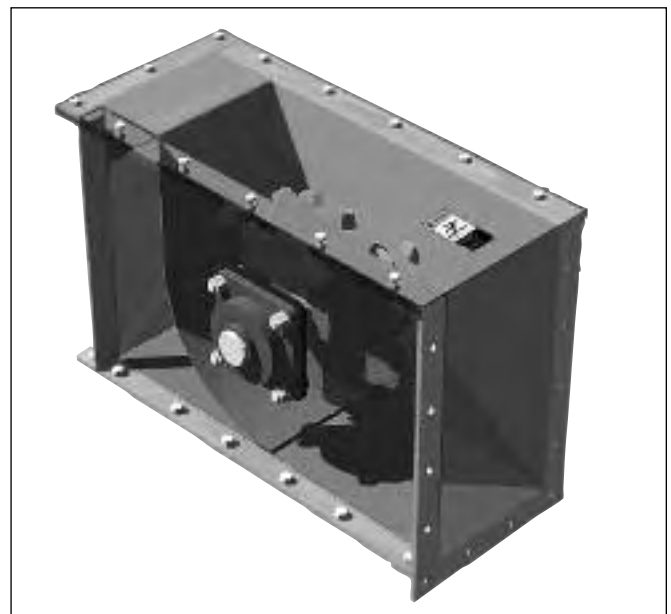

Self-Cleaning Tail

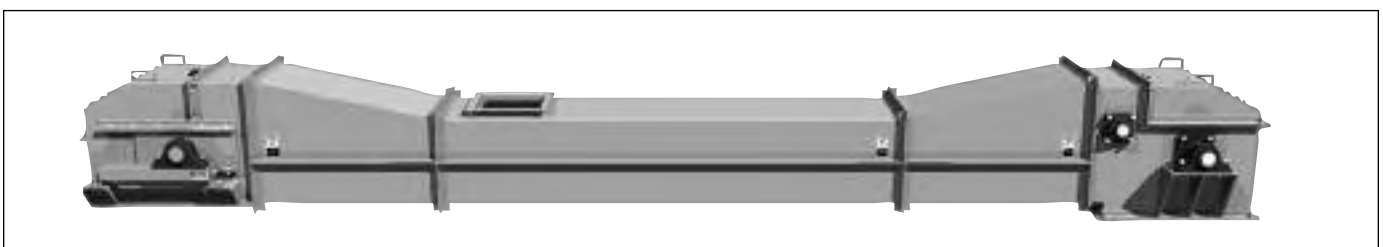

Super Duty Conveyor

Flat Bottom Drag Conveyor

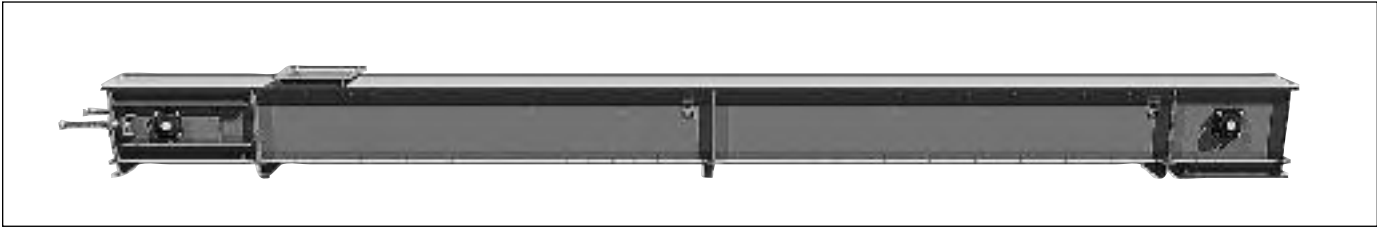

Flat Bottom Conveyor

SERIES	1 FPM			100 FPM			125 FPM			150 FPM			175 FPM			200 FPM		
	CFH	CFH	RPM	CFH	RPM	CFH	RPM	CFH	RPM	CFH	RPM	CFH	RPM	CFH	RPM	CFH	RPM	
1809	28.13	2,813	37	3,516	46	4,220	55	4,923	65	5,626	74							
2409	54.38	5,438	27	6,798	34	8,157	40	9,517	47	10,876	54							
2412	68.25	6,825	27	8,531	34	10,238	40	11,944	47	13,650	54							
2414	78.75	7,875	27	9,844	34	11,813	40	13,781	47	15,750	54							
2416	89.25	8,925	27	11,156	34	13,388	40	15,619	47	17,850	54							
2418	96.19	9,619	27	12,024	34	14,429	40	16,833	47	19,238	54							
3016	111.56	11,156	23	13,945	29	16,734	34	19,523	40	22,312	46							
3018	121.13	12,113	23	15,141	29	18,170	34	21,198	40	24,226	46							
3020	133.88	13,388	23	16,735	29	20,082	34	23,429	40	26,776	46							
3024	159.38	15,938	23	19,923	29	23,907	34	27,892	40	31,876	46							

NOTES:

1. Capacities are based on 90% loading with free-flowing grains at 48 pounds per cubic foot.
2. Selection of conveyors should be based upon material characteristics.
3. Capacities and speeds will vary for other types of materials and for materials conveyed at an incline.
4. Capacities at 90% bed depth.

Please consult *Martin* if you have any questions concerning your application.

MATERIAL THICKNESS & APPROXIMATE SHIPPING WEIGHTS							
SERIES	ADJ. TAIL	WGT.	HEAD	WGT.	INTERMEDIATE		COVER
					STD. DUTY	WGT.	
1809	10 GA.	333	10 GA.	206	10 GA.	403	14 GA.
2409	10 GA.	432	10 GA.	277	10 GA.	460	14 GA.
2412	10 GA.	454	10 GA.	306	10 GA.	492	14 GA.
2414	10 GA.	467	10 GA.	315	10 GA.	514	14 GA.
2416	10 GA.	482	10 GA.	322	10 GA.	532	14 GA.
2418	10 GA.	497	10 GA.	335	10 GA.	544	12 GA.
3016	3/16	642	3/16	438	10 GA.	655	12 GA.
3018	3/16	655	3/16	452	10 GA.	679	12 GA.
3020	3/16	690	3/16	485	10 GA.	703	12 GA.
3024	3/16	749	3/16	613	10 GA.	745	12 GA.

NOTES:

1. Tail and head weights shown include bearings, shafts and standard sprockets.
2. Intermediate weights include return rails, and bolted covers.

Warning And Safety Reminder

LOCK OUT POWER before removing covers, guards or before servicing. Exposed moving parts can cause severe injury.

Martin offers a complete line of standard Flat Bottom Drags to handle capacities up to 31,876 CFH.

Martin Super Duty Flat Bottom drags have been successfully used in applications with conveyors reaching lengths of over 660 feet and large capacities.

The *Martin* Flat Bottom drag conveyor is constructed with heavy-duty formed channel sides,

with replaceable bolted bottoms and covers. The replaceable rail return system is offered with an optional rail liner when wear is a concern.

The *Martin* Flat Bottom drag conveyor is especially suited for handling free flowing grains. When heavier abrasive materials need to be conveyed, contact *Martin* about our Mill Duty Drag conveyor with Forged Chain.

CONVEYORS

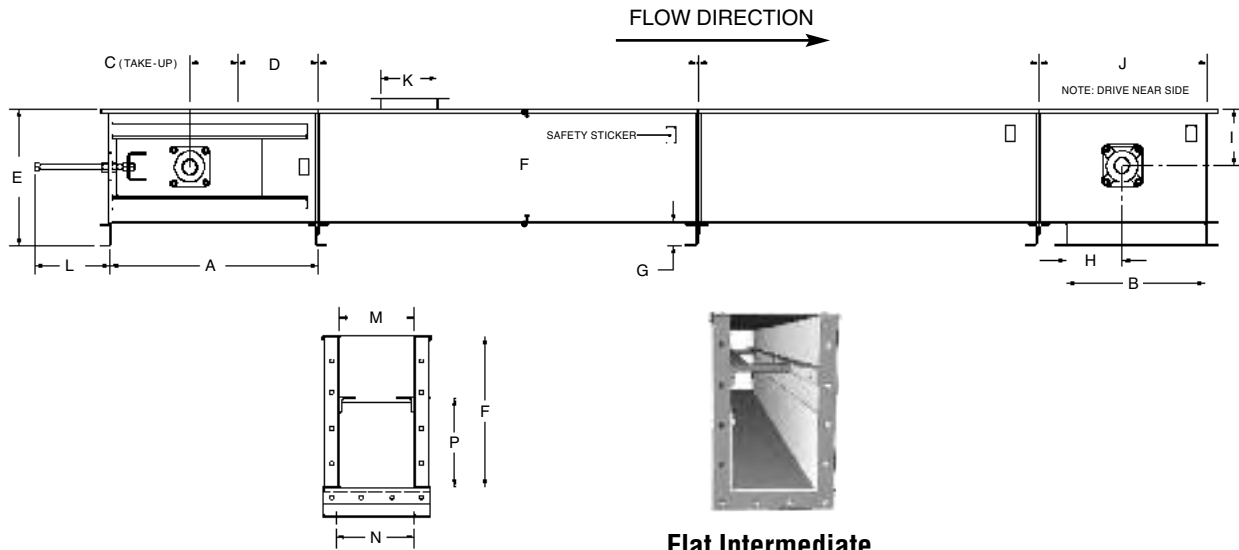

Flat Intermediate

SERIES	A	B	C	E	F	G	H	I	J	K	L	M	N	P
1809	37	25	9	18½	14¼	4	17¼	7¼	30	16	13	10	9¾	9
2409	37	25	9	24½	20¼	4	15	10¾	30	16	13	10	9¾	16
2412	37	30	9	24½	20¼	4	17½	10¾	35	18	13	13	12¼	16
2414	37	30	9	24½	20¼	4	17½	10¾	35	20	13	15	13½	16
2416	37	30	9	24½	20¼	4	17½	10¾	35	22	13	17	14¾	16
2418	37	30	9	24½	20¼	4	17½	10¾	35	25	13	19	16	16
3016	37	36	9	29½	25¼	4	20½	12¾	41	22	13	17	14¾	19½
3018	37	36	9	29½	25¼	4	20½	12¾	41	25	13	19	16	19½
3020	37	36	9	29½	25¼	4	20½	12¾	41	27	13	21	19¼	19½
3024	37	36	9	29½	25¼	4	20½	12¾	41	31	13	25	20	19½

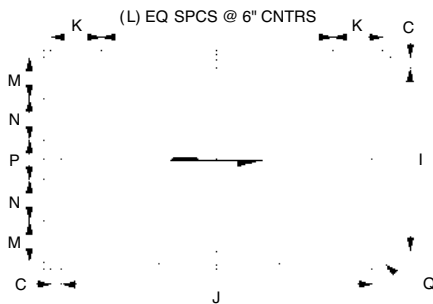

Head & Intermediate Discharge

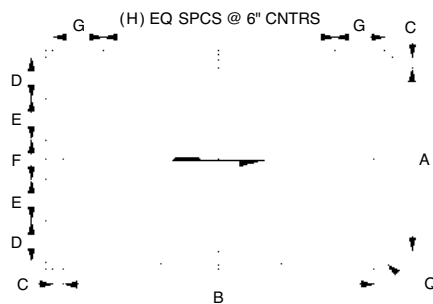

Standard Inlet

SERIES	A	B	C	D	E	F	G	H	I	J	K	L	M	N	P	Q
1809	7	16	1	4½	***	***	3	2	10	25	3½	3	4	***	4	⅞
2409	7	16	1	4½	***	***	3	2	10	25	3½	3	4	***	4	⅞
2412	10	18	1¼	4	***	***	4¼	2	13	30	4¼	4	5½	***	5¼	⅞
2414	12	20	1¼	4½	***	***	5¼	2	15	30	4¼	4	3½	3½	3½	⅞
2416	14	22	1¼	3¼	3¼	3¼	3¼	3	17	30	4¼	4	3¼	4	4	⅞
2418	15	25	1½	3½	3½	3½	5	3	19	30	4¼	4	4⅞	4%	4%	⅞
3016	14	22	1½	3¼	3¼	3¼	3¼	3	17	36	4½	5	3¼	4	4	⅞
3018	15	25	1½	3½	3½	3½	5	3	19	36	4½	5	4⅞	4%	4%	⅞
3020	17	27	1½	4	4	4	6	3	21	36	4½	5	4¾	4%	4%	⅞
3024	21	31	1½	3¾	3¾	3¾	5	4	25	36	4½	5	5%	5%	5%	⅞

Note: Dimensions not certified for construction.

Flat Bottom Drag Conveyor

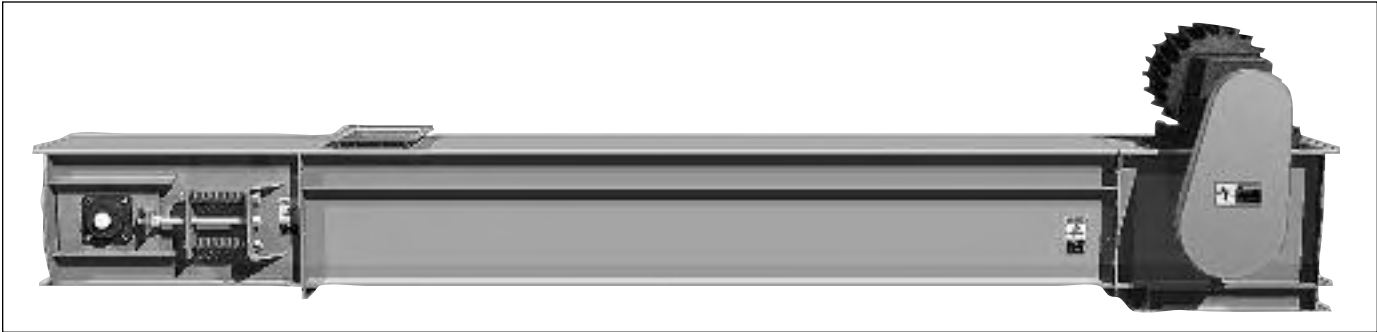

Mill Duty Conveyor

Standard Features

- Forged Chain and Steel Flights
- A.R. Steel Return Tray or Rail Return System
- Spring Loaded Take-up
- Split Sprockets

Popular Options

- A.R. Steel Side Liners
- By-pass Inlet
- Self-cleaning Tail

Capacities and Speeds					
SERIES	FPM	25 FPM		50 FPM	
	CFH	CFH	RPM	CFH	RPM
1200 MD	58	1400	8	2800	16
1600 MD	96	2400	7.5	4800	15
2000 MD	130	3250	5	6500	10
2400 MD	192	4800	5	9600	10

The *Martin* Mill Duty Drag is designed for handling heavy and abrasive materials, such as limestone, aggregate, and sand.

Please consult *Martin* if you have any questions concerning your application.

Warning And Safety Reminder

LOCK OUT POWER before removing covers, guards or before servicing. Exposed moving parts can cause severe injury.

CONVEYORS

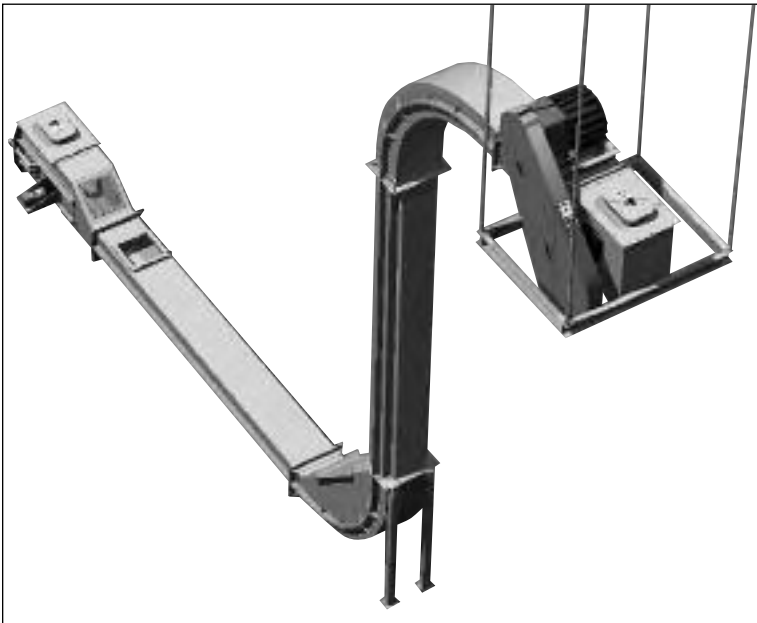

Special Application Drag



Martin-Built Take-up

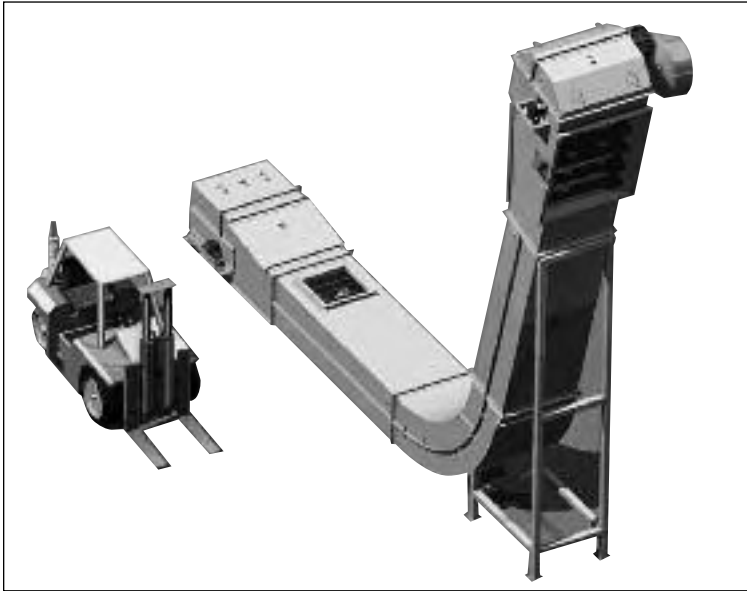

L-Path Conveyor

Series	1FPM		50 FPM		75 FPM		100 FPM	
	CFH	CFH	RPM	CFH	RPM	CFH	RPM	
57	12	600	17	900	26	1200	35	
610	20	1000	11	1500	16-1/2	2000	22	
913	35	1750	8	2625	12	3500	16	
1020	58	2900	11	4350	16-1/2	5800	22	
1224	87	4350	11	6525	16-1/2	8700	22	
1236	129	6450	10	9675	15	12900	20	
1342	150	7500	10	11250	15	15000	20	

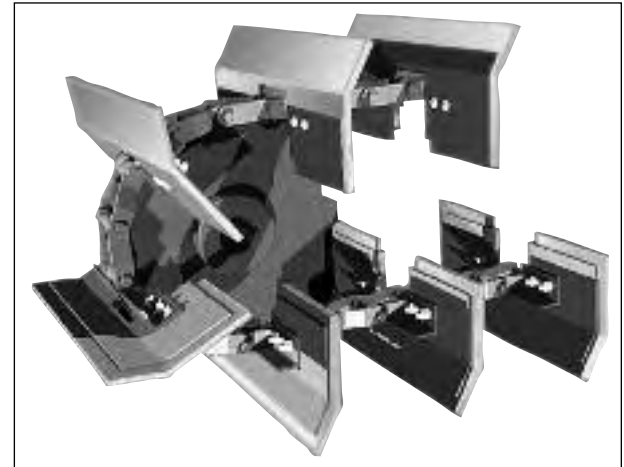

Single Chain Configuration



S-Path Conveyor

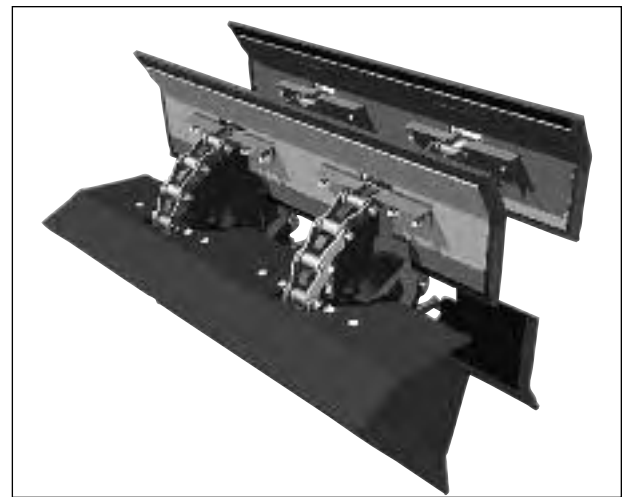

Double Chain Configuration

NOTES:

- Capacities are based on the handling of non-abrasive materials (as listed).
 - Cotton Seed Hulls • Cotton Seed Meal • Delinted Cotton Seed
 - Ground Feed • Whole Soybeans • Hot Soybean Meal
 - Whole Corn • Whole Rice
- CAUTION** should be observed when handling fine granular materials (as listed).
 - Wheat Flour • Sugar • Powdered Lime • Starch
 - Carbon Black • Soda Ash

CHAIN FEATURES

- Welded Steel or Forged Chain
- UHMW Flights
- Jig Welded Attachments
- Heavy Duty Backing Plates

Please consult *Martin* if you have any questions concerning your application.

L-Path Drag Conveyor

L-Path Conveyor

Series	610	913	1020	1224	1236	1342
A	68	89	96	96	96	96
B	29	37	35	38-5/8	38-5/8	38-5/8
C	12	12	12	12	12	12
D	2	2	2	2	2	2
E	14-1/2	20	22-1/4	28-1/4	28-1/4	28-1/4
F	3	3	6	6	6	6
G	96	96	96	120	120	120
H	82	108	108	116	116	116
I	36	42	54	60	60	60
J	32	38	40	44	44	44
K	18-3/4	22-1/2	28-1/2	32-1/2	44-1/2	50-1/2
L	18-3/4	22-1/2	28-1/2	32-1/2	44-1/2	50-1/2
M	11	14	21	25	37	43
N	4-1/8	4-1/8	4-1/8	4-1/8	4-1/8	4-1/8
P	21-1/2	25	25	29	29	29
Q	36-1/8	42-1/8	44-1/8	48-1/8	48-1/8	48-1/8

Consult factory for information on 57 Series and other sizes.

Note: Dimensions not certified for construction.

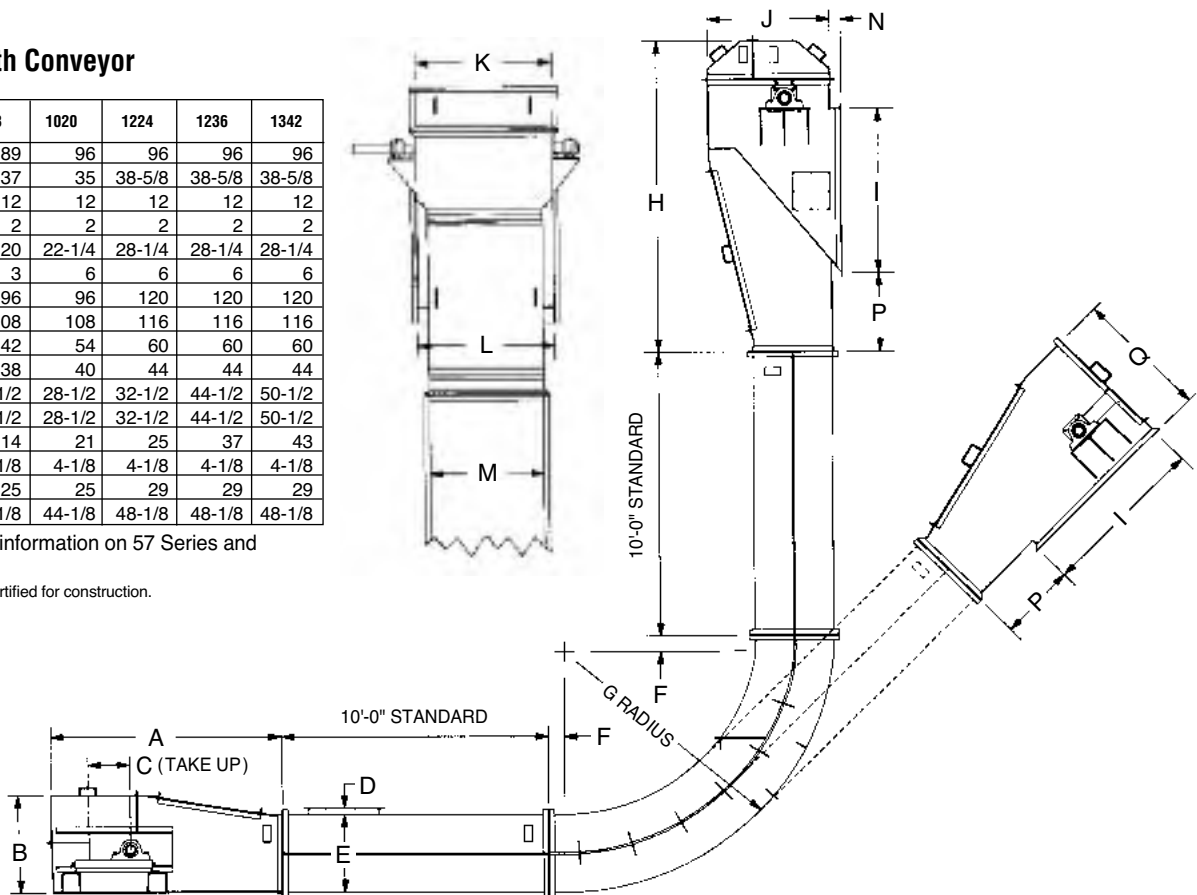

Standard Inlet

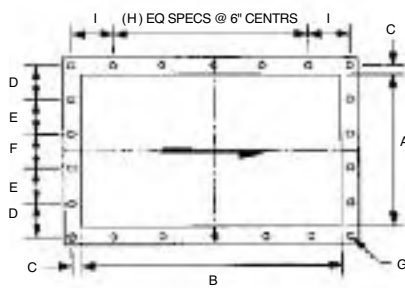

Head Discharge 45°-90°

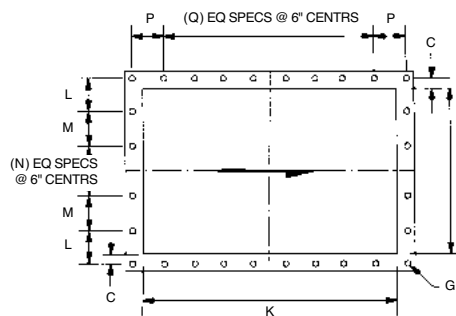

Head Discharge 0°-45°

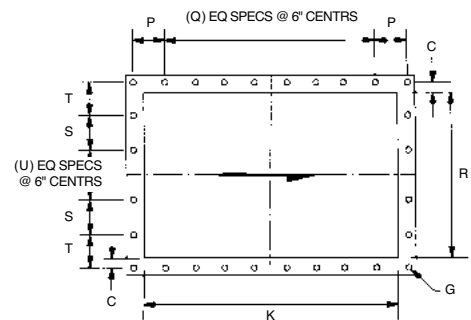

SERIES	A	B	C	D	E	F	G	H	I	J	K	L	M	N	P	Q	R	S	T	U
610	7	16	1	4½	***	***	7/16	2	3	18¾	36	4¾	***	2	4	5	11	***	3½	3½
913	10	18	1¼	4	***	4½	7/16	2	4¼	22½	42	4¾	4¼	1	4¼	6	14	4¼	3½	1
1020	17	27	1½	4	4	4	9/16	3	6	29	54	4	***	4	4½	8	21	4½	4½	1
1224	21	31	1½	4¾	4¾	5	9/16	4	5	33	60	***	***	6	4½	9	25	***	5	3
1236	33	43	1½	4½	6	6	9/16	6	5	45	60	***	***	8	4½	9	37	***	5	5
1342	38	48	1½	5½	6	6	9/16	7	4½	51	60	4½	4½	6	4½	9	43	4	4	5

Note: Dimensions not certified for construction.

CONVEYORS

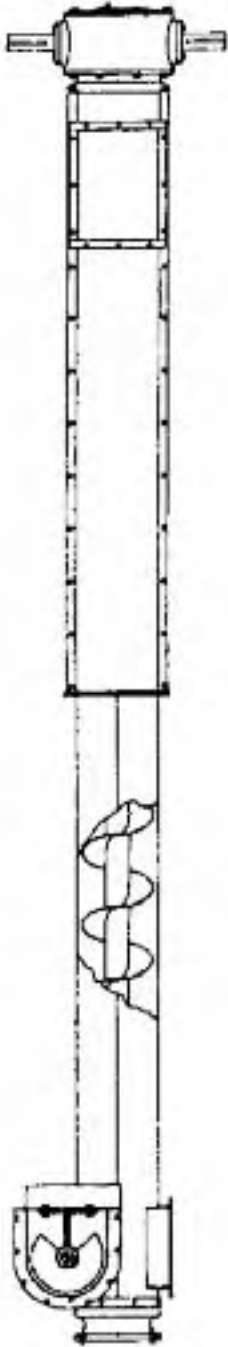

SECTION VIII VERTICAL SCREW ELEVATOR SECTION VIII

Warning and Safety Reminder	H-156
Introduction	H-157
Screw Elevator Types	H-158
Standard Components	H-159
Standard Screw Elevator Speed and Capacity	H-160
Type B Dimensions	H-161
Super Screw Elevator Speed and Capacity	H-162
Super Screw Drive Unit	H-163
Super Screw Elevator Dimensions	H-164

**Standard Screw
Elevator**

Warning & Safety Reminder

Martin



WARNING AND SAFETY REMINDERS FOR SCREW, DRAG, AND BUCKET ELEVATOR CONVEYORS

APPROVED FOR DISTRIBUTION BY THE SCREW CONVEYOR SECTION OF THE CONVEYOR EQUIPMENT MANUFACTURERS ASSOCIATION (CEMA)

It is the responsibility of the contractor, installer, owner and user to install, maintain and operate the conveyor, components and, conveyor assemblies in such a manner as to comply with the Williams-Steiger Occupational Safety and Health Act and with all state and local laws and ordinances and the American National Standards Institute (ANSI) B20.1 Safety Code.

In order to avoid an unsafe or hazardous condition, the assemblies or parts must be installed and operated in accordance with the following minimum provisions.

1. Conveyors shall not be operated unless all covers and/or guards for the conveyor and drive unit are in place. If the conveyor is to be opened for inspection cleaning, maintenance or observation, the electric power to the motor driving the conveyor must be LOCKED OUT in such a manner that the conveyor cannot be restarted by anyone; however remote from the area, until conveyor cover or guards and drive guards have been properly replaced.
2. If the conveyor must have an open housing as a condition of its use and application, the entire conveyor is then to be guarded by a railing or fence in accordance with ANSI standard B20.1. (Request current edition and addenda)
3. Feed openings for shovel, front loaders or other manual or mechanical equipment shall be constructed in such a way that the conveyor opening is covered by a grating. If the nature of the material is such that a grating cannot be used, then the exposed section of the conveyor is to be guarded by a railing or fence and there shall be a warning sign posted.
4. Do not attempt any maintenance or repairs of the conveyor until power has been LOCKED OUT.
5. Always operate conveyor in accordance with these instructions and those contained

on the caution labels affixed to the equipment.

6. Do not place hands, feet, or any part of your body, in the conveyor.
7. Never walk on conveyor covers, grating or guards.
8. Do not use conveyor for any purpose other than that for which it was intended.
9. Do not poke or prod material into the conveyor with a bar or stick inserted through the openings.
10. Keep area around conveyor drive and control station free of debris and obstacles.
11. Eliminate all sources of stored energy (materials or devices that could cause conveyor components to move without power applied) before opening the conveyor
12. Do not attempt to clear a jammed conveyor until power has been LOCKED OUT.
13. Do not attempt field modification of conveyor or components.
14. Conveyors are not normally manufactured or designed to handle materials that are hazardous to personnel. These materials which are hazardous include those that are explosive, flammable, toxic or otherwise dangerous to personnel. Conveyors may be designed to handle these materials. Conveyors are not manufactured or designed to comply with local, state or federal codes for unfired pressure vessels. If hazardous materials are to be conveyed or if the conveyor is to be subjected to internal or external pressure, manufacturer should be consulted prior to any modifications.

CEMA insists that disconnecting and locking out the power to the motor driving the unit provides the only real protection against injury. Secondary safety devices are available; however, the decision as to their need and the type required must be made by the owner-assembler as we have no information regarding plant wiring, plant environment, the interlocking of the screw conveyor with other equipment, extent of plant automation, etc. Other devices should not be used as a substitute for locking out the power prior to removing guards or covers. We caution that use of the secondary devices may cause employees to develop a false sense of security and fail to lock out power before removing covers or guards. This could result in a serious injury should the secondary device fail or malfunction.

There are many kinds of electrical devices for interlocking of conveyors and conveyor systems such that if one conveyor in a system or process is stopped other equipment feeding it, or following it can also be automatically stopped.

Electrical controls, machinery guards, railings, walkways, arrangement of installation, training of personnel, etc., are necessary ingredients for a safe working place. It is the responsibility of the contractor, installer, owner and user to supplement the materials and services furnished with these necessary items to make the conveyor installation comply with the law and accepted standards.

Conveyor inlet and discharge openings are designed to connect to other equipment or machinery so that the flow of material into and out of the conveyor is completely enclosed.

One or more warning labels should be visible on conveyor housings, conveyor covers and elevator housings. If the labels attached to the equipment become illegible, please order replacement warning labels from the OEM or CEMA.

The Conveyor Equipment Manufacturers Association (CEMA) has produced an audio-visual presentation entitled "Safe Operation of Screw Conveyors, Drag Conveyors, and Bucket Elevators." CEMA encourages acquisition and use of this source of safety information to supplement your safety program.

ble as we have no information regarding plant wiring, plant environment, the interlocking of the screw conveyor with other equipment, extent of plant automation, etc. Other devices should not be used as a substitute for locking out the power prior to removing guards or covers. We caution that use of the secondary devices may cause employees to develop a false sense of security and fail to lock out power before removing covers or guards. This could result in a serious injury should the secondary device fail or malfunction.

There are many kinds of electrical devices for interlocking of conveyors and conveyor systems such that if one conveyor in a system or process is stopped other equipment feeding it, or following it can also be automatically stopped.

Electrical controls, machinery guards, railings, walkways, arrangement of installation, training of personnel, etc., are necessary ingredients for a safe working place. It is the responsibility of the contractor, installer, owner and user to supplement the materials and services furnished with these necessary items to make the conveyor installation comply with the law and accepted standards.

Conveyor inlet and discharge openings are designed to connect to other equipment or machinery so that the flow of material into and out of the conveyor is completely enclosed.

One or more warning labels should be visible on conveyor housings, conveyor covers and elevator housings. If the labels attached to the equipment become illegible, please order replacement warning labels from the OEM or CEMA.

The Conveyor Equipment Manufacturers Association (CEMA) has produced an audio-visual presentation entitled "Safe Operation of Screw Conveyors, Drag Conveyors, and Bucket Elevators." CEMA encourages acquisition and use of this source of safety information to supplement your safety program.

CONVEYORS



PROMINENTLY DISPLAY THESE SAFETY LABELS ON INSTALLED EQUIPMENT

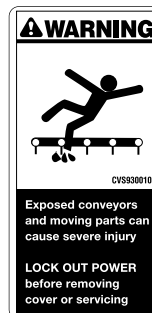

NOTICE: This document is provided by CEMA as a service to the industry in the interest of promoting safety. It is advisory only and it is not a substitute for a thorough safety program. Users should consult with qualified engineers and other safety professionals. CEMA makes no representations or warranties, either expressed or implied, and the users of this document assume full responsibility for the safe design and operation of equipment.

Martin Screw Elevators

For over fifty years, *Martin* Standard Screw Elevators have been successfully elevating a wide range of materials. In 1956, we added the heavier duty Superscrew Elevator, giving our customers the ability to elevate larger capacities to greater heights.

The *Martin* Screw Elevator is ideally suited to elevate a wide range of bulk materials in a relatively small space. If a material can be classified as very free flowing or free flowing, it can probably be elevated in a Screw Elevator.

We offer both our Standard and Superscrew Elevators with several different drive arrangements to meet our customers' individual requirements. *Martin* has an experienced staff in over twenty locations throughout the U.S.A. and Canada that can help you design the right screw elevator for your application. We have the capability of manufacturing our screw elevators in six locations in the U.S.A.

Contact your nearest *Martin* facility with your application information and we will design the right elevator for your needs.

Partial Material List

Alfalfa Meal	Mixed Feeds
Barley, Malted	Mustard Seed
Bone Meal	Oats
Cement	Paper Pulp
Coffee	Peanuts
Corn Meal	Resin
Cotton Seed	Rubber, Ground
Cryolite	Salt
Flours	Sawdust
Grains	Screened Wood Chips
Hops	Shellac, Powder
Ice	Soda Ash
Kaolin Clay	Soybean Meal
Lead Oxide	Sugar
Lime	Sunflower Seeds
Malt	Tobacco
Mica	Wheat
Milk, Dried	Wood Flour

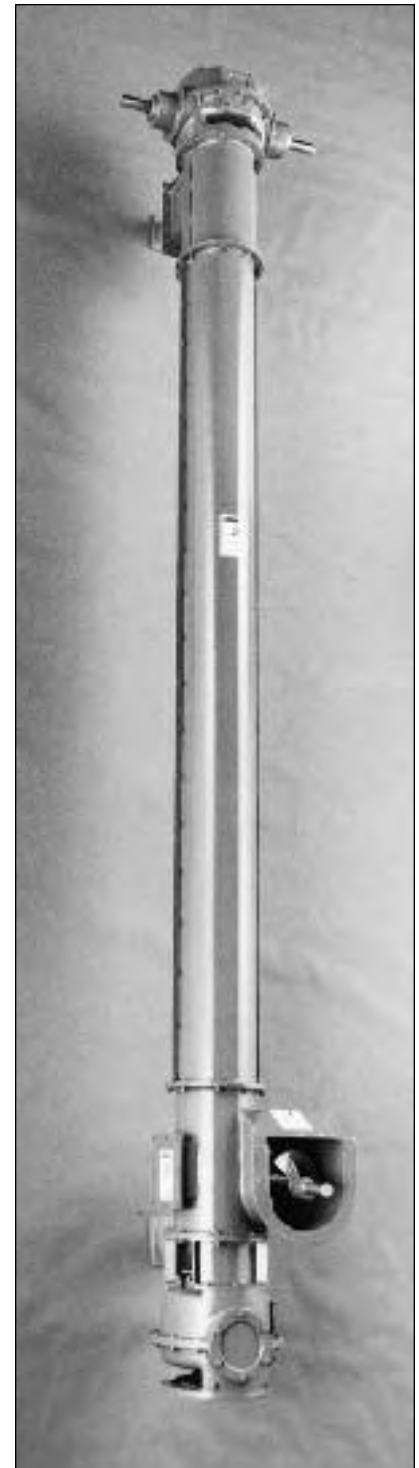

Type 4
Superscrew Elevator

Martin Screw Elevators

To help better meet the needs of our customers, we offer both the *Martin* Standard and Superscrew Elevators in sixteen different types. The different types allow us to vary the drive location, discharge location and feed arrangement. We are also able to drive the feeder or take-away conveyor by the screw elevator drive.

The *Martin* Screw Elevators are easy to install because they are factory assembled, match-marked and disassembled prior to shipment. All *Martin* Screw Elevators are of a sturdy self-supporting design and only need lateral support when installed.

The drives for the *Martin* Standard and Superscrew Elevators are manufactured by *Martin* and are specifically designed for use with our screw elevators. We can also offer a Screw Conveyor Drive arrangement for lighter duty applications.

Standard Screw Elevator Types



Type B
Straight Inlet
Top Drive,
Pedestal Base



Type BO
Offset Inlet
Top Drive,
Pedestal Base



Type AF1
Straight Inlet Top
Drive, Bottom P.T.O.
w/4'-0" Feeder
And Drive

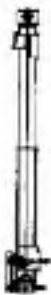

Type AF2
Offset Inlet
Top Drive,
Bottom P.T.O.
With Drive



Type EAF1
Straight Inlet
Bottom Drive,
Thrust Head



Type HAF2
Offset Inlet
Bottom Drive,
Thrust Head
With Drive



Type GAF1
Straight Inlet
Bottom Drive,
Thrust Head w/4'-0"
Feeder And Drive



Type IAF-2
Offset Inlet
Bottom Drive,
Thrust Head

SuperScrew Elevator Types



Type 1
Straight Inlet
Top Drive,
Pedestal Base



Type 2
Offset Inlet
Top Drive,
Pedestal Base



Type 3
Straight Inlet Top
Drive, Bottom P.T.O.
w/4'-0" Feeder
And Drive

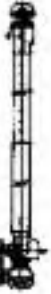

Type 4
Offset Inlet
Top Drive,
Bottom P.T.O.
With Drive



Type 5
Straight Inlet
Bottom Drive,
Thrust Head



Type 6
Offset Inlet
Bottom Drive,
Thrust Head



Type 7
Straight Inlet
Bottom Drive,
Thrust Head w/4'-0"
Feeder And Drive

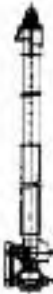

Type 8
Offset Inlet
Bottom Drive,
Thrust Head
With Drive

NOTE: All elevators are furnished less feeder and/or feeder drive unless otherwise specified.

CAUTION: Never operate without covers and guards. Always LOCKOUT/TAGOUT electrical power when working on equipment for inspection, cleaning, maintenance, or other purposes.



Standard Screw Thrust Unit



Stabilizer Bearing Used on Standard Screw Elevator



Standard Screw Pedestal Base



Standard Screw Thrust Head

All *Martin* Screw Elevators come with heavy duty helicoid or sectional screws which are checked for straightness and run-out to insure a smooth running elevator. When handling free flowing material, we add stabilizers as needed, as the height of the elevator increases. The stabilizer bearings are available in a wide range of bearing materials to meet our customers' requirements, including wood, hard iron, bronze, UHMW, and others.

Both the *Martin* Standard Screw and Superscrew Elevators are supplied with split intermediate housing to allow easier maintenance.

Martin's specially engineered inlet/bottom section assures a smooth transfer to conveyed material from the horizontal to vertical with a minimum of back-up and product degradation.

The bottom inspection panel is bolted to minimize any product leakage. It also has a shroud to assure that the conveyed material is moving smoothly through the area.

The drives for both the Standard Screw and the Superscrew Elevator are manufactured by *Martin* to guarantee their quality and availability.

Clearance Between Screw and Housing

Size	Type of Housing	Clearance	Standard Elevator			Superscrew Elevator		
			Intermediate Housings	Top and Bottom Sections	Screw	Intermediate Housings	Top and Bottom Sections	Screw
6	Standard Clearance	1/2	14	14	6H304 6.55312	14	10	6H304 6.55312
	Close Fitting Clearance	5/16	14	14		14	10	
9	Standard Clearance	1/2	12	12	9H306 9.55312	12	3/16	9H306 9.55312
	Close Fitting Clearance	5/16	12	12		12	3/16	
12	Standard Clearance	1/2	10	10	12H408 12.55412	10	3/16	12H408 12.55412
	Close Fitting Clearance	5/16	10	10		10	3/16	
14	Standard Clearance	1/2				10	3/16	16H610 16.55612
	Close Fitting Clearance	5/16				10	3/16	

Standard Screw Elevator



The *Martin* Standard Screw Elevator is designed to handle under normal conditions, capacities ranging from 360 CFH to 3600 CFH in 6" dia., 9" dia., and 12" dia. sizes. With complete information, *Martin* engineering staff can help you design the right Screw Elevator for your application.

Martin Standard Screw Elevator Speed / Capacity

Size	Vertical Shaft Diameter	Ratio Top Drive	Ratio Bottom Drive	▲ Recommended Minimum and Maximum Speeds			RPM Horizontal Feeder Screw 45 Percent Loading	Capacity Cubic Foot per Hour
				Vertical Screw	Input Top Drive	Input Bottom Drive		
6	1½	2:1	1.4:1	200	400	280	165	360
				215	430	301	177	400
				275	550	385	226	500
9	1½	2:1	1.4:1	170	340	238	139	1100
				200	400	280	163	1300
				230	460	322	187	1500
12	2	2:1	2:1	155	310	310	147	2700
				165	330	330	156	3000
				200	400	400	189	3600

▲ For speeds in excess or less than shown, consult *Martin*.

The Standard Screw Elevator drive unit will function efficiently with the elevator erected at any angle of incline from horizontal to vertical. The input shaft can be driven in either direction, and the input shaft extension may be used to drive a horizontal feeder or discharge conveyor.

Both top and bottom drives are required when the elevator, feeder and discharge conveyor are all driven from one power source. A top drive and pedestal base are used when the elevator and discharge conveyor are driven from one source. A bottom drive and thrust unit are necessary if the elevator and feeder are driven from one power source. The drives are designed and constructed to withstand all radial and thrust loads and support the entire weight of a fully loaded elevator.

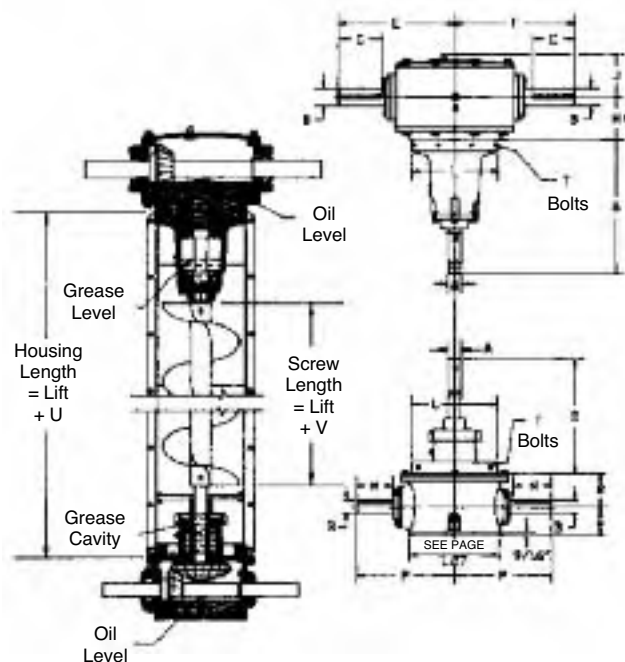

Dimensions in Inches

Size	Ratio		A	B		C	E	F	G	H	J	L	M	N	P	Q	R	S	T Bolts		U		V
	Top Drive	Bottom Drive		Top Drive	Bottom Drive														No. Rec'd	Size	B & BO	All Other Types	All Types
6*	2:1	1.4:1	1½	2	1½	5	13½	14	15¼	7%	4 ¹⁵ / ₁₆	7	4¼	4½	11 ¹¹ / ₃₂	3%	3 ³ / ₁₆	13¾	4	¾-16 NC	16%	23%	6%
9	2:1	1.4:1	1½	2	1½	5	13½	14	15¼	5	4 ¹⁵ / ₁₆	10	4¼	4½	11 ¹¹ / ₃₂	3%	3 ³ / ₁₆	13¾	8	¾-16 NC	21½	27%	8%
12	2:1	2:1	2	2	2	5	13½	14	15¼	4%	4 ¹⁵ / ₁₆	13	5	5 ¹ / ₁₆	14 ¹ / ₁₆	3%	4 ¹ / ₁₆	13¾	8	½-13 NC	26	31%	12%

*2½" lg. adapter for 6" head not illustrated

CAUTION: Never operate without covers and guards. Always LOCKOUT/TAGOUT electrical power when working on equipment for inspection, cleaning, maintenance, or other purposes.

Note: Dimensions not certified for construction.

Type B

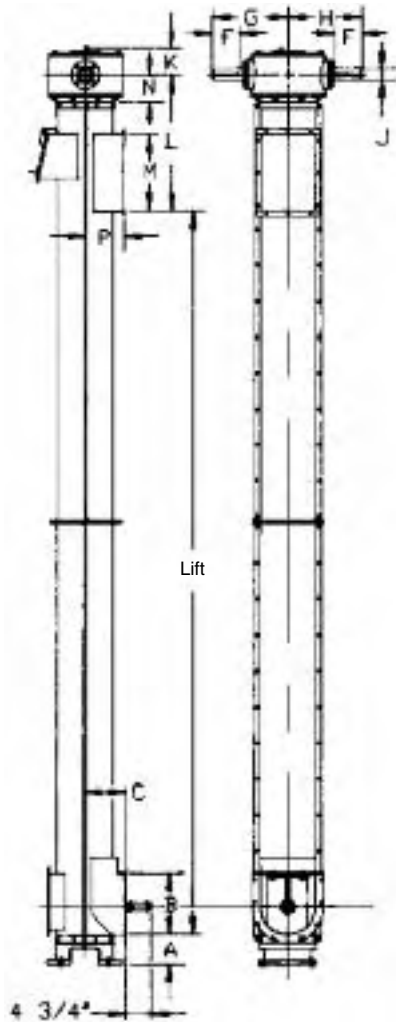

Type B0

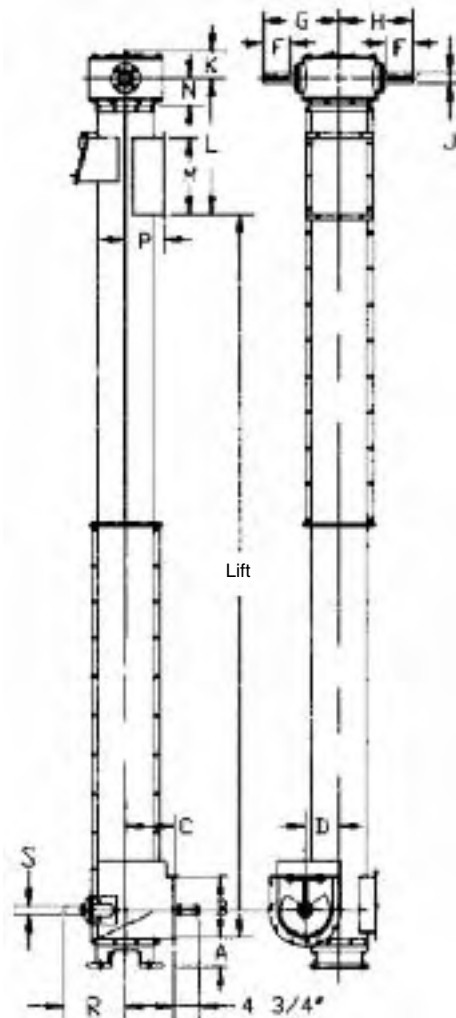

Screw elevator shown is offset to right for illustration purpose only. This elevator will normally be furnished offset to left, unless otherwise specified. See page H-158 for typical elevator arrangements.

Type B0

Size of Elevator	A	B	C	D	F	G	H	J	K	L	M	N	P	R	S
6	6	8	9	4 $\frac{3}{4}$	5	13 $\frac{1}{2}$	14	2	4 $\frac{15}{16}$	23	12	7 $\frac{7}{8}$	5 $\frac{1}{2}$	11 $\frac{1}{8}$	1 $\frac{1}{2}$
9	5 $\frac{1}{2}$	11 $\frac{1}{8}$	9	6 $\frac{1}{4}$	5	13 $\frac{1}{2}$	14	2	4 $\frac{15}{16}$	25	14	5	7 $\frac{7}{8}$	11 $\frac{1}{8}$	1 $\frac{1}{2}$
12	8	14 $\frac{1}{4}$	15	8	5	13 $\frac{1}{2}$	14	2	4 $\frac{15}{16}$	29	18	4 $\frac{7}{8}$	8 $\frac{3}{4}$	14 $\frac{1}{16}$	2

Type B

Size of Elevator	A	B	C	F	G	H	J	K	L	M	N	P
6	6	8	9	5	13 $\frac{1}{2}$	14	2	4 $\frac{15}{16}$	23	12	7 $\frac{7}{8}$	5 $\frac{1}{2}$
9	5 $\frac{1}{2}$	11 $\frac{1}{8}$	9	5	13 $\frac{1}{2}$	14	2	4 $\frac{15}{16}$	25	14	5	7 $\frac{7}{8}$
12	8	14 $\frac{1}{4}$	15	5	13 $\frac{1}{2}$	14	2	4 $\frac{15}{16}$	29	18	4 $\frac{7}{8}$	8 $\frac{3}{4}$

Dimensions in Inches

Note: Dimensions not certified for construction.

Super Screw Elevator



The *Martin* Superscrew Elevator is designed to handle capacities ranging from 360 CFH to 7000 CFH in 6" dia., 9" dia., 12" dia., and 16" dia. sizes.

Martin SuperScrew Elevator Speed / Capacity

Size	Vertical Shaft Diameter	Ratio Top Drive	Ratio Bottom Drive	▲ Recommended Minimum and Maximum Speeds			RPM Horizontal Feeder Screw 45 Percent Loading	Capacity Cubic Foot per Hour	
				Vertical Screw	Input Top Drive	Input Bottom Drive			
1	2	3	4	5	6	7	8	9	
6	1½	2:1	2:1	200	400	400	165	360	
				215	430	430	177	400	
				275	550	550	226	500	
				330	660	660	272	600	
				Up to 425	Up to 850	Up to 850	★	★	
9	2	2:1	2:1	170	340	340	139	1100	
				200	400	400	163	1300	
				230	460	460	187	1500	
				240	480	480	196	1600	
				Up to 425	Up to 850	Up to 850	★	★	
12	2⅞	2:1	2:1	155	310	310	147	2800	
				165	330	330	156	3000	
				200	400	400	189	3600	
				210	420	420	199	3800	
				Up to 425	Up to 850	Up to 850	★	★	
	2⅞★ 3	2.06:1	2.06:1	2.06:1	155	319	319	151	2800
					165	340	340	161	3000
					200	412	412	195	3600
					210	433	433	205	3800
					Up to 425	Up to 876	Up to 876	★	★
16	3	2.06:1	2.06:1	138	284	284	132	6000	
				150	309	309	144	6500	
				161	332	332	155	7000	
				Up to 425	Up to 876	Up to 876	★	★	

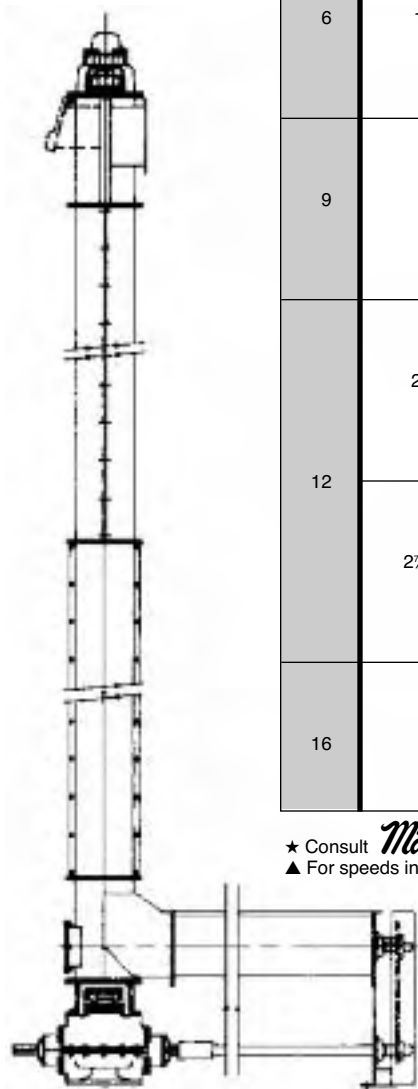

Type 7 Superscrew Elevator

★ Consult *Martin*.
▲ For speeds in excess or less than those shown, consult *Martin*.



CAUTION: Never operate without covers and guards. Always LOCKOUT/TAGOUT electrical power when working on equipment for inspection, cleaning, maintenance, or other purposes.

Super Screw Elevator D.S.D. (Dry Shaft Drive)

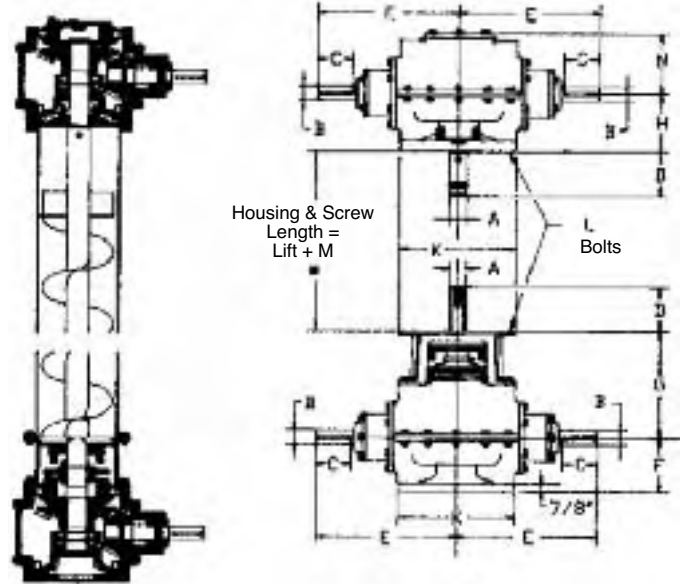

DSD (Dry Shaft Drive) is a completely new design and construction concept especially developed to enable the SuperScrew Elevator to broaden the application of screw elevators.

The DSD unit is designed to meet special conditions encountered in vertical installations and may be installed in the range of 70° to 90° incline. If a smaller angle of incline is required, special units may be furnished.

A patented lubrication system precisely “meters” the proper amount of lubricant to those points where needed with no danger of damaging seals.

DSD units may be furnished at both the top and the bottom of the elevator. The top drive incorporates special design features to assure that no lubricant may pass into the elevator to contaminate the material being elevated. In the bottom drive unit other special features prevent entrance of foreign material into lubricant.

DSD units may also be furnished at the top only with a pedestal base or at the bottom only with a thrust head.

The compactness of the DSD requires a minimum of head room providing maximum lift with minimum overall elevator height.

DSD units are sturdily constructed to withstand all radial and thrust loads encountered and to support the entire weight of elevators and materials handled.

Size	Ratio	A	B	C	D		E	F	G	H	K	L		M
					Top	Bottom						No.	Size	
6	2:1	1½	1⅝	4	4¾	5	16	6⅝	12	7½	10⅝	8	¾	12¼
9	2:1	2	1⅝	4	4¾	5	16	6⅝	12	7½	13¼	8	¾	13¼
12	2:1	2⅞	1⅝	4	4¾	5	16	6⅝	12	7½	16¼	8	½	18¼
	2.06:1	2⅞	1⅝	4¼	4¾	5	18.1	6⅝	12⅝	7¼	17¼	8	½	18¼
	2.06:1	3	2⅞	4¼	5	5	18.1	6⅝	12⅝	7¼	17⅝	8	½	18¼
16	2.06:1	3	2⅞	4¼	5	5	18.1	6⅝	12⅝	7¼	20¼	12	½	24¼



Spider Type Stabilizer
Used on SuperScrew



SuperScrew
Thrust Head



SuperScrew
Pedestal Base

Super Screw Elevator Dimensions



Type 1

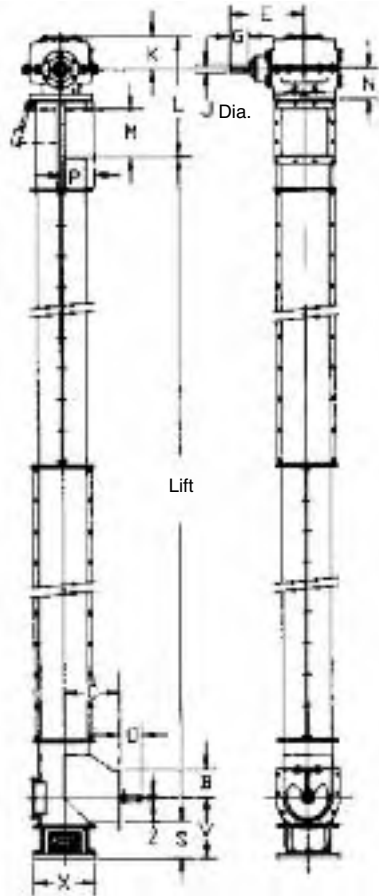

Type 2

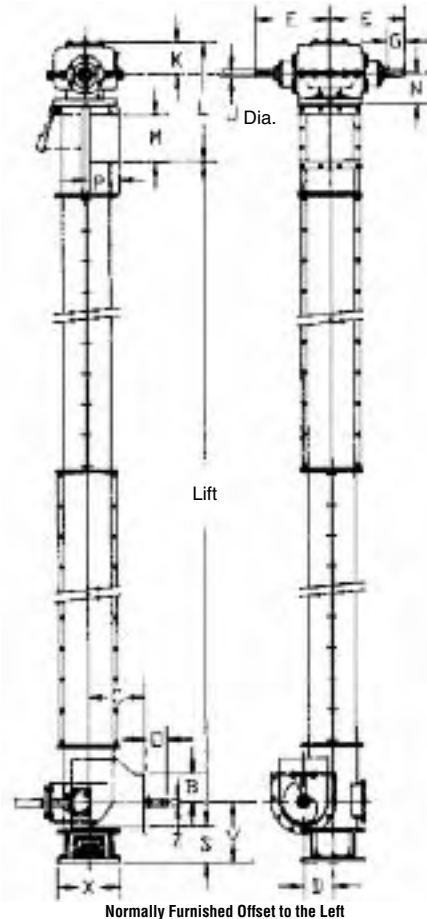

CONVEYORS

Type 1

Size of Elevator	Vert. Shaft Dia.	Ratio	B	C	E	G	J	K	L	M	N	O	P	S	V	X	Z ◇
6	1½	2:1	4½	10½	16	4	1⅝	6¾	26¾	7	6½	4¾	5	8⅝	11⅝	13¾	1½
9	2	2:1	6⅝	12	16	4	1⅝	6¾	28¾	10	6½	4¾	7⅞	7⅞	12⅞	13¾	1½
12	2⅞	2:1	7¾	15	16	4	1⅝	6¾	32¼	13	6½	4¾	8⅞	8⅞	15⅞	13¾	2
	○ 2⅞	2.06:1	7¾	15	18.1	4¼	2⅞	7⅞	34¾	13	7¼	4¾	8⅞	9	15½	17⅞	2
	3	2.06:1	7¾	15	18.1	4¼	2⅞	7⅞	34¾	13	7¼	4¾	8⅞	9	15½	17⅞	2
16	3	2.06:1	10⅞	20	18.1	4¼	2⅞	7⅞	39⅞	17	7¼	5	11⅞	9½	18	17⅞	3

Type 2

Size of Elevator	Vert. Shaft Dia.	Ratio	B	C	D	E	G	J	K	L	M	N	O	P	S	V	X	Z ◇
6	1½	2:1	4½	10½	4¾	16	4	1⅝	6¾	23¾	7	6½	4¾	5	8⅝	11⅝	13¾	1½
9	2	2:1	6⅝	12	6¾	16	4	1⅝	6¾	25¾	10	6½	4¾	7⅞	7⅞	12⅞	13¾	1½
12	2⅞	2:1	7¾	15	8	16	4	1⅝	6¾	29¾	13	6½	4¾	8⅞	8⅞	15⅞	13¾	2
	○ 2⅞	2.06:1	7¾	15	8	18.1	4¼	2⅞	7⅞	31⅞	13	7¼	4¾	8⅞	9	15½	17⅞	2
	3	2.06:1	7¾	15	8	18.1	4¼	2⅞	7⅞	31⅞	13	7¼	4¾	8⅞	9	15½	17⅞	2
16	3	2.06:1	10⅞	20	10½	18.1	4¼	2⅞	7⅞	36¾	17	7¼	5	11⅞	9½	18	17⅞	3

Dimensions in Inches

- ◇ Horizontal coupling diameter may vary upon length of feeder.
- Consult *Martin* before using.

CAUTION: Never operate without covers and guards. Always LOCKOUT/TAGOUT electrical power when working on equipment for inspection, cleaning, maintenance, or other purposes.

SECTION IX

MODULAR PLASTIC SCREW SECTION IX

Introduction	H-165
Warning and Safety Reminder	H-166
Technical and Design Data	H-167

Another *Martin* patented Innovation. We'll give your customers another reason to give you their business.



- Plastic modules consist of a helical flight spiraling once around a hollow square hub.
- Eliminates need to spot or continuously weld metal flights to shaft.
- Polyurethane - used where impact/abrasive wear is a problem. Lab tests show it up to 3 times more wear resistant than carbon or stainless steel in certain applications.
- All-plastic material does not corrode, is impervious to acids, caustics and other chemicals.
- Durable, lightweight injection-molded modules stack on square tube.
- Polypropylene - general purpose material for high temperature service.
- FDA approved for food contact.
- Highly resistant to corrosion.
- Modules are individually replaceable without welding or burning.
- Assembled conveyor is comparatively lightweight, easier to handle, and bearing life is prolonged.
- Polyethylene - general purpose material. FDA approved for food contact.
- Good abrasive and excellent corrosion resistance in a wide temperature range.
- Slick surface simplifies cleaning.

Warning & Safety Reminder

WARNING & SAFETY REMINDER

Safety must be considered a basic factor in machinery operation at all time. *Most accidents are the results of carelessness or negligence.*

All rotating power transmission products are potentially dangerous and must be guarded by the contractor, installer, purchaser, owner, and user as required by applicable laws, regulations, standards, and good safety practice.

Additionally specific information must be obtained from other sources including the latest editions of American Society of Mechanical Engineers; (ANSI) Safety Code. A copy of this

standard may be obtained from the American Society of Mechanical Engineers at 345 East 47th Street, New York, NY 10017 (212-705-7722).

It is the responsibility of the contractor, installer, purchaser, owner, and user to install, maintain, and operate the parts or components manufactured and supplied by *Martin* Sprocket & Gear, Inc., in such a manner as to comply with the Williams-Steiger Occupational Safety Act and with all state and local laws, ordinances, regulations, and the American National Standard Institute Safety Code.

CAUTION

Guards, access doors, and covers must be securely fastened before operating any equipment.

If parts are to be inspected, cleaned, observed, or general maintenance performed, **the motor driving the part or components is to be locked out electrically in such a manner that it cannot be started by anyone**, however remote from the area. Failure to follow these instructions may result in personal injury or property damage.

WARNING

Warning: Static Electricity

Static Electricity may accumulate on modular plastic conveyor screws which carry non-conductive materials and may produce an electrical spark. **Do Not Use to Convey Non-Conductive Materials in a Combustible Environment.**

Martin Solutions to Screw Conveyor Problems

- Currently available in 6", 9" and 12" diameters, in right hand only.
- Assembled conveyors compatible with CEMA standards; easily retro-fitted.
- Flight modules available in polyethylene, polypropylene, and polyurethane, each with characteristics to fill specific needs (see Technical Data).
- Flights and hubs are integrally molded, resulting in consistent diameter, pitch and thickness with a uniform, smooth finish.
- Plastic modules eliminate metal contamination to food.
- Assembled conveyor is light in weight, is safe and easy to handle; bearing life is prolonged.
- Plastic flights may operate at close clearances, or when conveying many materials, directly on the trough without danger of metal contamination.
- Modules are individually replaceable.
- Balance is excellent allowing high speed operation.

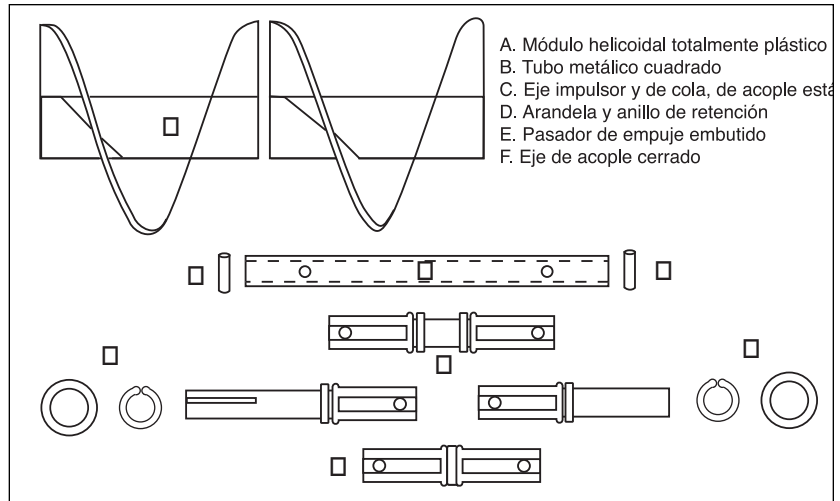

The *Martin* Screw Conveyor System consists of plastic modules stacked on a square metal tube. A shaft is inserted at each tube end and secured by a recessed pin. Modules are secured at tube ends by retainer rings and washers.

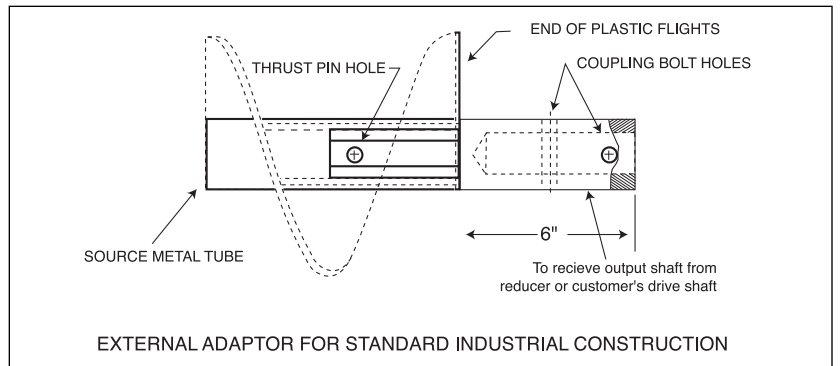

MOUNTED SCREW CONVEYOR

END CONSTRUCTION

DRIVE OR TAIL | SPECIFIED LENGTH
 SHAFT EXTENSION | PLASTIC MODULE | SQUARE METAL TUBE
 RETAINING RING | WASHER | INTERIOR THRUST PIN
 SQUARE PORTION OF SHAFT

DIAMETER	AVAILABLE SHAFTS		WEIGHT PER FOOT	
	FULL PITCH	SHORT PITCH	FULL PITCH	SHORT PITCH
6"	1-1/2", 2"		4.1 lb	4.3 lb
9"	1-1/2", 2"		4.5 lb	5.2 lb
12"	2", 2-7/16"		8.0 lb	9.5 lb
14"	NOT CURRENTLY AVAILABLE			
16"	NOT CURRENTLY AVAILABLE			

Weights shown as for polyethylene or polypropylene on stainless steel tube, polyurethane approximately 10% heavier.

DIAMETER	FULL PITCH	SHORT PITCH	FLIGHT THICKNESS	OUTSIDE HUB	INSIDE HUB
6"	9.05"	4.53"	.25"	2.51"	2.03"
9"	9.05"	4.53"	.25"	2.51"	2.03"
12"	11.72"	5.86"	.34"	3.17"	2.53"
14"	NOT CURRENTLY AVAILABLE				
16"	NOT CURRENTLY AVAILABLE				

FLIGHT HUB
FLIGHT THICKNESS MODULES

CONVEYORS

Technical & Design Data



Screw Conveyor Capacities

CUBIC FEET PER HOUR PER R.P.M. FULL PITCH HORIZONTAL				
DIAMETER	PITCH	CONVEYOR LOAD		
		FULL	45%	30%
6"	9"	5.72	2.75	1.72
9"	9"	16.73	7.53	5.02
12"	12"	39.27	17.67	11.78
14"	14"	NOT CURRENTLY AVAILABLE		
16"	16"	NOT CURRENTLY AVAILABLE		

Maximum Recommended Conveyor Speed / Horizontal Operation / R.P.M.

DIA.	SHAFT	TYPE OF INTERMEDIATE BEARING	
		WOOD, NYLATRON, BRONZE	CLOSE COUPLED*
6"	1-1/2"	165	90
9"	1-1/2"	165	80
9"	2"	150	80
12"	2"	145	70
12"	2-7/16"	140	70
14"	2-7/16"	NOT CURRENTLY AVAILABLE	
14"	3"	NOT CURRENTLY AVAILABLE	
16"	3"	NOT CURRENTLY AVAILABLE	

* Close coupled limitations apply to screw lengths over 12 ft. (for 6" and 9" dia.) or 15 ft. (for 12" dia). For longer lengths or units without intermediate bearing supports, locate end bearing no more than 3-1/8" (for 6" size); 4-5/8" (for 9" size); or 6-1/8" (for 12" size); centers above the inside bottom of the conveyor trough.

Horsepower Ratings

DIA.	SHAFT	RATINGS FOR CARBON STEEL SHAFT AND TUBE			
		50 R.P.M.	75 R.P.M.	100 R.P.M.	150 R.P.M.
6"-9"	1-1/2"	3.4	5.1	6.8	10.1
6"-9"	2"	5.6	8.4	11.2	16.8
12"	2"	8.0	12.0	16.0	24.0
12"	2-7/16"	9.1	13.6	18.2	27.3
14"	2-7/16"	NOT CURRENTLY AVAILABLE			
14"	3"	NOT CURRENTLY AVAILABLE			
16"	3"	NOT CURRENTLY AVAILABLE			

NOTE: The above limitations are based on *Martin* modular plastic construction throughout. The use of coupling bolts, as required for an external adaptor, may reduce horsepower capacity.

Materials of Construction

	POLYETHYLENE	POLYPROPYLENE	POLYURETHANE
FDA Approved	Yes	Yes	No
Abrasive Resistance	Good	Fair	Excellent
Corrosive Resistance	Excellent	Excellent	Good
Impact Resistance	Good	Fair	Excellent
Temperature Limit	-60° to +150° F	+40° to +220° F	-20° to +150°
Release	Excellent	Good	Good

Note: Release pertains to the capability of conveying "sticky" products.

Design Data for Bonded Construction

Bonded Construction is used in the handling of a finished food product or for the conveying of any product in which it is necessary to guard against material entering the internal clearances between the modules or into the inside of the square tube.

The hubs of the individual modules are heat fused together, the ends of the flights may be fused or may be cut to create a "clean out" gap,

usually 1/8" to 1/4" wide. The ends are capped and fitted with an "O" ring to seal around the shaft. The cap may be of alternate construction as detailed below.

Bonded Construction has USDA acceptance for use as a component part of food processing equipment in federally inspected meat and poultry processing plants.

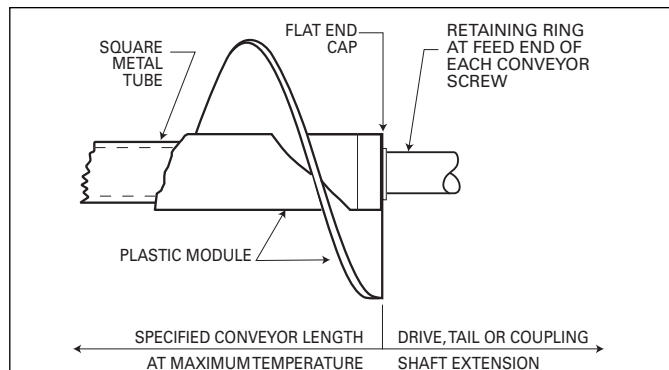

FLAT END CAPS

Flat End Caps are the basic construction for conveying finished food products. Drive and Tail End Shafts are shipped factory installed. If used with coupling shafts, the thrust bearing must be at the feed end of the conveyor assembly. Retaining ring may be eliminated in some applications depending upon length and temperature involved.

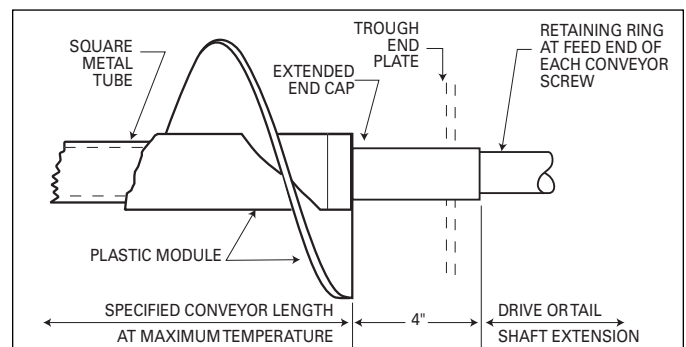

EXTENDED END CAPS

Extended End Caps are used in the handling of products which require a total elimination of cracks and crevices on the conveyor screw. This precludes the use of coupling shafts and therefore limits the unit to one conveyor length, a maximum of 20 feet. Retainer rings and shafts are entirely outside the product area. Drive and Tail End Shafts are shipped factory installed.

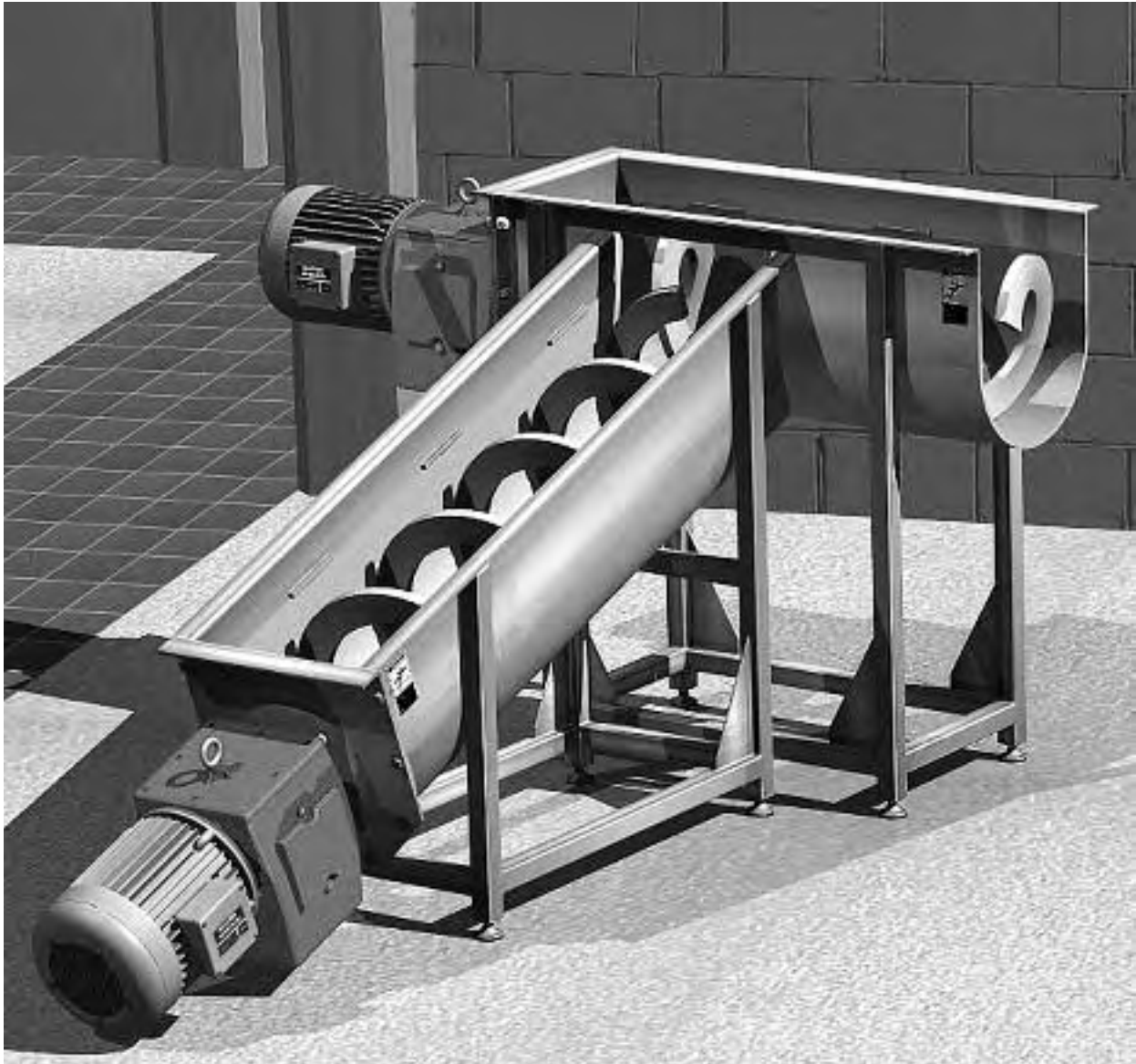

CONVEYORS

SECTION X

SHAFTLESS SCREW CONVEYORS SECTION X

Typical Applications	H-170
Feature- Function & Benefit	H-170
Warning and Safety Reminder	H-171
Size and Capacity	H-172

*Conveyors shown without cover for illustration purposes only. Please follow manufacturing safety guidelines when operating conveyors.

Shaftless Screw Conveyors



Typical Applications

- **Rendering**
 - Poultry Processing • Meat Processing • Fish Processing
 - Chicken Feathers • Whole Carcasses • Animal Waste • Fish/Animal Bones
- **Pulp & Paper, Gypsum Board, Particle Board**
 - Lime Mud • Oversized Wood Chips • Hogged Bark • Shavings
- **Agriculture**
 - Fertilizer • Corn Gluten • Sugar Beets/Cane Processing • Chopped Hay
- **Hospital Waste Processing, Recycle Plants**
 - Shredded Cans • Bottles • Paper • Medical Disposables
- **Wine & Beverage Industries**
 - Grape Skins • Stems • Pumice • Fruit Peels
- **Waste Water • Solid Waste Treatment**
 - Sludge • Grit • Screenings • Solids Removal
- **Chemical & Heavy Industrial**
 - Ash • Recycle Batteries • Shredded Tires

CONVEYORS

FEATURE	FUNCTION	BENEFIT
Continuous Flight	Eliminate Hangers	Reduces Maintenance Costs
3/4"-1" Flight	Long Lasting	Increases Uptime
No Tail Seals or Tail Bearings	Use Blind End Plate	Reduces Maintenance Costs
Cold Formed Flight	High Brinell	Longer Life
No Center Pipe Required	Eliminate Buildup On Pipe	Lower Maintenance/ Operation Costs
	Can Handle Particle Sizes Up To 90% Of Spiral O.D.	
	Allows Higher Trough Loading (45%-95%)	Increases Screw Capacity
Side Inlet Feeding	No Vertical Transition Necessary	Lower Installation Cost Reduces Headroom

Specifications:

Type of Steel	Carbon Steel • High Brinell Carbon Steel • Stainless Steel
Capacity	Up to 17,000 CFH
Diameter	6" to 30" (and Larger)
Pitches	Full, 2/3, 1/2
Trough	CEMA Standards
Options	UHMW Liners, AR Liners, Rider Bars, Drive End Seals
Advantages	Spanning longer distances without intermediate bearings. Transport sticky products and large lumps.

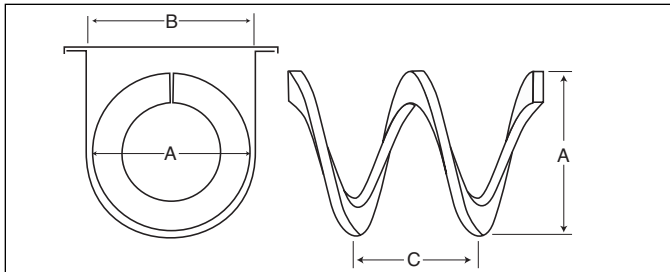

45% Trough Loading

NOM. DIA.	A Dia.	B Inside	C Pitch	CFH* Full Pitch	CFH* 2/3 Pitch	CFH* 1/2 Pitch	MAX RPM
6	6	7	6	65	43	33	25
9	9	10	9	224	149	112	25
10	10	11	10	307	205	154	25
12	12	13	12	530	353	265	25
14	14	15	14	842	561	421	25
16	16	17	16	1256	837	628	25
18	18	19	18	1789	1193	895	25
20	20	21	20	2455	1637	1228	25
24	24	25	24	4240	2827	2120	25
30	30	31	30	8283	5522	4142	25

95% Trough Loading

NOM. DIA.	A Dia.	B Inside	C Pitch	CFH* Full Pitch	CFH* 2/3 Pitch	CFH* 1/2 Pitch	MAX RPM
6	6	7	6	140	93	70	25
9	9	10	9	472	315	236	25
10	10	11	10	648	432	324	25
12	12	13	12	1119	746	560	25
14	14	15	14	1777	1185	889	25
16	16	17	16	2652	1766	1326	25
18	18	19	18	3776	2517	1888	25
20	20	21	20	5180	3453	2590	25
24	24	25	24	8950	5967	4475	25
30	30	31	30	17485	11657	8743	25

*CFH = Cubic Feet per hour. -** ALL DIMENSIONS SHOWN IN INCHES.

Warning & Safety Reminder



WARNING AND SAFETY REMINDERS FOR SCREW, DRAG, AND BUCKET ELEVATOR CONVEYORS

APPROVED FOR DISTRIBUTION BY THE SCREW CONVEYOR SECTION OF THE CONVEYOR EQUIPMENT MANUFACTURERS ASSOCIATION (CEMA)

It is the responsibility of the contractor, installer, owner and user to install, maintain and operate the conveyor, components and, conveyor assemblies in such a manner as to comply with the Williams-Steiger Occupational Safety and Health Act and with all state and local laws and ordinances and the American National Standards Institute (ANSI) B20.1 Safety Code.

In order to avoid an unsafe or hazardous condition, the assemblies or parts must be installed and operated in accordance with the following minimum provisions.

1. Conveyors shall not be operated unless all covers and/or guards for the conveyor and drive unit are in place. If the conveyor is to be opened for inspection cleaning, maintenance or observation, the electric power to the motor driving the conveyor must be LOCKED OUT in such a manner that the conveyor cannot be restarted by anyone; however remote from the area, until conveyor cover or guards and drive guards have been properly replaced.
2. If the conveyor must have an open housing as a condition of its use and application, the entire conveyor is then to be guarded by a railing or fence in accordance with ANSI standard B20.1. (Request current edition and addenda)
3. Feed openings for shovel, front loaders or other manual or mechanical equipment shall be constructed in such a way that the conveyor opening is covered by a grating. If the nature of the material is such that a grating cannot be used, then the exposed section of the conveyor is to be guarded by a railing or fence and there shall be a warning sign posted.
4. Do not attempt any maintenance or repairs of the conveyor until power has been LOCKED OUT.
5. Always operate conveyor in accordance with these instructions and those contained

on the caution labels affixed to the equipment.

6. Do not place hands, feet, or any part of your body, in the conveyor.
7. Never walk on conveyor covers, grating or guards.
8. Do not use conveyor for any purpose other than that for which it was intended.
9. Do not poke or prod material into the conveyor with a bar or stick inserted through the openings.
10. Keep area around conveyor drive and control station free of debris and obstacles.
11. Eliminate all sources of stored energy (materials or devices that could cause conveyor components to move without power applied) before opening the conveyor
12. Do not attempt to clear a jammed conveyor until power has been LOCKED OUT.
13. Do not attempt field modification of conveyor or components.
14. Conveyors are not normally manufactured or designed to handle materials that are hazardous to personnel. These materials which are hazardous include those that are explosive, flammable, toxic or otherwise dangerous to personnel. Conveyors may be designed to handle these materials. Conveyors are not manufactured or designed to comply with local, state or federal codes for unfired pressure vessels. If hazardous materials are to be conveyed or if the conveyor is to be subjected to internal or external pressure, manufacturer should be consulted prior to any modifications.

CEMA insists that disconnecting and locking out the power to the motor driving the unit provides the only real protection against injury. Secondary safety devices are available; however, the decision as to their need and the type required must be made by the owner-assembler as we have no information regarding plant wiring, plant environment, the interlocking of the screw conveyor with other equipment, extent of plant automation, etc. Other devices should not be used as a substitute for locking out the power prior to removing covers or covers. We caution that use of the secondary devices may cause employees to develop a false sense of security and fail to lock out power before removing covers or guards. This could result in a serious injury should the secondary device fail or malfunction.

There are many kinds of electrical devices for interlocking of conveyors and conveyor systems such that if one conveyor in a system or process is stopped other equipment feeding it, or following it can also be automatically stopped.

Electrical controls, machinery guards, railings, walkways, arrangement of installation, training of personnel, etc., are necessary ingredients for a safe working place. It is the responsibility of the contractor, installer, owner and user to supplement the materials and services furnished with these necessary items to make the conveyor installation comply with the law and accepted standards.

Conveyor inlet and discharge openings are designed to connect to other equipment or machinery so that the flow of material into and out of the conveyor is completely enclosed.

One or more warning labels should be visible on conveyor housings, conveyor covers and elevator housings. If the labels attached to the equipment become illegible, please order replacement warning labels from the OEM or CEMA.

The Conveyor Equipment Manufacturers Association (CEMA) has produced an audiovisual presentation entitled "Safe Operation of Screw Conveyors, Drag Conveyors, and Bucket Elevators." CEMA encourages acquisition and use of this source of safety information to supplement your safety program.

ble as we have no information regarding plant wiring, plant environment, the interlocking of the screw conveyor with other equipment, extent of plant automation, etc. Other devices should not be used as a substitute for locking out the power prior to removing covers or covers. We caution that use of the secondary devices may cause employees to develop a false sense of security and fail to lock out power before removing covers or guards. This could result in a serious injury should the secondary device fail or malfunction.

There are many kinds of electrical devices for interlocking of conveyors and conveyor systems such that if one conveyor in a system or process is stopped other equipment feeding it, or following it can also be automatically stopped.

Electrical controls, machinery guards, railings, walkways, arrangement of installation, training of personnel, etc., are necessary ingredients for a safe working place. It is the responsibility of the contractor, installer, owner and user to supplement the materials and services furnished with these necessary items to make the conveyor installation comply with the law and accepted standards.

Conveyor inlet and discharge openings are designed to connect to other equipment or machinery so that the flow of material into and out of the conveyor is completely enclosed.

One or more warning labels should be visible on conveyor housings, conveyor covers and elevator housings. If the labels attached to the equipment become illegible, please order replacement warning labels from the OEM or CEMA.

The Conveyor Equipment Manufacturers Association (CEMA) has produced an audiovisual presentation entitled "Safe Operation of Screw Conveyors, Drag Conveyors, and Bucket Elevators." CEMA encourages acquisition and use of this source of safety information to supplement your safety program.



PROMINENTLY DISPLAY THESE SAFETY LABELS ON INSTALLED EQUIPMENT

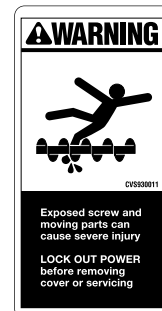
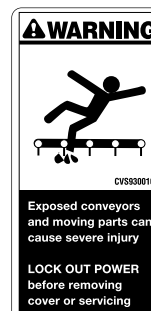

NOTICE: This document is provided by CEMA as a service to the industry in the interest of promoting safety. It is advisory only and it is not a substitute for a thorough safety program. Users should consult with qualified engineers and other safety professionals. CEMA makes no representations or warranties, either expressed or implied, and the users of this document assume full responsibility for the safe design and operation of equipment.



Vertical Screw Data Sheet

CUSTOMER: _____ DATE QUOTE DUE: _____

ADDRESS: _____

CONTACT: _____ PHONE # _____

VERTICAL SCREW: LIFT _____ DISCH. HEIGHT. _____

INLET CONFIGURATION		
(Indicate One):	<input type="checkbox"/>	<input type="checkbox"/>
Elevator Offset to Left	Straight Inlet	Elevator Offset to Right

CAPACITY: _____ (CFH) (LBS/HR) (TPH) (MTPH) (BPH)

MATERIAL: _____ DENSITY _____ LBS/FT³ TEMP _____ °F MOISTURE _____ %

LUMPS: MAX SIZE _____ IN LUMP CLASS: (Lump % of Total; I - 10%, II - 25%, III - 95%)

FED BY: _____ DISCHARGES TO: _____

MAT'L OF CONSTR: MILD STEEL T304 T316 H.D. GALV. OTHER

INSTALLATION: NEW REPLACEMENT INDOORS OUTDOORS

DRIVE: (DIRECT) (SCREW CONVEYOR DRIVE) (OTHER): _____ V-BELTS CHAIN GUARD

MOTOR: TEFC X-PROOF MAC OTHER _____ NOTES _____

NOTES: _____

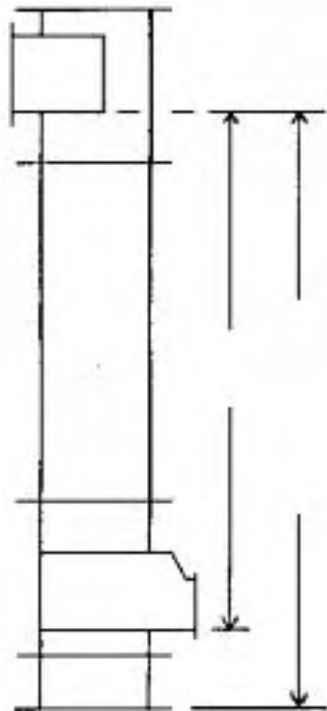

TROUGH: _____

SCREW: _____

SHAFT DIA: _____

HANGERS: _____

HRG. BRG.: _____

BOTTOM BRG.: _____

BOTTOM SEAL: _____

GASKETS: _____

DRIVE: _____ HP AT _____ RPM

REDUCER: _____

PAINT: _____

NOTES: _____

PAGE _____ OF _____ PREPARED BY _____ DATE _____

CONVEYORS

Screw Conveyor Data Sheet



CUSTOMER: _____ DATE PROPOSAL DUE: _____

ADDRESS: _____

CONTACT: _____ PHONE # _____

SCREW DESCR: ____ QTY: _____ " DIA. x _____ LONG (C INLET TO C DISCH.) (OVERALL) HORIZ. INCL. _____ ° DECL. _____ °

CAPACITY: _____ (CFH) (LBS/HR) (TPH) (MTPH) (BPH)

MATERIAL: _____ DENSITY _____ LBS/FT³ TEMP _____ °F MOISTURE _____ %

LUMPS: MAX SIZE _____ IN LUMP CLASS: (Lump % of Total; I - 10%, II - 25%, III - 95%)

INSTALLATION: INDOORS OUTDOORS NEW REPLACEMENT MAT'L OF CONSTR.: MILD STEEL T304 T316 HD GALV OTHER _____

IS IT? FEEDER CONVEYOR IS FEED? FLOOD LOAD UNIFORM

FED BY: _____ INLET SIZE: _____ DISCHARGES TO: _____

DRIVE: (SCREW CONVEYOR DRIVE) (SHAFT MOUNT) (OTHER): _____

NOTES: _____

TROUGH: STYLE _____ THK. _____ COUPL. BOLTS: _____

DISCHARGE: TYPE _____ QTY. _____ HANGER: STYLE _____

GATES: TYPE _____ QTY. _____ HANGER BRG.: TYPE _____

TROUGH END TYPE: TAIL _____ COVER: STYLE _____ THK. _____

TROUGH END TYPE: HEAD _____ COVER FASTENERS: TYPE _____

BEARING TYPE: TAIL _____ HEAD _____ INLETS: STYLE _____ QTY. _____

SEAL TYPE: TAIL _____ HEAD _____ GASKETS: TYPE _____ THK. _____

SCREW: DIA. _____ (RH) (LH) PITCH _____ THK. _____ DRIVE _____ HP AT _____ RPM

MOTOR: _____ MOTOR MOUNT _____

REDUCER: _____

V-BELT/CHAIN: _____

NOTES: _____

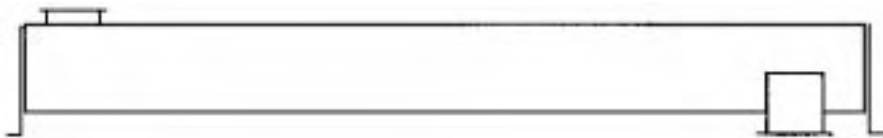

SKETCH — (SHOW FEEDER INLET SIZE AND LOCATION, DRIVE LOCATION, ETC.)

CONVEYORS



Sample Work Sheet

Client: _____ Date Quote Due: _____

Conveyor No.: _____ Inquiry No.: _____

Table 1-2

_____ Dia. x Length **L** = _____ Recommended % Trough Loading: _____

Material: _____ Material HP Factor: **F_M** = _____

Capacity: _____ Component Series: _____

Density: **W** = _____ Lbs/Ft³ Intermediate Hanger Bearing Series: _____

Lumps: Max. Size _____ in. Class (I) (II) (III) _____ Notes: _____

Required Capacity = **C** = _____ CFH (cubic feet per hour)

$$CFH = \frac{TPH \times 2000}{W}$$

CFH = Bushels per Hour x 1.24

$$CFH = \frac{\text{Pounds per Hour}}{W}$$

Tables 1-3, 1-4, 1-5

Equivalent Capacity = $\frac{\text{Req'd Capacity}}{CF_1} \times CF_2 \times CF_3$ = _____ CFH

Equivalent Capacity

Table 1-6

Screw Diameter = _____ Select Diameter from 'at max RPM' column where capacity listed equals or exceeds equivalent capacity

Screw RPM = **N** = _____ = $\frac{\text{Equivalent Capacity}}{\text{Capacity 'at one RPM' for diameter selected}}$

Table 1-7

Check lump size and lump class for diameter selected. If larger screw diameter recommended, recalculate RPM per instructions above for selected diameter.

Tables 1-12, 1-13, 1-14, 1-15, 1-16, 1-17

Values to be substituted in formula: **F_d** **F_b** **F_f** **F_p** **e**

$$HPf = \frac{L}{1,000,000} \left(\frac{N}{1,000} \right) \left(\frac{F_d}{1,000} \right) \left(\frac{F_b}{1,000} \right) = \underline{\hspace{2cm}}$$

NOTE: Consult factory for feeder horsepower

$$HPm = \frac{C}{1,000,000} \left(\frac{L}{1,000} \right) \left(\frac{W}{1,000} \right) \left(\frac{F_f}{1,000} \right) \left(\frac{F_m}{1,000} \right) \left(\frac{F_p}{1,000} \right) = \underline{\hspace{2cm}}$$

If HPf + HPm is less than 5.2, select overload factor **F_O** = _____ (If HPf + HPm is greater than 5.2, **F_O** = 1.0)

Total HP = $\frac{(HPf + HPm) F_o}{e}$ = _____ = _____

DRIVE: Use _____ HP motor with AGMA Class (I) (II) (III) Drive at _____ Screw RPM

Tables 1-18, 1-19

Torque = $\frac{\text{Motor HP} \times 63,025}{\text{Screw RPM}}$ = _____ in.-lbs.

List Minimum Size: Shaft Dia. _____ Pipe _____ Bolt/Shear _____ Bolt/Bearing _____

Tables 1-8, 1-9, 1-10, 1-11

Select Components:

Trough _____ Screw _____ Hanger Style _____ Hanger Bearing _____ Cover _____

CONVEYORS

Bucket Elevator Data Sheet



CUSTOMER: _____ DATE QUOTE DUE: _____

ADDRESS: _____

CONTACT: _____ PHONE # _____

BUCKET ELEVATOR: (CTRS/LIFT) _____ DESCR. _____

CAPACITY: _____ (CFH) (LBS/HR) (TPH) (MTPH) (BPH)

MATERIAL: _____ DENSITY _____ LBS/FT³ TEMP _____ °F MOISTURE _____ %

LUMPS: MAX SIZE _____ IN LUMP CLASS: (Lump % of Total; I - 10%, II - 25%, III - 95%)

FED BY: _____ DISCHARGES TO: _____

MAT'L OF CONSTR: MILD STEEL T304 T316 H.D. GALV. OTHER

INSTALLATION: NEW REPLACEMENT INDOORS OUTDOORS

DRIVE: (SHAFT MOUNT) (FOOT MOUNTED GEAR REDUCER) (OTHER): _____ V-BELTS CHAIN GUARD

MOTOR: TEFC X-PROOF MAC OTHER _____ BACKSTOP: SHAFT INTEGRAL TO REDUCER OTHER

NOTES: _____

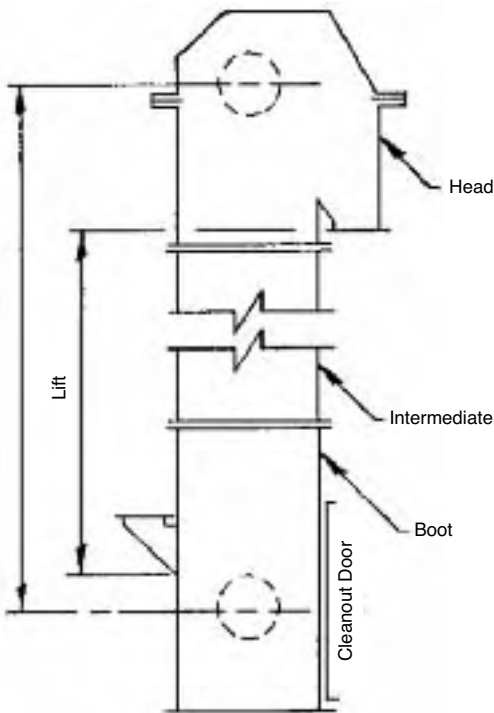

TYPE: CENTRIFUGAL CONTINUOUS GRAIN TYPE OTHER _____

CHAIN BELT SPECS. _____

DRIVE: _____ HP AT _____ RPM REDUCER _____

SPKTS/SHEAVES _____ CHAIN/V-BELTS _____

BACKSTOP _____

INLET: STANDARD SPECIAL _____

DISCHARGE: STANDARD 45°

SAFETY CAGE: YES NO LADDER: LGTH _____

HEAD PLATFORM: STANDARD SIZE SPECIAL _____

INT. PLATFORM STANDARD SIZE SPECIAL _____

THICKNESS: HEAD _____ BOOT _____ INT. _____

TAKEUP: HEAD BOOT SCREW GRAVITY

SEALS: STANDARD SPECIAL _____ VENTS: SIZE _____ QTY _____

PAINT: _____

CONVEYORS

PAGE _____ OF _____ PREPARED BY _____ DATE _____

BODY AND FENDER TOOLS	J-97 – J-104
“C” Clamps	J-96
Chisels and Punches	J-90 – J-91
Chisel and Punch Sets	J-89
Eye Bolts	J-96
HAMMERS	J-83 – J-86
Handles, Crank	J-95
Handles, Hammer, Wood	J-86
Manual of Body Repairs.....	J-102
Pipe Wrench.....	J-30
Pliers	J-92 – J-94
Pry Bars Rolling, HD	J-96
Screwdrivers	J-87 – J-88
SOCKETS, SETS & ATTACHMENTS.....	J-42 – J-82
1/4" Sq. Drive.....	J-44 – J-46
3/8" Sq. Drive.....	J-47 – J-59
1/2" Sq. Drive.....	J-60 – J-73
3/4" Sq. Drive.....	J-74 – J-77
1" Sq. Drive	J-78 – J-81
1 1/2" Sq. Drive.....	J-82
WRENCHES.....	J-14 – J-41
Adjustable	J-31
Auto Wrench Type, Adj.....	J-31
Box, Double Offset, Long.....	J-20 – J-21
Box, Double Offset, Short	J-20 – J-21
Box, Striking Face	J-37 – J-38
Offset, 12 Pt.	J-38
Straight, 6 Pt. & 12 Pt.....	J-37
Box, 12 Pt. Single End	J-36
Check Nut (Thin).....	J-26
Combination (Open-End and Box).....	J-14 – J-17
Construction.....	J-36
Flare Nut.....	J-27
Hex Keys	J-39
Hydraulic, (Angle) Open-End.....	J-22 – J-23
Mechanics Tool Sets	J-42 – J-43
Offset Socket	J-40
Open-End (Double Head).....	J-18 – J-19
Open-End Engineer’s (Single)	J-32
Pipe Wrench.....	J-30
Ratcheting Box.....	J-28 – J-29
Service, Straight Opening	J-24
Service, 30-Deg. Opening.....	J-24 – J-25
Set Screw	J-31
Spanner, Various Types	J-33 – J-34
Structural (Open-End)	J-35
Structural Box	J-35
“T” Handle Sockets.....	J-41

Tool Display Boards

Combination Wrenches

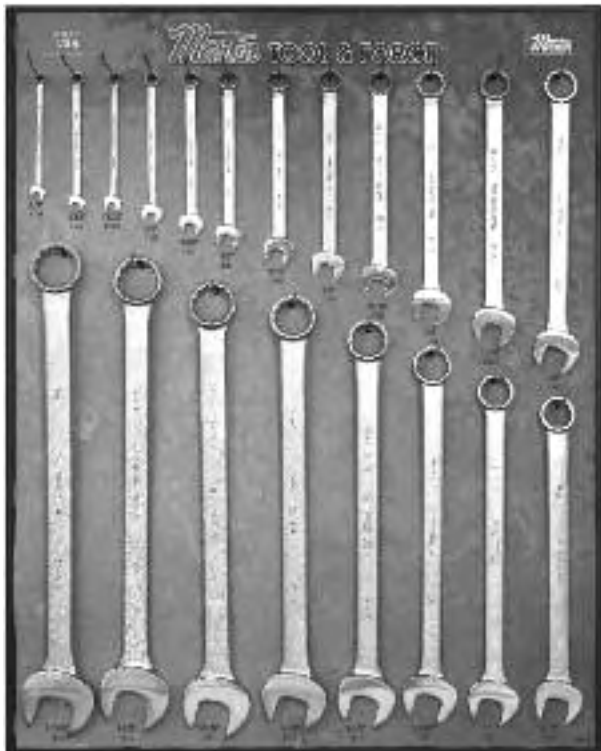

BD1		QTY.
1158	1/4 Combination Wrench	1
1159	5/16 Combination Wrench	1
1159A	11/32 Combination Wrench	1
1160	3/8 Combination Wrench	1
1161	7/16 Combination Wrench	1
1162	1/2 Combination Wrench	1
1163	9/16 Combination Wrench	1
1164	5/8 Combination Wrench	1
1165	11/16 Combination Wrench	1
1166	3/4 Combination Wrench	1
1167A	13/16 Combination Wrench	1
1167	7/8 Combination Wrench	1
1168	15/16 Combination Wrench	1
1170	1 Combination Wrench	1
1171	1 1/16 Combination Wrench	1
1172	1 1/8 Combination Wrench	1
1173	1 1/4 Combination Wrench	1
1174	1 5/16 Combination Wrench	1
1175	1 3/8 Combination Wrench	1
1176	1 7/16 Combination Wrench	1

Combination Wrenches - Metric

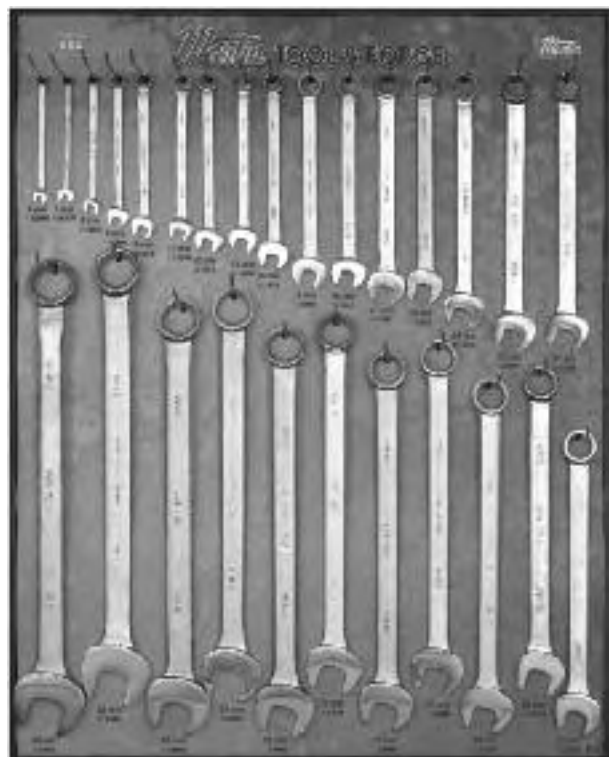

BD2		QTY.
1106MM	6 MM Combination Wrench	1
1107MM	7 MM Combination Wrench	1
1108MM	8 MM Combination Wrench	1
1109MM	9 MM Combination Wrench	1
1110MM	10 MM Combination Wrench	1
1111MM	11 MM Combination Wrench	1
1112MM	12 MM Combination Wrench	1
1113MM	13 MM Combination Wrench	1
1114MM	14 MM Combination Wrench	1
1115MM	15 MM Combination Wrench	1
1116MM	16 MM Combination Wrench	1
1117MM	17 MM Combination Wrench	1
1118MM	18 MM Combination Wrench	1
1119MM	19 MM Combination Wrench	1
1120MM	20 MM Combination Wrench	1
1121MM	21 MM Combination Wrench	1
1122MM	22 MM Combination Wrench	1
1123MM	23 MM Combination Wrench	1
1124MM	24 MM Combination Wrench	1
1125MM	25 MM Combination Wrench	1
1126MM	26 MM Combination Wrench	1
1127MM	27 MM Combination Wrench	1
1128MM	28 MM Combination Wrench	1
1129MM	29 MM Combination Wrench	1
1130MM	30 MM Combination Wrench	1
1132MM	32 MM Combination Wrench	1
1134MM	34 MM Combination Wrench	1

TOOLS

Hydraulic Wrenches



BD3		QTY.
3710A	11/32x11/32 Hydraulic Wrench	1
3710	3/8x3/8 Hydraulic Wrench	1
3711	7/16x7/16 Hydraulic Wrench	1
3712	1/2x1/2 Hydraulic Wrench	1
3713	9/16x9/16 Hydraulic Wrench	1
3714	5/8x5/8 Hydraulic Wrench	1
3715	11/16x11/16 Hydraulic Wrench	1
3716	3/4x3/4 Hydraulic Wrench	1
3717	13/16x13/16 Hydraulic Wrench	1
3718	7/8x7/8 Hydraulic Wrench	1
3719	15/16x15/16 Hydraulic Wrench	1
3720	1x1 Hydraulic Wrench	1
3721	1 1/16x 1 1/16 Hydraulic Wrench	1
3722	1 1/8x1 1/8 Hydraulic Wrench	1
3722A	1 3/16x1 3/16 Hydraulic Wrench	1
3723	1 1/4x1 1/4 Hydraulic Wrench	1
3724	1 3/8x1 3/8 Hydraulic Wrench	1
3725	1 7/16x1 7/16 Hydraulic Wrench	1
3726	1 1/2x 1 1/2 Hydraulic Wrench	1

Hydraulic Wrenches — Metric



BD4		QTY.
3709mm	9 mm Hydraulic Wrench	1
3710mm	10 mm Hydraulic Wrench	1
3711mm	11 mm Hydraulic Wrench	1
3712mm	12 mm Hydraulic Wrench	1
3713mm	13 mm Hydraulic Wrench	1
3714mm	14 mm Hydraulic Wrench	1
3715mm	15 mm Hydraulic Wrench	1
3716mm	16 mm Hydraulic Wrench	1
3717mm	17 mm Hydraulic Wrench	1
3718mm	18 mm Hydraulic Wrench	1
3719mm	19 mm Hydraulic Wrench	1
3720mm	20 mm Hydraulic Wrench	1
3721mm	21 mm Hydraulic Wrench	1
3722mm	22 mm Hydraulic Wrench	1
3723mm	23 mm Hydraulic Wrench	1
3724mm	24 mm Hydraulic Wrench	1
3727mm	27 mm Hydraulic Wrench	1
3730mm	30 mm Hydraulic Wrench	1
3732mm	32 mm Hydraulic Wrench	1
3734mm	34 mm Hydraulic Wrench	1
3736mm	36 mm Hydraulic Wrench	1

Tool Display Boards

Service Wrenches



BD5		QTY.
1224	3/4 Service Wrench	1
1226	13/16 Service Wrench	1
1228	7/8 Service Wrench	1
1230	15/16 Service Wrench	1
1232	1 Service Wrench	1
1234	1 1/16 Service Wrench	1
1236	1 1/8 Service Wrench	1
1238	1 3/16 Service Wrench	1
1240	1 1/4 Service Wrench	1
1242	1 5/16 Service Wrench	1
1244	1 3/8 Service Wrench	1
1246	1 7/16 Service Wrench	1
1248	1 1/2 Service Wrench	1
1250	1 9/16 Service Wrench	1
1252	1 5/8 Service Wrench	1
1254	1 11/16 Service Wrench	1
1256	1 3/4 Service Wrench	1
1258	1 13/16 Service Wrench	1
1260	1 7/8 Service Wrench	1
1262	1 15/16 Service Wrench	1
1264	2 Service Wrench	1
1268	2 1/8 Service Wrench	1
1272	2 1/4 Service Wrench	1

Service Wrenches — Metric

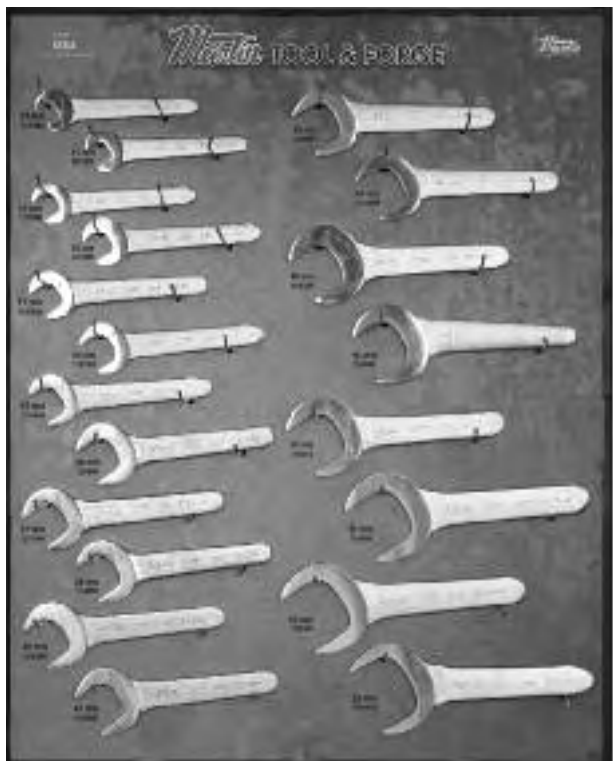

BD6		QTY.
1219mm	19mm Service Wrench	1
1221mm	21 mm Service Wrench	1
1222mm	22 mm Service Wrench	1
1224mm	24 mm Service Wrench	1
1227mm	27 mm Service Wrench	1
1230mm	30 mm Service Wrench	1
1232mm	32 mm Service Wrench	1
1236mm	36 mm Service Wrench	1
1237mm	37 mm Service Wrench	1
1238mm	38 mm Service Wrench	1
1240mm	40 mm Service Wrench	1
1241mm	41 mm Service Wrench	1
1242mm	42 mm Service Wrench	1
1244mm	44 mm Service Wrench	1
1246mm	46 mm Service Wrench	1
1248mm	48 mm Service Wrench	1
1250mm	50 mm Service Wrench	1
1255mm	55 mm Service Wrench	1
1260mm	60 mm Service Wrench	1
1265mm	65 mm Service Wrench	1

TOOLS

Double Open End / Box Wrenches

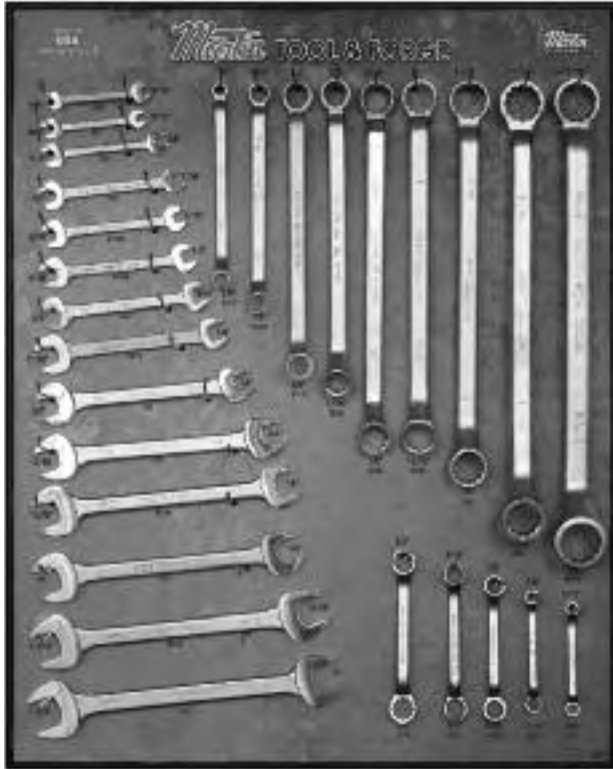

BD7		QTY.
1020	1/4x5/16 Open End Wrench	1
1721	5/16x3/8 Open End Wrench	1
1723	3/8x7/16 Open End Wrench	1
1725	7/16x1/2 Open End Wrench	1
1725A	7/16x9/16 Open End Wrench	1
1725B	1/2x9/16 Open End Wrench	1
1727	9/16x5/8 Open End Wrench	1
1027B	5/8x11/16 Open End Wrench	1
1729	5/8x3/4 Open End Wrench	1
1731	3/4x13/16 Open End Wrench	1
1033A	7/8x15/16 Open End Wrench	1
1733	7/8x1 Open End Wrench	1
1034A	15/16x1 1/16 Open End Wrench	1
1735	1x1 1/8 Open End Wrench	1
8723	3/8x7/16 Long Box Wrench	1
8725B	1/2x9/16 Long Box Wrench	1
8729	5/8x3/4 Long Box Wrench	1
8029B	11/16x3/4 Long Box Wrench	1
8033A	7/8x15/16 Long Box Wrench	1
8033C	15/16x1 Long Box Wrench	1
8735	1x1 1/8 Long Box Wrench	1
8037	1 1/16x1 1/4 Long Box Wrench	1
8039B	1 1/4x1 7/16 Long Box Wrench	1
9721	5/16x3/8 Dbl. Offset Box Wrench	1
9723	3/8x7/16 Dbl. Offset Box Wrench	1
9725B	1/2x9/16 Dbl. Offset Box Wrench	1
9727	9/16x5/8 Dbl. Offset Box Wrench	1
9729	5/8x3/4 Dbl. Offset Box Wrench	1

Check Nut Wrenches



BD9		QTY.
601A	7/16 CHECKNUT	1
601	1/2 CHECKNUT	1
602A	9/16 CHECKNUT	1
602	19/32 CHECKNUT	1
603A	5/8 CHECKNUT	1
603	11/16 CHECKNUT	1
604A	3/4 CHECKNUT	1
605A	13/16 CHECKNUT	1
605	7/8 CHECKNUT	1
606A	15/16 CHECKNUT	1
606B	1 CHECKNUT	1
607	1 1/16 CHECKNUT	1
607A	1 1/8 CHECKNUT	1
608	1 1/4 CHECKNUT	1
610MM	10mm CHECKNUT	1
611MM	1mm CHECKNUT	1
612MM	12mm CHECKNUT	1
613MM	13mm CHECKNUT	1
614MM	14mm CHECKNUT	1
615MM	15mm CHECKNUT	1
616MM	16mm CHECKNUT	1
617MM	17mm CHECKNUT	1
618MM	18mm CHECKNUT	1
619MM	19mm CHECKNUT	1
621MM	21mm CHECKNUT	1
622MM	22mm CHECKNUT	1
624MM	24mm CHECKNUT	1
627MM	27mm CHECKNUT	1
630MM	30mm CHECKNUT	1
632MM	32mm CHECKNUT	1

Tool Display Boards

Crowfoot Wrenches

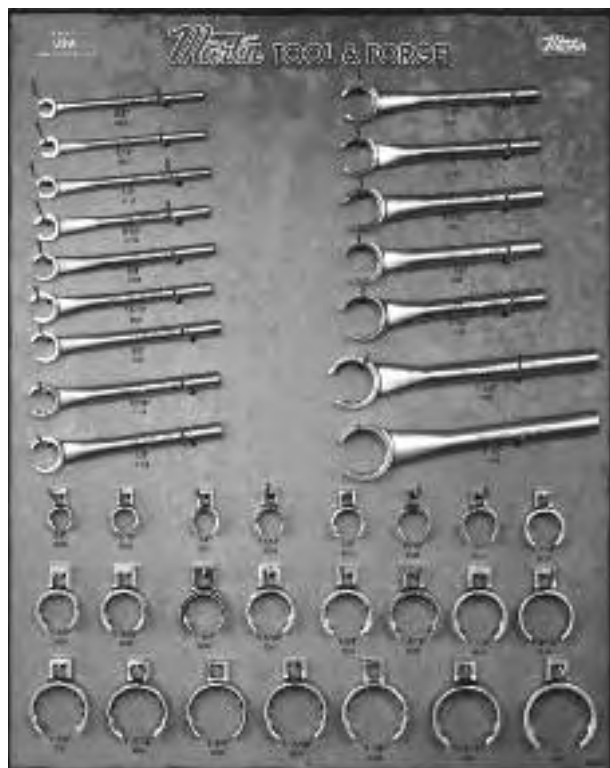

BD10		QTY.
4112	3/8 Crowfoot Wrench	1
4114	7/16 Crowfoot Wrench	1
4116	1/2 Crowfoot Wrench	1
4118	9/16 Crowfoot Wrench	1
4120	5/8 Crowfoot Wrench	1
4122	11/16 Crowfoot Wrench	1
4124	3/4 Crowfoot Wrench	1
4126	13/16 Crowfoot Wrench	1
4128	7/8 Crowfoot Wrench	1
4130	15/16 Crowfoot Wrench	1
4132	1 Crowfoot Wrench	1
4134	1 1/16 Crowfoot Wrench	1
4136	1 1/8 Crowfoot Wrench	1
4140	1 1/4 Crowfoot Wrench	1
4144	1 3/8 Crowfoot Wrench	1
4148	1 1/2 Crowfoot Wrench	1
BC20	5/8 Drive Crowfoot	1
BC22	11/16 Drive Crowfoot	1
BC24	3/4 Drive Crowfoot	1
BC26	13/16 Drive Crowfoot	1
BC28	7/8 Drive Crowfoot	1
BC30	15/16 Drive Crowfoot	1
BC32	1 Drive Crowfoot	1
BC34	1 1/16 Drive Crowfoot	1
SC36	1 1/8 Drive Crowfoot	1
SC38	1 3/16 Drive Crowfoot	1
SC40	1 1/4 Drive Crowfoot	1
SC42	1 5/16 Drive Crowfoot	1
SC44	1 3/8 Drive Crowfoot	1
SC46	1 7/16 Drive Crowfoot	1
SC50	1 9/16 Drive Crowfoot	1
SC52	1 5/8 Drive Crowfoot	1
SC54	1 11/16 Drive Crowfoot	1
SC56	1 3/4 Drive Crowfoot	1
SC58	1 13/16 Drive Crowfoot	1
SC60	1 7/8 Drive Crowfoot	1
SC62	1 15/16 Drive Crowfoot	1
SC64	2 Drive Crowfoot	1

Spanner Wrenches



BD11		QTY.
O471	3/4 to 2 Adjustable Pin Spanner	1
O471A	3/4 to 2 Adjustable Pin Spanner	1
O472	1 1/4 to 3 Adjustable Pin Spanner	1
O472A	1 1/4 to 3 Adjustable Pin Spanner	1
O474	2 to 4 3/4 Adjustable Pin Spanner	1
O474A	4 1/2 to 6 1/4 Adjustable Pin Spanner	1
471	3/4 to 2 Adjustable Hook Spanner	1
472	1 1/4 to 3 Adjustable Hook Spanner	1
474	2 to 4 3/4 Adjustable Hook Spanner	1
474A	4 1/2 to 6 1/4 Adjustable Hook Spanner	1
474B	6 1/8 to 8 3/4 Adjustable Hook Spanner	1
482	2 Adjustable Face Spanner	1
483	3 Adjustable Face Spanner	1
484	4 Adjustable Face Spanner	1

TOOLS

Adjustable Wrenches



BD12		QTY.
A6	6 Adjustable Wrench	1
A6T	6 Adjustable Wrench Black	1
A8	8 Adjustable Wrench	1
A8T	8 Adjustable Wrench Black	1
A10	10 Adjustable Wrench	1
A10T	10 Adjustable Wrench Black	1
A12	12 Adjustable Wrench	1
A12T	12 Adjustable Wrench Black	1
A 15	15 Adjustable Wrench	1
A15T	15 Adjustable Wrench Black	1
A18	18 Adjustable Wrench	1
A18T	18 Adjustable Wrench Black	1
89311	11 Adjustable Auto Wrench	1

Pliers



BD13		QTY.
P206	6 Diagonal Cutting	1
P208	8 Combination Slip Joint	1
P210	10 Combination Slip Joint	1
P307	7 Lineman's	1
P308	8 1/2 Lineman's	1
P309	9 1/4 New England Pattern Lineman's	1
P407	7 Tongue and Groove	1
P506	6 1/2 Long Chain Side Cutting	1
P507	8 Long Chain Side Cutting	1
P510	10 Tongue and Groove	1
P2065	6 3/4 Combination Slip Joint	1
P2075	7 Diagonal Cutting	1
P71275	13 Tongue and Groove	1
P75	10" Retaining Ring Plier 1 1/2" - 4"	1
P1421	6" Retaining Ring Plier 1/8" - 1"	1
P1434	8" Retaining Ring Plier 1/4" - 2"	1

Tool Board Displays



Dollies



BD14		QTY.
1024	Surfacing Spoon	1
1036	Light Dinging Spoon	1
1052	Spoon Dolly	1
1056	Wing-Ding Spoon Dolly	1
1057	Light Weight Toe Dolly	1
1058	Toe Dolly	1
1058S	Shrinking Dolly (Serrated)	1
1059	Heel Dolly	1
1060	General Purpose Dolly	1
1065	Light Weight Wedge Dolly	1

Wood Handle Hammers



BD15WD		QTY.
150G	Dinging Hmr.	1
153G	Cross Chisel Hmr.	1
153GB	Cross Chisel Curved Hmr.	1
153S	Cross Chisel Shrinking Hmr.	1
156GB	Curved Pick Hmr.	1
158G	General Purpose Pick Hmr.	1
160G	Heavy Duty Bumping Hmr.	1
162G	Shrinking Hmr.	1
164G	Utility Pick Hmr.	1
168G	Cross Peen Finishing Hmr.	1
170G	Door Skin Hmr.	1

TOOLS

Fiberglass Handle Hammers



BD15FG		QTY.
150FG	Dinging Hmr.	1
153FG	Cross Chisel Hmr.	1
153FGB	Cross Chisel Curved Hmr.	1
153SFG	Cross Chisel Shrinking Hmr.	1
156FG	Curved Pick Hmr.	1
158FG	General Purpose Pick Hmr.	1
160FG	Heavy Duty Bumping Hmr.	1
162FG	Shrinking Hmr.	1
164FG	Utility Pick Hmr.	1
168FG	Cross Peen Finishing Hmr.	1
170FG	Door Skin Hmr.	1

1/4" & 3/8" Sockets



BD16	QTY.	BD16	QTY.	DB16	QTY.
M52	ATTACH,1/4,RATCH	1	BA10	SKT,3/8,HEX,BIT,5/16	1
M103	ATTACH,1/4,EXT,3	1	BA12	SKT,3/8,HEX,BIT,5/16	1
M106	ATTACH,1/4,SPINNER,6	1	BU612	SKT,3/8,6PT,FLEX,3/8	1
M605	SKT,1/4,6PT,STD,5/32	1	BU614	SKT,3/8,6PT,FLEX,7/16	1
M606	SKT,1/4,6PT,STD,3/16	1	BU616	SKT,3/8,6PT,FLEX,1/2	1
M607	SKT,1/4,6PT,STD,7/32	1	BU618	SKT,3/8,6PT,FLEX,9/16	1
M608	SKT,1/4,6PT,STD,1/4	1	BU620	SKT,3/8,6PT,FLEX,5/8	1
M609	SKT,1/4,6PT,STD,9/32	1	BU622	SKT,3/8,6PT,FLEX,11/16	1
M610	SKT,1/4,6PT,STD,5/16	1	BU624	SKT,3/8,6PT,FLEX,3/4	1
M611	SKT,1/4,6PT,STD,11/32	1	B40A	RATCH,3/8,F-HDL,8 1/2	1
M612	SKT,1/4,6PT,STD,3/8	1	B52	RATCH,3/8,REV,7	1
M614	SKT,1/4,6PT,STD,7/16	1	B54	RATCH,3/8,FLEX	1
M616	SKT,1/4,6PT,STD,1/2	1	B103	ATTACH,EXT,3/8,3	1
M1206	SKT,1/4,12PT,STD,3/16	1	B105	ATTACH,EXT,3/8,5	1
M1207	SKT,1/4,12PT,STD,7/32	1	B112	ATTACH,EXT,3/8,12	1
M1208	SKT,1/4,12PT,STD,1/4	1	B608	SKT,3/8,6PT,STD,1/4	1
M1209	SKT,1/4,12PT,STD,9/32	1	B610	SKT,3/8,6PT,STD,5/16	1
M1210	SKT,1/4,12PT,STD,5/16	1	B612	SKT,3/8,6PT,STD,3/8	1
M1211	SKT,1/4,12PT,STD,11/32	1	B614	SKT,3/8,6PT,STD,7/16	1
M1212	SKT,1/4,12PT,STD,3/8	1	B616	SKT,3/8,6PT,STD,1/2	1
M1214	SKT,1/4,12PT,STD,7/16	1	B618	SKT,3/8,6PT,STD,9/16	1
M1216	SKT,1/4,12PT,STD,1/2	1	B620	SKT,3/8,6PT,STD,5/8	1
MD606	SKT,1/4,6PT,DP,3/16	1	B622	SKT,3/8,6PT,STD,11/16	1
MD607	SKT,1/4,6PT,DP,7/32	1	B624	SKT,3/8,6PT,STD,3/4	1
MD608	SKT,1/4,6PT,DP,1/4	1	B626	SKT,3/8,6PT,STD,13/16	1
MD609	SKT,1/4,6PT,DP,9/32	1	B628	SKT,3/8,6PT,STD,7/8	1
MD610	SKT,1/4,6PT,DP,5/16	1	B630	SKT,3/8,6PT,STD,15/16	1
MD611	SKT,1/4,6PT,DP,11/32	1	B632	SKT,3/8,6PT,STD,1	1
MD612	SKT,1/4,6PT,DP,3/8	1	B1208	SKT,3/8,12PT,STD,1/4	1
MD614	SKT,1/4,6PT,DP,7/16	1	B1210	SKT,3/8,12PT,STD,5/16	1
MD616	SKT,1/4,6PT,DP,1/2	1	B1212	SKT,3/8,12PT,STD,3/8	1
MM604	SKT,1/4,6PT,STD,4MM	1	B1214	SKT,3/8,12PT,STD,7/16	1
MM605	SKT,1/4,6PT,STD,5MM	1	B1216	SKT,3/8,12PT,STD,1/2	1
MM606	SKT,1/4,6PT,STD,6MM	1	B1218	SKT,3/8,12PT,STD,9/16	1
MM607	SKT,1/4,6PT,STD,7MM	1	B1220	SKT,3/8,12PT,STD,5/8	1
MM608	SKT,1/4,6PT,STD,8MM	1	B1222	SKT,3/8,12PT,STD,11/16	1
MM609	SKT,1/4,6PT,STD,9MM	1	B1224	SKT,3/8,12PT,STD,3/4	1
MM610	SKT,1/4,6PT,STD,10MM	1	B1226	SKT,3/8,12PT,STD,13/16	1
MM611	SKT,1/4,6PT,STD,11MM	1	B1228	SKT,3/8,12PT,STD,7/8	1
MM612	SKT,1/4,6PT,STD,12MM	1	B1230	SKT,3/8,12PT,STD,15/16	1
MM613	SKT,1/4,6PT,STD,13MM	1	B1232	SKT,3/8,12PT,STD,1	1
BS129	ATT,ADAPT,3/8-FX1/4-M	1	BD608	SKT,3/8,6PT,DP,1/4	1
BS130	ATT,ADAPT,3/8-FX1/2-M	1	BD610	SKT,3/8,6PT,DP,5/16	1
B140A	ATTACH,3/8,UNIVERSAL	1	BD612	SKT,3/8,6PT,DP,3/8	1
BA4	SKT,3/8,HEX,BIT,1/8	1	BD614	SKT,3/8,6PT,DP,7/16	1
BA5	SKT,3/8,HEX,BIT,5/32	1	BD616	SKT,3/8,6PT,DP,1/2	1
BA6	SKT,3/8,HEX,BIT,3/16	1	BD618	SKT,3/8,6PT,DP,9/16	1
BA7	SKT,3/8,HEX,BIT,7/32	1	BD620	SKT,3/8,6PT,DP,5/8	1
BA8	SKT,3/8,HEX,BIT,1/4	1	BD622	SKT,3/8,6PT,DP,11/16	1
BD624	SKT,3/8,6PT,DP,3/4	1			
BD626	SKT,3/8,6PT,DP,13/16	1			
BD628	SKT,3/8,6PT,DP,7/8	1			
BD630	SKT,3/8,6PT,DP,15/16	1			
BD632	SKT,3/8,6PT,DP,1	1			
BD620P	SKT,3/8,6PT,SPK,PLG,5/8	1			
BD626P	SKT,3/8,6PT,SPK,PLG,13/16	1			
BD1212	SKT,3/8,12PT,DP,3/8	1			
BD1214	SKT,3/8,12PT,DP,7/16	1			
BD1216	SKT,3/8,12PT,DP,1/2	1			
BD1218	SKT,3/8,12PT,DP,9/16	1			
BD1220	SKT,3/8,12PT,DP,5/8	1			
BD1222	SKT,3/8,12PT,DP,11/16	1			
BD1224	SKT,3/8,12PT,DP,3/4	1			
BD1226	SKT,3/8,12PT,DP,13/16	1			
BD1228	SKT,3/8,12PT,DP,7/8	1			
BM606	SKT,3/8,6PT,STD,6MM	1			
BM607	SKT,3/8,6PT,STD,7MM	1			
BM608	SKT,3/8,6PT,STD,8MM	1			
BM609	SKT,3/8,6PT,STD,9MM	1			
BM610	SKT,3/8,6PT,STD,10MM	1			
BM611	SKT,3/8,6PT,STD,11MM	1			
BM612	SKT,3/8,6PT,STD,12MM	1			
BM613	SKT,3/8,6PT,STD,13MM	1			
BM614	SKT,3/8,6PT,STD,14MM	1			
BM615	SKT,3/8,6PT,STD,15MM	1			
BM616	SKT,3/8,6PT,STD,16MM	1			
BM617	SKT,3/8,6PT,STD,17MM	1			
BM618	SKT,3/8,6PT,STD,18MM	1			
BM619	SKT,3/8,6PT,STD,19MM	1			
BM606	SKT,3/8,6PT,DP,6MM	1			
BM607	SKT,3/8,6PT,DP,7MM	1			
BM608	SKT,3/8,6PT,DP,8MM	1			
BM609	SKT,3/8,6PT,DP,9MM	1			
BM610	SKT,3/8,6PT,DP,10MM	1			
BM611	SKT,3/8,6PT,DP,11MM	1			
BM612	SKT,3/8,6PT,DP,12MM	1			
BM613	SKT,3/8,6PT,DP,13MM	1			
BM614	SKT,3/8,6PT,DP,14MM	1			
BM615	SKT,3/8,6PT,DP,15MM	1			
BM616	SKT,3/8,6PT,DP,16MM	1			
BM617	SKT,3/8,6PT,DP,17MM	1			
BM618	SKT,3/8,6PT,DP,18MM	1			
BM619	SKT,3/8,6PT,DP,19MM	1			

Tool Display Boards



1/2" Chrome



BD17		QTY.			QTY.
S15	ATTACH,1/2,SPEEDER,18	1	ST1232	SKT,1/2,12P,STD,1	1
S102P	ATTACH,1/2,EXT,2	1	ST1234	SKT,1/2,12P,STD,1-1/16	1
S110P	ATTACH,1/2,EXT,5	1	ST1236	SKT,1/2,12P,STD,1-1/8	1
S115P	ATTACH,1/2,EXT,10	1	ST1238	SKT,1/2,12P,STD,1-3/16	1
S121P	ATTACH,1/2,EXT,18	1	ST1240	SKT,1/2,12P,STD,1-1/4	1
S140	ATTACH,1/2,UNIVERSAL	1	ST1242	SKT,1/2,12PT,STD,1-5/16	1
SA8	SKT,1/2,HEX,BIT,1/4	1	ST1244	SKT,1/2,12P,STD,1-3/8	1
SA10	SKT,1/2,HEX,BIT,5/16	1	ST1246	SKT,1/2,12PT,STD,1-7/16	1
SA12	SKT,1/2,HEX,BIT,3/8	1	ST1248	SKT,1/2,12P,STD,1-1/2	1
SA14	SKT,1/2,HEX,BIT,7/16	1	ST612	SKT,1/2,6P,STD,3/8	1
SA16	SKT,1/2,HEX,BIT,1/2	1	ST614	SKT,1/2,6P,STD,7/16	1
SA18	SKT,1/2,HEX,BIT,9/16	1	ST616	SKT,1/2,6P,STD,1/2	1
SA20	SKT,1/2,HEX,BIT,5/8	1	ST618	SKT,1/2,6P,STD,9/16	1
SF41	ATTACH,1/2,F-HDL,17	1	ST620	SKT,1/2,6P,STD,5/8	1
SF51	RACTH,1/2,,REV,10	1	ST622	SKT,1/2,6P,STD,11/16	1
SF55	1/2" RATCHET 15"	1	ST624	SKT,1/2,6P,STD,3/4	1
SH129	ADAPT,1/2F X 3/8M	1	ST626	SKT,1/2,6P,STD,13/16	1
SH130	ADAPT,1/2 F X 3/4M	1	ST628	SKT,1/2,6P,STD,7/8	1
ST1212	SKT,1/2,12P,STD,3/8	1	ST630	SKT,1/2,6P,STD,15/16	1
ST1214	SKT,1/2,12P,STD,7/16	1	ST632	SKT,1/2,6P,STD,1	1
ST1216	SKT,1/2,12PTSTD,1/2	1	ST634	SKT,1/2,6P,STD,1-1/16	1
ST1218	SKT,1/2,12P,STD,9/16	1	ST636	SKT,1/2,6P,STD,1-1/8	1
ST1220	SKT,1/2,12P,STD,5/8	1	ST638	SKT,1/2,6P,STD,1-3/16	1
ST1222	SKT,1/2,12P,STD,11/16	1	ST640	SKT,1/2,6P,STD,1-1/4	1
ST1224	SKT,1/2,12P,STD,3/4	1			
ST1226	SKT,1/2,12P,STD,13/16	1			
ST1228	SKT,1/2,12P,STD,7/8	1			
ST1230	SKT,1/2,12P,STD,15/16	1			

1/2" Chrome Sockets



BD18	QTY.	BD16	QTY.		
SD1212	SKT,1/2,12P,DP,3/8	1	STM1215	SKT,1/2,12P,STD,15MM	1
SD1214	SKT,1/2,12P,DP,7/16	1	STM1216	SKT,1/2,12P,STD,16MM	1
SD1216	SKT,1/2,12P,DP,1/2	1	STM1217	SKT,1/2,12P,STD,17MM	1
SD1218	SKT,1/2,12P,DP,9/16	1	STM1218	SKT,1/2,12P,STD,18MM	1
SD1220	SKT,1/2,12P,DP,5/8	1	STM1219	SKT,1/2,12P,STD,19MM	1
SD1222	SKT,1/2,12P,DP,11/16	1	STM1220	SKT,1/2,12P,STD,20MM	1
SD1224	SKT,1/2,12P,DP,3/4	1	STM1221	SKT,1/2,12P,STD,21MM	1
SD1226	SKT,1/2,12P,DP,13/16	1	STM1222	SKT,1/2,12P,STD,22MM	1
SD1228	SKT,1/2,12P,DP,7/8	1	STM1223	SKT,1/2,12P,STD,23MM	1
SD1230	SKT,1/2,12P,DP,15/16	1	STM1224	SKT,1/2,12P,STD,24MM	1
SD1232	SKT,1/2,12P,DP,1	1	STM1225	SKT,1/2,12P,STD,25MM	1
SD1234	SKT,1/2,12P,DP,1-1/16	1	STM1226	SKT,1/2,12P,STD,26MM	1
SD1236	SKT,1/2,12P,DP,1-1/8	1	STM1227	SKT,1/2,12P,STD,27MM	1
SD1238	SKT,1/2,12P,DP,1-3/16	1	STM1230	SKT,1/2,12P,STD,30MM	1
SD1240	SKT,1/2,12P,DP,1-1/4	1	STM1232	SKT,1/2,12P,STD,32MM	1
SD1242	SKT, 1/2, 12P, DP, 1-5/16	1	STM1236	SKT,1/2,12P,STD,36MM	1
SD1244	SKT,1/2,12P,DP,1-3/8	1	SMD1210	SKT,1/2,12P,DP,10MM	1
SD1246	SKT,1/2,12P,DP,1-7/16	1	SMD1211	SKT,1/2,12P,DP,11MM	1
SD1248	SKT,1/2,12P,DP,1-1/2	1	SMD1212	SKT,1/2,12P,DP,12MM	1
SD616	SKT,1/2,6P,DP,1/2	1	SMD1213	SKT,1/2,12P,DP,13MM	1
SD618	SKT,1/2,6P,DP,9/16	1	SMD1214	SKT,1/2,12P,DP,14MM	1
SD620	SKT,1/2,6P,DP,5/8	1	SMD1215	SKT,1/2,12P,DP,15MM	1
SD622	SKT,1/2,6P,DP,11/16	1	SMD1216	SKT,1/2,12P,DP,16MM	1
SD624	SKT,1/2,6P,DP,3/4	1	SMD1217	SKT,1/2,12P,DP,17MM	1
SD626	SKT,1/2,6P,DP,13/16	1	SMD1218	SKT,1/2,12P,DP,18MM	1
SD628	SKT,1/2,6P,DP,7/8	1	SMD1219	SKT,1/2,12P,DP,19MM	1
SD630	SKT,1/2,6P,DP,15/16	1	SMD1220	SKT,1/2,12P,DP,20MM	1
SD632	SKT,1/2,6P,DP,1	1	SMD1221	SKT,1/2,12P,DP,21MM	1
SD634	SKT,1/2,6P,DP,1-1/16	1	SMD1222	SKT,1/2,12P,DP,22MM	1
SD636	SKT,1/2,6P,DP,1-1/8	1	SMD1223	SKT,1/2,12P,DP,23MM	1
STM1209	SKT,1/2,12P,STD,9MM	1	SMD1224	SKT,1/2,12P,DP,24MM	1
STM1210	SKT,1/2,12P,STD,10MM	1	SMD1225	SKT,1/2,12P,DP,25MM	1
STM1211	SKT,1/2,12P,STD,11MM	1	SMD1226	SKT,1/2,12P,DP,26MM	1
STM1212	SKT,1/2,12P,STD,12MM	1	SMD1227	SKT,1/2,12P,DP,27MM	1
STM1213	SKT,1/2,12P,STD,13MM	1			
STM1214	SKT,1/2,12P,STD,14MM	1			

TOOLS

3/4" Chrome



BD19		QTY.
H20A	ATTACH,3/4,T-SLIDE,	1
H41A	ATTACH,3/4,F-HDL,21-5/8	1
H51	RATCH,3/4,REV,24	1
H104	ATTACH,3/4,EXT,3-1/2	1
H110	ATTACH,3/4,EXT,8	1
H115	ATTACH,3/4,EXT,16	1
H140	ATTACH,3/4,UNIVERSAL	1
H1224	SKT,3/4,12PT,STD,3/4	1
H1226	SKT,3/4,12PT,STD,13/16	1
H1228	SKT,3/4,12PT,STD,7/8	1
H1230	SKT,3/4,12PT,STD,15/16	1
H1232	SKT,3/4,12PT,STD,1	1
H1234	SKT,3/4,12PT,STD,1-1/16	1
H1236	SKT,3/4,12PT,STD,1-1/8	1
H1238	SKT,3/4,12PT,STD,1 3/16	1
H1240	SKT,3/4,12PT,STD,1-1/4	1
H1242	SKT,3/4,12PT,STD,1-5/16	1
H1244	SKT,3/4,12PT,STD,1-3/8	1
H1246	SKT,3/4,12PT,STD,1-7/16	1
H1248	SKT,3/4,12PT,STD,1-1/2	1
H1250	SKT,3/4,12PT,STD,1-9/16	1
H1252	SKT,3/4,12PT,STD,1-5/8	1
H1254	SKT,3/4,12PT,STD,1-11/16	1
H1256	SKT,3/4,12PT,STD,1-3/4	1
H1258	SKT,3/4,12PT,STD,1-13/16	1
H1260	SKT,3/4,12PT,STD,1-7/8	1
H1264	SKT,3/4,12PT,STD,2	1
H1266	SKT,3/4,12PT,STD,2 1/16	1
H1268	SKT,3/4,12PT,STD,2 1/7	1
H1270	SKT,3/4,12PT,STD,2 3/16	1
H1272	SKT,3/4,12PT,STD,2 1/4	1
H1276	SKT,3/4,12PT,STD,2 3/8	1

3/4" Impact



BD20	QTY	BD20	QTY
6107	3/4,EXT,7	6660	SKT,3/4,6P,STD,IMP,1-7/8 1
6110	3/4,EXT,10	6662	SKT,3/4,6P,STD,IMP,1-15/16 1
64A	3/4,ADAP,3/4F-1/2M	6664	SKT,3/4,6P,STD,IMP,2 1
67	3/4,ADAP,3/4F-1M	16624	SKT,3/4,6P,DP,IMP,3/4 1
6140A	3/4,IMP,UNIVERSAL	16626	SKT,3/4,6P,DP,IMP,13/16 1
6620	SKT,3/4,6P,STD,IMP,5/8	16628	SKT,3/4,6P,DP,IMP,7/8 1
6622	SKT,3/4,6P,STD,IMP,11/16	16630	SKT,3/4,6P,DP,IMP,15/16 1
6624	SKT,3/4,6P,STD,IMP,3/4	16632	SKT,3/4,6P,DP,IMP,1 1
6626	SKT,3/4,6P,STD,IMP,13/16	16634	SKT,3/4,6P,DP,IMP,1-1/16 1
6628	SKT,3/4,6P,STD,IMP,7/8	16636	SKT,3/4,6P,DP,IMP,1-1/8 1
6630	SKT,3/4,6P,STD,IMP,15/16	16638	SKT,3/4,6P,DPIMP,1-3/16 1
6632	SKT,3/4,6P,STD,IMP,1	16640	SKT,3/4,6P,DP,IMP,1-1/4 1
6634	SKT,3/4,6P,STD,IMP,1-1/16	16642	SKT,3/4,6P,DP,IMP,1-5/16 1
6636	SKT,3/4,6P,STD,IMP,1-1/8	16644	SKT,3/4,6P,DP,IMP,1-3/8 1
6638	SKT,3/4,6P,STD,IMP,1-3/16	16646	SKT,3/4,6P,DP,IMP,1-7/16 1
6640	SKT,3/4,6P,STD,IMP,1-1/4	16648	SKT,3/4,6P,DP,IMP,1-1/2 1
6642	SKT,3/4,6P,STD,IMP,1-5/16	16650	SKT,3/4,6P,DP,IMP,1-9/16 1
6644	SKT,3/4,6P,STD,IMP,1-3/8	16652	SKT,3/4,6P,DP,IMP,1-5/8 1
6646	SKT,3/4,6P,STD,IMP,1-7/16	16654	SKT,3/4,6P,DP,IMP,111/16 1
6648	SKT,3/4,6P,STD,IMP,1-1/2	16656	SKT,3/4,6P,DP,IMP,1-3/4 1
6650	SKT,3/4,6P,STD,IMP,1-9/16	16660	SKT,3/4,6P,DP,IMP,1-7/8 1
6652	SKT,3/4,6P,STD,IMP,1-5/8	16664	SKT,3/4,6P,DP,IMP,2 1
6654	SKT,3/4,6P,STD,IMP,1-11/16 1		
6656	SKT,3/4,6P,STD,IMP,1-3/4 1		
6658	SKT,3/4,6P,STD,IMP,1-13/16 1		

TOOLS

Tool Display Boards



3/8" and 1/2" Impact



BD21		QTY	BD21		QTY
24A	3/8,IMP,ADAPT,3/8FX1/2M	1	4624	SKT,1/2,6P,STP,IMP,3/4	1
2140A	3/8,IMP,UNIVERSAL,JOINT	1	4626	SKT,1/2,6P,STD,IMP,13/16	1
2610	SKT,3/8,6P,STD,IMP,5/16	1	4628	SKT,1/2,6P,STD,IMP,7/8	1
2612	SKT,3/8,6P,STD,IMP,3/8	1	2630	SKT,1/2,6P,STD,IMP,15/16	1
2614	SKT,3/8,6P,STD,IMP,7/16	1	4632	SKT,1/2,6P,STD,IMP,1	1
2616	SKT,3/8,6P,STD,IMP,1/2	1	4634	SKT,1/2,6P,STD,IMP,1-1/16	1
2618	SKT,3/8,6P,STD,IMP,9/16	1	4636	SKT,1/2,6P,STD,IMP,1-1/8	1
2620	SKT,3/8,6P,STD,IMP,5/8	1	4638	SKT,1/2,6P,STD,IMP,1-3/16	1
2622	SKT,3/8,6P,STD,IMP,11/16	1	4640	SKT,1/2,6P,STD,IMP,1-1/4	1
2624	SKT,3/8,6P,STD,IMP,3/4	1	14612	SKT,1/2,6P,DP,IMP,3/8	1
12610	SKT,3/8,6P,DP,IMP,5/16	1	14614	SKT,1/2,6P,DP,IMP,7/16	1
12612	SKT,3/8,6P,DP,IMP,3/8	1	14616	SKT,1/2,6P,DP,IMP,1/2	1
12614	SKT,3/8,6P,DP,IMP,7/16	1	14618	SKT,1/2,6P,DP,IMP,9/16	1
12616	SKT,3/8,6P,DP,IMP,1/2	1	14620	SKT,1/2,6P,DP,IMP,5/8	1
12618	SKT,3/8,6P,DP,IMP,9/16	1	14622	SKT,1/2,6P,DP,IMP,11/16	1
12620	SKT,3/8,6P,DP,IMP,5/8	1	14624	SKT,1/2,6P,DP,IMP,3/4	1
12622	SKT,3/8,6P,DP,IMP,11/16	1	14626	SKT,1/2,6P,DP,IMP,13/16	1
12624	SKT,3/8,6P,DP,IMP,3/4	1	14628	SKT,1/2,6P,DP,IMP,7/8	1
2M610	SKT,3/8,6P,STD,IMP,10MM	1	14630	SKT,1/2,6P,DP,IMP,15/16	1
2M612	SKT,3/8,6P,STD,IMP,12MM	1	14632	SKT,1/2,6P,DP,IMP,1	1
2M613	SKT,3/8,6P,STD,IMP,13MM	1	14634	SKT,1/2,6P,DP,IMP,1-1/16	1
2M614	SKT,3/8,6P,STD,IMP,14MM	1	14636	SKT,1/2,6P,DP,IMP,1-1/8	1
2M615	SKT,3/8,6P,STD,IMP,15MM	1	14640	SKT,1/2,6P,DP,IMP,1-1/4	1
2M617	SKT,3/8,6P,STD,IMP,17MM	1	4M613	SKT,1/2,6P,STD,IMP,13MM	1
2M618	SKT,3/8,6P,STD,IMP,18MM	1	4M614	SKT,1/2,6P,STD,IMP,14MM	1
2M619	SKT,3/8,6P,STD,IMP,19MM	1	4M615	SKT,1/2,6P,STD,IMP,15MM	1
4105A	1/2,IMP,EXT,6	1	4M616	SKT,1/2,6P,STD,IMP,16MM	1
4140A	1/2,IMP,U-JOINT	1	4M617	SKT,1/2,6P,STD,IMP,17MM	1
42A	1/2,ADAP,1/2F X 3/8M	1	4M618	SKT,1/2,6P,STD,IMP,18MM	1
46	1/2,ADAP,1/2F X 3/4M	1	4M619	SKT,1/2,6P,STD,IMP,19MM	1
4612	SKT,1/2,6P,STD,IMP,3/8	1	4M621	SKT,1/2,6P,STD,IMP,21MM	1
4614	SKT,1/2,6P,STD,IMP,7/16	1	4M622	SKT,1/2,6P,STD,IMP,22MM	1
4616	SKT,1/2,6P,STD,IMP,1/2	1	4M624	SKT,1/2,6P,STD,IMP,24MM	1
4618	SKT,1/2,6P,STD,IMP,9/16	1	4M627	SKT,1/2,6P,STD,IMP,27MM	1
4620	SKT,1/2,6P,STD,IMP,5/8	1			
4622	SKT,1/2,6P,STD,IMP,11/16	1			

Screwdrivers



BD22		QTY.
GS50	GASKET SCRAPER 1/2" Blade	1
GS75	GASKET SCRAPER 3/4" Blade	1
GS100	GASKET SCRAPER 1" Blade	1
GS150	GASKET SCRAPER 1 1/2" Blade	1
SDE4	SCREWDRIVER, ELECTRICAL, 4"	1
SDE6	SCREWDRIVER, ELECTRICAL, 6"	1
SDE8	SCREWDRIVER, ELECTRICAL, 8"	1
SDP1	SCREWDRIVER, PHILLIP, 1-1/2"	1
SDP3	SCREWDRIVER, PHILLIP, 3"	1
SDP4	SCREWDRIVER, PHILLIP, 4"	1
SDP6	SCREWDRIVER, PHILLIP, 6"	1
SDR4	SCREWDRIVER, MECHANICS, 4"	1
SDR6	SCREWDRIVER, HEAVY, DUTY, 6"	1
SDR8	SCREWDRIVER, HEAVY, DUTY, 8"	1
SDS1	SCREWDRIVER, STUBBY, 1-1/2"	1
SDS4	SCREWDRIVER, SQ-BLADE, 4"	1
SDS6	SCREWDRIVER, SQ-BLADE, 6"	1
SDS8	SCREWDRIVER, SQ-BLADE, 8"	1
SDS10	SCREWDRIVER, SQ-BLADE, 10"	1
SDS12	SCREWDRIVER, SQ-BLADE, 12"	1

TOOLS

Header & Hooks



BD HEADER

QTY.

BD-HEADER Tool Board Header 23.5" x 3"
Molded in Black, Raised Letter,
w/2 Mounting Screws

1

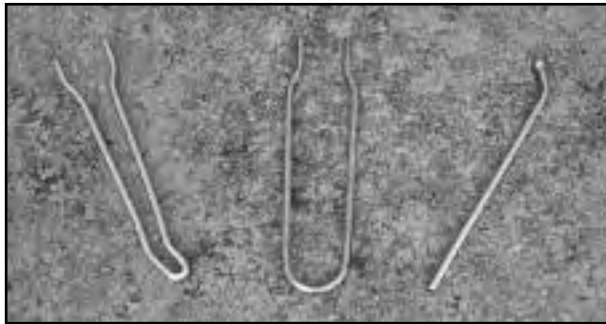

HOOKS

QTY.

1	STRAIGHT HOOK	10
2	HEAVY DUTY STRAIGHT HOOK	5
3	LOOP HOOK	5

Universal Peg Board



BD8

QTY.

BD8 UNIVERSAL PEG BOARD

1

Combination Wrenches

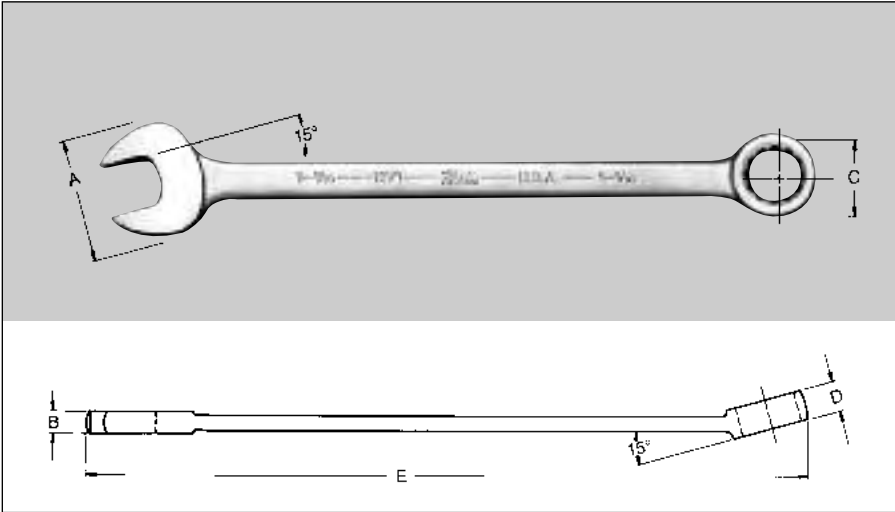

American Alloy Steel

**Drop Forged
Long Pattern
15° Angle
12 Point Box**

**Versatile, General
Purpose Wrench in a
Complete Range of
Openings, 1/4" thru
2 1/2". Chrome and
Industrial Black Finish.**

Wrench Opening	Open End		Box End		Overall Length E	Weight Ea.-Lbs.	Chrome	Industrial Black	Std. Pkg. Qty.	Wrench Opening
	Diameter	Thickness	Diameter	Thickness			Part No.	Part No.		
	A	B	C	D						
1/4	19/32	11/64	7/16	7/32	5	.04	1158	BLK1158	6	1/4
5/16	11/16	3/16	33/64	1/4	5 1/2	.05	1159	BLK1159	6	5/16
11/32	11/16	3/16	33/64	1/4	5 1/2	.05	1159A	BLK1159A	6	11/32
3/8	53/64	7/32	5/8	9/32	6	.08	1160	BLK1160	6	3/8
7/16	61/64	1/4	45/64	21/64	6 1/2	.13	1161	BLK1161	6	7/16
1/2	11/16	17/64	5/8	23/64	7 7/8	.17	1162	BLK1162	6	1/2
9/16	113/64	19/64	7/8	25/64	7 3/4	.25	1163	BLK1163	6	9/16
5/8	115/64	21/64	5/64	7/16	8 1/16	.30	1164	BLK1164	6	5/8
11/16	117/32	23/64	13/64	15/32	9 1/4	.38	1165	BLK1165	6	11/16
3/4	119/16	3/8	11/64	1/2	10 5/8	.43	1166	BLK1166	6	3/4
13/16	1111/16	13/32	17/32	17/32	11	.55	1167A	BLK1167A	6	13/16
7/8	113/16	27/64	119/64	9/16	12	.64	1167	BLK1167	6	7/8
15/16	115/16	29/64	13/8	19/32	13	.77	1168	BLK1168	6	15/16
1	21/16	27/64	115/32	19/32	14	.92	1170	BLK1170	6	1
1 1/16	213/16	29/64	119/16	5/8	15	1.07	1171	BLK1171	6	1 1/16
1 1/8	215/64	17/32	1164	11/16	16 1/8	1.37	1172	BLK1172	6	1 1/8
1 1/4	237/64	37/64	119/16	3/4	17 7/16	1.8	1173	BLK1173	1	1 1/4
1 1/2	211/16	17/32	118	3/4	18	2.1	1174	BLK1174	1	1 1/2
1 3/8	213/16	9/16	131/32	25/32	18 3/4	2.1	1175	BLK1175	1	1 3/8
1 7/16	315/16	19/32	21/16	13/16	19 1/2	3.6	1176	BLK1176	1	1 7/16
1 1/2	31/16	5/8	23/32	27/32	20 1/2	3.4	1177	BLK1177	1	1 1/2
1 5/8	313/16	21/32	211/32	7/8	21 1/2	4.5	1180	BLK1180	1	1 5/8
1 11/16	31/16	11/16	21/16	29/32	22 1/2	4.5	1182	BLK1182	1	1 11/16
1 3/4	313/16	23/32	25/8	31/32	24	7.1	1184	BLK1184	1	1 3/4
1 13/16	315/16	23/32	25/8	31/32	24	7.0	1186	BLK1186	1	1 13/16
1 7/8	41/16	25/32	27/8	11/16	25 3/4	6.9	1188	BLK1188	1	1 7/8
2	41/16	25/32	27/8	11/16	25 3/4	6.8	1190	BLK1190	1	2
2 1/16	43/32	13/16	31/16	19/64	27 1/2	8.3	1191	BLK1191	1	2 1/16
2 1/8	43/32	13/16	31/16	19/64	27 1/2	8.2	1192	BLK1192	1	2 1/8
2 1/4	47/32	7/8	33/32	13/16	29 1/4	7.9	1193	BLK1193	1	2 1/4
2 1/2	47/32	7/8	33/32	13/16	29 1/4	7.7	1194	BLK1194	1	2 1/2
2 5/8	5	31/32	37/32	19/16	31	12.1	1195	BLK1195	1	2 5/8
2 3/4	5	31/32	37/32	19/16	31	11.7	1196	BLK1196	1	2 3/4

TOOLS



Combination Wrenches

Convenient Sets Provide Popular Wrench Sizes Ranging from 3/8" thru 2" Openings. Sets are Available in 4 Sizes: 5, 7, 11 and 14 Wrenches, Packaged in a Handcrafted Fabric and Vinyl Roll Up Kit.

Chrome Sets

C7K		C11K		C14K		HC5K	
OPENING	PART NO.	OPENING	PART NO.	OPENING	PART NO.	OPENING	PART NO.
3/8	1160	3/8	1160	3/8	1160	1/4	1173
7/16	1161	7/16	1161	7/16	1161	1/8	1176
1/2	1162	1/2	1162	1/2	1162	1/2	1180
9/16	1163	9/16	1163	9/16	1163	1 3/16	1186
5/8	1164	5/8	1164	5/8	1164	2	1190
1 1/16	1165	1 1/16	1165	1 1/16	1165	KIT BAG	C55
3/4	1166	3/4	1166	3/4	1166		
KIT BAG	C187	1 9/16	1167A	1 9/16	1167A		
		7/8	1167	7/8	1167		
		1 5/16	1168	1 5/16	1168		
		1	1170	1	1170		
		KIT BAG	C110	1 1/8	1171		
				1 1/2	1172		
				1 3/4	1173		
				KIT BAG	C140		

Industrial Black Sets

CB7K		CB11K		CB14K		HCB5K	
OPENING	PART NO.	OPENING	PART NO.	OPENING	PART NO.	OPENING	PART NO.
3/8	BLK1160	3/8	BLK1160	3/8	BLK1160	1/4	BLK1173
7/16	BLK1161	7/16	BLK1161	7/16	BLK1161	1/8	BLK1176
1/2	BLK1162	1/2	BLK1162	1/2	BLK1162	1/2	BLK1180
9/16	BLK1163	9/16	BLK1163	9/16	BLK1163	1 3/16	BLK1186
5/8	BLK1164	5/8	BLK1164	5/8	BLK1164	2	BLK1190
1 1/16	BLK1165	1 1/16	BLK1165	1 1/16	BLK1165	KIT BAG	C55
3/4	BLK1166	3/4	BLK1166	3/4	BLK1166		
KIT BAG	C187	1 9/16	BLK1167A	1 9/16	BLK1167A		
		7/8	BLK1167	7/8	BLK1167		
		1 5/16	BLK1168	1 5/16	BLK1168		
		1	BLK1170	1	BLK1170		
		KIT BAG	C110	1 1/8	BLK1171		
				1 1/2	BLK1172		
				1 3/4	BLK1173		
				KIT BAG	C140		

TOOLS

Combination Wrenches Metric

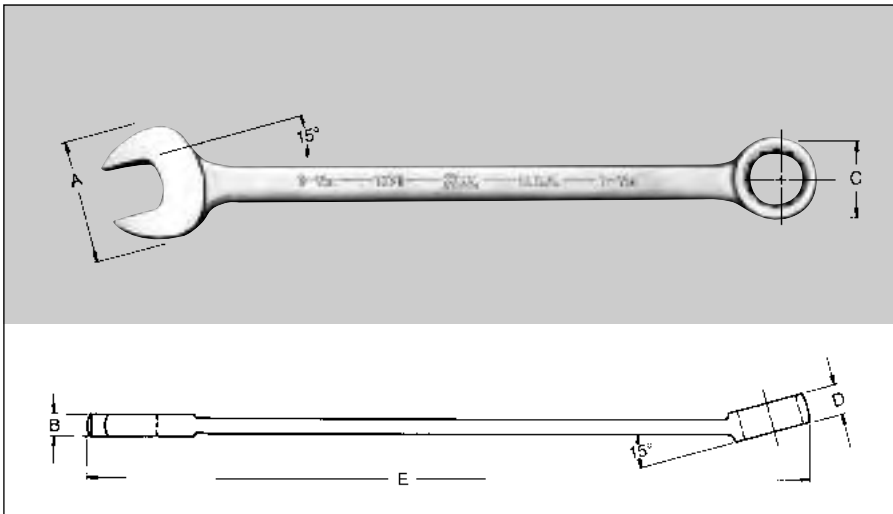

American Alloy Steel

**Drop Forged
Long Pattern
15° Angle
12 Point Box**

**Versatile, General
Purpose Wrench in a
Complete Range of
Openings, 6mm thru
60mm. Chrome and
Industrial Black Finish.**

Wrench Opening	Open End		Box End		Overall Length E	Weight Ea.-Lbs.	Chrome	Industrial Black	Std. Pkg. Qty.	Wrench Opening
	Diameter	Thickness	Diameter	Thickness			Part No.	Part No.		
	A	B	C	D						
6 mm	15.0 mm	4.1 mm	11.2 mm	5.6 mm	127.0 mm	.04	1106MM	BLK1106MM	6	6 mm
7 mm	15.0 mm	4.1 mm	11.2 mm	5.6 mm	127.0 mm	.05	1107MM	BLK1107MM	6	7 mm
8 mm	17.5 mm	4.8 mm	13.2 mm	6.4 mm	139.7 mm	.05	1108MM	BLK1108MM	6	8 mm
9 mm	20.8 mm	5.6 mm	15.7 mm	7.4 mm	152.4 mm	.08	1109MM	BLK1109MM	6	9 mm
10 mm	24.1 mm	6.4 mm	17.8 mm	8.1 mm	165.1 mm	.13	1110MM	BLK1110MM	6	10 mm
11 mm	24.1 mm	6.4 mm	17.8 mm	8.1 mm	165.1 mm	.13	1111MM	BLK1111MM	6	11 mm
12 mm	26.9 mm	6.9 mm	20.3 mm	9.1 mm	180.8 mm	.17	1112MM	BLK1112MM	6	12 mm
13 mm	26.9 mm	6.9 mm	20.3 mm	9.1 mm	180.8 mm	.17	1113MM	BLK1113MM	6	13 mm
14 mm	30.2 mm	7.6 mm	22.1 mm	9.7 mm	196.9 mm	.25	1114MM	BLK1114MM	6	14 mm
15 mm	33.3 mm	8.1 mm	24.1 mm	10.9 mm	215.9 mm	.30	1115MM	BLK1115MM	6	15 mm
16 mm	33.3 mm	8.1 mm	24.1 mm	10.9 mm	215.9 mm	.30	1116MM	BLK1116MM	6	16 mm
17 mm	38.9 mm	8.9 mm	26.4 mm	11.7 mm	235.0 mm	.38	1117MM	BLK1117MM	6	17 mm
18 mm	38.9 mm	8.9 mm	26.4 mm	11.7 mm	235.0 mm	.38	1118MM	BLK1118MM	6	18 mm
19 mm	39.6 mm	9.4 mm	28.7 mm	12.7 mm	257.0 mm	.43	1119MM	BLK1119MM	6	19 mm
20 mm	42.9 mm	10.2 mm	31.0 mm	13.5 mm	279.4 mm	.55	1120MM	BLK1120MM	6	20 mm
21 mm	42.9 mm	10.2 mm	31.0 mm	13.5 mm	279.4 mm	.55	1121MM	BLK1121MM	6	21 mm
22 mm	46.0 mm	10.7 mm	33.0 mm	14.2 mm	304.8 mm	.64	1122MM	BLK1122MM	6	22 mm
23 mm	49.3 mm	11.4 mm	35.1 mm	15.0 mm	330.2 mm	.77	1123MM	BLK1123MM	6	23 mm
24 mm	49.3 mm	11.4 mm	35.1 mm	15.0 mm	330.2 mm	.77	1124MM	BLK1124MM	6	24 mm
25 mm	52.3 mm	10.4 mm	37.3 mm	15.0 mm	355.6 mm	.92	1125MM	BLK1125MM	6	25 mm
26 mm	55.6 mm	11.2 mm	39.6 mm	15.7 mm	381.0 mm	1.07	1126MM	BLK1126MM	6	26 mm
27 mm	55.6 mm	11.2 mm	39.6 mm	15.7 mm	381.0 mm	1.07	1127MM	BLK1127MM	1	27 mm
28 mm	58.9 mm	13.5 mm	41.7 mm	17.5 mm	409.4 mm	1.40	1128MM	BLK1128MM	1	28 mm
29 mm	58.9 mm	13.5 mm	41.7 mm	17.5 mm	409.4 mm	1.34	1129MM	BLK1129MM	1	29 mm
30 mm	65.5 mm	14.7 mm	46.0 mm	19.1 mm	436.6 mm	1.80	1130MM	BLK1130MM	1	30 mm
32 mm	68.3 mm	13.5 mm	47.8 mm	19.1 mm	457.2 mm	1.80	1132MM	BLK1132MM	1	32 mm
34 mm	71.4 mm	14.2 mm	50.0 mm	19.8 mm	476.3 mm	2.10	1134MM	BLK1134MM	1	34 mm
36 mm	74.7 mm	15.0 mm	52.3 mm	20.6 mm	495.3 mm	3.60	1136MM	BLK1136MM	1	36 mm
41 mm	84.1 mm	16.8 mm	59.4 mm	22.4 mm	546.1 mm	4.50	1141MM	BLK1141MM	1	41 mm
46 mm	93.7 mm	18.3 mm	66.5 mm	24.6 mm	609.6 mm	7.00	1146MM	BLK1146MM	1	46 mm
50 mm	103.1 mm	19.8 mm	73.2 mm	26.9 mm	654.1 mm	6.80	1150MM	BLK1150MM	1	50 mm
55 mm	115.1 mm	22.4 mm	81.8 mm	30.2 mm	743.0 mm	7.90	1155MM	BLK1155MM	1	55 mm
60 mm	127.0 mm	24.6 mm	89.7 mm	33.3 mm	787.4 mm	12.10	1160MM	BLK1160MM	1	60 mm

TOOLS



Combination Wrench Metric Sets

Convenient Sets Provide Popular Wrench Sizes Ranging from 7 mm thru 32 mm Openings. Sets are Available in 5 Sizes: 7, 9, 11, 15 and 18 Wrenches, Packaged in a Handcrafted Fabric and Vinyl Roll Up Kit.

Chrome Sets				
C7KM	C9KM	C11KM	C15KM	C18KM
11 mm1111MM 12 mm1112MM 13 mm1113MM 14 mm1114MM 16 mm1116MM 17 mm1117MM 19 mm1119MM Kit BagC187	7 mm1107MM 8 mm1108MM 9 mm1109MM 10 mm1110MM 11 mm1111MM 12 mm1112MM 13 mm1113MM 14 mm1114MM 15 mm1115MM Kit BagC90	7 mm1107MM 8 mm1108MM 9 mm1109MM 10 mm1110MM 11 mm1111MM 12 mm1112MM 13 mm1113MM 14 mm1114MM 15 mm1115MM 16 mm1116MM 17 mm1117MM Kit BagC111	7 mm1107MM 8 mm1108MM 10 mm1110MM 12 mm1112MM 14 mm1114MM 16 mm1116MM 18 mm1118MM 20 mm1120MM 22 mm1122MM 24 mm1124MM 26 mm1126MM 28 mm1128MM 29 mm1129MM 30 mm1130MM 32 mm1132MM Kit BagC150	7 mm1107MM 8 mm1108MM 9 mm1109MM 10 mm1110MM 11 mm1111MM 12 mm1112MM 13 mm1113MM 14 mm1114MM 15 mm1115MM 16 mm1116MM 17 mm1117MM 18 mm1118MM 19 mm1119MM 20 mm1120MM 21 mm1121MM 22 mm1122MM 23 mm1123MM 24 mm1124MM Kit BagC180
Industrial Black Sets				
CB7KM	CB9KM	CB11KM	CB15KM	CB18KM
11 mmBLK1111MM 12 mmBLK1112MM 13 mmBLK1113MM 14 mmBLK1114MM 16 mmBLK1116MM 17 mmBLK1117MM 19 mmBLK1119MM Kit BagC187	7 mmBLK1107MM 8 mmBLK1108MM 9 mmBLK1109MM 10 mmBLK1110MM 11 mmBLK1111MM 12 mmBLK1112MM 13 mmBLK1113MM 14 mmBLK1114MM 15 mmBLK1115MM Kit BagC90	7 mmBLK1107MM 8 mmBLK1108MM 9 mmBLK1109MM 10 mmBLK1110MM 11 mmBLK1111MM 12 mmBLK1112MM 13 mmBLK1113MM 14 mmBLK1114MM 15 mmBLK1115MM 16 mmBLK1116MM 17 mmBLK1117MM Kit BagC111	7 mmBLK1107MM 8 mmBLK1108MM 10 mmBLK1110MM 12 mmBLK1112MM 14 mmBLK1114MM 16 mmBLK1116MM 18 mmBLK1118MM 20 mmBLK1120MM 22 mmBLK1122MM 24 mmBLK1124MM 26 mmBLK1126MM 28 mmBLK1128MM 29 mmBLK1129MM 30 mmBLK1130MM 32 mmBLK1132MM Kit BagC150	7 mmBLK1107MM 8 mmBLK1108MM 9 mmBLK1109MM 10 mmBLK1110MM 11 mmBLK1111MM 12 mmBLK1112MM 13 mmBLK1113MM 14 mmBLK1114MM 15 mmBLK1115MM 16 mmBLK1116MM 17 mmBLK1117MM 18 mmBLK1118MM 19 mmBLK1119MM 20 mmBLK1120MM 21 mmBLK1121MM 22 mmBLK1122MM 23 mmBLK1123MM 24 mmBLK1124MM Kit BagC180

TOOLS

Double Head Open End Wrenches

Martin

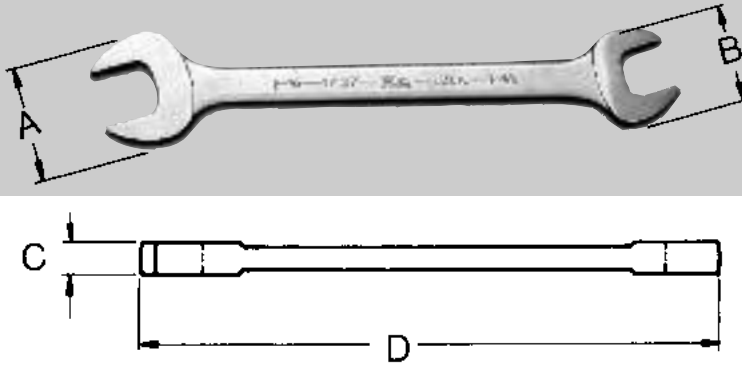

**American Alloy Steel
Drop Forged**

15° Angle

Comfortable Grip

**Chrome and
Industrial Black**

Wrench Opening	Diameter of Head	Thickness of Head	Length	Wt. Ea. Lbs.	Chrome	Std. Pkg. Qty.	Industrial Black	Std. Pkg. Qty.	Wrench Opening
	A x B	C	D		Part No.		Part No.		
1/4 x 5/16	19/32 x 3/4	5/32	4 1/2	.03	1020	6	BLK1020	6	1/4 x 5/16
5/16 x 1/2	19/32 x 3/4	5/32	4 1/2	.04	1720	6	BLK1720	6	5/16 x 1/2
5/16 x 3/8	19/32 x 3/4	5/32	4 1/2	.04	1721	6	BLK1721	6	5/16 x 3/8
5/16 x 19/32	19/32 x 3/4	5/32	4 1/2	.04	1021	6	BLK1021	6	5/16 x 19/32
3/8 x 7/16	3/4 x 29/32	13/64	4 7/8	.06	1723	6	BLK1723	6	3/8 x 7/16
3/8 x 1/2	3/4 x 29/32	13/64	4 7/8	.06	1723A	6	BLK1723A	6	3/8 x 1/2
7/16 x 1/2	29/32 x 1 1/8	1/4	5 3/4	.13	1725	6	BLK1725	6	7/16 x 1/2
7/16 x 9/16	29/32 x 1 1/8	1/4	5 3/4	.13	1725A	6	BLK1725A	6	7/16 x 9/16
1/2 x 9/16	1 1/16 x 1 1/8	1/4	6 1/8	.19	1725B	6	BLK1725B	6	1/2 x 9/16
1/2 x 5/8	1 1/4 x 1 3/8	1/4	6 1/8	.32	1726	6	BLK1726	6	1/2 x 5/8
9/16 x 5/8	1 1/8 x 1 1/4	17/64	6 3/4	.20	1727	6	BLK1727	6	9/16 x 5/8
9/16 x 1 1/16	1 1/16 x 1 1/16	19/64	7 1/2	.27	1027C	6	BLK1027C	6	9/16 x 1 1/16
19/32 x 1 1/16	1 1/16 x 1 1/16	19/64	7 1/2	.27	1027	6	BLK1027	6	19/32 x 1 1/16
5/8 x 1 1/16	1 1/16 x 1 1/16	19/64	7 1/2	.27	1027B	6	BLK1027B	6	5/8 x 1 1/16
9/16 x 3/4	1 1/16 x 1 1/2	19/64	7 1/2	.41	1728	6	BLK1728	6	9/16 x 3/4
5/8 x 3/4	1 1/16 x 1 3/8	5/16	8 1/2	.41	1729	6	BLK1729	6	5/8 x 3/4
1 1/16 x 3/4	1 1/16 x 1 3/8	5/16	8 1/2	.41	1029B	6	BLK1029B	6	1 1/16 x 3/4
1 1/16 x 29/32	1 1/16 x 1 3/8	5/16	8 1/2	.41	1029	6	BLK1029	6	1 1/16 x 29/32
1 1/16 x 13/16	1 1/16 x 1 3/8	5/16	8 1/2	.40	1029C	6	BLK1029C	6	1 1/16 x 13/16
1 1/16 x 7/8	1 1/16 x 1 3/8	5/16	8 1/2	.40	1030	6	BLK1030	6	1 1/16 x 7/8
3/4 x 19/16	1 5/8 x 1 3/4	11/32	9 5/8	.50	1731	6	BLK1731	6	3/4 x 19/16
3/4 x 7/8	1 5/8 x 1 3/4	11/32	9 5/8	.50	1731A	6	BLK1731A	6	3/4 x 7/8
19/16 x 7/8	1 5/8 x 1 3/4	11/32	9 5/8	.50	1731B	6	BLK1731B	6	19/16 x 7/8
7/8 x 19/16	1 11/16 x 1 19/16	3/8	10 3/8	.75	1033A	6	BLK1033A	6	7/8 x 19/16
7/8 x 1	1 11/16 x 1 19/16	3/8	10 3/8	.72	1733	6	BLK1733	6	7/8 x 1
19/16 x 1	1 7/8 x 2 1/8	7/16	11 1/2	1.05	1033C	6	BLK1033C	6	19/16 x 1
7/8 x 1 1/16	1 7/8 x 2 1/8	7/16	11 1/2	1.03	1034	6	BLK1034	6	7/8 x 1 1/16
15/16 x 1 1/16	1 7/8 x 2 1/8	7/16	11 1/2	1.01	1034A	6	BLK1034A	6	15/16 x 1 1/16
1 x 1 1/8	2 1/8 x 2 1/4	7/16	12 1/2	1.18	1735	6	BLK1735	6	1 x 1 1/8
1 1/16 x 1 1/8	2 1/8 x 2 1/4	7/16	12 1/2	1.16	1036B	6	BLK1036B	6	1 1/16 x 1 1/8
1 1/16 x 1 1/4	2 1/4 x 2 3/8	1/2	13 3/4	1.6	1037	6	BLK1037	6	1 1/16 x 1 1/4
1 1/8 x 1 1/4	2 1/4 x 2 3/8	1/2	13 3/4	1.6	1737	6	BLK1737	6	1 1/8 x 1 1/4
1 1/8 x 1 1/8	2 1/4 x 2 3/8	1/2	13 3/4	1.6	1037A	6	BLK1037A	6	1 1/8 x 1 1/8
1 1/4 x 1 1/8	2 3/4 x 2 3/8	9/16	15 1/2	2.1	1039B	6	BLK1039B	1	1 1/4 x 1 1/8
1 1/4 x 1 1/16	2 3/4 x 2 3/8	9/16	15 1/2	2.1	1039	6	BLK1039	1	1 1/4 x 1 1/16
1 5/16 x 1 1/2	2 3/4 x 2 3/8	9/16	15 1/2	2.1	1039A	6	BLK1039A	1	1 5/16 x 1 1/2
1 3/8 x 1 1/16	2 3/4 x 2 3/8	9/16	15 1/2	2.0	1039C	6	BLK1039C	1	1 3/8 x 1 1/16
1 1/4 x 1 1/8	2 3/4 x 2 3/8	9/16	15 1/2	2.0	1040	6	BLK1040	1	1 1/4 x 1 1/8
1 7/16 x 1 3/8	2 3/4 x 3 1/4	5/8	17	3.1	1041	1	BLK1041	1	1 7/16 x 1 3/8
1 7/8 x 1 3/8	2 3/4 x 3 1/4	5/8	17	3.1	1041B	1	BLK1041B	1	1 7/8 x 1 3/8
1 11/16 x 1 7/8	3 3/4 x 4 1/8	7/8	19 1/2	7.2	—	—	BLK44A	1	1 11/16 x 1 7/8
1 13/16 x 2	3 3/4 x 4 1/8	7/8	19 1/2	6.9	—	—	BLK45	1	1 13/16 x 2
2 5/16 x 2 3/8	4 9/16 x 4 7/8	1 1/8	23	11.8	—	—	BLK49	1	2 5/16 x 2 3/8
2 1/4 x 2 1/16	4 9/16 x 4 7/8	1 1/8	23	11.7	—	—	BLK49A	1	2 1/4 x 2 1/16



Double Head Open End Wrench Sets

6 Sets of Popular Sizes Provide a Wide Range of Openings in Chrome or Industrial Black Finish.

Chrome Sets					
OE6K		OE8K		OE11K	
OPENING	PART NO.	OPENING	PART NO.	OPENING	PART NO.
3/8 x 7/16	1723	1/4 x 5/16	1020	1/4 x 5/16	1020
1/2 x 9/16	1725B	3/8 x 7/16	1723	5/16 x 3/8	1721
5/8 x 11/16	1027B	1/2 x 9/16	1725B	3/8 x 7/16	1723
3/4 x 13/16	1731	5/8 x 11/16	1027B	7/16 x 1/2	1725
7/8 x 15/16	1033A	3/4 x 13/16	1731	1/2 x 9/16	1725B
1 x 1 1/8	1735	7/8 x 15/16	1033A	9/16 x 5/8	1727
Kit Bag	C60B	1 x 1 1/8	1735	5/8 x 11/16	1027B
		1 1/8 x 1 1/4	1037	3/4 x 13/16	1731
		Kit Bag	C81	7/8 x 15/16	1033A
				1 x 1 1/8	1735
				1 1/8 x 1 1/4	1037
				Kit Bag	C110
Industrial Black Sets					
BOE6K		BOE8K		BOE11K	
OPENING	PART NO.	OPENING	PART NO.	OPENING	PART NO.
3/8 x 7/16	BLK1723	1/4 x 5/16	BLK-1020	1/4 x 5/16	BLK-1020
1/2 x 9/16	BLK1725B	3/8 x 7/16	BLK1723	5/16 x 3/8	BLK1721
5/8 x 11/16	BLK1027B	1/2 x 9/16	BLK1725B	3/8 x 7/16	BLK1723
3/4 x 13/16	BLK1731	5/8 x 11/16	BLK1027B	7/16 x 1/2	BLK1725
7/8 x 15/16	BLK1033A	3/4 x 13/16	BLK1731	1/2 x 9/16	BLK1725B
1 x 1 1/8	BLK1735	7/8 x 15/16	BLK1033A	9/16 x 5/8	BLK1727
Kit Bag	C60B	1 x 1 1/8	BLK1735	5/8 x 11/16	BLK1027B
		1 1/8 x 1 1/4	BLK1037	3/4 x 13/16	BLK1731
		Kit Bag	C81	7/8 x 15/16	BLK1033A
				1 x 1 1/8	BLK1735
				1 1/8 x 1 1/4	BLK1037
				Kit Bag	C110

TOOLS

Double Offset Box Wrenches

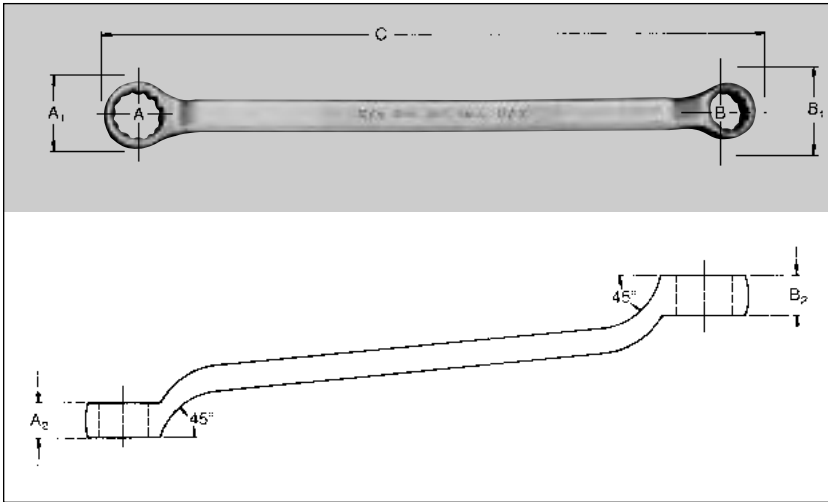

American Alloy Steel
Drop Forged
12 Point Box
**Double Offset 45° for
Obstruction Clearance**
Different Opening in Each End.

Short Pattern										
Wrench Opening	Diameter of Head		Thickness of Head		Length	Wt. Ea. Lbs.	Chrome	Industrial Black	Std. Pkg. Qty.	Wrench Opening
	A x B	A ₁	B ₁	A ₂			B ₂	Part No.		Part No.
5/16 x 3/8	15/32	35/64	7/32	1/4	4 1/4	.06	9721	BLK9721	6	5/16 x 3/8
3/8 x 7/16	17/32	5/8	17/64	5/16	4 3/8	.08	9723	BLK9723	6	3/8 x 7/16
7/16 x 1/2	5/8	23/32	5/16	11/32	5 1/16	.10	9725	BLK9725	6	7/16 x 1/2
1/2 x 9/16	23/32	13/16	11/32	3/8	5 1/2	.13	9725B	BLK9725B	6	1/2 x 9/16
9/16 x 5/8	13/16	7/8	3/8	7/16	5 15/16	.19	9727	BLK9727	6	9/16 x 5/8
5/8 x 11/16	7/8	1 1/32	7/16	15/32	6 1/2	.26	9727A	BLK9727A	6	5/8 x 11/16
5/8 x 3/4	7/8	1 1/32	7/16	15/32	6 1/2	.25	9729	BLK9729	6	5/8 x 3/4

Long Pattern										
Wrench Opening	Diameter of Head		Thickness of Head		Length	Wt. Ea. Lbs.	Chrome	Industrial Black	Std. Pkg. Qty.	Wrench Opening
	A x B	A ₁	B ₁	A ₂			B ₂	Part No.		Part No.
3/8 x 7/16	17/32	19/32	9/32	9/32	6 15/32	.15	8723	BLK8723	6	3/8 x 7/16
7/16 x 1/2	5/8	11/16	5/16	5/16	7 1/4	.16	8725	BLK8725	6	7/16 x 1/2
1/2 x 9/16	11/16	13/16	3/8	3/8	8 5/8	.25	8725B	BLK8725B	6	1/2 x 9/16
9/16 x 5/8	25/32	7/8	3/8	3/8	9 1/2	.34	8727	BLK8727	6	9/16 x 5/8
5/8 x 11/16	7/8	31/32	13/32	13/32	10 9/16	.37	8727A	BLK8727A	6	5/8 x 11/16
5/8 x 3/4	7/8	1 1/32	29/64	29/64	11 1/16	.43	8729	BLK8729	6	5/8 x 3/4
11/16 x 3/4	1 1/32	1 1/32	15/32	15/32	11 7/8	.56	8029B	BLK8029B	6	11/16 x 3/4
3/4 x 7/8	1 1/32	13/16	1/2	1/2	12 3/16	.68	8731A	BLK8731A	6	3/4 x 7/8
13/16 x 7/8	1 1/32	1 1/32	17/32	17/32	13 3/16	.74	8731B	BLK8731B	6	13/16 x 7/8
7/8 x 15/16	1 1/16	1 1/32	9/16	9/16	14 1/16	1.0	8033A	BLK8033A	6	7/8 x 15/16
15/16 x 1	1 1/16	1 1/32	9/16	9/16	14 1/16	1.0	8033C	BLK8033C	6	15/16 x 1
1 x 1 1/16	1 1/32	1 1/32	21/32	21/32	15 3/16	1.4	8735	BLK8735	6	1 x 1 1/16
1 1/16 x 1 1/8	1 1/32	1 1/32	21/32	21/32	15 3/16	1.4	8735A	BLK8735A	6	1 1/16 x 1 1/8
1 1/8 x 1 1/4	1 1/16	1 1/16	11/16	11/16	17 3/16	1.8	8037	BLK8037	1	1 1/8 x 1 1/4
1 1/8 x 1 5/16	1 1/16	1 1/16	11/16	11/16	17 3/16	1.8	8037A	BLK8037A	1	1 1/8 x 1 5/16
1 1/4 x 1 1/2	1 1/2	2 1/16	3/4	3/4	18 3/8	2.4	8039B	BLK8039B	1	1 1/4 x 1 1/2
1 1/4 x 1 7/16	1 1/2	2 1/16	3/4	3/4	18 3/8	2.4	8039	BLK8039	1	1 1/4 x 1 7/16
1 5/16 x 1 1/2	2	2 1/16	25/32	13/16	20 1/16	2.8	8040A	BLK8040A	1	1 5/16 x 1 1/2
1 3/8 x 1 7/16	2	2 1/16	25/32	13/16	20 1/16	2.8	8040C	BLK8040C	1	1 3/8 x 1 7/16
1 3/8 x 1 1/2	2	2 1/16	25/32	13/16	20 1/16	2.8	8040	BLK8040	1	1 3/8 x 1 1/2
1 7/16 x 1 1/2	2	2 1/16	25/32	13/16	20 1/16	2.8	8040B	BLK8040B	1	1 7/16 x 1 1/2

TOOLS

Chrome Sets

BO6K



$\frac{3}{8} \times \frac{7}{16}$	8723
$\frac{7}{16} \times \frac{1}{2}$	8725
$\frac{1}{2} \times \frac{9}{16}$	8725B
$\frac{9}{16} \times \frac{5}{8}$	8727
$1\frac{1}{16} \times \frac{3}{4}$	8029B
$1\frac{3}{16} \times \frac{7}{8}$	8731B
Kit Bag	C60B

BO11K



$\frac{3}{8} \times \frac{7}{16}$	8723
$\frac{7}{16} \times \frac{1}{2}$	8725
$\frac{1}{2} \times \frac{9}{16}$	8725B
$\frac{9}{16} \times \frac{5}{8}$	8727
$\frac{5}{8} \times 1\frac{1}{16}$	8727A
$1\frac{1}{16} \times \frac{3}{4}$	8029B
$1\frac{3}{16} \times \frac{7}{8}$	8731B
$1\frac{5}{16} \times 1$	8033C
$1\frac{1}{16} \times 1\frac{1}{8}$	8735A
$1\frac{1}{16} \times 1\frac{1}{4}$	8037
$1\frac{1}{4} \times 1\frac{3}{16}$	8039B
Kit Bag	C110

Industrial Black Sets

BBO6K



$\frac{3}{8} \times \frac{7}{16}$	BLK8723
$\frac{7}{16} \times \frac{1}{2}$	BLK8725
$\frac{1}{2} \times \frac{9}{16}$	BLK8725B
$\frac{9}{16} \times \frac{5}{8}$	BLK8727
$1\frac{1}{16} \times \frac{3}{4}$	BLK8029B
$1\frac{3}{16} \times \frac{7}{8}$	BLK8731B
Kit Bag	C60B

BBO11K



$\frac{3}{8} \times \frac{7}{16}$	BLK8723
$\frac{7}{16} \times \frac{1}{2}$	BLK8725
$\frac{1}{2} \times \frac{9}{16}$	BLK8725B
$\frac{9}{16} \times \frac{5}{8}$	BLK8727
$\frac{5}{8} \times 1\frac{1}{16}$	BLK8727A
$1\frac{1}{16} \times \frac{3}{4}$	BLK8029B
$1\frac{3}{16} \times \frac{7}{8}$	BLK8731B
$1\frac{5}{16} \times 1$	BLK8033C
$1\frac{1}{16} \times 1\frac{1}{8}$	BLK8735A
$1\frac{1}{16} \times 1\frac{1}{4}$	BLK8037
$1\frac{1}{4} \times 1\frac{3}{16}$	BLK8039B
Kit Bag	C110

Hydraulic Wrenches Angle Openings SAE & Metric

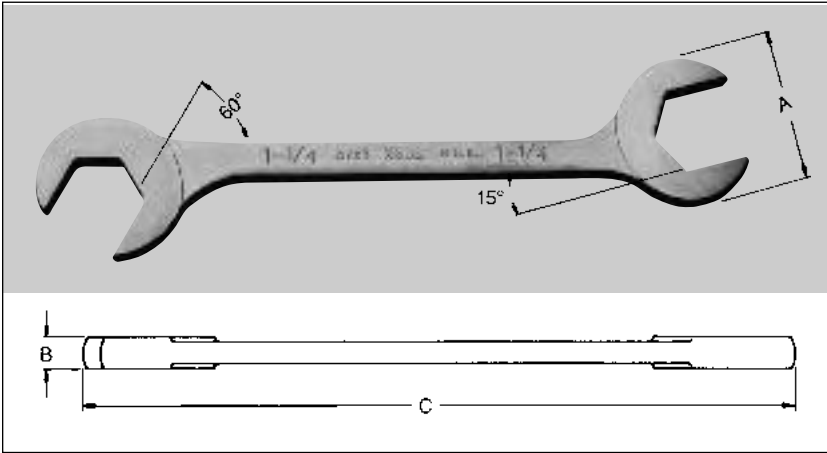

**American Alloy Steel
Drop Forged**

**Permits Work in Extremely
Tight Clearance**

Thin Head

Same Opening Each End

Wrench Openings	Diameter of Head		Length C	Wt. Ea. Lbs.	Chrome	Industrial Black	Std. Pkg. Qty.	Wrench Openings
	A	B			Part No.	Part No.		
1/32 X 1/32	0.78	0.22	4.75	.07	3710A	BLK3710A	6	1/32 X 1/32
3/16 X 3/16	0.78	0.22	4.75	.07	3710	BLK3710	6	3/16 X 3/16
1/8 X 1/8	0.88	0.22	5.00	.08	3711	BLK3711	6	1/8 X 1/8
1/4 X 1/4	1.00	0.22	5.50	.10	3712	BLK3712	6	1/4 X 1/4
5/16 X 5/16	1.12	0.25	6.00	.12	3713	BLK3713	6	5/16 X 5/16
3/8 X 3/8	1.19	0.28	6.25	.18	3714	BLK3714	6	3/8 X 3/8
1/2 X 1/2	1.31	0.28	7.00	.22	3715	BLK3715	6	1/2 X 1/2
5/8 X 5/8	1.44	0.28	7.25	.24	3716	BLK3716	6	5/8 X 5/8
3/4 X 3/4	1.59	0.28	7.50	.29	3717	BLK3717	6	3/4 X 3/4
7/8 X 7/8	1.69	0.28	8.25	.35	3718	BLK3718	6	7/8 X 7/8
1 X 1	1.81	0.25	9.00	.38	3719	BLK3719	6	1 X 1
1 1/8 X 1 1/8	1.94	0.31	9.75	.52	3720	BLK3720	6	1 X 1
1 1/4 X 1 1/4	2.06	0.31	10.00	.60	3721	BLK3721	6	1 1/4 X 1 1/4
1 1/2 X 1 1/2	2.25	0.31	11.00	.75	3722	BLK3722	6	1 1/2 X 1 1/2
1 3/4 X 1 3/4	2.25	0.31	11.00	.74	3722A	BLK3722A	6	1 3/4 X 1 3/4
2 X 2	2.38	0.34	11.50	.83	3723	BLK3723	6	1 3/4 X 1 3/4
2 1/4 X 2 1/4	2.66	0.41	12.50	1.2	3724	BLK3724	6	2 X 2
2 1/2 X 2 1/2	2.66	0.41	12.50	1.2	3725	BLK3725	6	2 1/2 X 2 1/2
3 X 3	2.66	0.41	12.50	1.2	3726	BLK3726	6	3 X 3
3 1/2 X 3 1/2	3.19	0.47	15.75	3.0	3727	BLK3727	1	3 1/2 X 3 1/2
4 X 4	3.31	0.50	16.50	3.4	3728	BLK3728	1	4 X 4
4 1/2 X 4 1/2	3.44	0.53	17.00	3.8	3729	BLK3729	1	4 1/2 X 4 1/2
5 X 5	3.56	0.53	17.75	4.5	3730	BLK3730	1	5 X 5
5 1/2 X 5 1/2	3.69	0.56	18.50	5.2	3731	BLK3731	1	5 1/2 X 5 1/2
6 X 6	3.94	0.59	19.25	5.9	3732	BLK3732	1	6 X 6

Wrench Openings	Diameter of Head		Length C	Wt. Ea. Lbs.	Chrome	Std. Pkg. Qty.	Wrench Openings
	A	B			Part No.		
9 mm	19.8	5.6	120.7	.07	3709 MM	6	9 mm
10 mm	19.8	5.6	120.7	.07	3710 MM	6	10 mm
11 mm	22.4	5.6	127.0	.08	3711 MM	6	11 mm
12 mm	22.4	5.6	127.0	.08	3712 MM	6	12 mm
13 mm	25.4	5.6	139.7	.10	3713 MM	6	13 mm
14 mm	28.4	6.4	152.4	.12	3714 MM	6	14 mm
15 mm	28.4	6.4	152.4	.12	3715 MM	6	15 mm
16 mm	30.2	7.1	158.8	.18	3716 MM	6	16 mm
17 mm	30.2	7.1	158.8	.18	3717 MM	6	17 mm
18 mm	33.3	7.1	177.8	.22	3718 MM	6	18 mm
19 mm	36.6	7.1	184.2	.24	3719 MM	6	19 mm
20 mm	36.6	7.1	184.2	.24	3720 MM	6	20 mm
21 mm	40.4	7.1	190.5	.29	3721 MM	6	21 mm
22 mm	40.4	7.1	190.5	.29	3722 MM	6	22 mm
23 mm	42.9	7.1	209.6	.35	3723 MM	6	23 mm
24 mm	46.0	7.1	228.6	.38	3724 MM	6	24 mm
27 mm	52.3	7.9	254.0	.52	3727 MM	6	27 mm
30 mm	57.2	7.9	279.4	.60	3730 MM	6	30 mm
32 mm	60.5	8.6	292.1	.83	3732 MM	6	32 mm
34 mm	67.6	10.4	317.5	1.2	3734 MM	6	34 mm
36 mm	67.6	10.4	317.5	1.2	3736 MM	6	36 mm

TOOLS



Hydraulic Wrench Sets Angle Openings SAE & Metric

Convenient Angle Wrench Sets Keep Popular Sizes in Handy, Easy to Carry Roll Bags. 8 Sets Provide the Full Range of Openings in Chrome or Industrial Black Finish.

Chrome Sets SAE & Metric							
OB7K		OB11K		OB15K		OB18K	
OPENING	PART NO.	OPENING	PART NO.	OPENING	PART NO.	OPENING	PART NO.
OB7K		OB11K		OB15K		OB18K	
3/8 x 3/8	3710	3/8 x 3/8	3710	3/8 x 3/8	3710	1 1/32 x 1 1/32	3710A
7/16 x 7/16	3711	7/16 x 7/16	3711	7/16 x 7/16	3711	3/8 x 3/8	3710
1/2 x 1/2	3712	1/2 x 1/2	3712	1/2 x 1/2	3712	7/16 x 7/16	3711
9/16 x 9/16	3713	9/16 x 9/16	3713	9/16 x 9/16	3713	1/2 x 1/2	3712
5/8 x 5/8	3714	5/8 x 5/8	3714	5/8 x 5/8	3714	9/16 x 9/16	3713
1 1/16 x 1 1/16	3715	1 1/16 x 1 1/16	3715	1 1/16 x 1 1/16	3715	5/8 x 5/8	3714
3/4 x 3/4	3716	3/4 x 3/4	3716	3/4 x 3/4	3716	1 1/16 x 1 1/16	3715
Roll Bag	C70	1 3/16 x 1 3/16	3717	1 3/16 x 1 3/16	3717	3/4 x 3/4	3716
OB7KMM		OB11KMM		OB15KMM		OB18KMM	
10mm	3710MM	10mm	3710MM	10mm	3710MM	9mm	3709MM
11mm	3711MM	11mm	3711MM	11mm	3711MM	10mm	3710MM
12mm	3712MM	12mm	3712MM	12mm	3712MM	11mm	3711MM
13mm	3713MM	13mm	3713MM	13mm	3713MM	12mm	3712MM
14mm	3714MM	14mm	3714MM	14mm	3714MM	13mm	3713MM
15mm	3715MM	15mm	3715MM	15mm	3715MM	14mm	3714MM
16mm	3716MM	16mm	3716MM	16mm	3716MM	15mm	3715MM
Roll Bag	C70	16mm	3716MM	17mm	3717MM	16mm	3716MM
		17mm	3717MM	18mm	3718MM	17mm	3717MM
		18mm	3718MM	19mm	3719MM	18mm	3718MM
		19mm	3719MM	21mm	3721MM	19mm	3719MM
		21mm	3721MM	22mm	3722MM	21mm	3721MM
		22mm	3722MM	24mm	3724MM	22mm	3722MM
		24mm	3724MM	27mm	3727MM	24mm	3724MM
		27mm	3727MM	30mm	3730MM	27mm	3727MM
		30mm	3730MM	Roll Bag	C180	32mm	3732MM
		Roll Bag	C180			34mm	3734MM
						36mm	3736MM
						Roll Bag	C180

Industrial Black Sets							
BOB7K		BOB11K		BOB15K		BOB18K	
OPENING	PART NO.	OPENING	PART NO.	OPENING	PART NO.	OPENING	PART NO.
BOB7K		BOB11K		BOB15K		BOB18K	
3/8 x 3/8	BLK3710	3/8 x 3/8	BLK3710	3/8 x 3/8	BLK3710	1 1/32 x 1 1/32	BLK3710A
7/16 x 7/16	BLK3711	7/16 x 7/16	BLK3711	7/16 x 7/16	BLK3711	3/8 x 3/8	BLK3710
1/2 x 1/2	BLK3712	1/2 x 1/2	BLK3712	1/2 x 1/2	BLK3712	7/16 x 7/16	BLK3711
9/16 x 9/16	BLK3713	9/16 x 9/16	BLK3713	9/16 x 9/16	BLK3713	1/2 x 1/2	BLK3712
5/8 x 5/8	BLK3714	5/8 x 5/8	BLK3714	5/8 x 5/8	BLK3714	9/16 x 9/16	BLK3713
1 1/16 x 1 1/16	BLK3715	1 1/16 x 1 1/16	BLK3715	1 1/16 x 1 1/16	BLK3715	5/8 x 5/8	BLK3714
3/4 x 3/4	BLK3716	3/4 x 3/4	BLK3716	3/4 x 3/4	BLK3716	1 1/16 x 1 1/16	BLK3715
Roll Bag	C70	1 3/16 x 1 3/16	BLK3717	1 3/16 x 1 3/16	BLK3717	3/4 x 3/4	BLK3716
		7/8 x 7/8	BLK3718	7/8 x 7/8	BLK3718	1 1/16 x 1 1/16	BLK3717
		1 5/16 x 1 5/16	BLK3719	1 5/16 x 1 5/16	BLK3719	1/2 x 1/2	BLK3718
		1 x 1	BLK3720	1 x 1	BLK3720	9/16 x 9/16	BLK3719
		Roll Bag	C111	1 1/8 x 1 1/8	BLK3721	1 x 1	BLK3720
				1 1/4 x 1 1/4	BLK3722	1 1/8 x 1 1/8	BLK3721
				1 3/8 x 1 3/8	BLK3722A	1 1/4 x 1 1/4	BLK3722
				1 1/2 x 1 1/2	BLK3723	1 3/8 x 1 3/8	BLK3723
				Roll Bag	C180	1 3/4 x 1 3/4	BLK3724
						1 7/8 x 1 7/8	BLK3725
						1 1/2 x 1 1/2	BLK3726
						Roll Bag	C180

TOOLS

Service Wrenches SAE & Metric

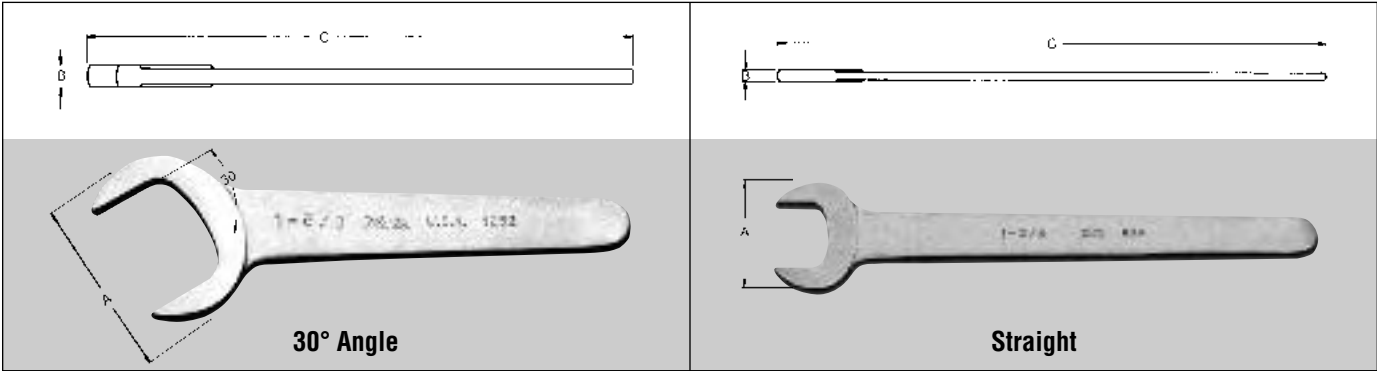

30° Angle Service Wrenches

Wrench Opening	Diameter of Head	Thickness of Head	Length	Wt. Ea. Lbs.	Chrome	Industrial Black	Std. Pkg. Qty.	Wrench Opening
	A	B			Part No.	Part No.		
3/4	1 1/16	1/4	6 5/16	.22	1224	BLK-1224	6	3/4
13/16	1 1/16	1/4	6 5/16	.22	1226	BLK1226	6	13/16
7/8	1 1/16	1/4	6 5/16	.22	1228	BLK1228	6	7/8
15/16	1 1/8	1/4	6 5/8	.25	1230	BLK-1230	6	15/16
1	1 1/8	1/4	6 5/8	.25	1232	BLK1232	6	1
1 1/16	1 1/8	1/4	6 5/8	.25	1234	BLK1234	6	1 1/16
1 1/8	2 1/16	1/4	7 1/16	.31	1236	BLK1236	6	1 1/8
1 3/16	2 1/16	1/4	7 1/8	.31	1238	BLK1238	6	1 3/16
1 1/4	2 1/8	1/4	7 1/8	.30	1240	BLK1240	6	1 1/4
1 3/8	2 1/8	1/4	7 1/8	.30	1236S	BLK1236S	6	1 3/8
1 5/8	2 1/2	3/32	7 1/16	.45	1242	BLK1242	6	1 5/8
1 3/4	2 1/2	3/32	7 1/16	.44	1244	BLK1244	6	1 3/4
1 7/8	2 1/2	3/32	7 1/16	.43	1246	BLK1246	6	1 7/8
1 1/2	2 1/2	3/32	7 1/16	.42	1248	BLK1248	6	1 1/2
1 9/16	2 5/8	3/32	7 5/16	.43	1250	BLK1250	6	1 9/16
1 5/8	2 5/8	3/32	7 5/16	.43	1252	BLK1252	6	1 5/8
1 11/16	2 5/8	3/32	7 5/16	.42	1254	BLK1254	6	1 11/16
1 3/4	3 3/8	5/16	8 7/16	.70	1256	BLK1256	6	1 3/4
1 13/16	3 3/8	5/16	8 7/16	.69	1258	BLK1258	6	1 13/16
1 7/8	3 3/8	5/16	8 7/16	.69	1260	BLK1260	6	1 7/8
1 15/16	3 3/8	5/16	8 7/16	.68	1262	BLK1262	6	1 15/16
2	3 1/2	5/16	9 1/2	.66	1264	BLK1264	6	2
2 1/8	3 1/2	5/16	9 1/2	.65	1268	BLK1268	6	2 1/8
2 1/4	3 1/2	5/16	9 1/2	.61	1272	BLK1272	6	2 1/4
2 3/8	3 1/2	5/16	9 1/2	.61	1276	BLK1276	6	2 3/8
2 1/2	3 1/2	5/16	9 1/2	.59	1272S	BLK1272S	6	2 1/2
2 5/8	3 1/2	5/16	9 1/2	.57	1264S	BLK1264S	6	2 5/8

Chrome Set 30°

SW11K

	CHROME OPENING	BLACK PART NO.	BLACK PART NO.
3/4	1224	BLK-1224	
13/16	1226	BLK1226	
7/8	1228	BLK1228	
15/16	1230	BLK-1230	
1	1232	BLK1232	
1 1/16	1234	BLK1234	
1 1/8	1236	BLK1236	
1 3/16	1238	BLK1238	
1 1/4	1240	BLK1240	
1 3/8	1244	BLK1244	
1 1/2	1248	BLK1248	
Kit Bag		C111	

Industrial Black Set 30°

BSW11K

Straight Service Wrenches

Wrench Opening	Diameter of Head	Thickness of Head	Length	Wt. Ea. Lbs.	Chrome	Std. Pkg. Qty.	Wrench Opening
	A	B			Part No.		
1	2 1/2	1/4	12 1/4	.77	1932	6	1
1 1/8	2 1/2	1/4	12 1/4	.73	1936	6	1 1/8
1 1/2	2 5/8	3/32	12 1/4	.93	1948	6	1 1/2
1 3/8	2 5/8	3/32	12 1/4	.92	1952	6	1 3/8
1 1/4	3 1/16	5/16	12 1/4	1.3	1956	6	1 1/4
2	3 1/16	5/16	12 1/4	1.3	1964	6	2
2 1/4	3 1/16	5/16	12 1/4	1.3	1972	6	2 1/4

TOOLS

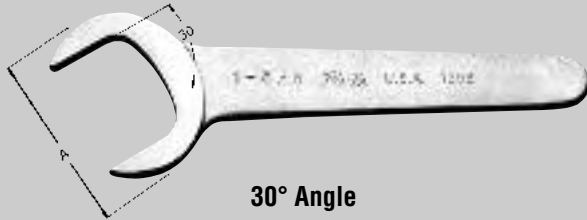
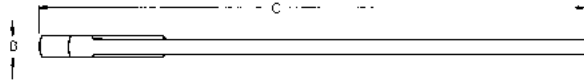

30° Angle

- Pump Wrenches - Chrome
- Thin Pattern for Use on Jam Nuts and in Confined Areas
- 30° Angle Heads

30° Angle Service Wrenches

Wrench Opening	Diameter of Head	Thickness of Head	Length	Wt. Ea. Lbs.	Chrome	Std. Pkg. Qty.	Wrench Opening	Chrome Set 30°																																														
	A	B	C		Part No.																																																	
19 mm	42.86 mm	6.35 mm	160.27 mm	.22	1219 mm	6	19 mm	SW11KM																																														
21 mm	42.86 mm	6.35 mm	160.27 mm	.22	1221 mm	6	21 mm																																															
22 mm	42.86 mm	6.35 mm	160.27 mm	.22	1222 mm	6	22 mm																																															
24 mm	47.62 mm	6.35 mm	174.75 mm	.25	1224 mm	6	24 mm																																															
27 mm	47.62 mm	6.35 mm	174.75 mm	.25	1227 mm	6	27 mm																																															
30 mm	52.38 mm	6.35 mm	182.62 mm	.31	1230 mm	6	30 mm																																															
32 mm	52.38 mm	6.35 mm	182.62 mm	.30	1232 mm	6	32 mm	<table border="0"> <thead> <tr> <th>OPENING</th> <th>CHROME PART NO.</th> </tr> </thead> <tbody> <tr><td>19 mm</td><td>1219 mm</td></tr> <tr><td>21 mm</td><td>1221 mm</td></tr> <tr><td>22 mm</td><td>1222 mm</td></tr> <tr><td>24 mm</td><td>1224 mm</td></tr> <tr><td>27 mm</td><td>1227 mm</td></tr> <tr><td>30 mm</td><td>1230 mm</td></tr> <tr><td>32 mm</td><td>1232 mm</td></tr> <tr><td>36 mm</td><td>1236 mm</td></tr> <tr><td>37 mm</td><td>1237 mm</td></tr> <tr><td>38 mm</td><td>1238 mm</td></tr> <tr><td>40 mm</td><td>1240 mm</td></tr> <tr><td>41 mm</td><td>1241 mm</td></tr> <tr><td>42 mm</td><td>1242 mm</td></tr> <tr><td>44 mm</td><td>1244 mm</td></tr> <tr><td>46 mm</td><td>1246 mm</td></tr> <tr><td>48 mm</td><td>1248 mm</td></tr> <tr><td>50 mm</td><td>1250 mm</td></tr> <tr><td>52 mm</td><td>1252 mm</td></tr> <tr><td>55 mm</td><td>1255 mm</td></tr> <tr><td>60 mm</td><td>1260 mm</td></tr> <tr><td>65 mm</td><td>1265 mm</td></tr> <tr><td>Kit Bag</td><td>C111</td></tr> </tbody> </table>	OPENING	CHROME PART NO.	19 mm	1219 mm	21 mm	1221 mm	22 mm	1222 mm	24 mm	1224 mm	27 mm	1227 mm	30 mm	1230 mm	32 mm	1232 mm	36 mm	1236 mm	37 mm	1237 mm	38 mm	1238 mm	40 mm	1240 mm	41 mm	1241 mm	42 mm	1242 mm	44 mm	1244 mm	46 mm	1246 mm	48 mm	1248 mm	50 mm	1250 mm	52 mm	1252 mm	55 mm	1255 mm	60 mm	1260 mm	65 mm	1265 mm	Kit Bag	C111
OPENING	CHROME PART NO.																																																					
19 mm	1219 mm																																																					
21 mm	1221 mm																																																					
22 mm	1222 mm																																																					
24 mm	1224 mm																																																					
27 mm	1227 mm																																																					
30 mm	1230 mm																																																					
32 mm	1232 mm																																																					
36 mm	1236 mm																																																					
37 mm	1237 mm																																																					
38 mm	1238 mm																																																					
40 mm	1240 mm																																																					
41 mm	1241 mm																																																					
42 mm	1242 mm																																																					
44 mm	1244 mm																																																					
46 mm	1246 mm																																																					
48 mm	1248 mm																																																					
50 mm	1250 mm																																																					
52 mm	1252 mm																																																					
55 mm	1255 mm																																																					
60 mm	1260 mm																																																					
65 mm	1265 mm																																																					
Kit Bag	C111																																																					
36 mm	63.49 mm	7.14 mm	195.32 mm	.45	1236 mm	6	36 mm																																															
37 mm	63.49 mm	7.14 mm	195.32 mm	.43	1237 mm	6	37 mm																																															
38 mm	63.49 mm	7.14 mm	195.32 mm	.42	1238 mm	6	38 mm																																															
40 mm	66.67 mm	7.14 mm	201.67 mm	.43	1240 mm	6	40 mm																																															
41 mm	66.67 mm	7.14 mm	201.67 mm	.43	1241 mm	6	41 mm																																															
42 mm	66.67 mm	7.14 mm	201.67 mm	.43	1242 mm	6	42 mm																																															
44 mm	66.67 mm	7.14 mm	201.67 mm	.43	1244 mm	6	44 mm																																															
46 mm	79.37 mm	7.94 mm	217.42 mm	.70	1246 mm	6	46 mm																																															
48 mm	79.37 mm	7.94 mm	217.42 mm	.70	1248 mm	6	48 mm																																															
50 mm	79.37 mm	7.94 mm	217.42 mm	.68	1250 mm	6	50 mm																																															
52 mm	88.89 mm	7.94 mm	242.06 mm	.66	1252 mm	6	52 mm																																															
55 mm	88.89 mm	7.94 mm	242.06 mm	.66	1255 mm	6	55 mm																																															
60 mm	88.89 mm	7.94 mm	242.06 mm	.61	1260 mm	6	60 mm																																															
65 mm	88.89 mm	7.94 mm	242.06 mm	.57	1265 mm	6	65 mm																																															

Check Nut Wrenches Fractional & Metric

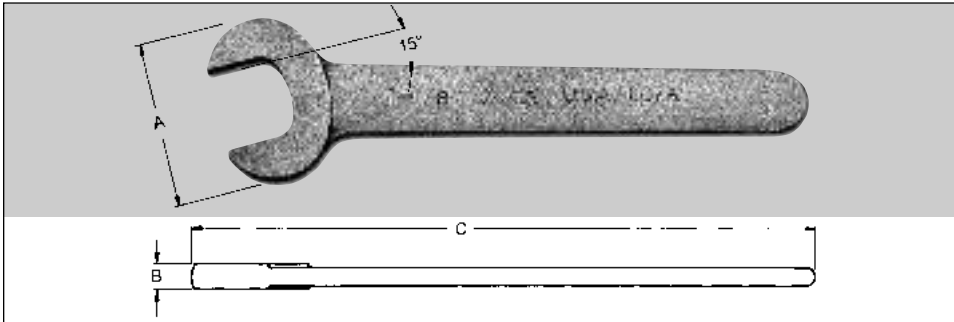

Thin Pattern
15° Angle
Use on Check Nuts, Stop Nuts, Jam Nuts, Hydraulic Fitting
Smaller Sizes Compliment Service Wrenches

Check Nut Wrench - Fractional

Wrench Opening	Diameter of Head	Thickness of Head	Length	Wt. Ea. Lbs.	Industrial Black	Std. Pkg. Qty.	Wrench Opening
	A	B			Part No.		
7/16	1	1/8	4	.05	601A	6	7/16
1/2	1	1/8	4	.05	601	6	1/2
9/16	1 1/4	5/32	4 1/2	.11	602A	6	9/16
19/32	1 1/4	5/32	4 1/2	.11	602	6	19/32
5/8	1 1/2	3/16	5 1/8	.13	603A	6	5/8
11/16	1 1/2	3/16	5 1/8	.13	603	6	11/16
3/4	1 5/8	7/32	5 3/8	.19	604A	6	3/4
13/16	1 9/16	1/4	6 1/8	.28	605A	6	13/16
7/8	1 9/16	1/4	6 1/8	.28	605	6	7/8
15/16	2	9/32	7 1/2	.36	606A	6	15/16
1	2	9/32	7 1/2	.35	606B	6	1
1 1/16	2 1/16	5/16	8 1/2	.66	607	6	1 1/16
1 1/8	2 1/8	5/16	8 1/2	.65	607A	6	1 1/8
1 1/4	2 1/4	3/8	10	1.12	608	6	1 1/4
1 3/8	2 3/8	3/8	10	1.12	608A	6	1 3/8
1 1/2	3 1/8	7/16	11 1/8	1.5	609A	6	1 1/2
1 5/8	3 5/8	1/2	13	2.3	610	6	1 5/8
1 7/8	3 7/8	1/2	13	2.2	610A	6	1 7/8

Check Nut Wrench - Metric

Wrench Opening	Diameter of Head	Thickness of Head	Length	Wt. Ea. Lbs.	Industrial Black	Std. Pkg. Qty.	Wrench Opening
	A	B			Part No.		
10 mm	25.40 mm	3.17 mm	101.59 mm	.05	610 mm	6	10 mm
11 mm	25.40 mm	3.17 mm	101.59 mm	.05	611 mm	6	11 mm
12 mm	25.40 mm	3.17 mm	101.59 mm	.05	612 mm	6	12 mm
13 mm	25.40 mm	3.17 mm	101.59 mm	.05	613 mm	6	13 mm
14 mm	31.75 mm	3.97 mm	114.29 mm	.11	614 mm	6	14 mm
15 mm	31.75 mm	3.97 mm	114.29 mm	.11	615 mm	6	15 mm
16 mm	38.10 mm	4.76 mm	130.16 mm	.13	616 mm	6	16 mm
17 mm	38.10 mm	4.76 mm	130.16 mm	.13	617 mm	6	17 mm
18 mm	38.10 mm	4.76 mm	130.16 mm	.13	618 mm	6	18 mm
19 mm	41.28 mm	5.56 mm	155.58 mm	.19	619 mm	6	19 mm
21 mm	46.03 mm	6.35 mm	168.25 mm	.28	621 mm	6	21 mm
22 mm	46.03 mm	6.35 mm	168.25 mm	.28	622 mm	6	22 mm
24 mm	50.79 mm	7.14 mm	190.48 mm	.36	624 mm	6	24 mm
27 mm	61.90 mm	7.94 mm	215.87 mm	.66	627 mm	6	27 mm
30 mm	61.90 mm	7.94 mm	215.87 mm	.66	630 mm	6	30 mm
32 mm	66.67 mm	9.52 mm	253.97 mm	1.12	632 mm	6	32 mm
36 mm	66.67 mm	9.52 mm	253.97 mm	1.12	636 mm	6	36 mm
37 mm	85.71 mm	11.11 mm	288.88 mm	1.50	637 mm	6	37 mm
38 mm	85.71 mm	11.11 mm	288.88 mm	1.50	638 mm	6	38 mm
41 mm	87.30 mm	12.70 mm	330.16 mm	2.1	641 mm	6	41 mm



Sets

CN7K

OPENING	PART NO.
7/16	601A
1/2	601
9/16	602A
5/8	603A
11/16	603
3/4	604A
13/16	605A
7/8	605
15/16	606A
1	606B
1 1/16	607
1 1/8	607A
1 1/4	608
1 3/8	608A
1 1/2	609A
1 5/8	610
1 7/8	610A
Kit Bag	C70

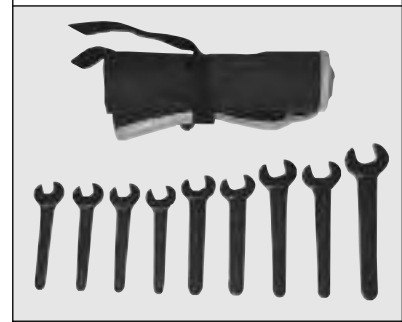

CN9KM

OPENING	PART NO.
10 mm	610 mm
11 mm	611 mm
12 mm	612 mm
13 mm	613 mm
14 mm	614 mm
15 mm	615 mm
16 mm	616 mm
17 mm	617 mm
19 mm	619 mm
Kit Bag	C90

TOOLS

American Alloy Steel

Chrome or Black Finish

12 Point Opening

Drop Forged

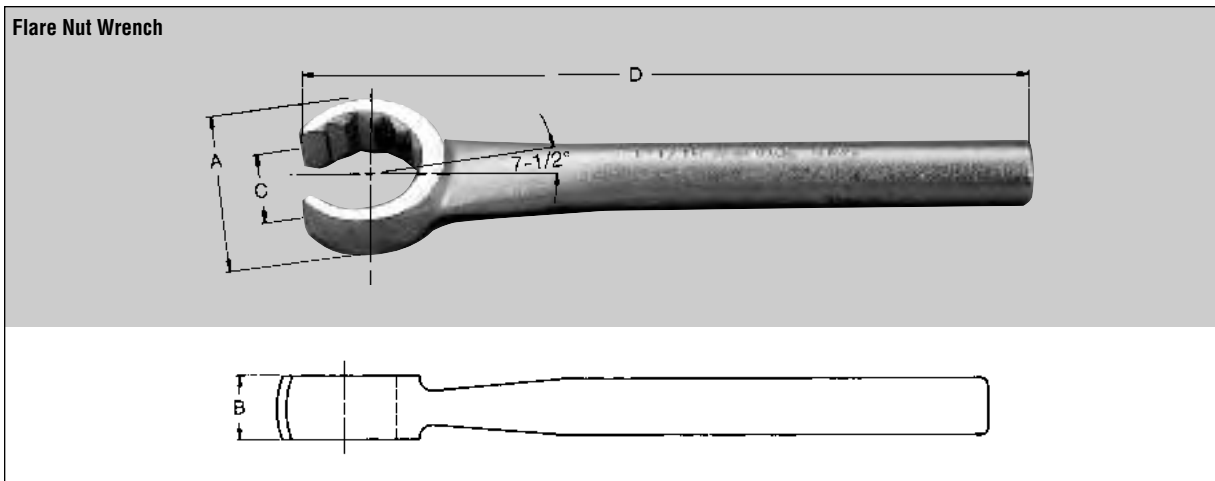

Wrench Opening	Diameter of Head	Thickness of Head	Width of Slot	Length	Wt. Ea. Lbs.	Chrome	Industrial Black	Std. Pkg. Qty.	Wrench Opening
	A	B	C	D		Part No.	Part No.		
3/8	25/32	5/16	9/32	6 1/32	.18	4112	BLK4112	6	3/8
7/16	27/32	5/16	11/32	6 15/32	.20	4114	BLK4114	6	7/16
1/2	29/32	3/8	3/8	6 25/32	.28	4116	BLK4116	6	1/2
9/16	1 1/32	7/16	7/16	6 25/32	.30	4118	BLK4118	6	9/16
5/8	1 1/16	1/2	1/2	7 1/8	.38	4120	BLK4120	6	5/8
1 1/16	1 1/8	1/2	9/16	7 3/16	.45	4122	BLK4122	6	1 1/16
3/4	1 1/32	9/16	5/8	7 1/16	.53	4124	BLK4124	6	3/4
13/16	1 7/32	5/8	21/32	7 1/2	.60	4126	BLK4126	6	13/16
7/8	1 3/8	5/8	11/16	7 1/2	.60	4128	BLK4128	6	7/8
15/16	1 7/16	5/8	3/4	7 13/16	.63	4130	BLK4130	6	15/16
1	1 9/16	11/16	3/4	7 13/16	.69	4132	BLK4132	6	1
1 1/16	1 5/8	3/4	13/16	7 15/16	.78	4134	BLK4134	6	1 1/16
1 1/8	1 11/16	25/32	7/8	7 15/16	.83	4136	BLK4136	6	1 1/8
1 1/4	1 23/32	13/16	1	7 15/16	.83	4140	BLK4140	6	1 1/4
1 3/8	2 3/32	29/32	1 1/16	9	1.3	4144	BLK4144	6	1 3/8
1 1/2	2 7/16	7/8	1 1/8	10	1.6	4148	BLK4148	6	1 1/2

TOOLS

Ratcheting Box Wrenches & Sets — Straight Pattern

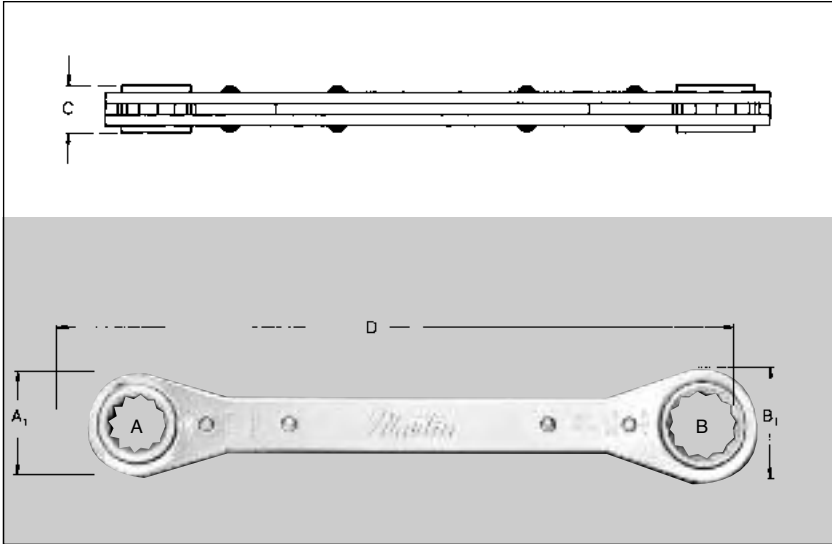

Chrome Finish

Different Openings on Each End in Size from 1/4" thru 7/8".

12 Point with 6 Point Also Available on RB810, 1214 and 1618.

Wrench Openings A x B	Type Opening	Diameter of Head		Thickness of Head	Overall Length	Wt. Ea. Lbs.	Chrome	Std. Pkg. Qty.	Wrench Openings
		A ₁	B ₁	C	D		Part No.		A x B
1/4 x 5/16	6 pt.	5/16	3/8	3/8	4 1/4	.12	RB810	6	1/4 x 5/16
1/4 x 3/8	12 pt.	5/16	3/8	3/8	4 1/4	.13	RB810DH	6	1/4 x 3/8
3/8 x 7/16	6 pt.	3/8	7/8	3/8	5 1/2	.18	RB1214	6	3/8 x 7/16
3/8 x 7/16	12 pt.	3/8	7/8	3/8	5 1/2	.19	RB1214DH	6	3/8 x 7/16
1/2 x 9/16	6 pt.	1	1 1/8	1/2	6 3/4	.42	RB1618	6	1/2 x 9/16
1/2 x 9/16	12 pt.	1	1 1/8	1/2	6 3/4	.42	RB1618DH	6	1/2 x 9/16
5/8 x 11/16	12 pt.	1 1/4	1 7/16	1/2	8	.54	RB2022	6	5/8 x 11/16
5/8 x 3/4	12 pt.	1 1/4	1 7/16	1/2	8	.52	RB2024	6	5/8 x 3/4
1 1/16 x 1 3/16	12 pt.	1 7/16	1 9/16	1/2	9 1/4	.78	RB2226	6	1 1/16 x 1 3/16
3/4 x 7/8	12 pt.	1 7/16	1 9/16	1/2	9 1/4	.74	RB2428	6	3/4 x 7/8

Sets

RB5K		RB7K			
	OPENING	PART NO.		OPENING	PART NO.
	1/4 x 5/16	RB810		1/4 x 5/16	RB810
	3/8 x 7/16	RB1214		3/8 x 7/16	RB1214
	1/2 x 9/16	RB1618		1/2 x 9/16	RB1618
	5/8 x 11/16	RB2022		5/8 x 11/16	RB2022
	5/8 x 3/4	RB2428		5/8 x 3/4	RB2024
	Kit Bag	C185		1 1/16 x 1 3/16	RB2226
			3/4 x 7/8	RB2428	
			Kit Bag	C187	

TOOLS



Ratcheting Box Wrenches & Sets —25° Offset Pattern

Chrome Finish

25° Offset

Size Openings from 1/4" thru 7/8" with Different Openings on Each End.

**RBO810 thru RBO1618
6 Point**

**RBO2022 thru RBO2428
12 Point**

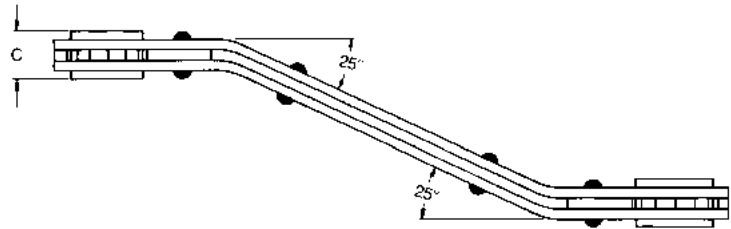

Wrench Openings A x B	Type Opening	Diameter of Head		Thickness of Head C	Overall Length D	Wt. Ea. Lbs.	Chrome	Std. Pkg. Qty.	Wrench Openings
		A ₁	B ₁				Part No.		A x B
1/4 x 5/16	6 pt.	5/16	5/8	3/8	4 3/32	.12	RBO810	6	1/4 x 5/16
3/8 x 7/16	6 pt.	5/8	7/8	3/8	5 7/32	.18	RBO1214	6	3/8 x 7/16
1/2 x 9/16	6 pt.	1	1 1/8	1/2	6 15/32	.42	RBO1618	6	1/2 x 9/16
5/8 x 1 1/16	12 pt.	1 1/4	1 7/16	1/2	7 21/32	.54	RBO2022	6	5/8 x 1 1/16
3/4 x 3/4	12 pt.	1 1/4	1 1/16	1/2	7 21/32	.52	RBO2024	6	3/4 x 3/4
1 1/16 x 1 3/16	12 pt.	1 7/16	1 1/16	1/2	8 3/4	.78	RBO2226	6	1 1/16 x 1 3/16
3/4 x 7/8	12 pt.	1 7/16	1 1/16	1/2	8 3/4	.74	RBO2428	6	3/4 x 7/8

Sets

RBO5K		RBO7K		
	OPENING	PART NO.	OPENING	PART NO.
	1/4 x 5/16	RBO810	1/4 x 5/16	RBO810
	3/8 x 7/16	RBO1214	3/8 x 7/16	RBO1214
	1/2 x 9/16	RBO1618	1/2 x 9/16	RBO1618
	5/8 x 1 1/16	RBO2022	5/8 x 1 1/16	RBO2022
	3/4 x 3/4	RBO2024	3/4 x 3/4	RBO2024
	Kit Bag	C185	1 1/16 x 1 3/16	RBO2226
	1 1/16 x 1 3/16	RBO2226	3/4 x 7/8	RBO2428
	3/4 x 7/8	RBO2428	Kit Bag	C187

TOOLS

Heavy Duty Pipe Wrenches

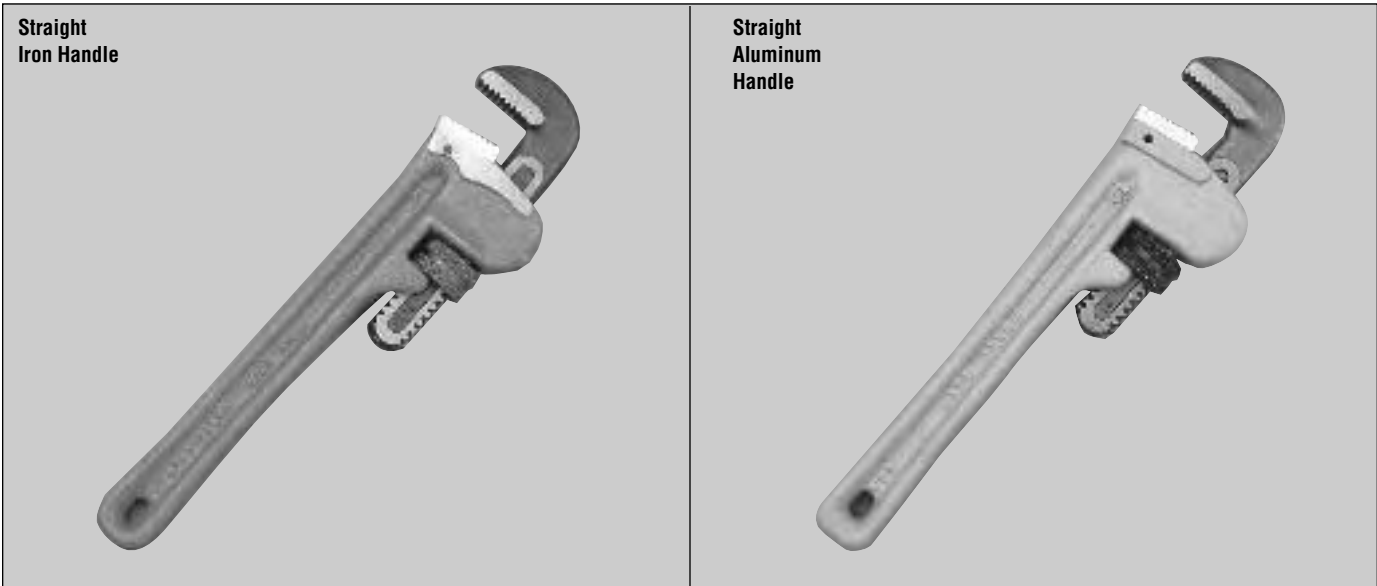

Size	Capacity	Wt. Ea. Lbs.	Part No.	Std. Pkg. Qty.	Size	Capacity	Wt. Ea. Lbs.	Part No.	Std. Pkg. Qty.
6	3/4"	1/2	PW6	6	—	—	—	—	—
8	1"	3/4	PW8	6	—	—	—	—	—
10	1 1/2"	1 1/4	PW10	6	10	1 1/2	1	PWA10	6
12	2"	2 3/4	PW12	6	—	—	—	—	—
14	2"	3 1/2	PW14	6	14	2	2	PWA14	6
18	2 1/2"	5 3/4	PW18	6	18	2 1/2	3 1/2	PWA18	6
24	3"	9 3/4	PW24	3	24	3	5 3/4	PWA24	6
36	5"	17	PW36	3	36	5	10	PWA36	3
48	6"	34	PW48	1	48	6	17	PWA48	1

Pipe Wrench Parts

Hook Jaw		Heel Jaw & Pin		Flat Spring & Ball		Nut	
Part No.	Size	Part No.	Size	Part No.	Size	Part No.	Size
PW6HJ	6"	PW6HP	6"	PW6SFC	6"	PW6N	6"
PW8HJ	8"	PW8HP	8"	PW8SFC	8"	PW8N	8"
PW10HJ	10"	PW10HP	10"	PW10SFC	10"	PW10N	10"
PW12HJ	12"	PW12HP	12"	PW12SFC	12"	PW12N	12"
PW14HJ	14"	PW14HP	14"	PW14SFC	14"	PW14N	14"
PW18HJ	18"	PW18HP	18"	PW18SFC	18"	PW18N	18"
PW24HJ	24"	PW24HP	24"	PW24SFC	24"	PW24N	24"
PW36HJ	36"	PW36HP	36"	PW36SFC	36"	PW36N	36"
PW48HJ	48"	PW48HP	48"	PW48SFC	48"	PW48N	48"

*Limited Supply

TOOLS

Martin

Adjustable Wrenches Auto Wrench Set Screw Wrenches

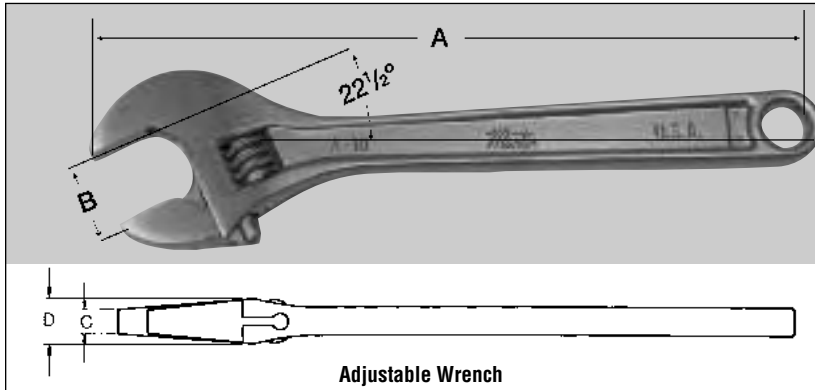

- Drop Forged American Alloy Steel
- Extra Wide Capacity
- Light Weight
- Thin Tapered Head
- 22-1/2 Degree Angle
- Nickel & Industrial Black Finish

Size Length	Capacity	Thickness of Head		Wt. Ea. Lbs.	Cobalt	Industrial Black	Std. Pkg. Qty.	Size Length
		Jaw Tip	Extreme					
A	B	C	D		Part No.	Part No.		A
6	15/16	7/32	3/8	.26	A6	A6T	6	6
8	1 1/8	17/64	1/2	.48	A8	A8T	6	8
10	1 3/16	23/64	19/32	.80	A10	A10T	6	10
12	1 1/2	15/32	23/32	1.30	A12	A12T	6	12
15	1 3/4	19/32	31/32	3.00	A15	A15T	6	15
18	2 3/16	23/32	1 1/16	5.65	A18	A18T	1	18
24	2 1/2	7/8	1 1/8	8.60	A24	A24T	1	24

Drop Forged, Machined, and Heat Treated. Well Suited for General Repair Work.

A	Max. Jaw Capacity	B	C	Weight Each-Lbs.	Chrome	Std. Pkg. Qty.
					Part No.	
11	3	7/16	1 1/2	1.5	89311	1

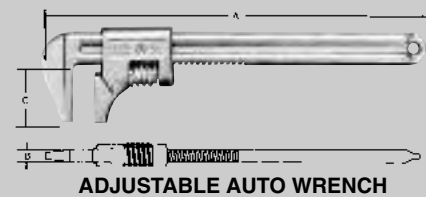

ADJUSTABLE AUTO WRENCH

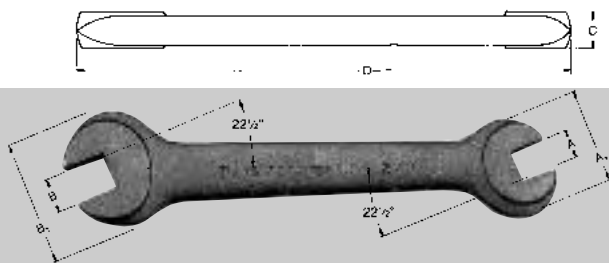

Set Screw Wrench

Set Screw Wrench

For Hard Square Set Screws, Cap Screws & Nuts

High Grade Carbon Steel

Machined to Industry Standards

Wrench Openings	Diameter of Head	Thickness of Head	Length	Wt. Ea. Lbs.	Industrial Black	Std. Pkg. Qty.	Wrench Openings
A x B	A ₁ x B ₁	C	D		Part No.		A x B
3/16 x 1/4	27/32 x 1 1/16	9/32	4 1/4	.13	523	6	3/16 x 1/4
1/4 x 5/16	27/32 x 1 1/16	9/32	4 1/4	.13	525	6	1/4 x 5/16
5/16 x 3/8	1 x 1 1/16	11/32	5	.21	527	6	5/16 x 3/8
3/8 x 7/16	1 1/4 x 1 3/8	3/8	5 3/4	.33	529	6	3/8 x 7/16
3/8 x 1/2	1 1/4 x 1 3/8	13/32	5 3/4	.35	530	6	3/8 x 1/2
7/16 x 1/2	1 1/4 x 1 3/8	13/32	5 3/4	.35	531	6	7/16 x 1/2
1/2 x 5/8	1 3/4 x 1 3/8	9/16	8 1/2	.90	534	6	1/2 x 5/8

TOOLS

Single Head Open End Engineers Wrench

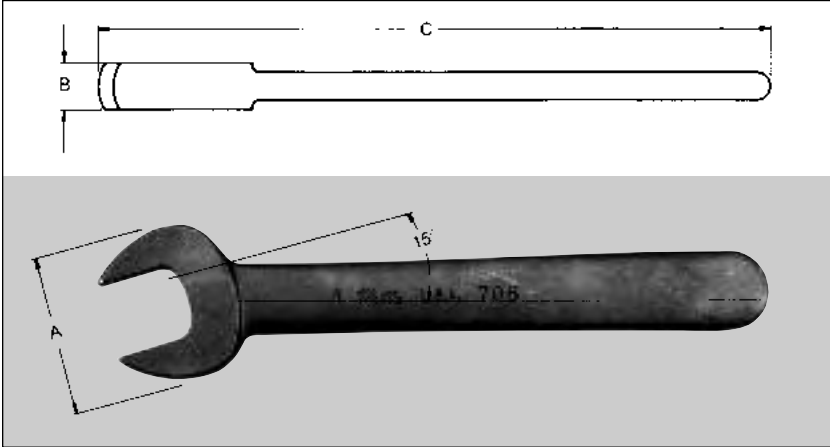

American High Carbon Steel

Precision Forged and thru Hardened.

1⁵/₈" and Larger Sizes Have Tapered Handles

Industrial Black Finish

Wrench Opening	Diameter of Head	Thickness of Head	Length	Wt. Ea. Lbs.	Industrial Black	Std. Pkg. Qty.	Wrench Opening
	A	B	C		Part No.		
1/2	1	5/16	4 3/8	.16	1	6	1/2
3/16	1 1/16	5/16	5 1/2	.19	702	6	3/16
5/8	1 3/8	1 1/32	6 3/8	.32	703	6	5/8
1 1/16	1 3/8	1 1/32	6 3/8	.32	3	6	1 1/16
3/4	1 7/8	3/8	7 1/4	.44	704	6	3/4
13/16	1 3/4	7/16	8 3/8	.64	705	6	13/16
7/8	1 3/4	7/16	8 3/8	.64	5	6	7/8
15/16	2	7/16	9 1/4	.80	6A	6	15/16
1	2	7/16	9 1/4	.82	706	6	1
1 1/16	2 1/4	9/16	10 1/2	1.26	7	6	1 1/16
1 1/8	2 1/4	9/16	10 1/2	1.22	707	6	1 1/8
1 1/4	2 3/4	1 1/32	12	2.1	8	6	1 1/4
1 3/8	2 3/4	1 1/32	12	2.0	8A	6	1 3/8
1 3/4	2 3/4	1 1/32	12	2.0	708A	6	1 3/4
1 7/8	3	5/8	13 1/2	2.5	9	6	1 7/8
1 1/2	3	5/8	13 1/2	2.5	709	6	1 1/2
1 5/8	3 1/2	7/8	15	3.6	10	1	1 5/8
1 11/16	3 1/2	7/8	15	3.5	10A	1	1 11/16
1 13/16	3 3/4	1 1/16	16 1/2	5.0	11	1	1 13/16
1 5/8	3 3/4	1 1/16	16 1/2	5.0	11A	1	1 5/8
2	4 3/8	1	18 1/4	6.2	12	1	2
2 1/16	4 3/8	1	18 1/4	6.2	12A	1	2 1/16
2 3/16	4 3/8	1 1/16	20	8.0	13	1	2 3/16
2 1/4	4 1/2	1 1/16	20	8.0	13A	1	2 1/4
2 3/8	4 3/8	1 1/8	22	9.6	14	1	2 3/8
2 7/16	4 3/8	1 1/8	22	9.6	14A	1	2 7/16
2 9/16	5 1/4	1 3/16	24	13.2	15	1	2 9/16
2 5/8	5 1/4	1 3/16	24	13.1	15A	1	2 5/8
2 3/4	6	1 1/4	27	12.9	16	1	2 3/4
2 7/8	6	1 1/4	27	16.0	16B	1	2 7/8
2 15/16	6	1 1/4	27	16.0	16A	1	2 15/16
3	6 3/8	1 1/2	30	23.7	17A	1	3
3 1/8	6 3/8	1 1/2	30	23.7	17	1	3 1/8
3 3/8	7 1/2	1 5/8	34	31.6	18A	1	3 3/8
3 1/2	7 1/2	1 5/8	34	31.6	18	1	3 1/2
3 3/4	8	1 3/4	37	33.0	19B	1	3 3/4
3 5/8	8	1 3/4	37	33.0	19	1	3 5/8
4 1/8	8	1 3/4	37	32.5	19C	1	4 1/8
4 1/4	8	1 3/4	37	32.0	19A	1	4 1/4
4 1/2	10 1/4	1 5/8	42	50.5	20B	1	4 1/2
4 3/4	10 1/4	1 5/8	42	50.5	20	1	4 3/4
5	10 1/4	1 5/8	42	50.4	20A	1	5

TOOLS

Adjustable Face Spanner

Extreme Capacity	Diameter of Pin	Length of Pin	Overall Length	Wt. Ea. Lbs.	Industrial Black	Std. Pkg. Qty.
	A	B	C		Part No.	
2	3/16	1/4	6 3/8	.31	482	6
3	1/4	1/4	8 1/4	.52	483	6
4	5/16	1 1/2	10 3/8	1.02	484	6

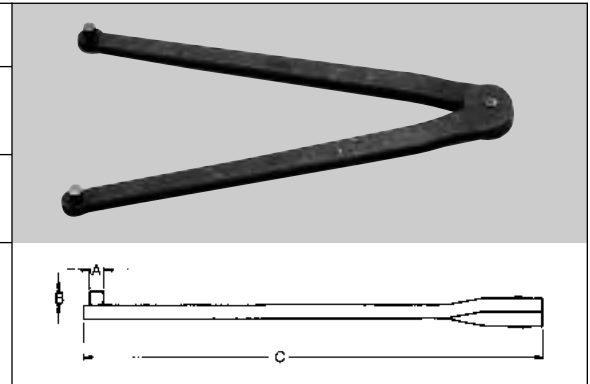

Pin Spanner

For Circle Diameter	Diameter of Pin	Length of Pin	Overall Length	Wt. Ea. Lbs.	Industrial Black	Std. Pkg. Qty.
	A	B	C		Part No.	
1	3/16	3/16	4	.08	452	6
1 1/4	13/64	3/16	4 1/2	.11	453	6
1 1/2	7/32	7/32	5	.13	454	6
1 3/4	15/64	7/32	5 1/2	.17	455	6
2	1/4	1/4	6	.20	456	6
2 1/4	17/64	1/4	6 1/2	.24	457	6
2 1/2	9/32	9/32	7	.28	458	6
2 3/4	19/64	9/32	7 1/2	.37	459	6
3	5/16	9/16	8	.43	460	6
3 1/4	21/64	5/16	8 1/2	.47	461	6
3 1/2	11/32	5/16	9	.50	462	6
3 3/4	23/64	3/8	9 1/2	.59	463	6
4	3/8	7/16	10	.69	464	6
5	7/16	7/16	12	1.15	466	6
6	1/2	1/2	14	1.90	468	6

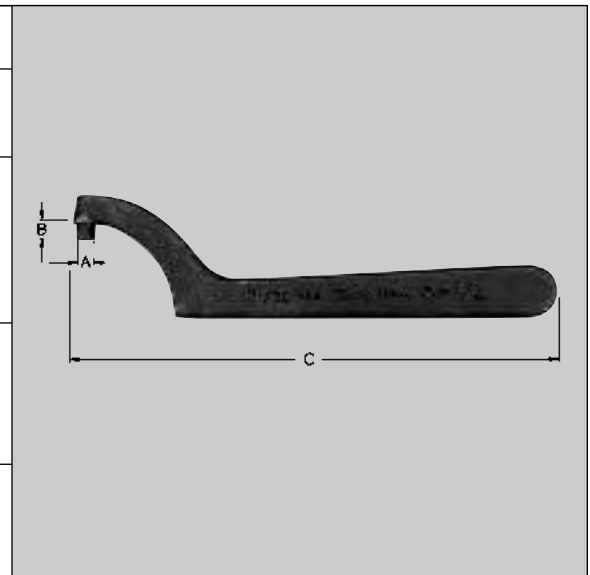

Face Spanner

Center Distance of Pins	Pins		Span of Jaws in Clear	Length from Center of Pins	Thick-ness	Wt. Ea. Lbs.	Industrial Black	Std. Pkg. Qty.
	Dia.	Length					Part No.	
A	B	C	D	E	F			
1	3/16	3/16	1 1/16	4 1/2	3/16	.12	418	6
1 1/4	7/32	7/32	7/8	5	3/16	.13	420	6
1 1/2	7/32	7/32	1 1/8	5 1/2	3/16	.23	422	6
1 3/4	7/32	7/32	1 3/8	6	7/32	.30	424	6
2	1/4	1/4	1 19/32	6 1/2	7/32	.39	426	6
2 1/4	1/4	1/4	1 27/32	7	7/32	.42	428	6
2 1/2	9/32	9/32	2 1/32	7 1/2	1/4	.52	430	6
2 3/4	9/32	9/32	2 5/32	8	1/4	.59	432	6
3	5/16	5/16	2 1/2	8 1/2	1/4	.70	434	6
3 1/4	5/16	5/16	2 3/4	9 3/8	1/4	.82	436	6
3 1/2	5/16	5/16	3	9 3/4	1/4	.89	438	6
3 3/4	3/8	3/8	3 3/16	10 3/8	1/4	1.0	440	6
4	3/8	3/8	3 1/2	11	1/4	1.1	442	6

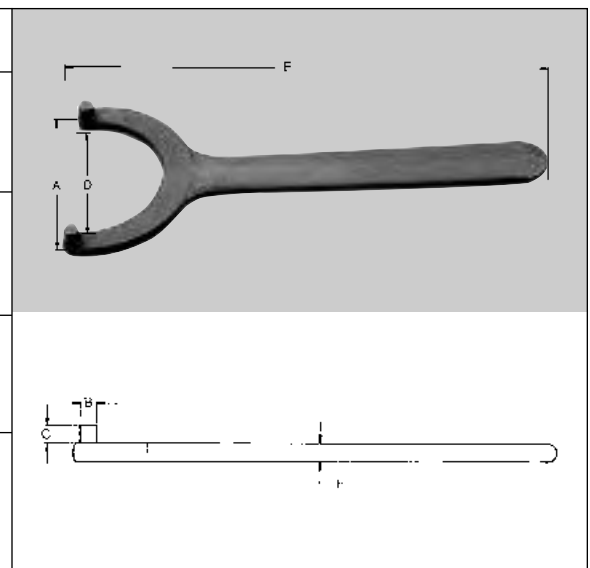

TOOLS

Adjustable Spanner Wrenches

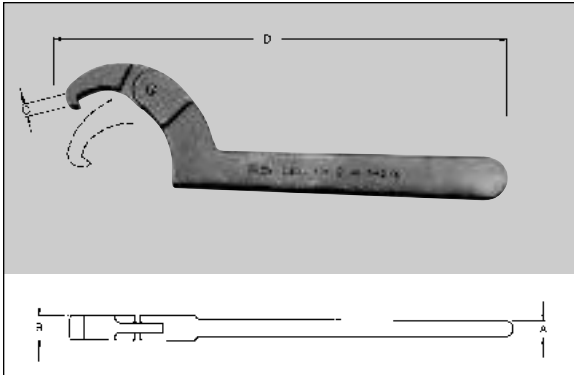

Adjustable Hook Spanner

Capacity Range	Thickness of Handle	Thickness of Hook	Depth of Hook	Length	Wt. Ea. Lbs.	Industrial Black	Std. Pkg. Qty.
	A	B	C	D		Part No.	
3/4 to 2	1/4	1 1/2	1/8	6 3/4	.23	471	6
1 1/4 to 3	5/16	1 3/4	3/16	8 1/4	.43	472	6
2 to 4 1/4	3/8	2 1/4	1/4	11 1/4	1.03	474	6
4 1/2 to 6 1/4	1/2	3 1/4	3/8	12 1/4	1.07	474A	6
6 1/2 to 8 3/4	5/8	4 1/4	1/2	13 1/4	1.40	474B	6

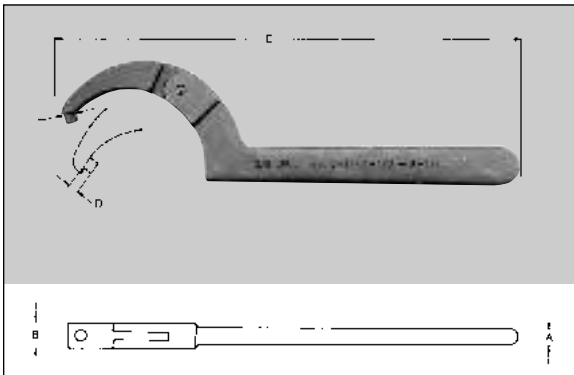

Adjustable Pin Spanner

Capacity Range	Thickness		Pin Size		Overall Length	Wt. Ea. Lbs.	Industrial Black	Std. Pkg. Qty.
	Handle	Hook	Diameter	Length			Part No.	
	A	B	C	D				
3/4 to 2	1/4	1 1/2	1/8	1/4	6 3/4	.23	0471	6
3/4 to 2	1/4	1 1/2	3/16	5/16	6 3/4	.23	0471A	6
1 1/4 to 3	5/16	1 3/4	1/4	3/8	8 1/4	.42	0472	6
1 1/4 to 3	5/16	1 3/4	1/4	7/16	8 1/4	.42	0472A	6
2 to 4 1/4	3/8	2 1/4	3/8	1/2	11 1/4	.99	0474	6
4 1/2 to 6 1/4	1/2	3 1/4	1/2	3/4	12 1/4	1.08	0474A	6

Adjustable Spanner Wrench Sets



SPW6K
0471
0471A
0472
0472A
0474
0474A
C60B Kit Bag



SHW5K
471
472
474
474A
474B
C60B Kit Bag

TOOLS

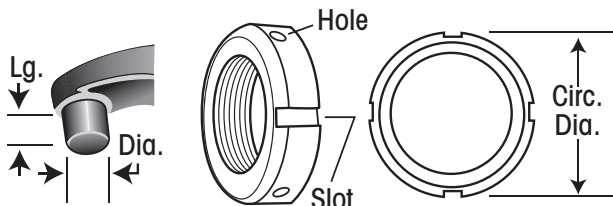

Adjustable Pin Spanner

Pins fit into the holes or slots on the side of the flange or collar.

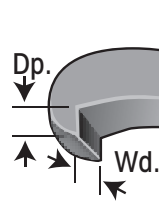

Adjustable Hook Spanner

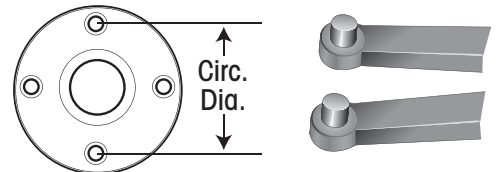

Pins fit into the holes or slots on the face of the flange or collar.

Adjustable Face Spanner

Structural Box Wrenches									
Wrench Opening	Diameter of Head	Thickness of Head	Length	Offset at End	Wt. Ea. Lbs.	Part No.	Std. Pkg. Qty.	Wrench Opening	
	A	B	C	D					
13/16	1 15/32	11/16	12	1 25/32	1.3	8905A	1	13/16	
7/8	1 15/32	11/16	12	1 25/32	1.3	8905	1	7/8	
15/16	1 1/8	13/16	12	1 61/64	1.3	8906	1	15/16	
1	1 5/8	13/16	12	1 61/64	1.3	8906B	1	1	
1 1/16	1 59/64	7/8	15	2 3/4	1.9	8907	1	1 1/16	
1 1/8	1 59/64	7/8	15	2 3/4	1.9	8907A	1	1 1/8	
1 1/4	2 3/64	15/16	17	2 21/64	2.6	8908	1	1 1/4	
1 5/16	2 3/4	15/16	17	2 21/64	2.0	8908A	1	1 5/16	
1 7/16	2 3/4	1 1/8	19	2 3/4	3.5	8909	1	1 7/16	
1 1/2	2 3/4	1 1/8	19	2 3/4	3.5	8909A	1	1 1/2	
1 5/8	2 3/4	1 3/16	22	2 7/8	4.8	8910	1	1 5/8	
1 11/16	2 3/8	1 3/16	22	2 7/8	4.7	8910A	1	1 11/16	
1 13/16	2 29/32	1 1/4	23	3	6.6	8911	1	1 13/16	
1 1/8	2 29/32	1 1/4	23	3	6.6	8911A	1	1 1/8	
2	3 3/32	1 3/8	24 1/2	3 5/32	6.5	8912	1	2	
2 3/16	3 15/32	1 1/2	26	3 1/2	7.3	8913	1	2 3/16	
2 3/8	3 23/32	1 5/8	28	3 11/16	8.5	8914	1	2 3/8	
2 1/2	3 29/32	1 3/4	30	3 11/16	9.2	8915	1	2 1/2	
2 3/4	4 3/32	1 7/8	30	3 29/32	9.8	8916	1	2 3/4	

Structural Box Wrench Heads are Offset from Handle to Permit Clearance of Obstructions.

Industrial Black

Handles are Tapered to Align Bolt Holes.

Structural Wrench Offset									
Wrench Opening	Diameter of Head	Thickness of Head	Length	Handle at Head	Offset at End	Wt. Ea. Lbs.	Industrial Black	Std. Pkg. Qty.	Wrench Opening
	A	B	C	D	E		Part No.		
9/16	1 1/16	3/16	12	13/16	1 11/16	.56	901B	1	9/16
5/8	1 1/16	3/16	12	13/16	1 11/16	.56	903A	1	5/8
11/16	1 1/16	3/16	12	13/16	1 11/16	.56	903	1	11/16
3/4	1 1/16	3/16	12	13/16	1 11/16	.70	904A	1	3/4
13/16	2	1 1/32	14 1/2	15/16	1 7/8	1.3	905A	1	13/16
7/8	2	1 1/32	14 1/2	15/16	1 7/8	1.3	905	1	7/8
15/16	2	1 1/32	14 1/2	15/16	1 7/8	1.3	906C	1	15/16
1	2	1 1/32	14 1/2	15/16	1 7/8	1.3	906B	1	1
1 1/16	2 1/4	5/8	17	1 1/16	2 3/8	1.9	907	1	1 1/16
1 1/8	2 1/4	5/8	17	1 1/16	2 3/8	1.9	907A	1	1 1/8
1 1/4	2 3/4	1 1/16	19	1 1/4	2 3/4	2.6	908	1	1 1/4
1 3/8	2 3/4	1 1/16	19	1 1/4	2 3/4	2.6	908A	1	1 3/8
1 7/16	3 1/8	3/4	20	1 1/4	3 1/8	3.5	909	1	1 7/16
1 1/2	3 1/8	3/4	20	1 1/4	3 1/8	3.5	909A	1	1 1/2
1 5/8	3 15/32	13/16	23	1 1/2	3 3/8	4.8	910	1	1 5/8
1 11/16	3 19/32	13/16	23	1 1/2	3 3/8	4.7	910A	1	1 11/16
1 13/16	4 1/8	1 3/16	24	1 5/8	3 11/16	6.6	911	1	1 13/16
1 7/8	4 1/8	1 3/16	24	1 5/8	3 11/16	6.6	911A	1	1 7/8
2	4 1/8	1 3/16	24	1 5/8	3 11/16	6.5	912	1	2

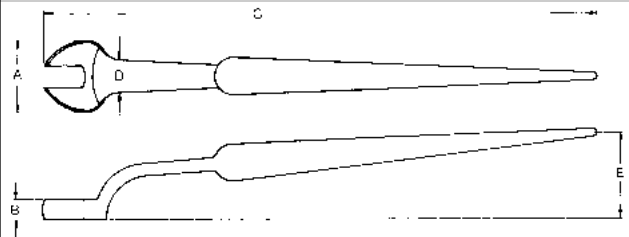

Structural Wrench Heads are Offset from Handle to Permit Clearance of Obstructions.

Handles are Tapered to Align Bolt Holes.

TOOLS

Construction and Box Wrenches

Construction Wrench 15° Angle							
Wrench Opening	Diameter of Head	Thickness of Head	Length	Wt. Ea. Lbs.	Industrial Black	Std. Pkg. Qty.	Wrench Opening
	A	B			Part No.		
5/8	1 1/16	7/16	12	.62	203A	1	5/8
1 1/16	1 1/16	7/16	12	.62	203	1	1 1/16
3/4	1 1/16	7/16	12	.58	204A	1	3/4
7/8	2	1 1/2	14 1/2	2.0	205	1	7/8
1 5/16	2	1 1/2	14 1/2	2.0	206C	1	1 5/16
1	2	1 1/2	14 1/2	2.0	206B	1	1
1 1/16	2 1/4	5/8	17	1.8	207	1	1 1/16
1 1/8	2 1/4	5/8	17	1.8	207A	1	1 1/8
1 1/4	2 5/8	1 1/16	19	2.7	208	1	1 1/4
1 5/16	2 5/8	1 1/16	19	2.7	208A	1	1 5/16
1 7/16	2 5/8	1 1/16	19	2.6	209	1	1 7/16
1 1/2	2 5/8	1 1/16	19	2.6	209A	1	1 1/2
1 5/8	4	1 5/16	22 11/16	7.0	210	1	1 5/8
1 11/16	4	1 5/16	22 11/16	7.0	210A	1	1 11/16
1 13/16	4	1 5/16	22 11/16	6.9	211	1	1 13/16
1 7/8	4	1 5/16	22 11/16	6.9	211A	1	1 7/8
2	4	1 5/16	22 11/16	6.8	212	1	2

Drop Forged from High Grade Carbon Steel, thru Hardening.

Straight Handle with 15° Angle Opening.

Handles are Tapered to Align Bolt Holes.

12 Point Box Opening

Box Wrenches							
Wrench Opening	Diameter of Head	Thickness of Head	Length	Wt. Ea. Lbs.	Industrial Black	Std. Pkg. Qty.	Wrench Opening
	A	B			Part No.		
1/2	29/32	3/8	6 25/32	.28	801	6	1/2
5/16	1 1/32	7/16	6 25/32	.30	802A	6	5/16
5/8	1 1/16	1/2	7 1/8	.38	803A	6	5/8
1 1/16	1 1/8	1/2	7 3/16	.45	803	6	1 1/16
3/4	1 1/2	9/16	7 1/16	.53	804A	6	3/4
7/8	1 5/8	5/8	7 1/2	.60	805	6	7/8
1 5/16	1 7/16	5/8	7 13/16	.63	806	6	1 5/16
1	1 9/16	1 1/16	7 13/16	.69	806B	6	1
1 1/8	1 3/4	3/4	7 15/16	.78	807	6	1 1/8
1 1/16	1 11/16	25/32	7 15/16	.83	807A	6	1 1/16
1 1/4	1 23/32	13/16	7 15/16	.83	808	6	1 1/4
1 1/2	2 3/16	7/8	10	1.6	809A	6	1 1/2

TOOLS

Martin

Striking Face 6 Point Box Wrenches SAE 12 Point Box Wrenches SAE & Metric

Wrench Opening (Nut Size)	Diameter of Head		Thickness of Head C	Wt. Ea. Lbs.	Industrial Black Part No.	Std. Pkg. Qty.	Wrench Opening (Nut Size)
	A	B					
1 ¹ / ₁₆	1 ²⁵ / ₃₂	9 ⁷ / ₈	⁵ / ₈	1.9	RN7063	1	1 ¹ / ₁₆
1 ¹ / ₄	2	10 ¹ / ₄	²³ / ₃₂	2.1	RN7075	1	1 ¹ / ₄
1 ¹ / ₂	2 ¹ / ₁₆	10 ⁹ / ₁₆	⁷ / ₈	2.6	RN7088	1	1 ¹ / ₂
1 ³ / ₈	2 ³ / ₁₆	11	⁹ / ₁₆	2.9	RN7100	1	1 ³ / ₈
1 ¹ / ₂	2 ² / ₁₆	11 ¹ / ₁₆	⁹ / ₁₆	3.5	RN7113	1	1 ¹ / ₂
2	3 ¹ / ₁₆	11 ¹ / ₈	1 ¹ / ₁₆	4.0	RN7125	1	2
2 ¹ / ₁₆	3 ³ / ₁₆	12	1 ¹ / ₈	5.2	RN7138	1	2 ¹ / ₁₆
2 ¹ / ₈	3 ¹ / ₈	12 ³ / ₈	1 ¹ / ₈	6.0	RN7150	1	2 ¹ / ₈
2 ¹ / ₄	3 ³ / ₈	12 ¹ / ₁₆	1 ¹ / ₄	6.6	RN7163	1	2 ¹ / ₄
2 ³ / ₈	4 ¹ / ₁₆	13 ¹ / ₁₆	1 ¹ / ₂	7.5	RN7175	1	2 ³ / ₈
2 ¹ / ₂	4 ³ / ₁₆	13 ¹ / ₈	1 ¹ / ₂	7.9	RN7188	1	2 ¹ / ₂
3 ¹ / ₈	4 ³ / ₈	13 ¹ / ₁₆	1 ⁵ / ₈	9.4	RN7200	1	3 ¹ / ₈
3 ¹ / ₄	4 ³ / ₄	14 ¹ / ₄	1 ²³ / ₃₂	10.5	RN7225	1	3 ¹ / ₄
3 ³ / ₈	5 ³ / ₁₆	14 ¹ / ₂	1 ²³ / ₃₂	13.3	RN7250	1	3 ³ / ₈

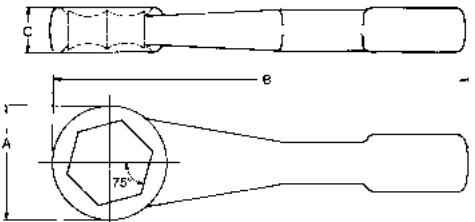

Roughneck "Hammer Wrench"
Straight Pattern — 6 Point
Alloy Steel — Drop Forged

Wrench Opening (Nut Size)	Diameter of Head		Thickness of Head C	Wt. Ea. Lbs.	Industrial Black Part No.	Std. Pkg. Qty.	Wrench Opening (Nut Size)
	A	B					
1	1 ²⁵ / ₃₂	9 ⁷ / ₈	⁵ / ₈	1.9	1807B	1	1
1 ¹ / ₁₆	1 ²⁵ / ₃₂	9 ⁷ / ₈	⁵ / ₈	1.9	1807	1	1 ¹ / ₁₆
1 ¹ / ₈	1 ²⁵ / ₃₂	9 ⁷ / ₈	⁵ / ₈	1.9	1807A	1	1 ¹ / ₈
1 ³ / ₁₆	2	10 ¹ / ₄	²³ / ₃₂	2.1	1808B	1	1 ³ / ₁₆
1 ¹ / ₄	2	10 ¹ / ₄	²³ / ₃₂	2.1	1808	1	1 ¹ / ₄
1 ¹ / ₂	2	10 ¹ / ₄	²³ / ₃₂	2.1	1808A	1	1 ¹ / ₂
1 ⁵ / ₈	2 ¹ / ₁₆	10 ⁹ / ₁₆	⁷ / ₈	2.6	1809B	1	1 ⁵ / ₈
1 ¹ / ₂	2 ¹ / ₁₆	10 ⁹ / ₁₆	⁷ / ₈	2.6	1809	1	1 ¹ / ₂
1 ¹ / ₂	2 ¹ / ₁₆	10 ⁹ / ₁₆	⁷ / ₈	2.6	1809A	1	1 ¹ / ₂
1 ³ / ₄	2 ³ / ₁₆	11	⁹ / ₁₆	2.9	1810	1	1 ³ / ₄
1 ¹ / ₂	2 ³ / ₁₆	11	⁹ / ₁₆	2.9	1810A	1	1 ¹ / ₂
1 ³ / ₈	2 ² / ₁₆	11 ¹ / ₁₆	⁹ / ₁₆	3.5	1811B	1	1 ³ / ₈
1 ¹ / ₂	2 ² / ₁₆	11 ¹ / ₁₆	⁹ / ₁₆	3.5	1811	1	1 ¹ / ₂
1 ¹ / ₂	2 ² / ₁₆	11 ¹ / ₁₆	⁹ / ₁₆	3.5	1811A	1	1 ¹ / ₂
2	3 ¹ / ₁₆	11 ¹ / ₈	1 ¹ / ₁₆	4.0	1812	1	2
2 ¹ / ₁₆	3 ³ / ₁₆	11 ¹ / ₈	1 ¹ / ₁₆	4.0	1812B	1	2 ¹ / ₁₆
2 ¹ / ₈	3 ³ / ₁₆	12	1 ¹ / ₈	5.2	1813B	1	2 ¹ / ₈
2 ¹ / ₄	3 ³ / ₈	12	1 ¹ / ₈	5.2	1813	1	2 ¹ / ₄
2 ¹ / ₄	3 ¹ / ₄	12 ³ / ₈	1 ¹ / ₈	6.0	1813A	1	2 ¹ / ₄
2 ³ / ₈	3 ¹ / ₄	12 ³ / ₈	1 ¹ / ₈	6.0	1814	1	2 ³ / ₈
2 ¹ / ₂	3 ³ / ₄	12 ¹ / ₁₆	1 ¹ / ₂	6.5	1815B	1	2 ¹ / ₂
2 ¹ / ₂	3 ³ / ₄	12 ¹ / ₁₆	1 ¹ / ₂	6.5	1815C	1	2 ¹ / ₂
2 ¹ / ₂	3 ³ / ₄	12 ¹ / ₁₆	1 ¹ / ₂	6.5	1815	1	2 ¹ / ₂
2 ³ / ₈	3 ³ / ₄	12 ¹ / ₁₆	1 ¹ / ₂	6.5	1815A	1	2 ³ / ₈
2 ¹ / ₄	4 ¹ / ₁₆	13 ¹ / ₁₆	1 ¹ / ₂	7.5	1816	1	2 ¹ / ₄
2 ¹ / ₂	4 ²³ / ₆₄	13 ¹ / ₈	1 ¹ / ₂	7.9	1816C	1	2 ¹ / ₂
2 ¹ / ₂	4 ²³ / ₆₄	13 ¹ / ₈	1 ¹ / ₂	7.9	1816B	1	2 ¹ / ₂
3	4 ³ / ₁₆	13 ¹ / ₁₆	1 ⁵ / ₈	9.4	1817A	1	3
3 ¹ / ₈	4 ³ / ₁₆	13 ¹ / ₁₆	1 ⁵ / ₈	9.4	1817	1	3 ¹ / ₈
3 ¹ / ₄	4 ³ / ₄	14 ¹ / ₄	1 ²³ / ₃₂	10.5	1818A	1	3 ¹ / ₄
3 ¹ / ₂	4 ³ / ₂	14 ¹ / ₂	1 ²³ / ₃₂	10.5	1818	1	3 ¹ / ₂
3 ³ / ₈	5 ³ / ₁₆	14 ¹ / ₂	1 ²³ / ₃₂	13.3	1819B	1	3 ³ / ₈
3 ¹ / ₂	5 ³ / ₁₆	14 ¹ / ₂	1 ²³ / ₃₂	13.3	1819	1	3 ¹ / ₂
4 ¹ / ₈	6 ¹ / ₁₆	16 ¹ / ₁₆	2 ¹ / ₈	20.8	1820B	1	4 ¹ / ₈
4 ¹ / ₄	6 ¹ / ₈	16 ¹ / ₁₆	2 ¹ / ₈	20.1	1820	1	4 ¹ / ₄
4 ¹ / ₂	7 ¹ / ₁₆	18 ¹ / ₁₆	3	35.2	1821B	1	4 ¹ / ₂
4 ¹ / ₂	7 ¹ / ₁₆	18 ¹ / ₁₆	3	38.0	1821	1	4 ¹ / ₂
4 ³ / ₈	7 ¹ / ₈	18 ¹ / ₁₆	3	38.2	1822	1	4 ³ / ₈
32mm	50.8	260.4	18.3	2.1	1832MM	1	32 mm
36mm	57.7	268.2	22.4	2.6	1836MM	1	36 mm
41mm	63.0	279.4	24.1	2.9	1841MM	1	41 mm
46mm	67.6	287.3	24.9	3.5	1846MM	1	46 mm
50mm	67.6	287.3	24.9	3.5	1850MM	1	50 mm
55mm	83.3	304.8	31.8	5.2	1855MM	1	55 mm
60mm	86.6	314.5	36.6	6.0	1860MM	1	60 mm
65mm	95.3	322.3	38.9	6.6	1865MM	1	65 mm
70mm	105.9	331.7	38.9	7.5	1870MM	1	70 mm
75mm	110.7	341.4	38.9	7.9	1875MM	1	75 mm
80 mm	113.8	350.8	41.1	9.4	1880MM	1	80 mm

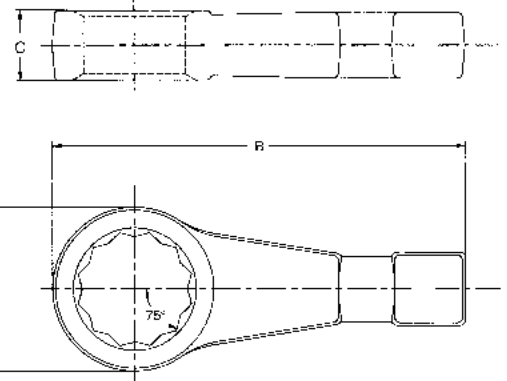

Roughneck "Hammer Wrench"
Straight Pattern — 12 Point
Alloy Steel — Drop Forged

TOOLS

Striking Face Box Wrenches Offset Style

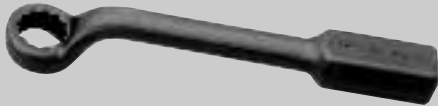

	Wrench Opening	Diameter of Head	Thickness of Head	Length C	Wt. Ea. Lbs.	Industrial Black	Std. Pkg. Qty.	Wrench Opening
		A	B			Part No.		
	1	1 ²⁵ / ₃₂	3/ ₁₆	10	1.9	8807 B	1	1
	1 ¹ / ₁₆	1 ²⁵ / ₃₂	3/ ₁₆	10	1.9	8807	1	1 ¹ / ₁₆
	1 ¹ / ₈	1 ²⁵ / ₃₂	3/ ₁₆	10	1.8	8807A	1	1 ¹ / ₈
	1 ³ / ₁₆	2 ¹ / ₁₆	2 ⁷ / ₃₂	11	2.6	8808B	1	1 ³ / ₁₆
	1 ¹ / ₄	2 ¹ / ₁₆	2 ⁷ / ₃₂	11	2.6	8808	1	1 ¹ / ₄
	1 ³ / ₈	2 ¹ / ₁₆	2 ⁷ / ₃₂	11	2.6	8808A	1	1 ³ / ₈
	1 ³ / ₈	2 ²⁵ / ₆₄	1 ⁵ / ₁₆	11 ¹ / ₂	3.4	8809B	1	1 ³ / ₈
	1 ⁷ / ₁₆	2 ²⁵ / ₆₄	1 ⁵ / ₁₆	11 ¹ / ₂	3.4	8809	1	1 ⁷ / ₁₆
	1 ¹ / ₂	2 ²⁵ / ₆₄	1 ⁵ / ₁₆	11 ¹ / ₂	3.3	8809A	1	1 ¹ / ₂
	1 ⁵ / ₈	2 ²¹ / ₃₂	1 ¹ / ₁₆	12	4.0	8810	1	1 ⁵ / ₈
	1 ¹¹ / ₁₆	2 ²¹ / ₃₂	1 ¹ / ₁₆	12	4.0	8810A	1	1 ¹¹ / ₁₆
	1 ³ / ₄	2 ²¹ / ₃₂	1 ¹ / ₁₆	12	3.9	8811B	1	1 ³ / ₄
	1 ¹³ / ₁₆	3 ³ / ₃₂	1 ¹ / ₁₆	13	5.4	8811	1	1 ¹³ / ₁₆
	1 ⁷ / ₈	3 ³ / ₃₂	1 ³ / ₁₆	13	5.4	8811A	1	1 ⁷ / ₈
	1 ¹⁵ / ₁₆	3 ³ / ₃₂	1 ³ / ₁₆	13	5.3	8812A	1	1 ¹⁵ / ₁₆
	2	3 ³ / ₃₂	1 ³ / ₁₆	13	5.2	8812	1	2
	2 ¹ / ₈	3 ¹⁷ / ₃₂	1 ¹ / ₁₆	13 ¹ / ₂	6.9	8813B	1	2 ¹ / ₈
	2 ¹ / ₈	3 ¹⁷ / ₃₂	1 ¹ / ₁₆	13 ¹ / ₂	6.9	8813	1	2 ¹ / ₈
	2 ¹ / ₄	3 ¹⁷ / ₃₂	1 ¹ / ₁₆	13 ¹ / ₂	6.7	8813A	1	2 ¹ / ₄
	2 ³ / ₁₆	3 ¹³ / ₁₆	1 ¹ / ₁₆	14	8.1	8814A	1	2 ³ / ₁₆
	2 ³ / ₈	3 ¹³ / ₁₆	1 ¹ / ₁₆	14	7.8	8814	1	2 ³ / ₈
	2 ¹ / ₂	3 ¹³ / ₁₆	1 ¹ / ₁₆	14	7.8	8815B	1	2 ¹ / ₂
	2 ³ / ₁₆	4 ⁷ / ₃₂	1 ¹ / ₁₆	15	10.6	8815	1	2 ³ / ₁₆
	2 ⁵ / ₈	4 ⁷ / ₃₂	1 ¹ / ₁₆	15	10.5	8815A	1	2 ⁵ / ₈
	2 ³ / ₄	4 ⁷ / ₃₂	1 ¹ / ₁₆	15	10.2	8816	1	2 ³ / ₄
	2 ⁷ / ₈	4 ²⁵ / ₃₂	1 ¹ / ₈	16	14.0	8816C	1	2 ⁷ / ₈
	2 ¹⁵ / ₁₆	4 ²⁵ / ₃₂	1 ¹ / ₈	16	13.8	8816B	1	2 ¹⁵ / ₁₆
	3	4 ²⁵ / ₃₂	1 ¹ / ₈	16	13.7	8817	1	3
	3 ¹ / ₈	4 ²⁵ / ₃₂	1 ¹ / ₈	16	13.3	8817A	1	3 ¹ / ₈
	3 ³ / ₈	6 ¹ / ₄	2 ³ / ₈	18	26.7	8818A	1	3 ³ / ₈
	3 ¹ / ₂	6 ¹ / ₄	2 ³ / ₈	18	26.3	8818	1	3 ¹ / ₂
	3 ³ / ₄	6 ¹ / ₄	2 ³ / ₈	18	25.3	8819B	1	3 ³ / ₄
	3 ⁷ / ₈	6 ¹ / ₄	2 ³ / ₈	18	24.8	8819	1	3 ⁷ / ₈
	4 ¹ / ₈	6 ¹ / ₄	2 ³ / ₈	18	23.6	8819C	1	4 ¹ / ₈
	4 ¹ / ₄	6 ¹ / ₄	2 ³ / ₈	18	22.9	8819A	1	4 ¹ / ₄

45° Offset Pattern — 12 Point

**Black Industrial Finish
Drop Forged**



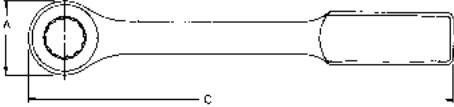





TOOLS

	Wrench Opening	Diameter of Head	Thickness of Head	Length C	Wt. Ea. Lbs.	Industrial Black	Std. Pkg. Qty.	Wrench Opening
		A	B			Part No.		
	32 mm	2 ¹ / ₁₆	2 ⁷ / ₃₂	11	2.6	8832 mm	1	32 mm
	36 mm	2 ²⁵ / ₆₄	1 ⁵ / ₁₆	11 ¹ / ₂	3.4	8836 mm	1	36 mm
	41 mm	2 ²¹ / ₃₂	1 ¹ / ₁₆	12	4.0	8841 mm	1	41 mm
	46 mm	3 ³ / ₃₂	1 ³ / ₁₆	13	5.4	8846 mm	1	46 mm
	50 mm	3 ³ / ₃₂	1 ³ / ₁₆	13	5.2	8850 mm	1	50 mm
	55 mm	3 ¹⁷ / ₃₂	1 ¹ / ₁₆	13 ¹ / ₂	6.9	8855 mm	1	55 mm
	60 mm	3 ¹³ / ₁₆	1 ¹ / ₁₆	14	7.8	8860 mm	1	60 mm
	65 mm	4 ⁷ / ₃₂	1 ¹ / ₈	15	10.6	8865 mm	1	65 mm
	70 mm	4 ⁷ / ₃₂	1 ¹ / ₈	15	10.2	8870 mm	1	70 mm
	75 mm	4 ²⁵ / ₃₂	1 ¹ / ₈	16	13.8	8875 mm	1	75 mm
	80 mm	4 ²⁵ / ₃₂	1 ¹ / ₈	16	13.3	8880 mm	1	80 mm







45° Offset Pattern — 12 Point

**Black Industrial Finish
Drop Forged**

Hex Key Wrench Sets

	Number	Approx. Wt. Lbs.	Quantity		Number	Approx. Wt. Lbs.	Quantity
	13S	.75	1		11SA	.6	1
Contains 13 keys, short arm series, each in a separate size-marked pocket, inch sizes: .050, 1/16, 3/64, 1/32, 1/64, 1/8, 3/64, 1/32, 1/16, 1/32, 1/4, 3/16, 1/2.				11 keys, short arm series, inch sizes: .050, 1/16, 3/64, 1/32, 1/8, 3/64, 1/32, 1/16, 1/32, 1/4, 3/16, 1/2.			
Kit Bag C691				Kit Bag C691			
	Number	Approx. Wt. Lbs.	Quantity		Number	Approx. Wt. Lbs.	Quantity
	9L	.9	1		9S	.30	1
9 keys, 6" long arm series, inch sizes: 3/64, 1/32, 1/8, 3/32, 1/16, 1/32, 1/4, 3/16, 1/2.				9 keys, short arm series, inch sizes: 3/64, 1/32, 1/8, 3/32, 1/16, 1/32, 1/4, 3/16, 1/2.			
Kit Bag C591				Kit Bag C691			
	Number	Approx. Wt. Lbs.	Quantity		Number	Approx. Wt. Lbs.	Quantity
	9SM	.58	1		7S	.25	1
9 metric keys, short arm series, mm sizes: 1.5, 2, 2.5, 3, 4, 5, 6, 8, 10.				7 keys, short arm series, inch sizes: 3/64, 1/32, 1/8, 3/32, 1/16, 1/32, 1/4.			
Kit Bag C691				Kit Bag C791			
	Number	Approx. Wt. Lbs.	Quantity		Number	Approx. Wt. Lbs.	Quantity
	11S	1.6	1		7SM	.66	1
11 keys, short arm series, inch sizes: 3/64, 1/32, 1/8, 3/32, 1/16, 1/32, 1/4, 3/16, 1/2, 3/16.				7 metric keys, short arm series, mm sizes: 2, 2.5, 3, 4, 5, 6, 8.			
Kit Bag C591				Kit Bag C691			

JackKey Wrench Sets

	Number	Approx. Wt. Lbs.	Quantity		Number	Approx. Wt. Lbs.	Quantity
	5LK	1.62	1		9LK	1.06	1
JackKey® Set with 5 long bits in inch sizes: 3/16, 1/32, 1/4, 3/16, 1/2.				JackKey® Set with 9 bits in inch sizes: .050, 1/16, 3/64, 1/32, 1/8, 3/64, 1/32, 1/16.			
Bit lengths 3 3/4"-5". Handle length 5 1/4".							
	Number	Approx. Wt. Lbs.	Quantity		Number	Approx. Wt. Lbs.	Quantity
	7LKM	.15	1		8SK	.3	1
Metric JackKey® Set with 7 bits in mm sizes: 1.5, 2, 2.5, 3, 4, 5, 6.				JackKey® Set with 8 bits in inch sizes: .050, 1/16, 3/64, 1/32, 1/8, 3/64, 1/32.			
Bit lengths 38-50 mm; handle length 100 mm.				Bit lengths 2"-2 1/2". Handle length 3".			
	Number	Approx. Wt. Lbs.	Quantity		Number	Approx. Wt. Lbs.	Quantity
	8LK	2.02	1		9SK	1.06	1
JackKey® Set with 8 long bits in inch sizes: 3/32, 1/64, 1/8, 3/64, 1/32, 1/16, 1/32, 1/4.				JackKey® Set with 9 bits in inch sizes: 3/64, 1/32, 1/64, 1/8, 3/64, 1/32, 1/16, 1/32, 1/4.			
Bit lengths 5"-5 1/2". Handle length 6 1/4".				Bit lengths 3"-3 1/2". Handle length 4".			
Number	Approx. Wt. Lbs.	Quantity		Number	Approx. Wt. Lbs.	Quantity	
8SC	.34	1		7SCM	.4	1	
Handle Length: 3 1/2". Contains 8 bits in inch sizes: .050, 1/16, 3/64, 1/32, 1/64, 1/8, 3/64, 1/32.			Handle Length: 3 1/2". Contains 7 bits in metric sizes: 1.5, 2, 2.5, 3, 4, 5, 6.				
Number	Approx. Wt. Lbs.	Quantity	Number	Approx. Wt. Lbs.	Quantity		
9SC	.34	1	9SAC	.6	1		
Handle Length: 3 1/2". Contains 9 bits in inch sizes: .050, 1/16, 3/64, 1/32, 1/64, 1/8, 3/64, 1/32, 1/16.			Handle Length: 4 1/4". Contains 9 bits in inch sizes: 3/64, 1/32, 1/64, 1/8, 3/64, 1/32, 1/16, 1/32, 1/4.				
Handle Length: 4 1/4". Contains 7 TORX® bits: T-10, T-15, T-20, T-25, T-27, T-30, T-40.							

Offset Socket Wrenches

Forged from High Grade Carbon Steel

Special Bends, Lengths Available as Made-to-Order

<p>Square Opening</p>		Square Opening 4-Point							
		Wrench Opening	Handle Offset in Clear from Face of Wrench	Diameter of Head	Length	Wt. Ea. Lbs.	Industrial Black	Std. Pkg. Qty.	Wrench Opening
							Part No.		
1/4	13/16	1/2	3 3/8	.07	261J	6	1/4		
5/16	1	5/8	3 3/8	.12	262H	6	5/16		
3/8	1 1/8	7/16	4 7/16	.23	263H	6	3/8		
7/16	1 1/8	7/8	5 1/8	.42	265H	6	7/16		
1/2	1 1/4	1	6 1/4	.59	266H	6	1/2		
9/16	1 7/16	1 1/8	6 3/4	.85	267H	6	9/16		
5/8	1 9/16	1 1/4	7 1/2	.94	268H	6	5/8		
3/4	1 5/8	1 1/2	8 1/8	1.2	269H	6	3/4		
1 1/4	3	2 1/2	14 1/2	5.3	276H	1	1 1/4		

<p>Hexagon Opening</p>		Hexagon Opening 6-Point							
		Wrench Opening	Handle Offset in Clear from Face of Wrench	Diameter of Head	Length	Wt. Ea. Lbs.	Industrial Black	Std. Pkg. Qty.	Wrench Opening
							Part No.		
7/16	1 1/8	1 1/16	4 5/16	.21	263D	6	7/16		
1/2	1 1/4	3/4	5 1/8	.33	264A	6	1/2		
9/16	1 7/16	7/8	5 1/8	.46	265D	6	9/16		
5/8	1 9/16	1	6 1/4	.53	266D	6	5/8		
3/4	1 5/8	1 1/8	6 3/4	.79	267D	6	3/4		
7/8	2 1/4	1 1/8	8 3/8	1.02	269A	6	7/8		
1 1/16	2 1/4	1 1/2	9 1/8	1.7	270S	6	1 1/16		
1 1/8	2 3/4	1 3/8	10	1.8	271A	1	1 1/8		
1 1/2	3 1/4	1 3/4	11 1/4	2.7	273A	1	1 1/2		
1 3/8	3 3/4	2 1/8	13 1/4	4.1	275A	1	1 3/8		
1 1/2	3 3/4	2 1/2	13 3/4	4.1	275D	1	1 1/2		
1 3/4	3 3/4	2 3/4	14 1/2	5.8	276A	1	1 3/4		

TOOLS



Tee-Handle Socket Wrenches

Upset Forged from Carbon Steel

Special Lengths Can Be Ordered in Quantities.

Pin Handle Can Be Removed, Enabling Use of a Wrench on Hex End of Shank.

Square Opening 4-Point								
Wrench Opening	Diameter of Head	Size Hex on Handle End	Length of Pin Handle	Overall Length	Wt. Ea. Lbs.	Industrial Black	Std. Pkg. Qty.	Wrench Opening
						Part No.		
	A	B	C	D				
3/16	1/2	13/32	4 1/2	4 1/4	.12	961H	6	3/16
1/4	1/2	13/32	4 1/2	4 1/4	.12	961J	6	1/4
5/16	5/8	13/32	4 1/2	4 1/2	.17	962H	6	5/16
3/8	11/16	5/8	4 1/2	4 3/8	.29	963H	6	3/8
7/16	7/8	3/4	5 1/2	5 1/4	.57	965H	12	7/16
1/2	1	3/4	6 1/8	6 1/8	.68	966H	12	1/2
9/16	1 1/8	7/8	6 1/8	6 1/2	.94	967H	6	9/16
5/8	1 1/4	7/8	7	7	1.18	968H	6	5/8
3/4	1 1/2	7/8	7	7 3/8	1.20	969H	1	3/4
7/8	1 3/4	1 1/4	8 1/4	8 3/4	2.2	971H	1	7/8

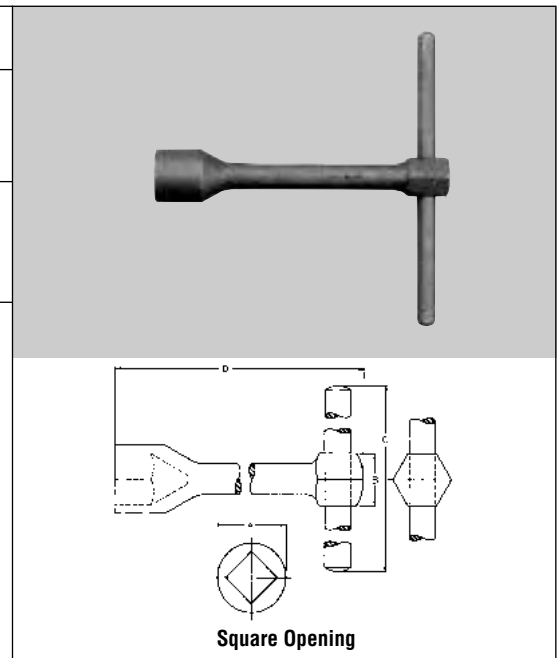

Hexagon Opening 6-Point								
Wrench Opening	Diameter of Head	Size Hex on Handle End	Length of Pin Handle	Overall Length	Wt. Ea. Lbs.	Industrial Black	Std. Pkg. Qty.	Wrench Opening
						Part No.		
	A	B	C	D				
5/16	1/2	13/32	4 1/2	4 1/4	.12	961A	6	5/16
3/8	5/8	13/32	4 1/2	4 1/2	.17	962D	6	3/8
7/16	11/16	5/8	4 1/2	4 3/8	.28	963D	6	7/16
1/2	3/4	13/16	5 1/2	5 1/4	.40	964A	12	1/2
9/16	7/8	3/4	5 1/2	5 3/4	.56	965D	12	9/16
5/8	1	3/4	6 1/8	6 1/8	.68	966D	12	5/8
11/16	1 1/8	7/8	6 1/8	6 1/2	.94	967A	6	11/16
3/4	1 1/4	7/8	6 1/8	6 1/2	.91	967D	6	3/4
7/8	1 1/2	7/8	7	7 3/8	1.24	969A	1	7/8
15/16	1 3/4	1 1/8	7 3/8	7 3/8	1.8	970S	1	15/16
1	1 3/4	1 1/8	7 3/8	7 3/8	1.9	970D	1	1
1 1/16	1 3/4	1 1/4	8 1/4	8 1/4	2.3	971A	1	1 1/16
1 1/4	1 3/4	1 1/4	8 3/4	8 3/4	2.2	971D	1	1 1/4
1 1/2	1 3/4	1 1/4	8 3/4	9	3.0	973A	1	1 1/2
1 3/4	1 3/4	1 1/4	8 3/4	9	2.9	973B	1	1 3/4
1 7/8	2	1 1/2	8 3/4	10	3.8	975D	1	1 7/8
2	2	1 3/4	10 3/4	10 3/4	5.5	976A	1	2

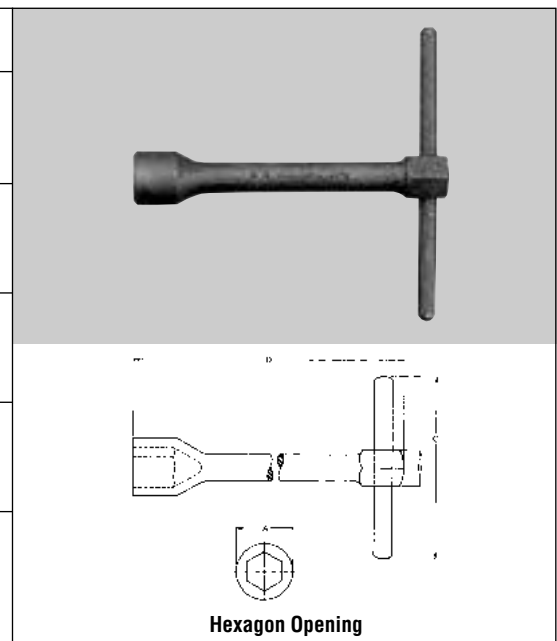

TOOLS

Mechanic's Starter Set Industrial



M46K

ADJUSTABLE WRENCHES

6"A6

COMBINATION WRENCH SET

1/4"1158	3/16"1167A
5/16"1159	7/8"1167
3/8"1160	Kit BagC110
7/16"1161	Kit BagC55
1/2"1162	15/16"1168
9/16"1163	1"1170
5/8"1164	1 1/16"1171
11/16"1165	1 1/8"1172
3/4"1166	1 1/4"1173

3/8" DRIVE SOCKET SET

1/4"B1208	3/16"B1226
5/16"B1210	7/8"B1228
3/8"B1212	15/16"B1230
7/16"B1214	1"B1232
1/2"B1216	7" Rev. Ratchet.....B52
9/16"B1218	3" Ext.....B103
5/8"B1220	6" Ext.....B105
11/16"B1222	UniversalB140A
3/4"B1224	Flex HandleB40A

HAMMERS

12 oz. Ball Peen104G

CHISEL & PUNCH

3/16" Pin PunchP6
 1/4" Center Punch.....P38
 1/2" Cold ChiselC16

PLIERS & SCREWDRIVERS

8" Combination Slip Joint Pliers.....P208
 6" Diagonal Cutting PliersP206
 6 1/2" Long Chain Nose Side Cutting PliersP506
 6" Square Blade ScrewdriverSDS6
 6" No. 3 Phillips ScrewdriverSDP6

M46KM

ADJUSTABLE WRENCHES

6"A6

COMBINATION WRENCH SET

7 mm.....1107MM	16 mm.....1116MM
8 mm.....1108MM	17 mm.....1117MM
9 mm.....1109MM	Kit BagC110
10 mm.....1110MM	Kit BagC55
11 mm.....1111MM	24 mm.....1124MM
12 mm.....1112MM	26 mm.....1126MM
13 mm.....1113MM	28 mm.....1128MM
14 mm.....1114MM	29 mm.....1129MM
15 mm.....1115MM	30 mm.....1130MM

3/8" DRIVE SOCKET SET

8 mm.....BM1208	17 mm.....BM1217
9 mm.....BM1209	18 mm.....BM1218
10 mm.....BM1210	19 mm.....BM1219
11 mm.....BM1211	AdaptorBS130
12 mm.....BM1212	7" Rev. RatchetB52
13 mm.....BM1213	3" Ext.....B103
14 mm.....BM1214	6" Ext.....B105
15 mm.....BM1215	UniversalB140A
16 mm.....BM1216	Flex HandleB40A

HAMMERS

12 oz. Ball Peen104G

CHISEL & PUNCH

3/16" Pin Punch.....P6
 1/4" Center PunchP38
 1/2" Cold Chisel.....C16

PLIERS & SCREWDRIVERS

8" Combination Slip Joint PliersP208
 6" Diagonal Cutting PliersP206
 6 1/2" Long Chain Nose Side Cutting Pliers.....P506
 6" Square Blade Screwdriver.....SDS6
 6" No. 3 Phillips ScrewdriverSDP6

TOOLS

Martin

Mechanic's Set Industrial

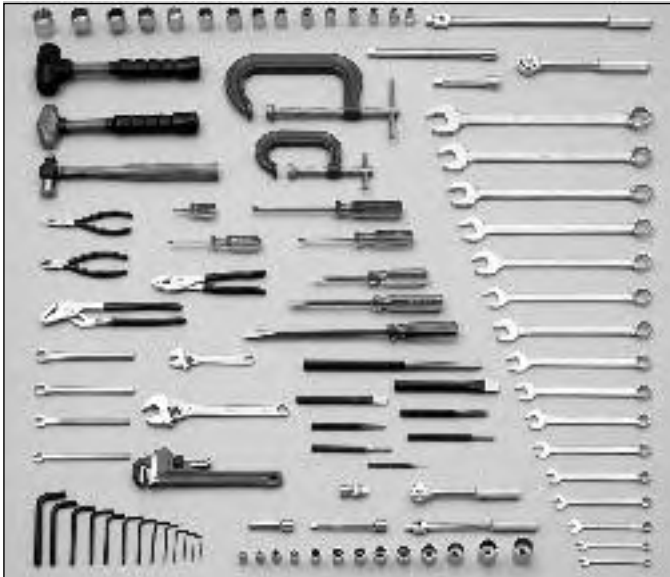

TOOL BOX INCLUDED...BX26



M100K

3/8" DRIVE SOCKET SET		
1/4".....B1208	13/16".....B1226	
5/16".....B1210	7/8".....B1228	
3/8".....B1212	15/16".....B1230	
7/16".....B1214	1".....B1232	
1/2".....B1216	3" Ext.....B103	
9/16".....B1218	6" Ext.....B105	
5/8".....B1220	Flex Handle.....B40A	
11/16".....B1222	Universal Joint.....B140A	
3/4".....B1224	7" Rev. Ratchet.....B52	
1/2" DRIVE SOCKET SET		
3/8".....ST1212	1".....ST1232	
7/16".....ST1214	1 1/8".....ST1234	
1/2".....ST1216	1 1/4".....ST1236	
9/16".....ST1218	1 3/8".....ST1238	
5/8".....ST1220	1 1/2".....ST1240	
11/16".....ST1222	5" Ext.....S110P	
3/4".....ST1224	10" Ext.....S115P	
13/16".....ST1226	Flex Handle.....SF41	
7/8".....ST1228	Rev. Ratchet.....SF51	
15/16".....ST1230		
COMBINATION WRENCHES		
1/4".....1158	5/16".....1168	
5/16".....1159	1".....1170	
3/8".....1160	1 1/8".....1171	
7/16".....1161	1 1/4".....1172	
1/2".....1162	1 1/2".....1173	
9/16".....1163	Kit Bag.....C55	
5/8".....1164	FLARE NUT WRENCHES	
11/16".....1165	3/8".....4112	
3/4".....1166	7/16".....4114	
13/16".....1167A	1/2".....4116	
7/8".....1167	9/16".....4118	
Kit Bag.....C110		
C-CLAMPS		
0-3.....CC403		
0-6 1/16.....CC406		
HAMMERS		
12 oz.....104G		
1.50 lbs.....HSB15		
1.25 lbs.....HPD 1		
CHISEL & PUNCH		
3/16" Pin.....P6		
3/16" Center.....P40		
1/2" Cold.....C16		
1/4" Pin.....P8		
3/4" Center.....P42		
3/4" Cold.....C24		
1/16" Pin.....P2		
1/4" Taper.....P27		
SCREWDRIVERS & PLIERS		
8" Combo.....P208		
6" Diagonal.....P206		
6 1/2" Chain Nose.....P506		
10" Groove.....P510		
4" Square Blade.....SDS4		
6" Square Blade.....SDS6		
10" Square Blade.....SDS10		
3" Phillips No. 1.....SDP3		
4" Phillips No. 2.....SDP4		
6" Phillips No. 3.....SDP6		
1 1/2" Stubby No. 2.....SDP1		
HEX KEY WRENCH SET		
13 pcs. Short Arm Series...13S		
ADJUSTABLE & PIPE WRENCHES		
6".....A6		
10".....A10		
10".....PW10		

M100KM

3/8" DRIVE SOCKET SET		
8 mm.....BM1208	17mm.....BM1217	
9 mm.....BM1209	18 mm.....BM1218	
10 mm.....BM1210	19 mm.....BM1219	
11 mm.....BM1211	Adaptor.....BS130	
12 mm.....BM1212	3" Ext.....B103	
13 mm.....BM1213	5" Ext.....B105	
14 mm.....BM1214	Flex Handle.....B40A	
15 mm.....BM1215	Universal Joint.....B140A	
16 mm.....BM1216	7" Rev. Ratchet.....B52	
1/2" DRIVE SOCKET SET		
10 mm.....STM1210	25 mm.....STM1225	
11 mm.....STM1211	26 mm.....STM1226	
12 mm.....STM1212	27 mm.....STM1227	
13 mm.....STM1213	30 mm.....STM1230	
14 mm.....STM1215	32 mm.....STM1232	
17 mm.....STM1217	5" Ext.....S110P	
19 mm.....STM1219	10" Ext.....S115P	
22 mm.....STM1222	Flex Handle.....SF41	
23 mm.....STM1223	Rev. Ratchet.....SF51	
24 mm.....STM1224		
COMBINATION WRENCHES		
7 mm.....1107MM	24 mm.....1124MM	
8 mm.....1108MM	26 mm.....1126MM	
9 mm.....1109MM	28 mm.....1128MM	
10 mm.....1110MM	29 mm.....1129MM	
11 mm.....1111MM	30 mm.....1130MM	
12 mm.....1112MM	Kit Bag.....C55	
13 mm.....1113MM	FLARE NUT WRENCHES	
14 mm.....1114MM	3/8".....4112	
15 mm.....1115MM	7/16".....4114	
16 mm.....1116MM	1/2".....4116	
17 mm.....1117MM	9/16".....4118	
Kit Bag.....C110		
C-CLAMPS		
0-3.....CC403		
0-6 1/16.....CC406		
HAMMERS		
12 oz.....104G		
1.50 lbs.....HSB15		
1.25 lbs.....HPD 1		
CHISEL & PUNCH		
3/16" Pin.....P6		
3/16" Center.....P40		
1/2" Cold.....C16		
1/4" Pin.....P8		
3/4" Center.....P42		
3/4" Cold.....C24		
1/16" Pin.....P2		
1/4" Taper.....P27		
PLIERS & SCREWDRIVERS		
8" Combo.....P208		
6" Diagonal.....P206		
6 1/2" Chain Nose.....P506		
10" Groove.....P510		
4" Square Blade.....SDS4		
6" Square Blade.....SDS6		
10" Square Blade.....SDS10		
3" Phillips No. 1.....SDP3		
4" Phillips No. 2.....SDP4		
6" Phillips No. 3.....SDP6		
1 1/2" Stubby No. 2.....SDP1		
HEX KEY WRENCH SET		
13 pcs. Short Arm Series...13S		
ADJUSTABLE & PIPE WRENCHES		
6".....A6		
10".....A10		
10".....PW10		

TOOLS

1/4" and 3/8" Drive Master Sets



MB20K	
1/4" DRIVE SOCKET SET	
M606 3/16" 6 pt. Std. Skt.	M106 Spinner Handle
M607 7/32" 6 pt. Std. Skt.	
M608 1/4" 6 pt. Std. Skt.	
M609 9/32" 6 pt. Std. Skt.	
M610 5/16" 6 pt. Std. Skt.	
M611 11/32" 6 pt. Std. Skt.	
3/8" DRIVE SOCKET SET	
B612 3/8" 6 pt. Std. Skt.	B52 8" Reversible Ratchet
B614 7/16" 6 pt. Std. Skt.	B103 3" Extension
B616 1/2" 6 pt. Std. Skt.	B105 6" Extension
B618 9/16" 6 pt. Std. Skt.	BD620P 5/8" Spark Plug Skt.
B620 5/8" 6 pt. Std. Skt.	BS129 Adaptor 3/8"F to 1/4"M
B622 11/16" 6 pt. Std. Skt.	98 METAL BOX
B624 3/4" 6 pt. Std. Skt.	
B626 13/16" 6 pt. Std. Skt.	



MBM20K	
1/4" DRIVE SOCKET SET	
MM605 ... 5 mm 6 Pt. Std. Skt.	M106 Spinner Handle
MM606 ... 6 mm 6 Pt. Std. Skt.	
MM607 ... 7 mm 6 Pt. Std. Skt.	
MM608 ... 8 mm 6 Pt. Std. Skt.	
MM609 ... 9 mm 6 Pt. Std. Skt.	
MM610 ... 10 mm 6 Pt. Std. Skt.	
3/8" DRIVE SOCKET SET	
BM612 12 mm 6 Pt. Std. Skt.	B52 8" Reversible Ratchet
BM613 13 mm 6 Pt. Std. Skt.	B103 3" Extension
BM614 14 mm 6 Pt. Std. Skt.	B105 6" Extension
BM615 15 mm 6 Pt. Std. Skt.	BD620P 5/8" Spark Plug Skt.
BM616 16 mm 6 Pt. Std. Skt.	BS129 Adaptor 3/8"F to 1/4"M
BM617 17 mm 6 Pt. Std. Skt.	98 METAL BOX
BM618 18 mm 6 Pt. Std. Skt.	
BM619 19 mm 6 Pt. Std. Skt.	







MB28K	
1/4" DRIVE SOCKET SET	
M608 1/4" 6 pt. Std. Skt.	MM607 ... 7 mm 6 Pt. Std. Skt.
M609 9/32" 6 pt. Std. Skt.	MM608 ... 8 mm 6 Pt. Std. Skt.
M610 5/16" 6 pt. Std. Skt.	MM609 ... 9 mm 6 Pt. Std. Skt.
M611 11/32" 6 pt. Std. Skt.	MM610 ... 10 mm 6 Pt. Std. Skt.
M612 3/8" 6 pt. Std. Skt.	MM611 ... 11 mm 6 Pt. Std. Skt.
	M106 Spinner Handle
3/8" DRIVE SOCKET SET	
B614 7/16" 6 pt. Std. Skt.	BM615 15 mm 6 Pt. Std. Skt.
B616 1/2" 6 pt. Std. Skt.	BM617 17 mm 6 Pt. Std. Skt.
B618 9/16" 6 pt. Std. Skt.	BM619 19 mm 6 Pt. Std. Skt.
B620 5/8" 6 pt. Std. Skt.	B52 8" Reversible Ratchet
B622 11/16" 6 pt. Std. Skt.	B103 3" Extension
B624 3/4" 6 pt. Std. Skt.	B105 6" Extension
BM612 12 mm 6 Pt. Std. Skt.	BD620P .. 5/8" Spark Plug Skt.
Skt.	BS129 Adaptor 3/8"F to 1/4"M
BM613 13 mm 6 Pt. Std. Skt.	98 METAL BOX
Skt.	



TOOLS



1/4" Drive Sockets & Attachments — Chrome

Type	Item	Description	Part No.	Std. Pkg. Qty.
Ratchet		Chrome .43 tooth. Head dia. 1" . Length 5 1/2" . Weight .40 lbs.	M52	6
Ratchet Replacement Head		Preassembled Ratchet Replacement Head. Weight .19 lbs.	M52RD	1
Extension Bar		3" Extension Bar. Weight .17 lbs.	M103	6
Spinner		Spinner Handle. Length 6" .	M106	6

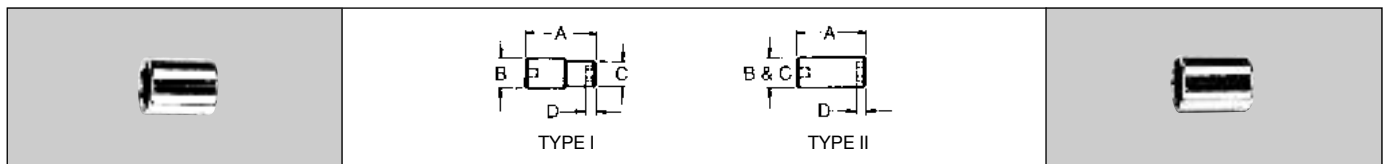

1/4" Square Drive 12 Point Standard

Opening	Type	Length	Drive End	Opening End	Minimum Depth	Wt. Ea. Lbs.	Chrome	Std. Pkg. Qty.	Opening
							Part No.		
3/16	I	13/16	31/64	3/16	7/32	.01	M1206	6	3/16
7/32	I	13/16	31/64	23/64	15/64	.01	M1207	6	7/32
1/4	I	13/16	31/64	25/64	1/4	.01	M1208	6	1/4
9/32	I	13/16	31/64	7/16	19/64	.02	M1209	6	9/32
5/16	II	13/16	31/64	31/64	21/64	.02	M1210	6	5/16
11/32	II	13/16	33/64	33/64	21/64	.03	M1211	6	11/32
3/8	II	13/16	9/16	9/16	3/16	.03	M1212	6	3/8
7/16	II	13/16	5/8	5/8	21/64	.04	M1214	6	7/16
1/2	II	13/16	49/64	49/64	13/32	.04	M1216	6	1/2

1/4" Square Drive 6 Point Standard

Opening	Type	Length	Drive End	Opening End	Minimum Depth	Wt. Ea. Lbs.	Chrome	Std. Pkg. Qty.	Opening
							Part No.		
5/32	I	13/16	31/64	9/32	7/32	.01	M605	6	5/32
3/16	I	13/16	31/64	3/16	7/32	.01	M606	6	3/16
7/32	I	13/16	31/64	23/64	15/64	.01	M607	6	7/32
1/4	I	13/16	31/64	25/64	1/4	.01	M608	6	1/4
9/32	I	13/16	31/64	7/16	19/64	.02	M609	6	9/32
5/16	II	13/16	31/64	31/64	21/64	.02	M610	6	5/16
11/32	II	13/16	33/64	33/64	21/64	.03	M611	6	11/32
3/8	II	13/16	9/16	9/16	3/16	.03	M612	6	3/8
7/16	II	13/16	5/8	5/8	21/64	.04	M614	6	7/16
1/2	II	13/16	49/64	49/64	13/32	.04	M616	6	1/2

TOOLS

1/4" Drive Sockets & Sets — Chrome

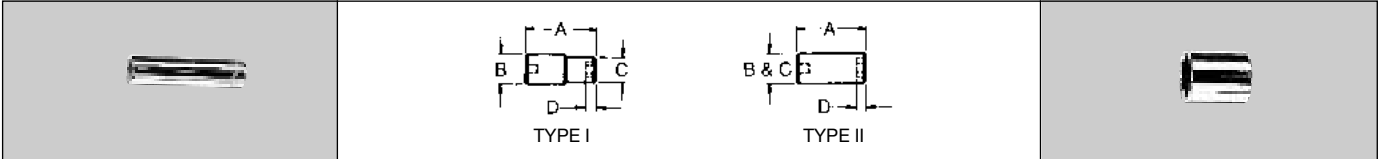

1/4" Square Drive 6 Point Deep									
Opening	Type	Length	Drive End	Opening End	Minimum Depth	Wt. Ea. Lbs.	Chrome	Std. Pkg. Qty.	Opening
		A	B	C	D		Part No.		
3/16	I	1 ⁶¹ / ₆₄	1 ¹ / ₃₂	3/16	1 ¹ / ₆₄	.05	MD606	6	3/16
7/32	I	1 ⁶¹ / ₆₄	1 ¹ / ₃₂	2 ³ / ₆₄	1 ¹ / ₆₄	.06	MD607	6	7/32
1/4	I	1 ⁶¹ / ₆₄	1 ¹ / ₃₂	2 ⁵ / ₆₄	1 ¹ / ₃₂	.06	MD608	6	1/4
9/32	I	1 ⁶¹ / ₆₄	1 ¹ / ₃₂	7/16	1 ¹ / ₃₂	.06	MD609	6	9/32
5/16	II	1 ⁶¹ / ₆₄	1 ¹ / ₃₂	1 ¹ / ₃₂	1 ¹ / ₃₂	.06	MD610	6	5/16
1 ¹ / ₃₂	II	1 ⁶¹ / ₆₄	3 ³ / ₆₄	3 ³ / ₆₄	3 ³ / ₆₄	.06	MD611	6	1 ¹ / ₃₂
3/8	II	1 ⁶¹ / ₆₄	3 ⁷ / ₆₄	3 ⁷ / ₆₄	3 ⁵ / ₆₄	.09	MD612	6	3/8
7/16	II	1 ⁶¹ / ₆₄	3/8	3/8	3 ⁵ / ₆₄	.09	MD614	6	7/16
1/2	II	1 ⁶¹ / ₆₄	4 ⁵ / ₆₄	4 ⁵ / ₆₄	3 ⁵ / ₆₄	.11	MD616	6	1/2

1/4" Square Drive 6 Point Standard — Metric									
Opening	Type	Length	Drive End	Opening End	Minimum Depth	Wt. Ea. Lbs.	Chrome	Std. Pkg. Qty.	Opening
		A	B	C	D		Part No.		
4 mm	I	21.1 mm	12.1 mm	7.1 mm	5.3 mm	.05	MM604	6	4 mm
5 mm	I	21.1 mm	12.1 mm	8.6 mm	5.1 mm	.05	MM605	6	5 mm
6 mm	I	21.1 mm	12.1 mm	10.2 mm	6.6 mm	.05	MM606	6	6 mm
7 mm	I	21.1 mm	12.1 mm	11.2 mm	7.6 mm	.05	MM607	6	7 mm
8 mm	II	21.1 mm	12.1 mm	12.2 mm	8.4 mm	.05	MM608	6	8 mm
9 mm	II	21.1 mm	14.2 mm	14.2 mm	8.4 mm	.06	MM609	6	9 mm
10 mm	II	21.1 mm	14.9 mm	14.9 mm	8.4 mm	.06	MM610	6	10 mm
11 mm	II	21.1 mm	16.0 mm	16.0 mm	8.4 mm	.06	MM611	6	11 mm
12 mm	II	21.1 mm	17.0 mm	17.0 mm	9.1 mm	.07	MM612	6	12 mm
13 mm	II	21.1 mm	17.8 mm	17.8 mm	10.2 mm	.08	MM613	6	13 mm

M12K	
M606..... 3/16" 6 Pt. Std. Skt.	M612..... 3/8" 6 Pt. Std. Skt.
M607..... 7/32" 6 Pt. Std. Skt.	M614..... 7/16" 6 Pt. Std. Skt.
M608..... 1/4" 6 Pt. Std. Skt.	M616..... 1/2" 6 Pt. Std. Skt.
M609..... 9/32" 6 Pt. Std. Skt.	M52..... RATCHET
M610..... 5/16" 6 Pt. Std. Skt.	M103..... 3" EXTENSION BAR
M611..... 11/32" 6 Pt. Std. Skt.	M106..... 6" SPINNER
	91..... METAL BOX



M12KM		METRIC
MM604..... 4 mm 6 Pt. Std. Skt.	MM610..... 10 mm 6 Pt. Std. Skt.	
MM605..... 5 mm 6 Pt. Std. Skt.	MM612..... 12 mm 6 Pt. Std. Skt.	
MM606..... 6 mm 6 Pt. Std. Skt.	MM613..... 13 mm 6 Pt. Std. Skt.	
MM607..... 7 mm 6 Pt. Std. Skt.	M52..... RATCHET	
MM608..... 8 mm 6 Pt. Std. Skt.	M103..... 3" EXTENSION BAR	
MM609..... 9 mm 6 Pt. Std. Skt.	M106..... 6" SPINNER	
	91..... METAL BOX	



TOOLS

Type		Description	Part No.	Std. Pkg. Qty.
FLEXIBLE HANDLE		Chrome Knurled Grip. Length 7³/₁₆" . Weight .59 lbs.	B40A	6
REVERSIBLE RATCHET		Chrome. 41 tooth. Head dia. 1¹/₄" . Length 8" . Weight .69 lbs.	B52	6
		Preassembled Ratchet Replacement Head. Weight .19 lbs.	B52RD	1
FLEXIBLE HEAD RATCHET		Flex Head Reversible Ratchet. Chrome. Length 10¹/₂" . 70 lbs.	B54	6
		Preassembled Flexible Ratchet Replacement Head. .19 lbs.	B54RD	1
EXTENSIONS		Chrome. Length 3" . Weight .17 lbs.	B103	6
		Chrome. Length 6" . Weight .20 lbs.	B105	6
		Chrome. Length 12" . Weight .42 lbs.	B112	6
UNIVERSAL JOINT		Chrome. Weight .13 lbs.	B140A	6
ADAPTORS		Chrome. 3/8" F to 1/4" M . Weight .06 lbs.	BS129	6
		Chrome. 3/8" F to 1/2" M . Weight .09 lbs.	BS130	6
SPEEDER		Chrome. Revolving Grip. Length 16" . Weight 1.1 lbs.	B15	6

3/8" Drive Socket Wrenches Chrome

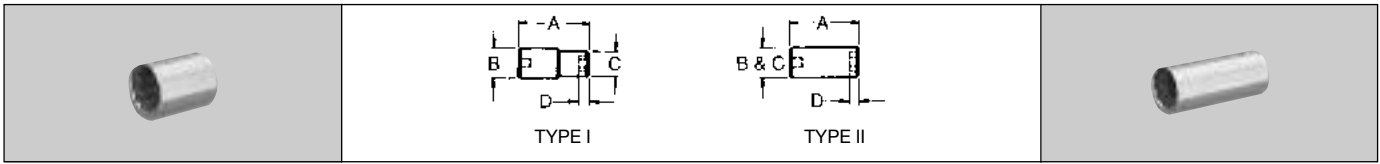

3/8" Square Drive 12 Point Standard

Opening	Type	Length				Wt. Ea. Lbs.	Chrome	Std. Pkg. Qty.	Opening
		A	B	C	D		Part No.		
1/4	I	1 1/8	5/8	25/64	1/8	.04	B1208	6	1/4
5/16	I	1 1/8	5/8	15/32	9/64	.05	B1210	6	5/16
3/8	I	1 1/8	5/8	39/64	7/32	.05	B1212	6	3/8
7/16	II	1 1/8	—	5/8	7/32	.05	B1214	6	7/16
1/2	II	1 1/8	—	23/32	17/64	.06	B1216	6	1/2
9/16	II	1 1/8	—	25/32	21/64	.08	B1218	6	9/16
5/8	II	1 1/8	—	7/8	3/8	.10	B1220	6	5/8
11/16	II	1 1/8	—	15/16	3/8	.12	B1222	6	11/16
3/4	II	1 1/8	—	1	7/16	.14	B1224	6	3/4
13/16	II	1 3/16	—	1 1/16	29/64	.15	B1226	6	13/16
7/8	II	1 1/4	—	1 1/4	1/2	.18	B1228	6	7/8
15/16	II	1 1/8	—	1 1/4	35/64	.18	B1230	6	15/16
1	II	1 5/8	—	1 1/2	35/64	.19	B1232	6	1

3/8" Square Drive 12 Point Deep

Opening	Type	Length				Wt. Ea. Lbs.	Chrome	Std. Pkg. Qty.	Opening
		A	B	C	D		Part No.		
3/8	I	2 1/32	5/8	35/64	5/32	.10	BD1212	6	3/8
7/16	II	2 1/32	—	5/8	7/32	.10	BD1214	6	7/16
1/2	II	2 1/32	—	23/32	17/64	.15	BD1216	6	1/2
9/16	II	2 1/32	—	25/32	21/64	.19	BD1218	6	9/16
5/8	II	2 1/32	—	7/8	3/8	.23	BD1220	6	5/8
11/16	II	2 1/2	—	59/64	3/8	.28	BD1222	6	11/16
3/4	II	2 1/2	—	63/64	7/16	.26	BD1224	6	3/4
13/16	II	2 25/32	—	1 1/16	29/64	.48	BD1226	6	13/16
7/8	II	2 7/8	—	1 1/2	1/2	.39	BD1228	6	7/8

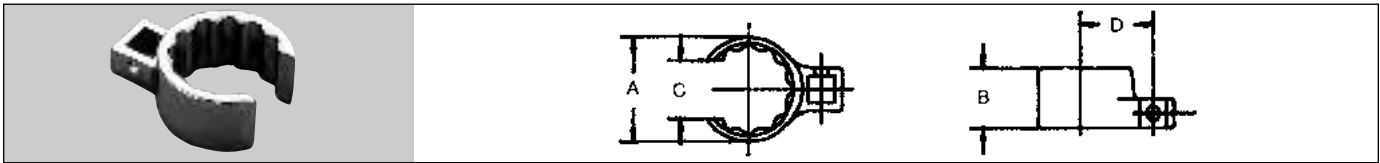

3/8" Drive Crowfoot Wrench — Flare Nut 12 Pt.

Opening	Diameter of Head	Thickness of Head	Width of Slot	Length of Centers	Wt. Ea. Lbs.	Chrome	Industrial Black	Std. Pkg. Qty.	Opening
	A	B	C	D		Part No.	Part No.		
3/8	15/16	1 1/16	1 1/32	47/64	.06	BC20	BLKBC20	6	3/8
1/2	1 1/32	1 1/16	1 1/32	25/32	.06	BC22	BLKBC22	6	1/2
3/4	1 1/8	23/32	9/16	53/64	.06	BC24	BLKBC24	6	3/4
13/16	1 13/64	23/32	5/8	7/8	.06	BC26	BLKBC26	6	13/16
7/8	1 19/64	3/4	1 1/16	1 1/16	.06	BC28	BLKBC28	6	7/8
15/16	1 3/8	3/4	25/32	1 1/16	.06	BC30	BLKBC30	6	15/16
1	1 29/64	25/32	3/4	1 1/4	.13	BC32	BLKBC32	6	1
1 1/16	1 17/32	25/32	25/32	1 3/4	.13	BC34	BLKBC34	6	1 1/16

TOOLS

Martin

3/8" Drive Socket Wrenches — Chrome

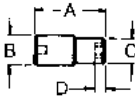

TYPE I

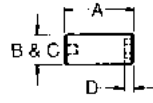

TYPE II



3/8" Square Drive 6 Point Standard

Opening	Type	Length	Drive End	Opening End	Minimum Depth	Wt. Ea. Lbs.	Chrome	Std. Pkg. Qty.	Opening
		A	B	C	D		Part No.		
1/4	I	1 1/8	5/8	25/64	1/8	.04	B608	6	1/4
3/16	I	1 1/8	5/8	19/32	3/64	.04	B610	6	3/16
3/8	I	1 1/8	5/8	35/64	5/32	.05	B612	6	3/8
7/16	II	1 1/8	—	5/8	7/32	.05	B614	6	7/16
1/2	II	1 1/8	—	23/32	17/64	.07	B616	6	1/2
9/16	II	1 1/8	—	25/32	21/64	.08	B618	6	9/16
5/8	II	1 1/8	—	—	7/8	.10	B620	6	5/8
11/16	II	1 1/8	—	15/16	3/8	.13	B622	6	11/16
3/4	II	1 1/8	—	1	7/16	.14	B624	6	3/4
13/16	II	1 3/8	—	1 1/16	29/64	.17	B626	6	13/16
7/8	II	1 1/4	—	1 1/4	1/2	.19	B628	6	7/8
15/16	II	1 1/2	—	1 1/2	35/64	.29	B630	6	15/16
1	II	1 5/8	—	1 5/8	39/64	.33	B632	6	1

3/8" Square Drive 6 Point Deep

Opening	Type	Length	Drive End	Opening End	Minimum Depth	Wt. Ea. Lbs.	Chrome	Std. Pkg. Qty.	Opening
		A	B	C	D		Part No.		
1/4	I	2 1/32	5/8	3/8	5/32	.10	BD608	6	1/4
3/16	I	2 1/32	5/8	7/16	3/32	.11	BD610	6	3/16
3/8	I	2 1/32	5/8	35/64	5/32	.12	BD612	6	3/8
7/16	II	2 1/32	—	5/8	7/32	.12	BD614	6	7/16
1/2	II	2 1/32	—	23/32	17/64	.16	BD616	6	1/2
9/16	I	2 1/4	59/64	13/16	11/32	.25	BD618	6	9/16
5/8	I	2 1/4	59/64	57/64	3/8	.30	BD620	6	5/8
11/16	II	2 3/16	—	61/64	3/8	.32	BD622	6	11/16
3/4	II	2 3/16	—	1 3/64	7/16	.37	BD624	6	3/4
13/16	II	2 25/32	—	1 1/16	29/64	.32	BD626	6	13/16
7/8	II	2 1/2	—	1 1/32	1/2	.39	BD628	6	7/8
15/16	II	3 3/64	—	1 1/4	35/64	.41	BD630	6	15/16
1	II	3 3/64	—	1 1/2	39/64	.41	BD632	6	1

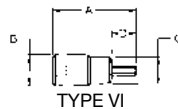

TYPE VI

3/8" Drive Hex Bit Sockets

Bit Size	Type	Length	Drive End	Opening End	Bit Length	Wt. Ea. Lbs.	Chrome	Replacement Hex Bits	Std. Pkg. Qty.	Bit Size
		A	B	C	D		Part No.			
1/8	I	2 1/4	5/8	15/32	15/16	.06	BA4	BA4B	6	1/8
5/32	I	2 1/4	5/8	15/32	15/16	.06	BA5	BA5B	6	5/32
3/16	I	2 1/4	5/8	15/32	15/16	.06	BA6	BA6B	6	3/16
7/32	I	2 1/4	5/8	33/64	15/16	.07	BA7	BA7B	6	7/32
1/4	I	2 1/4	5/8	9/16	15/16	.08	BA8	BA8B	6	1/4
5/16	II	2 1/4	—	5/8	15/16	.10	BA10	BA10B	6	5/16
3/8	II	2 1/2	—	11/16	15/16	.13	BA12	BA12B	6	3/8

TOOLS

3/8" Drive Socket Wrenches — Chrome

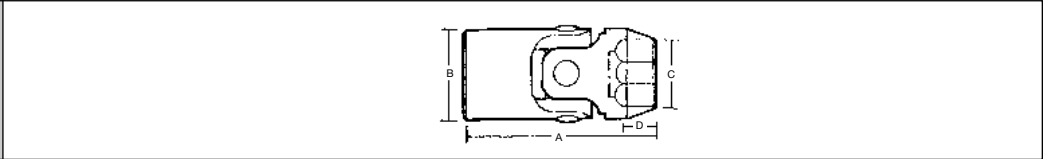

3/8" Square Drive 6 Point Flex Socket

Opening	Length	Drive End	Opening End	Minimum Depth	Wt. Ea. Lbs.	Chrome	Std. Pkg. Qty.	Opening
	A	B	C	D		Part No.		
3/8	1 ⁴⁹ / ₆₄	3/4	37/64	15/64	.09	BU612	6	3/8
7/16	1 ⁵⁵ / ₆₄	3/4	43/64	5/16	.09	BU614	6	7/16
1/2	1 ⁵⁷ / ₆₄	3/4	3/4	23/64	.13	BU616	6	1/2
9/16	1 ⁵⁷ / ₆₄	3/4	13/16	25/64	.13	BU618	6	9/16
5/8	1 ¹⁹ / ₆₄	3/4	7/8	7/16	.14	BU620	6	5/8
11/16	1 ³¹ / ₃₂	3/4	31/32	15/32	.18	BU622	6	11/16
3/4	2 ¹ / ₈	3/4	1 ³ / ₆₄	33/64	.19	BU624	6	3/4

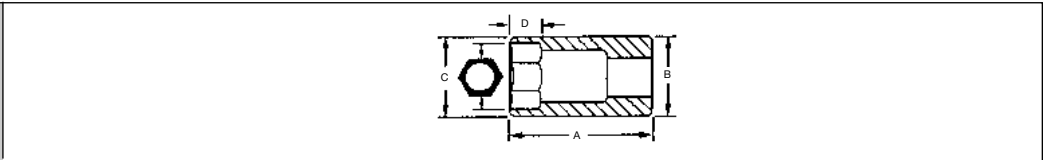

3/8" Square Drive Spark Plug Sockets — Chrome

Opening	Length	Drive End	Opening End	Minimum Depth	Wt. Ea. Lbs.	Chrome	Std. Pkg. Qty.	Opening
	A	B	C	D		Part No.		
5/8	2 ¹ / ₂	3/4	55/64	51/64	.28	BD620P	6	5/8
13/16	2 ³ / ₄	7/8	1 ⁵ / ₆₄	51/64	.35	BD626P	6	13/16

TOOLS



3/8" Drive Sockets & Sets — Chrome

B7K

BU612 3/8" 6 Pt. Flex Skt.	BU620 3/8" 6 Pt. Flex Skt.
BU614 7/16" 6 Pt. Flex Skt.	BU622 11/16" 6 Pt. Flex Skt.
BU616 1/2" 6 Pt. Flex Skt.	BU624 3/4" 6 Pt. Flex Skt.
BU618 5/8" 6 Pt. Flex Skt.	247 CLIP RAIL



BA7K

BA4..... 1/8" Hex Type Skt. 3/8" DR	BA8..... 1/4" Hex Type Skt. 3/8" DR
BA5..... 5/32" Hex Type Skt. 3/8" DR	BA10..... 5/16" Hex Type Skt. 3/8" DR
BA6..... 3/16" Hex Type Skt. 3/8" DR	BA12..... 3/8" Hex Type Skt. 3/8" DR
BA7..... 7/32" Hex Type Skt. 3/8" DR	242 CLIP RAIL



BC8K

BC20 3/8" 12 Pt. Crowfoot	BC30 13/16" 12 Pt. Crowfoot
BC22 11/16" 12 Pt. Crowfoot	BC32 1" 12 Pt. Crowfoot
BC24 3/4" 12 Pt. Crowfoot	BC34 1 1/16" 12 Pt. Crowfoot
BC26 13/16" 12 Pt. Crowfoot	244 CLIP RAIL
BC28 7/8" 12 Pt. Crowfoot	



B9K

BD1212 3/8" 12 Pt. Deep Skt.	BD1222 1 1/16" 12 Pt. Deep Skt.
BD1214 7/16" 12 Pt. Deep Skt.	BD1224 3/4" 12 Pt. Deep Skt.
BD1216 1/2" 12 Pt. Deep Skt.	BD1226 13/16" 12 Pt. Deep Skt.
BD1218 5/8" 12 Pt. Deep Skt.	BD1228 7/8" 12 Pt. Deep Skt.
BD1220 3/4" 12 Pt. Deep Skt.	245 CLIP RAIL



TOOLS

3/8" Drive Sockets & Sets — Chrome



	BD9K	
	BD612 3/8" 6 Pt. Deep Skt. BD614 7/16" 6 Pt. Deep Skt. BD616 1/2" 6 Pt. Deep Skt. BD618 9/16" 6 Pt. Deep Skt. BD620 5/8" 6 Pt. Deep Skt.	BD622 11/16" 6 Pt. Deep Skt. BD624 3/4" 6 Pt. Deep Skt. BD626 13/16" 6 Pt. Deep Skt. BD628 7/8" 6 Pt. Deep Skt. 245 CLIP RAIL

	B10K	
	B1210 5/16" 12 Pt. Std. Skt. B1212 3/8" 12 Pt. Std. Skt. B1214 7/16" 12 Pt. Std. Skt. B1216 1/2" 12 Pt. Std. Skt. B1218 9/16" 12 Pt. Std. Skt. B1220 5/8" 12 Pt. Std. Skt.	B1222 11/16" 12 Pt. Std. Skt. B1224 3/4" 12 Pt. Std. Skt. B1226 13/16" 12 Pt. Std. Skt. B1228 7/8" 12 Pt. Std. Skt. 246 CLIP RAIL

	BD10K	
	B610 5/16" 6 Pt. Std. Skt. B612 3/8" 6 Pt. Std. Skt. B614 7/16" 6 Pt. Std. Skt. B616 1/2" 6 Pt. Std. Skt. B618 9/16" 6 Pt. Std. Skt. B620 5/8" 6 Pt. Std. Skt.	B622 11/16" 6 Pt. Std. Skt. B624 3/4" 6 Pt. Std. Skt. B626 13/16" 6 Pt. Std. Skt. B628 7/8" 6 Pt. Std. Skt. 246 CLIP RAIL

	B11K	
	B608 1/4" 6 Pt. Std. Skt. B610 5/16" 6 Pt. Std. Skt. B612 3/8" 6 Pt. Std. Skt. B614 7/16" 6 Pt. Std. Skt. B616 1/2" 6 Pt. Std. Skt. B618 9/16" 6 Pt. Std. Skt.	B620 5/8" 6 Pt. Std. Skt. B622 11/16" 6 Pt. Std. Skt. B624 3/4" 6 Pt. Std. Skt. B626 13/16" 6 Pt. Std. Skt. B628 7/8" 6 Pt. Std. Skt. 249 CLIP RAIL

TOOLS

B11KM

B612..... 3/8" 6 Pt. Std. Skt.	B1224..... 1/4" 12 Pt. Std. Skt.
B614..... 7/16" 6 Pt. Std. Skt.	B1226..... 13/16" 12 Pt. Std. Skt.
B616..... 1/2" 6 Pt. Std. Skt.	B1228..... 7/8" 12 Pt. Std. Skt.
B618..... 9/16" 6 Pt. Std. Skt.	B52..... RATCHET
B1220..... 5/8" 12 Pt. Std. Skt.	B105..... 6" EXTENSION
B1222..... 11/16" 12 Pt. Std. Skt.	25..... METAL BOX



B11RK

B610..... 5/16" 6 Pt. Std. Skt.	B622..... 1/16" 6 Pt. Std. Skt.
B612..... 3/8" 6 Pt. Std. Skt.	B624..... 3/4" 6 Pt. Std. Skt.
B614..... 7/16" 6 Pt. Std. Skt.	B52..... REVERSIBLE RATCHET
B616..... 1/2" 6 Pt. Std. Skt.	B103..... 3" EXTENSION
B618..... 9/16" 6 Pt. Std. Skt.	BD620P..... 5/8" SPARK PLUG SKT.
B620..... 5/8" 6 Pt. Std. Skt.	93..... METAL BOX



B12K

B1212..... 3/8" 12 Pt. Std. Skt.	B1226..... 13/16" 12 Pt. Std. Skt.
B1214..... 7/16" 12 Pt. Std. Skt.	B1228..... 7/8" 12 Pt. Std. Skt.
B1216..... 1/2" 12 Pt. Std. Skt.	B52..... REVERSIBLE RATCHET
B1218..... 9/16" 12 Pt. Std. Skt.	B103..... 3" EXTENSION
B1220..... 5/8" 12 Pt. Std. Skt.	B105..... 6" EXTENSION
B1222..... 11/16" 12 Pt. Std. Skt.	93..... METAL BOX
B1224..... 3/4" 12 Pt. Std. Skt.	



3/8" Drive Sockets & Sets — Chrome

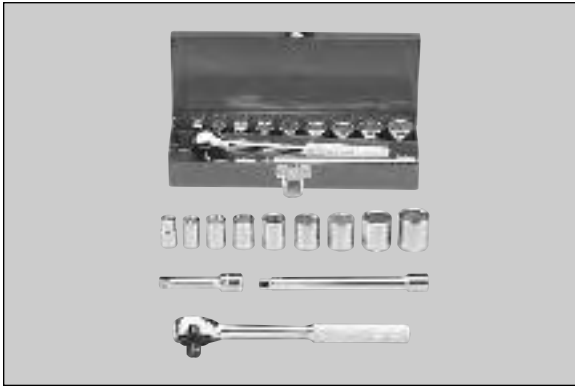

BD12K			
B612.....	3/8" 6 Pt. Std. Skt.	B626.....	13/16" 6 Pt. Std. Skt.
B614.....	7/16" 6 Pt. Std. Skt.	B628.....	7/8" 6 Pt. Std. Skt.
B616.....	1/2" 6 Pt. Std. Skt.	B52.....	REVERSIBLE RATCHET
B618.....	9/16" 6 Pt. Std. Skt.	B103.....	3" EXTENSION
B620.....	5/8" 6 Pt. Std. Skt.	B105.....	6" EXTENSION
B622.....	11/16" 6 Pt. Std. Skt.	93.....	METAL BOX
B624.....	3/4" 6 Pt. Std. Skt.		



B19K			
B612.....	3/8" 6 Pt. Std. Skt.	BD612.....	3/8" 6 Pt. Deep Skt.
B614.....	7/16" 6 Pt. Std. Skt.	BD614.....	7/16" 6 Pt. Deep Skt.
B616.....	1/2" 6 Pt. Std. Skt.	BD616.....	1/2" 6 Pt. Deep Skt.
B618.....	9/16" 6 Pt. Std. Skt.	BD618.....	9/16" 6 Pt. Deep Skt.
B620.....	5/8" 6 Pt. Std. Skt.	BD622.....	11/16" 6 Pt. Deep Skt.
B622.....	11/16" 6 Pt. Std. Skt.	BD624.....	3/4" 6 Pt. Deep Skt.
B624.....	3/4" 6 Pt. Std. Skt.	B52.....	REVERSIBLE RATCHET
B626.....	13/16" 6 Pt. Std. Skt.	B103.....	3" EXTENSION
B628.....	7/8" 6 Pt. Std. Skt.	B105.....	6" EXTENSION
		BD620P.....	3/8" SPARK PLUG SKT.
		94.....	METAL BOX



B20K			
B612.....	3/8" 6 Pt. Std. Skt.	BD616.....	1/2" 6 Pt. Deep Skt.
B614.....	7/16" 6 Pt. Std. Skt.	BD618.....	9/16" 6 Pt. Deep Skt.
B616.....	1/2" 6 Pt. Std. Skt.	BD620.....	5/8" 6 Pt. Deep Skt.
B618.....	9/16" 6 Pt. Std. Skt.	BD622.....	11/16" 6 Pt. Deep Skt.
B1220.....	5/8" 12 Pt. Std. Skt.	BD624.....	3/4" 6 Pt. Deep Skt.
B1222.....	11/16" 12 Pt. Std. Skt.	BD626.....	13/16" 6 Pt. Deep Skt.
B1224.....	3/4" 12 Pt. Std. Skt.	B52.....	RATCHET
B1226.....	13/16" 12 Pt. Std. Skt.	B105.....	6" EXTENSION
B1228.....	7/8" 12 Pt. Std. Skt.	B40A.....	FLEX HANDLE
BD612.....	3/8" 6 Pt. Deep Skt.	94.....	METAL BOX
BD614.....	7/16" 6 Pt. Deep Skt.		

TOOLS

B22K

B1212..... 3/8" 12 Pt. Std. Skt.	BD1218 9/16" 12 Pt. Deep Skt.
B1214..... 7/16" 12 Pt. Std. Skt.	BD1220 5/8" 12 Pt. Deep Skt.
B1216..... 1/2" 12 Pt. Std. Skt.	BD1222 11/16" 12 Pt. Deep Skt.
B1218..... 9/16" 12 Pt. Std. Skt.	BD1224 3/4" 12 Pt. Deep Skt.
B1220..... 5/8" 12 Pt. Std. Skt.	BD1226 13/16" 12 Pt. Deep Skt.
B1222..... 11/16" 12 Pt. Std. Skt.	BD1228 7/8" 12 Pt. Deep Skt.
B1224..... 3/4" 12 Pt. Std. Skt.	B52..... REVERSIBLE RATCHET
B1226..... 13/16" 12 Pt. Std. Skt.	B103..... 3" EXTENSION
B1228..... 7/8" 12 Pt. Std. Skt.	B105..... 6" EXTENSION
BD1212 3/8" 12 Pt. Deep Skt.	B140A..... UNIVERSAL JOINT
BD1214 7/16" 12 Pt. Deep Skt.	94 METAL BOX
BD1216 1/2" 12 Pt. Deep Skt.	

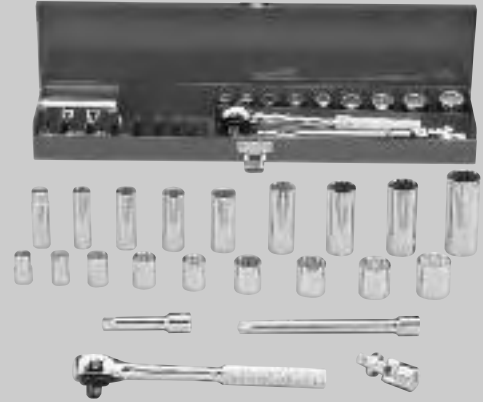

BD22K

B612..... 3/8" 6 Pt. Std. Skt.	BD618 9/16" 6 Pt. Deep Skt.
B614..... 7/16" 6 Pt. Std. Skt.	BD620 5/8" 6 Pt. Deep Skt.
B616..... 1/2" 6 Pt. Std. Skt.	BD622 11/16" 6 Pt. Deep Skt.
B618..... 9/16" 6 Pt. Std. Skt.	BD624 3/4" 6 Pt. Deep Skt.
B620..... 5/8" 6 Pt. Std. Skt.	BD626 13/16" 6 Pt. Deep Skt.
B622..... 11/16" 6 Pt. Std. Skt.	BD628 7/8" 6 Pt. Deep Skt.
B624..... 3/4" 6 Pt. Std. Skt.	B52..... REVERSIBLE RATCHET
B626..... 13/16" 6 Pt. Std. Skt.	B103..... 3" EXTENSION
B628..... 7/8" 6 Pt. Std. Skt.	B105..... 6" EXTENSION
BD612 3/8" 6 Pt. Deep Skt.	B140A..... UNIVERSAL JOINT
BD614 7/16" 6 Pt. Deep Skt.	94 METAL BOX
BD616 1/2" 6 Pt. Deep Skt.	



B26K

B608..... 1/4" 6 Pt. Std. Skt.	BD614 7/16" 6 Pt. Deep Skt.
B610..... 5/16" 6 Pt. Std. Skt.	BD616 1/2" 6 Pt. Deep Skt.
B612..... 3/8" 6 Pt. Std. Skt.	BD618 9/16" 6 Pt. Deep Skt.
B614..... 7/16" 6 Pt. Std. Skt.	BD620 5/8" 6 Pt. Deep Skt.
B616..... 1/2" 6 Pt. Std. Skt.	BD622 11/16" 6 Pt. Deep Skt.
B618..... 9/16" 6 Pt. Std. Skt.	BD624 3/4" 6 Pt. Deep Skt.
B1220..... 5/8" 12 Pt. Std. Skt.	BD626 13/16" 6 Pt. Deep Skt.
B1222..... 11/16" 12 Pt. Std. Skt.	B52..... RATCHET
B1224..... 3/4" 12 Pt. Std. Skt.	B103..... 3" EXTENSION
B1226..... 13/16" 12 Pt. Std. Skt.	B105..... 6" EXTENSION
B1228..... 7/8" 12 Pt. Std. Skt.	B40A..... FLEX HANDLE
B1230..... 15/16" 12 Pt. Std. Skt.	B140A..... UNIVERSAL
B1232..... 1" 12 Pt. Std. Skt.	94 METAL BOX
BD612 3/8" 6 Pt. Deep Skt.	

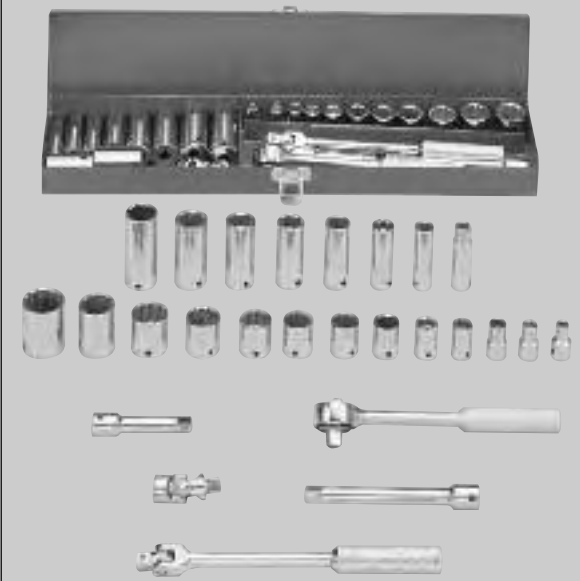

TOOLS

3/8" Drive Metric Socket Wrenches — Chrome

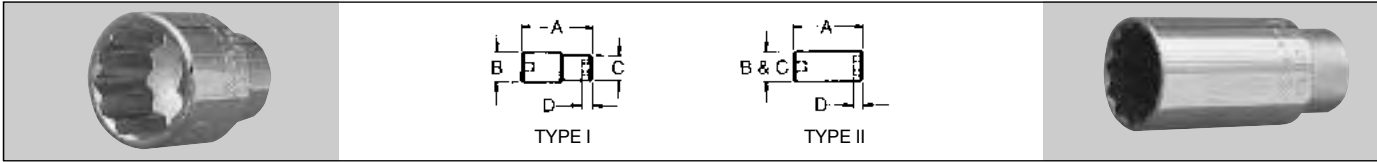

3/8" Square Drive 12 Point Standard — Metric									
Opening	Type	Length	Drive End	Opening End	Minimum Depth	Wt. Ea. Lbs.	Chrome	Std. Pkg. Qty.	Opening
		A	B	C	D		Part No.		
8 mm	I	25.7 mm	17.3 mm	12.2 mm	6.6 mm	.06	BM1208	6	8 mm
9 mm	I	25.4 mm	17.3 mm	14.2 mm	6.9 mm	.06	BM1209	6	9 mm
10 mm	I	25.4 mm	17.3 mm	14.9 mm	7.9 mm	.06	BM1210	6	10 mm
11 mm	I	25.4 mm	17.3 mm	16.5 mm	8.1 mm	.06	BM1211	6	11 mm
12 mm	II	25.4 mm	17.8 mm	17.8 mm	7.9 mm	.06	BM1212	6	12 mm
13 mm	II	25.7 mm	18.8 mm	18.8 mm	7.9 mm	.06	BM1213	6	13 mm
14 mm	II	25.7 mm	20.6 mm	20.6 mm	12.4 mm	.06	BM1214	6	14 mm
15 mm	II	25.7 mm	21.6 mm	21.6 mm	12.4 mm	.13	BM1215	6	15 mm
16 mm	II	28.7 mm	22.1 mm	22.1 mm	14.2 mm	.13	BM1216	6	16 mm
17 mm	II	30.0 mm	24.4 mm	24.4 mm	14.2 mm	.19	BM1217	6	17 mm
18 mm	II	30.0 mm	24.4 mm	24.4 mm	15.7 mm	.19	BM1218	6	18 mm
19 mm	II	30.0 mm	26.2 mm	26.2 mm	17.3 mm	.19	BM1219	6	19 mm

3/8" Square Drive 6 Point Standard — Metric									
Opening	Type	Length	Drive End	Opening End	Minimum Depth	Wt. Ea. Lbs.	Chrome	Std. Pkg. Qty.	Opening
		A	B	C	D		Part No.		
6 mm	I	1 1/8	5/8	25/64	5/32	.04	BM606	6	6 mm
7 mm	I	1 1/8	5/8	7/16	5/32	.04	BM607	6	7 mm
8 mm	I	1 1/8	5/8	15/64	3/64	.05	BM608	6	8 mm
9 mm	I	1 1/8	5/8	33/64	7/32	.05	BM609	6	9 mm
10 mm	I	1 1/8	5/8	37/64	15/64	.05	BM610	6	10 mm
11 mm	II	1 1/8	—	5/8	5/32	.05	BM611	6	11 mm
12 mm	II	1 1/8	—	11/16	3/16	.06	BM612	6	12 mm
13 mm	II	1 1/8	—	47/64	3/16	.08	BM613	6	13 mm
14 mm	II	1 1/8	—	49/64	25/64	.08	BM614	6	14 mm
15 mm	II	1 1/8	—	27/32	25/64	.10	BM615	6	15 mm
16 mm	II	1 1/8	—	7/8	13/32	.10	BM616	6	16 mm
17 mm	II	1 1/8	—	59/64	25/64	.13	BM617	6	17 mm
18 mm	II	1 1/8	—	31/32	13/32	.13	BM618	6	18 mm
19 mm	II	1 1/8	—	1	15/32	.15	BM619	6	19 mm

3/8" Square Drive 6 Point Deep — Metric									
Opening	Type	Length	Drive End	Opening End	Minimum Depth	Wt. Ea. Lbs.	Chrome	Std. Pkg. Qty.	Opening
		A	B	C	D		Part No.		
6 mm	I	2 1/32	5/8	25/64	5/32	.10	BMD606	6	6 mm
7 mm	I	2 1/32	5/8	25/64	5/32	.10	BMD607	6	7 mm
8 mm	I	2 1/32	5/8	29/64	3/16	.12	BMD608	6	8 mm
9 mm	I	2 1/32	5/8	1/2	15/64	.10	BMD609	6	9 mm
10 mm	I	2 1/32	5/8	9/16	15/64	.12	BMD610	6	10 mm
11 mm	I	2 1/32	—	5/8	5/32	.12	BMD611	6	11 mm
12 mm	II	2 1/32	—	45/64	3/16	.13	BMD612	6	12 mm
13 mm	II	2 1/32	—	47/64	3/16	.17	BMD613	6	13 mm
14 mm	II	2 1/32	—	49/64	25/64	.21	BMD614	6	14 mm
15 mm	II	2 1/32	—	27/32	25/64	.23	BMD615	6	15 mm
16 mm	II	2 1/32	—	7/8	25/64	.23	BMD616	6	16 mm
17 mm	II	2 1/2	—	59/64	25/64	.31	BMD617	6	17 mm
18 mm	II	2 1/2	—	31/32	13/32	.23	BMD618	6	18 mm
19 mm	II	2 1/2	—	63/64	7/16	.25	BMD619	6	19 mm

TOOLS



3/8" Drive Metric Socket Sets — Chrome

MB11K

BM610..... 10 mm 6 Pt. Std. Skt.	BM618..... 18 mm 6 Pt. Std. Skt.
BM612..... 12 mm 6 Pt. Std. Skt.	BM619..... 19 mm 6 Pt. Std. Skt.
BM613..... 13 mm 6 Pt. Std. Skt.	B52..... REVERSIBLE RATCHET
BM614..... 14 mm 6 Pt. Std. Skt.	B103..... 3" EXTENSION
BM615..... 15 mm 6 Pt. Std. Skt.	BD620P..... SPARK PLUG SKT.
BM617..... 17 mm 6 Pt. Std. Skt.	92..... METAL BOX



MB12K

BM1208..... 8 mm 12 Pt. Std. Skt.	BM1215..... 15 mm 12 Pt. Std. Skt.
BM1209..... 9 mm 12 Pt. Std. Skt.	BM1216..... 16 mm 12 Pt. Std. Skt.
BM1210..... 10 mm 12 Pt. Std. Skt.	BM1217..... 17 mm 12 Pt. Std. Skt.
BM1211..... 11 mm 12 Pt. Std. Skt.	BM1218..... 18 mm 12 Pt. Std. Skt.
BM1212..... 12 mm 12 Pt. Std. Skt.	BM1219..... 19 mm 12 Pt. Std. Skt.
BM1213..... 13 mm 12 Pt. Std. Skt.	240..... CLIP RAIL
BM1214..... 14 mm 12 Pt. Std. Skt.	



MB14K

BM606..... 6 mm 6 Pt. Std. Skt.	BM614..... 14 mm 6 Pt. Std. Skt.
BM607..... 7 mm 6 Pt. Std. Skt.	BM615..... 15 mm 6 Pt. Std. Skt.
BM608..... 8 mm 6 Pt. Std. Skt.	BM616..... 16 mm 6 Pt. Std. Skt.
BM609..... 9 mm 6 Pt. Std. Skt.	BM617..... 17 mm 6 Pt. Std. Skt.
BM610..... 10 mm 6 Pt. Std. Skt.	BM618..... 18 mm 6 Pt. Std. Skt.
BM611..... 11 mm 6 Pt. Std. Skt.	BM619..... 19 mm 6 Pt. Std. Skt.
BM612..... 12 mm 6 Pt. Std. Skt.	240..... CLIP RAIL
BM613..... 13 mm 6 Pt. Std. Skt.	

METRIC



TOOLS

3/8" Drive Metric Socket Sets—Chrome



MB17K			
BM1208.....	8 mm 12 Pt. Std. Skt.	BM1215.....	15 mm 12 Pt. Std. Skt.
BM1209.....	9 mm 12 Pt. Std. Skt.	BM1216.....	16 mm 12 Pt. Std. Skt.
BM1210.....	10 mm 12 Pt. Std. Skt.	BM1217.....	17 mm 12 Pt. Std. Skt.
BM1211.....	11 mm 12 Pt. Std. Skt.	BM1218.....	18 mm 12 Pt. Std. Skt.
BM1212.....	12 mm 12 Pt. Std. Skt.	BM1219.....	19 mm 12 Pt. Std. Skt.
BM1213.....	13 mm 12 Pt. Std. Skt.	B40A.....	7 ¹³ / ₁₆ " FLEXIBLE HANDLE
BM1214.....	14 mm 12 Pt. Std. Skt.	B52.....	REVERSIBLE RATCHET
		B103.....	3" EXTENSION
		B105.....	6" EXTENSION
		B140A.....	UNIVERSAL JOINT
		94.....	METAL BOX



MB19K			
BM610.....	10 mm 6 Pt. Std. Skt.	BMD610.....	10 mm 6 Pt. Deep Skt.
BM612.....	12 mm 6 Pt. Std. Skt.	BMD612.....	12 mm 6 Pt. Deep Skt.
BM613.....	13 mm 6 Pt. Std. Skt.	BMD613.....	13 mm 6 Pt. Deep Skt.
BM614.....	14 mm 6 Pt. Std. Skt.	BMD614.....	14 mm 6 Pt. Deep Skt.
BM615.....	15 mm 6 Pt. Std. Skt.	BMD615.....	15 mm 6 Pt. Deep Skt.
BM617.....	17 mm 6 Pt. Std. Skt.	BMD617.....	17 mm 6 Pt. Deep Skt.
BM618.....	18 mm 6 Pt. Std. Skt.	BMD619.....	19 mm 6 Pt. Deep Skt.
BM619.....	19 mm 6 Pt. Std. Skt.	B52.....	REVERSIBLE RATCHET
		B103.....	3" EXTENSION
		B105.....	6" EXTENSION
		BD620P.....	SPARK PLUG SKT.
		94.....	METAL BOX

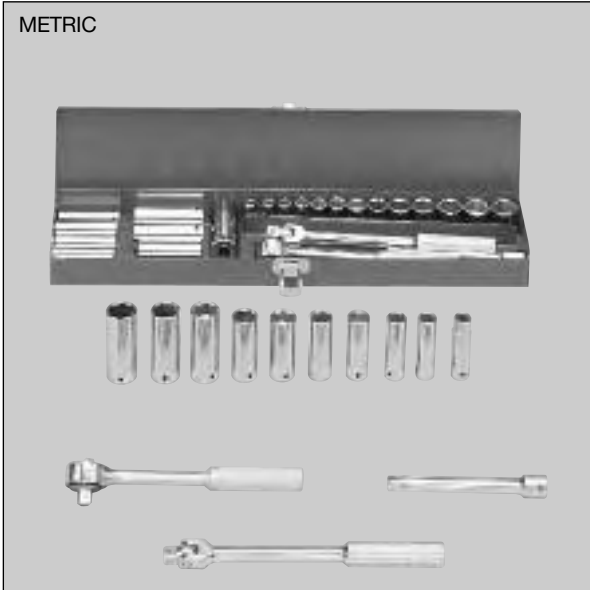

METRIC		MB26K	
BM607.....	7 mm 6 Pt. Std. Skt.	BMD611.....	11 mm 6 Pt. Deep Skt.
BM608.....	8 mm 6 Pt. Std. Skt.	BMD612.....	12 mm 6 Pt. Deep Skt.
BM609.....	9 mm 6 Pt. Std. Skt.	BMD613.....	13 mm 6 Pt. Deep Skt.
BM610.....	10 mm 6 Pt. Std. Skt.	BMD614.....	14 mm 6 Pt. Deep Skt.
BM611.....	11 mm 6 Pt. Std. Skt.	BMD615.....	15 mm 6 Pt. Deep Skt.
BM612.....	12 mm 6 Pt. Std. Skt.	BMD616.....	16 mm 6 Pt. Deep Skt.
BM613.....	13 mm 6 Pt. Std. Skt.	BMD617.....	17 mm 6 Pt. Deep Skt.
BM614.....	14 mm 6 Pt. Std. Skt.	BMD618.....	18 mm 6 Pt. Deep Skt.
BM615.....	15 mm 6 Pt. Std. Skt.	BMD619.....	19 mm 6 Pt. Deep Skt.
BM616.....	16 mm 6 Pt. Std. Skt.	B52.....	RATCHET
BM617.....	17 mm 6 Pt. Std. Skt.	B105.....	6" EXTENSION
BM618.....	18 mm 6 Pt. Std. Skt.	B40A.....	FLEX HANDLE
BM619.....	19 mm 6 Pt. Std. Skt.	94.....	METAL BOX
BMD610.....	10 mm 6 Pt. Deep Skt.		

TOOLS

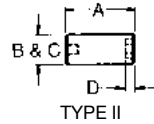
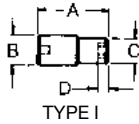

3/8" Square Drive 6 Point Standard

Opening	Type	Length	Drive End	Opening End	Minimum Depth	Wt. Ea. Lbs.	Industrial Black	Std. Pkg. Qty.	Opening
		A	B	C	D		Part No.		
5/16	I	1 1/16	47/64	1/2	7/64	.07	2610	6	5/16
3/8	I	1 1/16	47/64	19/32	5/32	.07	2612	6	3/8
7/16	I	1 1/16	47/64	43/64	7/32	.08	2614	6	7/16
1/2	II	1 3/32	—	3/4	13/64	.08	2616	6	1/2
9/16	II	1 1/8	—	55/64	1/4	.13	2618	6	9/16
5/8	II	1 1/8	—	59/64	9/32	.15	2620	6	5/8
11/16	II	1 1/8	—	63/64	5/16	.16	2622	6	11/16

3/8" Square Drive 6 Point Deep

Opening	Type	Length	Drive End	Opening End	Minimum Depth	Wt. Ea. Lbs.	Industrial Black	Std. Pkg. Qty.	Opening
		A	B	C	D		Part No.		
5/16	I	2 1/4	47/64	1/2	3/32	.19	12610	6	5/16
3/8	I	2 1/4	47/64	19/32	7/64	.19	12612	6	3/8
7/16	I	2 1/4	47/64	43/64	13/64	.19	12614	6	7/16
1/2	II	2 1/4	—	3/4	13/64	.18	12616	6	1/2
9/16	I	2 1/4	55/64	13/16	11/32	.25	12618	6	9/16
5/8	I	2 1/4	55/64	57/64	3/8	.28	12620	6	5/8
11/16	II	2 3/16	—	61/64	3/8	.31	12622	6	11/16
3/4	II	2 7/16	—	1 1/64	7/16	.38	12624	6	3/4

3/8" Square Drive 6 Point Standard — Metric

Opening	Type	Length	Drive End	Opening End	Minimum Depth	Wt. Ea. Lbs.	Industrial Black	Std. Pkg. Qty.	Opening
		A	B	C	D		Part No.		
10 mm	I	28.0 mm	18.0 mm	15.1 mm	5.0 mm	.05	2M610	6	10 mm
12 mm	II	28.0 mm	18.5 mm	18.5 mm	7.5 mm	.07	2M612	6	12 mm
13 mm	II	30.0 mm	19.6 mm	19.6 mm	9.5 mm	.07	2M613	6	13 mm
14 mm	II	30.0 mm	21.3 mm	21.3 mm	9.5 mm	.08	2M614	6	14 mm
15 mm	II	30.0 mm	22.3 mm	22.3 mm	9.5 mm	.10	2M615	6	15 mm
17 mm	II	30.0 mm	24.5 mm	24.5 mm	9.5 mm	.11	2M617	6	17 mm
18 mm	II	30.0 mm	25.3 mm	25.3 mm	9.5 mm	.12	2M618	6	18 mm
19 mm	II	30.0 mm	27.2 mm	27.2 mm	10.0 mm	.13	2M619	6	19 mm



Item	Description	Wt. Ea. Lbs.	Part No.	Std. Pkg. Qty.
Universal	3/8" Impact Universal Joint	.18	2140A	6
Adaptor	3/8" F X 1/2" M	.10	24A	6

Wt. Ea. Lbs.

Part No.

Std. Pkg. Qty.



IB6K

2610	5/16" 6 Pt. Skt.	2618	9/16" 6 Pt. Skt.
2612	3/8" 6 Pt. Skt.	2620	5/8" 6 Pt. Skt.
2614	7/16" 6 Pt. Skt.	242	CLIP RAIL
2616	1/2" 6 Pt. Skt.		

IMB8K

2M610	10 mm 6 Pt. Skt.	2M615	15 mm 6 Pt. Skt.
2M612	12 mm 6 Pt. Skt.	2M617	17 mm 6 Pt. Skt.
2M613	13 mm 6 Pt. Skt.	2M618	18 mm 6 Pt. Skt.
2M614	14 mm 6 Pt. Skt.	2M619	19 mm 6 Pt. Skt.
		244	CLIP RAIL

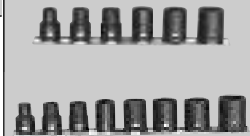

IB8K

2610	5/16" 6 Pt. Skt.	2620	5/8" 6 Pt. Skt.
2612	3/8" 6 Pt. Skt.	2622	11/16" 6 Pt. Skt.
2614	7/16" 6 Pt. Skt.	2624	3/4" 6 Pt. Skt.
2616	1/2" 6 Pt. Skt.	70	METAL TRAY
2618	9/16" 6 Pt. Skt.		

IB8KD

12610	5/16" 6 Pt. Deep Skt.	12620	5/8" 6 Pt. Deep Skt.
12612	3/8" 6 Pt. Deep Skt.	12622	11/16" 6 Pt. Deep Skt.
12614	7/16" 6 Pt. Deep Skt.	12624	3/4" 6 Pt. Deep Skt.
12616	1/2" 6 Pt. Deep Skt.	70	METAL TRAY
12618	9/16" 6 Pt. Deep Skt.		

1/2" Drive Attachments Chrome

Type		Description	Part No.	Std. Pkg. Qty.
FLEXIBLE HANDLE		Chrome Knurled Grip. Length 17". Weight 1.65 lb.	SF41	5
REVERSIBLE RATCHET		Chrome .45 tooth. Head diameter 1 1/8". Length 10". Weight 1.44 lb.	SF51	1
REVERSIBLE RATCHET REPAIR KIT		Preassembled Ratchet Replacement Head. Weight .31 lb. For SF51 and SF55	SF51RD	1
DOUBLE PAWL RATCHET		Double Pawl 45 tooth. Head diameter 1 1/16". Length 15". Weight 1.25 lb.	SF55	1
EXTENSION		Chrome. Length 20". Weight 1.19 lb.	S121P	5
EXTENSION		Chrome. Length 2". Weight .21 lb.	S102P	5
EXTENSION		Chrome. Length 5". Weight .37 lb.	S110P	5
EXTENSION		Chrome. Length 10". Weight .66 lb.	S115P	5
UNIVERSAL JOINT		Chrome. Length 2 5/16". Weight .15 lb.	S140	5
ADAPTOR		Chrome. 1/2"F to 3/8"M. Weight .15 lb.	SH129	5
ADAPTOR		Chrome. 1/2"F to 1/4"M. Weight .18 lb.	SH130	5
17 1/4" SPEEDER		Chrome. Revolving Grip. Length 17 1/4". Weight 1.23 lb.	S15	5

TOOLS



1/2" Drive Socket Wrenches

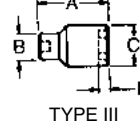
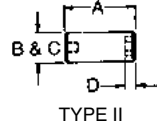
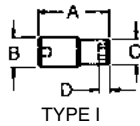

Martin Heavy Duty Chrome Hand Tool Sockets are Manufactured to Extremely Close Tolerances of American Alloy Steel. The 12 Point Broach Opening Provides a Secure Fit for Absolute Tightening and Loosening.

1/2" Square Drive 12 Point Standard

Opening	Type	Length	Drive End	Opening End	Minimum Depth	Wt. Ea. Lbs.	Chrome	Std. Pkg. Qty.	Opening
		A	B	C	D		Part No.		
3/8	I	1 15/32	13/16	37/64	5/32	.09	ST1212	5	3/8
7/16	I	1 15/32	13/16	41/64	7/32	.09	ST1214	5	7/16
1/2	I	1 15/32	13/16	23/32	17/64	.10	ST1216	5	1/2
9/16	II	1 15/32	—	13/16	21/64	.10	ST1218	5	9/16
5/8	II	1 15/32	—	7/8	1 15/32	.14	ST1220	5	5/8
11/16	II	1 15/32	—	31/32	1 15/32	.15	ST1222	5	11/16
3/4	II	1 15/32	—	1 1/16	1 15/32	.19	ST1224	5	3/4
13/16	II	1 1/8	—	1 1/8	1 1/8	.20	ST1226	5	13/16
7/8	II	1 1/8	—	1 11/64	1/2	.24	ST1228	5	7/8
15/16	II	1 1/8	—	1 1/4	35/64	.28	ST1230	5	15/16
1	II	1 11/16	—	1 5/16	35/64	.32	ST1232	5	1
1 1/16	III	1 3/4	1 3/32	1 13/32	5/8	.32	ST1234	5	1 1/16
1 1/8	III	1 13/16	1 1/4	1 1/2	21/32	.35	ST1236	5	1 1/8
1 1/16	III	1 7/8	1 1/4	1 37/64	21/32	.40	ST1238	5	1 1/16
1 1/4	III	1 59/64	1 1/8	1 13/16	3/4	.43	ST1240	5	1 1/4
1 1/16	III	2	1 1/16	1 13/16	13/16	.45	ST1242	5	1 1/16
1 3/8	III	2	1 1/4	1 7/8	55/64	.46	ST1244	5	1 3/8
1 1/16	III	2 1/16	1 3/8	1 15/16	29/32	.47	ST1246	5	1 1/16
1 1/2	III	2 1/8	1 3/8	2	1 1/16	.49	ST1248	5	1 1/2

1/2" Square Drive 12 Point Deep

Opening	Type	Length	Drive End	Opening End	Minimum Depth	Wt. Ea. Lbs.	Chrome	Std. Pkg. Qty.	Opening
		A	B	C	D		Part No.		
7/16	II	3 3/4	—	1 3/16	23/32	.24	SD1214	5	7/16
1/2	I	3 1/16	13/16	29/32	17/64	.24	SD1216	5	1/2
9/16	II	3 1/16	—	13/16	21/64	.24	SD1218	5	9/16
5/8	II	3 1/16	—	7/8	3/8	.30	SD1220	5	5/8
11/16	II	3 1/16	—	31/32	3/8	.34	SD1222	5	11/16
3/4	II	3 1/16	—	1 3/4	7/16	.35	SD1224	5	3/4
13/16	II	3 1/16	—	1 1/4	29/64	.40	SD1226	5	13/16
7/8	II	3 1/16	—	1 11/64	1/2	.43	SD1228	5	7/8
15/16	II	3 1/16	—	1 1/4	35/64	.48	SD1230	5	15/16
1	III	3 1/16	1 3/32	1 5/16	35/64	.45	SD1232	5	1
1 1/16	III	3 1/16	1 1/4	1 13/32	5/8	.50	SD1234	5	1 1/16
1 1/8	III	3 1/16	1 1/4	1 1/2	21/32	.51	SD1236	5	1 1/8
1 1/16	III	3 3/4	1 1/4	1 37/64	21/32	.56	SD1238	5	1 1/16
1 1/4	III	3 3/4	1 1/8	1 41/64	3/4	.61	SD1240	5	1 1/4
1 3/8	III	3 3/4	1 1/4	1 13/16	49/64	.61	SD1242	5	1 3/8
1 1/16	III	3 3/4	1 15/64	1 7/8	25/32	.84	SD1244	5	1 1/16
1 1/8	III	3 3/4	1 19/64	1 61/64	7/8	.88	SD1246	5	1 1/8
1 1/2	III	3 3/4	1 11/32	2 1/64	55/64	.93	SD1248	5	1 1/2

TOOLS

1/2" Drive Socket Wrenches—Chrome

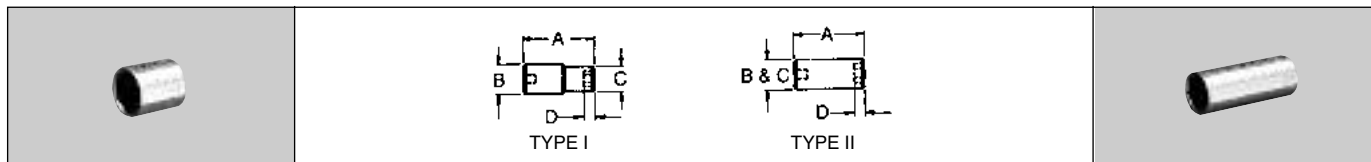

1/2" Square Drive 6 Point Standard

Opening	Type	Length	Drive End	Opening End	Minimum Depth	Wt. Ea. Lbs.	Chrome	Std. Pkg. Qty.	Opening
		A	B	C	D		Part No.		
3/8	I	1 1/2	7/8	37/64	5/16	.11	ST612	5	3/8
7/16	I	1 1/2	59/64	11/16	21/64	.11	ST614	5	7/16
1/2	I	1 1/2	55/64	3/4	13/32	.11	ST616	5	1/2
9/16	I	1 1/2	59/64	19/16	19/32	.13	ST618	5	9/16
5/8	II	1 1/2	7/8	7/8	9/16	.12	ST620	5	5/8
11/16	II	1 1/2	31/32	31/32	9/16	.16	ST622	5	11/16
3/4	II	1 1/2	13/64	13/64	21/32	.19	ST624	5	3/4
13/16	II	1 1/2	13/32	13/32	11/16	.20	ST626	5	13/16
7/8	II	1 1/2	13/16	13/16	3/4	.29	ST628	5	7/8
15/16	II	1 1/2	117/64	117/64	51/64	.31	ST630	5	15/16
1	II	1 39/64	121/64	121/64	53/64	.37	ST632	5	1
1 1/16	II	1 39/64	113/32	113/32	15/16	.52	ST634	5	1 1/16
1 1/8	II	1 5/8	115/32	115/32	63/64	.52	ST636	5	1 1/8
1 3/8	II	1 5/8	117/32	117/32	63/64	.59	ST638	5	1 3/8
1 1/2	II	1 3/4	137/64	137/64	1 1/8	.66	ST640	5	1 1/2

1/2" Square Drive 6 Point Deep

Opening	Type	Length	Drive End	Opening End	Minimum Depth	Wt. Ea. Lbs.	Chrome	Std. Pkg. Qty.	Opening
		A	B	C	D		Part No.		
1/2	I	3 3/8	7/8	49/64	51/64	.34	SD616	5	1/2
9/16	I	3 3/8	7/8	59/64	19/16	.31	SD618	5	9/16
5/8	II	3 3/8	7/8	7/8	1 3/16	.38	SD620	5	5/8
11/16	II	3 3/8	31/32	31/32	1 1/32	.41	SD622	5	11/16
3/4	II	3 3/8	1 1/16	1 1/16	1 17/64	.44	SD624	5	3/4
13/16	II	3 3/8	1 1/8	1 1/8	1 19/64	.47	SD626	5	13/16
7/8	II	3 3/8	1 3/16	1 3/16	1 19/64	.53	SD628	5	7/8
15/16	II	3 3/8	1 17/64	1 17/64	1 3/8	.56	SD630	5	15/16
1	II	3 3/8	1 11/32	1 11/32	1 3/8	.72	SD632	5	1
1 1/16	II	3 3/8	1 13/32	1 13/32	1 27/64	.78	SD634	5	1 1/16
1 1/8	II	3 3/8	1 1/2	1 1/2	1 27/64	.84	SD636	5	1 1/8

TOOLS



1/2" Drive Crowfoot Wrench and Hex Bit Sockets

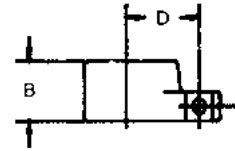
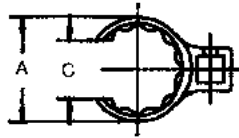

1/2" Drive Crowfoot Wrench — Flare Nut 12 Pt.

Wrench Opening	Diameter of Head	Thickness of Head	Width of Slot	Length of Centers	Wt. Ea. Lbs.	Chrome	Industrial Black	Std. Pkg. Qty.	Wrench Opening
	A	B	C	D		Part No.	Part No.		
1 1/8	1 1/8	7/16	27/32	1 1/32	.19	SC36	BLKSC36	5	1 1/8
1 1/16	1 1/16	7/16	29/32	1 1/16	.19	SC38	BLKSC38	5	1 1/16
1 1/4	1 23/32	7/16	15/16	1 15/64	.19	SC40	BLKSC40	5	1 1/4
1 5/16	1 27/32	7/16	31/32	1 17/64	.19	SC42	BLKSC42	5	1 5/16
1 3/8	1 15/16	15/16	1 1/16	1 1/16	.25	SC44	BLKSC44	5	1 3/8
1 1/2	2	15/16	1 1/16	1 11/32	.25	SC46	BLKSC46	5	1 1/2
1 5/8	2 1/16	15/16	1 1/8	1 1/8	.25	SC48	BLKSC48	5	1 5/8
1 3/4	2 3/32	15/16	1 1/2	1 27/64	.31	SC50	BLKSC50	5	1 3/4
1 7/8	2 1/2	15/16	1 1/2	1 29/64	.31	SC52	BLKSC52	5	1 7/8
1 15/16	2 5/16	1	1 1/16	1 33/64	.31	SC54	BLKSC54	5	1 15/16
1 1/4	2 3/8	1	1 5/16	1 35/64	.38	SC56	BLKSC56	5	1 1/4
1 13/16	2 19/32	1	1 11/32	1 19/32	.38	SC58	BLKSC58	5	1 13/16
1 1/2	2 1/8	1 1/16	1 3/8	1 41/64	.44	SC60	BLKSC60	5	1 1/2
1 5/8	2 1/4	1 1/16	1 1/8	1 43/64	.50	SC62	BLKSC62	5	1 5/8
1 3/4	2 1/2	1 1/16	1 1/8	1 23/32	.50	SC64	BLKSC64	5	1 3/4

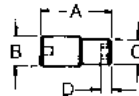

TYPE I

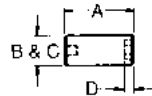

TYPE II

1/2" Drive Hex Type Sockets with Bits

Bit Size	Type	Length	Drive End	Bit Size End	Bit Length	Wt. Ea. Lbs.	Chrome	Replacement Hex Bits	Std. Pkg. Qty.	Bit Size
		A	B	C	D		Part No.			
1/4	I	2 1/2	—	15/16	1	.18	SA8	SA8B	5	1/4
5/16	I	2 1/2	—	15/16	1	.18	SA10	SA10B	5	5/16
3/8	I	2 1/2	—	15/16	1	.18	SA12	SA12B	5	3/8
7/16	I	2 1/2	—	15/16	1	.18	SA14	SA14B	5	7/16
1/2	II	2 1/2	—	1 1/16	1	.18	SA16	SA16B	5	1/2
9/16	II	2 1/2	—	1 1/16	1	.18	SA18	SA18B	5	9/16
5/8	II	2 1/2	—	1 1/16	1	.19	SA20	SA20B	5	5/8

TOOLS

1/2" Drive Socket & Sets – Chrome



S7K	
SA8..... 1/4" Hex Type Skt. 1/2" Dr.	SA16..... 1/2" Hex Type Skt. 1/2" Dr.
SA10..... 5/16" Hex Type Skt. 1/2" Dr.	SA18..... 9/16" Hex Type Skt. 1/2" Dr.
SA12..... 3/8" Hex Type Skt. 1/2" Dr.	SA20..... 5/8" Hex Type Skt. 1/2" Dr.
SA14..... 7/16" Hex Type Skt. 1/2" Dr.	250 CLIP RAIL

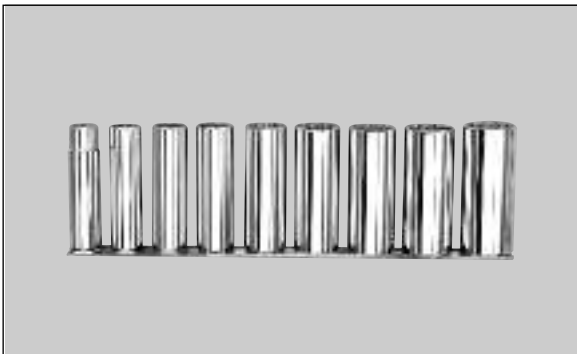

S9K	
SD616 1/2" 6 pt. Deep Skt.	SD626 13/16" 6 pt. Deep Skt.
SD618 9/16" 6 pt. Deep Skt.	SD628 7/8" 6 pt. Deep Skt.
SD620 5/8" 6 pt. Deep Skt.	SD630 15/16" 6 pt. Deep Skt.
SD622 11/16" 6 pt. Deep Skt.	SD632 1" 6 pt. Deep Skt.
SD624 3/4" 6 pt. Deep Skt.	256 CLIP RAIL



S11K	
SD1216 1/2" 12 pt. Deep Skt.	SD1228 7/8" 12 pt. Deep Skt.
SD1218 9/16" 12 pt. Deep Skt.	SD1230 15/16" 12 pt. Deep Skt.
SD1220 5/8" 12 pt. Deep Skt.	SD1232 1" 12 pt. Deep Skt.
SD1222 11/16" 12 pt. Deep Skt.	SD1234 1 1/16" 12 pt. Deep Skt.
SD1224 3/4" 12 pt. Deep Skt.	SD1236 1 1/8" 12 pt. Deep Skt.
SD1226 13/16" 12 pt. Deep Skt.	254 CLIP RAIL



S12K	
ST1214..... 7/16" 12 pt. Skt.	ST1228..... 7/8" 12 pt. Skt.
ST1216..... 1/2" 12 pt. Skt.	ST1230..... 15/16" 12 pt. Skt.
ST1218..... 9/16" 12 pt. Skt.	ST1232..... 1" 12 pt. Skt.
ST1220..... 5/8" 12 pt. Skt.	SF51 10" Reversible Ratchet
ST1222..... 11/16" 12 pt. Skt.	S110P 5" Extension
ST1224..... 3/4" 12 pt. Skt.	95 METAL BOX
ST1226..... 13/16" 12 pt. Skt.	

TOOLS

S13K

ST1214..... 7/16" 12 pt. Skt.	ST1228..... 7/8" 12 pt. Skt.
ST1216..... 1/2" 12 pt. Skt.	ST1230..... 15/16" 12 pt. Skt.
ST1218..... 9/16" 12 pt. Skt.	ST1232..... 1" 12 pt. Skt.
ST1220..... 5/8" 12 pt. Skt.	ST1234..... 1 1/16" 12 pt. Skt.
ST1222..... 11/16" 12 pt. Skt.	ST1236..... 1 1/8" 12 pt. Skt.
ST1224..... 3/4" 12 pt. Skt.	ST1240..... 1 1/4" 12 pt. Skt.
ST1226..... 13/16" 12 pt. Skt.	151 METAL TRAY

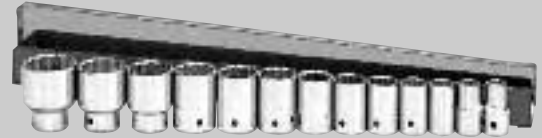

S15K

ST612..... 3/8" 6 pt. Std. Skt.	ST628..... 7/8" 6 pt. Std. Skt.
ST614..... 7/16" 6 pt. Std. Skt.	ST630..... 15/16" 6 pt. Std. Skt.
ST616..... 1/2" 6 pt. Std. Skt.	ST632..... 1" 6 pt. Std. Skt.
ST618..... 9/16" 6 pt. Std. Skt.	ST634..... 1 1/16" 6 pt. Std. Skt.
ST620..... 5/8" 6 pt. Std. Skt.	ST636..... 1 1/8" 6 pt. Std. Skt.
ST622..... 11/16" 6 pt. Std. Skt.	ST638..... 1 3/16" 6 pt. Std. Skt.
ST624..... 3/4" 6 pt. Std. Skt.	ST640..... 1 1/4" 6 pt. Std. Skt.
ST626..... 13/16" 6 pt. Std. Skt.	258 CLIP RAIL



SC15K

SC36 1 1/8" 12 pt. Crowfoot	SC52 1 5/8" 12 pt. Crowfoot
SC38 1 3/16" 12 pt. Crowfoot	SC54 1 11/16" 12 pt. Crowfoot
SC40 1 1/4" 12 pt. Crowfoot	SC56 1 3/4" 12 pt. Crowfoot
SC42 1 5/16" 12 pt. Crowfoot	SC58 1 13/16" 12 pt. Crowfoot
SC44 1 3/8" 12 pt. Crowfoot	SC60 1 7/8" 12 pt. Crowfoot
SC46 1 7/16" 12 pt. Crowfoot	SC62 1 15/16" 12 pt. Crowfoot
SC48 1 1/2" 12 pt. Crowfoot	SC64 2" 12 pt. Crowfoot
SC50 1 5/16" 12 pt. Crowfoot	258 CLIP RAIL



S16K

ST1214..... 7/16" 12 pt. Skt.	ST1232..... 1" 12 pt. Skt.
ST1216..... 1/2" 12 pt. Skt.	ST1234..... 1 1/16" 12 pt. Skt.
ST1218..... 9/16" 12 pt. Skt.	ST1236..... 1 1/8" 12 pt. Skt.
ST1220..... 5/8" 12 pt. Skt.	ST1240..... 1 1/4" 12 pt. Skt.
ST1222..... 11/16" 12 pt. Skt.	SF51..... 10" Reversible Ratchet
ST1224..... 3/4" 12 pt. Skt.	S110P..... 5" Extension
ST1226..... 13/16" 12 pt. Skt.	S140..... Universal Joint
ST1228..... 7/8" 12 pt. Skt.	95 METAL BOX
ST1230..... 15/16" 12 pt. Skt.	



1/2" Drive Socket Sets – Chrome

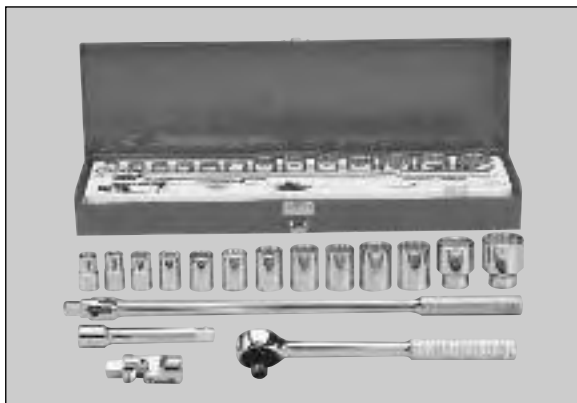

S17K	
ST1214..... 7/16" 12 pt. Std. Skt.	ST1232..... 1" 12 pt. Std. Skt.
ST1216..... 1/2" 12 pt. Std. Skt.	ST1234..... 1 1/16" 12 pt. Std. Skt.
ST1218..... 9/16" 12 pt. Std. Skt.	ST1236..... 1 1/8" 12 pt. Std. Skt.
ST1220..... 5/8" 12 pt. Std. Skt.	ST1240..... 1 1/4" 12 pt. Std. Skt.
ST1222..... 11/16" 12 pt. Std. Skt.	SF41 17" Flex Handle
ST1224..... 3/4" 12 pt. Std. Skt.	SF51 10" Ratchet
ST1226..... 13/16" 12 pt. Std. Skt.	S110P 5" Extension
ST1228..... 7/8" 12 pt. Std. Skt.	S140 Universal Joint
ST1230..... 15/16" 12 pt. Std. Skt.	99 TOOL BOX



S18K	
ST1214..... 7/16" 12 pt. Skt.	S102P..... 2" Extension
ST1216..... 1/2" 12 pt. Skt.	S110P 5" Extension
ST1218..... 9/16" 12 pt. Skt.	S115P 10" Extension
ST1220..... 5/8" 12 pt. Skt.	S140 Universal Joint
ST1222..... 11/16" 12 pt. Skt.	SF41 17" Flexible Handle
ST1224..... 3/4" 12 pt. Skt.	SF51 10" Reversible Ratchet
ST1226..... 13/16" 12 pt. Skt.	SH129 1/2"F to 3/8"M Adaptor
ST1228..... 7/8" 12 pt. Skt.	SH130 1/2"F to 3/4"M Adaptor
ST1230..... 15/16" 12 pt. Skt.	95 TOOL BOX
ST1232..... 1" 12 pt. Skt.	





S19K	
ST612..... 3/8" 6 pt. Std. Skt.	ST632..... 1" 6 pt. Std. Skt.
ST614..... 7/16" 6 pt. Std. Skt.	ST634..... 1 1/16" 6 pt. Std. Skt.
ST616..... 1/2" 6 pt. Std. Skt.	ST636..... 1 1/8" 6 pt. Std. Skt.
ST618..... 9/16" 6 pt. Std. Skt.	ST640..... 1 1/4" 6 pt. Std. Skt.
ST620..... 5/8" 6 pt. Std. Skt.	SF41 17" Flex Handle
ST622..... 11/16" 6 pt. Std. Skt.	SF51 10" Ratchet
ST624..... 3/4" 6 pt. Std. Skt.	S110P 5" Extension
ST626..... 13/16" 6 pt. Std. Skt.	S115P 10" Extension
ST628..... 7/8" 6 pt. Std. Skt.	95 TOOL BOX
ST630..... 15/16" 6 pt. Std. Skt.	

TOOLS

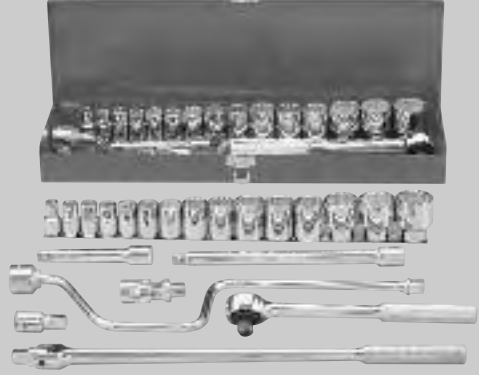

1/2" Drive Socket Sets - Chrome

S22K		
ST1212 3/16" 12 pt. Std. Skt. ST1214 7/16" 12 pt. Std. Skt. ST1216 1/2" 12 pt. Std. Skt. ST1218 9/16" 12 pt. Std. Skt. ST1220 5/8" 12 pt. Std. Skt. ST1222 11/16" 12 pt. Std. Skt. ST1224 3/4" 12 pt. Std. Skt. ST1226 13/16" 12 pt. Std. Skt. ST1228 7/8" 12 pt. Std. Skt. ST1230 15/16" 12 pt. Std. Skt. ST1232 1" 12 pt. Std. Skt. ST1234 1 1/16" 12 pt. Skt.	ST1236 1 1/8" 12 pt. Std. Skt. ST1238 1 1/16" 12 pt. Std. Skt. ST1240 1 1/4" 12 pt. Std. Skt. SF41 17" Flex Handle SF51 10" Ratchet S102P 2" Extension S110P 5" Extension S115P 10" Extension S140 Universal Joint S15 Drive Speeder 258 CLIP RAIL 99 TOOL BOX	

S24K		
ST1214 7/16" 12 pt. Skt. ST1216 1/2" 12 pt. Skt. ST1218 9/16" 12 pt. Skt. ST1220 5/8" 12 pt. Skt. ST1222 11/16" 12 pt. Skt. ST1224 3/4" 12 pt. Skt. ST1226 13/16" 12 pt. Skt. ST1228 7/8" 12 pt. Skt. ST1230 15/16" 12 pt. Skt. ST1232 1" 12 pt. Skt. ST1234 1 1/16" 12 pt. Skt. ST1236 1 1/8" 12 pt. Skt. ST1240 1 1/4" 12 pt. Skt.	SD1216 1/2" 12 pt. Deep Skt. SD1218 9/16" 12 pt. Deep Skt. SD1220 5/8" 12 pt. Deep Skt. SD1222 11/16" 12 pt. Deep Skt. SD1224 3/4" 12 pt. Deep Skt. SD1226 13/16" 12 pt. Deep Skt. SD1228 7/8" 12 pt. Deep Skt. SD1230 15/16" 12 pt. Deep Skt. SF41 17" Flexible Handle SF51 10" Reversible Ratchet S115P 10" Extension BX21 TOOL BOX	

S36K		32 PIECES		
ST1212 3/16" 12 pt. Std. Skt. ST1214 7/16" 12 pt. Std. Skt. ST1216 1/2" 12 pt. Std. Skt. ST1218 9/16" 12 pt. Std. Skt. ST1220 5/8" 12 pt. Std. Skt. ST1222 11/16" 12 pt. Std. Skt. ST1224 3/4" 12 pt. Std. Skt. ST1226 13/16" 12 pt. Std. Skt. ST1228 7/8" 12 pt. Std. Skt. ST1230 15/16" 12 pt. Std. Skt. ST1232 1" 12 pt. Std. Skt. ST1234 1 1/16" 12 pt. Std. Skt. ST1236 1 1/8" 12 pt. Std. Skt. ST1240 1 1/4" 12 pt. Std. Skt.	SD1216 1/2" 12 pt. Deep Skt. SD1218 9/16" 12 pt. Deep Skt. SD1220 5/8" 12 pt. Deep Skt. SD1222 11/16" 12 pt. Deep Skt. SD1224 3/4" 12 pt. Deep Skt. SD1226 13/16" 12 pt. Deep Skt. SD1228 7/8" 12 pt. Deep Skt. SD1230 15/16" 12 pt. Deep Skt. SD1232 1" 12 pt. Deep Skt. SD1234 1 1/16" 12 pt. Deep Skt. SD1236 1 1/8" 12 pt. Deep Skt. S15 17 1/2" Speed Handle S110P 5" Extension S115P 10" Extension S140 Universal Joint SF41 17" Flex Handle SF51 10" Reversible Ratchet SH130 1/2" F x 3/4" M Adaptor BX21 TOOL BOX			

TOOLS

1/2" Drive Metric Socket Wrenches — Chrome

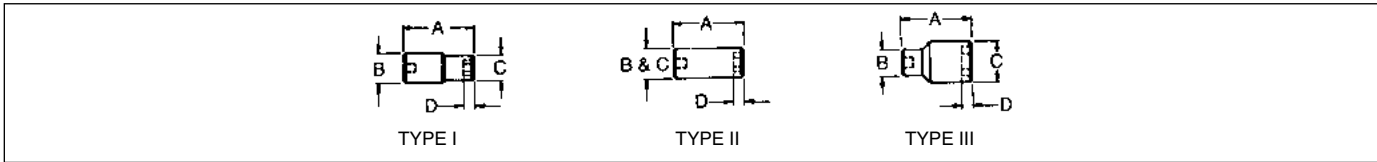

1/2" Square Drive 12 Point Standard — Metric									
Opening	Type	Length	Drive End	Opening End	Minimum Depth	Wt. Ea. Lbs.	Chrome	Std. Pkg. Qty.	Opening
		A	B	C	D		Part No.		
9 mm	I	1 15/32	3/16	33/64	7/32	.09	STM1209	5	9 mm
10 mm	I	1 15/32	3/16	37/64	1/64	.09	STM1210	5	10 mm
11 mm	I	1 15/32	3/16	41/64	9/32	.09	STM1211	5	11 mm
12 mm	I	1 15/32	3/16	1/16	5/16	.10	STM1212	5	12 mm
13 mm	I	1 15/32	3/16	47/64	5/16	.10	STM1213	5	13 mm
14 mm	II	1 15/32	—	13/16	11/32	.12	STM1214	5	14 mm
15 mm	II	1 15/32	—	5/64	1/32	.13	STM1215	5	15 mm
16 mm	II	1 15/32	—	7/8	3/8	.13	STM1216	5	16 mm
17 mm	II	1 15/32	—	15/16	3/8	.17	STM1217	5	17 mm
18 mm	II	1 15/32	—	1	13/32	.14	STM1218	5	18 mm
19 mm	II	1 15/32	—	1 1/16	7/16	.19	STM1219	5	19 mm
20 mm	II	1 1/2	—	1 3/32	29/64	.17	STM1220	5	20 mm
21 mm	II	1 1/16	—	1 1/64	15/32	.24	STM1221	5	21 mm
22 mm	II	1 5/8	—	1 11/64	1/2	.24	STM1222	5	22 mm
23 mm	II	1 7/8	—	1 1/32	33/64	.25	STM1223	5	23 mm
24 mm	II	1 5/8	—	1 1/4	35/64	.29	STM1224	5	24 mm
25 mm	II	1 11/16	—	1 1/16	9/16	.29	STM1225	5	25 mm
26 mm	III	1 3/4	1 3/32	1 1/8	19/32	.30	STM1226	5	26 mm
27 mm	III	1 3/4	1 3/32	1 13/32	5/8	.30	STM1227	5	27 mm
30 mm	III	1 7/8	1 1/8	1 37/64	21/32	.40	STM1230	5	30 mm
32 mm	III	1 59/64	1 1/8	1 21/32	3/4	.44	STM1232	5	32 mm
36 mm	III	2	1 23/64	1 61/64	29/32	.46	STM1236	5	36 mm

1/2" Square Drive 12 Point Deep — Metric									
Opening	Type	Length	Drive End	Opening End	Minimum Depth	Wt. Ea. Lbs.	Chrome	Std. Pkg. Qty.	Opening
		A	B	C	D		Part No.		
10 mm	I	79.5 mm	22.1 mm	15.2 mm	16.0 mm	.22	SMD1210	5	10 mm
11 mm	I	79.5 mm	22.1 mm	18.3 mm	17.0 mm	.22	SMD1211	5	11 mm
12 mm	I	79.5 mm	22.1 mm	18.8 mm	18.0 mm	.22	SMD1212	5	12 mm
13 mm	I	79.5 mm	22.1 mm	19.3 mm	20.1 mm	.26	SMD1213	5	13 mm
14 mm	I	79.5 mm	22.1 mm	21.8 mm	23.9 mm	.26	SMD1214	5	14 mm
15 mm	II	79.5 mm	21.8 mm	21.8 mm	26.9 mm	.26	SMD1215	5	15 mm
16 mm	II	79.5 mm	22.1 mm	22.1 mm	30.0 mm	.32	SMD1216	5	16 mm
17 mm	II	79.5 mm	24.4 mm	24.4 mm	31.0 mm	.32	SMD1217	5	17 mm
18 mm	II	79.5 mm	25.4 mm	25.4 mm	31.0 mm	.33	SMD1218	5	18 mm
19 mm	II	79.5 mm	26.9 mm	26.9 mm	33.0 mm	.38	SMD1219	5	19 mm
20 mm	II	79.5 mm	27.9 mm	27.9 mm	33.0 mm	.41	SMD1220	5	20 mm
21 mm	II	79.5 mm	28.4 mm	28.4 mm	33.0 mm	.41	SMD1221	5	21 mm
22 mm	II	79.5 mm	30.2 mm	30.2 mm	33.0 mm	.46	SMD1222	5	22 mm
23 mm	II	79.5 mm	31.0 mm	31.0 mm	33.0 mm	.51	SMD1223	5	23 mm
24 mm	II	79.5 mm	32.0 mm	32.0 mm	35.1 mm	.57	SMD1224	5	24 mm
25 mm	II	79.5 mm	33.3 mm	33.3 mm	35.1 mm	.70	SMD1225	5	25 mm
26 mm	II	79.5 mm	34.0 mm	34.0 mm	35.1 mm	.74	SMD1226	5	26 mm
27 mm	II	79.5 mm	35.8 mm	35.8 mm	35.1 mm	.78	SMD1227	5	27 mm

TOOLS





1/2" Drive Metric Sockets & Sets — Chrome

MS10K	
SMD1216 16 mm 12 pt. Deep Skt.	SMD1222 22 mm 12 pt. Deep Skt.
SMD1217 17 mm 12 pt. Deep Skt.	SMD1224 24 mm 12 pt. Deep Skt.
SMD1218 18 mm 12 pt. Deep Skt.	SMD1225 25 mm 12 pt. Deep Skt.
SMD1219 19 mm 12 pt. Deep Skt.	SMD1226 26 mm 12 pt. Deep Skt.
SMD1220 20 mm 12 pt. Deep Skt.	261 CLIP RAIL
SMD1221 21 mm 12 pt. Deep Skt.	



MS16K	
STM1210 10 mm 12 pt. Std. Skt.	STM1219 19 mm 12 pt. Std. Skt.
STM1211 11 mm 12 pt. Std. Skt.	STM1220 20 mm 12 pt. Std. Skt.
STM1212 12 mm 12 pt. Std. Skt.	STM1221 21 mm 12 pt. Std. Skt.
STM1213 13 mm 12 pt. Std. Skt.	STM1222 22 mm 12 pt. Std. Skt.
STM1214 14 mm 12 pt. Std. Skt.	STM1223 23 mm 12 pt. Std. Skt.
STM1215 15 mm 12 pt. Std. Skt.	SF51 10" Ratchet
STM1216 16 mm 12 pt. Std. Skt.	S110P 5" Extension
STM1217 17 mm 12 pt. Std. Skt.	95 TOOL BOX
STM1218 18 mm 12 pt. Std. Skt.	



MS17K		METRIC
STM1210 10 mm 12 pt. Skt.	STM1219 19 mm 12 pt. Skt.	
STM1211 11 mm 12 pt. Skt.	STM1220 20 mm 12 pt. Skt.	
STM1212 12 mm 12 pt. Skt.	STM1221 21 mm 12 pt. Skt.	
STM1213 13 mm 12 pt. Skt.	STM1222 22 mm 12 pt. Skt.	
STM1214 14 mm 12 pt. Skt.	STM1224 24 mm 12 pt. Skt.	
STM1215 15 mm 12 pt. Skt.	SF51 10" Reversible Ratchet	
STM1216 16 mm 12 pt. Skt.	SF41 17" Flexible Handle	
STM1217 17 mm 12 pt. Skt.	S110P 5" Extension	
STM1218 18 mm 12 pt. Skt.	95 TOOL BOX	

MS18K		METRIC
STM1209 9 mm 12 pt. Skt.	STM1219 19 mm 12 pt. Skt.	
STM1210 10 mm 12 pt. Skt.	STM1220 20 mm 12 pt. Skt.	
STM1211 11 mm 12 pt. Skt.	STM1221 21 mm 12 pt. Skt.	
STM1212 12 mm 12 pt. Skt.	STM1222 22 mm 12 pt. Skt.	
STM1213 13 mm 12 pt. Skt.	STM1224 24 mm 12 pt. Skt.	
STM1214 14 mm 12 pt. Skt.	STM1227 27 mm 12 pt. Skt.	
STM1215 15 mm 12 pt. Skt.	STM1230 30 mm 12 pt. Skt.	
STM1216 16 mm 12 pt. Skt.	STM1232 32 mm 12 pt. Skt.	
STM1217 17 mm 12 pt. Skt.	59 METAL TRAY	
STM1218 18 mm 12 pt. Skt.		

TOOLS

1/2" Drive Metric Sockets & Sets — Chrome



MS27K			
STM1210.....	10 mm 12 pt. Std. Skt.	STM1224.....	24 mm 12 pt. Std. Skt.
STM1211.....	11 mm 12 pt. Std. Skt.	STM1225.....	25 mm 12 pt. Std. Skt.
STM1212.....	12 mm 12 pt. Std. Skt.	STM1226.....	26 mm 12 pt. Std. Skt.
STM1213.....	13 mm 12 pt. Std. Skt.	STM1227.....	27 mm 12 pt. Std. Skt.
STM1214.....	14 mm 12 pt. Std. Skt.	STM1230.....	30 mm 12 pt. Std. Skt.
STM1215.....	15 mm 12 pt. Std. Skt.	STM1232.....	32 mm 12 pt. Std. Skt.
STM1216.....	16 mm 12 pt. Std. Skt.	STM1236.....	36 mm 12 pt. Std. Skt.
STM1217.....	17 mm 12 pt. Std. Skt.	SF41.....	17" Flex Handle
STM1218.....	18 mm 12 pt. Std. Skt.	SF51.....	10" Ratchet
STM1219.....	19 mm 12 pt. Std. Skt.	S102P.....	2" Extension
STM1220.....	20 mm 12 pt. Std. Skt.	S110P.....	5" Extension
STM1221.....	21 mm 12 pt. Std. Skt.	S115P.....	10" Extension
STM1222.....	22 mm 12 pt. Std. Skt.	S140.....	Universal Joint
STM1223.....	23 mm 12 pt. Std. Skt.	248.....	CLIP RAIL
		258.....	CLIP RAIL
		BX21.....	TOOL BOX

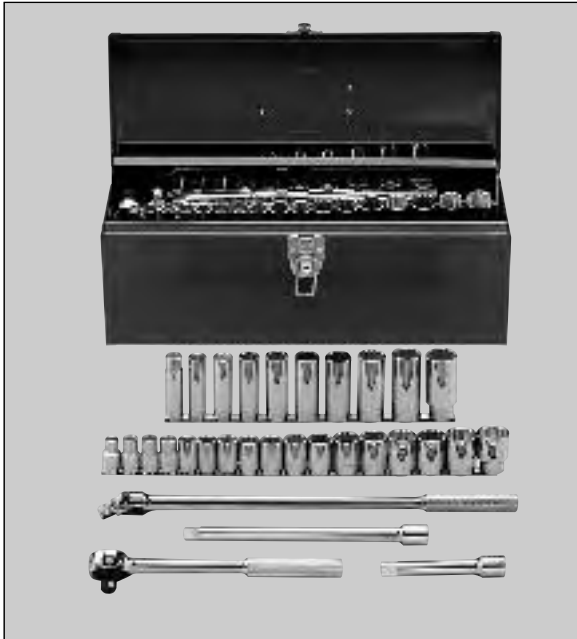

MS31K			
STM1210.....	10 mm 12 pt. Std. Skt.	SMD1216.....	16 mm 12 pt. Deep Skt.
STM1211.....	11 mm 12 pt. Std. Skt.	SMD1217.....	17 mm 12 pt. Deep Skt.
STM1212.....	12 mm 12 pt. Std. Skt.	SMD1218.....	18 mm 12 pt. Deep Skt.
STM1213.....	13 mm 12 pt. Std. Skt.	SMD1219.....	19 mm 12 pt. Deep Skt.
STM1214.....	14 mm 12 pt. Std. Skt.	SMD1220.....	20 mm 12 pt. Deep Skt.
STM1215.....	15 mm 12 pt. Std. Skt.	SMD1221.....	21 mm 12 pt. Deep Skt.
STM1216.....	16 mm 12 pt. Std. Skt.	SMD1222.....	22 mm 12 pt. Deep Skt.
STM1217.....	17 mm 12 pt. Std. Skt.	SMD1224.....	24 mm 12 pt. Deep Skt.
STM1218.....	18 mm 12 pt. Std. Skt.	SMD1225.....	25 mm 12 pt. Deep Skt.
STM1219.....	19 mm 12 pt. Std. Skt.	SMD1226.....	26 mm 12 pt. Deep Skt.
STM1220.....	20 mm 12 pt. Std. Skt.	S110P.....	5" Extension
STM1221.....	21 mm 12 pt. Std. Skt.	S115P.....	10" Extension
STM1222.....	22 mm 12 pt. Std. Skt.	SF41.....	17" Flexible Handle
STM1223.....	23 mm 12 pt. Std. Skt.	SF51.....	10" Reversible Ratchet
STM1224.....	24 mm 12 pt. Std. Skt.	258.....	CLIP RAIL
STM1225.....	25 mm 12 pt. Std. Skt.	261.....	CLIP RAIL
STM1226.....	26 mm 12 pt. Std. Skt.	BX21.....	TOOL BOX

TOOLS

Martin

1/2" Drive Power/Impact

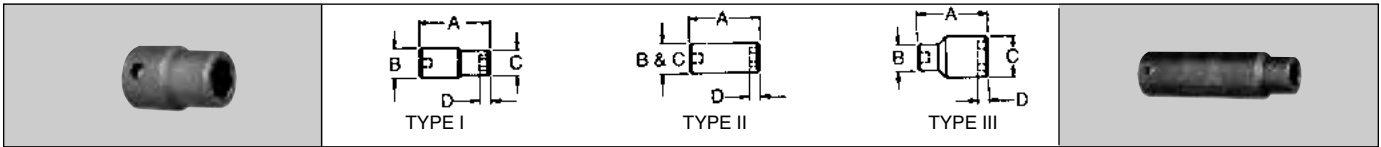

Martin Heavy Duty Power Impact Sockets are Specially Designed for Use with All Types of Power Wrenches. All Sockets are Hot Forged from the Finest Alloy Steels for Maximum Strength and Durability. Heat Treated by Carefully Controlled Methods, the Sockets are Accurately Broached in 6 Point Openings. All Power Impact Sockets are Finished in Rust Resistant Black Oxide.

1/2" Square Drive 6 Point Standard									
Opening	Type	Length	Drive End	Opening End	Opening Depth	Wt. Ea. Lbs.	Industrial Black	Std. Pkg. Qty.	Opening
		A	B	C	D		Part No.		
3/8	I	1 15/32	15/16	2 1/32	5/32	.14	4612	5	3/8
7/16	I	1 15/32	15/16	4 5/64	7/32	.16	4614	5	7/16
1/2	I	1 15/32	15/16	2 5/32	7/64	.18	4616	5	1/2
9/16	I	1 15/32	15/16	5 5/64	2 1/64	.17	4618	5	9/16
5/8	II	1 15/32	—	1 5/16	3/8	.20	4620	5	5/8
1 1/16	II	1 1/2	—	1	3/8	.23	4622	5	1 1/16
3/4	II	1 1/2	—	1 3/64	7/16	.23	4624	5	3/4
1 1/16	II	1 1/6	—	1 5/32	2 5/64	.25	4626	5	1 1/16
7/8	II	1 5/8	—	1 1/2	1/2	.31	4628	5	7/8
1 1/16	II	1 5/8	—	1 1 5/64	3 5/64	.33	4630	5	1 1/16
1	III	1 1 1/16	1 3/64	1 2 3/64	3 5/64	.31	4632	5	1
1 1/16	III	1 3/4	1 3/32	1 7/16	5/8	.37	4634	5	1 1/16
1 1/8	III	1 13/16	1 1/4	1 1/2	2 1/32	.40	4636	5	1 1/8
1 1/4	III	1 7/8	1 1 3/32	1 1 1/16	2 1/32	.43	4638	5	1 1/4
1 1/2	III	1 5 9/64	1 1/8	1 4 1/64	3/4	.43	4640	5	1 1/2

1/2" Square Drive 6 Point Deep									
Opening	Type	Length	Drive End	Opening End	Opening Depth	Wt. Ea. Lbs.	Industrial Black	Std. Pkg. Qty.	Opening
		A	B	C	D		Part No.		
3/8	I	3 1/4	15/16	5/8	5/32	.42	14612	5	3/8
7/16	I	3 1/4	15/16	4 5/64	7/32	.42	14614	5	7/16
1/2	I	3 1/4	15/16	2 5/32	1 7/64	.43	14616	5	1/2
9/16	I	3 1/4	15/16	5 5/64	2 1/64	.43	14618	5	9/16
5/8	II	3 1/4	—	1 5/16	3/8	.40	14620	5	5/8
1 1/16	II	3 3/4	—	1	3/8	.37	14622	5	1 1/16
3/4	II	3 3/4	—	1 3/64	7/16	.45	14624	5	3/4
1 1/16	II	3 3/4	—	1 5/32	2 5/64	.49	14626	5	1 1/16
7/8	II	3 3/4	—	1 1/2	1/2	.54	14628	5	7/8
1 1/16	II	3 3/4	—	1 1 5/64	3 5/64	.62	14630	5	1 1/16
1	III	3 3/4	1 3/32	1 2 3/64	3 5/64	.57	14632	5	1
1 1/16	III	3 3/4	1 3/32	1 7/16	5/8	.62	14634	5	1 1/16
1 1/8	III	3 3/4	1 1/4	1 1/2	2 1/32	.62	14636	5	1 1/8
1 1/4	III	3 3/4	1 1/8	1 4 1/64	3/4	.73	14640	5	1 1/4

Item	Description	Wt. Ea. Lbs.	Part No.	Std. Pkg. Qty.
	1/2 U-Joint	.44	4140A	5
	1/2 F x 3/8M	.13	42A	5
	1/2 F x 1/4M	.44	46	5
	6" Extension	.67	4105A	5

1/2" ATTACHMENTS

TOOLS

1/2" Drive Power/Impact Sets

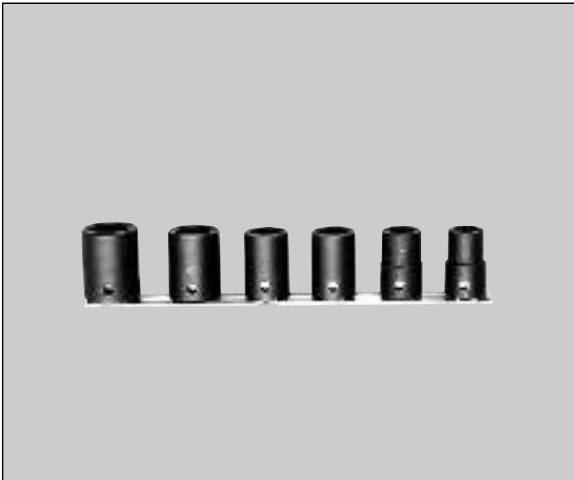

IS6K	
4616	1/2" 6 pt. Skt.
4618	9/16" 6 pt. Skt.
4620	5/8" 6 pt. Skt.
4622	11/16" 6 pt. Skt.
4624	3/4" 6 pt. Skt.
4626	13/16" 6 pt. Skt.
248	CLIP RAIL



IS6KD	
14616	1/2" 6 pt. Deep Skt.
14618	9/16" 6 pt. Deep Skt.
14620	5/8" 6 pt. Deep Skt.
14622	11/16" 6 pt. Deep Skt.
14624	3/4" 6 pt. Deep Skt.
14626	13/16" 6 pt. Deep Skt.
248	CLIP RAIL



IS10KD	
14614	7/16" 6 pt. Deep Skt.
14616	1/2" 6 pt. Deep Skt.
14618	9/16" 6 pt. Deep Skt.
14620	5/8" 6 pt. Deep Skt.
14622	11/16" 6 pt. Deep Skt.
14624	3/4" 6 pt. Deep Skt.
14626	13/16" 6 pt. Deep Skt.
14628	7/8" 6 pt. Deep Skt.
14630	15/16" 6 pt. Deep Skt.
14632	1" 6 pt. Deep Skt.
261	CLIP RAIL

TOOLS



1/2" Drive Metric Socket Sets Power/Impact

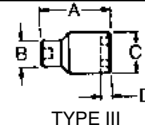
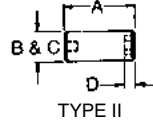
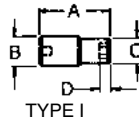

1/2" Square Drive 6 Point Standard — Metric

Opening	Type	Length	Drive End	Opening End	Minimum Depth	Wt. Ea. Lbs.	Industrial Black	Std. Pkg. Qty.	Opening
		A	B	C	D		Part No.		
13 mm	I	38.0 mm	24.7 mm	18.9 mm	8.0 mm	.17	4M613	5	13 mm
14 mm	I	38.0 mm	24.7 mm	20.3 mm	9.0 mm	.17	4M614	5	14 mm
15 mm	II	38.0 mm	24.7 mm	24.7 mm	9.0 mm	.17	4M615	5	15 mm
16 mm	II	38.0 mm	24.7 mm	24.7 mm	10.0 mm	.17	4M616	5	16 mm
17 mm	II	38.0 mm	26.3 mm	26.3 mm	11.0 mm	.17	4M617	5	17 mm
18 mm	II	38.0 mm	27.2 mm	27.2 mm	12.0 mm	.17	4M618	5	18 mm
19 mm	II	41.0 mm	29.5 mm	29.5 mm	12.0 mm	.09	4M619	5	19 mm
21 mm	II	41.0 mm	32.0 mm	32.0 mm	13.0 mm	.09	4M621	5	21 mm
22 mm	II	41.0 mm	33.0 mm	33.0 mm	14.0 mm	.09	4M622	5	22 mm
24 mm	II	41.0 mm	35.5 mm	35.5 mm	14.5 mm	.09	4M624	5	24 mm
27 mm	II	41.0 mm	39.6 mm	39.6 mm	14.5 mm	.09	4M627	5	27 mm

MIS6K

4M613 13 mm 6 pt. Std. Skt. 4M617 17 mm 6 pt. Std. Skt.
 4M614 14 mm 6 pt. Std. Skt. 4M618 18 mm 6 pt. Std. Skt.
 4M615 15 mm 6 pt. Std. Skt. 248 CLIP RAIL
 4M616 16 mm 6 pt. Std. Skt.



MIS11K

4M613 13 mm 6 pt. Std. Skt. 4M619 19 mm 6 pt. Std. Skt.
 4M614 14 mm 6 pt. Std. Skt. 4M621 21 mm 6 pt. Std. Skt.
 4M615 15 mm 6 pt. Std. Skt. 4M622 22 mm 6 pt. Std. Skt.
 4M616 16 mm 6 pt. Std. Skt. 4M624 24 mm 6 pt. Std. Skt.
 4M617 17 mm 6 pt. Std. Skt. 4M627 27 mm 6 pt. Std. Skt.
 4M618 18 mm 6 pt. Std. Skt. 248 CLIP RAIL



3/4" Drive Sockets & Attachments — Chrome

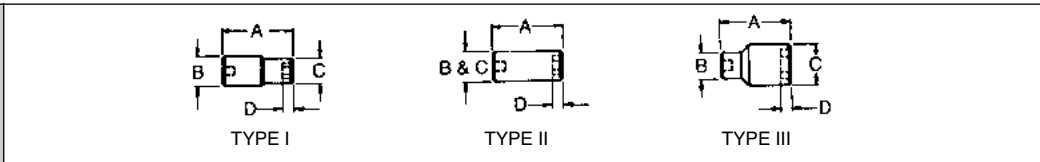

3/4" Square Drive 12 Point Standard Chrome									
Opening	Type	Length	Drive End	Opening End	Opening Depth	Wt. Ea. Lbs.	Chrome	Std. Pkg. Qty.	Opening
		A	B	C	D		Part No.		
3/4"	I	2	1 1/64	1 1/64	1/2	.40	H1224	5	3/4"
13/16"	II	2	—	1 1/64	1/2	.41	H1226	5	13/16"
7/8"	II	2	—	1 1/32	1/2	.35	H1228	5	7/8"
15/16"	II	2	—	1 3/8	3/4	.43	H1230	5	15/16"
1"	II	2 1/16	—	1 1/8	3/8	.50	H1232	5	1"
1 1/16"	III	2 1/16	1 1/16	1 1/8	3/8	.57	H1234	5	1 1/16"
1 1/8"	III	2 3/8	1 1/8	1 3/8	2 1/32	.65	H1236	5	1 1/8"
1 3/16"	III	2 1/2	1 1/8	1 11/16	2 1/32	.59	H1238	5	1 3/16"
1 1/4"	III	2 5/8	1 1/8	1 3/8	3/4	.78	H1240	5	1 1/4"
1 5/16"	III	2 3/4	1 3/8	1 7/8	4 9/64	.79	H1242	3	1 5/16"
1 3/8"	III	2 3/4	1 1/8	1 7/8	2 5/32	.69	H1244	3	1 3/8"
1 1/2"	III	2 5/8	1 1/8	2 1/64	7/8	.87	H1246	3	1 1/2"
1 1/2"	III	2 5/8	1 35/64	2 3/32	55/64	.94	H1248	3	1 1/2"
1 5/8"	III	2 5/8	1 19/32	2 3/32	55/64	.91	H1250	3	1 5/8"
1 5/8"	III	2 5/8	1 19/32	2 5/32	1	.98	H1252	3	1 5/8"
1 11/16"	III	2 7/8	1 5/8	2 7/32	1	1.00	H1254	3	1 11/16"
1 3/4"	III	2 3/2	1 23/32	2 5/16	1 1/32	1.23	H1256	3	1 3/4"
1 7/8"	III	2 13/16	1 3/4	2 3/8	1 1/8	1.31	H1258	3	1 7/8"
1 7/8"	III	2 7/8	1 3/4	2 15/32	1 1/8	1.33	H1260	3	1 7/8"
2"	III	3	1 3/4	2 39/64	1 7/32	1.54	H1264	1	2"
2 1/16"	III	3 1/32	1 15/16	2 23/32	1 7/32	2.13	H1266	1	2 1/16"
2 1/8"	III	3 1/8	1 15/16	2 55/64	1 7/32	2.19	H1268	1	2 1/8"
2 1/8"	III	3 1/8	1 15/16	2 55/64	1 3/8	2.00	H1270	1	2 1/8"
2 1/4"	III	3 1/4	2	3 1/16	1 3/8	2.50	H1272	1	2 1/4"
2 3/8"	III	3 1/4	2	3 1/16	1 3/8	2.16	H1276	1	2 3/8"

Item	Description	Wt. Ea. Lbs.	Chrome Part No.	Black Part No.	Std. Pkg. Qty.	3/4" ATTACHMENTS
Flex Hdle.	21 1/2" Flexible Hdle.	5.63	H41A		1	
Flex Hdle.	21 1/2" Flexible Hdle.	5.63		BLKH41A	1	
Ratchet Repair Kit	24" Rev. Ratchet Ratchet Repair Kit	5.38 1.00	H51 H51RU		1 1	
Ratchet Repair Kit	24" Rev. Ratchet Ratchet Repair Kit	5.38 1.00		BLKH51 BLKH51RU	1 1	
Sliding T	17 1/2" Sliding Hd.	2.45	H20A		1	
Extension	3 1/2" Extension	1.27	H104		1	
Extension	8" Extension	2.25	H110		1	
Extension	16" Extension	3.13	H115		1	
Universal	U-Joint	1.08	H140		1	

TOOLS

H12K

H1228..... 7/8" 12 pt. Skt.	H1246..... 1 7/16" 12 pt. Skt.
H1230..... 15/16" 12 pt. Skt.	H1248..... 1 1/2" 12 pt. Skt.
H1234..... 1 1/16" 12 pt. Skt.	H1252..... 1 5/8" 12 pt. Skt.
H1236..... 1 1/8" 12 pt. Skt.	H51..... Rev. Ratchet
H1240..... 1 1/4" 12 pt. Skt.	H110..... 8" Extension
H1242..... 1 5/16" 12 pt. Skt.	96A..... METAL BOX
H1244..... 1 3/8" 12 pt. Skt.	



H17K

H1228..... 7/8" 12 pt. Skt.	H1252..... 1 5/8" 12 pt. Skt.
H1230..... 15/16" 12 pt. Skt.	H1256..... 1 3/4" 12 pt. Skt.
H1234..... 1 1/16" 12 pt. Skt.	H1258..... 1 13/16" 12 pt. Skt.
H1236..... 1 1/8" 12 pt. Skt.	H1260..... 1 7/8" 12 pt. Skt.
H1240..... 1 1/4" 12 pt. Skt.	H1264..... 2" 12 pt. Skt.
H1242..... 1 5/16" 12 pt. Skt.	H51..... Rev. Ratchet
H1244..... 1 3/8" 12 pt. Skt.	H110..... 8" Extension
H1246..... 1 7/16" 12 pt. Skt.	H115..... 16" Extension
H1248..... 1 1/2" 12 pt. Skt.	237..... METAL BOX



H20K

H51..... Rev. Ratchet	H1242..... 1 1/16" 12 pt. Skt.
H104..... 3 1/2" Extension	H1244..... 1 3/8" 12 pt. Skt.
H110..... 8" Extension	H1246..... 1 7/16" 12 pt. Skt.
H41A..... 21 5/8" Flexible Hdle.	H1248..... 1 1/2" 12 pt. Skt.
H1228..... 7/8" 12 pt. Skt.	H1252..... 1 5/8" 12 pt. Skt.
H1230..... 15/16" 12 pt. Skt.	H1254..... 1 11/16" 12 pt. Skt.
H1232..... 1" 12 pt. Skt.	H1256..... 1 3/4" 12 pt. Skt.
H1234..... 1 1/16" 12 pt. Skt.	H1258..... 1 13/16" 12 pt. Skt.
H1236..... 1 1/8" 12 pt. Skt.	H1260..... 1 7/8" 12 pt. Skt.
H1240..... 1 1/4" 12 pt. Skt.	H1264..... 2" 12 pt. Skt.
	237..... TOOL BOX



H22K

H51..... Rev. Ratchet	H1240..... 1 1/4" 12 pt. Skt.
H104..... 3 1/2" Extension	H1242..... 1 1/16" 12 pt. Skt.
H110..... 8" Extension	H1244..... 1 3/8" 12 pt. Skt.
H115..... 16" Extension	H1246..... 1 7/16" 12 pt. Skt.
H140..... Universal Joint	H1248..... 1 1/2" 12 pt. Skt.
H1228..... 7/8" 12 pt. Skt.	H1250..... 1 1/16" 12 pt. Skt.
H1230..... 15/16" 12 pt. Skt.	H1252..... 1 5/8" 12 pt. Skt.
H1232..... 1" 12 pt. Skt.	H1254..... 1 11/16" 12 pt. Skt.
H1234..... 1 1/16" 12 pt. Skt.	H1256..... 1 3/4" 12 pt. Skt.
H1236..... 1 1/8" 12 pt. Skt.	H1258..... 1 13/16" 12 pt. Skt.
	H1260..... 1 7/8" 12 pt. Skt.
	H1264..... 2" 12 pt. Skt.
	237..... TOOL BOX



Heavy-Duty Hand Tools

Martin

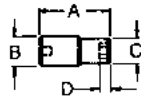

TYPE I

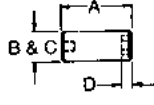

TYPE II

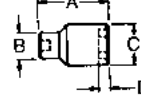

TYPE III



3/4" Square Drive 6 Point Standard

Opening	Type	Length	Drive End	Opening End	Minimum Depth	Wt. Ea. Lbs.	Industrial Black	Std. Pkg. Qty.	Opening
		A	B	C	D		Part No.		
3/8	I	2 1/8	1 3/8	1 3/8	3/32	.65	6620	5	3/8
1/2	I	2 1/8	1 3/8	1 3/8	5/16	.66	6622	5	1/2
5/8	I	2 1/8	1 3/8	1 15/64	9/16	.67	6624	5	5/8
11/16	I	2 1/8	1 3/8	1 23/64	5/8	.75	6626	5	11/16
3/4	I	2 1/8	1 3/8	1 1/2	5/8	.91	6628	5	3/4
13/16	I	2 1/8	1 3/8	1 1/8	11/32	.77	6630	5	13/16
1	II	2 1/8	—	1 1/8	3/4	.85	6632	5	1
1 1/16	II	2 1/8	1 3/4	1 11/16	13/16	.83	6634	5	1 1/16
1 1/8	II	2 1/8	—	1 1/4	13/16	.92	6636	5	1 1/8
1 1/4	II	2 1/8	1 7/8	1 1/8	7/8	.94	6638	5	1 1/4
1 1/2	II	2 1/8	2	2	29/32	1.24	6640	3	1 1/2
1 5/8	II	2 1/8	2	2	29/64	1.38	6642	3	1 5/8
1 3/4	III	2 1/4	1 29/32	2 1/8	25/32	1.38	6644	3	1 3/4
1 7/8	III	2 1/4	1 29/32	2 1/8	5/8	1.33	6646	3	1 7/8
2	III	2 1/2	1 29/32	2 5/8	55/64	1.71	6648	3	2
1 1/16	III	2 1/2	1 29/32	2 15/32	55/64	1.80	6650	3	1 1/16
1 1/8	III	2 1/2	1 29/32	2 1/16	1	1.83	6652	3	1 1/8
1 1/4	III	2 3/8	1 29/32	2 1/2	1	1.90	6654	3	1 1/4
1 1/2	III	2 3/8	1 29/32	2 3/8	1	2.01	6656	3	1 1/2
1 5/8	III	2 3/8	1 29/32	2 3/8	1	2.16	6658	3	1 5/8
1 3/4	III	2 3/4	1 29/32	2 23/32	1 1/16	2.20	6660	3	1 3/4
1 7/8	III	2 3/4	1 29/32	2 13/16	1 1/16	2.25	6662	3	1 7/8
2	III	2 3/4	1 29/32	2 15/16	1 1/16	2.30	6664	3	2







3/4" Square Drive 6 Point Deep Socket

Opening	Type	Length	Drive End	Opening End	Minimum Depth	Wt. Ea. Lbs.	Industrial Black	Std. Pkg. Qty.	Opening
		A	B	C	D		Part No.		
3/8	I	3 3/8	1 5/8	1 15/64	9/16	1.10	16624	5	3/8
1/2	I	3 3/8	1 5/8	1 23/64	5/8	1.14	16626	5	1/2
5/8	I	3 3/8	1 5/8	1 1/2	5/8	1.24	16628	5	5/8
11/16	I	3 3/8	1 5/8	1 1/8	11/32	1.10	16630	5	11/16
1	II	3 3/8	—	1 1/8	3/4	1.30	16632	5	1
1 1/16	I	3 1/2	1 3/4	1 3/8	13/16	1.42	16634	5	1 1/16
1 1/8	I	3 1/2	1 3/4	1 11/16	13/16	1.39	16636	3	1 1/8
1 1/4	I	3 1/2	1 1/8	1 13/16	13/16	1.63	16638	3	1 1/4
1 1/2	II	3 1/2	2	1 13/16	29/32	1.58	16640	3	1 1/2
1 3/4	II	3 1/2	2	2	7/8	2.02	16642	3	1 3/4
1 5/8	III	3 1/2	1 29/32	2 1/8	7/8	2.13	16644	3	1 5/8
1 7/8	III	3 1/2	1 29/32	2 1/8	7/8	2.00	16646	3	1 7/8
2	III	3 1/2	1 29/32	2 5/8	55/64	2.33	16648	3	2
1 1/16	III	3 1/2	1 29/32	2 15/32	55/64	2.50	16650	3	1 1/16
1 1/8	III	3 1/2	1 29/32	2 1/16	55/64	2.70	16652	3	1 1/8
1 1/4	III	3 1/2	1 29/32	2 1/2	1	3.00	16654	3	1 1/4
1 1/2	III	3 1/2	1 29/32	2 1/16	1	3.20	16656	3	1 1/2
1 3/4	III	3 1/2	1 29/32	2 23/32	1	3.40	16660	3	1 3/4
2	III	3 3/4	1 29/32	2 15/16	1	4.00	16664	3	2

TOOLS



3/4" Drive Power/Impact Attachments Socket Sets

3/4" Drive Power/Impact Attachments					
3/4" ATTACHMENTS	Item	Description	Wt. Ea. Lbs.	Part No.	Std. Pkg. Qty.
	Adaptor	3/4F x 1/2M	.06	64A	5
	Adaptor	3/4F x 1M	.06	67	5
	Extension	7" Extension	1.77	6107	5
	Extension	10" Extension	2.25	6110	5
	Extension	13" Extension	4.15	6113	5
	Universal Joint	4 1/16 Lgth. Max.	.77	6140A	5
	Ret Ring®	Fits Part No. 64A	.01	M10005S	1
	Ret Ring®	Fits Part No. 67	.01	M10032S	1
	Ret Ring®	Fits Part No. 6107	.01	M10032S	1
	Ret Ring®	Fits Part No. 6110	.01	M10032S	1
	Ret Ring®	Fits Part No. 6113	.01	M10032S	1
	Ret Ring®	Fits Part No. 6140A	.01	M10032S	1
	Ret Ring®	Fits Part No. 6620 - 6634	.01	M10032S	1
	Ret Ring®	Fits Part No. 6636	.01	M10034S	1
	Ret Ring®	Fits Part No. 6638 - 6664	.01	M18708S	1
	Ret Ring®	Fits Part No. 16624 - 16634	.01	M10032S	1
	Ret Ring®	Fits Part No. 16636 - 16664	.01	M10034S	1

3/4" Drive 6 Point Deep 8 Pieces		
IH8K		
16628 7/8"	16636 1 1/8"	
16630 15/16"	16640 1 1/4"	
16632 1"	16642 1 1/2"	
16634 1 1/16"	16648 1 1/2"	

3/4" Drive 6 Point Standard 9 Pieces		
IH9K		
6624 3/4"	6634 1 1/16"	
6626 13/16"	6636 1 1/8"	
6628 7/8"	6638 1 1/4"	
6630 15/16"	6640 1 1/2"	
6632 1"		

TOOLS

1" Drive Chrome Sockets

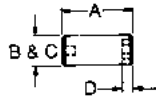

TYPE II

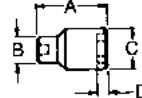

TYPE III

1" Square Drive 12 Point Standard Chrome

Opening	Type	Length	Drive End	Opening End	Minimum Depth	Wt. Ea. Lbs.	Chrome	Std. Pkg. Qty.	Opening
		A	B	C	D		Part No.		
1 ¹ / ₁₆	II	2 ³ / ₃₂	1 ⁴ / ₆₄	1 ⁴ / ₆₄	³ / ₁₆	.90	X1234	1	1 ¹ / ₁₆
1 ¹ / ₈	II	2 ³ / ₃₂	1 ¹ / ₁₆	1 ¹ / ₁₆	² / ₃₂	.90	X1236	1	1 ¹ / ₈
1 ³ / ₁₆	II	2 ³ / ₃₂	1 ³ / ₄	1 ³ / ₄	² / ₃₂	.90	X1238	1	1 ³ / ₁₆
1 ¹ / ₄	II	2 ³ / ₃₂	1 ¹³ / ₁₆	1 ¹³ / ₁₆	³ / ₄	.90	X1240	1	1 ¹ / ₄
1 ³ / ₈	II	2 ¹ / ₃₂	1 ⁷ / ₈	1 ⁷ / ₈	⁴⁹ / ₆₄	.90	X1242	1	1 ³ / ₈
1 ¹ / ₂	II	2 ⁷ / ₁₆	1 ³ / ₄	1 ¹⁵ / ₁₆	²⁵ / ₃₂	.94	X1244	1	1 ¹ / ₂
1 ⁷ / ₁₆	III	2 ¹ / ₂	1 ³ / ₄	2	⁷ / ₁₆	.94	X1246	1	1 ⁷ / ₁₆
1 ¹ / ₂	III	2 ³ / ₁₆	1 ³ / ₄	2 ¹ / ₈	⁵ / ₆₄	1.06	X1248	1	1 ¹ / ₂
1 ⁵ / ₈	III	2 ¹ / ₁₆	1 ³ / ₄	2 ¹ / ₄	1	1.06	X1252	1	1 ⁵ / ₈
1 ¹ / ₁₆	III	2 ³ / ₄	1 ¹⁵ / ₁₆	2 ³ / ₈	1	1.50	X1254	1	1 ¹ / ₁₆
1 ³ / ₄	III	2 ¹³ / ₁₆	1 ¹⁵ / ₁₆	2 ¹ / ₂	1 ³ / ₃₂	1.50	X1256	1	1 ³ / ₄
1 ¹³ / ₁₆	III	2 ⁷ / ₈	1 ¹⁵ / ₁₆	2 ³ / ₁₆	1 ¹ / ₈	1.63	X1258	1	1 ¹³ / ₁₆
1 ⁷ / ₈	III	2 ¹⁵ / ₁₆	2 ¹ / ₄	2 ⁵ / ₈	1 ¹ / ₈	1.94	X1260	1	1 ⁷ / ₈
1 ¹⁵ / ₁₆	III	3	2 ¹ / ₄	2 ³ / ₄	1 ¹ / ₃₂	2.25	X1262	1	1 ¹⁵ / ₁₆
2	III	3	2 ¹ / ₄	2 ³ / ₄	1 ¹ / ₃₂	2.19	X1264	1	2
2 ¹ / ₈	III	3 ¹ / ₁₆	2 ¹ / ₄	2 ¹⁵ / ₁₆	1 ¹ / ₈	2.44	X1268	1	2 ¹ / ₈
2 ³ / ₁₆	III	3 ¹ / ₈	2 ¹ / ₄	3	1 ¹ / ₈	2.50	X1270	1	2 ³ / ₁₆
2 ¹ / ₄	III	3 ³ / ₁₆	2 ¹ / ₄	3 ¹ / ₈	1 ¹ / ₈	2.38	X1272	1	2 ¹ / ₄
2 ⁵ / ₁₆	III	3 ¹ / ₄	2 ¹ / ₄	3 ³ / ₃₂	1 ¹ / ₈	2.69	X1274	1	2 ⁵ / ₁₆
2 ³ / ₈	III	3 ³ / ₈	2 ¹ / ₄	3 ¹ / ₄	1 ¹ / ₈	2.88	X1276	1	2 ³ / ₈
2 ¹ / ₂	III	3 ⁵ / ₈	2 ¹ / ₄	3 ⁵ / ₁₆	1 ¹ / ₈	2.88	X1278	1	2 ¹ / ₂
2 ¹ / ₂	III	3 ⁷ / ₁₆	2 ¹ / ₄	3 ³ / ₈	1 ¹ / ₂	3.00	X1280	1	2 ¹ / ₂
2 ³ / ₈	III	3 ¹ / ₂	2 ¹ / ₄	3 ⁵ / ₈	1 ¹ / ₂	3.13	X1282	1	2 ³ / ₈
2 ⁵ / ₈	III	3 ³ / ₄	2 ¹ / ₄	3 ³ / ₄	1 ¹ / ₄	3.63	X1284	1	2 ⁵ / ₈
2 ³ / ₄	III	3 ¹ / ₁₆	2 ⁴⁵ / ₆₄	3 ²⁵ / ₃₂	1 ¹ / ₄	4.63	X1288	1	2 ³ / ₄
2 ¹³ / ₁₆	III	3 ³ / ₄	2 ⁴⁵ / ₆₄	3 ⁵⁵ / ₆₄	1 ¹ / ₄	5.13	X1290	1	2 ¹³ / ₁₆
2 ¹⁵ / ₁₆	III	3 ⁷ / ₈	2 ⁴⁵ / ₆₄	3 ⁶¹ / ₆₄	2	5.25	X1294	1	2 ¹⁵ / ₁₆
3	III	3 ¹⁵ / ₁₆	2 ⁴⁵ / ₆₄	4 ¹ / ₄	2	5.56	X1296	1	3
3 ¹ / ₈	III	4 ¹ / ₁₆	2 ⁴⁵ / ₆₄	4 ¹¹ / ₆₄	2 ¹⁵ / ₆₄	5.25	X12100	1	3 ¹ / ₈
3 ³ / ₈	III	4 ¹ / ₈	2 ⁴⁵ / ₆₄	4 ¹⁷ / ₃₂	2 ¹⁵ / ₆₄	6.31	X12108	1	3 ³ / ₈
3 ¹ / ₂	III	4 ¹ / ₈	2 ⁴⁵ / ₆₄	4 ¹¹ / ₁₆	2 ¹⁵ / ₆₄	6.50	X12112	1	3 ¹ / ₂

TOOLS

Martin Heavy Duty Chrome Hand Tool Sockets are Manufactured to Extremely Close Tolerances of American Alloy Steel. The 12 Point Broach Opening Provides a Secure Fit for Absolute Tightening and Loosening.

WARNING: Only Power Impact Sockets Should Be Used on Pneumatic or Electric Impact Wrenches. Never Use Chrome Sockets.



1" Drive Attachments & Socket Set

1" Drive Attachments						
Item	Description	Wt. Ea. Lbs.	Chrome Part No.	Black Part No.	Std. Pkg. Qty.	1" ATTACHMENTS
Ratchet	30" Rev. Ratchet	7.94	X51		1	
Repair Kit	Ratchet Repair	1.13	X51RU		1	
Ratchet	30" Rev. Ratchet	7.94		BLKX51	1	
Repair Kit	Ratchet Repair	1.13		BLKX51RU	1	
Extension	8" Extension	2.31	X108		1	
Extension	17" Extension	4.31	X117		1	
Flex Handle	26" Flexible Hdle.	8.19	X41A		1	

X21K		
X1246 1 ¹ / ₁₆ " 12 pt. Std. Skt. X1248 1 ¹ / ₂ " 12 pt. Std. Skt. X1252 1 ³ / ₈ " 12 pt. Std. Skt. X1254 1 ¹¹ / ₁₆ " 12 pt. Std. Skt. X1256 1 ³ / ₄ " 12 pt. Std. Skt. X1258 1 ¹³ / ₁₆ " 12 pt. Std. Skt. X1260 1 ⁷ / ₈ " 12 pt. Std. Skt. X1264 2" 12 pt. Std. Skt. X1268 2 ¹ / ₈ " 12 pt. Std. Skt. X1270 2 ³ / ₁₆ " 12 pt. Std. Skt. X1272 2 ¹ / ₄ " 12 pt. Std. Skt.	X1276 2 ³ / ₈ " 12 pt. Std. Skt. X1280 2 ¹ / ₂ " 12 pt. Std. Skt. X1284 2 ⁵ / ₈ " 12 pt. Std. Skt. X1288 2 ³ / ₄ " 12 pt. Std. Skt. X1294 2 ¹⁵ / ₁₆ " 12 pt. Std. Skt. X12100 3 ¹ / ₈ " 12 pt. Std. Skt. X51 Reversible Ratchet X108 8" Extension X117 17" Extension X41A Flexible Handle 299 METAL BOX	

Martin Heavy Duty Power Impact Sockets are Specially Designed for Use with All Types of Power Wrenches. All Sockets are Hot Forged from the Finest Alloy Steels for Maximum Strength and Durability. Heat Treated by Carefully Controlled Methods, the Sockets are Accurately Broached in 6 Point Openings. All Power Impact Sockets are Finished in Rust Resistant Black Oxide.

WARNING: Only Power Impact Sockets Should Be Used on Pneumatic or Electric Impact Wrenches. Never Use Chrome Sockets.

TOOLS

1" Drive Power/Impact

Martin

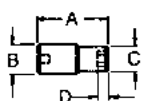

TYPE I

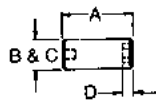

TYPE II

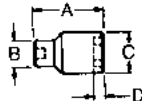

TYPE III

1" Drive 6 Point Standard

Opening	Type	Length	Drive End	Opening End	Minimum Depth	Wt. Ea. Lbs.	Industrial Black	Std. Pkg. Qty.	Opening
		A	B	C	D		Part No.		
3/4	I	2 1/4	2	1 1/16	1 1/4	1.13	7624	1	3/4
19/16	I	2 1/4	2	1 1/16	1 1/4	1.00	7626	1	19/16
7/8	I	2 13/32	2	1 17/32	45/64	1.06	7628	1	7/8
15/16	I	2 7/16	2	1 1/16	29/32	1.06	7630	1	15/16
1	I	2 17/32	2	1 21/32	49/64	1.19	7632	1	1
1 1/16	I	2 5/16	2	1 3/4	13/64	1.25	7634	1	1 1/16
1 1/8	I	2 5/16	2	1 13/16	27/64	1.25	7636	1	1 1/8
1 3/16	II	2 11/16	—	2 1/8	29/32	1.50	7638	1	1 3/16
1 1/4	II	2 11/16	—	2 1/8	29/32	1.50	7640	1	1 1/4
1 5/16	II	2 11/16	—	2 1/8	49/64	1.44	7642	1	1 5/16
1 3/8	III	2 11/16	2 1/8	2 1/4	49/64	1.69	7644	1	1 3/8
1 7/16	III	2 11/16	2 1/8	2 1/4	59/64	1.63	7646	1	1 7/16
1 1/2	III	2 11/16	2 3/8	2 1/4	59/64	1.56	7648	1	1 1/2
1 5/8	III	2 11/16	2 1/4	2 1/2	1	1.75	7650	1	1 5/8
1 5/8	III	2 11/16	2 1/4	2 1/2	1	1.81	7652	1	1 5/8
1 11/16	III	2 11/16	2 1/4	2 1/2	1	1.88	7654	1	1 11/16
1 3/4	III	2 11/16	2 7/16	2 3/4	1	2.50	7656	1	1 3/4
1 13/16	III	2 11/16	2 7/16	2 3/4	1 1/16	2.50	7658	1	1 13/16
1 7/8	III	2 5/8	2 7/16	2 3/4	1 1/8	2.56	7660	1	1 7/8
1 15/16	III	3	2 7/16	2 59/64	1 1/8	3.00	7662	1	1 15/16
2	III	3	2 7/16	2 59/64	1 11/64	2.88	7664	1	2
2 1/16	III	3	2 7/16	2 59/64	1 11/64	2.81	7666	1	2 1/16
2 1/8	III	3	2 7/16	3 1/4	1 13/64	3.63	7668	1	2 1/8
2 3/16	III	3 3/16	2 7/16	3 1/4	1 1/32	3.38	7670	1	2 3/16
2 1/4	III	3 3/16	2 7/16	3 1/4	1 1/32	3.19	7672	1	2 1/4
2 5/16	III	3 3/16	2 7/16	3 1/2	1 1/8	3.88	7674	1	2 5/16
2 3/8	III	3 1/4	2 7/16	3 1/2	1 23/64	3.75	7676	1	2 3/8
2 1/2	III	3 3/8	2 7/16	3 1/2	1 1/8	3.44	7678	1	2 1/2
2 5/8	III	3 3/8	2 7/16	3 1/2	1 1/2	3.78	7680	1	2 5/8
2 7/8	III	3 15/32	2 3/4	3 45/64	1 1/4	4.75	7684	1	2 7/8
2 11/16	III	3 15/32	2 3/4	3 59/64	1 1/2	4.88	7686	1	2 11/16
2 3/4	III	3 3/8	2 3/4	3 59/64	1 3/4	4.94	7688	1	2 3/4
2 13/16	III	3 11/16	2 3/4	4 1/64	1 3/4	5.01	7690	1	2 13/16
2 7/8	III	3 3/4	2 3/4	4	1 3/4	5.30	7692	1	2 7/8
2 15/16	III	3 3/4	2 3/4	4 1/64	2	5.56	7694	1	2 15/16
3	III	3 7/8	2 3/4	4 11/64	2	5.75	7696	1	3
3 1/16	III	3 15/16	2 3/4	4 11/64	2 3/64	5.63	76100	1	3 1/16
3 1/8	III	4 1/16	2 3/4	4 35/64	2	6.19	76104	1	3 1/8
3 3/8	III	4 1/8	2 3/4	4 17/32	2 13/64	7.06	76108	1	3 3/8
3 1/2	III	4 5/16	2 3/4	4 11/16	2 13/64	7.25	76112	1	3 1/2

TOOLS



1" Drive Power/Impact Deep/Attachments

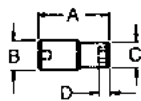

TYPE I

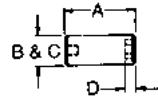

TYPE II

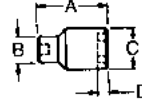

TYPE III

1" Drive 6 Point Deep

Opening	Type	Length	Drive End	Opening End	Minimum Depth	Wt. Ea. Lbs.	Industrial Black	Std. Pkg. Qty.	Opening
		A	B	C	D		Part No.		
3/4	I	4	2	1 1/16	2 3/64	2.25	17624	1	3/4
13/16	I	4	2	1 1/16	2 7/64	2.38	17626	1	13/16
7/8	I	4	2	1 1/32	2 3/64	2.41	17628	1	7/8
15/16	I	4	2	1 1/8	2 3/32	2.43	17630	1	15/16
1	I	4	2	1 1/4	2 1/32	2.38	17632	1	1
1 1/16	I	4	2	1 3/8	3/4	2.38	17634	1	1 1/16
1 1/8	I	4	2	1 13/16	13/16	2.39	17636	1	1 1/8
1 1/4	II	4	—	2 1/16	7/8	2.33	17638	1	1 1/4
1 1/2	II	4	—	2 1/8	29/32	2.31	17640	1	1 1/2
1 5/8	II	4	—	2 1/4	15/16	2.25	17642	1	1 5/8
1 3/4	III	4	2 1/2	2 1/4	49/64	2.10	17644	1	1 3/4
1 7/8	III	4	2 1/2	2 1/2	49/64	2.25	17646	1	1 7/8
1 5/4	III	4	2 1/2	2 1/2	55/64	2.75	17648	1	1 5/4
1 1/2	III	4	2 1/2	2 1/2	55/64	2.83	17650	1	1 1/2
1 1/4	III	4	2 1/2	2 1/2	1	2.84	17652	1	1 1/4
1 1/16	III	4	2 1/16	2 3/4	1	3.46	17654	1	1 1/16
1 3/8	III	4 1/16	2 1/16	2 3/4	1	3.46	17656	1	1 3/8
1 1/2	III	4 1/8	2 1/16	2 3/4	1	3.81	17658	1	1 1/2
1 5/8	III	4 1/4	2 1/16	2 3/4	1 1/16	3.85	17660	1	1 5/8
1 3/4	III	4 1/2	2 1/16	2 31/32	1 1/8	4.80	17662	1	1 3/4
2	III	4 5/8	2 1/8	2 31/32	1 1/8	4.52	17664	1	2
2 1/16	III	4 3/4	2 1/8	2 31/32	1 11/64	4.73	17666	1	2 1/16
2 1/8	III	4 7/8	2 1/8	3 1/4	1 11/64	5.00	17668	1	2 1/8
2 1/4	III	4 1/2	2 1/8	3 1/4	1 13/64	5.60	17670	1	2 1/4
2 3/8	III	4 31/32	2 1/8	3 1/4	1 1/2	5.30	17672	1	2 3/8
2 1/2	III	4 3/4	2 1/8	2 15/32	1 1/2	5.90	17674	1	2 1/2
2 5/8	III	4 7/8	2 1/8	2 15/32	1 1/8	6.50	17676	1	2 5/8

1" POWER OR IMPACT ATTACHMENTS	Item	Description	Wt. Ea. Lbs.	Part No.	Std. Pkg. Qty.
	Adaptor	1F x 3/4M	1.00	76	1
	Adaptor	1F x 1 1/2M	1.00	77	1
	Universal	Max Length 4.5"	3.04	7140A	1
	Extension	7" Extension	3.56	7107	1
	Extension	10" Extension	6.00	7110	1
	Extension	13" Extension	8.50	7113	1
	Ret Ring®	Fits Part No. 76	.01	M10008S	1
	Ret Ring®	Fits Part No. 77, 7140A, 7107, 7110, 7113	.01	M10010S	1
	Ret Ring®	Fits Part No. 7624 - 7642	.01	M10008S	1
	Ret Ring®	Fits Part No. 7644 - 7648	.01	M10010S	1
	Ret Ring®	Fits Part No. 7650 - 7654	.01	M10015S	1
	Ret Ring®	Fits Part No. 7656 - 7680	.01	M10016S	1
	Ret Ring®	Fits Part No. 7684 - 7696	.01	M10017S	1
	Ret Ring®	Fits Part No. 76100 - 76112	.01	M10017S	1
	Ret Ring®	Fits Part No. 17624 - 17642	.01	M10008S	1
	Ret Ring®	Fits Part No. 17644 - 17648	.01	M10010S	1
	Ret Ring®	Fits Part No. 17650 - 17652	.01	M10015S	1
	Ret Ring®	Fits Part No. 17654 - 17676	.01	M10016S	1

TOOLS

1½" Drive Power/Impact

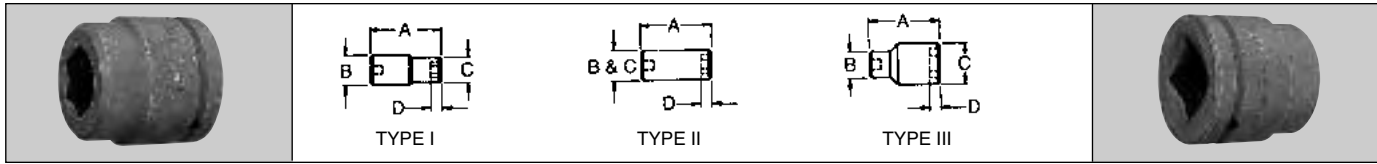

1½" Drive 6 Point Standard

Opening	Type	Length	Drive End	Opening End	Minimum Depth	Wt. Ea. Lbs.	Industrial Black	Std. Pkg. Qty.	Opening
							Part No.		
		A	B	C	D				
1½"	I	3½"	3¼"	2½"	¾"	5.70	8644	1	1½"
1½"	I	3½"	3¼"	2½"	¾"	5.70	8646	1	1½"
1½"	I	3½"	3¼"	2½"	¾"	5.70	8648	1	1½"
1½"	I	3½"	3¼"	2½"	¾"	5.70	8650	1	1½"
1½"	I	3½"	3¼"	3"	¾"	5.70	8652	1	1½"
1½"	I	3½"	3¼"	3"	¾"	5.70	8654	1	1½"
1½"	I	3½"	3¼"	3"	¾"	5.70	8656	1	1½"
1½"	I	3½"	3¼"	3"	¾"	5.70	8658	1	1½"
1½"	I	3½"	3¼"	3"	¾"	5.70	8660	1	1½"
1½"	I	3½"	3¼"	3"	¾"	5.70	8662	1	1½"
2"	II	3½"	3¼"	3¼"	1½"	5.70	8664	1	2"
2"	II	3½"	3¼"	3¼"	1½"	5.70	8666	1	2"
2"	III	3½"	3¼"	3½"	1½"	6.30	8668	1	2"
2"	III	3½"	3¼"	3½"	1½"	6.40	8670	1	2"
2"	III	3½"	3¼"	3½"	1½"	6.80	8672	1	2"
2"	III	3½"	3¼"	3½"	1½"	7.20	8674	1	2"
2"	III	3½"	3¼"	3½"	1½"	7.60	8676	1	2"
2"	III	3½"	3¼"	3½"	1½"	7.90	8678	1	2"
2"	III	4"	3¼"	3½"	1½"	8.20	8680	1	2"
2"	III	4"	3¼"	4"	1½"	8.50	8682	1	2"
2"	III	4½"	3¼"	4"	1½"	8.80	8684	1	2"
2"	III	4½"	3¼"	4"	1½"	8.90	8686	1	2"
2"	III	4½"	3¼"	4"	1½"	9.10	8688	1	2"
2"	III	4½"	3¼"	4"	1½"	9.30	8690	1	2"
2"	III	4½"	3¼"	4½"	1½"	9.50	8692	1	2"
2"	III	4½"	3¼"	4½"	1½"	9.80	8694	1	2"
3"	III	4½"	3¼"	4½"	1½"	9.90	8696	1	3"
3"	III	4½"	3¼"	4½"	1½"	12.70	8698	1	3"
3"	III	4½"	3¼"	4½"	1½"	12.70	86100	1	3"
3"	III	4½"	3¼"	4½"	1½"	12.50	86102	1	3"
3"	III	4½"	3¼"	5"	1½"	14.00	86104	1	3"
3"	III	4½"	3¼"	5"	1½"	13.70	86106	1	3"
3"	III	4½"	3¼"	5"	1½"	13.40	86108	1	3"
3"	III	4½"	3¼"	5"	1½"	13.50	86110	1	3"
3"	III	4½"	3¼"	5½"	1½"	13.90	86112	1	3"
3"	III	5"	3¼"	5½"	1½"	14.40	86114	1	3"
3"	III	5"	3¼"	5½"	1½"	15.00	86116	1	3"
3"	III	5"	3¼"	5½"	1½"	14.70	86118	1	3"
3"	III	5"	3¼"	5½"	1½"	14.70	86120	1	3"
3"	III	5"	3¼"	5½"	1½"	16.00	86122	1	3"
3"	III	5½"	3¼"	5½"	1½"	15.50	86124	1	3"
3"	III	5½"	3¼"	5½"	1½"	18.40	86126	1	3"
4"	III	5½"	3¼"	5½"	1½"	18.00	86128	1	4"
4"	III	5½"	3¼"	5½"	1½"	17.50	86130	1	4"
4"	III	5½"	3¼"	6"	1½"	20.20	86132	1	4"
4"	III	5½"	3¼"	6"	1½"	19.70	86134	1	4"
4"	III	5½"	3¼"	6"	1½"	19.20	86136	1	4"
4"	III	5½"	3¼"	6½"	1½"	22.00	86138	1	4"
4"	III	5½"	3¼"	6½"	1½"	21.60	86140	1	4"
4"	III	5½"	3¼"	6½"	1½"	21.00	86142	1	4"
4"	III	6"	3¼"	6½"	1½"	23.60	86144	1	4"
4"	III	6"	3¼"	6½"	1½"	23.60	86148	1	4"
4"	III	6"	3¼"	6½"	1½"	22.50	86152	1	4"

1½" Attachments

1½" DRIVE ATTACHMENTS	Item	Description	Wt. Ea. Lbs.	Industrial Black	Std. Pkg. Qty.
				Part No.	
	Adaptor	1½" F x 1M	3.40	87A	1
	Universal	Max. length 8.25"	4.40	8140A	1
	Extension	8" Extension	8.80	8108	1
	Extension	12" Extension	12.10	8112	1
	Extension	15" Extension	14.40	8115	1
	Ret Ring®	Fits Part No. 87A - 8670	.01	M10020S	1
	Ret Ring®	Fits Part No. 8672 - 86152	.01	M10025S	1

TOOLS

Martin

Hammers

Only *Martin* Provides This Added Warranty —
If a Hammer Head Should Loosen at Any Time, Return
It for Handle Replacement or a New Hammer.

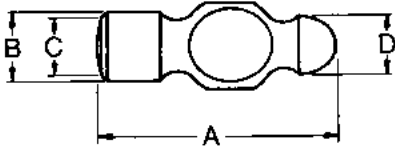

Standard Ball Peen — G Series — Wood and Fiberglass Handles

Head Weight	Overall Length	Head Length	Bell Dia.	Face	Peen	Replacement Handle		Weight With Handle	Industrial Black Head Finish		Std. Pkg. Qty.	Head Weight
		A	B	C	D	Wood	Fiberglass Kit		Wood Handle	Fiberglass Handle		
2 oz.	9½	2½	⅝	⅝	17/32	HH49		.25	101G		6	2 oz.
4 oz.	9½	2½	¾	¾	⅝	HH50		.37	102G		6	4 oz.
8 oz.	11½	3½	15/16	19/16	25/32	HH53		.66	103G		6	8 oz.
12 oz.	13¼	3¾	1½	19/16	15/16	HH56		1.0	104G		6	12 oz.
1 lb.	14¼	4	1½	69/64	1	HH59	HH105106FG	1.3	105G	105FG	6	1 lb.
1½ lb.	14½	43/16	1½	1½	13/64	HH59	HH105106FG	1.5	106G	106FG	6	1½ lb.
1½ lb.	14¾	47/16	121/64	17/64	1½	HH66	HH107FG	1.8	107G	107FG	6	1½ lb.
2 lb.	15¼	5	1½	1½	1¼	HH66	HH108FG	2.4	108G	108FG	4	2 lb.
2½ lb.	16¼	5½	127/32	127/64	123/64	HH69	HH109110FG	3.0	109G	109FG	4	2½ lb.
3 lb.	16¼	5½	129/32	1½	119/32	HH71	HH109110FG	3.4	110G	110FG	4	3 lb.

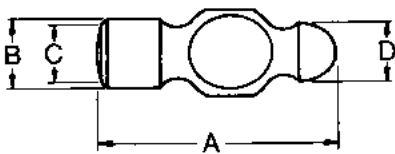

Utility Ball Peen — D Series

Head Weight	Overall Length	Head Length	Bell Dia.	Face	Peen	Replacement Handle	Weight With Handle	Shot Blasted Head Finish	Std. Pkg. Qty.	Head Weight
		A	B	C	D			Part No.		
8 oz.	11½	3½	15/16	19/16	25/32	HH53	.66	63D	6	8 oz.
12 oz.	13¼	3¾	1½	19/16	15/16	HH56	1.0	64D	6	12 oz.
1 lb.	14¼	4	1½	69/64	1	HH59	1.3	65D	6	1 lb.
1½ lb.	14½	43/16	1½	1½	13/64	HH59	1.5	66D	6	1½ lb.
1½ lb.	14¾	47/16	121/64	17/64	1½	HH66	1.8	67D	6	1½ lb.
2 lbs.	15¼	5	1½	1½	1¼	HH66	2.4	68D	4	2 lbs.
2½ lbs.	16¼	5½	127/32	127/64	123/64	HH69	3.0	69D	4	2½ lbs.
3 lbs.	16¼	5½	129/32	1½	119/32	HH71	3.4	70D	4	3 lbs.

Always wear eye protection. A hammer blow should always be struck squarely. Avoid glancing blows. Never use hammers, punches or chisels with "mushroomed" heads.

TOOLS

Hammers

Only *Martin* Provides This Added Warranty —
If a Hammer Head Should Loosen at Any Time, Return
It for Handle Replacement or a New Hammer.



WARNING: Never use Hammers with “Mushroomed” heads. They may chip and cause injury. “ALWAYS WEAR SAFETY GOGGLES.”

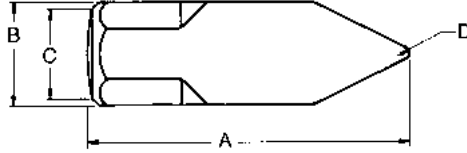

Cross Peen Engineer / Blacksmith Hand

Head Weight	Overall Length	Head Length	Bell Dia.	Face	Peen	Replacement Handle	Weight With Handle	Industrial Black Head Finish	Std. Pkg. Qty.	Head Weight	
		A	B	C	D			Part No.			
2 lbs.	15½	4¾	1½	1½	¾R	HH45	2.7	121G	4	2 lb.	
2½ lbs	15½	5⅙	1⅙	1½	¾R	HH45	3.2	122G	4	2½ lb.	
3 lbs.	15½	5¼	1¾	1¾	¼R	HH45	3.7	123G	4	3 lb.	



Double Faced Engineer's / Blacksmith

Head Weight	Overall Length	Head Length	Bell Dia.	Face	Replacement Handle	Weight With Handle	Industrial Black Head Finish	Std. Pkg. Qty.	Head Weight	
		A	B	C			Part No.			
2 lbs.	15½	4	1½	1½	HH45	2.7	141G	4	2 lb.	
2½ lbs	15½	4½	1½	1½	HH45	3.2	142G	4	2½ lb.	
3 lbs.	15½	5⅙	1¾	1½	HH45	3.7	143G	4	3 lb.	

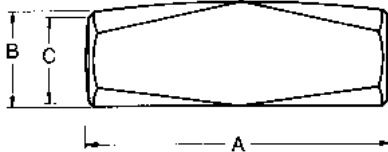

Hand Drilling

Head Weight	Overall Length	Head Length	Bell Dia.	Face	Replacement Handle	Weight With Handle	Industrial Black Head Finish	Std. Pkg. Qty.	Head Weight	
		A	B	C			Part No.			
2 lbs.	10½	4⅙	1¾	1½	HH92	2.6	192G	4	2 lbs.	
3 lbs.	10½	4¾	1½	1½	HH92	3.6	193G	4	3 lbs.	
4 lbs.	10½	4¾	1¾	1¾	HH92	4.4	194G	4	4 lbs.	



Scaling Hammer (Boiler Pick)

Head Weight	Overall Length	Head Length	Face Length	Face Radius	Replacement Handle	Weight with Handle Lbs.	Industrial Black Head Finish	Std. Pkg. Qty.	Head Weight	
		A	B	C			Part No.			
1 lb.	14	5⅙	1½	⅙	HH59	1.4	132G	6	1 lb.	

Martin

Hammers

Only *Martin* Provides This Added Warranty —
If a Hammer Head Should Loosen at Any Time, Return
It for Handle Replacement or a New Hammer.

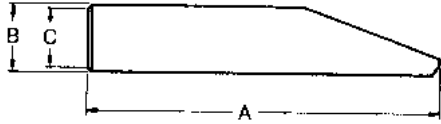

Always wear eye protection. A hammer blow should always be struck squarely. Avoid glancing blows. Never use hammers, punches or chisels with "mushroomed" heads.

Setting Paneing Hammer

Head Weight	Overall Length	Head Length	Head Width	Face Width	Replacement Handle	Weight with Handle Lbs.	Industrial Black Head Finish	Std. Pkg. Qty.	Head Weight
		A	B	C			Part No.		
12 oz.	13½	4 ¹ / ₁₆	7 ¹ / ₁₆	3 ¹ / ₄	HH801	1.1	30G	6	12 oz.
1 lb.	13½	5 ¹ / ₁₆	1 ⁵ / ₁₆	1 ³ / ₁₆	HH801	1.4	31G	6	1 lb.



Sledge Hammer

Head Weight	Head Length	Face Width	Handle Length	Replacement Handle	Weight with Handle Lbs.	Industrial Black Head Finish	Std. Pkg. Qty.	Head Weight
						Part No.		
4 lbs.	5¼	1 ¹ / ₁₆	32	HH418	4.3	S844SH	5	4 lbs.
6 lbs.	6	2 ¹ / ₁₆	32	HH6810	7.1	S846H	5	6 lbs.
8 lbs.	6½	2¼	32	HH6810	9.1	S848H	5	8 lbs.
10 lbs.	7	2½	32	HH6810	11.1	S8410H	5	10 lbs.
12 lbs.	7½	2¾	34	HH1216	13.2	S8412H	5	12 lbs.
16 lbs.	8¼	2¾	34	HH1216	17.2	S8416H	4	16 lbs.

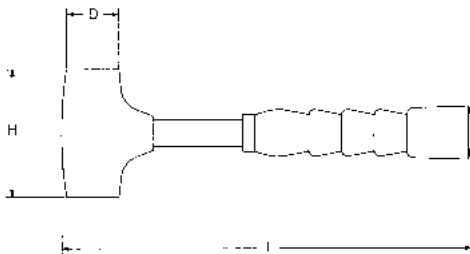

Surface protective, non-marring and non-sparking brass head provides a lot of driving power in a compact hammer. Standard Super Grip (SG) requires less "squeeze" when swinging heavy hammer, reducing strain and fatigue. Ideal for use with heavy gloves.

Brass Hammers

Part No.	Approx. Head Wt.	Std. Pkg.	Ship. Wt.	D	H	L
HSB15	1.5 lb.	5	2.01 lb.	1/1.25	3.5	12
HSB25	2.5 lb.	2	2.72 lb.	1.25/1.5	3.5	12
HSB4	3.5 lb.	2	3.85 lb.	1.65/1.78	3.7	12



Dead Blow Hammers

Part No.	Approx. Head Wt.	Std. Pkg.	Ship. Wt.	D	H	L
HPD1	1.25 lb.	5	1.85 lb.	1.6/2.1	3.9	11
HPD2	1.5 lb.	5	2.10 lb.	2.05/2.4	4.3	12
HPD3	2.2 lb.	2	2.71 lb.	2.4/2.7	4.7	12
HPD4	2.9 lb.	2	3.50 lb.	2.75/3.1	5	13



Shot loaded head produces the most complete dead blow effect (no rebound) ever offered for 30% more striking force than conventional hammers. Fiberglass handle and pliable Standard Super Grip combine with the dead blow effect to reduce effort, strain, vibration and noise.

TOOLS

Hammers

Only *Martin* Provides This Added Warranty —
If a Hammer Head Should Loosen at Any Time, Return
It for Handle Replacement or a New Hammer.

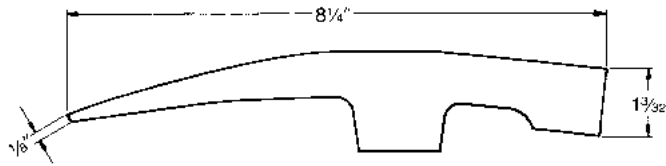

WARNING: Always wear Safety Goggles.

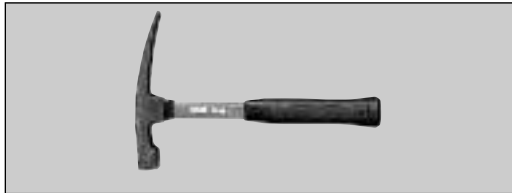

Brick Hammer						
Head Weight	Overall Length	Replacement Handle Kit	Weight with Handle Lbs.	Industrial Black Head Finish	Std. Pkg. Qty.	Head Weight
				Part No.		
1½ lbs.	11	HH173FG	2.0	173	6	1½ lb.

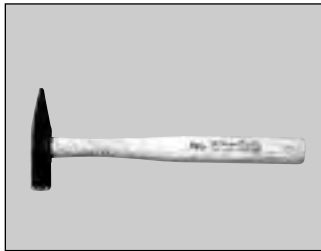
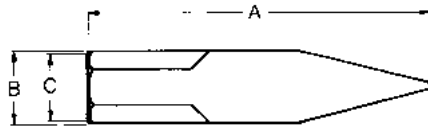

Tinner's Riveting Hammer									
Head Weight	Overall Length	Head Length	Head Width	Face Width	Replacement Handle	Weight with Handle Lbs.	Industrial Black Head Finish	Std. Pkg. Qty.	Head Weight
		A	B	C			Part No.		
4 oz.	9¼	3 ¹ / ₁₆	⁹ / ₁₆	¹⁵ / ₃₂	HH50	.38	25G	6	4 oz.
8 oz.	11	4¼	³ / ₄	²¹ / ₃₂	HH53	.76	26G	6	8 oz.
12 oz.	13½	4¾	²⁹ / ₃₂	²⁵ / ₃₂	HH801	1.1	27G	6	12 oz.
1 lb.	14	5½	³¹ / ₃₂	²⁷ / ₃₂	HH801	1.4	28G	6	1 lb.



Hickory Hammer Handles			
Part Number	Std. Pkg. Qty.	Approx. Length	Use For
HH42A18	12	18	165 Body Hammer
HH42B	12	12	All Body Hammers (Except 165 & 155)
HH45	12	16	Cross Peen and Double Face Eng. and 155
HH49	12	9¼	2 oz. Ball Peen
HH50	12	10	4 oz. Ball Peen/4 oz. Riveting
HH53	12	12	8 oz. Ball Peen/8 oz. Riveting
HH56	12	13½	12 oz. Ball Peen
HH59	12	14½	1 lb., 1½ lb. Ball Peen
HH66	12	16	1½, 2 lb. Ball Peen
HH69	12	17	2½ lb. Ball Peen
HH71	12	17	3 lb. Ball Peen
HH92	12	10½	All Hand Drilling
HH801	12	13¾	12 & 16 oz. Riveting and Settling
HH418	12	32	4 lb. Sledge
HH6810	12	33	6, 8 & 10 lb. Sledge
HH1216	12	35	12 & 16 lb. Sledge



Fiberglass Replacement Handle Kits			
Part Number	Std. Pkg. Qty.	Approx. Length	Use For
HH105106FG	1	13	1 lb. and 1¼ lb. Ball Peen — G Series
HH107FG	1	14	1½ lb. Ball Peen — G Series
HH108FG	1	16	2 lbs. Ball Peen — G Series
HH109110FG	1	16	2½ lb. and 3 lb. Ball Peen — G Series
HH173FG	1	12½	1½ lbs. Brick Hammer
HHBFFG	1	12	All Body Hammers with 12" Handle

TOOLS

Ergonomically & Accurately Sized Cellulose Acetate Handles.

Rugged, Impact and Chemical Resistant.

Color Coded Inlays for Easy Identification.

Forged Nickel-Chrome Molybdenum Alloy Blades.

Serrated Faces to Resist Slipping.

Bright Zinc Plate to Resist Corrosion.

All drivers meet or exceed ANSI/ASME standards and specifications for hardness and torque.

WARNING: Acetate handles are not intended to act as insulation. Never use screwdrivers as prybars or chisels.

 NARROW TIP, ROUND SHANK	Cabinet and Electrical Screwdrivers					
	Blade Length	Blade Width	Type	Wt. Ea. Lbs.	Part No.	Std. Pkg. Qty.
	4	$\frac{3}{16}$	Cabinet	.14	SDE4-1	6
	6	$\frac{3}{16}$	Electrical	.15	SDE6-1	6
	8	$\frac{3}{16}$	Electrical	.16	SDE8-1	6

 WIDENED TIP, ROUND SHANK	Mechanic's and Heavy Duty Screwdrivers					
	Blade Length	Blade Width	Type	Wt. Ea. Lbs.	Part No.	Std. Pkg. Qty.
	4	$\frac{1}{4}$	Mechanic's	.20	SDR4-1	6
	6	$\frac{5}{16}$	Heavy Duty	.30	SDR6-1	6
	8	$\frac{3}{8}$	Heavy Duty	.49	SDR8-1	6

 PRECISION HEAD, ROUND SHANK	Phillips Screwdrivers					
	Blade Length	Phillips Size	Type	Wt. Ea. Lbs.	Part No.	Std. Pkg. Qty.
	3	No. 1	Phillips	.13	SDP3-1	6
	4	No. 2	Phillips	.20	SDP4-1	6
	6	No. 3	Phillips	.30	SDP6-1	6

 STURDY TIP, SQUARE SHANK	Square-Blade Screwdrivers					
	Blade Length	Blade Width	Type	Wt. Ea. Lbs.	Part No.	Std. Pkg. Qty.
	4	$\frac{1}{4}$	Square	.21	SDS4-1	6
	6	$\frac{5}{16}$	Square	.34	SDS6-1	6
	8	$\frac{3}{8}$	Square	.55	SDS8-1	6
	10	$\frac{3}{8}$	Square	.62	SDS10-1	6
	12	$\frac{3}{8}$	Square	.70	SDS12-1	6

 TIGHT CLEARANCE, STURDY	Stubby Screwdrivers					
	Blade Length	Width/ Size	Type	Wt. Ea. Lbs.	Part No.	Std. Pkg. Qty.
	1½	$\frac{1}{4}$	Stubby	.10	SDS1-1	6
	1½	No. 2	Phillips Stubby	.10	SDP1-1	6

Screwdriver Sets

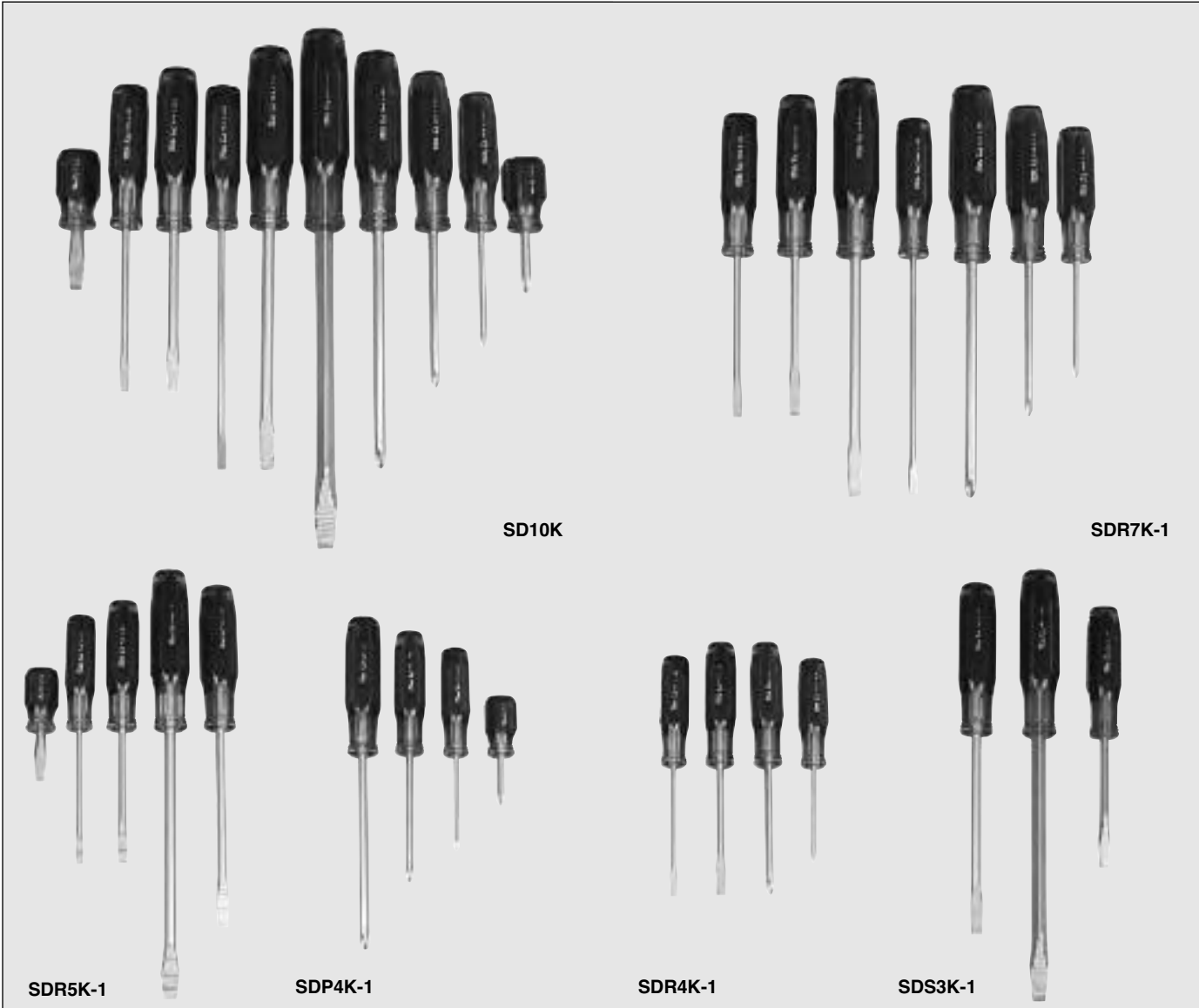

SD10K

SDR7K-1

SDR5K-1

SDP4K-1

SDR4K-1

SDS3K-1

TOOLS

SDR4K - 14pc Screwdriver Combo Set

SDR4-1	Mechanics, 4"	1/4 Rd-C x 4"
SDE4-1	Electrical, 4"	3/16 Rd-C x 4"
SDP3-1	#1 Phillips, 3"	P1 x 3"
SDP4-1	#2 Phillips, 4"	P2 x 4"
P396	Pouch	

SDR5K - 15pc Screwdriver Combo Set

SDR4-1	Mechanics, 4"	1/4 Rd-C x 4"
SDE4-1	Electrical, 4"	3/16 Rd-C x 4"
SDR6-1	Mechanics, 6"	5/16 Rd-C x 6"
SDR8-1	Mechanics, 8"	3/8 Rd-K x 8"
SDS1-1	Mechanics, 1-1/2"	1/4 Sq-K x 1.5"
P696	Pouch	

SDR7K - 17pc Screwdriver Combo Set

SDE4-1	Electrical, 4"	3/16 Rd-C x 4"
SDE6-1	Electrical, 6"	3/16 Rd-C x 6"
SDP3-1	#1 Phillips, 3"	P1 x 3"
SDP4-1	#2 Phillips, 4"	P2 x 4"
SDP6-1	#3 Phillips, 6"	P3 x 6"
SDR4-1	Mechanics, 4"	1/4 Rd-C x 4"
SDR6-1	Mechanics, 6"	5/16 Rd-C x 6"
P496	Pouch	

SDS3K - 1 HD Screwdriver Set

SDS4-1	SQ-Blade, 4"	1/4 Sq x 4"
SDS6-1	SQ-Blade, 6"	5/16 Sq x 6"
SDS8-1	SQ-Blade, 8"	3/8 Sq x 8"
P296	Pouch	

SD10K - 10pc Screwdriver Combo Set

SDE4-1	Electrical, 4"	3/16 Rd-C x 4"
SDE6-1	Electrical, 6"	3/16 Rd-C x 6"
SDR4-1	Mechanics, 4"	1/4 Rd-C x 4"
SDR6-1	Mechanics, 6"	5/16 Rd-C x 6"
SDS1-1	Mechanics, 1-1/2"	1/4 Sq-K x 1.5"
SDS8-1	SQ-Blade, 8"	3/8 Sq-K x 8"
SDP1-1	#2 Phillips, 1-1/2"	P2 x 1.5"
SDP3-1	#1 Phillips, 3"	P1 x 3"
SDP4-1	#2 Phillips, 4"	P2 x 4"
SDP6-1	#3 Phillips, 6"	P3 x 6"

SDP4K - 14pc Phillips Set

SDP1-1	#2 Phillips, 1-1/2"	P2 x 1.5"
SDP3-1	#1 Phillips, 3"	P1 x 3"
SDP4-1	#2 Phillips, 4"	P2 x 4"
SDP6-1	#3 Phillips, 6"	P3 x 6"
P396	Pouch	



Heavy-Duty Gasket Scrapers Chisel and Punch Sets



Martin's patented two composite ergonomically designed handle provides maximum comfort and secure grip. Capped end in direct contact with the shaft allows the user to strike the tool without handle damage. Blade extends throughout the handle. Hardened and tempered the entire length for maximum durability

Set contains 1/2" x 10"; 3/4" x 10"; 1" x 10"; 1-1/2" x 10".

- Cleaning gasket material, adhesives and all general scraping in automotive and engineering applications.
- Used for scraping carbon from cylinder heads, pistons and other metal surfaces.

GS4K	Gasket Scraper Set 4 Pc. Heavy Duty Gasket Scraper Set		Wt. 2.5 lb.
GS50	1/2" x 10" Long Gasket Scraper	<ul style="list-style-type: none"> • USA Alloy Steel • Heavy Duty 3/88 Shank 	
GS75	3/4" x 10" Long Gasket Scraper		
GS100	1" x 10" Long Gasket Scraper		
GS150	1-1/2" x 10" Long Gasket Scraper		

Part No.		Size	Weight	Std. Pkg. Qty.
GS50		1/2" x 10"	.57	6
GS75		3/4" x 10"	.57	6
GS100		1" x 10"	.58	6
GS150		1-1/2" x 10"	.59	6

Chisel Sets



	CC6K	6 PIECES
C8.....	1/4" Cold Chisel	
C10.....	5/16" Cold Chisel	
C12.....	3/8" Cold Chisel	
C16.....	1/2" Cold Chisel	
C20.....	5/8" Cold Chisel	
C24.....	3/4" Cold Chisel	
C66.....	KIT BAG	

**WARNING: Never use hammers with "mush-roomed" heads. They may chip and cause injury.
"ALWAYS WEAR SAFETY GOGGLES"**

Punch Sets



	PP7K	7 PIECES
P2.....	1/16" Pin Punch	
P3.....	3/32" Pin Punch	
P4.....	1/8" Pin Punch	
P5.....	5/32" Pin Punch	
P6.....	3/16" Pin Punch	
P8.....	1/4" Pin Punch	
P10.....	5/16" Pin Punch	
C70.....	KIT BAG	



	LP7K	7 PIECES
P23.....	3/32" Lg. Taper	
P24.....	1/8" Lg. Taper	
P25.....	5/32" Lg. Taper	
P26.....	3/16" Lg. Taper	
P26A.....	7/32" Lg. Taper	
P27.....	1/4" Lg. Taper	
P28.....	5/16" Lg. Taper	
C187.....	KIT BAG	

Combination Chisel & Punch Sets



	PC6K	6 PIECES
C16.....	1/2" Cold Chisel	
C24.....	3/4" Cold Chisel	
P42.....	1/2" Center Punch	
P4.....	1/8" Pin Punch	
P6.....	3/16" Pin Punch	
P16.....	3/16" Solid Punch	
C66.....	KIT BAG	

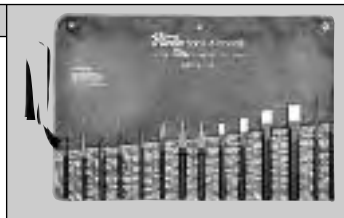

	PC14K	14 PIECES
C42.....	1/4" Cape Chisel	
C16.....	1/2" Cold Chisel	
C20.....	5/8" Cold Chisel	
C24.....	3/4" Cold Chisel	
C28.....	7/8" Cold Chisel	
C60.....	1/4" Diamond Pt. Chisel	
C72.....	1/4" Hlf. Rd. Nose Chisel	
P40.....	3/8" Center Punch	
P24.....	1/8" Drift Punch	
P25.....	5/32" Lg. Taper Punch	
P6.....	3/16" Pin Punch	
P8.....	1/4" Pin Punch	
P14.....	1/8" Solid Punch	
P18.....	1/4" Solid Punch	
C14.....	KIT BAG	

TOOLS

Punches



WARNING: "ALWAYS WEAR SAFETY GOGGLES"

Prick Punch						Center Punch					
Stock Size	Length	Wt. Ea. Lbs.	Industrial Black	Std. Pkg. Qty.		Point Size	Stock Size	Length	Wt. Ea. Lbs.	Industrial Black	Std. Pkg. Qty.
A	B		Part No.			A	B	C		Part No.	
$\frac{3}{8}$	5	.14	P32	12		$\frac{3}{32}$	$\frac{1}{4}$	$3\frac{1}{2}$.06	P38	12
$\frac{1}{2}$	6	.27	P33	12		$\frac{5}{32}$	$\frac{5}{16}$	$4\frac{1}{4}$.08	P39	12
						$\frac{3}{16}$	$\frac{3}{8}$	5	.15	P40	12
						$\frac{1}{4}$	$\frac{1}{2}$	6	.30	P42	12
						$\frac{5}{8}$	$\frac{5}{8}$	$6\frac{1}{4}$.25	P43	6

Pin Punch							Solid Punch						
Point Size	Stock Size	Length	Pin Length	Wt. Ea. Lbs.	Industrial Black	Std. Pkg. Qty.	Point Size	Stock Size	Length	Taper Length	Wt. Ea. Lbs.	Industrial Black	Std. Pkg. Qty.
A	B	C	D		Part No.		A	B	C	D		Part No.	
$\frac{1}{16}$	$\frac{1}{4}$	4	$\frac{3}{4}$.05	P2	12	$\frac{3}{32}$	$\frac{5}{16}$	5	$1\frac{1}{4}$.02	P13	12
$\frac{3}{32}$	$\frac{5}{16}$	$4\frac{1}{2}$	$\frac{7}{8}$.12	P3	12	$\frac{1}{8}$	$\frac{3}{8}$	5	$1\frac{1}{4}$.16	P14	12
$\frac{1}{8}$	$\frac{5}{16}$	$4\frac{3}{4}$	1	.12	P4	12	$\frac{3}{16}$	$\frac{3}{8}$	5	$1\frac{1}{2}$.16	P16	12
$\frac{3}{32}$	$\frac{5}{16}$	5	1	.12	P5	12	$\frac{1}{4}$	$\frac{3}{8}$	6	$1\frac{1}{2}$.16	P18	12
$\frac{3}{16}$	$\frac{3}{8}$	$5\frac{1}{4}$	$1\frac{1}{4}$.17	P6	12	$\frac{5}{16}$	$\frac{1}{2}$	6	2	.31	P19	12
$\frac{7}{32}$	$\frac{3}{8}$	$5\frac{1}{2}$	$1\frac{1}{4}$.18	P7	12							
$\frac{1}{4}$	$\frac{3}{8}$	$5\frac{3}{4}$	$1\frac{1}{4}$.29	P8	12							
$\frac{5}{16}$	$\frac{1}{2}$	6	$1\frac{1}{4}$.33	P10	12							

Long Taper Punch						
Point Size	Stock Size	Length	Taper Length	Wt. Ea. Lbs.	Industrial Black	Std. Pkg. Qty.
A	B	C	D		Part No.	
$\frac{3}{32}$	$\frac{5}{16}$	8	$3\frac{1}{2}$.12	P23	12
$\frac{1}{8}$	$\frac{5}{16}$	8	$3\frac{1}{2}$.16	P24	12
$\frac{3}{32}$	$\frac{3}{8}$	9	$4\frac{1}{4}$.25	P25	12
$\frac{3}{16}$	$\frac{1}{2}$	10	$6\frac{1}{2}$.45	P26	12
$\frac{7}{32}$	$\frac{1}{2}$	10	$6\frac{1}{2}$.45	P26A	12
$\frac{1}{4}$	$\frac{5}{8}$	12	$7\frac{1}{4}$.88	P27	6
$\frac{5}{16}$	$\frac{5}{8}$	12	$7\frac{1}{4}$.94	P28	6
$\frac{1}{4}$	$\frac{3}{4}$	15	$7\frac{1}{4}$	1.66	P28A	6
$\frac{5}{16}$	$\frac{5}{8}$	16	$9\frac{1}{2}$	1.33	P29	6
$\frac{3}{8}$	$\frac{3}{4}$	15	8	1.66	P34	6

TOOLS

WARNING: "ALWAYS WEAR SAFETY GOGGLES"

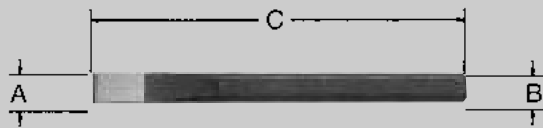
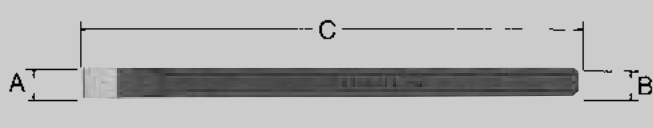
Cold Chisel						Long Cold Chisel					
											
Cut Width	Stock Size	Length	Wt. Ea. Lbs.	Industrial Black	Std. Pkg. Qty.	Cut Width	Stock Size	Length	Wt. Ea. Lbs.	Industrial Black	Std. Pkg. Qty.
A	B	C		Part No.		A	B	C		Part No.	
1/4	1/4	5	.07	C8	12	3/4	5/8	12	1.13	C120	6
5/16	1/4	5	.08	C10	12	5/8	1/2	12	.70	C124	12
3/8	5/16	5 1/2	.13	C12	12	3/4	5/8	18	1.67	C126	3
1/2	7/16	6	.26	C16	12	7/8	3/4	12	1.50	C129	6
5/8	1/2	6 1/2	.37	C20	12	1	3/4	12	1.50	C132	6
3/4	5/8	7	.62	C24	12	1	3/4	18	2.33	C133	3
7/8	3/4	7 1/2	.93	C28	6						
1	3/4	8	1.34	C32	6						

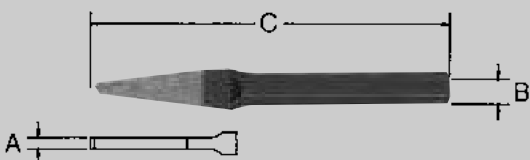
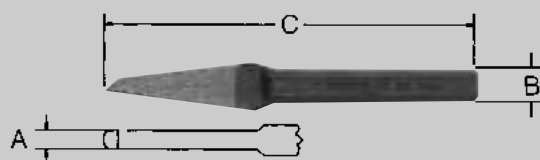
Cape Chisel						Half Round Chisel					
											
Point Size	Stock Size	Length	Wt. Ea. Lbs.	Industrial Black	Std. Pkg. Qty.	Point Size	Stock Size	Length	Wt. Ea. Lbs.	Industrial Black	Std. Pkg. Qty.
A	B	C		Part No.		A	B	C		Part No.	
1/8	5/16	5 1/2	.10	C39	12	3/16	5/8	5 1/2	.16	C71	12
3/16	3/8	5 1/2	.16	C40	12	1/4	3/8	5 1/2	.29	C72	12
1/4	3/8	5 1/2	.29	C42	12						

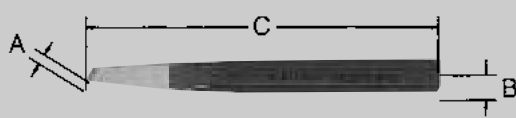
Diamond Point Chisel					
					
Point Size	Stock Size	Length	Wt. Ea. Lbs.	Industrial Black	Std. Pkg. Qty.
A	B	C		Part No.	
1/8	5/16	5	.10	C58	12
3/16	3/8	5 1/2	.18	C59	12
1/4	3/8	5 3/4	.18	C60	12
3/8	5/8	7	.58	C62	6

TOOLS

Pliers – Plastic Grip



Lineman's Plier

Overall Length	Jaw Length	Jaw Width	Jaw Thickness	Wt. Ea. Lbs.	Part No.	Std. Pkg. Qty.
A	B	C	D			
7	1¼	¾	½	.44	P307	6
8½	1¼	1⅛	¾	.91	P308	6

In addition to lineman's work, this tool is great for various wiring and electrical equipment installation and maintenance.

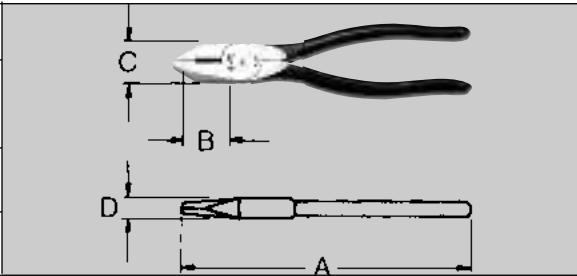

New England Pattern Lineman's Plier

Overall Length	Jaw Length	Jaw Width	Jaw Thickness	Wt. Ea. Lbs.	Part No.	Std. Pkg. Qty.
A	B	C	D			
9¼	1¼	1¼	⅞	1.0	P309	6

Heavy duty for cutting #8 and other large wires. Jaws are designed for increased leverage and has built-in insulation crusher.

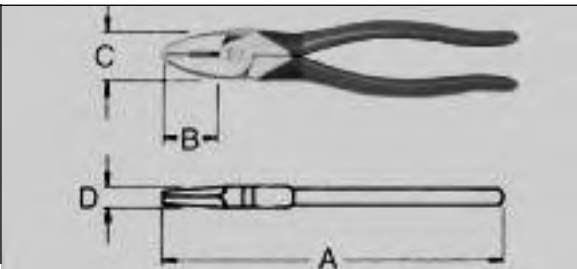

Diagonal Cutting Plier

Overall Length	Jaw Length	Jaw Width	Jaw Thickness	Wt. Ea. Lbs.	Part No.	Std. Pkg. Qty.
A	B	C	D			
6	⅜	⅜	⅜	.28	P206	6
7	1⅛	⅞	½	.53	P2075	6

Great for general purpose electrical and electronic work in confined areas.

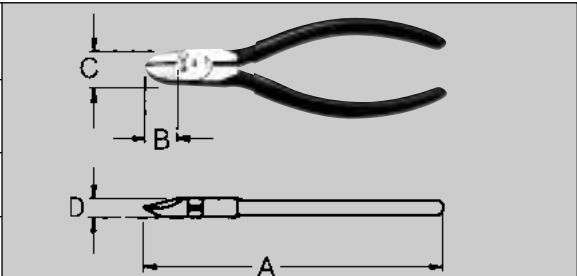

Long Chain Nose Side Cutting Pliers

Overall Length	Jaw Length	Jaw Width	Jaw Thickness	Wt. Ea. Lbs.	Part No.	Std. Pkg. Qty.
A	B	C	D			
6½	1 ²⁵ / ₃₂	⅜	1 ¹ / ₃₂	.28	P506	6
8	2¼	¾	¾	.34	P507	6

Long nose and sharp cutters are ideal for many electrical and electronic applications.

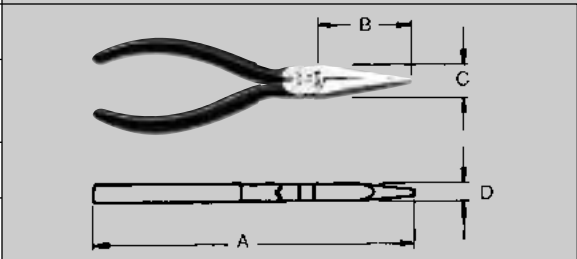

Tongue and Groove Pliers

Overall Length	Jaw Length	Jaw Width	Jaw Thickness	Wt. Ea. Lbs.	Part No.	Std. Pkg. Qty.
A	B	C	D			
7	1 ¹⁷ / ₃₂	1¼	¾	.48	P407	6
9½	1 ¹⁵ / ₁₆	1⅞	¾	.91	P510	6
13	1 ²⁵ / ₃₂	2¼	½	1.49	P71275	6

Precision crafted for balance, taking strain off bolt. Hardened and tempered for long industrial service life.

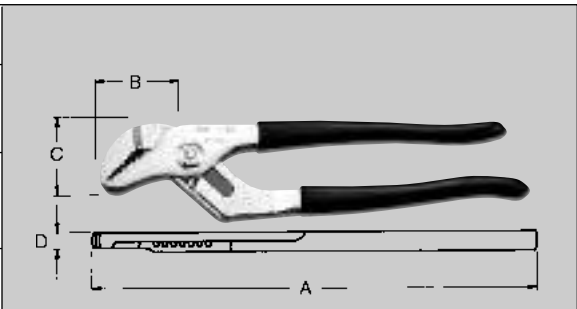

Combination Slip Joint Pliers

Overall Length	Jaw Length	Jaw Width	Jaw Thickness	Wt. Ea. Lbs.	Part No.	Std. Pkg. Qty.
A	B	C	D			
6¼	1 ¹⁵ / ₁₆	1¼	¾	.42	P2065	6
8	1⅞	1 ¹¹ / ₃₂	¾	.53	P208	6
10	2 ⁵ / ₃₂	1⅞	¾	.87	P210	6

Two Slip-joint adjustments, the most basic plier for general use.

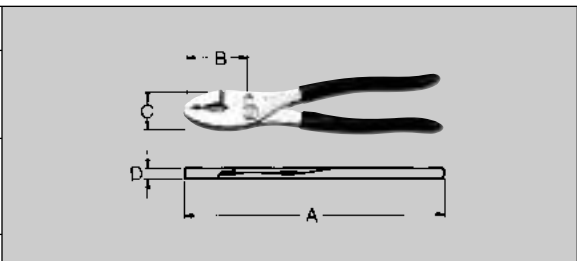



PL3K
3 Pc. General Purpose Pliers Set

P506	6½" Long Chain Nose Side Cutting
P2065	6¾" Combination Slip Joint
P510	9½" Tongue and Groove
P1796	Pouch



PL4K
4 Pc. General Purpose Pliers Set

P507	8" Long Chain Nose Side Cutting
P510	9½" Tongue and Groove
P208	8" Combination Slip Joint
P2075	7" Diagonal Cutting
P1996	Pouch



PL3KSJ
3 Pc. Combination Slip-Joint Pliers Set

P2065	6¾" Combination Slip Joint
P208	8" Combination Slip Joint
P210	10" Combination Slip Joint
P1896	Pouch



PL3KTG
3 Pc. Tongue and Groove Pliers Set

P407	7" Tongue and Groove
P510	9½" Tongue and Groove
P71275	13" Tongue and Groove
P2096	Pouch

Retaining Ring Pliers



One Tool Does it All!

Martin's patented retaining ring pliers are capable of servicing both and external retaining rings. *Martin's* pliers offer superior performance with unique features:

- Flexible internal and external design for quick and easy conversion, as well as unequalled performance.
- Precision broached pliers jaws (patented) providing greater accuracy, stability, and control of retaining rings by tip angle adjustability and positive tip alignment.
- A complete set of replaceable tips held in place with alloy steel set screws provides for each Martin plier to be used for a wide variety of ring sizes & locations.

These unique features and the superior performance of *Martin's* pliers have made them the standard excellence for retaining ring service tools.

Snap Ring Pliers

Part Number	Description	Internal	External	Weight Ea. Lbs.	Std. Pkg. Qty.
P1421	Quick Switch Retaining Ring Pliers - Includes 5 pairs of color-coded interchangeable tips and Allen wrench in handy pouch. Tip sizes: Straight- .023", .036", .047" (0.6mm, 0.9mm, 1.2mm) Bent 90° - .036", .047" (0.9mm, 1.2mm)	1/4" - 1" 7mm - 26mm	1/8" - 1" 3mm - 26mm	0.3	6
P1434	Quick Switch Retaining Ring Pliers - Includes 5 pairs of color-coded interchangeable tips and Allen wrench in handy pouch. Tip sizes: Straight- .036", .047", .070" (0.9mm, 1.2mm, 1.8mm) Bent 90° - .036", .047" (0.9mm, 1.2mm)	3/8" - 2" 10mm - 51mm	1/4" - 2" 7mm - 51mm	0.6	6
P75	Retaining Ring Pliers - Includes 6 pairs of color-coded interchangeable tips and Allen wrench in handy pouch. Tip sizes: Bent 15° - .090", .108", .120" (2.3mm, 2.7mm, 3.0mm) Bent 90° - .090", .108", .120" (2.3mm, 2.7mm, 3.0mm).	1 1/16" - 4" 46mm - 102mm	1 1/2" - 4" 32mm - 102mm	1.18	6
P87	Retaining Ring Pliers - Includes 6 pairs of color-coded interchangeable tips and Allen wrench in handy pouch. Tip sizes: Bent 20° - .120", .150", .180" (3.0mm, 3.8mm, 4.6mm) Bent 90° - .120", .150", .180" (3.0mm, 2.8mm, 4.6mm).	3/8" - 7" 90mm - 175mm	3/8" - 7" 90mm - 175mm	3.05	6



Snap Ring Plier Sets

PL1450K	2 Piece Snap Ring Plier Set w/ Molded Foam Tray Includes P1421 & P1434	0.0	1
PL1465K	3 Piece Snap Ring Plier Set w/ Plastic Box Includes P1421, P1434 & P75	0.0	1

Tip Kits

Part No.	Description	Wt. Ea. Lbs.	Std. Pkg. Qty.
P12K	Tip Kit for P1221 & P1421		
P14K	Tip Kit for P1234 & PP1434		
P651590K	Tip Kit for P65 & P75		
P8720K	Tip Kit 20° for P87		
P8790K	Tip Kit 90° for P87		

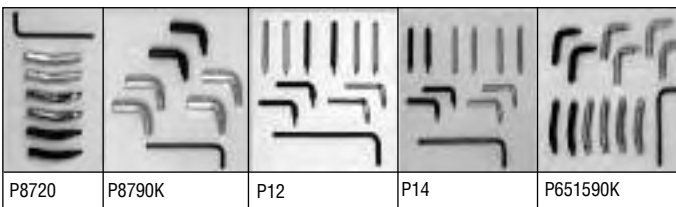

Broached Crank Handles

Square Broached Openings, with Counterbore in Free End of Hub. Special Bends, Offsets, and Broached Openings Also Available.

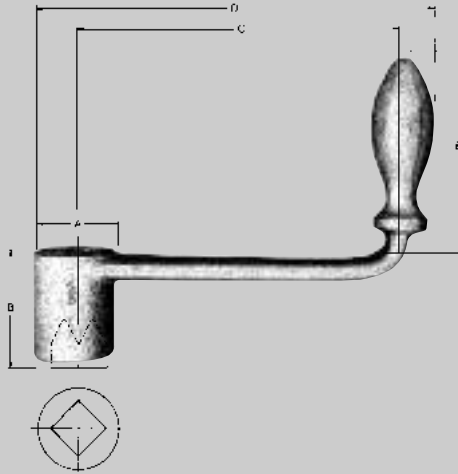

Stock Square Bore	Hub		Length		Height Handle Above Arm	Wt. Ea. Lbs.	Natural Finish	Std. Pkg. Qty.
	Dia.	Length	Center Hub to Center Handle	Overall				
	A	B	C	D	E	Part No.		
1/2	1	1 1/2	1 3/4	2 5/8	2 3/4	.46	CH00B	1
1/2	1	1 1/4	2 1/2	3 3/8	2 1/2	.53	CH0B	1
9/16	1 1/4	1 1/2	3	4	2 3/4	.83	CH1B	1
1/2	1 1/8	1 5/8	3 1/2	4 1/2	2 7/8	.74	CH2B	1
9/16	1 1/4	1 3/8	4	5 1/8	3 1/8	1.0	CH4B	1
5/8	1 1/4	1 13/16	5	6 1/8	3 1/8	1.3	CH6B	1
1 1/16	1 1/4	1 15/16	6	7 1/8	3 3/8	1.4	CH8B	1
3/4	1 3/8	2 1/16	7	8 1/4	3 3/8	1.6	CH10B	1
7/8	1 1/8	2 1/16	8	9 3/8	3 3/8	2.3	CH12B	1
7/8	1 1/2	2 1/2	9 1/8	10 1/2	3 3/4	2.7	CH14B	1
1	1 3/4	3	10	11 1/2	4	3.6	CH16B	1

Unfinished Crank Handles

Unfinished Cranks are Plain Forgings Without a Hole in the Hub.

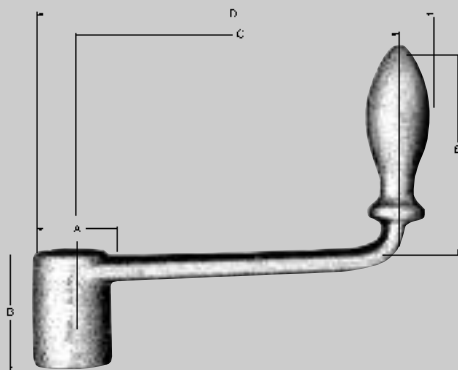

Max Square Bore	Hub		Length		Height Handle Above Arm	Wt. Ea. Lbs.	Natural Finish	Std. Pkg. Qty.
	Dia.	Length	Center Hub to Center Handle	Overall				
	A	B	C	D	E	Part No.		
5/8	1	1 1/2	1 3/4	2 5/8	2 3/4	.46	CH00U	1
5/8	1	1 1/4	2 1/2	3 3/8	2 1/2	.53	CH0U	1
13/16	1 1/4	1 1/2	3	4	2 3/4	.83	CH1U	1
5/8	1 1/8	1 5/8	3 1/2	4 1/2	2 7/8	.74	CH2U	1
13/16	1 1/4	1 3/8	4	5 1/8	3 1/8	1.0	CH4U	1
13/16	1 1/4	1 13/16	5	6 1/8	3 1/8	1.3	CH6U	1
13/16	1 1/4	1 15/16	6	7 1/8	3 3/8	1.4	CH8U	1
7/8	1 3/8	2 1/16	7	8 1/4	3 3/8	1.6	CH10U	1
1	1 1/8	2 1/16	8	9 3/8	3 3/8	2.3	CH12U	1
1	1 1/2	2 1/2	9 1/8	10 1/2	3 3/4	2.7	CH14U	1
1 1/8	1 3/4	3	10	11 1/2	4	3.6	CH16U	1

C-Clamps Eye Bolts Pry Bars



Extra Deep Throat, Copper Plated Fatigue Proof Spindles, Permanent Type Pads.

Inch Capacity	Throat Depth	Spindle Diameter	Minimum Proof Test	Weight Each-Lbs.	Part Number	Std. Pkg. Qty.
0-2	2	1/2	3500 lbs.	1.4	CC402	1
0-3	2 3/8	1/2	3500 lbs.	2.2	CC403	1
0-4	2 3/4	3/4	6500 lbs.	3.4	CC404	1
0-6	3 3/8	3/4	6900 lbs.	5.0	CC406	1
0-8	4 1/2	3/4	6900 lbs.	7.8	CC408	1
0-10	5 3/8	3/4	8000 lbs.	11.0	CC410	1
0-12	5 3/4	7/8	9500 lbs.	15.8	CC412	1



Shot Blasted Finish Meets ANSI B18.15-1985

A	Threads/Inch	B	Eye		*Rated Capacity	Weight Each-Lbs.	Part Number	Std. Pkg. Qty.
			C	D				
1/4	20	1	3/4	1 1/8	500	.06	EB1	1
5/16	18	1 1/8	7/8	1 1/8	900	.10	EB2	1
3/8	16	1 1/4	1	1 11/16	1300	.15	EB3	1
7/16	14	1 3/8	1 1/16	1 3/8	1800	.21	EB4	1
1/2	13	1 1/2	1 1/8	2 1/8	2400	.30	EB5	1
5/8	12	1 3/4	1 1/4	2 1/4	3000	.55	EB6	1
3/4	11	2	1 3/8	2 3/8	4000	.61	EB7	1
7/8	10	2 1/8	1 1/2	2 3/4	5000	.98	EB8	1
1	9	2 3/4	1 3/4	3 1/8	7000	1.53	EB9	1
1 1/8	8	3 1/8	2 1/4	4 1/8	9000	2.06	EB10	1
1 1/4	7	3 1/2	2 3/4	5 1/8	12000	2.90	EB11	1
1 1/2	6	4 1/8	3 1/2	6 1/8	15000	4.11	EB12	1
1 3/4	5	5 1/8	4 1/2	7 1/8	21000	6.73	EB14	1

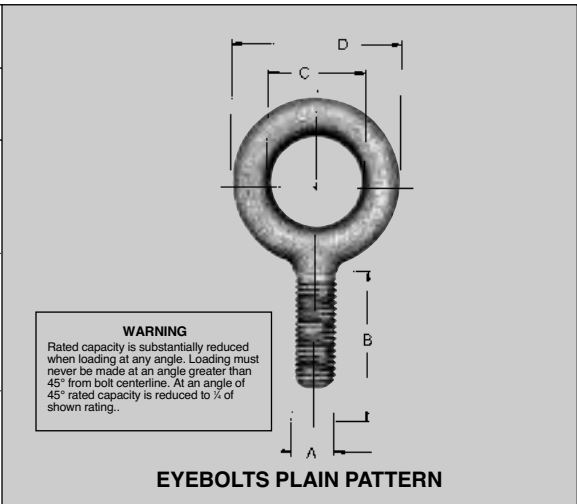

Shot Blasted Finish Meets ANSI B18.15-1985

A	Threads/Inch	B	Eye		E	*Rated Cpty.-Lbs.	Weight Each-Lbs.	Part Number	Std. Pkg. Qty.
			C	D					
1/4	20	1	3/4	1 1/8	1 1/16	500	.06	EB21	1
5/16	18	1 1/8	7/8	1 1/8	7/8	900	.11	EB22	1
3/8	16	1 1/4	1	1 11/16	1 1/8	1300	.18	EB23	1
7/16	14	1 3/8	1 1/16	1 3/8	1 3/8	1800	.23	EB24	1
1/2	13	1 1/2	1 1/8	2 1/8	1 1/8	2400	.35	EB25	1
5/8	12	1 3/4	1 1/4	2 1/4	1 1/2	3000	.47	EB26	1
3/4	11	2	1 3/8	2 3/8	1 13/16	4000	.70	EB27	1
7/8	10	2 1/8	1 1/2	2 3/4	1 7/8	5000	1.10	EB28	1
1	9	2 3/4	1 3/4	3 1/8	2 1/2	7000	1.70	EB29	1
1 1/8	8	3 1/8	2 1/4	4 1/8	2 3/4	9000	2.36	EB30	1
1 1/4	7	3 1/2	2 3/4	5 1/8	2 7/8	12000	3.41	EB31	1
1 1/2	6	4 1/8	3 1/2	6 1/8	3 1/4	15000	4.68	EB32	1
1 3/4	5	5 1/8	4 1/2	7 1/8	3 3/4	21000	7.77	EB34	1

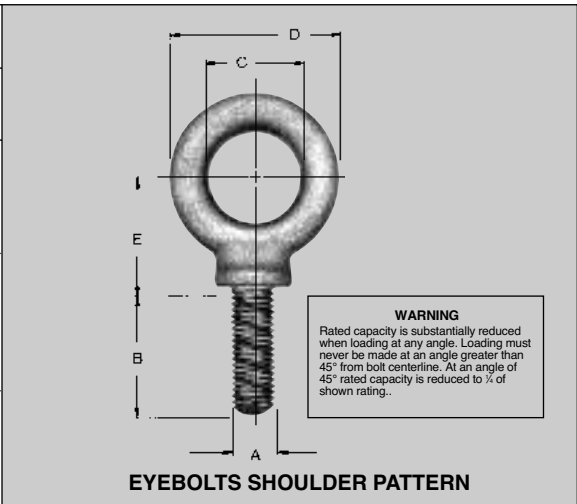

Pinch or Pry Bar

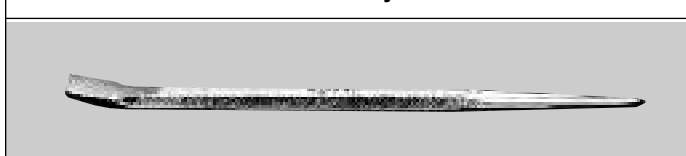

Die Bar — Pry Bar



Size	Length	Wt. Ea. Lbs.	Bright Zinc	Industrial Black	Std. Pkg. Qty.	Size	Length	Wt. Ea. Lbs.	Chrome	Industrial Black	Std. Pkg. Qty.
			Part No.	Part No.					Part No.	Part No.	
5/8	16	1.3	196C	196	1	1/2	12	.70	192C	192	1
3/4	24	3.0	197C	197	1	1/2	15	.87	193C	193	1
7/8	30	5.25	198C	198	1	3/8	18	1.6	194C	194	1

J-96 **WARNING: Never substitute a pry bar with a screwdriver. "ALWAYS WEAR SAFETY GOGGLES"**

Body Hammers

Only *Martin* Provides This Added Warranty —
If a Hammer Head Should Loosen at Any Time, Return
It for Handle Replacement or a New Hammer.

Type	Image	Description	Body Hammers Part No.		Std. Pkg. Qty.
			Wood Handles	Fiberglass Handles	
DINGING HAMMER		For fender and high-crowned panel dinging or bumping. Both high and low-crown faces for "on or off dolly" work. Faces, 1¼" and 1½". Round heads, 6" overall. Weight 1.04 lbs.	150G	150FG	6
DINGING HAMMER		For light dinging and long reach. Square face permits dinging close to moulding or beading. Faces, 1¼" round, 1½" square head 6" overall. Weight .85 lbs.	151G	—	6
HIGH CROWN CROSS PEEN HAMMER		Two high-crowned faces for concave surfaces on doors, rear quarter panels, fenders and hoods. Faces 1½", 6" overall. Weight 1.02 lbs.	152G	—	6
CROSS CHISEL HAMMER		Excellent for finishing. Cross peen used for working in sharp corners around mouldings and for caulking. Round face — 1⅞" diameter. Chisel — 3" long. Weight .87 lbs.	153G	153FG	6
CURVED CROSS CHISEL HAMMER		Excellent for finishing. Cross peen used for working in sharp corners around mouldings and for caulking. Well balanced curved chisel for work in close places. Round face — 1⅞" diameter. Chisel — 3" long. Weight .85 lbs.	153GB	153FGB	6
CROSS CHISEL SHRINKING HAMMER		Cross grooved. Extra wide faces are cross grooved and used for shrinkage on large surfaces — chisel end used on sharp corners. Flat round face — 1⅞" diameter. Chisel — 3" long. Weight .87 lbs.	153S	—	6
VERTICAL CHISEL HAMMER		Excellent for finishing. Cross peen used for working in sharp corners around mouldings and for caulking. Vertical chisel end used on sharp corners. Round face — 1½" diameter. ⅝" Chisel — 5½" long. Weight .85 lbs.	154G	154FG	6
VERTICAL CHISEL SHRINKING HAMMER		Cross grooved. Extra wide faces are cross grooved and used for shrinkage on large surfaces — vertical chisel end used on sharp corners. Round face — 1½" diameter. Chisel — 5½" long. Weight .87 lbs.	154S	154SFG	6
FENDER BUMPER		For bumping where hand and dolly cannot reach. Ample clearance for obstructions. Also used as a caulking iron. Length of head, 8¾". Weight 2.8 lbs.	155G	155FG	4
PICK HAMMER		Long-reach, thin point for low spot on low-crown panels. Reaches over inner obstructions. One high-crown face. Face, 1¼" round point, ½" radius. Length of pointed end, 5½". Weight .91 lbs.	156G	156FG	6
CURVED PICK HAMMER		Like 156G except pick end is bent in arc of normal blow. Reaches behind reinforcements to difficult spots. Face, 1¼" round point, ½" radius. Length of pointed end, 5½". Weight .86 lbs.	156GB	—	6

TOOLS

Body Hammers









Only *Martin* Provides This Added Warranty —
If a Hammer Head Should Loosen at Any Time, Return
It for Handle Replacement or a New Hammer.

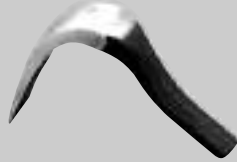



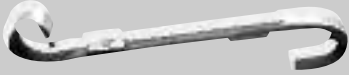

Type		Description	Body Hammers Part No.		Std. Pkg. Qty.
			Wood Handles	Fiberglass Handles	
GENERAL PURPOSE PICK HAMMER		Medium size point and reach for general work. Low crown strawberry point for perfect balance. Face, 1¹/₁₆" round point, 3¹/₃₂" radius. Length of pick end, 3³/₄". Weight .91 lbs.	158G	158FG	6
ROUND POINT FINISHING HAMMER		Blunt point — long reach. For low spots on high crown panels and other work with long reach. Will not pick holes in the metal. Round face — 1¹/₁₆" diameter. Blunt point 3" long. Weight .81 lbs.	158GM	158FGM	6
SHARP POINT FINISHING HAMMER		Sharp point — long reach. For low spots on high crown panels and other work with long reach. Round face — 1¹/₁₆" diameter. Sharp point 3" long. Weight .79 lbs.	158GMS	—	6
HEAVY DUTY BUMPING HAMMER		For heavy gauge truck fenders and panels. Also used in straightening reinforcements, braces, etc. Faces, 1¹/₄" round and 1¹/₁₆" square head, 4" overall. Weight 1.1 lbs.	160G	160FG	6
DINGING HAMMER		Short-reach, lightweight. One low-crown, square face. Lightest dinging hammer in line. Faces, 1¹/₄" round and 1¹/₁₆" square. Head, 4" overall. Weight .83 lbs.	161G	161FG	6
SHRINKING HAMMER		For work in close quarters. Expertly machined serrations on the round face. Plain square face, 1¹/₄" round serrated face, 1¹/₄" diameter. 4" overall. Weight .78 lbs.	162G	162FG	6
UTILITY PICK HAMMER		Blunt point, short reach. For low spots in high-crown panels and other work with small clearance. Face, 1¹/₁₆" round point, 3¹/₃₂" radius. Length of pointed end, 2" head, 4" overall. Weight .75 lbs.	164G	164FG	6
PICK HAMMER		Lightweight. Provides stubby pick point and high-crown peen-type faces. Will ding out small dents in high fins. No need to remove panels. Long reach, 18" handle. Weight 5 oz.	165G	—	6
PICK HAMMER		Lightweight. Provides stubby pick point and high-crown peen-type faces. Will ding out small dents in high fins. No need to remove panels. 12" handle. Weight 4 oz.	166G	—	6
CROSS PEEN FINISHING HAMMER		Used to bump odd fender or bumper contours. Round face — 1¹/₁₆" diameter peen end 3¹/₁₆ x 7¹/₈". 5" overall head length. 12" handle. Weight .91 lbs.	168G	168FG	6
HIGH CROWN CROSS PEEN FINISHING HAMMER		Ideal for forming radiuses, contours and curves-restoration, bike tanks. High Crown face — 1¹/₁₆" diameter. 2¹/₄" radius. Peen end 3¹/₁₆" x 1". 5" overall head length. 12" handle. Weight 1.0 lbs.	168HC	168HCFG	6
LARGE FACE PICK FINISHING HAMMER		For finishing and caulking. Round face — 1¹/₄" diameter. 4¹/₂" overall head length. 13" handle. Weight 1.0 lbs.	169G	169FG	6
DOOR SKIN HAMMER		Rectangular heads fit in door flanges. Bent Head - medium crown - starts door skin fold. Straight head - high crown - for finishing. 7" overall length. Weight .94 lbs.	170G	170FG	6

Type		Description	Part No.	Std. Pkg. Qty.
LIGHT WEIGHT TOE DOLLY		Designed for flat surfaces. All the features of a toe dolly. Sizes 4$\frac{3}{4}$" x 2$\frac{1}{4}$" x $\frac{1}{16}$". Weight 1.8 lbs.	1057	1
TOE DOLLY		Thinness and length provide easy accessibility to narrow pockets. Large, flat face is frequently used in shrinking and dinging flat panels. The flat sides furnish a convenient anvil for repairing flanges. Sizes 4$\frac{3}{4}$" x 2$\frac{3}{8}$" x 1$\frac{1}{8}$". Weight 3.0 lbs.	1058	1
SHRINKING DOLLY (SERRATED)		Shaped like a toe dolly but has one face covered with raised serrations for shrinking metal stretched by dents. Weight 3.4 lbs.	1058S	1
HEEL DOLLY		Design makes it possible to reach easily into sharp corners and wide radii. These features are exclusive to the Heel Dolly and continue its high demand. Sizes 3$\frac{1}{4}$" x 2$\frac{1}{2}$" x 1$\frac{1}{8}$". Weight 2.7 lbs.	1059	1
GENERAL PURPOSE DOLLY		Provides convenient and comfortable hand hold during heaviest blows. Weight, balance and several differently crowned working faces, together with two beading and flange lips, give this dolly broad general use. Sizes 2$\frac{7}{8}$" x 2$\frac{3}{8}$" x 2$\frac{1}{4}$". Weight 3 lbs.	1060	1
UTILITY DOLLY		High-crown dolly with one narrow beading edge. Thick rounded sides are useful in short radii curves. Wide application of uses in high-crown portions of hoods, fenders and body panels. Sizes 3$\frac{3}{8}$" x 3" x 1$\frac{1}{8}$". Weight 2.9 lbs.	1061	1
EGG SHAPED DOLLY		This unique shape with high crown design is a very popular shape, with many different curves and angles. Sizes 1$\frac{5}{8}$" x 2$\frac{1}{2}$" x 3$\frac{3}{4}$". Weight 3.1 lbs.	1064	1
WEDGE DOLLY		Long, slender general purpose dolly. Widely favored by many body repair men for all-around use. The long, thin lip is very useful in working behind reinforcements. Sizes 5$\frac{3}{4}$" x 2$\frac{3}{8}$" x 2$\frac{1}{16}$". Weight 4 lbs.	1067	1
LIGHT WEIGHT WEDGE DOLLY		Short, slender general purpose Dolly. Good hand grip. Also used for beads or flanges on fenders. Thin edge is useful for corners and beading. Flat side works under long curve of fender Size 2$\frac{3}{4}$" x 2$\frac{1}{2}$" x 4$\frac{7}{16}$". Weight 2.7 lbs.	1065	1
"CHAMPION" HEAVYWEIGHT DOLLY		Heavy duty, general purpose fender dolly. A necessity on heavy gauge fenders which resist the blows of lighter dollies. Brings out the toughest damage. Seats comfortably in the hand and protects fingers from a swinging blow. Sizes 3$\frac{3}{8}$" x 3$\frac{3}{8}$" x 2$\frac{1}{16}$". Weight 4.6 lbs.	1070	1
LOW CROWN DOLLY		Specially designed for use on low-crown panels where medium and high-crown dollies would stretch the metal. Angle between the sides and large face is less than 90°, which permits this dolly to reach into the corner of a flanged edge. Size 3$\frac{3}{8}$" x 2$\frac{3}{4}$" x 1$\frac{1}{8}$". Weight 3.3 lbs.	1068	1

Body and Fender Repair Tools

Body Spoons

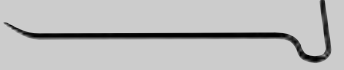
Type		Description	Part No.	Std.
LIGHT DINGING SPOON		To ding ridges smooth and level. When held against ridge and struck with hammer, spreads blow over large area making smooth job and preventing damage to metal or finish. Not made for prying. Length 10" overall. Face 2" x 4⁵/₁₆". Weight .50 lbs.	1036	6
COMBINATION SPOON		General purpose fender spoon. Used as dolly behind brackets, inner panels and similar places. Handle offset to give balance when dinging and for long reach. Has high-crown working surface. Face 1¹/₄" x 5¹/₂". Handle 1" octagon 4³/₄" long. Weight 3.0 lbs.	1050	4
SPOON DOLLY		Long handle permits many uses in places otherwise inaccessible. Can be driven between reinforcements and outer panel, then used to pry outward as the metal is dinged. Excellent forming and caulking tool for the deep pockets of doors, quarter-panels, rear fenders and lower trunk panels. Size 2¹/₂" x 1" x 3". Weight 4.2 lbs.	1052	1
LONG CURVED SPOON		Long, thin, curved blade is handy for prying up dents behind curved reinforcements in header panels, hinge anchors in doors, body pillars and reinforcements in hoods and radiator shells. Length 10¹/₂" overall. Face 2" x 7". Weight 1.5 lbs.	1054	6
WING-DING SPOON DOLLY		The answer to repair problems on high fins. A dolly, a spoon, a pry. Long handle and special contours for working up inside cramped fins. Wide spoon transmits hammer blows over wide area without damaging finish. 1" handle diameter, 19" overall length. Weight 4.5 lbs.	1056	1
HEAVY DUTY DRIVING AND FENDER BENDING TOOL		Useful for restoration of turned under, non-wired flanged edges. Also handy for alignment of inner construction and flanges on alligator hoods. Heavy formed striking pads. Length 14¹/₂". Weight 3.2 lbs.	1091	1
CAULKING IRON		Excellent precision made wire caulking iron. Polished working surfaces are rounded for use on inside moldings. Face 1¹/₄" x 1". Overall length 11". Weight 1.4 lbs.	1096C	6
SURFACING SPOON		Excellent spoon for fender spring hammering, finishing and shaping. Curve gets behind inner construction between panels that are close for removal of dents. Molds panels. Blade fully polished. 9" Blade Length. 2¹/₄" Width. Overall Length 15¹/₈". Weight 2.5 lbs.	1024	1
MEDIUM CROWN SPOON		Long slender shape just like the 1024 surfacing spoon. Inside with medium crown, for high ridges or prying. For slapping and surface finishing on fenders, panels and trunk lids. Blade fully polished. 9" Blade Length. 2¹/₄" Width. Overall Length 14¹/₈". Weight 1.5 lbs.	1026	1
HEAVY DUTY DOUBLE END S-SPOON		General purpose fender and frame spoon. Designed to provide further reach on panels and behind reinforcements. Prying, heavy duty design for use on SUV frames. 12³/₁₆" Length. 1¹/₂" X 5¹/₄" Face. Weight 3.0 lbs.	1044	1

		Description		
MEDIUM CURVED PICK		Medium length. Curved and pointed. Use twisting or prying action. Length 26½" . Weight 2.2 lbs.	1106	1
LONG CURVED PICK		Long length. Curved and pointed. Use twisting or prying action. Length 31" . Weight 2.5 lbs.	1107	1
LONG CHISEL BIT PICK		Heavy duty. Employ twisting action. Chisel bit 1" . Length 20" . Weight 1.9 lbs.	1109	1
SHORT CURVED PICK		Extremely short length. Curved and pointed. Use twisting or prying action. Length 12" . Weight .5 lbs.	1110	1
MEDIUM SHORT CURVED PICK		Short length. Curved and pointed. Use twisting or prying action. Length 18" . Weight .7 lbs.	1111	1
LIGHT CHISEL BIT PICK		Light duty. Employ twisting action. Chisel bit 1½" . Length 16" . Weight .7 lbs.	1112	1

Body and Fender Repair Tools

Miscellaneous Tools

		Description		
ADJUSTABLE AND FLEXIBLE FILE HOLDERS		Permits use of files to 14". Handle adjustable for both right and left hand use for working close to offset or panels. Permit flexing either way to maximum point of safety against breakage. Weight 1.7 lbs.	1150	1
STANDARD 14" BODY FILE		Vixen milled, curved tooth. Plain blade. Flexible, standard cut, 8 tooth. 14" long. Weight .66 lbs.	1158F	5
STRAIGHT SHELL BODY FILE		Vixen milled, curved tooth. Plain blade. Half round shell, 8 tooth. Concave for shallow concave work. 14" long. Weight .66 lbs.	1163F	5
BODY DENT PULLER TOOL		Slide hammer activated. This tool provides a remarkably simple and easy method of removing a dent in a door or panel. Merely punch or drill a hole in the deepest part of the damage and insert a self-threading screw or hook. A few light impacts with the slide hammer will return the metal to original position. Shaft is 1/2" x 13" with locking device to keep screw from turning. Cadmium and black oxide rust-proof finish. Weight 3.9 lbs.	DP38	1
THE KEY TO METAL BUMPING		This book, entitled "The Key to Metal Bumping," is an excellent instruction manual and guide for every body man or student. It provides authoritative reference for techniques and methods for all phases of body and fender work. Its 126 pages cover most approaches to body repair problems. Visual assistance is rendered by more than 100 illustrations. It includes explanations of many time-saving short-cut methods to make the job easier and better. Among other features is a glossary of terms used in the trade. This is the third edition. The first was published in the late thirties and over the years has enjoyed widespread acceptance and usage as a guide and text by many public, private and trade schools. It is a perfect "tool of the trade" for the student and journeyman alike.	BFB	1

TOOLS

Body and Fender Repair Tool Sets

PART NO.	659 K
153G.....	Cross Chisel Straight Hammer
158G.....	General Purpose Pick Hammer
160G.....	Heavy Duty Bumping Hammer
164G.....	Utility Pick Hammer
1058.....	Toe Dolly Block
1059.....	Heel Dolly Block
1060.....	General Purpose Dolly Block
1036.....	Light Dinging Spoon
1150.....	Adjustable File Holder
1158F.....	Body File Standard 14"
BFB.....	Instruction Manual
BX18.....	Tool Box



PART NO.	691 K
153G.....	Cross Chisel Straight Hammer
156G.....	Pick Hammer
158G.....	General Purpose Pick Hammer
160G.....	Heavy Duty Bumping Hammer
161G.....	Dinging Hammer
164G.....	Utility Pick Hammer
1058.....	Toe Dolly Block
1059.....	Heel Dolly Block
1060.....	General Purpose Dolly Block
1036.....	Light Dinging Spoon
1052.....	Spoon Dolly
1050.....	Combination Spoon
1150.....	Adjustable File Holder
1158F.....	Body File Standard 14"
162G.....	Shrinking Hammer
BFB.....	Instruction Manual
BX18.....	Tool Box



PART NO.	692 K
150G.....	Dinging Hammer
153G.....	Cross Chisel Straight Hammer
153GB.....	Cross Chisel Curved Hammer
155G.....	Fender Bumper
156G.....	Pick Hammer
156GB.....	Curved Pick Hammer
158G.....	General Purpose Pick Hammer
160G.....	Heavy Duty Bumping Hammer
161G.....	Dinging Hammer
162G.....	Shrinking Hammer
164G.....	Utility Pick Hammer
168G.....	Cross Peen Finishing Hammer
169G.....	Large Face Pick Finishing Hammer
1036.....	Light Dinging Spoon
1050.....	Combination Spoon
1052.....	Spoon Dolly
1054.....	Long Curved Spoon
1058.....	Toe Dolly Block
1059.....	Heel Dolly Block
1060.....	General Purpose Dolly Block
1061.....	Utility Dolly Block
1068.....	Low Crown Dolly Block
1091.....	Heavy Duty Driving Spoon
1150.....	Adjustable File Holder
1158F.....	Body File Standard 14"
BFB.....	Instruction Manual
BX17.....	Tool Box



Body and Fender Repair Tools Tool Sets



<table border="1"> <thead> <tr> <th>Part No.</th> <th>644K</th> <th>WOOD HANDLES</th> </tr> </thead> <tbody> <tr> <td>158G</td> <td></td> <td>General Purpose Pick Hammer</td> </tr> <tr> <td>153GB</td> <td></td> <td>Cross Chisel Curved Hammer</td> </tr> <tr> <td>1036</td> <td></td> <td>Light Dinging Spoon</td> </tr> <tr> <td>1058</td> <td></td> <td>Toe Dolly Block</td> </tr> </tbody> </table>	Part No.	644K	WOOD HANDLES	158G		General Purpose Pick Hammer	153GB		Cross Chisel Curved Hammer	1036		Light Dinging Spoon	1058		Toe Dolly Block	<p style="text-align: center;">4 TOOLS</p>									
Part No.	644K	WOOD HANDLES																							
158G		General Purpose Pick Hammer																							
153GB		Cross Chisel Curved Hammer																							
1036		Light Dinging Spoon																							
1058		Toe Dolly Block																							
<table border="1"> <thead> <tr> <th>Part No.</th> <th>644KFG</th> <th>FIBERGLASS HANDLES</th> </tr> </thead> <tbody> <tr> <td>158FG</td> <td></td> <td>General Purpose Pick Hammer</td> </tr> <tr> <td>153FGB</td> <td></td> <td>Cross Chisel Curved Hammer</td> </tr> <tr> <td>1036</td> <td></td> <td>Light Dinging Spoon</td> </tr> <tr> <td>1058</td> <td></td> <td>Toe Dolly Block</td> </tr> </tbody> </table>	Part No.	644KFG	FIBERGLASS HANDLES	158FG		General Purpose Pick Hammer	153FGB		Cross Chisel Curved Hammer	1036		Light Dinging Spoon	1058		Toe Dolly Block										
Part No.	644KFG	FIBERGLASS HANDLES																							
158FG		General Purpose Pick Hammer																							
153FGB		Cross Chisel Curved Hammer																							
1036		Light Dinging Spoon																							
1058		Toe Dolly Block																							
<table border="1"> <thead> <tr> <th>Part No.</th> <th>647K</th> <th>WOOD HANDLES</th> </tr> </thead> <tbody> <tr> <td>153GB</td> <td></td> <td>Cross Chisel Curved Hammer</td> </tr> <tr> <td>162G</td> <td></td> <td>Shrinking Hammer</td> </tr> <tr> <td>164G</td> <td></td> <td>Utility Pick Hammer</td> </tr> <tr> <td>1036</td> <td></td> <td>Light Dinging Spoon</td> </tr> <tr> <td>1058</td> <td></td> <td>Toe Dolly Block</td> </tr> <tr> <td>1059</td> <td></td> <td>Heel Dolly Block</td> </tr> <tr> <td>1060</td> <td></td> <td>General Purpose Dolly Block</td> </tr> </tbody> </table>	Part No.	647K	WOOD HANDLES	153GB		Cross Chisel Curved Hammer	162G		Shrinking Hammer	164G		Utility Pick Hammer	1036		Light Dinging Spoon	1058		Toe Dolly Block	1059		Heel Dolly Block	1060		General Purpose Dolly Block	<p style="text-align: center;">7 TOOLS</p>
Part No.	647K	WOOD HANDLES																							
153GB		Cross Chisel Curved Hammer																							
162G		Shrinking Hammer																							
164G		Utility Pick Hammer																							
1036		Light Dinging Spoon																							
1058		Toe Dolly Block																							
1059		Heel Dolly Block																							
1060		General Purpose Dolly Block																							
<table border="1"> <thead> <tr> <th>Part No.</th> <th>647KFG</th> <th>FIBERGLASS HANDLES</th> </tr> </thead> <tbody> <tr> <td>153FGB ...</td> <td></td> <td>Cross Chisel Curved Hammer</td> </tr> <tr> <td>162FG</td> <td></td> <td>Shrinking Hammer</td> </tr> <tr> <td>164FG</td> <td></td> <td>Utility Pick Hammer</td> </tr> <tr> <td>1036</td> <td></td> <td>Light Dinging Spoon</td> </tr> <tr> <td>1058 ..</td> <td></td> <td>Toe Dolly Block</td> </tr> <tr> <td>1059 ..</td> <td></td> <td>Heel Dolly Block</td> </tr> <tr> <td>1060 ..</td> <td></td> <td>General Purpose Dolly Block</td> </tr> </tbody> </table>	Part No.	647KFG	FIBERGLASS HANDLES	153FGB ...		Cross Chisel Curved Hammer	162FG		Shrinking Hammer	164FG		Utility Pick Hammer	1036		Light Dinging Spoon	1058 ..		Toe Dolly Block	1059 ..		Heel Dolly Block	1060 ..		General Purpose Dolly Block	
Part No.	647KFG	FIBERGLASS HANDLES																							
153FGB ...		Cross Chisel Curved Hammer																							
162FG		Shrinking Hammer																							
164FG		Utility Pick Hammer																							
1036		Light Dinging Spoon																							
1058 ..		Toe Dolly Block																							
1059 ..		Heel Dolly Block																							
1060 ..		General Purpose Dolly Block																							
<table border="1"> <thead> <tr> <th>Part No.</th> <th>694K</th> <th>WOOD HANDLES</th> </tr> </thead> <tbody> <tr> <td>158G</td> <td></td> <td>General Purpose Pick Hammer</td> </tr> <tr> <td>153GB</td> <td></td> <td>Cross Chisel Curved Hammer</td> </tr> <tr> <td>164G</td> <td></td> <td>Utility Pick Hammer</td> </tr> <tr> <td>170G</td> <td></td> <td>Door Skin Hammer</td> </tr> </tbody> </table>	Part No.	694K	WOOD HANDLES	158G		General Purpose Pick Hammer	153GB		Cross Chisel Curved Hammer	164G		Utility Pick Hammer	170G		Door Skin Hammer	<p style="text-align: center;">4 TOOLS</p>									
Part No.	694K	WOOD HANDLES																							
158G		General Purpose Pick Hammer																							
153GB		Cross Chisel Curved Hammer																							
164G		Utility Pick Hammer																							
170G		Door Skin Hammer																							
<table border="1"> <thead> <tr> <th>Part No.</th> <th>694KFG</th> <th>FIBERGLASS HANDLES</th> </tr> </thead> <tbody> <tr> <td>158FG</td> <td></td> <td>General Purpose Pick Hammer</td> </tr> <tr> <td>153FGB ...</td> <td></td> <td>Cross Chisel Curved Hammer</td> </tr> <tr> <td>164FG</td> <td></td> <td>Utility Pick Hammer</td> </tr> <tr> <td>170FG</td> <td></td> <td>Door Skin Hammer</td> </tr> </tbody> </table>	Part No.	694KFG	FIBERGLASS HANDLES	158FG		General Purpose Pick Hammer	153FGB ...		Cross Chisel Curved Hammer	164FG		Utility Pick Hammer	170FG		Door Skin Hammer										
Part No.	694KFG	FIBERGLASS HANDLES																							
158FG		General Purpose Pick Hammer																							
153FGB ...		Cross Chisel Curved Hammer																							
164FG		Utility Pick Hammer																							
170FG		Door Skin Hammer																							

TOOLS

SYNCHRONOUS DRIVES

ITEM	PAGE
TIMING PULLEYS	K-2 – K-70
Terminology	K-3 – K-4
XL	K5
L	K-6 – K-10
H	K-11 – K-17
XH	K-18 – K-19
Selection Procedure	K-20 – K-21
Speed Up Drives	K-60
Drive Selection XL.....	K-22 – K-31
Drive Selection L	K-32 – K-43
Drive Selection H	K-44 – K-53
Drive Selection XH	K-54 – K-59
Non-Stock Design	K-61 – K-63
Timing Pulley Info	K-64
HP Ratings	K-65 – K-68
Diameter Tables	K-69 – K-70
HTS® Synchronous Sprockets.....	K-71 – K-168
HTS® Synchronous Sprockets	K-73 – K-84
5mm	K-73
8mm.....	K-74 - K-77
14mm.....	K-78 - K-82
20mm.....	K-83 - K-84
Sprocket Diameter.....	K-85 – K-88
Sprocket Selection	K-89 – K-93
Drive Selection Tables	K-94 – K-149
Belt Horsepower Tables	K-150 – K-162
RPP®.....	K-151 - K-157
RPP® Plus.....	K-158 - K-162
Engineering	K-163 – K-168
MPC™ Synchronous Sprockets.....	K-169
High HP HTS® Synchronous Sprockets.....	K-169 - K-192
8mm	K-170 - K-171
14mm	K-172 - K-173
Drive Selection Tables.....	K-174 - K-187
Belt Horsepower Tables.....	K-188 - K-192

Stock Timing Pulleys



STOCK TIMING PULLEYS

**1/5" - 7/8" PITCH
QD – TAPER BUSHED
AND STOCK BORE**



Stock Bore



Taper Bushed



QD

PITCH IN.	PULLEY DESIGNATION
1/5"	XL (Extra Light)
3/8"	L (Light)
1/2"	H (Heavy)
7/8"	XH (Extra Heavy)

Martin Timing Pulleys are manufactured to extremely close specifications and are stocked in minimum plain bore, Taper Bushed and Q.D. bushed styles depending on size and pitch.

See tables for stock pulley types. Bushings are priced separately and must be added to pulley price.

Illustrations below indicate stock pulley construction type listed in tables.

Type DF

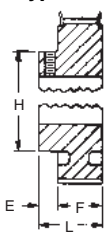

Type D

Type CF

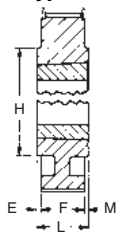

Type C

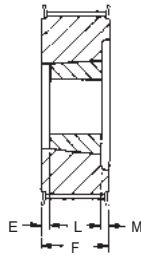

Type KF

Type AF

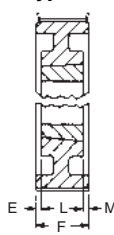

Type A



Type G

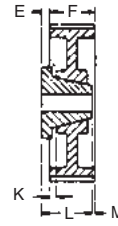

Type H

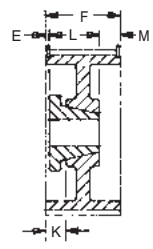

Type J

"F" designation in pulley type means pulley is flanged. When drive center distance is eight times the diameter of the smaller pulley or when drive is operating on vertical shafts, both pulleys should be flanged.

DEFINITION OF CATALOG NUMBERS

EX: TB 20L100

TB — Requires Taper Bushing

20 — Number of Teeth

L — 3/8" Pitch (Light)

100 — Belt Width 1"

EX: 72L100SD

72 — Number of Teeth

L — 3/8" Pitch (Light)

100 — Belt Width 1"

SD — Requires QD Bushing

EX: 16L100

Min. Plain Bore

Pulley Style Designation As Shown in Tables

Dash 1 = Block Body Style

Dash 2 = Web Style

Dash 3 = Arm/Spoke Style

Size XXH (1-1/4" Pitch).

Available as made-to-order.

Call your nearest *Martin* facility.

Pulley sizes shown stocked as stock bore only: max. bore listed is without keyway. If keyway is used reduce max. bore by twice kw depth.

Let us quote your made-to-order and large quantity requirements.

Timing belts and pulleys — in order to handle a wide range of loads, speeds and applications at highest possible efficiencies — are made in five stock pitches. Circular pitch (usually referred to as pitch) is a basic consideration in the selection of timing pulleys as with gear and chain drives. Pitch is the distance between groove centers and is measured on the pulley pitch circle. On the belt, pitch is the distance between tooth centers and is measured on the pitch line of the belt.

The pitch line of the belt is located within the tension member and coincides with the pitch circle of the pulley mating with it. Any timing belt must be run with pulleys of the same pitch. A belt of one pitch cannot be used successfully with pulleys of a different pitch.

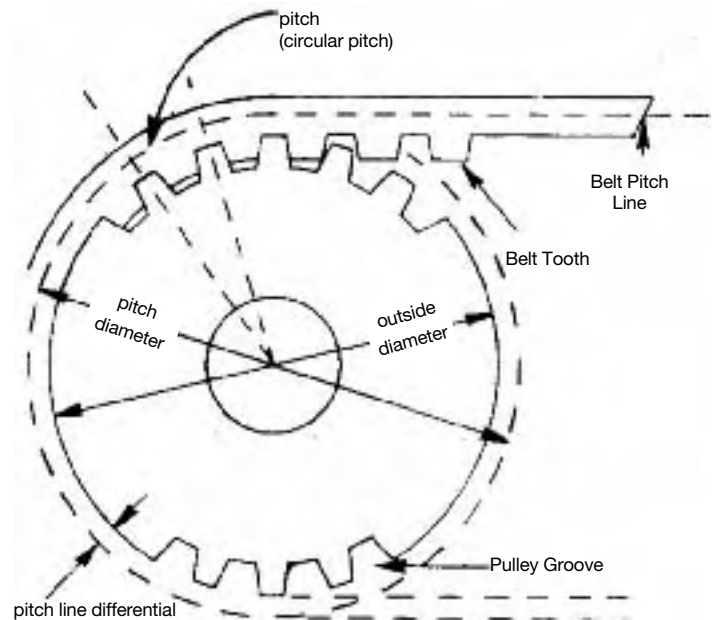

TIMING BELT TERMINOLOGY

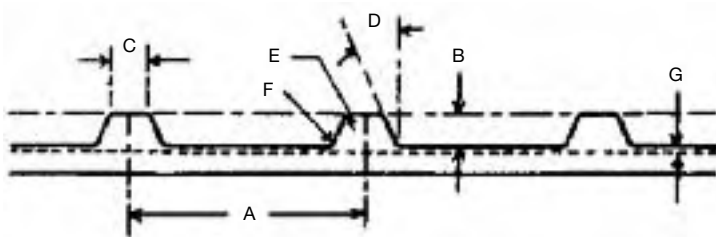

- A Pitch of Teeth
- B Depth of Teeth
- C Width at Bottom of Teeth
- D Pressure Angle
- E Radius at Bottom of Teeth
- F Radius at Top of Teeth
- G Pitch Line Differential

Belt P.L. = "A" X Total No. of Teeth in Belt

TIMING PULLEY TERMINOLOGY

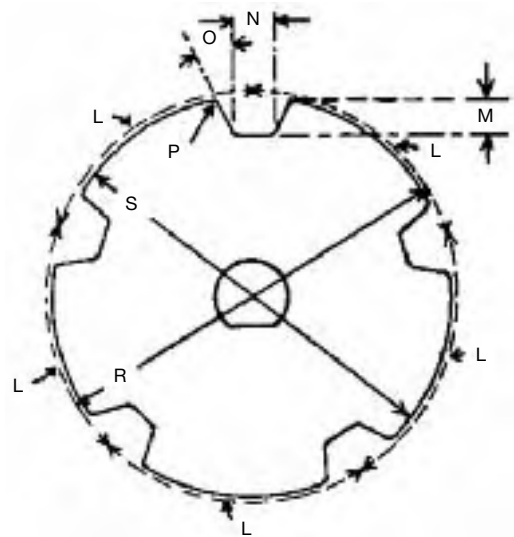

- L Circular Pitch of Groove
- M Minimum Depth of Groove, Including Clearance
- N Width of Groove at Minimum Depth, Including Clearance
- O Pressure Angle
- P Top Radius of Groove
- R Pitch Diameter (Always > S)
- S Outside Diameter

Timing Pulley Terminology



Timing Pulleys

Timing pulleys have evenly spaced axial grooves cut in their periphery to make correct, positive engagement with the mating teeth of the belt. These pulleys are designed so that the teeth of the belt enter and leave the grooves with negligible friction. All pulleys, stock and made-to-order, have minimum tooth-to-groove clearance (backlash). The pulley's pitch diameter will always be greater than its outside diameter. Pulleys are available in a wide range of stock widths and diameters.

Minimum Pulley Diameters

pitch	speed rpm	recommended minimum*	no. of grooves
		pitch diam. in.	
1/8 in. (XL)	3500	.764	12 XL
	1750	.637	10 XL
	1160	.637	10 XL
3/8 in. (L)	3500	1.910	16 L
	1750	1.671	14 L
	1160	1.432	12 L
1/2 in. (H)	3500	3.183	20 H
	1750	2.865	18 H
	1160	2.546	16 H
7/8 in. (XH)	1750	7.242	26 XH
	1160	6.685	24 XH
	870	6.127	22 XH
1 1/4 in. (XXH)	1750	10.345	26 XXH
	1160	9.549	24 XXH
	870	8.754	22 XXH

*Smaller diameter pulleys can be used if a corresponding reduction in belt service life is satisfactory.

Flanged Pulleys

Because timing belts have an inherent, gentle side thrust, it is necessary to use at least one flanged pulley to prevent the belt from riding off. Generally, for economy, the smaller pulley in each drive is flanged. However, when the center distance is greater than eight times the diameter of the smaller pulley on drive ratios less than 3 to 1, or when the drive is operated on other than horizontal shafts — both pulleys should be flanged. When a drive has three pulleys, at least two should be flanged. If the drive has more than three pulleys, every other pulley should be flanged.

Pulley Diameters

Stock timing belts should not be used over pulley diameters less than those recommended above without expecting some reduction in belt life. This reduced belt life is the result of flex fatigue of the steel tension members in the belt. If pulleys smaller than recommended must be used, the use of special timing belts should be considered.

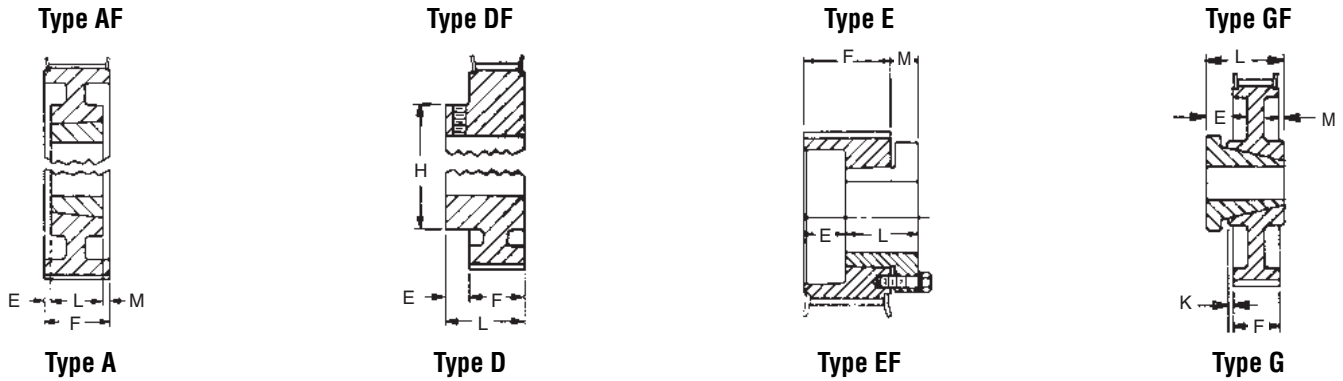

Dash 1 = Solid Style Dash 2 = Web Style Dash 3 = Arm/Spoke Style
 "F" type description indicates flanged.

XL - 1/5" Pitch

XL 037 For Belts 1/4" and 3/8" Wide
 Minimum Plain Bore

F = 1/16

No. Teeth	Part Number	Pitch Diam.	Max FL O.D.	Type	Bore		E	H	L	WT
					Stk.*	Max.				
10	10XL037	.637	.929	DF-1	3/16	1/4	7/32	7/16	25/32	.03
11	11XL037	.700	.929	DF-1	3/16	1/4	7/32	7/16	25/32	.04
12	12XL037	.764	.993	DF-1	3/16	3/8	7/32	7/8	25/32	.06
14	14XL037	.891	1.120	DF-1	1/4	3/8	7/32	9/16	25/32	.08
15	15XL037	.955	1.184	DF-1	1/4	7/16	7/32	5/8	25/32	.09
16	16XL037	1.019	1.248	DF-1	1/4	1/2	7/32	11/16	25/32	.10
18	18XL037	1.146	1.375	DF-1	1/4	9/16	7/32	13/16	25/32	.13
20	20XL037	1.273	1.502	DF-1	1/4	11/16	5/16	15/16	7/8	.18
21	21XL037	1.337	1.566	DF-1	1/4	11/16	5/16	15/16	7/8	.19
22	22XL037	1.401	1.630	DF-1	1/4	3/4	5/16	1	7/8	.22
24	24XL037	1.528	1.756	DF-1	1/4	13/16	5/16	1 1/16	7/8	.25
28	28XL037	1.783	2.011	DF-1	1/4	15/16	5/16	1 1/8	7/8	.34
30	30XL037	1.910	2.138	DF-1	5/16	1 1/16	5/16	1 3/8	7/8	.41
32	32XL037	2.037	—	D-1	5/16	1 3/16	7/16	1 1/2	1	.25
36	36XL037	2.292	—	D-1	5/16	1 3/16	7/16	1 1/2	1	.29
40	40XL037	2.546	—	D-1	5/16	1 3/16	7/16	1 1/2	1	.35
42	42XL037	2.674	—	D-1	5/16	1 3/16	7/16	1 1/2	1	.31
44	44XL037	2.801	—	D-1	5/16	1 3/16	7/16	1 1/2	1	.34
48	48XL037	3.056	—	D-1	5/16	1 3/16	7/16	1 1/2	1	.63
60	60XL037	3.820	—	D-1	3/8	1 3/16	7/16	1 1/2	1	.90
72	72XL037	4.584	—	D-1	3/8	1 3/16	7/16	1 1/2	1	.50

Note: XL Pulleys stocked min. plain bore with 2 setscrews @ 90°. If keyway is used, reduce max. bore by twice keyway depth.
 Pulley O.D. = P.D. - .02".

L 3/8" Pitch

Stock Timing Pulleys

L - 3/8" Pitch

L050 For Belts 1/2" Wide
Minimum Plain Bore

$F = \frac{3}{4}$

No. Teeth	Part Number	Pitch Diam.	Max FL O.D.	Type	Bore		Dimensions			Wt.
					Stk. *	Max.	E	H	L	
10	10L050	1.194	1 1/16	DF-1	3/8	3/16	3/8	1 3/16	1 1/8	.28
12	12L050	1.432	1 4/16	DF-1	3/8	3/16	1/2	1 1/16	1 1/4	.30
13	13L050	1.552	1 3/4	DF-1	3/8	1/8	1/2	1 1/8	1 1/4	.35
14	14L050	1.671	1 5/16	DF-1	3/8	7/16	1/2	1 1/8	1 1/4	.40
15	15L050	1.790	2	DF-1	1/2	1/8	1/2	1 1/8	1 1/4	.50
16	16L050	1.910	2 3/32	DF-1	1/2	1 1/8	3/8	1 1/16	1 3/8	.60
17	17L050	2.029	2 1/16	DF-1	1/2	1 1/8	3/8	1 1/8	1 3/8	.65
18	18L050	2.149	2 5/16	DF-1	1/2	1 3/16	3/8	1 3/8	1 3/8	.75
19	19L050	2.268	2 1/2	DF-1	1/2	1 1/2	3/8	1 3/8	1 3/8	.80
20	20L050	2.387	2 3/8	DF-1	1/2	1 1/4	3/8	1 11/16	1 3/8	.94
21	21L050	2.507	2 3/4	DF-1	1/2	1 5/8	1/2	1 3/8	1 3/8	1.00
22	22L050	2.626	2 7/8	DF-1	1/2	1 1/2	3/4	2	1 1/2	1.10
24	24L050	2.865	3 1/16	DF-1	1/2	1 5/8	3/4	2 1/4	1 1/2	1.60
26	26L050	3.104	3 1/32	DF-1	1/2	1 5/8	3/4	2 1/2	1 1/2	2.30
28	28L050	3.342	3 3/16	DF-1	1/2	1 5/8	3/4	2 3/4	1 1/2	2.50
30	30L050	3.581	3 9/16	DF-1	1/2	1 5/8	3/4	2 3/4	1 1/2	2.70
32	32L050	3.820	4 1/16	DF-1	1/2	1 5/8	7/8	3 1/16	1 1/2	3.00

L Pulleys 10 - 16 teeth min. plain bore stocked with 1 set screw. If keyway is used, reduced maximum bore by twice keyway depth.
Dimensions in inches. Weight in pounds
Pulley O.D. = P.D. - .03"

L050 For Belts 1/2" Wide (3/8" Pitch) QD Type

$F = \frac{3}{4}$

No. Teeth	Part Number	Pitch Diam.	Max FL O.D.	Type	Bush	Bore Range	Dimensions				Wt. Less Bush.
							E	K	L	M	
18	18L050JA	2.149	2 29/64	EF-1*	JA	1/2-1 1/4	3/16	—	1 1/16	1/2	.40
20	20L050JA	2.387	2 3/8	EF-1*	JA	1/2-1 1/4	3/16	—	1 1/16	1/2	.50
22	22L050JA	2.626	2 1/2	EF-1*	JA	1/2-1 1/4	3/16	—	1 1/16	1/2	.70
24	24L050SH	2.865	3 1/16	GF-1 +	SH	1/2-1 11/16	3/16	—	1 1/16	0	.70
26	26L050SH	3.104	3 1/32	GF-1 +	SH	1/2-1 11/16	3/16	0	1 1/16	0	1.00
28	28L050SH	3.342	3 37/64	GF-1 +	SH	1/2-1 11/16	3/16	0	1 1/16	0	1.10
30	30L050SDS	3.581	3 59/64	GF-1	SDS	1/2-2	3/8	0	1 3/8	0	1.10
32	32L050SDS	3.820	4 1/16	GF-1	SDS	1/2-2	3/8	0	1 3/8	0	1.40
36	36L050SDS	4.297	4 17/32	GF-1	SDS	1/2-2	3/8	0	1 3/8	0	2.00
40	40L050SDS	4.775	5 1/16	GF-1	SDS	1/2-2	3/8	0	1 3/8	0	2.80
44	44L050SDS	5.252	5 21/64	GF-1	SDS	1/2-2	3/8	0	1 3/8	0	3.60
48	48L050SDS	5.730	6 1/16	GF-1	SDS	1/2-2	3/8	0	1 3/8	0	4.40
60	60L050SD	7.162	—	G-3	SD	1/2-2	3/8	1/4	1 3/16	1/4	4.20
72	72L050SD	8.594	—	G-3	SD	1/2-2	3/8	1/4	1 3/16	1/4	6.60
84	84L050SD	10.027	—	G-3	SD	1/2-2	3/8	1/4	1 3/16	1/4	5.80

Dimensions in inches. Weight in pounds
Pulley O.D. = P.D. - .03"
*Reverse mount drilled only
+Bushing Projects 1/16 on Small End.

L050 Taper Bushed
on Page K7

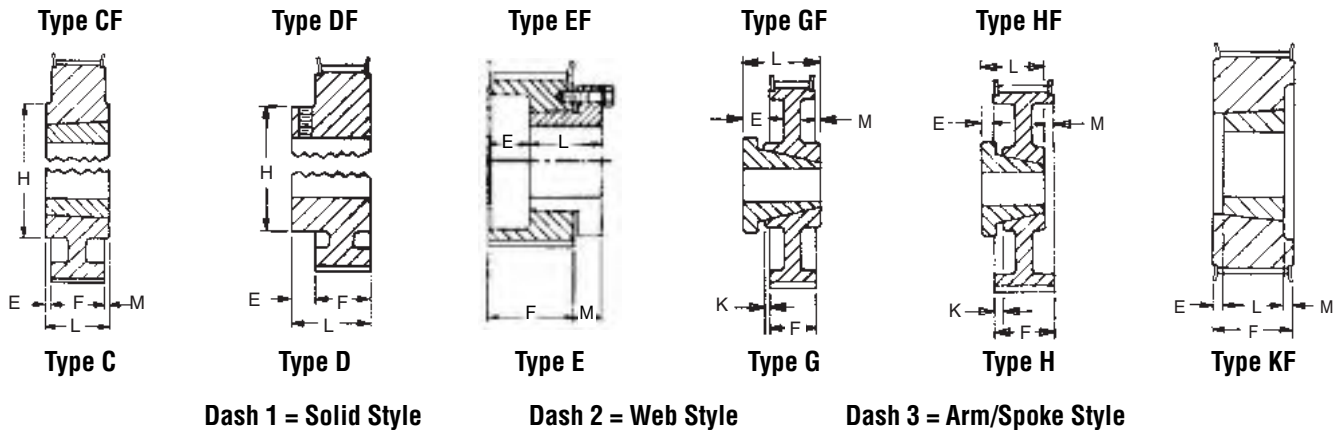

L050 For Belts 1/2" Wide (3/8" Pitch) Taper Bushed Type

$$F = \frac{3}{4}$$

No. Teeth	Part Number	Pitch Diam.	Max FL O.D.	Type	Bush	Bore Range	Dimensions				Wt. Less Bush.
							E	H	L	M	
18	TB18L050	2.149	2 ²⁵ / ₆₄	CF-1	1008	1/2-1	1/8	1 1/8	3/8	—	0.45
20	TB20L050	2.387	2 2/8	CF-1	1008	1/2-1	1/8	1 11/16	3/8	—	0.68
22	TB22L050	2.626	2 2/8	CF-1	1008	1/2-1	1/8	2	3/8	—	0.90
24	TB24L050	2.865	3 1/64	CF-1	1210	1/2-1 1/4	1/4	2 1/4	1	—	1.00
26	TB26L050	3.104	3 1/32	CF-1	1210	1/2-1 1/4	1/4	2 1/2	1	—	1.20
28	TB28L050	3.342	3 3/64	CF-1	1610	1/2-1 1/4	1/4	2 3/4	1	—	1.40
30	TB30L050	3.581	3 3/64	CF-1	1610	1/2-1 1/4	1/4	2 7/8	1	—	1.50
32	TB32L050	3.820	4 1/16	CF-1	1610	1/2-1 1/4	1/4	3 1/16	1	—	1.90
40	TB40L050	4.775	5 1/64	CF-1	2012	1/2-2	1/2	3 11/16	1 1/4	—	2.40
48	TB48L050	5.730	6 1/64	CF-1	2012	1/2-2	1/2	3 11/16	1 1/4	—	3.20
60	TB60L050	7.162	—	C-2	2012	1/2-2	1/4	4 3/8	1 1/4	1/4	4.90

Dimensions in inches. Weight in pounds
Pulley O.D. = P.D. - .03"

L075 For Belts 3/4" Wide (3/8" Pitch) Minimum Plain Bore

$$F = 1$$

No. Teeth	Part Number	Pitch Diam.	Max FL O.D.	Type	Bore		Dimensions			Wt.
					Stk. *	Max.	E	H	L	
12	12L075	1.432	1 13/64	DF-1	3/8	1 1/16	1/2	1 1/16	1 1/2	.40
14	14L075	1.671	1 9/64	DF-1	3/8	7/8	1/2	1 1/8	1 1/2	.50
16	16L075	1.910	2 2/32	DF-1	1/2	1 1/8	5/8	1 7/16	1 3/4	.70
18	18L075	2.149	2 25/64	DF-1	1/2	1 1/8	5/8	1 1/8	1 3/4	.90
20	20L075	2.387	2 2/8	DF-1	1/2	1 1/4	5/8	1 11/16	1 3/4	1.5
22	22L075	2.626	2 2/8	DF-1	3/4	1 1/2	3/4	2	1 3/4	1.8
24	24L075	2.865	3 3/64	DF-1	3/4	1 5/8	3/4	2 1/4	1 3/4	2.1
26	26L075	3.104	3 1/32	DF-1	3/4	1 3/4	7/8	2 1/2	1 3/4	2.8
28	28L075	3.342	3 3/64	DF-1	3/4	1 3/4	1	2 3/4	2	3.1
30	30L075	3.581	3 3/64	DF-1	3/4	1 7/8	1	2 3/4	2	3.4
32	32L075	3.820	4 1/16	DF-1	3/4	1 7/8	1	3 1/16	2	3.7

Dimensions in inches. Weight in pounds.

Pulley O.D. = P.D. - .03"

L Pulleys 12 - 16 teeth min. plain bore stocked with 1-SS. If keyway is used, reduce maximum bore by twice keyway depth.

L

3/8" Pitch

Stock Timing Pulleys

L075 For Belts 3/4" Wide (3/8" Pitch)

QD Type

F = 1

No. Teeth	Part Number	Pitch Diam.	Max FL O.D.	Type	Bush	Bore Range	Dimensions				Wt. Less Bush.
							E	K	L	M	
18	18L075JA	2.149	2 ²⁹ / ₆₄	EF-1*	JA	1/2 - 1 1/4	7/16	—	1 1/16	1/2	.50
20	20L075JA	2.387	2 5/8	EF-1*	JA	1/2 - 1 1/4	7/16	—	1 1/16	1/2	.70
22	22L075JA	2.626	2 7/8	EF-1*	JA	1/2 - 1 1/4	7/16	—	1 1/16	1/2	.80
24	24L075SH	2.865	3 1/64	EF-1*	SH	1/2 - 1 11/16	3/16	—	1 5/16	5/16	.80
26	26L075SH	3.104	3 17/32	EF-1*	SH	1/2 - 1 11/16	3/16	—	1 5/16	5/16	1.1
28	28L075SH	3.342	3 7/64	EF-1*	SH	1/2 - 1 11/16	3/16	—	1 5/16	5/16	1.3
30	30L075SDS	3.581	3 9/64	EF-1*	SDS	1/2 - 2	1/4	—	1 3/8	5/8	1.5
32	32L075SDS	3.820	4 1/16	EF-1*	SDS	1/2 - 2	1/4	—	1 3/8	5/8	1.7
36	36L075SDS	4.297	4 17/32	HF-1	SDS	1/2 - 2	3/8	1/4	1 3/8	0	2.3
40	40L075SDS	4.775	5 1/64	HF-1	SDS	1/2 - 2	3/8	1/4	1 3/8	0	3.1
44	44L075SDS	5.252	5 7/64	HF-1	SDS	1/2 - 2	3/8	1/4	1 3/8	0	4.0
48	48L075SDS	5.730	6 1/64	HF-1	SDS	1/2 - 2	3/8	1/4	1 3/8	0	4.6
60	60L075SD	7.162	—	G-3	SD	1/2 - 2	1 1/16	1/8	1 13/16	1/8	4.7
72	72L075SD	8.594	—	G-3	SD	1/2 - 2	1 1/16	1/8	1 13/16	1/8	6.5
84	84L075SD	10.027	—	G-3	SD	1/2 - 2	1 1/16	1/8	1 13/16	1/8	6.3

Dimensions in inches. Weight in pounds

Pulley O.D. = P.D. - .03"

*Reverse mount only

L075 For Belts 3/4" Wide (3/8" Pitch)

Taper Bushed Type

No. Teeth	Part Number	Pitch Diam.	Max FL O.D.	Type	Bush	Bore Range	Dimensions				Wt. Less Bush.
							E	H	L	M	
18	TB18L075	2.149	2 ²⁹ / ₆₄	KF-1	1008	1/2 - 1	1/8	—	7/8	—	.50
20	TB20L075	2.387	2 5/8	KF-1	1008	1/2 - 1	1/8	—	7/8	—	.70
22	TB22L075	2.626	2 7/8	KF-1	1008	1/2 - 1	1/8	—	7/8	—	1.10
24	TB24L075	2.865	3 1/64	KF-1	1210	1/2 - 1 1/4	—	—	1	—	.90
26	TB26L075	3.104	3 17/32	KF-1	1210	1/2 - 1 1/4	—	—	1	—	1.30
28	TB28L075	3.342	3 37/64	KF-1	1610	1/2 - 1 5/8	—	—	1	—	1.30
30	TB30L075	3.581	3 9/64	KF-1	1610	1/2 - 1 5/8	—	—	1	—	1.60
32	TB32L075	3.820	4 1/16	KF-1	1610	1/2 - 1 5/8	—	—	1	—	1.80
40	TB40L075	4.775	5 1/64	CF-1	2012	1/2 - 2	1/4	3 15/16	1 1/4	—	3.60
48	TB48L075	5.730	6 1/64	CF-1	2012	1/2 - 2	1/4	3 15/16	1 1/4	—	5.40
60	TB60L075	7.162	—	C-1	2012	1/2 - 2	1/8	4 3/8	1 1/4	1/8	7.90

Dimensions in inches. Weight in pounds

Pulley O.D. = P.D. - .03"



Stock Timing Pulleys

L
3/8" Pitch

L100 For Belts 1" Wide (3/8" Pitch) Minimum Plain Bore

F = 1/4

No. Teeth	Part Number	Pitch Diam.	Max FL O.D.	Type	Bore		Dimensions			Wt.
					Stk.*	Max.	E	H	L	
14	14L100	1.671	1 ⁵⁹ / ₆₄	DF-1	3/8	7/8	1/2	1 1/8	1 1/4	.60
16	16L100	1.910	2 ⁵ / ₃₂	DF-1	1/2	1 1/8	5/8	1 1/16	1 1/8	.80
17	17L100	2.029	2 ⁹ / ₃₂	DF-1	1/2	1 1/8	5/8	1 1/2	1 1/8	1.0
18	18L100	2.149	2 ²⁹ / ₆₄	DF-1	1/2	1 3/16	5/8	1 1/8	1 1/4	1.1
19	19L100	2.268	2 3/8	DF-1	1/2	1 3/16	5/8	1 1/8	1 1/4	1.4
20	20L100	2.387	2 3/8	DF-1	1/2	1 3/16	5/8	1 1/16	1 1/8	1.75
21	21L100	2.507	2 3/4	DF-1	5/8	1 1/16	11/16	1 1/8	1 1/8	1.80
22	22L100	2.626	2 3/8	DF-1	5/8	1 1/2	3/4	2	2	2.0
24	24L100	2.865	3 3/64	DF-1	5/8	1 5/8	3/4	2 1/4	2	2.5
26	26L100	3.104	3 1/32	DF-1	5/8	1 5/8	7/8	2 1/2	2 1/4	3.3
28	28L100	3.342	3 37/64	DF-1	5/8	1 5/8	1	2 3/4	2 1/4	3.6
30	30L100	3.581	3 59/64	DF-1	5/8	1 5/8	1	2 5/8	2 1/4	4.0
32	32L100	3.820	4 1/16	DF-1	5/8	1 5/8	1	3 1/16	2 1/4	4.4

Dimensions in inches. Weight in pounds

Pulley O.D. = P.D. - .03"

L Pulleys 14 - 16 teeth min. plain bore stocked with 1-S.S. If keyway is used, reduce maximum bore by twice keyway depth.

L100 For Belts 1" Wide (3/8" Pitch) QD Type

F = 1/4

No. Teeth	Part Number	Pitch Diam.	Max FL O.D.	Type	Bush	Bore Range	Dimensions				Wt. Less Bush.
							E	K	L	M	
18	18L100JA	2.149	2 ²⁹ / ₆₄	EF-1*	JA	1/2 - 1 1/4	1 1/16	—	1 1/16	1/2	.70
20	20L100JA	2.387	2 3/8	EF-1*	JA	1/2 - 1 1/4	1 1/16	—	1 1/16	1/2	.90
22	22L100JA	2.626	2 3/8	EF-1*	JA	1/2 - 1 1/4	1 1/16	—	1 1/16	1/2	1.0
24	24L100SH	2.865	3 3/64	EF-1*	SH	1/2 - 1 11/16	7/16	—	1 1/16	5/16	1.0
26	26L100SH	3.104	3 1/32	EF-1*	SH	1/2 - 1 11/16	7/16	—	1 1/16	5/16	1.3
28	28L100SH	3.342	3 37/64	EF-1*	SH	1/2 - 1 11/16	7/16	—	1 1/16	5/16	1.7
30	30L100SDS	3.581	3 59/64	EF-1*	SDS	1/2 - 2	1/2	—	1 3/8	5/8	2.0
32	32L100SDS	3.820	4 1/16	EF-1*	SDS	1/2 - 2	1/2	—	1 3/8	5/8	2.1
36	36L100SDS	4.297	4 17/32	HF-1	SDS	1/2 - 2	1/2	1/2	1 3/8	0	2.6
40	40L100SDS	4.775	5 1/64	HF-1	SDS	1/2 - 2	1/2	1/2	1 3/8	0	3.4
44	44L100SDS	5.252	5 37/64	HF-1	SDS	1/2 - 2	1/2	1/2	1 3/8	0	4.2
48	48L100SDS	5.730	6 1/64	HF-1	SDS	1/2 - 2	1/2	1/2	1 3/8	0	5.1
60	60L100SD	7.162	—	G-3	SD	1/2 - 2	5/8	0	1 3/16	0	6.0
72	72L100SD	8.594	—	G-3	SD	1/2 - 2	5/8	0	1 3/16	0	8.0
84	84L100SD	10.027	—	G-3	SD	1/2 - 2	5/8	0	1 3/16	0	9.2

Dimensions in inches. Weight in pounds

Pulley O.D. = P.D. - .03"

*Reverse mount only

L 3/8" Pitch

Stock Timing Pulleys

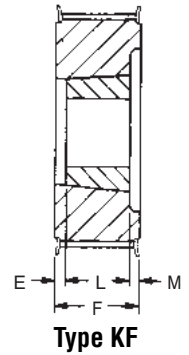
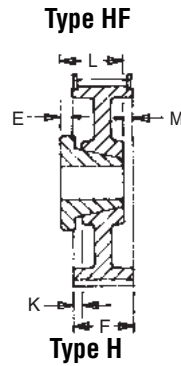
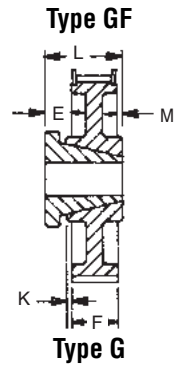
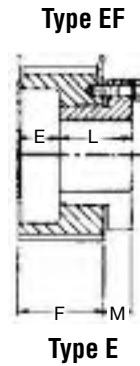
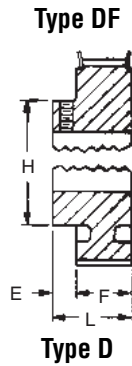
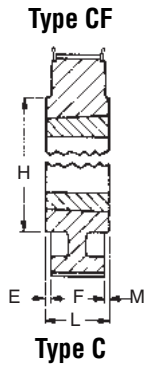

Dash 1 = Solid Style

Dash 2 = Web Style

Dash 3 = Arm/Spoke Style

“F” in type description indicates flanged.

L100 For Belts 1" Wide (3/8" Pitch) Taper Bushed Type

F = 1 1/4

No. Teeth	Part Number	Pitch Diam.	Max FL.O.D.	Type	Bush	Bore Range	Dimensions				Wt. Less Bush.
							E	K	L	M	
18	TB18L100	2.149	2 ²⁹ / ₆₄	KF-1	1008	1/2 - 1	3/8	—	3/8	—	.70
20	TB20L100	2.387	2 ³ / ₈	KF-1	1008	1/2 - 1	3/8	—	3/8	—	1.0
22	TB22L100	2.626	2 ⁵ / ₁₆	KF-1	1008	1/2 - 1	3/8	—	3/8	—	1.3
24	TB24L100	2.865	3 ¹ / ₁₆	KF-1	1210	1/2 - 1 1/4	1/4	—	1	—	1.3
26	TB26L100	3.104	3 ¹ / ₈	KF-1	1210	1/2 - 1 1/4	1/4	—	1	—	1.7
28	TB28L100	3.342	3 ³ / ₁₆	KF-1	1610	1/2 - 1 3/8	1/4	—	1	—	1.7
30	TB30L100	3.581	3 ⁵ / ₁₆	KF-1	1610	1/2 - 1 3/8	1/4	—	1	—	2.2
32	TB32L100	3.820	4 ¹ / ₁₆	KF-1	1610	1/2 - 1 3/8	1/4	—	1	—	2.7
40	TB40L100	4.775	5 ¹ / ₁₆	KF-1	2012	1/2 - 2	1/16	—	1 1/4	—	3.6
48	TB48L100	5.730	6 ¹ / ₁₆	KF-1	2012	1/2 - 2	1/16	—	1 1/4	—	5.1
60	TB60L100	7.162	—	C-2	2012	1/2 - 2	—	—	1 1/4	—	6.0

Dimensions in inches. Weight in pounds
Pulley O.D. = P.D. - .03"

PULLEYS



Stock Timing Pulleys

H 1/2" Pitch

H — 1/2" Pitch

H100 For Belts 3/4" and 1" Wide (1/2" Pitch)

Minimum Plain Bore

F = 1 5/16

No. Teeth	Part Number	Pitch Diam.	Max FL. O.D.	Type	Bore		Dimensions			Wt.
					Stk.	Max.	E	H	L	
14	14H100	2.228	2 ³¹ / ₆₄	DF-1	3/8	1	5/8	1 1/2	1 ¹⁵ / ₁₆	1.4
16	16H100	2.546	2 ⁵ / ₁₆	DF-1	3/8	1 1/4	1 ¹ / ₁₆	2	2	2.0
18	18H100	2.865	3 ³ / ₆₄	DF-1	3/8	1 1/2	1 ¹ / ₁₆	2 1/4	2	2.8
20	20H100	3.183	3 ⁷ / ₁₆	DF-1	3/8	1 5/8	7/8	2 1/2	2 ³ / ₁₆	3.4
21	21H100	3.342	3 ⁷ / ₁₆	DF-1	3/4	1 11/16	1	2 3/8	2 1/4	3.8
22	22H100	3.501	3 3/4	DF-1	3/4	1 7/8	1	2 3/8	2 ⁵ / ₁₆	4.3
24	24H100	3.820	4 ¹ / ₆₄	DF-1	3/4	2 1/8	1	3 3/8	2 ⁵ / ₁₆	5.3
26	26H100	4.138	4 ²⁵ / ₆₄	DF-1	3/4	2 1/2	1 1/8	3 3/8	2 ⁵ / ₁₆	6.7
28	28H100	4.456	4 ⁴⁵ / ₆₄	DF-1	3/4	2 3/8	1 1/8	3 3/8	2 ⁵ / ₁₆	8.0

Dimensions in inches. Weight in pounds
Pulley O.D. = P.D. - .054"

H100 For Belts 3/4" and 1" Wide (1/2" Pitch)

QD Type

F = 1 5/16

No. Teeth	Part Number	Pitch Diam.	Max FL. O.D.	Type	Bush	Bore Range	Dimensions					Wt. Less Bush.
							E	H	K	L	M	
14	14H100JA	2.228	2 ³¹ / ₆₄	EF-1*	JA	1/2 - 1 1/4	3/4	—	—	1 1/16	1/2	1.0
16	16H100JA	2.546	2 ⁵ / ₁₆	EF-1*	JA	1/2 - 1 1/4	3/4	—	—	1 1/16	1/2	1.5
18	18H100SH	2.865	3 ³ / ₆₄	EF-1*	SH	1/2 - 1 11/16	9/16	—	—	1 3/16	5/16	1.2
20	20H100SH	3.183	3 ⁷ / ₁₆	EF-1*	SH	1/2 - 1 11/16	9/16	—	—	1 5/16	5/16	1.2
22	22H100SDS	3.501	3 3/4	EF-1*	SDS	1/2 - 2	9/16	—	—	1 1/8	5/16	1.4
24	24H100SDS	3.820	4 ¹ / ₆₄	EF-1*	SDS	1/2 - 2	9/16	—	—	1 3/8	5/16	1.7
26	26H100SDS	4.138	4 ²⁵ / ₆₄	HF-1	SDS	1/2 - 2	1/16	—	9/16	1 3/8	—	2.0
28	28H100SDS	4.456	4 ⁴⁵ / ₆₄	HF-1	SDS	1/2 - 2	1/16	—	9/16	1 3/8	—	2.6
30	30H100SD	4.775	5 ¹ / ₆₄	GF-1	SD	1/2 - 2	5/8	—	—	1 3/16	—	3.0
32	32H100SK	5.093	5 ²¹ / ₆₄	GF-1	SK	1/2 - 2 3/8	1 1/16	—	—	1 5/16	—	4.9
36	36H100SK	5.730	5 ⁵¹ / ₆₄	GF-1	SK	1/2 - 2 3/8	1 1/16	—	—	1 5/16	—	5.6
40	40H100SK	6.366	6 ³⁷ / ₆₄	GF-1	SK	1/2 - 2 3/8	1 1/16	—	—	1 5/16	—	8.2
44	44H100SK	7.003	7 1/4	GF-1	SK	1/2 - 2 3/8	1 1/16	—	—	1 5/16	—	10.0
48	48H100SK	7.639	8 ¹ / ₆₄	GF-2	SK	1/2 - 2 3/8	1 1/16	—	—	1 5/16	—	12.5
60	60H100SF	9.549	—	H-2	SF	1/2 - 2 15/16	1 1/16	—	—	2 1/16	—	10.9
72	72H100SF	11.459	—	H-3	SF	1/2 - 2 15/16	1 1/16	—	—	2 1/16	—	14.0
84	84H100SF	13.369	—	H-3	SF	1/2 - 2 15/16	1 1/16	5 1/8	—	2 1/16	—	20.0
96	96H100SF	15.279	—	H-3	SF	1/2 - 2 15/16	1 1/16	5 1/8	—	2 1/16	—	27.0
120	120H100SF	19.099	—	H-3	SF	1/2 - 2 15/16	1 1/16	5 1/8	—	2 1/16	—	38.0

Dimensions in inches. Weight in pounds
Pulley O.D. = P.D. - .054"

*Reverse mount only

H 1/2" Pitch

Stock Timing Pulleys

Type CF

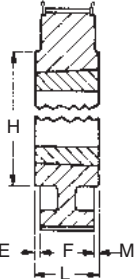

Type C

Type DF

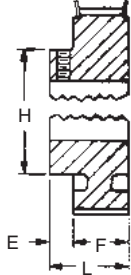

Type D

Type EF

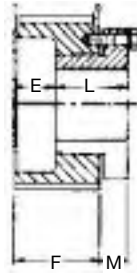

Type E

Type GF

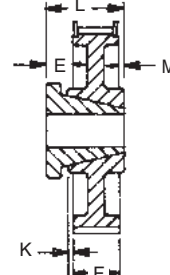

Type G

Type HF

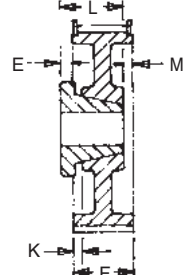

Type H

Dash 1 = Solid Style Dash 2 = Web Style Dash 3 = Arm/Spoke Style

"F" in description indicates flanged.

H100 For Belts 3/4" and 1" Wide (1/2" Pitch) Taper Bushed Type

F = 1 5/16

No. Teeth	Part Number	Pitch Diam.	Max Fl. O.D.	Type	Bush	Bore Range	Dimensions				Wt. Less Bush.
							E	H	L	M	
14	TB14H100	2.228	2 ³ / ₆₄	KF-1	1008	1/2 - 1	7/16	—	7/8	—	.80
16	TB16H100	2.546	2 ⁵ / ₆₄	KF-1	1008	1/2 - 1	7/16	—	7/8	—	1.3
18	TB18H100	2.865	3 ³ / ₆₄	KF-1	1210	1/2 - 1 1/4	9/16	—	1	—	1.2
20	TB20H100	3.183	3 ⁷ / ₆₄	KF-1	1210	1/2 - 1 1/4	9/16	—	1	—	1.7
22	TB22H100	3.501	3 1/4	KF-1	1610	1/2 - 1 3/8	9/16	—	1	—	1.8
24	TB24H100	3.820	4 ¹ / ₆₄	KF-1	1610	1/2 - 1 3/8	5/16	—	1	—	2.3
26	TB26H100	4.138	4 ² / ₆₄	KF-1	2012	1/2 - 2	1/16	—	1 1/4	—	2.6
28	TB28H100	4.456	4 ⁴ / ₆₄	KF-1	2012	1/2 - 2	1/16	—	1 1/4	—	2.8
30	TB30H100	4.775	5 ¹ / ₆₄	KF-1	2012	1/2 - 2	1/16	—	1 1/4	—	4.2
32	TB32H100	5.093	5 ² / ₆₄	CF-1	2517	1/2 - 2 1/2	7/16	4 ¹ / ₁₆	1 3/4	—	4.3
40	TB40H100	6.366	6 ³ / ₆₄	CF-1	2517	1/2 - 2 1/2	7/16	4 ¹ / ₁₆	1 3/4	—	7.8
48	TB48H100	7.639	8 ¹ / ₆₄	CF-1	2517	1/2 - 2 1/2	7/16	4 ¹ / ₁₆	1 3/4	—	12.1
60	TB60H100	9.549	—	C-2	3020	1/2 - 3	1 ¹ / ₃₂	6 ¹ / ₄	2	1 ¹ / ₃₂	10.3

Dimensions in inches. Weight in pounds
Pulley O.D. = P.D. - .054"

Type AF

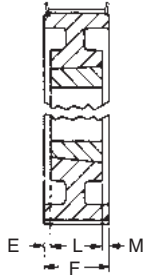

Type A

Type CF

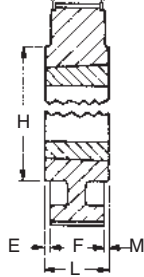

Type C

Type DF

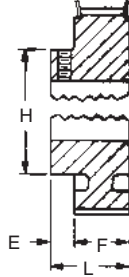

Type D

Type EF

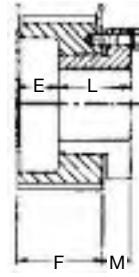

Type E

Type GF

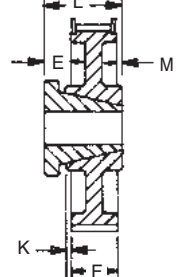

Type G

Type HF

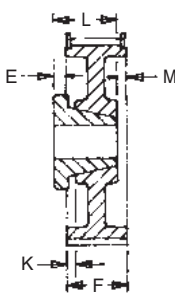

Type H

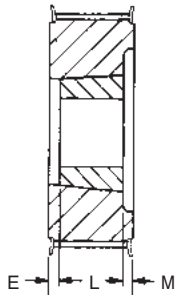

Type KF

Dash 1 = Solid Style

Dash 2 = Web Style

Dash 3 = Arm/Spoke Style

"F" in type description indicates flanged.

H150 For Belts 1 1/2" Wide (1/2" Pitch) Minimum Plain Bore

$$F = 1\frac{13}{16}$$

No. Teeth	Part Number	Pitch Diam.	Max FL O.D.	Type	Bore		Dimensions			Wt.
					Stk.	Max.	E	H	L	
14	14H150	2.228	2 ³ / ₆₄	DF-1	3/4	1	5/8	1 1/2	2 ⁷ / ₁₆	1.8
16	16H150	2.546	2 ⁵ / ₆₄	DF-1	3/4	1 1/4	3/4	2	2 ⁵ / ₁₆	2.5
18	18H150	2.865	3 ³ / ₆₄	DF-1	3/4	1 1/2	3/4	2 1/4	2 ⁵ / ₁₆	3.3
19	19H150	3.024	3/4	DF-1	3/4	1 15/16	7/8	2 1/4	2 ⁵ / ₁₆	3.9
20	20H150	3.183	3 ⁷ / ₁₆	DF-1	3/4	1 5/8	7/8	2 1/2	2 ¹¹ / ₁₆	4.3
21	21H150	3.342	3 ⁹ / ₁₆	DF-1	3/4	1 11/16	15/16	2 1/2	2 ³ / ₄	5.3
22	22H150	3.501	3/4	DF-1	3/4	1 7/8	1	2 5/8	2 ¹³ / ₁₆	5.4
24	24H150	3.820	4 ¹ / ₁₆	DF-1	3/4	2 1/8	1	3 1/4	2 ¹³ / ₁₆	6.5
26	26H150	4.138	4 ²⁵ / ₃₂	DF-1	3/4	2 1/2	1	3 1/2	2 ¹³ / ₁₆	8.4

Dimensions in inches. Weight in pounds
Pulley O.D. = P.D. - .054"

H

1/2" Pitch

Stock Timing Pulleys

H150 For Belts 1 1/2" Wide (1/2" Pitch) QD Type

F = 1 13/16

No. Teeth	Part Number	Pitch Diam.	Max FL O.D.	Type	Bush.	Bore Range	Dimensions				Wt. Less Bush.
							E	K	L	M	
14	14H150JA	2.228	2 ³ / ₆₄	EF-1*	JA	1/2 - 1 1/4	1 1/4	—	1 1/16	1/2	1.5
16	16H150JA	2.546	2 ⁵ / ₆₄	EF-1*	JA	1/2 - 1 1/4	1 1/4	—	1 1/16	1/2	2.0
18	18H150SH	2.865	3 ³ / ₆₄	EF-1*	SH	1/2 - 1 11/16	1	—	1 1/16	5/16	1.3
20	20H150SH	3.183	3 ⁷ / ₆₄	EF-1*	SH	1/2 - 1 11/16	1	—	1 1/16	5/16	1.8
22	22H150SD	3.501	3 3/4	EF-1*	SD	1/2 - 2	5/16	—	1 1/16	5/8	2.0
24	24H150SD	3.820	4 1/16	EF-1*	SD	1/2 - 2	9/16	—	1 1/16	5/8	2.6
26	26H150SD	4.138	4 ²⁹ / ₃₂	HF-1	SD	1/2 - 2	1/16	5/16	1 1/16	1/16	3.0
28	28H150SD	4.456	4 ⁴⁹ / ₆₄	HF-1	SD	1/2 - 2	1/16	5/16	1 1/16	1/16	4.0
30	30H150SD	4.775	5 ¹ / ₆₄	HF-1	SD	1/2 - 2	1/16	5/16	1 1/16	1/16	4.9
32	32H150SK	5.093	5 ⁷ / ₆₄	HF-1	SK	1/2 - 2 5/16	1/8	5/16	1 15/16	0	5.8
36	36H150SK	5.730	5 ⁵¹ / ₆₄	HF-1	SK	1/2 - 2 5/16	1/8	5/16	1 15/16	0	7.0
40	40H150SK	6.366	6 ³ / ₆₄	HF-1	SK	1/2 - 2 5/16	1/8	5/16	1 15/16	0	9.2
44	44H150SK	7.003	7 1/4	HF-1	SK	1/2 - 2 5/16	1/8	5/16	1 15/16	0	11.0
48	48H150SK	7.639	8 ¹ / ₆₄	HF-2	SK	1/2 - 2 5/16	1/8	5/16	1 15/16	0	13.7
60	60H150SF	9.549	—	H-2	SF	1/2 - 2 15/16	1 3/32	5/32	2 1/16	5/32	12.5
72	72H150SF	11.459	—	H-3	SF	1/2 - 2 15/16	1 3/32	5/32	2 1/16	5/32	17.0
84	84H150SF	13.369	—	H-3	SF	1/2 - 2 15/16	1 3/32	5/32	2 1/16	5/32	21.5
96	96H150SF	15.279	—	H-3	SF	1/2 - 2 15/16	1 3/32	5/32	2 1/16	5/32	31.0
120	120H150SF	19.099	—	H-3	SF	1/2 - 2 15/16	1 3/32	5/32	2 1/16	5/32	40.0

Dimensions in inches. Weight in pounds

Pulley O.D. = P.D. - .054"

*Reverse mount only

H150 For Belts 1 1/2" Wide (1/2" Pitch) Taper Bushed Type

F = 1 13/16

No. Teeth	Part Number	Pitch Diam.	Max FL O.D.	Type	Bush	Bore Range	Dimensions					Wt. Less Bush.
							E	H	K	L	M	
14	TB14H150	2.228	2 ³ / ₆₄	KF-1	1008	1/2 - 1	1 5/32	—	—	7/8	1 5/32	1.0
16	TB16H150	2.546	2 ⁵ / ₆₄	KF-1	1008	1/2 - 1	1 5/32	—	—	7/8	1 5/32	1.5
18	TB18H150	2.865	3 ³ / ₆₄	KF-1	1215	1/2 - 1 1/4	5/16	—	—	1 1/2	—	1.6
20	TB20H150	3.183	3 ⁷ / ₆₄	KF-1	1215	1/2 - 1 1/4	5/16	—	—	1 1/2	—	2.2
22	TB22H150	3.501	3 3/4	KF-1	1615	1/2 - 1 5/8	5/16	—	—	1 1/2	—	2.5
24	TB24H150	3.820	4 1/16	KF-1	2012	1/2 - 2	9/16	—	—	1 1/4	—	2.7
26	TB26H150	4.138	4 ²⁹ / ₃₂	KF-1	2012	1/2 - 2	9/16	—	—	1 1/4	—	3.2
28	TB28H150	4.456	4 ⁴⁹ / ₆₄	KF-1	2012	1/2 - 2	9/16	—	—	1 1/4	—	4.1
30	TB30H150	4.775	5 ¹ / ₆₄	KF-1	2012	1/2 - 2	9/16	—	—	1 1/4	—	5.1
32	TB32H150	5.093	5 ⁷ / ₆₄	KF-1	2517	1/2 - 2 1/2	1/16	—	—	1 3/4	—	5.6
40	TB40H150	6.366	6 ³ / ₆₄	KF-1	2517	1/2 - 2 1/2	1/16	—	—	1 3/4	—	8.6
48	TB48H150	7.639	8 ¹ / ₆₄	AF-1	2517	1/2 - 2 1/2	—	—	1/16	1 3/4	1/16	13.6
60	TB60H150	9.549	—	C-2	3020	7/8 - 3	3/32	6 1/4	—	2	5/32	12.3

Dimensions in inches. Weight in pounds

Pulley O.D. = P.D. - .054"

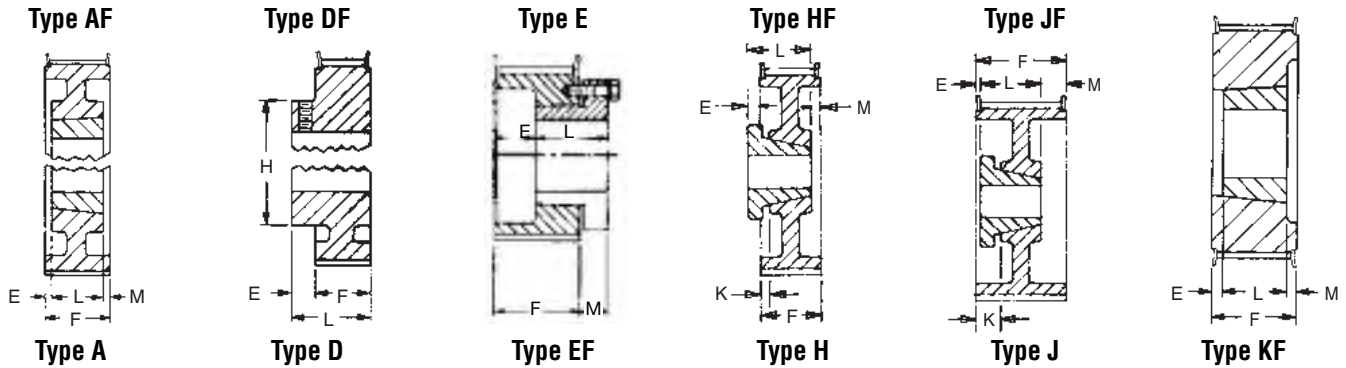

Dash 1 = Solid Style Dash 2 = Web Style Dash 3 = Arm/Spoke Style

“F” in type description indicates flanged.

H200 For Belts 2" Wide (1/2" Pitch)

Minimum Plain Bore

$$F = 2\frac{1}{32}$$

No. Teeth	Part Number	Pitch Diam.	Max FL O.D.	Type	Bore		Dimensions			Wt.
					Stk.	Max.	E	H	L	
14	14H200	2.228	2 ⁵ / ₈	DF-1	3/4	1	5/8	1 1/2	2 ³ / ₃₂	2.2
16	16H200	2.546	2 ⁵ / ₁₆	DF-1	3/4	1 1/4	3/4	2	3 ³ / ₃₂	3.1
18	18H200	2.865	3 ³ / ₁₆	DF-1	3/4	1 1/2	3/4	2	3 ³ / ₃₂	3.7
19	19H200	3.024	3 ¹ / ₄	DF-1	3/4	1 1/16	7/8	2 1/4	3 ³ / ₃₂	3.9
20	20H200	3.183	3 ⁷ / ₁₆	DF-1	3/4	1 1/8	7/8	2 1/2	3 ³ / ₃₂	4.9
22	22H200	3.501	3 ³ / ₄	DF-1	1	1 1/8	1	2 1/8	3 ¹ / ₃₂	6.3
24	24H200	3.820	4 ¹ / ₁₆	DF-1	1	2 1/8	1	3 1/8	3 ¹ / ₃₂	7.5
26	26H200	4.138	4 ²⁹ / ₃₂	DF-1	1	2 1/2	1 1/8	3 1/2	3 ¹ / ₃₂	9.5

Dimensions in inches. Weight in pounds
Pulley O.D. = P.D. - .054"

H 1/2" Pitch

Stock Timing Pulleys

H200 For Belts 2" Wide (1/2" Pitch) QD Type

$$F = 2\frac{1}{32}$$

No. Teeth	Part Number	Pitch Diam.	Max. FL. O.D.	Type	Bush	Bore Range	Dimensions				Wt. Less Bush.
							E	K	L	M	
16	16H200JA	2.546	2 ⁵¹ / ₆₄	EF-1*	JA	1/2 - 1 1/4	1 ²⁹ / ₃₂	—	1 ¹ / ₁₆	1/2	2.6
18	18H200SH	2.865	3 ⁷ / ₆₄	EF-1*	SH	1/2 - 1 11/16	1 ¹⁷ / ₃₂	—	1 ⁵ / ₁₆	9/16	1.6
20	20H200SH	3.183	3 ³ / ₁₆	EF-1*	SH	1/2 - 1 11/16	1 ¹⁷ / ₃₂	—	1 ⁵ / ₁₆	9/16	2.2
22	22H200SD	3.501	3 ³ / ₄	EF-1*	SD	1/2 - 2	1 ³ / ₃₂	—	1 ³ / ₁₆	5/8	2.5
24	24H200SD	3.820	4 ¹ / ₁₆	EF-1*	SD	1/2 - 2	1 ³ / ₃₂	—	1 ³ / ₁₆	5/8	3.0
26	26H200SD	4.138	4 ²⁹ / ₃₂	HF-1	SD	1/2 - 2	5/64	35/64	1 ¹³ / ₁₆	35/64	3.9
28	28H200SD	4.456	4 ⁴⁵ / ₆₄	HF-1	SD	1/2 - 2	5/64	35/64	1 ¹³ / ₁₆	35/64	4.7
30	30H200SD	4.775	5 ¹ / ₆₄	HF-1	SD	1/2 - 2	5/64	35/64	1 ¹³ / ₁₆	35/64	5.7
32	32H200SK	5.093	5 ²¹ / ₆₄	HF-1	SK	1/2 - 2 5/8	5/64	35/64	1 ¹⁵ / ₁₆	35/64	6.7
36	36H200SK	5.730	5 ⁵¹ / ₆₄	HF-1	SK	1/2 - 2 5/8	5/64	35/64	1 ¹⁵ / ₁₆	35/64	8.0
40	40H200SK	6.366	6 ³⁷ / ₆₄	HF-1	SK	1/2 - 2 5/8	5/64	35/64	1 ¹⁵ / ₁₆	35/64	10.2
44	44H200SK	7.003	7 ¹ / ₄	HF-1	SK	1/2 - 2 5/8	5/64	35/64	1 ¹⁵ / ₁₆	35/64	12.5
48	48H200SF	7.639	8 ¹ / ₆₄	HF-2	SF	1/2 - 2 15/16	5/64	35/64	2 ¹ / ₁₆	35/64	14.1
60	60H200SF	9.549	—	H-2	SF	1/2 - 2 15/16	5/64	35/64	2 ¹ / ₁₆	35/64	14.6
72	72H200SF	11.459	—	H-3	SF	1/2 - 2 15/16	5/64	35/64	2 ¹ / ₁₆	35/64	21.0
84	84H200SF	13.369	—	H-3	SF	1/2 - 2 15/16	5/64	35/64	2 ⁵ / ₁₆	35/64	23.0
96	96H200E	15.279	—	H-3	E	7/8 - 3 1/2	33/64	23/64	2 ³ / ₈	23/64	34.0
120	120H200E	19.099	—	H-3	E	7/8 - 3 1/2	33/64	23/64	2 ⁵ / ₈	23/64	42.0

Dimensions in inches. Weight in pounds

Pulley O.D. = P.D. - .054"

*Reverse mount only

H200 For Belts 2" Wide (1/2" Pitch) Taper Bushed Type

$$F = 2\frac{1}{32}$$

No. Teeth	Part Number	Pitch Diam.	Max. FL. O.D.	Type	Bush	Bore Range	Dimensions			Wt. Less Bush.
							E	L	M	
16	TB16H200	2.546	2 ⁵¹ / ₆₄	KF-1	1008	1/2 - 1	3/4	7/8	23/32	1.9
18	TB18H200	2.865	3 ⁷ / ₆₄	KF-1	1215	1/2 - 1 1/4	7/16	1 1/2	13/32	1.8
20	TB20H200	3.183	3 ³ / ₁₆	KF-1	1215	1/2 - 1 1/4	2 ¹ / ₆₄	1 1/2	2 ¹ / ₆₄	2.6
22	TB22H200	3.501	3 ³ / ₄	KF-1	1615	1/2 - 1 5/8	2 ¹ / ₆₄	1 1/2	2 ¹ / ₆₄	2.8
24	TB24H200	3.820	4 ¹ / ₁₆	KF-1	2012	1/2 - 2	35/64	1 1/4	35/64	2.8
26	TB26H200	4.138	4 ²⁹ / ₃₂	KF-1	2012	1/2 - 2	35/64	1 1/4	35/64	3.6
28	TB28H200	4.456	4 ⁴⁵ / ₆₄	KF-1	2012	1/2 - 2	35/64	1 1/4	35/64	5.1
30	TB30H200	4.775	5 ¹ / ₆₄	KF-1	2012	1/2 - 2	1 ¹ / ₃₂	1 1/4	—	7.0
32	TB32H200	5.093	5 ²¹ / ₆₄	KF-1	2517	1/2 - 2 1/2	1 ⁹ / ₃₂	1 3/4	—	8.5
40	TB40H200	6.366	6 ³⁷ / ₆₄	KF-1	2517	1/2 - 2 1/2	1 ⁹ / ₃₂	1 3/4	—	9.9
48	TB48H200	7.639	8 ¹ / ₆₄	KF-1	3020	7/8 - 3	1 ¹ / ₃₂	2	—	14.3
60	TB60H200	9.549	—	A-2	3020	7/8 - 3	1 ¹ / ₆₄	2	1 ¹ / ₆₄	15.3

Dimensions in inches. Weight in pounds

Pulley O.D. = P.D. - .054"

PULLEYS



Stock Timing Pulleys

H 1/2" Pitch

H300 For Belts 3" Wide (1/2" Pitch) Minimum Plain Bore

F = 3 3/8

No. Teeth	Part Number	Pitch Diam.	Max. FL. O.D.	Type	Bore		Dimensions			Wt.
					Stk.	Max.	E	H	L	
16	16H300	2.546	2 5/64	DF-1	3/4	1 1/4	3/4	2	4 1/2	4.2

Dimensions in inches. Weight in pounds
Pulley O.D. = P.D. - .054"

H300 For Belts 3" Wide (1/2" Pitch) QD Type

F = 3 3/8

No. Teeth	Part Number	Pitch Diam.	Max. FL. O.D.	Type	Bush	Bore Range	Dimensions				Wt. Less Bush.
							E	K	L	M	
22	22H300SD	3.501	3 3/4	EF-1*	SD	1/2 - 2	2 1/8	—	1 1/16	5/8	4.1
24	24H300SD	3.820	4 1/16	EF-1*	SD	1/2 - 2	2 1/8	—	1 1/16	5/8	4.1
26	26H300SD	4.138	4 25/64	JF-1	SD	1/2 - 2	7/16	1 1/16	1 1/16	1 1/16	5.0
28	28H300SD	4.456	4 49/64	JF-1	SD	1/2 - 2	7/16	1 1/16	1 1/16	1 1/16	6.0
30	30H300SD	4.775	5 1/64	JF-1	SD	1/2 - 2	7/16	1 1/16	1 1/16	1 1/16	7.2
32	32H300SK	5.093	5 21/64	JF-1	SK	1/2 - 2 5/8	3/8	1 1/16	1 1/16	1 1/16	8.4
36	36H300SK	5.730	5 57/64	JF-1	SK	1/2 - 2 5/8	3/8	1 1/16	1 1/16	1 1/16	10.0
40	40H300SK	6.366	6 37/64	JF-1	SK	1/2 - 2 5/8	3/8	1 1/16	1 1/16	1 1/16	12.2
44	44H300SK	7.003	7 1/4	JF-1	SK	1/2 - 2 5/8	3/8	1 1/16	1 1/16	1 1/16	15.5
48	48H300SF	7.639	8 1/64	JF-2	SF	1/2 - 2 15/16	3/8	1 1/16	2 1/16	1 1/16	16.6
60	60H300SF	9.549	—	J-2	SF	1/2 - 2 15/16	3/8	1 1/16	2 1/16	1 1/16	17.9
72	72H300SF	11.459	—	J-3	SF	1/2 - 2 15/16	3/16	1 1/16	2 1/16	1 1/16	23.0
84	84H300SF	13.369	—	J-3	SF	1/2 - 2 15/16	3/16	1 1/16	2 1/16	1 1/16	30.0
96	96H300E	15.279	—	H-3	E	7/8 - 3 1/2	0	7/8	2 3/8	7/8	38.0
120	120H300E	19.099	—	H-3	E	7/8 - 3 1/2	0	7/8	2 3/8	7/8	51.0

Dimensions in inches. Weight in pounds
Pulley O.D. = P.D. - .054"
*Reverse mount only

H300 For Belts 3" Wide (1/2" Pitch) Taper Bushed Type

F = 3 3/8

No. Teeth	Part Number	Pitch Diam.	Max. FL. O.D.	Type	Bush	Bore Range	Dimensions			Wt. Less Bush.
							E	L	M	
18	TB18H300	2.865	3 3/64	KF-1	1215	1/2 - 1 1/4	1 5/16	1 1/2	1 9/16	2.6
20	TB20H300	3.183	3 7/16	KF-1	1215	1/2 - 1 1/4	1 5/16	1 1/2	1 9/16	3.9
22	TB22H300	3.501	3 3/4	KF-1	1615	1/2 - 1 1/2	1 5/16	1 1/2	1 9/16	4.0
24	TB24H300	3.820	4 1/16	KF-1	2012	1/2 - 2	1 1/16	1 1/4	1 1/16	4.3
26	TB26H300	4.138	4 25/64	KF-1	2012	1/2 - 2	1 1/16	1 1/4	1 1/16	5.4
28	TB28H300	4.456	4 49/64	KF-1	2012	1/2 - 2	1 1/16	1 1/4	1 1/16	6.8
30	TB30H300	4.775	5 1/64	KF-1	2012	1/2 - 2	1 1/16	1 1/4	1 1/16	7.5
32	TB32H300	5.093	5 21/64	KF-1	2517	1/2 - 2 1/2	1 3/16	1 3/4	1 9/16	7.4
40	TB40H300	6.366	6 37/64	KF-1	2517	1/2 - 2 1/2	1 3/16	1 3/4	1 9/16	12.1
48	TB48H300	7.639	8 1/64	KF-1	3020	7/8 - 3	1 1/16	2	1 11/16	16.3
60	TB60H300	9.549	—	A-2	3020	7/8 - 3	3/16	2	3/16	17.3

Dimensions in inches. Weight in pounds
Pulley O.D. = P.D. - .054"

XH

7/8" Pitch

Stock Timing Pulleys

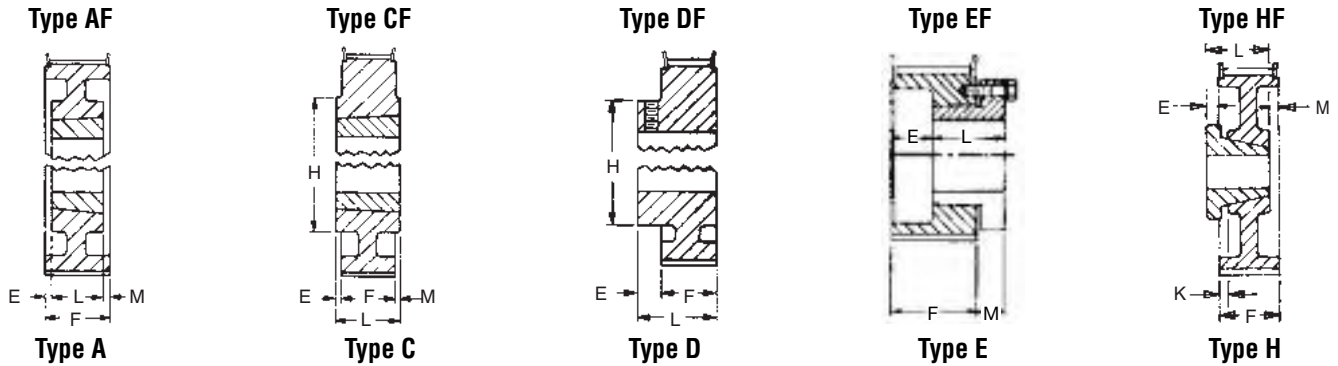

Dash 1 = Solid Style

Dash 2 = Web Style

Dash 3 = Arm/Spoke Style

"F" in type description indicates flanged.

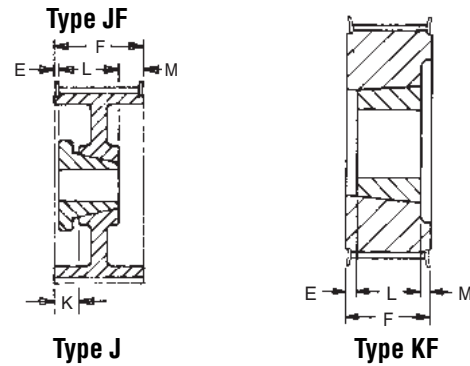

XH — 7/8" Pitch

XH200 For Belts 2" Wide (7/8" Pitch)
Minimum Plain Bore

F = 2 9/16

No. Teeth	Part Number	Pitch Diam.	Max. FL O.D.	Type	Bore		Dimensions			Wt.
					Stk.	Max.	E	H	L	
18	18XH200	5.013	5 57/64	DF-1	1	2 9/16	7/8	3 1/16	3 3/16	12.0
20	20XH200	5.570	6 6/64	DF-1	1	3 1/4	1	4 1/8	3 3/16	16.0

Dimensions in inches. Weight in pounds
Pulley O.D. = P.D. - .11"

XH200 For Belts 2" Wide (7/8" Pitch)
Taper Bushed Type

F = 2 9/16

No. Teeth	Part Number	Pitch Diam.	Max. FL O.D.	Type	Bush	Bore Range	Dimensions				Wt. Less Bush.
							E	H	L	M	
22	TB22XH200	6.127	6 19/32	KF-1	2517	1/2 - 2 1/2	1 1/16	—	1 3/4	—	10.6
24	TB24XH200	6.685	7 7/32	KF-1	3020	3/8 - 3	9/16	—	2	—	11.3
26	TB26XH200	7.241	7 29/32	KF-1	3020	7/8 - 3	9/16	—	2	—	13.3
28	TB28XH200	7.799	8 1/64	CF-1	3535	1 1/16 - 3 1/2	1 1/16	6 1/2	3 3/8	—	13.5
30	TB30XH200	8.356	9 3/32	CF-1	3535	1 1/16 - 3 1/2	1 1/16	6 1/2	3 3/8	—	18.5
32	TB32XH200	8.913	9 39/64	CF-1	3535	1 1/16 - 3 1/2	1 1/16	6 1/2	3 1/2	—	21.5
40	TB40XH200	11.141	11 51/64	CF-1	4040	1 1/16 - 4	1 1/16	8 1/2	4	—	37.5
48	TB48XH200	13.369	—	C-2	4040	1 1/16 - 4	1 1/32	8 1/2	4	23 7/32	44.5
60	TB60XH200	16.711	—	C-3	4040	1 1/16 - 4	23/32	8 1/2	4	23 7/32	47.0

Dimensions in inches. Weight in pounds
Pulley O.D. = P.D. - .11"

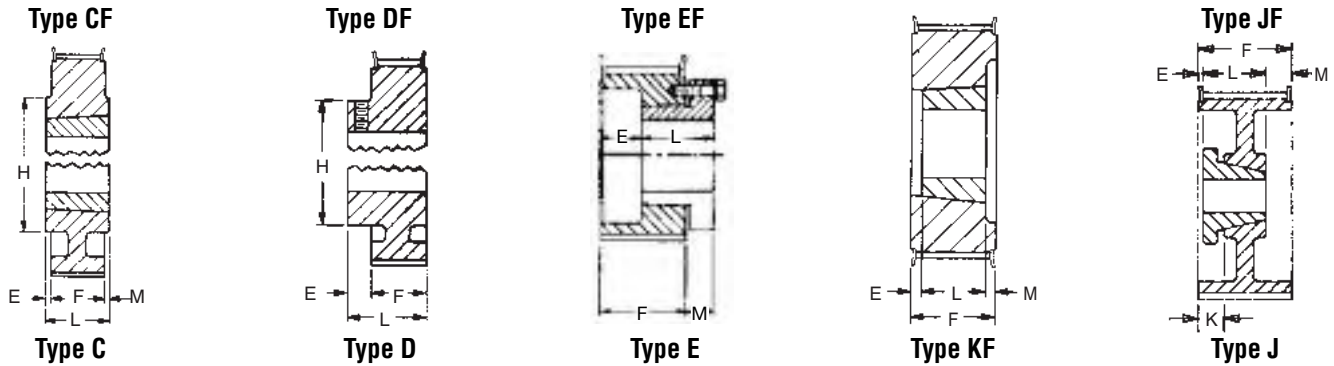

XH300 For Belts 3" Wide (7/8" Pitch) Minimum Plain Bore

F = 3 5/8

No. Teeth	Part Number	Pitch Diam.	Max. FL O.D.	Type	Bore		Dimensions				Wt.
					Stk.	Max.	E	H	L	M	
18	18XH300	5.013	5 3/64	DF-1	1	2 7/8	7/8	3 1/16	4 1/2	1*	15.0
20	20XH300	5.570	6 3/64	DF-1	1	3 1/4	1	4 3/8	4 3/8	3/4*	19.0

*Counterbore "M" depth on flush side.

XH300 For Belts 3" Wide (7/8" Pitch) Taper Bushed Type

F = 3 5/8

No. Teeth	Part Number	Pitch Diam.	Max. FL O.D.	Bore Type	Bush	Bore Range	Dimensions				Wt.
							E	H	L	M	
22	TB22XH300	6.127	6 1/32	KF-1	2517	1/2 - 2 1/2	1 9/16	—	1 3/4	1 5/16	13.6
24	TB24XH300	6.685	7 3/32	KF-1	3020	7/8 - 3	1 9/16	—	2	1 3/16	15.3
26	TB26XH300	7.241	7 29/32	KF-1	3020	7/8 - 3	1 9/16	—	2	1 3/16	17.3
28	TB28XH300	7.799	8 1/64	KF-1	3535	1 1/16 - 3 1/2	7/8	—	3 3/8	—	17.5
30	TB30XH300	8.356	9 1/32	KF-1	3535	1 1/16 - 3 1/2	7/8	—	3 3/8	—	22.5
32	TB32XH300	8.913	9 33/64	KF-1	3535	1 1/16 - 3 1/2	7/8	—	3 3/8	—	26.5
40	TB40XH300	11.141	11 9/64	CF-1	4040	1 1/16 - 4	7/8	7 3/4	4	—	43.5
48	TB48XH300	13.369	—	C-2	4040	1 1/16 - 4	3/16	8 1/2	4	3/16	51.5
60	TB60XH300	16.711	—	C-3	4040	1 1/16 - 4	3/16	8 1/2	4	3/16	55.5

XH400 For Belts 4" Wide (7/8" Pitch) QD Type

F = 4 1/16

No. Teeth	Part Number	Pitch Diam.	Max. FL O.D.	Type	Bush	Bore Range	Dimensions				Wt.
							E	K	L	M	
20	20XH400SK	5.570	6 3/32	JF-1	SK	1/2 - 2 1/2	1/2	1 3/16	1 1/16	2 1/4	12.4
22	22XH400SK	6.127	6 21/32	JF-1	SK	1/2 - 2 1/2	1/2	1 3/16	1 1/16	2 1/4	16.7
24	24XH400SF	6.685	7 3/32	JF-1	SF	1/2 - 2 1/8	1/2	1 3/16	2 1/16	2 3/16	19.2
26	26XH400SF	7.242	7 29/32	JF-1	SF	1/2 - 2 1/8	1/2	1 3/16	2 1/16	2 3/16	23.0
28	28XH400E	7.799	8 1/32	JF-1	E	7/8 - 3 1/2	2 1/32	1 17/32	2 3/8	1 13/32	24.0
30	30XH400E	8.356	8 39/32	JF-1	E	7/8 - 3 1/2	2 1/32	1 17/32	2 3/8	1 13/32	30.7
32	32XH400E	8.913	9 1/16	JF-1	E	7/8 - 3 1/2	2 1/32	1 17/32	2 3/8	1 13/32	34.0
40	40XH400F	11.141	11 11/16	HF-2	F	1 - 3 19/16	3/32	1 3/32	3 3/8	1 1/32	49.0
48	48XH400J	13.369	—	H-3	J	1 1/16 - 4 1/2	3/16	1	4 1/2	7/8	67.3
60	60XH400J	16.711	—	H-3	J	1 1/16 - 4 1/2	7/16	3/4	4 1/2	5/8	85.0
72	72XH400J	20.054	—	H-3	J	1 1/16 - 4 1/2	7/16	3/4	4 1/2	5/8	108.0
84	84XH400J	23.396	—	H-3	J	1 1/16 - 4 1/2	7/16	3/4	4 1/2	5/8	119.0
96	96XH400J	26.738	—	H-3	J	1 1/16 - 4 1/2	7/16	3/4	4 1/2	5/8	187.5
120	120XH400J	33.423	—	H-3	J	1 1/16 - 4 1/2	7/16	3/4	4 1/2	5/8	187.5

Dimensions in inches. Weight in pounds
Pulley O.D. = P.D. - .11"

Stock Drive Selection

STOCK DRIVE SELECTION

The following information is required:

1. HORSEPOWER AND TYPE OF DRIVER.
2. THE RPM OF THE DRIVER.
3. THE RPM OF THE DRIVEN MACHINE.
4. THE SHAFT DIAMETERS AND KEYSEAT DIMENSIONS.
5. THE EXACT OR APPROXIMATE CENTER DISTANCE REQUIRED.
6. OPERATING CONDITIONS OF DRIVE.

A typical example.

1. The driver is a 10hp squirrel cage, NEMA design “A” AC electrical motor.
2. The speed of the driver motor is 3600 rpm (3500 rpm full load speed.)
3. A centrifugal pump is to be driven at 2450 rpm.
4. Both the motor shaft and pump shaft are 1 $\frac{3}{8}$ ” with standard keyseats.
5. The drive will require a 25” to 27” center distance.
6. The drive is operated intermittently with the full 10 hp required.

SELECTION PROCEDURE

Step 1 – Determine the Design Horsepower

Refer to Table 1 for the CLASS driver and to Table 2 for the TYPE driven machine. The CLASS in the Service Factors (Table 2) will correspond to the CLASS determined in the Driver Classification (Table 1). Check for any additional service factor required for unusual conditions — such as continuous operation and/or use of an idler.

Example: Table 1 places the driver as class 2, and Table 2 shows a centrifugal pump in class 2 to have a service factor of 1.7. We deduct 0.2 for intermittent service. Thus, the service factor is 1.5.

The **design horsepower** is found by multiplying the full load horsepower by the service factor. This is the horsepower for which you are going to select the drive. Thus, design horsepower = 10 × 1.5 or 15 hp.

Step 2 – Choose the Belt Pitch

Locate the rpm of the **faster** shaft from Table 3. Follow this line to the point where the design hp selected in Step 1 intersects this speed. The point at which the lines intersect indicates the recommended belt pitch for your drive.

Example: The table indicates that a $\frac{1}{2}$ inch pitch (H) belt should be selected.

Step 3 – Select the Drive

NOTE: If the driver speed is other than those shown (870, 1160, 1750, or 3500 rpm) in the Driver Speeds column of the Stock Drive Selections or a Speed Up drive is required, step 3 will not be used. Instead turn to “Other Speeds or Speed Up Drive Selection.” This selection procedure is slightly different from step 3, but the Stock Drive Selection

Tables can still be used.

- A. Turn to the Stock Drive Selection Tables for the belt pitch selected in Step 2.

Example: Since Step 2 indicated a $\frac{1}{2}$ inch pitch belt, we refer to H $\frac{1}{2}$ ” pitch.

- B. Find the rpm of your driver. Speeds shown in the Drive Selection Tables are full load motor rating.

Example: Driver is listed under 3500 rpm.

- C. Read down the driven rpm column until you find a speed nearest the required driven speed. Under the same column heading, you will find the horsepower capacity per inch of belt length. Read across to the left for the required driver and driven pulleys.

Example: We find that we have a choice of two drives, a 28 groove DriveR with a 40 groove DriveN, or a 21 groove DriveR with a 30 groove DriveN. Since the Drive Selection Table indicates that the 21 groove pulley is below the recommended minimum, our choice is reduced to the 28 groove DriveR and a basic horsepower of 15.74.

- D. Read across to the right for shaft centers nearest to those you require. The belt size is shown at the top of the center distance column.

Example: We find a center distance of 26.49 which is within the desired distance. Reading up this column we find the belt designated as 700H.

- E. Multiply the horsepower capacity per inch of belt width by the teeth in mesh (TIM) factor (where applicable) — this is found in the table at the bottom of the selection tables. This will give you the corrected horsepower per inch of belt width.

Example: There is no TIM factor for this application. Since no correction is necessary, the basic horsepower capacity per inch of belt width will remain 15.74.

- F. Divide the design horsepower found in Step 1B by the corrected horsepower found in Step 3E — this will give you a NOMINAL BELT WIDTH.

IF YOUR ANSWER CONTAINS A FRACTION, USE THE NEXT LARGER SIZE.

Example: The design horsepower divided by the horsepower per inch of belt width would be:

$$\frac{15}{15.74} = .95 \text{ Nominal Width} = \text{Use } 1.00" \text{ Belt}$$

Order *Martin*

- (1) — 28H100SDS Pulley
- (1) — SDS × 1 $\frac{3}{8}$ ” QD Bushing
- (1) — 40H100SK Pulley
- (1) SK × 1 $\frac{3}{8}$ ” QD Bushing

NOTE: Decision to use QD Bushings was arbitrary.

(A re-check of bore limits, number of teeth, and width from the Stock Pulley Dimensions shows all material is stock.)



Stock Drive Selection

BASIC SERVICE FACTORS

To find a basic service factor: First, determine the class of the DriveR (prime mover) in Table 1. Then, determine the basic service factor for the application in Table 2, in the same class as driveR.

Table 1
Drive R (prime mover)

Class of DriveR	Class I	Class II	Class III
Momentary Peak Load % of Rated Load	149%	150 to 249%	250 to 400%
AC Electric Motors Single Phase			All
Squirrel Cage NEMA Design A	3450 rpm 1750 rpm 1160 rpm 870 rpm	40 hp up 100 hp up 15 hp up 5 hp up	1 1/2 thru 30 hp 5 thru 75 hp 3/4 thru 10 hp 1/2 thru 3 hp
NEMA Design B	3450 rpm 1750 rpm 1160 rpm 870 rpm	5 hp up 5 hp up 5 hp up 2 hp up	1 1/2 thru 3 hp 1 thru 3 hp 3/4 thru 3 hp 1/2 thru 1 1/2 hp
NEMA Design C	1750 rpm 1160 rpm 870 rpm	15 hp up 7 1/2 hp up All	5 thru 10 hp 3 and 5 hp
NEMA Design D			All
NEMA Design F	All		
Wound Rotor			
	1750 rpm 1160 rpm 870 rpm	20 hp 15 hp 7 1/2 hp	2 to 15 hp 2 to 10 hp 1 to 5 hp
Synchronous		Normal Torque	High Torque
D.C. ELECTRIC MOTORS	Shunt	Compound	Series
ENGINES Internal combustion	8 Cyl. up	6 Cyl.	4 Cyl. or less
HYDRAULIC MOTORS, LINE SHAFTS			All

ADDITIONAL SERVICE FACTORS FOR SPEED-UP DRIVES

For speed-up drives, add to the basic service factor the additional factor given at right.

Speed-Up Ratio Range	Add'l Factor
1.00 to 1.24	None
1.25 to 1.74	.10
1.75 to 2.49	.20
2.50 to 3.49	.30
3.50 & Over	.40

FOR UNUSUAL CONDITIONS

For 24-hour continuous operation and/or use of an idler, add 0.2 to basic service factor. For intermittent or seasonal operation, deduct 0.2 from basic service factor.

Additional service factors are required for unusual conditions — such as load reversal, heavy stock, plugged motor stop, electric brake. These should be determined by a transmission specialist.

TABLE 2.

Basic Service Factors of
Driven Machines

	Class I	Class II	Class III	
agitators, mixers (paddle or propeller)	liquid	1.4	1.6	1.8
	semiliquid	1.5	1.7	1.9
bakery machinery dough mixers	1.4	1.6	1.8	
brick and clay machinery augers, mixers, granulators pug mills	1.5	1.7	1.9	
	1.8	2.0	2.2	
centrifuges	1.7	1.9	—	
compressors reciprocating centrifugal	2.0	2.2	2.4	
	1.6	1.7	1.8	
conveyors belt, light package; oven belt; ore, coal, sand apron, bucket, elevator, pan flight, screw	1.3	1.5	1.7	
	1.6	1.7	1.8	
	1.7	1.8	1.9	
	1.7	1.9	2.0	
fans, blowers centrifugal, induced draft exhausters propeller, mine fans, positive blowers	1.6	1.8	2.0	
	1.8	2.0	2.2	
generators and exciters	1.6	1.8	2.0	
hammer mills	1.7	1.9	2.1	
hoists, elevators	1.6	1.8	2.0	
laundry machinery general extractors, washers	1.5	1.6	1.7	
	1.6	1.8	2.0	
line shafts	1.5	1.7	1.9	
machine tools drill presses, lathes, screw machines boring mills, grinders milling machines, shapers	1.4	1.6	1.8	
	1.5	1.7	1.9	
	1.5	1.7	1.9	
	1.5	1.7	1.9	
mills ball, rod, pebble, etc.	—	2.2	2.5	
paper machinery agitators, calenders, dryers beaters, jordans, Nash pumps, pulpers	1.4	1.6	1.8	
	1.7	1.9	2.1	
	1.4	1.6	1.8	
printing machinery presses; newspaper, rotary embossing, flat bed, magazine; linotype machines, cutters, folders	1.4	1.6	1.8	
	1.4	1.6	1.8	
	1.4	1.6	1.8	
pumps centrifugal, gear, rotary, pipeline reciprocating	1.5	1.7	1.9	
	2.0	2.2	2.4	
rubber plant machinery	1.6	1.8	2.0	
saw mill machinery	1.6	1.8	2.0	
screens vibrating (shakers), drum, conical	1.5	1.7	—	
	1.4	1.5	—	
textile machinery looms, spinning frames, twistors warpers, reels	1.6	1.8	2.0	
	1.5	1.7	—	
woodworking machinery lathes, band saws jointers, circular saws, planers	1.3	1.4	—	
	1.4	1.6	—	

XL 1/5" Pitch

Stock Drive Selection



speed ratio □	pulley combination				driveN speed and hp capacity						center distance, inches†				
	driveR		driveN		3500 rpm driveR speed		1750 rpm driveR speed		1160 rpm driveR speed		according to belt pitch length (PL), inches and corresponding code number (bold type)				
	code: no. of grooves	pitch diameter in.	code: no. of grooves	pitch diameter in.	driveN speed rpm	hp for 1 inch belt	driveN speed rpm	hp for 1 inch belt	driveN speed rpm	hp for 1 inch belt	PL: 6.00 30 teeth 60 XL	PL: 7.00 35 teeth 70 XL	PL: 8.00 40 teeth 80 XL	PL: 9.00 45 teeth 90 XL	PL: 10.00 50 teeth 100 XL
1.00	30 XL	1.910	30 XL	1.910	3500	2.11	1750	1.07	1160	.71	—	—	—	—	—
	28 XL	1.783	28 XL	1.783	3500	1.98	1750	1.00	1160	.66	—	—	—	—	2.20
	24 XL	1.528	24 XL	1.528	3500	1.71	1750	.86	1160	.56	—	—	—	2.10	2.60
	22 XL	1.401	22 XL	1.401	3500	1.57	1750	.79	1160	.52	—	—	1.80	2.30	2.80
	21 XL	1.337	21 XL	1.337	3500	1.49	1750	.75	1160	.50	—	—	1.90	2.40	2.90
	20 XL	1.273	20 XL	1.273	3500	1.42	1750	.72	1160	.46	—	—	2.00	2.50	3.00
	18 XL	1.146	18 XL	1.146	3500	1.28	1750	.64	1160	.42	—	1.70	2.20	2.70	3.20
	16 XL	1.019	16 XL	1.019	3500	1.15	1750	.58	1160	.38	1.40	1.90	2.40	2.90	3.40
	15 XL	.955	15 XL	.955	3500	1.07	1750	.53	1160	.36	1.50	2.00	2.50	3.00	3.50
	14 XL	.891	14 XL	.891	3500	1.00	1750	.50	1160	.33	1.60	2.10	2.60	3.10	3.60
	12 XL	.764	12 XL	.764	3500	.86	1750	.43	1160	.28	1.80	2.30	2.80	3.30	3.80
	11 XL	.700	11 XL	.700	3500	—	1750	.39	1160	.26	1.90 ^⑤	2.40 ^⑤	2.90 ^⑤	3.40 ^⑤	3.90 ^⑤
10 XL	.637	10 XL	.637	3500	—	1750	.36■	1160	.23	2.00 ^⑤	2.50 ^⑤	3.00 ^⑤	3.50 ^⑤	4.00 ^⑤	
1.05	21 XL	1.337	22 XL	1.401	3341	1.49	1675	.75	1107	.50	—	—	1.85	2.35	2.85
	20 XL	1.273	21 XL	1.337	3333	1.42	1667	.72	1105	.46	—	—	1.95	2.45	2.95
1.07	30 XL	1.910	32 XL	2.037	3281	2.11	1641	1.07	1088	.71	—	—	—	—	—
	28 XL	1.783	30 XL	1.910	3267	1.98	1634	1.00	1083	.66	—	—	—	—	2.09
	15 XL	.955	16 XL	1.019	3281	1.07	1641	.53	1088	.36	1.45	1.95	2.45	2.95	3.45
	14 XL	.891	15 XL	.955	3267	1.00	1634	.50	1083	.33	1.55	2.05	2.55	3.05	3.55
1.09	22 XL	1.401	24 XL	1.528	3208	1.57	1604	.79	1063	.52	—	—	—	2.19	2.69
	11 XL	.700	12 XL	.764	3208	—	1604	.39	1063	.26	1.85 ^⑤	2.35 ^⑤	2.85 ^⑤	3.35 ^⑤	3.85 ^⑤
1.10	20 XL	1.273	22 XL	1.401	3182	1.42	1591	.72	1055	.46	—	—	1.89	2.39	2.89
	10 XL	.637	11 XL	.700	3182	—	1591	.36■	1055	.23	1.95 ^④	2.45 ^④	2.95 ^④	3.45 ^④	3.95 ^④
1.11	18 XL	1.146	20 XL	1.273	3150	1.28	1575	.64	1044	.42	—	1.59	2.09	2.59	3.09
1.13	16 XL	1.019	18 XL	1.146	3111	1.15	1556	.58	1031	.38	—	1.79	2.29	2.79	3.29
1.14	28 XL	1.783	32 XL	2.037	3063	1.98	1532	1.00	1015	.66	—	—	—	—	—
	21 XL	1.337	24 XL	1.528	3063	1.49	1532	.75	1015	.50	—	—	1.74	2.24	2.74
	14 XL	.891	16 XL	1.019	3063	1.00	1532	.50	1015	.33	1.49	1.99	2.49	2.99	3.49
1.17	24 XL	1.528	28 XL	1.783	3000	1.71	1500	.86	994	.56	—	—	—	—	2.39
	18 XL	1.146	21 XL	1.337	3000	1.28	1500	.64	994	.42	—	1.54	2.04	2.54	3.04
	12 XL	.764	14 XL	.891	3000	.86	1500	.43	994	.28	1.69 ^⑤	2.19 ^⑤	2.69 ^⑤	3.19 ^⑤	3.69 ^⑤
1.20	30 XL	1.910	36 XL	2.292	2917	2.11	1458	1.07	967	.71	—	—	—	—	—
	20 XL	1.273	24 XL	1.528	2917	1.42	1458	.72	967	.46	—	—	1.79	2.29	2.79
	15 XL	.955	18 XL	1.146	2917	1.07	1458	.53	967	.36	1.34	1.84	2.34	2.84	3.34
	10 XL	.637	12 XL	.764	2917	—	1458	.36■	967	.23	1.89 ^④	2.39 ^④	2.89 ^④	3.39 ^④	3.89 ^④
1.22	18 XL	1.146	22 XL	1.401	2864	1.28	1432	.64	949	.42	—	—	1.99	2.49	2.99
1.25	24 XL	1.528	30 XL	1.910	2800	1.71	1400	.86	928	.56	—	—	—	—	2.29
	16 XL	1.019	20 XL	1.273	2800	1.15	1400	.58	928	.38	—	1.69	2.19	2.69	3.19
	12 XL	.764	15 XL	.955	2800	.86	1400	.43	928	.28	1.64 ^⑤	2.14 ^⑤	2.64 ^⑤	3.14 ^⑤	3.64 ^⑤

□ Pulley combinations shown are for conventional speed-reduction ratios; same table can be used for speed step-up ratios by making proper correction of driveN speed and belt hp capacity per inch width.

■ Pulley diameter is below recommended minimum; if used reduced belt life must be expected.

† Center distances shown are **theoretical**; manufacturing tolerances of belt length and pulley diameters can affect actual operating drive center distances.



Stock Drive Selection

XL 1/5" Pitch

center distance, inches†																speed ratio <input type="checkbox"/>
according to belt pitch length (PL), inches and corresponding code number (bold type)																
PL: 11.00 55 teeth 110 XL	PL: 12.00 60 teeth 120 XL	PL: 13.00 65 teeth 130 XL	PL: 14.00 70 teeth 140 XL	PL: 15.00 75 teeth 150 XL	PL: 16.00 80 teeth 160 XL	PL: 17.00 85 teeth 170 XL	PL: 18.00 90 teeth 180 XL	PL: 19.00 95 teeth 190 XL	PL: 20.00 100 teeth 200 XL	PL: 21.00 105 teeth 210 XL	PL: 22.00 110 teeth 220 XL	PL: 23.00 115 teeth 230 XL	PL: 24.00 120 teeth 240 XL	PL: 25.00 125 teeth 250 XL	PL: 26.00 130 teeth 260 XL	speed ratio <input type="checkbox"/>
2.50	3.00	3.50	4.00	4.50	5.00	5.50	6.00	6.50	7.00	7.50	8.00	8.50	9.00	9.50	10.00	
2.70	3.20	3.70	4.20	4.70	5.20	5.70	6.20	6.70	7.20	7.70	8.20	8.70	9.20	9.70	10.20	
3.10	3.60	4.10	4.60	5.10	5.60	6.10	6.60	7.10	7.60	8.10	8.60	9.10	9.60	10.10	10.60	
3.30	3.80	4.30	4.80	5.30	5.80	6.30	6.80	7.30	7.80	8.30	8.80	9.30	9.80	10.30	10.80	
3.40	3.90	4.40	4.90	5.40	5.90	6.40	6.90	7.40	7.90	8.40	8.90	9.40	9.90	10.40	10.90	
3.50	4.00	4.50	5.00	5.50	6.00	6.50	7.00	7.50	8.00	8.50	9.00	9.50	10.00	10.50	11.00	
3.70	4.20	4.70	5.20	5.70	6.20	6.70	7.20	7.70	8.20	8.70	9.20	9.70	10.20	10.70	11.20	
3.90	4.40	4.90	5.40	5.90	6.40	6.90	7.40	7.90	8.40	8.90	9.40	9.90	10.40	10.90	11.40	
4.00	4.50	5.00	5.50	6.00	6.50	7.00	7.50	8.00	8.50	9.00	9.50	10.00	10.50	11.00	11.50	
4.10	4.60	5.10	5.60	6.10	6.60	7.10	7.60	8.10	8.60	9.10	9.60	10.10	10.60	11.10	11.60	
4.30	4.80	5.30	5.80	6.30	6.80	7.30	7.80	8.30	8.80	9.30	9.80	10.30	10.80	11.30	11.80	
4.40 ^⑤	4.90 ^⑤	5.40 ^⑤	5.90 ^⑤	6.40 ^⑤	6.90 ^⑤	7.40 ^⑤	7.90 ^⑤	8.40 ^⑤	8.90 ^⑤	9.40 ^⑤	9.90 ^⑤	10.40 ^⑤	10.90 ^⑤	11.40 ^⑤	11.90 ^⑤	
4.50 ^⑤	5.00 ^⑤	5.50 ^⑤	6.00 ^⑤	6.50 ^⑤	7.00 ^⑤	7.50 ^⑤	8.00 ^⑤	8.50 ^⑤	9.00 ^⑤	9.50 ^⑤	10.00 ^⑤	10.50 ^⑤	11.00 ^⑤	11.50 ^⑤	12.00 ^⑤	1.05
3.35	3.85	4.35	4.85	5.35	5.85	6.35	6.85	7.35	7.85	8.35	8.85	9.35	9.85	10.35	10.85	
3.45	3.95	4.45	4.95	5.45	5.95	6.45	6.95	7.45	7.95	8.45	8.95	9.45	9.95	10.45	10.95	
2.39	2.89	3.39	3.89	4.40	4.90	5.40	5.90	6.40	6.90	7.40	7.90	8.40	8.90	9.40	9.90	1.07
2.59	3.09	3.59	4.10	4.60	5.10	5.60	6.10	6.60	7.10	7.60	8.10	8.60	9.10	9.60	10.10	
3.95	4.45	4.95	5.45	5.95	6.45	6.95	7.45	7.95	8.45	8.95	9.45	9.95	10.45	10.95	11.45	
4.05	4.55	5.05	5.55	6.05	6.55	7.05	7.55	8.05	8.55	9.05	9.55	10.05	10.55	11.05	11.55	1.09
3.19	3.69	4.20	4.70	5.20	5.70	6.20	6.70	7.20	7.70	8.20	8.70	9.20	9.70	10.20	10.70	
4.35 ^⑤	4.85 ^⑤	5.35 ^⑤	5.85 ^⑤	6.35 ^⑤	6.85 ^⑤	7.35 ^⑤	7.85 ^⑤	8.35 ^⑤	8.85 ^⑤	9.35 ^⑤	9.85 ^⑤	10.35 ^⑤	10.85 ^⑤	11.35 ^⑤	11.85 ^⑤	
3.39	3.89	4.40	4.90	5.40	5.90	6.40	6.90	7.40	7.90	8.40	8.90	9.40	9.90	10.40	10.90	1.10
4.45 ^④	4.95 ^④	5.45 ^④	5.95 ^④	6.45 ^④	6.95 ^④	7.45 ^④	7.95 ^④	8.45 ^④	8.95 ^④	9.45 ^④	9.95 ^④	10.45 ^④	10.95 ^④	11.45 ^④	11.95 ^④	
3.59	4.10	4.60	5.10	5.60	6.10	6.60	7.10	7.60	8.10	8.60	9.10	9.60	10.10	10.60	11.10	
3.79	4.30	4.80	5.30	5.80	6.30	6.80	7.30	7.80	8.30	8.80	9.30	9.80	10.30	10.80	11.30	1.11
2.49	2.99	3.49	3.99	4.49	4.99	5.49	5.99	6.49	6.99	7.49	7.99	8.49	8.99	9.49	9.99	
3.24	3.74	4.24	4.74	5.24	5.74	6.24	6.74	7.24	7.74	8.24	8.74	9.24	9.74	10.24	10.74	
4.00	4.50	5.00	5.50	6.00	6.50	7.00	7.50	8.00	8.50	9.00	9.50	10.00	10.50	11.00	11.50	1.14
2.89	3.39	3.89	4.39	4.89	5.39	5.89	6.39	6.89	7.39	7.89	8.39	8.89	9.39	9.89	10.39	
3.54	4.04	4.54	5.04	5.54	6.04	6.54	7.04	7.54	8.04	8.54	9.04	9.54	10.04	10.54	11.04	
4.20 ^⑤	4.70 ^⑤	5.20 ^⑤	5.70 ^⑤	6.20 ^⑤	6.70 ^⑤	7.20 ^⑤	7.70 ^⑤	8.20 ^⑤	8.70 ^⑤	9.20 ^⑤	9.70 ^⑤	10.20 ^⑤	10.70 ^⑤	11.20 ^⑤	11.70 ^⑤	1.17
—	2.69	3.19	3.69	4.19	4.69	5.19	5.69	6.19	6.69	7.19	7.69	8.19	8.69	9.19	9.69	
3.29	3.79	4.29	4.79	5.29	5.79	6.29	6.79	7.29	7.79	8.29	8.79	9.29	9.79	10.29	10.79	
3.84	4.34	4.84	5.34	5.84	6.34	6.84	7.34	7.84	8.34	8.84	9.34	9.84	10.34	10.84	11.34	1.20
4.40 ^④	4.90 ^④	5.40 ^④	5.90 ^④	6.40 ^④	6.90 ^④	7.40 ^④	7.90 ^④	8.40 ^④	8.90 ^④	9.40 ^④	9.90 ^④	10.40 ^④	10.90 ^④	11.40 ^④	11.90 ^④	
3.49	3.99	4.49	4.99	5.49	5.99	6.49	6.99	7.49	7.99	8.49	8.99	9.49	9.99	10.49	10.99	
2.79	3.29	3.79	4.29	4.79	5.29	5.79	6.29	6.79	7.29	7.79	8.29	8.79	9.29	9.79	10.29	1.22
3.69	4.19	4.69	5.19	5.69	6.19	6.69	7.19	7.69	8.19	8.69	9.19	9.69	10.19	10.69	11.19	
4.14 ^⑤	4.64 ^⑤	5.14 ^⑤	5.64 ^⑤	6.14 ^⑤	6.64 ^⑤	7.14 ^⑤	7.64 ^⑤	8.14 ^⑤	8.64 ^⑤	9.15 ^⑤	9.65 ^⑤	10.15 ^⑤	10.65 ^⑤	11.15 ^⑤	11.65 ^⑤	

Teeth in Mesh	F factor
6 or more	1.00
5	.80
4	.60
3	.40
2	.20

NOTE: Multiply the H.P. ratings shown in the Drive Section Tables by Factor "F" and the width correction factors shown below:

belt width	1/4	3/16	1/8	3/16	1/2	3/8	3/4	1	1 1/4	1 1/2	
width factor	.15	.21	.28	.35	.42	.57	.71	.86	1.0	1.29	1.56

If the number of teeth in mesh (TIM) is 5 or less, the exact TIM is indicated by the number in a circle following the center distance.

XL

1/5" Pitch

Stock Drive Selection

Martin

speed ratio □	pulley combination				driveN speed and hp capacity						center distance, inches†				
	driveR		driveN		3500 rpm driveR speed		1750 rpm driveR speed		1160 rpm driveR speed		according to belt pitch length (PL), inches and corresponding code number (bold type)				
	code: no. of grooves	pitch diameter in.	code: no. of grooves	pitch diameter in.	driveN speed rpm	hp for 1 inch belt	driveN speed rpm	hp for 1 inch belt	driveN speed rpm	hp for 1 inch belt	PL: 6.00 30 teeth 60 XL	PL: 7.00 35 teeth 70 XL	PL: 8.00 40 teeth 80 XL	PL: 9.00 45 teeth 90 XL	PL: 10.00 50 teeth 100 XL
1.27	22 XL	1.401	28 XL	1.783	2750	1.57	1375	.79	911	.52	—	—	—	1.99	2.49
	11 XL	.700	14 XL	.891	2750	—	1375	.39	911	.26	1.74 ^⑤	2.24 ^⑤	2.74 ^⑤	3.24 ^⑤	3.74 ^⑤
1.29	28 XL	1.783	36 XL	2.292	2722	1.98	1361	1.00	902	.66	—	—	—	—	—
	14 XL	.891	18 XL	1.146	2722	1.00	1361	.50	902	.33	1.39	1.89	2.39	2.89	3.39
1.31	16 XL	1.019	21 XL	1.337	2667	1.15	1333	.58	884	.38	—	1.64	2.14	2.64	3.14
1.33	30 XL	1.910	40 XL	2.546	2625	2.11	1313	1.07	870	.71	—	—	—	—	—
	24 XL	1.528	32 XL	2.037	2625	1.71	1313	.86	870	.56	—	—	—	—	2.18
	21 XL	1.337	28 XL	1.783	2625	1.49	1313	.75	870	.50	—	—	—	2.03	2.54
	18 XL	1.146	24 XL	1.528	2625	1.28	1313	.64	870	.42	—	—	1.89	2.39	2.89
	15 XL	.955	20 XL	1.273	2625	1.07	1313	.53	870	.36	—	1.74	2.24	2.74	3.24
1.36	12 XL	.764	16 XL	1.019	2625	.86	1313	.43	870	.28	1.59 ^⑤	2.09 ^⑤	2.59 ^⑤	3.09 ^⑤	3.59 ^⑤
	22 XL	1.401	30 XL	1.910	2567	1.57	1283	.79	851	.52	—	—	—	—	2.38
1.38	11 XL	.700	15 XL	.955	2567	—	1283	.38	851	.26	1.69 ^⑤	2.19 ^⑤	2.69 ^⑤	3.19 ^⑤	3.69 ^⑤
	16 XL	1.019	22 XL	1.401	2545	1.15	1273	.58	844	.38	—	1.58	2.09	2.59	3.09
1.40	30 XL	1.910	42 XL	2.674	2500	2.11	1250	1.07	829	.71	—	—	—	—	—
	20 XL	1.273	28 XL	1.783	2500	1.42	1250	.72	829	.46	—	—	—	2.08	2.58
	15 XL	.955	21 XL	1.337	2500	1.07	1250	.53	829	.36	—	1.68	2.19	2.69	3.19
	10 XL	.637	14 XL	.891	2500	—	1250	.36■	829	.23	1.79 ^④	2.29 ^④	2.79 ^④	3.29 ^④	3.79 ^④
1.43	28 XL	1.783	40 XL	2.546	2450	1.98	1225	1.00	812	.66	—	—	—	—	—
	21 XL	1.337	30 XL	1.910	2450	1.49	1225	.75	812	.50	—	—	—	1.92	2.43
	14 XL	.891	20 XL	1.273	2450	1.00	1225	.50	812	.33	—	1.79	2.29	2.79	3.29
1.45	22 XL	1.401	32 XL	2.037	2406	1.57	1203	.79	798	.52	—	—	—	—	2.27
	11 XL	.700	16 XL	1.019	2406	—	1203	.39	798	.26	1.64 ^⑤	2.14 ^⑤	2.64 ^⑤	3.14 ^⑤	3.64 ^⑤
1.47	30 XL	1.910	44 XL	2.801	2386	2.11	1193	1.07	791	.71	—	—	—	—	—
	15 XL	.955	22 XL	1.401	2386	1.07	1193	.53	791	.36	—	1.63	2.13	2.64	3.14
1.50	28 XL	1.783	42 XL	2.674	2334	1.98	1167	1.00	773	.66	—	—	—	—	—
	24 XL	1.528	36 XL	2.292	2334	1.71	1167	.86	773	.56	—	—	—	—	—
	20 XL	1.273	30 XL	1.910	2334	1.42	1167	.72	773	.46	—	—	—	1.97	2.48
	16 XL	1.019	24 XL	1.528	2334	1.15	1167	.58	773	.38	—	—	1.98	2.48	2.98
	14 XL	.891	21 XL	1.337	2334	1.00	1167	.50	773	.33	—	1.73	2.23	2.74	3.24
	12 XL	.764	18 XL	1.146	2334	.86	1167	.43	773	.28	1.48 ^⑤	1.99 ^⑤	2.49 ^⑤	2.99 ^⑤	3.49 ^⑤
1.52	10 XL	.637	15 XL	.955	2334	—	1167	.36■	773	.23	1.74 ^④	2.24 ^④	2.74 ^④	3.24 ^④	3.74 ^④
	21 XL	1.337	32 XL	2.037	2297	1.49	1148	.75	761	.50	—	—	—	—	2.32
1.56	18 XL	1.146	28 XL	1.783	2250	1.28	1125	.64	746	.42	—	—	—	2.17	2.68
1.57	28 XL	1.783	44 XL	2.801	2227	1.98	1114	1.00	738	.66	—	—	—	—	—
	14 XL	.891	22 XL	1.401	2227	1.00	1114	.50	738	.33	—	1.68	2.18	2.68	3.19
1.60	30 XL	1.910	48 XL	3.056	2188	2.11	1094	1.07	725	.71	—	—	—	—	—
	20 XL	1.273	32 XL	2.037	2188	1.42	1094	.72	725	.46	—	—	—	1.86	2.36
	15 XL	.955	24 XL	1.528	2188	1.07	1094	.53	725	.36	—	1.52	2.02	2.53	3.03
	10 XL	.637	16 XL	1.019	2188	—	1094	.36■	725	.23	1.68 ^④	2.19 ^④	2.69 ^④	3.19 ^④	3.69 ^④

□ Pulley combinations shown are for conventional speed-reduction ratios; same table can be used for speed step-up ratios by making proper correction of driveN speed and belt hp capacity per inch width.

■ Pulley diameter is below recommended minimum; if used reduced belt life must be expected.

† Center distances shown are **theoretical**; manufacturing tolerances of belt length and pulley diameters can affect actual operating drive center distances.



Stock Drive Selection

XL 1/5" Pitch

center distance, inches†															speed ratio □	
according to belt pitch length (PL), inches and corresponding code number (bold type)																
PL: 11.00 55 teeth 110 XL	PL: 12.00 60 teeth 120 XL	PL: 13.00 65 teeth 130 XL	PL: 14.00 70 teeth 140 XL	PL: 15.00 75 teeth 150 XL	PL: 16.00 80 teeth 160 XL	PL: 17.00 85 teeth 170 XL	PL: 18.00 90 teeth 180 XL	PL: 19.00 95 teeth 190 XL	PL: 20.00 100 teeth 200 XL	PL: 21.00 105 teeth 210 XL	PL: 22.00 110 teeth 220 XL	PL: 23.00 115 teeth 230 XL	PL: 24.00 120 teeth 240 XL	PL: 25.00 125 teeth 250 XL	PL: 26.00 130 teeth 260 XL	
2.99	3.49	3.99	4.49	4.99	5.49	5.99	6.49	6.99	7.49	7.99	8.49	8.99	9.49	9.99	10.49	1.27
4.24 ^⑤	4.74 ^⑤	5.24 ^⑤	5.74 ^⑤	6.24 ^⑤	6.74 ^⑤	7.24 ^⑤	7.74 ^⑤	8.24 ^⑤	8.74 ^⑤	9.25 ^⑤	9.75 ^⑤	10.25 ^⑤	10.75 ^⑤	11.25 ^⑤	11.75 ^⑤	
2.28	2.78	3.29	3.79	4.29	4.79	5.29	5.79	6.29	6.79	7.29	7.79	8.29	8.79	9.29	9.79	1.29
3.89	4.39	4.89	5.39	5.89	6.39	6.89	7.39	7.89	8.39	8.89	9.39	9.89	10.39	10.89	11.39	
3.64	4.14	4.64	5.14	5.64	6.14	6.64	7.14	7.64	8.14	8.64	9.14	9.64	10.14	10.64	11.14	1.31
—	2.48	2.98	3.48	3.98	4.48	4.99	5.49	5.99	6.49	6.99	7.49	7.99	8.49	8.99	9.49	1.33
2.68	3.19	3.69	4.19	4.69	5.19	5.69	6.19	6.69	7.19	7.69	8.19	8.69	9.19	9.69	10.19	
3.04	3.54	4.04	4.54	5.04	5.54	6.04	6.54	7.04	7.54	8.04	8.54	9.04	9.54	10.04	10.54	
3.39	3.89	4.39	4.89	5.39	5.89	6.39	6.89	7.39	7.89	8.39	8.89	9.39	9.89	10.39	10.89	
3.74	4.24	4.74	5.24	5.74	6.24	6.74	7.24	7.74	8.24	8.74	9.24	9.74	10.24	10.74	11.24	
4.09 ^⑤	4.59 ^⑤	5.09 ^⑤	5.59 ^⑤	6.09 ^⑤	6.59 ^⑤	7.09 ^⑤	7.59 ^⑤	8.09 ^⑤	8.59 ^⑤	9.09 ^⑤	9.59 ^⑤	10.09 ^⑤	10.59 ^⑤	11.09 ^⑤	11.59 ^⑤	
2.88	3.39	3.89	4.39	4.89	5.39	5.89	6.39	6.89	7.39	7.89	8.39	8.89	9.39	9.89	10.39	1.36
4.19 ^⑤	4.69 ^⑤	5.19 ^⑤	5.69 ^⑤	6.19 ^⑤	6.69 ^⑤	7.19 ^⑤	7.69 ^⑤	8.19 ^⑤	8.69 ^⑤	9.19 ^⑤	9.69 ^⑤	10.19 ^⑤	10.69 ^⑤	11.19 ^⑤	11.69 ^⑤	
3.59	4.09	4.59	5.09	5.59	6.09	6.59	7.09	7.59	8.09	8.59	9.09	9.59	10.09	10.59	11.09	1.38
—	—	2.87	3.37	3.88	4.38	4.88	5.38	5.88	6.38	6.88	7.39	7.89	8.39	8.89	9.39	1.40
3.09	3.59	4.09	4.59	5.09	5.59	6.09	6.59	7.09	7.59	8.09	8.59	9.09	9.59	10.09	10.59	
3.69	4.19	4.69	5.19	5.69	6.19	6.69	7.19	7.69	8.19	8.69	9.19	9.69	10.19	10.69	11.19	
4.29 ^④	4.79 ^④	5.29 ^④	5.79 ^④	6.29 ^④	6.79 ^④	7.29 ^④	7.79 ^④	8.29 ^④	8.79 ^④	9.29 ^④	9.79 ^④	10.29 ^④	10.79 ^④	11.29 ^④	11.79 ^④	
—	2.57	3.07	3.58	4.08	4.58	5.08	5.58	6.08	6.58	7.09	7.59	8.09	8.59	9.09	9.59	1.43
2.93	3.43	3.94	4.44	4.94	5.44	5.94	6.44	6.94	7.44	7.94	8.44	8.94	9.44	9.94	10.44	
3.79	4.29	4.79	5.29	5.79	6.29	6.79	7.29	7.79	8.29	8.79	9.29	9.79	10.29	10.79	11.29	
2.78	3.28	3.78	4.28	4.78	5.29	5.79	6.29	6.79	7.29	7.79	8.29	8.79	9.29	9.79	10.29	1.45
4.14 ^⑤	4.64 ^⑤	5.14 ^⑤	5.64 ^⑤	6.14 ^⑤	6.64 ^⑤	7.14 ^⑤	7.64 ^⑤	8.14 ^⑤	8.64 ^⑤	9.14 ^⑤	9.64 ^⑤	10.14 ^⑤	10.64 ^⑤	11.14 ^⑤	11.64 ^⑤	
—	—	2.76	3.27	3.77	4.27	4.77	5.28	5.78	6.28	6.78	7.28	7.78	8.28	8.78	9.28	1.47
3.64	4.14	4.64	5.14	5.64	6.14	6.64	7.14	7.64	8.14	8.64	9.14	9.64	10.14	10.64	11.14	
—	2.46	2.96	3.47	3.97	4.47	4.98	5.48	5.98	6.48	6.98	7.48	7.98	8.48	8.98	9.49	1.50
2.47	2.97	3.47	3.98	4.48	4.98	5.48	5.98	6.48	6.98	7.49	7.99	8.49	8.99	9.49	9.99	
2.98	3.48	3.98	4.48	4.99	5.49	5.99	6.49	6.99	7.49	7.99	8.49	8.99	9.49	9.99	10.49	
3.49	3.99	4.49	4.99	5.49	5.99	6.49	6.99	7.49	7.99	8.49	8.99	9.49	9.99	10.49	10.99	
3.74	4.24	4.74	5.24	5.74	6.24	6.74	7.24	7.74	8.24	8.74	9.24	9.74	10.24	10.74	11.24	
3.99 ^⑤	4.49 ^⑤	4.99 ^⑤	5.49 ^⑤	5.99 ^⑤	6.49 ^⑤	6.99 ^⑤	7.49 ^⑤	7.99 ^⑤	8.49 ^⑤	8.99 ^⑤	9.49 ^⑤	9.99 ^⑤	10.49 ^⑤	10.99 ^⑤	11.49 ^⑤	
4.24 ^④	4.74 ^④	5.24 ^④	5.74 ^④	6.24 ^④	6.74 ^④	7.24 ^④	7.74 ^④	8.24 ^④	8.74 ^④	9.24 ^④	9.74 ^④	10.24 ^④	10.74 ^④	11.24 ^④	11.74 ^④	
2.82	3.33	3.83	4.33	4.83	5.33	5.84	6.34	6.84	7.34	7.84	8.34	8.84	9.34	9.84	10.34	1.52
3.18	3.68	4.18	4.68	5.19	5.69	6.19	6.69	7.19	7.69	8.19	8.69	9.19	9.69	10.19	10.69	1.56
—	—	2.85	3.36	3.86	4.37	4.87	5.37	5.87	6.38	6.88	7.38	7.88	8.38	8.88	9.38	1.57
3.69	4.19	4.69	5.19	5.69	6.19	6.69	7.19	7.69	8.19	8.69	9.19	9.69	10.19	10.69	11.19	
—	—	—	3.04	3.55	4.06	4.56	5.06	5.57	6.07	6.57	7.07	7.57	8.08	8.58	9.08	1.60
2.87	3.37	3.88	4.38	4.88	5.38	5.88	6.38	6.88	7.39	7.89	8.39	8.89	9.39	9.89	10.39	
3.53	4.04	4.54	5.04	5.54	6.04	6.54	7.04	7.54	8.04	8.54	9.04	9.54	10.04	10.54	11.04	
4.19 ^④	4.69 ^④	5.19 ^④	5.69 ^④	6.19 ^④	6.69 ^④	7.19 ^④	7.69 ^④	8.19 ^④	8.69 ^④	9.19 ^④	9.69 ^④	10.19 ^④	10.69 ^④	11.19 ^④	11.69 ^④	

Teeth in Mesh	F factor
6 or more	1.00
5	.80
4	.60
3	.40
2	.20

NOTE: Multiply the H.P. ratings shown in the Drive Section Tables by Factor "F" and the width correction factors shown below:

belt width	1/4	5/16	3/8	7/16	1/2	5/8	3/4	7/8	1	1 1/4	1 1/2
width factor	.15	.21	.28	.35	.42	.57	.71	.86	1.0	1.29	1.56

If the number of teeth in mesh (TIM) is 5 or less, the exact TIM is indicated by the number in a circle following the center distance.

PULLEYS

XL

1/5" Pitch

Stock Drive Selection

Martin

speed ratio □	pulley combination				driveN speed and hp capacity						center distance, inches†				
	driveR		driveN		3500 rpm driveR speed		1750 rpm driveR speed		1160 rpm driveR speed		according to belt pitch length (PL), inches and corresponding code number (bold type)				
	code: no. of grooves	pitch diameter in.	code: no. of grooves	pitch diameter in.	driveN speed rpm	hp for 1 inch belt	driveN speed rpm	hp for 1 inch belt	driveN speed rpm	hp for 1 inch belt	PL: 6.00 30 teeth 60 XL	PL: 7.00 35 teeth 70 XL	PL: 8.00 40 teeth 80 XL	PL: 9.00 45 teeth 90 XL	PL: 10.00 50 teeth 100 XL
1.64	22 XL	1.401	36 XL	2.292	2139	1.57	1069	.79	709	.52	—	—	—	—	—
	11 XL	.700	18 XL	1.146	2139	—	1069	.39	709	.26	1.53 ^⑤	2.03 ^⑤	2.54 ^⑤	3.04 ^⑤	3.54 ^⑤
1.67	24 XL	1.528	40 XL	2.546	2100	1.71	1050	.86	696	.56	—	—	—	—	—
	18 XL	1.146	30 XL	1.910	2100	1.28	1050	.64	696	.42	—	—	—	2.06	2.57
	12 XL	.764	20 XL	1.273	2100	.86	1050	.43	696	.28	1.37 ^⑤	1.88 ^⑤	2.38 ^⑤	2.88 ^⑤	3.39 ^⑤
1.71	28 XL	1.783	48 XL	3.056	2042	1.98	1021	1.00	677	.66	—	—	—	—	—
	21 XL	1.337	36 XL	2.292	2042	1.49	1021	.75	677	.50	—	—	—	—	2.09
	14 XL	.891	24 XL	1.528	2042	1.00	1021	.50	677	.33	—	1.56	2.07	2.58	3.08
1.75	24 XL	1.528	42 XL	2.674	2000	1.71	1000	.86	663	.56	—	—	—	—	—
	16 XL	1.019	28 XL	1.783	2000	1.15	1000	.58	663	.38	—	—	1.75	2.26	2.77
	12 XL	.764	21 XL	1.337	2000	.86	1000	.43	663	.28	1.31 ^⑤	1.82 ^⑤	2.33 ^⑤	2.83 ^⑤	3.33 ^⑤
1.78	18 XL	1.146	32 XL	2.037	1969	1.28	984	.64	653	.42	—	—	—	1.94	2.46
1.80	20 XL	1.273	36 XL	2.292	1944	1.42	972	.72	644	.46	—	—	—	—	2.13
	10 XL	.637	18 XL	1.146	1944	—	972	.36 [■]	644	.23	1.57 ^④	2.08 ^④	2.58 ^④	3.09 ^④	3.59 ^④
1.82	22 XL	1.401	40 XL	2.546	1925	1.57	963	.79	637	.52	—	—	—	—	—
	11 XL	.700	20 XL	1.273	1925	—	963	.39	637	.26	1.42 ^④	1.92 ^④	2.43 ^④	2.93 ^④	3.43 ^⑤
1.83	24 XL	1.528	44 XL	2.801	1909	1.71	955	.86	633	.56	—	—	—	—	—
	12 XL	.764	22 XL	1.401	1909	.86	955	.43	633	.28	—	1.77 ^⑤	2.27 ^⑤	2.78 ^⑤	3.28 ^⑤
1.87	15 XL	.955	28 XL	1.783	1875	1.07	937	.53	621	.36	—	—	1.80	2.31	2.82
1.88	16 XL	1.019	30 XL	1.910	1867	1.15	933	.58	619	.38	—	—	—	2.15	2.66
1.90	21 XL	1.337	40 XL	2.546	1838	1.49	919	.75	609	.50	—	—	—	—	—
1.91	22 XL	1.401	42 XL	2.674	1833	1.57	917	.79	607	.52	—	—	—	—	—
	11 XL	.700	21 XL	1.337	1833	—	917	.39	607	.26	1.36 ^④	1.87 ^④	2.37 ^④	2.88 ^⑤	3.38 ^⑤
2.00	30 XL	1.910	60 XL	3.820	1750	2.11	875	1.07	580	.71	—	—	—	—	—
	24 XL	1.528	48 XL	3.056	1750	1.71	875	.86	580	.56	—	—	—	—	—
	22 XL	1.401	44 XL	2.801	1750	1.57	875	.79	580	.52	—	—	—	—	—
	21 XL	1.337	42 XL	2.674	1750	1.49	875	.75	580	.50	—	—	—	—	—
20 XL	1.273	40 XL	2.546	1750	1.42	875	.72	580	.46	—	—	—	—	—	
18 XL	1.146	36 XL	2.292	1750	1.28	875	.64	580	.42	—	—	—	—	2.22	
16 XL	1.019	32 XL	2.037	1750	1.15	875	.58	580	.38	—	—	—	2.03	2.54	
15 XL	.955	30 XL	1.910	1750	1.07	875	.53	580	.36	—	—	1.68	2.19	2.70	
2.10	14 XL	.891	28 XL	1.783	1750	1.00	875	.50	580	.33	—	—	1.84 ^⑤	2.35	2.86 ^⑤
	12 XL	.764	24 XL	1.528	1750	.86	875	.43	580	.28	—	1.65 ^④	2.16 ^④	2.67 ^⑤	3.17 ^⑤
	11 XL	.700	22 XL	1.401	1750	—	875	.39	580	.26	1.30 ^④	1.81 ^④	2.32 ^④	2.82 ^⑤	3.33 ^⑤
	10 XL	.637	20 XL	1.273	1750	—	875	.36 [■]	580	.23	1.46 ^④	1.97 ^④	2.48 ^④	2.98 ^④	3.48 ^④
2.13	21 XL	1.337	44 XL	2.801	1670	1.49	835	.75	554	.50	—	—	—	—	—
	20 XL	1.273	42 XL	2.674	1666	1.42	833	.72	552	.46	—	—	—	—	—
	10 XL	.637	21 XL	1.337	1666	—	833	.36 [■]	552	.23	1.40 ^④	1.91 ^④	2.42 ^④	2.92 ^④	3.43 ^④
2.13	15 XL	.955	32 XL	2.037	1641	1.07	820	.53	544	.36	—	—	—	2.07	2.59

□ Pulley combinations shown are for conventional speed-reduction ratios; same table can be used for speed step-up ratios by making proper correction of driveN speed and belt hp capacity per inch width.

■ Pulley diameter is below recommended minimum; if used reduced belt life must be expected.

† Center distances shown are **theoretical**; manufacturing tolerances of belt length and pulley diameters can affect actual operating drive center distances.



Stock Drive Selection

XL 1/5" Pitch

center distance, inches†															speed ratio □	
according to belt pitch length (PL), inches and corresponding code number (bold type)																
PL: 11.00 55 teeth 110 XL	PL: 12.00 60 teeth 120 XL	PL: 13.00 65 teeth 130 XL	PL: 14.00 70 teeth 140 XL	PL: 15.00 75 teeth 150 XL	PL: 16.00 80 teeth 160 XL	PL: 17.00 85 teeth 170 XL	PL: 18.00 90 teeth 180 XL	PL: 19.00 95 teeth 190 XL	PL: 20.00 100 teeth 200 XL	PL: 21.00 105 teeth 210 XL	PL: 22.00 110 teeth 220 XL	PL: 23.00 115 teeth 230 XL	PL: 24.00 120 teeth 240 XL	PL: 25.00 125 teeth 250 XL	PL: 26.00 130 teeth 260 XL	
2.56	3.06	3.57	4.07	4.57	5.08	5.58	6.08	6.58	7.08	7.58	8.08	8.58	9.08	9.59	10.09	1.64
4.04 ⁵	4.54 ⁵	5.04 ⁵	5.54 ⁵	6.04 ⁵	6.54 ⁵	7.04 ⁵	7.54 ⁵	8.04 ⁵	8.54 ⁵	9.04 ⁵	9.54 ⁵	10.04 ⁵	10.54 ⁵	11.04 ⁵	11.54 ⁵	
—	2.75	3.26	3.76	4.27	4.77	5.27	5.77	6.27	6.78	7.28	7.78	8.28	8.78	9.28	9.78	1.67
3.07	3.58	4.08	4.58	5.08	5.58	6.08	6.58	7.09	7.59	8.09	8.59	9.09	9.59	10.09	10.59	
3.89 ⁵	4.39 ⁵	4.89 ⁵	5.39 ⁵	5.89 ⁵	6.39 ⁵	6.89 ⁵	7.39 ⁵	7.89 ⁵	8.39 ⁵	8.89 ⁵	9.39 ⁵	9.89 ⁵	10.39 ⁵	10.89 ⁵	11.39 ⁵	
—	—	—	3.13	3.64	4.15	4.65	5.16	5.66	6.16	6.67	7.17	7.67	8.17	8.67	9.17	1.71
2.60	3.11	3.61	4.12	4.62	5.12	5.63	6.13	6.63	7.13	7.63	8.13	8.63	9.13	9.63	10.13	
3.58	4.08	4.58	5.09	5.59	6.09	6.59	7.09	7.59	8.09	8.59	9.09	9.59	10.09	10.59	11.09	
—	2.63	3.14	3.65	4.16	4.66	5.16	5.67	6.17	6.67	7.17	7.67	8.18	8.68	9.18	9.68	1.75
3.27	3.78	4.28	4.78	5.28	5.78	6.28	6.78	7.29	7.79	8.29	8.79	9.29	9.79	10.29	10.79	
3.83 ⁵	4.34 ⁵	4.84 ⁵	5.34 ⁵	5.84 ⁵	6.34 ⁵	6.84 ⁵	7.34 ⁵	7.84 ⁵	8.34 ⁵	8.84 ⁵	9.34 ⁵	9.84 ⁵	10.34 ⁵	10.84 ⁵	11.34 ⁵	
2.96	3.47	3.97	4.47	4.98	5.48	5.98	6.48	6.98	7.48	7.98	8.48	8.98	9.49	9.99	10.49	1.78
2.65	3.15	3.66	4.16	4.67	5.17	5.67	6.17	6.68	7.18	7.68	8.18	8.68	9.18	9.68	10.18	1.80
4.09 ⁴	4.59 ⁴	5.09 ⁴	5.69 ⁴	6.09 ⁴	6.59 ⁴	7.09 ⁴	7.59 ⁴	8.09 ⁴	8.59 ⁴	9.09 ⁴	9.59 ⁴	10.09 ⁴	10.59 ⁴	11.09 ⁴	11.59 ⁴	
2.32	2.84	3.35	3.85	4.36	4.86	5.36	5.87	6.37	6.87	7.37	7.87	8.38	8.88	9.38	9.88	1.82
3.94 ⁵	4.44 ⁵	4.94 ⁵	5.44 ⁵	5.94 ⁵	6.44 ⁵	6.94 ⁵	7.44 ⁵	7.94 ⁵	8.44 ⁵	8.94 ⁵	9.44 ⁵	9.94 ⁵	10.44 ⁵	10.94 ⁵	11.44 ⁵	
—	2.51	3.03	3.54	4.05	4.55	5.06	5.56	6.06	6.56	7.07	7.57	8.07	8.57	9.07	9.57	1.83
3.78 ⁵	4.28 ⁵	4.78 ⁵	5.29 ⁵	5.79 ⁵	6.29 ⁵	6.79 ⁵	7.29 ⁵	7.79 ⁵	8.29 ⁵	8.79 ⁵	9.29 ⁵	9.79 ⁵	10.29 ⁵	10.79 ⁵	11.29 ⁵	
3.32	3.82	4.33	4.83	5.33	5.83	6.33	6.83	7.33	7.83	8.34	8.84	9.34	9.84	10.34	10.84	1.87
3.16	3.67	4.17	4.67	5.18	5.68	6.18	6.68	7.18	7.68	8.18	8.68	9.18	9.69	10.19	10.69	1.88
2.37	2.88	3.39	3.90	4.40	4.91	5.41	5.91	6.42	6.92	7.42	7.92	8.42	8.93	9.43	9.93	1.90
—	2.72	3.23	3.74	4.25	4.75	5.26	5.76	6.26	6.77	7.27	7.77	8.27	8.77	9.27	9.77	1.91
3.88 ⁵	4.38 ⁵	4.89 ⁵	5.39 ⁵	5.89 ⁵	6.39 ⁵	6.89 ⁵	7.39 ⁵	7.89 ⁵	8.39 ⁵	8.89 ⁵	9.39 ⁵	9.89 ⁵	10.39 ⁵	10.89 ⁵	11.39 ⁵	
—	—	—	—	—	3.36	3.88	4.39	4.90	5.41	5.92	6.42	6.93	7.43	7.94	8.44	2.00
—	—	2.79	3.31	3.82	4.33	4.84	5.34	5.85	6.35	6.85	7.36	7.86	8.36	8.86	9.36	
—	2.60	3.12	3.63	4.14	4.64	5.15	5.65	6.16	6.66	7.16	7.66	8.17	8.67	9.17	9.67	
2.25	2.76	3.28	3.79	4.29	4.80	5.30	5.81	6.31	6.81	7.31	7.82	8.32	8.82	9.32	9.82	
2.41	2.93	3.44	3.94	4.45	4.95	5.46	5.96	6.46	6.97	7.47	7.97	8.47	8.97	9.47	9.98	
2.74	3.24	3.75	4.26	4.76	5.26	5.77	6.27	6.77	7.27	7.77	8.28	8.78	9.28	9.78	10.28	
3.05	3.56	4.06	4.57	5.07	5.57	6.07	6.58	7.08	7.58	8.08	8.58	9.08	9.58	10.08	10.58	
3.21	3.71	4.22	4.72	5.22	5.73	6.23	6.73	7.23	7.73	8.23	8.73	9.23	9.73	10.23	10.73	
3.37	3.87	4.37	4.88	5.38	5.88	6.38	6.88	7.38	7.88	8.38	8.88	9.38	9.89	10.39	10.89	
3.68 ⁵	4.18 ⁵	4.68 ⁵	5.18 ⁵	5.68 ⁵	6.18 ⁵	6.68 ⁵	7.19 ⁵	7.69 ⁵	8.19 ⁵	8.69 ⁵	9.19 ⁵	9.69 ⁵	10.19 ⁵	10.69 ⁵	11.19 ⁵	
3.83 ⁵	4.33 ⁵	4.83 ⁵	5.33 ⁵	5.84 ⁵	6.34 ⁵	6.84 ⁵	7.34 ⁵	7.84 ⁵	8.34 ⁵	8.84 ⁵	9.34 ⁵	9.84 ⁵	10.34 ⁵	10.84 ⁵	11.34 ⁵	
3.98 ⁴	4.48 ⁴	4.99 ⁴	5.49 ⁴	5.99 ⁴	6.49 ⁴	6.99 ⁴	7.49 ⁴	7.99 ⁴	8.49 ⁴	8.99 ⁴	9.49 ⁴	9.99 ⁴	10.49 ⁴	10.99 ⁴	11.49 ⁴	
—	2.64	3.16	3.67	4.18	4.69	5.19	5.70	6.20	6.71	7.21	7.71	8.21	8.71	9.22	9.72	2.10
2.29	2.81	3.32	3.83	4.34	4.84	5.35	5.85	6.36	6.86	7.36	7.86	8.37	8.87	9.37	9.87	
3.93 ⁴	4.43 ⁴	4.93 ⁴	5.43 ⁴	5.94 ⁴	6.44 ⁴	6.94 ⁴	7.44 ⁴	7.94 ⁴	8.44 ⁴	8.94 ⁴	9.44 ⁴	9.94 ⁴	10.44 ⁴	10.94 ⁴	11.44 ⁴	
3.10	3.60	4.11	4.61	5.12	5.62	6.12	6.62	7.12	7.63	8.13	8.63	9.13	9.63	10.13	10.63	2.13

Teeth in Mesh	F factor
6 or more	1.00
5	.80
4	.60
3	.40
2	.20

† Center distances shown are **theoretical**; manufacturing tolerances of belt length and pulley diameters can affect actual operating drive center distances.

NOTE: Multiply the H.P. ratings shown in the Drive Section Tables by Factor "F" and the width correction factors shown below:

belt width	¼	⅜	½	⅝	¾	1	1¼	1½			
width factor	.15	.21	.28	.35	.42	.57	.71	.86	1.0	1.29	1.56

If the number of teeth in mesh (TIM) is 5 or less, the exact TIM is indicated by the number in a circle following the center distance.

XL 1/5" Pitch

Stock Drive Selection

Martin

speed ratio □	pulley combination				driveN speed and hp capacity						center distance, inches†				
	driveR		driveN		3500 rpm driveR speed		1750 rpm driveR speed		1160 rpm driveR speed		according to belt pitch length (PL), inches and corresponding code number (bold type)				
	code: no. of grooves	pitch diameter in.	code: no. of grooves	pitch diameter in.	driveN speed rpm	hp for 1 inch belt	driveN speed rpm	hp for 1 inch belt	driveN speed rpm	hp for 1 inch belt	PL: 6.00 30 teeth 60 XL	PL: 7.00 35 teeth 70 XL	PL: 8.00 40 teeth 80 XL	PL: 9.00 45 teeth 90 XL	PL: 10.00 50 teeth 100 XL
2.14	28 XL	1.783	60 XL	3.820	1633	1.98	817	1.00	542	.66	—	—	—	—	—
	14 XL	.891	30 XL	1.910	1633	1.08	817	.50	542	.33	—	—	1.72 ^⑤	2.24 ^⑤	2.75
2.18	22 XL	1.401	48 XL	3.056	1604	1.57	802	.79	532	.52	—	—	—	—	—
	11 XL	.700	24 XL	1.528	1604	—	802	.39	532	.26	—	1.69 ^④	2.21 ^④	2.71 ^④	3.22 ^④
2.20	20 XL	1.273	44 XL	2.801	1591	1.42	795	.72	527	.46	—	—	—	—	—
	10 XL	.637	22 XL	1.401	1591	—	795	.36■	527	.23	1.34 ^③	1.86 ^④	2.36 ^④	2.87 ^④	3.37 ^④
2.22	18 XL	1.146	40 XL	2.546	1575	1.28	788	.64	523	.42	—	—	—	—	—
2.25	16 XL	1.019	36 XL	2.292	1556	1.15	778	.58	516	.38	—	—	—	—	2.31
2.29	21 XL	1.337	48 XL	3.056	1531	1.49	766	.75	508	.50	—	—	—	—	—
	14 XL	.891	32 XL	2.037	1531	1.00	766	.50	508	.33	—	—	—	2.12 ^⑤	2.63 ^⑤
2.33	18 XL	1.146	42 XL	2.674	1500	1.28	750	.64	498	.42	—	—	—	—	—
	12 XL	.764	28 XL	1.783	1500	.86	750	.43	498	.28	—	—	1.93 ^④	2.44 ^⑤	2.95 ^⑤
2.40	30 XL	1.910	72 XL	4.584	1458	2.11	729	1.07	483	.71	—	—	—	—	—
	20 XL	1.273	48 XL	3.056	1458	1.42	729	.72	483	.46	—	—	—	—	—
	15 XL	.955	36 XL	2.292	1458	1.07	729	.53	483	.36	—	—	—	—	2.35
	10 XL	.637	24 XL	1.528	1458	—	729	.36■	483	.23	—	1.74 ^④	2.25 ^④	2.76 ^④	3.27 ^④
2.44	18 XL	1.146	44 XL	2.801	1432	1.28	716	.64	475	.42	—	—	—	—	—
2.50	24 XL	1.528	60 XL	3.820	1400	1.71	700	.86	464	.56	—	—	—	—	—
	16 XL	1.019	40 XL	2.546	1400	1.15	700	.58	464	.38	—	—	—	—	2.05
	12 XL	.764	30 XL	1.910	1400	.86	700	.43	464	.28	—	—	1.80 ^④	2.32 ^④	2.84 ^⑤
2.55	11 XL	.700	28 XL	1.783	1375	—	688	.39	456	.26	—	—	1.97 ^④	2.49 ^④	3.00 ^④
2.57	28 XL	1.783	72 XL	4.584	1361	1.98	681	1.00	451	.66	—	—	—	—	—
	14 XL	.891	36 XL	2.292	1361	1.00	681	.50	451	.33	—	—	—	1.86 ^⑤	2.39 ^⑤
2.63	16 XL	1.019	42 XL	2.674	1333	1.15	666	.58	442	.38	—	—	—	—	—
2.67	18 XL	1.146	48 XL	3.056	1312	1.28	656	.64	435	.42	—	—	—	—	—
	15 XL	.955	40 XL	2.546	1312	1.07	656	.53	435	.36	—	—	—	—	2.09 ^⑤
	12 XL	.764	32 XL	2.037	1312	.86	656	.43	435	.28	—	—	1.67 ^④	2.20 ^④	2.72 ^⑤
2.73	22 XL	1.401	60 XL	3.820	1283	1.57	642	.79	425	.52	—	—	—	—	—
	11 XL	.700	30 XL	1.910	1283	—	642	.39	425	.26	—	—	1.85 ^④	2.37 ^④	2.88 ^④
2.75	16 XL	1.019	44 XL	2.801	1273	1.15	636	.58	422	.38	—	—	—	—	—
2.80	15 XL	.955	42 XL	2.674	1250	1.07	625	.53	414	.36	—	—	—	—	—
	10 XL	.637	28 XL	1.783	1250	—	625	.36■	414	.23	—	1.48 ^③	2.01 ^④	2.53 ^④	3.04 ^④
2.86	21 XL	1.337	60 XL	3.820	1225	1.49	613	.75	406	.50	—	—	—	—	—
	14 XL	.891	40 XL	2.546	1225	1.00	613	.50	406	.33	—	—	—	—	2.13 ^⑤
2.91	11 XL	.700	32 XL	2.037	1203	—	601	.39	399	.26	—	—	1.71 ^③	2.25 ^④	2.76 ^④
2.93	15 XL	.955	44 XL	2.801	1193	1.07	597	.53	396	.36	—	—	—	—	—

□ Pulley combinations shown are for conventional speed-reduction ratios; same table can be used for speed step-up ratios by making proper correction of driveN speed and belt hp capacity per inch width.

■ Pulley diameter is below recommended minimum; if used reduced belt life must be expected.

† Center distances shown are **theoretical**; manufacturing tolerances of belt length and pulley diameters can affect actual operating drive center distances.



Stock Drive Selection

XL 1/5" Pitch

center distance, inches†																speed ratio □
according to belt pitch length (PL), inches and corresponding code number (bold type)																
PL: 11.00 55 teeth 110 XL	PL: 12.00 60 teeth 120 XL	PL: 13.00 65 teeth 130 XL	PL: 14.00 70 teeth 140 XL	PL: 15.00 75 teeth 150 XL	PL: 16.00 80 teeth 160 XL	PL: 17.00 85 teeth 170 XL	PL: 18.00 90 teeth 180 XL	PL: 19.00 95 teeth 190 XL	PL: 20.00 100 teeth 200 XL	PL: 21.00 105 teeth 210 XL	PL: 22.00 110 teeth 220 XL	PL: 23.00 115 teeth 230 XL	PL: 24.00 120 teeth 240 XL	PL: 25.00 125 teeth 250 XL	PL: 26.00 130 teeth 260 XL	
—	—	—	—	—	3.44	3.96	4.48	4.99	5.50	6.01	6.52	7.02	7.53	8.03	8.53	2.14
3.26	3.76	4.27	4.77	5.27	5.77	6.27	6.78	7.28	7.78	8.28	8.78	9.28	9.78	10.28	10.78	
—	—	2.88	3.39	3.91	4.42	4.93	5.43	5.94	6.44	6.95	7.45	7.95	8.45	8.96	9.46	2.18
3.72 _⑤	4.23 _⑤	4.73 _⑤	5.23 _⑤	5.73 _⑤	6.23 _⑤	6.73 _⑤	7.23 _⑤	7.73 _⑤	8.24 _⑤	8.74 _⑤	9.24 _⑤	9.74 _⑤	10.24 _⑤	10.74 _⑤	11.24 _⑤	
—	2.69	3.20	3.72	4.23	4.73	5.24	5.74	6.25	6.75	7.26	7.76	8.26	8.76	9.26	9.77	2.20
3.88 _④	4.38 _④	4.88 _④	5.38 _④	5.88 _④	6.38 _④	6.88 _④	7.39 _④	7.89 _④	8.39 _④	8.89 _④	9.39 _④	9.89 _④	10.39 _④	10.89 _④	11.39 _④	
2.50	3.01	3.53	4.03	4.54	5.05	5.55	6.05	6.56	7.06	7.56	8.07	8.57	9.07	9.57	10.07	2.22
2.82	3.33	3.84	4.35	4.85	5.36	5.86	6.36	6.87	7.37	7.87	8.37	8.87	9.37	9.87	10.38	2.25
—	2.39	2.92	3.44	3.95	4.46	4.97	5.48	5.98	6.49	6.99	7.50	8.00	8.50	9.00	9.51	2.29
3.14	3.65	4.16	4.66	5.16	5.67	6.17	6.67	7.17	7.67	8.18	8.68	9.18	9.68	10.18	10.68	
2.37	2.89	3.41	3.92	4.43	4.94	5.44	5.95	6.45	6.95	7.46	7.96	8.46	8.96	9.46	9.97	2.33
3.46 _⑤	3.96 _⑤	4.47 _⑤	4.97 _⑤	5.47 _⑤	5.97 _⑤	6.48 _⑤	6.98 _⑤	7.48 _⑤	7.98 _⑤	8.48 _⑤	8.98 _⑤	9.48 _⑤	9.98 _⑤	10.48 _⑤	10.98 _⑤	
—	—	—	—	—	—	—	3.65	4.18	4.70	5.22	5.74	6.25	6.76	7.27	7.78	2.40
—	2.43	2.96	3.48	4.00	4.51	5.02	5.52	6.03	6.53	7.00	7.54	8.05	8.55	9.05	9.55	
2.87	3.38	3.89	4.39	4.90	5.40	5.91	6.41	6.91	7.42	7.92	8.42	8.92	9.42	9.92	10.42	
3.77 _④	4.27 _④	4.77 _④	5.28 _④	5.78 _④	6.28 _④	6.78 _④	7.28 _④	7.78 _④	8.28 _④	8.78 _④	9.28 _④	9.79 _④	10.29 _④	10.79 _④	11.29 _④	
2.24	2.77	3.29	3.81	4.32	4.82	5.33	5.84	6.34	6.85	7.35	7.85	8.35	8.86	9.36	9.86	2.44
—	—	—	—	3.08	3.61	4.14	4.65	5.17	5.68	6.19	6.70	7.20	7.71	8.22	8.72	2.50
2.58	3.10	3.61	4.12	4.63	5.14	5.64	6.15	6.65	7.15	7.66	8.16	8.66	9.16	9.67	10.17	
3.35 _⑤	3.85 _⑤	4.36 _⑤	4.86 _⑤	5.36 _⑤	5.87 _⑤	6.37 _⑤	6.87 _⑤	7.37 _⑤	7.87 _⑤	8.38 _⑤	8.88 _⑤	9.38 _⑤	9.88 _⑤	10.38 _⑤	10.88 _⑤	
3.50 _④	4.01 _⑤	4.51 _⑤	5.02 _⑤	5.52 _⑤	6.02 _⑤	6.52 _⑤	7.02 _⑤	7.53 _⑤	8.03 _⑤	8.53 _⑤	9.03 _⑤	9.53 _⑤	10.03 _⑤	10.53 _⑤	11.03 _⑤	2.55
—	—	—	—	—	—	—	3.73	4.26	4.79	5.31	5.83	6.34	6.85	7.36	7.87	2.57
2.91 _⑤	3.42	3.93	4.44	4.95	5.45	5.95	6.46	6.96	7.46	7.96	8.47	8.97	9.47	9.97	10.47	
2.45	2.98	3.50	4.01	4.52	5.03	5.53	6.04	6.54	7.05	7.55	8.05	8.56	9.06	9.56	10.06	2.63
—	2.51	3.04	3.57	4.08	4.60	5.11	5.61	6.12	6.63	7.13	7.64	8.14	8.64	9.15	9.65	2.67
2.62 _⑤	3.14	3.66	4.17	4.68	5.18	5.69	6.19	6.70	7.20	7.70	8.21	8.71	9.21	9.71	10.21	
3.23	3.74	4.25 _⑤	4.75 _⑤	5.26 _⑤	5.76 _⑤	6.26 _⑤	6.77 _⑤	7.27 _⑤	7.77 _⑤	8.27 _⑤	8.77 _⑤	9.27 _⑤	9.77 _⑤	10.28 _⑤	10.78 _⑤	
—	—	—	—	3.16	3.70	4.22	4.74	5.26	5.77	6.28	6.79	7.30	7.80	8.31	8.81	2.73
3.39 _④	3.90 _④	4.40 _⑤	4.91 _⑤	5.41 _⑤	5.91 _⑤	6.42 _⑤	6.92 _⑤	7.42 _⑤	7.92 _⑤	8.42 _⑤	8.93 _⑤	9.43 _⑤	9.93 _⑤	10.43 _⑤	10.93 _⑤	
2.32 _⑤	2.86	3.38	3.89	4.41	4.91	5.42	5.93	6.43	6.94	7.44	7.95	8.45	8.95	9.45	9.96	2.75
2.50 _⑤	3.02	3.54	4.05	4.56	5.07	5.58	6.08	6.59	7.09	7.60	8.10	8.60	9.11	9.61	10.11	2.80
3.55 _④	4.06 _④	4.56 _④	5.06 _④	5.57 _④	6.07 _④	6.57 _④	7.07 _④	7.57 _④	8.08 _④	8.58 _④	9.08 _④	9.58 _④	10.08 _④	10.58 _④	11.08 _④	
—	—	—	—	3.20	3.74	4.26	4.78	5.30	5.81	6.32	6.83	7.34	7.85	8.35	8.86	2.86
2.67 _⑤	3.19 _⑤	3.70 _⑤	4.21	4.72	5.23	5.74	6.24	6.74	7.25	7.75	8.25	8.76	9.26	9.76	10.26	
3.28 _④	3.79 _④	4.29 _④	4.80 _⑤	5.30 _⑤	5.81 _⑤	6.31 _⑤	6.81 _⑤	7.31 _⑤	7.82 _⑤	8.32 _⑤	8.82 _⑤	9.32 _⑤	9.82 _⑤	10.32 _⑤	10.82 _⑤	2.91
2.36 _⑤	2.90 _⑤	3.42	3.94	4.45	4.96	5.47	5.97	6.48	6.98	7.49	7.99	8.50	9.00	9.50	10.00	2.93

Teeth in Mesh	F factor
6 or more	1.00
5	.80
4	.60
3	.40
2	.20

NOTE: Multiply the H.P. ratings shown in the Drive Section Tables by Factor "F" and the width correction factors shown below:

belt width	1/4	5/16	3/8	7/16	1/2	5/8	3/4	7/8	1	1 1/4	1 1/2
width factor	.15	.21	.28	.35	.42	.57	.71	.86	1.0	1.29	1.56

If the number of teeth in mesh (TIM) is 5 or less, the exact TIM is indicated by the number in a circle following the center distance.

XL 1/5" Pitch

Stock Drive Selection



speed ratio □	pulley combination				driveN speed and hp capacity						center distance, inches†				
	driveR		driveN		3500 rpm driveR speed		1750 rpm driveR speed		1160 rpm driveR speed		according to belt pitch length (PL), inches and corresponding code number (bold type)				
	code: no. of grooves	pitch diameter in.	code: no. of grooves	pitch diameter in.	driveN speed rpm	hp for 1 inch belt	driveN speed rpm	hp for 1 inch belt	driveN speed rpm	hp for 1 inch belt	PL: 6.00 30 teeth 60 XL	PL: 7.00 35 teeth 70 XL	PL: 8.00 40 teeth 80 XL	PL: 9.00 45 teeth 90 XL	PL: 10.00 50 teeth 100 XL
3.00	24 XL	1.528	72 XL	4.584	1167	1.71	583	.86	387	.56	—	—	—	—	—
	20 XL	1.273	60 XL	3.820	1167	1.42	583	.72	387	.46	—	—	—	—	—
	16 XL	1.019	48 XL	3.056	1167	1.15	583	.58	387	.38	—	—	—	—	—
	14 XL	.891	42 XL	2.674	1167	1.00	583	.50	387	.33	—	—	—	—	1.99④
	12 XL	.764	36 XL	2.292	1167	.86	583	.43	387	.28	—	—	—	1.94④	2.48④
	10 XL	.637	30 XL	1.910	1167	—	583	.36■	387	.23	—	—	1.89③	2.41④	2.93④
3.14	14 XL	.891	44 XL	2.801	1114	1.00	557	.50	370	.33	—	—	—	—	—
3.20	15 XL	.955	48 XL	3.056	1094	1.07	547	.53	363	.36	—	—	—	—	—
	10 XL	.637	32 XL	2.037	1094	—	547	.36■	.363	.23	—	—	1.75③	2.29③	2.81③
3.27	22 XL	1.401	72 XL	4.584	1069	1.57	535	.79	355	.52	—	—	—	—	—
	11 XL	.700	36 XL	2.292	1069	—	535	.39	355	.26	—	—	—	1.98③	2.52④
3.33	18 XL	1.146	60 XL	3.820	1050	1.28	525	.64	348	.42	—	—	—	—	—
	12 XL	.764	40 XL	2.546	1050	.86	525	.43	348	.28	—	—	—	—	2.21④
3.43	21 XL	1.337	72 XL	4.584	1021	1.49	510	.75	338	.50	—	—	—	—	—
	14 XL	.891	48 XL	3.056	1021	1.00	510	.50	338	.33	—	—	—	—	—
3.50	12 XL	.764	42 XL	2.674	1000	.86	500	.43	331	.28	—	—	—	—	2.07④
3.60	20 XL	1.273	72 XL	4.584	972	1.42	486	.72	322	.46	—	—	—	—	—
	10 XL	.637	36 XL	2.292	972	—	486	.36■	322	.23	—	—	—	2.02③	2.56③
3.64	11 XL	.700	40 XL	2.546	963	—	481	.39	319	.26	—	—	—	—	2.25③
3.67	12 XL	.764	44 XL	2.801	955	.86	477	.43	316	.28	—	—	—	—	—
3.75	16 XL	1.019	60 XL	3.820	933	1.15	467	.58	309	.38	—	—	—	—	—
3.82	11 XL	.700	42 XL	2.674	917	—	458	.39	304	.26	—	—	—	—	2.11⑤
4.00	18 XL	1.146	72 XL	4.584	875	1.28	438	.64	290	.42	—	—	—	—	—
	15 XL	.955	60 XL	3.820	875	1.07	438	.53	290	.36	—	—	—	—	—
	12 XL	.764	48 XL	3.056	875	.86	438	.43	290	.28	—	—	—	—	—
	11 XL	.700	44 XL	2.801	875	—	438	.39	290	.26	—	—	—	—	1.96③
	10 XL	.637	40 XL	2.546	875	—	438	.36■	290	.23	—	—	—	—	2.29③
4.20	10 XL	.637	42 XL	2.674	832	—	416	.36■	276	.23	—	—	—	—	2.15③
4.29	14 XL	.891	60 XL	3.820	817	1.00	408	.50	270	.33	—	—	—	—	—
4.36	11 XL	.700	48 XL	3.056	802	—	401	.39	266	.26	—	—	—	—	—
4.40	10 XL	.637	44 XL	2.801	796	—	398	.36■	264	.23	—	—	—	—	1.99③
4.50	16 XL	1.019	72 XL	4.584	778	1.15	389	.58	258	.38	—	—	—	—	—
4.80	15 XL	.955	72 XL	4.584	730	1.07	365	.53	242	.36	—	—	—	—	—
	10 XL	.637	48 XL	3.056	730	—	365	.36■	242	.23	—	—	—	—	—
5.00	12 XL	.764	60 XL	3.820	700	.86	350	.43	232	.28	—	—	—	—	—
5.14	14 XL	.891	72 XL	4.584	681	1.00	340	.50	226	.33	—	—	—	—	—
5.45	11 XL	.700	60 XL	3.820	642	—	321	.39	213	.26	—	—	—	—	—
6.00	12 XL	.764	72 XL	4.584	584	.86	292	.43	193	.28	—	—	—	—	—
	10 XL	.637	60 XL	3.820	584	—	292	.36■	193	.23	—	—	—	—	—
6.55	11 XL	.755	72 XL	4.584	535	—	267	.39	177	.26	—	—	—	—	—
7.20	10 XL	.637	72 XL	4.584	486	—	243	.36■	161	.23	—	—	—	—	—

□ Pulley combinations shown are for conventional speed-reduction ratios; same table can be used for speed step-up ratios by making proper correction of driveN speed and belt hp capacity per inch width.

■ Pulley diameter is below recommended minimum; if used reduced belt life must be expected.

† Center distances shown are **theoretical**; manufacturing tolerances of belt length and pulley diameters can affect actual operating drive center distances.



Stock Drive Selection

XL 1/5" Pitch

center distance, inches†																speed ratio □
according to belt pitch length (PL), inches and corresponding code number (bold type)																
PL: 11.00 55 teeth 110 XL	PL: 12.00 60 teeth 120 XL	PL: 13.00 65 teeth 130 XL	PL: 14.00 70 teeth 140 XL	PL: 15.00 75 teeth 150 XL	PL: 16.00 80 teeth 160 XL	PL: 17.00 85 teeth 170 XL	PL: 18.00 90 teeth 180 XL	PL: 19.00 95 teeth 190 XL	PL: 20.00 100 teeth 200 XL	PL: 21.00 105 teeth 210 XL	PL: 22.00 110 teeth 220 XL	PL: 23.00 115 teeth 230 XL	PL: 24.00 120 teeth 240 XL	PL: 25.00 125 teeth 250 XL	PL: 26.00 130 teeth 260 XL	
—	—	—	—	—	—	3.34	3.89	4.43	4.96	5.48	6.00	6.52	7.03	7.54	8.05	3.00
—	—	—	—	3.24	3.78	4.31	4.83	5.34	5.86	6.37	6.88	7.39	7.89	8.40	8.90	
—	2.59 ^⑤	3.13	3.65	4.17	4.68	5.20	5.70	6.21	6.72	7.22	7.73	8.23	8.74	9.24	9.74	
2.54 ^⑤	3.07 ^⑤	3.58 ^⑤	4.10 ^⑤	4.61	5.12	5.62	6.13	6.64	7.14	7.64	8.15	8.65	9.15	9.65	10.16	
3.00 ^④	3.51 ^⑤	4.02 ^⑤	4.53 ^⑤	5.04 ^⑤	5.54 ^⑤	6.05 ^⑤	6.55 ^⑤	7.05 ^⑤	7.56 ^⑤	8.06 ^⑤	8.56 ^⑤	9.06 ^⑤	9.57 ^⑤	10.07 ^⑤	10.57 ^⑤	
3.44 ^④	3.94 ^④	4.45 ^④	4.95 ^④	5.46 ^④	5.96 ^④	6.46 ^④	6.97 ^④	7.47 ^④	7.97 ^④	8.47 ^④	8.97 ^④	9.47 ^④	9.98 ^④	10.48 ^④	10.98 ^④	
2.40 ^④	2.94 ^⑤	3.46 ^④	3.98 ^⑤	4.49	5.00	5.51	6.02	6.53	7.03	7.53	8.04	8.54	9.05	9.55	10.05	3.14
—	2.63 ^⑤	3.17 ^⑤	3.70	4.21	4.73	5.24	5.75	6.26	6.76	7.27	7.77	8.28	8.78	9.29	9.79	3.20
3.32 ^④	3.83 ^④	4.34 ^④	4.84 ^④	5.35 ^④	5.85 ^④	6.36 ^④	6.86 ^④	7.36 ^④	7.86 ^④	8.37 ^④	8.87 ^④	9.37 ^④	9.87 ^④	10.37 ^④	10.87 ^④	
—	—	—	—	—	—	3.42	3.97	4.51	5.04	5.57	6.09	6.60	7.12	7.63	8.14	3.27
3.04 ^④	3.56 ^④	4.07 ^④	4.58 ^④	5.08 ^④	5.59 ^④	6.09 ^⑤	6.60 ^⑤	7.10 ^⑤	7.60 ^⑤	8.11 ^⑤	8.61 ^⑤	9.11 ^⑤	9.61 ^⑤	10.11 ^⑤	10.62 ^⑤	
—	—	—	2.77	3.32	3.86	4.39	4.91	5.43	5.94	6.46	6.97	7.48	7.98	8.49	9.00	3.33
2.75 ^⑤	3.27 ^⑤	3.79 ^⑤	4.30 ^⑤	4.81 ^⑤	5.32 ^⑤	5.83 ^⑤	6.33 ^⑤	6.84 ^⑤	7.34 ^⑤	7.84 ^⑤	8.35 ^⑤	8.85 ^⑤	9.35 ^⑤	9.86 ^⑤	10.36 ^⑤	
—	—	—	—	—	—	3.46	4.01	4.55	5.08	5.61	6.13	6.65	7.16	7.67	8.18	3.43
—	2.67 ^④	3.21 ^⑤	3.74 ^⑤	4.26 ^⑤	4.77 ^⑤	5.28	5.79	6.30	6.81	7.32	7.82	8.33	8.83	9.33	9.84	
2.62 ^④	3.15 ^④	3.67 ^④	4.19 ^⑤	4.70 ^⑤	5.21 ^⑤	5.72 ^⑤	6.22 ^⑤	6.73 ^⑤	7.23 ^⑤	7.74 ^⑤	8.24 ^⑤	8.74 ^⑤	9.25 ^⑤	9.75 ^⑤	10.25 ^⑤	3.50
—	—	—	—	—	—	3.50	4.05	4.59	5.13	5.65	6.17	6.69	7.20	7.72	8.23	3.60
3.08 ^④	3.60 ^④	4.11 ^④	4.62 ^④	5.13 ^④	5.63 ^④	6.14 ^④	6.64 ^④	7.15 ^④	7.65 ^④	8.15 ^④	8.66 ^④	9.16 ^④	9.66 ^④	10.16 ^④	10.66 ^④	
2.79 ^④	3.32 ^④	3.83 ^④	4.35 ^④	4.86 ^④	5.37 ^④	5.87 ^④	6.38 ^④	6.88 ^④	7.39 ^④	7.89 ^④	8.39 ^④	8.90 ^④	9.40 ^④	9.90 ^④	10.40 ^④	3.64
2.48 ^④	3.02 ^④	3.55 ^④	4.07 ^④	4.58 ^④	5.09 ^④	5.60 ^④	6.11 ^④	6.62 ^④	7.12 ^④	7.63 ^④	8.13 ^④	8.64 ^④	9.14 ^④	9.64 ^④	10.14 ^④	3.67
—	—	—	2.84 ^⑤	3.40 ^⑤	3.94	4.47	5.00	5.52	6.03	6.55	7.06	7.57	8.07	8.58	9.09	3.75
2.66 ^④	3.19 ^④	3.71 ^④	4.23 ^④	4.74 ^④	5.25 ^④	5.76 ^④	6.27 ^④	6.77 ^④	7.28 ^④	7.78 ^④	8.29 ^④	8.79 ^④	9.29 ^④	9.80 ^④	10.30 ^④	3.82
—	—	—	—	—	—	3.57	4.13	4.68	5.21	5.74	6.26	6.78	7.29	7.81	8.32	4.00
—	—	—	2.88 ^④	3.44 ^⑤	3.99 ^⑤	4.52 ^⑤	5.04	5.56	6.08	6.59	7.10	7.61	8.12	8.63	9.13 ^⑤	
2.19 ^③	2.75 ^④	3.29 ^④	3.82 ^④	4.34 ^④	4.86 ^④	5.37 ^④	5.88 ^④	6.39 ^④	6.90 ^④	7.41 ^④	7.91 ^④	8.42 ^④	8.92 ^④	9.43 ^④	9.93 ^④	
2.52 ^③	3.06 ^④	3.59 ^④	4.11 ^④	4.63 ^④	5.14 ^④	5.65 ^④	6.16 ^④	6.66 ^④	7.17 ^④	7.67 ^④	8.18 ^④	8.68 ^④	9.19 ^④	9.69 ^④	10.19 ^④	
2.83 ^③	3.36 ^④	3.88 ^④	4.39 ^④	4.90 ^④	5.41 ^④	5.92 ^④	6.42 ^④	6.93 ^④	7.43 ^④	7.94 ^④	8.44 ^④	8.94 ^④	9.45 ^④	9.95 ^④	10.45 ^④	
2.70 ^③	3.23 ^③	3.76 ^④	4.27 ^④	4.79 ^④	5.30 ^④	5.81 ^④	6.31 ^④	6.82 ^④	7.32 ^④	7.83 ^④	8.33 ^④	8.84 ^④	9.34 ^④	9.84 ^④	10.35 ^④	4.20
—	—	—	2.92 ^④	3.48 ^④	4.03 ^⑤	4.56 ^⑤	5.08 ^⑤	5.60 ^⑤	6.12 ^⑤	6.63 ^⑤	7.15	7.66	8.16	8.67	9.18	4.29
2.23 ^③	2.79 ^③	3.34 ^④	3.86 ^④	4.39 ^④	4.90 ^④	5.42 ^④	5.93 ^④	6.44 ^④	6.95 ^④	7.45 ^④	7.96 ^④	8.46 ^④	8.97 ^④	9.47 ^④	9.98 ^④	4.36
2.59 ^③	3.11 ^③	3.63 ^④	4.15 ^④	4.67 ^④	5.18 ^④	5.69 ^④	6.20 ^④	6.71 ^④	7.21 ^④	7.72 ^④	8.22 ^④	8.73 ^④	9.23 ^④	9.74 ^④	10.24 ^④	4.40
—	—	—	—	—	3.06 ^④	3.65 ^⑤	4.21 ^⑤	4.76 ^⑤	5.29	5.82	6.34	6.86	7.38	7.89	8.41	4.50
—	—	—	—	—	3.10 ^④	3.69 ^④	4.25 ^④	4.80 ^④	5.33 ^④	5.86 ^④	6.39	6.91	7.42	7.94	8.45	4.80
2.26 ^③	2.83 ^③	3.38 ^③	3.91 ^③	4.43 ^④	4.95 ^④	5.46 ^④	5.97 ^④	6.48 ^④	6.99 ^④	7.50 ^④	8.00 ^④	8.51 ^④	9.01 ^④	9.52 ^④	10.02 ^④	
—	—	—	3.00 ^③	3.56 ^④	4.11 ^④	4.64 ^④	5.17 ^④	5.69 ^④	6.21 ^④	6.72 ^④	7.23 ^④	7.74 ^④	8.25 ^④	8.76 ^④	9.27 ^④	5.00
—	—	—	—	—	3.14 ^④	3.73 ^④	4.29 ^④	4.84 ^④	5.38 ^④	5.90 ^④	6.43 ^④	6.95 ^④	7.47 ^④	7.98 ^④	8.49 ^④	5.14
—	—	—	3.04 ^③	3.60 ^③	4.15 ^④	4.68 ^④	5.21 ^④	5.73 ^④	6.25 ^④	6.77 ^④	7.28 ^④	7.79 ^④	8.30 ^④	8.81 ^④	9.31 ^④	5.45
—	—	—	—	—	3.21 ^③	3.81 ^③	4.37 ^④	4.92 ^④	5.46 ^④	5.99 ^④	6.51 ^④	7.03 ^④	7.55 ^④	8.07 ^④	8.58 ^④	6.00
—	—	2.46 ^②	3.07 ^③	3.64 ^③	4.19 ^③	4.73 ^③	5.25 ^④	5.77 ^④	6.29 ^④	6.81 ^④	7.32 ^④	7.83 ^④	8.34 ^④	8.85 ^④	9.36 ^④	
—	—	—	—	—	3.25 ^③	3.84 ^③	4.41 ^③	4.96 ^③	5.50 ^④	6.03 ^④	6.56 ^④	7.08 ^④	7.60 ^④	8.11 ^④	8.63 ^④	6.55
—	—	—	—	—	3.28 ^②	3.88 ^③	4.45 ^③	5.00 ^③	5.54 ^③	6.07 ^③	6.60 ^④	7.12 ^④	7.64 ^④	8.16 ^④	8.67 ^④	7.20

Teeth in Mesh	F factor
6 or more	1.00
5	.80
4	.60
3	.40
2	.20

NOTE: Multiply the H.P. ratings shown in the Drive Section Tables by Factor "F" and the width correction factors shown below:

belt width	1/4	5/16	3/8	7/16	1/2	5/8	3/4	7/8	1	1 1/4	1 1/2
width factor	.15	.21	.28	.35	.42	.57	.71	.86	1.0	1.29	1.56

If the number of teeth in mesh (TIM) is 5 or less, the exact TIM is indicated by the number in a circle following the center distance.

L 3/8" Pitch

Stock Drive Selection



speed ratio □	pulley combination				driveN speed and hp capacity						center distance, inches†					
	driveR		driveN		3500 rpm driveR speed		1750 rpm driveR speed		1160 rpm driveR speed		according to belt pitch length (PL), inches and corresponding code number (bold type)					
	code: no. of grooves	pitch diameter in.	code: no. of grooves	pitch diameter in.	driveN speed rpm	hp for 1 inch belt	driveN speed rpm	hp for 1 inch belt	driveN speed rpm	hp for 1 inch belt	PL: 12.375 33 teeth 124 L	PL: 15.00 40 teeth 150 L	PL: 18.75 50 teeth 187 L	PL: 21.00 56 teeth 210 L	PL: 22.50 60 teeth 225 L	
1.00	48 L	5.730	48 L	5.730	3500	6.27	1750	4.06	1160	2.81	—	—	—	—	—	
	44 L	5.252	44 L	5.252	3500	6.12	1750	3.77	1160	2.59	—	—	—	—	—	
	40 L	4.775	40 L	4.775	3500	5.87	1750	3.47	1160	2.36	—	—	—	—	—	
	36 L	4.297	36 L	4.297	3500	5.52	1750	3.15	1160	2.14	—	—	—	—	—	
	32 L	3.820	32 L	3.820	3500	5.10	1750	2.83	1160	1.91	—	—	—	4.51	5.26	
	30 L	3.581	30 L	3.581	3500	4.86	1750	2.66	1160	1.79	—	—	—	4.88	5.63	
	28 L	3.342	28 L	3.342	3500	4.71	1750	2.49	1160	1.67	—	—	4.13	4.26	6.01	
	26 L	3.104	26 L	3.104	3500	4.35	1750	2.32	1160	1.56	—	—	4.51	5.63	6.38	
	24 L	2.865	24 L	2.865	3500	4.06	1750	2.15	1160	1.44	—	—	4.88	6.01	6.76	
	22 L	2.626	22 L	2.626	3500	3.77	1750	1.98	1160	1.32	—	3.38	5.26	6.39	7.31	
	21 L	2.507	21 L	2.507	3500	3.62	1750	1.89	1160	1.26	—	3.57	5.45	6.57	7.32	
	20 L	2.387	20 L	2.387	3500	3.46	1750	1.80	1160	1.20	—	3.76	5.53	6.76	7.51	
	19 L	2.268	19 L	2.268	3500	3.31	1750	1.71	1160	1.14	2.63	3.95	5.82	6.95	7.70	
	18 L	2.149	18 L	2.149	3500	3.15	1750	1.62	1160	1.08	2.82	4.13	6.01	7.14	7.89	
	17 L	2.029	17 L	2.029	3500	2.99	1750	1.54	1160	1.03	3.01	4.32	6.20	7.32	8.07	
	16 L	1.910	16 L	1.910	3500	2.83	1750	1.45	1160	.97	3.20	4.51	6.39	7.51	8.26	
	14 L	1.671	14 L	1.671	3500	2.49■	1750	1.27	1160	.85	3.57	4.89	6.76	7.89	8.64	
	12 L	1.432	12 L	1.432	3500	—	1750	1.09■	1160	.72	3.95	5.26	7.14	8.26	9.01	
	1.04	21 L	2.507	22 L	2.626	3342	3.62	1671	1.89	1108	1.26	—	3.48	5.35	6.48	7.23
	1.05	20 L	2.387	21 L	2.507	3333	3.46	1667	1.80	1105	1.20	—	3.66	5.54	6.67	7.42
19 L		2.268	20 L	2.387	3325	3.31	1663	1.71	1102	1.14	—	3.85	5.73	6.85	7.60	
1.06	18 L	2.149	19 L	2.268	3314	3.15	1657	1.62	1098	1.08	2.72	4.04	5.92	7.04	7.79	
	17 L	2.029	18 L	2.149	3305	2.99	1653	1.54	1096	1.03	2.91	4.23	6.10	7.23	7.98	
	16 L	1.910	17 L	2.029	3294	2.83	1647	1.45	1092	.97	3.10	4.42	6.29	7.42	8.17	
1.07	30 L	3.581	32 L	3.820	3281	4.86	1641	2.66	1087	1.79	—	—	—	4.69	5.44	
	28 L	3.342	30 L	3.581	3267	4.61	1633	2.49	1083	1.67	—	—	3.94	5.07	5.82	
1.08	26 L	3.104	28 L	3.342	3250	4.35	1625	2.32	1077	1.56	—	—	4.32	5.44	6.19	
	24 L	2.865	26 L	3.104	3231	4.06	1615	2.15	1071	1.44	—	—	4.69	5.82	6.57	
1.09	44 L	5.252	48 L	5.730	3208	6.12	1804	3.77	1063	2.59	—	—	—	—	—	
	22 L	2.626	24 L	2.865	3208	3.77	1604	1.98	1063	1.32	—	—	5.07	6.20	6.95	
1.10	40 L	4.775	44 L	5.252	3182	5.87	1591	3.47	1055	2.36	—	—	—	—	—	
	20 L	2.387	22 L	2.626	3182	3.46	1591	1.80	1055	1.20	—	3.57	5.45	6.57	7.32	
1.11	36 L	4.297	40 L	4.775	3150	5.52	1575	3.15	1044	2.14	—	—	—	—	—	
	19 L	2.268	21 L	2.507	3167	3.31	1583	1.71	1050	1.14	—	3.76	5.63	6.76	7.51	
	18 L	2.149	20 L	2.387	3150	3.15	1575	1.62	1044	1.08	—	3.94	5.82	6.95	7.70	
1.12	17 L	2.029	19 L	2.268	3132	2.99	1566	1.54	1038	1.03	2.82	4.13	6.01	7.14	7.89	
1.13	32 L	3.820	36 L	4.297	3111	5.10	1556	2.83	1031	1.91	—	—	—	—	4.88	
	16 L	1.910	18 L	2.149	3111	2.83	1556	1.45	1031	.97	—	4.32	6.20	7.32	8.07	
1.14	28 L	3.342	32 L	3.820	3063	4.61	1531	2.49	1015	1.67	—	—	—	4.88	5.63	
	21 L	2.507	24 L	2.865	3063	3.62	1531	1.89	1015	1.26	—	3.28	5.16	6.29	7.04	
	14 L	1.671	16 L	1.910	3036	2.49■	1531	1.27	1015	.85	3.38	4.70	6.57	7.70	8.45	
1.15	26 L	3.104	30 L	3.581	3033	4.35	1517	2.32	1005	1.56	—	—	4.12	5.25	6.00	
1.16	19 L	2.268	22 L	2.626	3023	3.31	1511	1.71	1002	1.14	—	3.66	5.54	6.66	7.41	

□ Pulley combinations shown are for conventional speed-reduction ratios; same table can be used for speed step-up ratios by making proper correction of driveN speed and belt hp capacity per inch width.

■ Pulley diameter is below recommended minimum; if used reduced belt life must be expected.

† Center distances shown are **theoretical**; manufacturing tolerances of belt length and pulley diameters can affect actual operating drive center distances.



Stock Drive Selection

L
3/8" Pitch

center distance, inches†															speed ratio □
according to belt pitch length (PL), inches and corresponding code number (bold type)															
PL: 24.00 64 teeth 240 L	PL: 25.50 68 teeth 255 L	PL: 27.00 72 teeth 270 L	PL: 28.50 76 teeth 285 L	PL: 30.00 80 teeth 300 L	PL: 32.25 86 teeth 322 L	PL: 34.50 92 teeth 345 L	PL: 36.75 98 teeth 367 L	PL: 39.00 104 teeth 390 L	PL: 42.00 112 teeth 420 L	PL: 45.00 120 teeth 450 L	PL: 48.00 128 teeth 480 L	PL: 51.00 136 teeth 510 L	PL: 54.00 144 teeth 540 L	PL: 60.00 160 teeth 600 L	
—	—	—	—	—	7.13	8.26	9.38	10.51	12.01	13.51	15.01	16.51	18.01	21.01	1.00
—	—	—	6.01	6.76	7.88	9.01	10.13	11.26	12.76	14.26	15.76	17.26	18.76	21.76	
—	5.26	6.01	6.76	7.51	8.63	9.76	10.88	12.01	13.51	15.01	16.51	18.01	19.51	22.51	
5.26	6.01	6.76	7.51	8.26	9.38	10.51	11.63	12.76	14.26	15.76	17.26	18.76	20.26	23.26	
6.01	6.76	7.51	8.26	9.01	10.14	11.26	12.39	13.51	15.01	16.51	18.01	19.51	21.01	24.01	1.05
6.38	7.13	7.88	8.63	9.39	10.51	11.64	12.76	13.89	15.39	16.89	18.39	19.89	21.39	24.39	
6.76	7.51	8.26	9.01	9.76	10.89	12.01	13.14	14.26	15.76	17.26	18.76	20.26	21.76	24.76	
7.13	7.88	8.63	9.39	10.14	11.26	12.39	13.51	14.64	16.14	17.64	19.14	20.64	22.14	25.14	
7.51	8.26	9.01	9.76	10.51	11.64	12.76	13.89	15.01	16.51	18.01	19.51	21.01	22.51	25.50	1.06
7.89	8.64	9.39	10.14	10.89	12.01	13.14	14.26	15.39	16.89	18.39	19.89	21.39	22.89	25.89	
8.07	8.82	9.57	10.32	11.07	12.20	13.32	14.45	15.57	17.07	18.57	20.08	21.58	23.08	26.08	
8.26	9.01	9.76	10.51	11.26	12.39	13.51	14.64	15.76	17.26	18.76	20.26	21.76	23.26	26.26	
8.54	9.20	9.95	10.70	11.45	12.57	13.70	14.82	15.95	17.45	18.95	20.45	21.95	23.45	26.45	1.07
8.64	9.39	10.14	10.89	11.64	12.76	13.89	15.01	16.14	17.64	19.14	20.64	22.14	23.64	26.64	
8.82	9.57	10.32	11.07	11.83	12.95	14.07	15.20	16.33	17.83	19.33	20.83	22.33	23.83	26.83	
9.01	9.76	10.51	11.26	12.01	13.14	14.26	15.39	16.51	18.01	19.51	21.01	22.51	24.01	27.01	
9.39	10.14	10.89	11.64	12.39	13.51	14.64	15.76	16.89	18.39	19.89	21.39	22.89	24.39	27.39	1.08
9.76	10.51	11.26	12.01	12.76	13.89	15.01	16.14	17.26	18.76	20.26	21.76	23.26	24.76	27.76	
7.98	8.73	9.48	10.23	10.98	12.11	13.23	14.36	15.48	16.98	18.48	19.98	21.48	22.98	25.98	
8.17	8.92	9.67	10.42	11.17	12.29	13.42	14.54	15.67	17.17	18.67	20.17	21.67	23.17	26.17	
8.35	9.11	9.86	10.61	11.36	12.48	13.61	14.73	15.86	17.36	18.86	20.36	21.86	23.36	26.36	1.09
8.54	9.29	10.04	10.79	11.54	12.67	13.79	14.92	16.04	17.54	19.04	20.54	22.04	23.54	26.55	
8.73	9.48	10.23	10.98	11.73	12.86	13.98	15.11	16.23	17.73	19.23	20.73	22.23	23.73	26.73	
8.92	9.67	10.42	11.17	11.92	13.04	14.17	15.29	16.42	17.92	19.42	20.92	22.42	23.92	26.92	
6.19	6.94	7.69	8.45	9.20	10.32	11.47	12.57	13.70	15.20	16.70	18.20	19.70	21.20	24.20	1.10
6.57	7.32	8.07	8.82	9.57	10.70	11.82	12.95	14.07	15.57	17.07	18.57	20.07	21.57	24.57	
6.95	7.70	8.45	9.20	9.95	11.07	12.20	13.32	14.45	15.95	17.45	18.95	20.45	21.95	24.95	
7.32	8.07	8.82	9.57	10.32	11.45	12.57	13.70	14.82	16.33	17.82	19.32	20.82	22.33	25.33	
—	—	—	—	6.38	7.50	8.63	9.76	10.88	12.38	13.88	15.38	16.88	18.38	21.39	1.11
7.70	8.45	9.20	9.95	10.70	11.82	12.95	14.07	15.20	16.70	18.20	19.70	21.20	22.70	25.70	
—	—	5.63	6.38	7.13	8.25	9.38	10.51	11.63	13.13	14.63	16.13	17.63	18.13	22.14	
8.07	8.82	9.57	10.32	11.07	12.20	13.33	14.45	15.58	17.07	18.57	20.08	21.58	23.08	26.08	
4.88	5.63	6.38	7.13	7.88	9.01	10.13	11.26	12.38	13.88	15.38	16.89	18.39	19.89	22.89	1.12
8.26	9.01	9.76	10.51	11.26	12.39	13.51	14.64	15.76	17.26	18.76	20.26	21.76	23.26	26.26	
8.45	9.20	9.95	10.70	11.45	12.57	13.70	14.82	15.95	17.45	18.95	20.45	21.95	23.45	26.45	
8.64	9.39	10.14	10.89	11.64	12.76	13.89	15.01	16.14	17.64	19.14	20.64	22.14	23.64	26.64	
5.63	6.38	7.14	7.88	8.63	9.76	10.88	12.01	13.13	14.63	16.13	17.64	19.14	20.64	23.64	1.13
8.82	9.57	10.32	11.07	11.83	12.95	14.07	15.20	16.33	17.83	19.32	20.82	22.33	23.83	26.83	
6.38	7.13	7.88	8.63	9.38	10.51	11.63	12.76	13.88	15.38	16.89	18.39	19.89	21.39	24.39	
7.79	8.54	9.29	10.04	10.79	11.92	13.04	14.17	15.29	16.79	18.29	19.79	21.29	22.79	25.79	
9.20	9.95	10.70	11.45	12.20	13.33	14.45	15.58	16.70	18.20	19.70	21.20	22.70	24.20	27.20	1.14
6.75	7.51	8.26	9.01	9.76	10.88	12.01	13.14	14.26	15.76	17.26	18.76	20.26	21.76	24.76	
8.16	8.91	9.67	10.42	11.17	12.29	13.42	14.54	15.67	17.17	18.67	20.17	21.67	23.17	26.17	
8.16	8.91	9.67	10.42	11.17	12.29	13.42	14.54	15.67	17.17	18.67	20.17	21.67	23.17	26.17	
8.16	8.91	9.67	10.42	11.17	12.29	13.42	14.54	15.67	17.17	18.67	20.17	21.67	23.17	26.17	1.16

Teeth in Mesh	F factor
6 or more	1.00
5	.80
4	.60
3	.40
2	.20

NOTE: Multiply the H.P. ratings shown in the Drive Section Tables by Factor "F" and the width correction factors shown below:

belt width	3/8	7/16	1/2	5/8	3/4	7/8	1	1 1/4	1 1/2	1 3/4	2	2 1/2	3
width factor	.28	.35	.42	.57	.71	.86	1.0	1.29	1.56	1.84	2.14	2.72	3.36

If the number of teeth in mesh (TIM) is 5 or less, the exact TIM is indicated by the number in a circle following the center distance.

PULLEYS

L 3/8" Pitch

Stock Drive Selection



speed ratio □	pulley combination				driveN speed and hp capacity						center distance, inches†				
	driveR		driveN		3500 rpm driveR speed		1750 rpm driveR speed		1160 rpm driveR speed		according to belt pitch length (PL), inches and corresponding code number (bold type)				
	code: no. of grooves	pitch diameter in.	code: no. of grooves	pitch diameter in.	driveN speed rpm	hp for 1 inch belt	driveN speed rpm	hp for 1 inch belt	driveN speed rpm	hp for 1 inch belt	PL: 12.375 33 teeth 124 L	PL: 15.00 40 teeth 150 L	PL: 18.75 50 teeth 187 L	PL: 21.00 56 teeth 210 L	PL: 22.50 60 teeth 225 L
1.17	24 L	2.865	28 L	3.342	3000	4.06	1500	2.15	994	1.44	—	—	4.50	5.63	6.38
	18 L	2.149	21 L	2.507	3000	3.15	1500	1.62	994	1.08	—	3.85	5.73	6.85	7.60
	12 L	1.432	14 L	1.671	3000	—	1500	1.09■	994	.72	3.76⑤	5.07⑤	6.95⑤	8.07⑤	8.83⑤
1.18	22 L	2.626	26 L	3.104	2962	3.77	1481	1.62	982	1.32	—	—	4.88	6.00	6.76
	17 L	2.029	20 L	2.387	2975	2.99	1483	1.54	986	1.03	2.72	4.04	5.91	7.04	7.79
1.19	16 L	1.910	19 L	2.263	2947	2.83	1474	1.45	977	.97	2.91	4.22	6.10	7.23	7.98
1.20	40 L	4.775	48 L	5.730	2917	5.87	1458	3.47	967	2.36	—	—	—	—	—
	30 L	3.581	36 L	4.297	2917	4.86	1458	2.66	967	1.79	—	—	—	4.30	5.06
	20 L	2.387	24 L	2.865	2917	3.46	1458	1.80	967	1.20	—	3.37	5.25	6.38	7.13
1.21	14 L	1.671	17 L	2.029	2882	2.49■	1441	1.27	955	.85	3.28	4.60	6.48	7.60	8.35
1.22	36 L	4.297	44 L	5.252	2864	5.52	1432	3.15	949	2.14	—	—	—	—	—
	18 L	2.149	22 L	2.626	2864	3.15	1432	1.62	949	1.08	—	3.75	5.63	6.76	7.51
1.23	26 L	3.104	32 L	3.820	2844	4.35	1422	2.32	943	1.56	—	—	—	5.06	5.81
	17 L	2.029	21 L	2.507	2833	2.99	1417	1.54	939	1.03	2.62	3.94	5.81	6.94	7.69
1.24	21 L	2.507	26 L	3.104	2827	3.62	1413	1.89	937	1.26	—	3.09	4.97	6.10	6.85
1.25	48 L	5.730	60 L	7.162	2800	6.27	1400	4.06	928	2.81	—	—	—	—	—
	32 L	3.820	40 L	4.775	2800	5.10	1400	2.83	928	1.91	—	—	—	—	—
	24 L	2.865	30 L	3.581	2800	4.06	1400	2.15	928	1.44	—	—	4.31	5.43	6.19
	16 L	1.910	20 L	2.387	2800	2.83	1400	1.45	928	.97	2.81	4.13	6.01	7.13	7.88
1.26	19 L	2.268	24 L	2.865	2770	3.31	1385	1.71	918	1.15	—	3.46	5.34	6.47	7.22
1.27	22 L	2.626	28 L	3.342	2750	3.77	1375	1.98	911	1.32	—	—	—	5.81	6.56
1.29	28 L	3.342	36 L	4.297	2722	4.61	1361	2.49	902	1.67	—	—	—	4.48	5.24
	17 L	2.029	22 L	2.626	2705	2.99	1352	1.54	896	1.03	—	3.84	5.72	6.85	7.60
	14 L	1.671	18 L	2.149	2722	2.49■	1361	1.27	902	.85	3.19	4.50	6.38	7.51	8.26
1.30	20 L	2.387	26 L	3.104	2692	3.46	1346	1.80	892	1.20	—	—	5.06	6.19	6.94
1.31	16 L	1.910	21 L	2.507	2666	2.83	1333	1.45	884	.97	2.71	4.03	5.91	5.04	7.79
1.33	36 L	4.297	48 L	5.730	2625	5.52	1313	3.15	870	2.14	—	—	—	—	—
	30 L	3.581	40 L	4.775	2625	4.86	1313	2.66	870	1.79	—	—	—	—	4.66
	24 L	2.865	32 L	3.820	2625	4.06	1313	2.15	870	1.44	—	—	4.10	5.24	5.99
	21 L	2.507	28 L	3.342	2625	3.62	1313	1.89	870	1.26	—	—	4.77	5.90	6.65
	18 L	2.149	24 L	2.865	2625	3.15	1313	1.62	870	1.08	—	3.55	5.44	6.56	7.31
	12 L	1.432	16 L	1.910	2625	—	1313	1.09■	870	.72	3.56⑤	4.88⑤	6.76⑤	7.88⑤	8.63⑤
1.36	44 L	5.252	60 L	7.162	2567	6.12	1283	3.77	851	2.59	—	—	—	—	—
	22 L	2.626	30 L	3.581	2567	3.77	1283	1.98	851	1.32	—	—	4.48	5.61	6.37
	14 L	1.671	19 L	2.268	2579	2.49■	1289	1.27	855	.85	3.09	4.41	6.28	7.41	8.18
1.37	19 L	2.268	26 L	3.104	2558	3.31	1279	1.71	848	1.14	—	3.26	5.15	6.28	7.03
1.38	32 L	3.820	44 L	5.252	2545	5.10	1273	2.83	844	1.91	—	—	—	—	—
	26 L	3.104	36 L	4.297	2528	4.35	1264	2.32	838	1.56	—	—	—	4.66	5.41
	16 L	1.910	22 L	2.626	2545	2.83	1273	1.45	844	.97	2.61	3.93	5.81	6.94	7.69
1.40	20 L	2.387	28 L	3.342	2500	3.46	1250	1.80	829	1.20	—	—	4.86	5.99	6.74

□ Pulley combinations shown are for conventional speed-reduction ratios; same table can be used for speed step-up ratios by making proper correction of driveN speed and belt hp capacity per inch width.

■ Pulley diameter is below recommended minimum; if used reduced belt life must be expected.

† Center distances shown are **theoretical**; manufacturing tolerances of belt length and pulley diameters can affect actual operating drive center distances.



Stock Drive Selection

L
3/8" Pitch

center distance, inches†															
according to belt pitch length (PL), inches and corresponding code number (bold type)															
PL: 24.00 64 teeth 240 L	PL: 25.50 68 teeth 255 L	PL: 27.00 72 teeth 270 L	PL: 28.50 76 teeth 285 L	PL: 30.00 80 teeth 300 L	PL: 32.25 86 teeth 322 L	PL: 34.50 92 teeth 345 L	PL: 36.75 98 teeth 367 L	PL: 39.00 104 teeth 390 L	PL: 42.00 112 teeth 420 L	PL: 45.00 120 teeth 450 L	PL: 48.00 128 teeth 480 L	PL: 51.00 136 teeth 510 L	PL: 54.00 144 teeth 540 L	PL: 60.00 160 teeth 600 L	speed ratio □
7.13	7.88	8.63	9.38	10.13	11.26	12.38	13.51	14.64	16.13	17.64	19.13	20.64	22.14	25.14	1.17
8.35	9.10	9.85	10.60	11.35	12.48	13.60	14.73	15.85	17.36	18.86	20.36	21.86	23.36	26.36	
9.57 ^⑤	10.32 ^⑤	11.07 ^⑤	11.83 ^⑤	12.58 ^⑤	13.70 ^⑤	14.83 ^⑤	15.95 ^⑤	17.08 ^⑤	18.57 ^⑤	20.08 ^⑤	21.58 ^⑤	23.08 ^⑤	24.58 ^⑤	27.58	
7.51	8.26	9.01	9.76	10.51	11.63	12.76	13.88	15.01	16.51	18.01	19.51	21.01	22.51	25.51	1.18
8.54	9.29	10.04	10.79	11.54	12.67	13.79	14.92	16.04	17.54	19.04	20.56	22.04	23.59	26.54	
8.73	9.48	10.23	10.98	11.73	12.86	13.98	15.10	16.23	17.73	19.23	20.73	22.23	23.73	26.73	1.19
—	—	—	5.99	6.74	7.87	9.00	10.12	11.25	12.75	14.25	15.75	17.25	18.76	21.76	1.20
5.81	6.56	7.31	8.06	8.81	9.94	11.07	12.19	13.32	14.82	16.32	17.82	19.32	20.82	23.82	
7.88	8.63	9.38	10.13	10.88	12.01	13.13	14.26	15.38	16.89	18.39	19.89	21.39	22.89	25.89	
9.10	9.85	10.60	11.35	12.11	13.23	14.36	15.48	16.61	18.11	19.61	21.11	22.61	24.11	27.11	1.21
—	5.23	5.99	6.74	7.49	8.62	9.75	10.87	12.00	13.50	15.00	16.50	18.01	19.51	22.51	1.22
8.26	9.01	9.76	10.51	11.26	12.39	13.51	14.64	15.76	17.26	18.76	20.26	21.76	23.26	26.26	
6.56	7.31	8.06	8.81	9.57	10.69	11.82	12.94	14.11	15.57	17.07	18.57	20.07	21.57	24.57	1.23
8.44	8.63	9.95	10.70	11.45	12.57	13.70	14.82	15.95	17.45	18.95	20.45	21.95	23.45	26.45	
7.60	8.35	9.10	9.85	10.60	11.73	12.85	13.98	15.10	16.60	18.10	19.60	21.11	22.60	25.61	1.24
—	—	—	—	—	—	7.45	8.58	9.36	10.86	12.36	13.87	15.37	16.87	19.87	1.25
5.29	5.99	6.74	7.49	8.25	9.37	10.50	11.62	12.75	14.25	15.75	17.26	18.76	20.26	23.26	
6.94	7.69	8.44	9.19	9.94	11.07	12.19	13.32	14.44	15.94	17.44	18.95	20.45	21.95	24.95	
8.63	9.38	10.13	10.88	11.64	12.76	13.89	15.01	16.13	17.64	19.14	20.64	22.14	23.64	26.64	
7.97	8.72	9.47	10.23	10.98	12.10	13.23	14.35	15.48	16.98	18.48	19.98	21.48	22.98	25.98	1.26
7.31	8.06	8.81	9.57	10.32	11.44	12.57	13.69	14.82	16.32	17.82	19.32	20.82	22.32	25.32	1.27
5.99	6.74	7.49	8.25	9.00	10.12	11.25	12.38	13.50	15.00	16.50	18.01	19.51	21.01	24.01	1.29
8.35	9.10	9.85	10.60	11.35	12.48	13.60	14.73	15.85	17.36	18.86	20.36	21.86	23.36	26.36	
9.01	9.76	10.51	11.26	12.01	13.14	14.26	15.39	16.51	18.01	19.51	21.01	22.51	24.01	27.01	
7.69	8.44	9.19	9.94	10.69	11.82	12.94	14.11	15.20	16.70	18.20	19.70	21.20	22.70	25.70	1.30
8.54	9.29	10.04	10.79	11.54	12.66	13.79	14.92	16.04	17.54	19.04	20.54	22.04	23.54	26.54	1.31
—	—	5.58	6.34	7.10	8.23	9.36	10.49	11.61	13.12	14.61	16.12	17.62	19.12	22.12	1.33
5.41	6.17	6.92	7.67	8.43	9.55	10.68	11.81	12.93	14.44	15.94	17.44	18.94	20.44	23.44	
6.74	7.49	8.25	9.00	9.75	10.88	12.00	13.13	14.25	15.75	17.26	18.76	20.26	21.76	24.76	
7.40	8.16	8.91	9.66	10.41	11.53	12.66	13.79	14.91	16.41	17.91	19.42	20.91	22.42	25.42	
8.06	8.82	9.57	10.32	11.07	12.19	13.32	14.45	15.57	17.07	18.57	20.07	21.57	23.07	26.07	
9.38 ^⑤	10.13 ^⑤	10.88 ^⑤	11.64 ^⑤	12.39 ^⑤	13.51 ^⑤	14.64 ^⑤	15.76 ^⑤	16.89 ^⑤	18.39 ^⑤	19.89 ^⑤	21.39 ^⑤	22.89 ^⑤	24.39 ^⑤	27.39 ^⑤	
—	—	—	—	—	—	7.45	8.58	9.79	11.22	12.72	14.23	15.73	17.23	20.24	1.36
7.12	7.87	8.62	9.37	10.13	11.25	12.38	13.50	14.63	16.13	17.63	19.13	20.63	22.13	25.13	
8.91	9.66	10.41	11.16	11.92	13.04	14.17	15.29	16.42	17.92	19.42	20.92	22.42	23.92	26.92	
7.78	8.53	9.28	10.03	10.79	11.92	13.04	14.16	15.29	16.79	18.29	19.79	21.29	22.79	25.79	1.37
—	5.58	6.34	7.10	7.85	8.98	10.11	11.24	12.36	13.87	15.37	16.87	18.37	19.89	22.88	1.38
6.17	6.92	7.67	8.43	9.18	10.31	11.43	12.56	13.68	15.19	16.69	18.19	19.69	21.19	24.19	
8.44	9.19	9.94	10.69	11.44	12.57	13.70	14.82	15.95	17.45	18.95	20.45	21.95	23.45	26.45	
7.49	8.25	9.00	9.75	10.50	11.63	12.75	13.88	15.00	16.51	18.01	19.51	21.01	22.51	25.51	1.40

Teeth in Mesh	F factor
6 or more	1.00
5	.80
4	.60
3	.40
2	.20

NOTE: Multiply the H.P. ratings shown in the Drive Section Tables by Factor "F" and the width correction factors shown below:

belt width	3/8	7/16	1/2	5/8	3/4	7/8	1	1 1/4	1 1/2	1 3/4	2	2 1/2	3
width factor	.28	.35	.42	.57	.71	.86	1.0	1.29	1.56	1.84	2.14	2.72	3.36

If the number of teeth in mesh (TIM) is 5 or less, the exact TIM is indicated by the number in a circle following the center distance.

L
3/8" Pitch

**Stock Drive
Selection**

Martin

speed ratio □	pulley combination				driveN speed and hp capacity						center distance, inches†				
	driveR		driveN		3500 rpm driveR speed		1750 rpm driveR speed		1160 rpm driveR speed		according to belt pitch length (PL), inches and corresponding code number (bold type)				
	code: no. of grooves	pitch diameter in.	code: no. of grooves	pitch diameter in.	driveN speed rpm	hp for 1 inch belt	driveN speed rpm	hp for 1 inch belt	driveN speed rpm	hp for 1 inch belt	PL: 12.375 33 teeth 124 L	PL: 15.00 40 teeth 150 L	PL: 18.75 50 teeth 187 L	PL: 21.00 56 teeth 210 L	PL: 22.50 60 teeth 225 L
1.41	17 L	2.029	24 L	2.865	2479	2.99	1239	1.54	822	1.03	—	3.64	5.52	6.65	7.40
1.42	12 L	1.432	17 L	2.029	2470	—	1235	1.09■	819	.72	3.46 ^⑤	4.78 ^⑤	6.66 ^⑤	7.79 ^⑤	8.54 ^⑤
1.43	28 L	3.342	40 L	4.775	2450	4.61	1225	2.49	812	1.67	—	—	—	—	4.83
	21 L	2.507	30 L	3.581	2450	3.62	1225	1.89	812	1.26	—	—	4.66	5.70	6.46
	14 L	1.671	20 L	2.387	2450	2.49■	1225	1.27	812	.85	2.99	4.31	6.19	7.32	8.07
1.44	18 L	2.149	26 L	3.104	2423	3.15	1212	1.62	803	1.08	—	—	5.24	6.37	7.12
1.45	22 L	2.626	32 L	3.820	2406	3.77	1203	1.98	788	1.32	—	—	4.28	5.41	6.17
1.47	30 L	3.581	44 L	5.252	2386	4.86	1193	2.66	791	1.79	.—	—	—	—	—
	19 L	2.268	28 L	3.342	2375	3.31	1187	1.71	787	1.14	—	3.05	4.95	6.08	6.83
1.50	48 L	5.730	72 L	8.594	2333	6.27	1167	4.06	773	2.81	—	—	—	—	—
	40 L	4.775	60 L	7.162	2333	5.87	1167	3.47	773	2.36	—	—	—	—	—
	32 L	3.820	48 L	5.730	2333	5.10	1167	2.83	773	1.91	—	—	—	—	—
	24 L	2.865	36 L	4.297	2333	4.06	1167	2.15	773	1.44	—	—	—	4.83	5.59
	20 L	2.387	30 L	3.581	2333	3.46	1167	1.80	773	1.20	—	—	4.66	5.79	6.54
	16 L	1.910	24 L	2.865	2333	2.83	1167	1.45	773	.97	—	3.73	5.61	6.74	7.50
	14 L	1.671	21 L	2.507	2333	2.49■	1167	1.27	773	.85	2.88	4.21	6.09	7.32	7.97
	12 L	1.432	18 L	2.149	2333	—	1167	1.09■	773	.72	3.36 ^⑤	4.68 ^⑤	6.56 ^⑤	7.69 ^⑤	8.44 ^⑤
1.52	21 L	2.507	32 L	3.820	2297	3.62	1148	1.89	761	1.26	—	—	4.36	5.50	6.26
1.53	17 L	2.029	26 L	3.104	2288	2.99	1144	1.54	758	1.03	—	3.43	5.32	6.46	7.11
1.54	26 L	3.104	40 L	4.775	2275	4.35	1138	2.32	754	1.56	—	—	—	4.24	5.00
1.56	18 L	2.149	28 L	3.342	2250	3.15	1125	1.62	746	1.08	—	—	5.04	6.07	6.92
1.57	28 L	3.342	44 L	5.252	2227	4.61	1114	2.49	738	1.67	—	—	—	—	—
	14 L	1.671	22 L	2.626	2227	2.49■	1114	1.27	738	.85	2.78	4.11	5.99	7.12	7.87
1.58	19 L	2.268	30 L	3.581	2217	3.31	1108	1.71	735	1.14	—	—	4.74	5.88	6.63
	12 L	1.432	19 L	2.268	2207	—	1104	1.09■	731	.72	3.26 ^⑤	4.58 ^⑤	6.47 ^⑤	7.59 ^⑤	8.34 ^⑤
1.60	30 L	3.581	48 L	5.730	2188	4.86	1094	2.66	725	1.79	—	—	—	—	—
	20 L	2.387	32 L	3.820	2188	3.46	1094	1.80	725	1.20	—	—	4.45	5.59	6.34
1.63	16 L	1.910	26 L	3.104	2154	2.83	1077	1.45	714	.97	—	3.52	5.41	6.55	7.30
1.64	44 L	5.252	72 L	8.594	2139	6.12	1069	3.77	709	2.59	—	—	—	—	—
	22 L	2.626	36 L	4.297	2139	3.77	1069	1.98	709	1.32	—	—	3.85	5.00	5.76
1.65	17 L	2.029	28 L	3.342	2125	2.99	1062	1.54	704	1.03	—	3.22	5.12	6.26	7.01
1.66	36 L	4.297	60 L	7.162	2100	5.52	1050	3.15	696	2.14	—	—	—	—	—
1.67	24 L	2.865	40 L	4.775	2100	4.06	1050	2.15	696	1.44	—	—	—	4.40	5.17
	18 L	2.149	30 L	3.581	2100	3.15	1050	1.62	696	1.08	—	2.92	4.83	5.97	6.72
	12 L	1.432	20 L	2.387	2100	—	1050	1.09■	696	.72	3.16 ^⑤	4.48 ^⑤	6.37 ^⑤	7.50 ^⑤	8.25 ^⑤
1.68	19 L	2.268	32 L	3.820	2078	3.31	1039	1.71	689	1.14	—	—	4.53	5.67	6.43
1.69	26 L	3.104	44 L	5.252	2068	4.35	1034	2.32	685	1.56	—	—	—	—	4.57
1.71	28 L	3.342	48 L	5.730	2042	4.61	1021	2.49	677	1.67	—	—	—	—	—
	21 L	2.507	36 L	4.297	2042	3.62	1021	1.89	677	1.26	—	—	3.93	5.08	5.85
	14 L	1.671	24 L	2.865	2042	2.49■	1021	1.27	677	.85	—	3.90	5.79	6.92	7.67

□ Pulley combinations shown are for conventional speed-reduction ratios; same table can be used for speed step-up ratios by making proper correction of driveN speed and belt hp capacity per inch width.

■ Pulley diameter is below recommended minimum; if used reduced belt life must be expected.

† Center distances shown are **theoretical**; manufacturing tolerances of belt length and pulley diameters can affect actual operating drive center distances.



Stock Drive Selection

L
3/8" Pitch

center distance, inches†															speed ratio □
according to belt pitch length (PL), inches and corresponding code number (bold type)															
PL: 24.00 64 teeth 240 L	PL: 25.50 68 teeth 255 L	PL: 27.00 72 teeth 270 L	PL: 28.50 76 teeth 285 L	PL: 30.00 80 teeth 300 L	PL: 32.25 86 teeth 322 L	PL: 34.50 92 teeth 345 L	PL: 36.75 98 teeth 367 L	PL: 39.00 104 teeth 390 L	PL: 42.00 112 teeth 420 L	PL: 45.00 120 teeth 450 L	PL: 48.00 128 teeth 480 L	PL: 51.00 136 teeth 510 L	PL: 54.00 144 teeth 540 L	PL: 60.00 160 teeth 600 L	
8.16	8.91	9.66	10.41	11.16	12.29	13.41	14.54	15.66	17.16	18.67	20.17	21.67	23.17	26.17	1.41
9.29 ^⑤	10.04 ^⑤	10.79 ^⑤	11.54 ^⑤	12.29 ^⑤	13.42 ^⑤	14.54	15.67	16.79	18.29	19.79	21.29	22.79	24.29	27.29	1.42
5.59	6.34	7.10	7.85	8.60	9.73	10.86	11.99	13.12	14.62	16.12	17.62	19.12	20.63	23.63	1.43
7.21	7.96	8.71	9.46	10.22	11.34	12.47	13.59	14.72	16.03	17.72	19.22	20.72	22.23	25.23	
8.82	9.57	10.32	11.07	11.82	12.95	14.11	15.20	16.32	17.82	19.32	20.82	22.32	23.82	26.82	
7.87	8.62	9.37	10.13	10.88	12.00	13.13	14.25	15.38	16.88	18.38	19.88	21.38	22.88	25.88	1.44
6.92	7.67	8.43	9.18	9.93	11.06	12.18	13.31	14.44	15.94	17.44	18.94	20.44	21.94	24.94	1.45
5.00	5.76	6.52	7.24	8.03	9.16	10.29	11.42	12.24	14.05	15.55	17.05	18.56	20.07	23.06	1.47
7.58	8.34	9.09	9.84	10.59	11.72	12.84	13.97	15.10	16.60	18.10	19.60	21.10	22.60	25.60	
—	—	—	—	—	—	—	—	8.13	9.65	11.17	12.68	14.19	15.69	18.70	1.50
—	—	—	—	—	6.65	7.79	8.93	10.06	11.57	13.08	14.59	16.09	17.60	20.60	
—	5.17	5.93	6.69	7.45	8.58	9.71	10.84	11.97	13.48	14.98	16.48	17.99	19.49	22.49	
6.34	7.10	7.85	8.60	9.36	10.49	11.61	12.74	13.87	15.37	16.87	18.37	19.87	21.38	24.38	
7.30	8.05	8.80	9.55	10.31	11.43	12.56	13.69	14.81	16.31	17.81	19.32	20.82	22.32	25.32	
8.25	9.00	9.75	10.50	11.24	12.38	13.50	14.63	15.76	17.26	18.76	20.26	21.76	23.26	26.26	
8.72	9.47	10.22	10.97	11.72	12.85	13.97	15.10	16.23	17.73	19.23	20.73	22.23	23.73	26.73	
9.19 ^⑤	9.94 ^⑤	10.69 ^⑤	11.44 ^⑤	12.20 ^⑤	13.32 ^⑤	14.45 ^⑤	15.57 ^⑤	16.70 ^⑤	18.20 ^⑤	19.70 ^⑤	21.20 ^⑤	22.70 ^⑤	24.20 ^⑤	27.20 ^⑤	
7.01	7.76	8.52	9.27	10.02	11.15	12.28	13.40	14.53	16.03	17.53	19.03	20.53	22.03	25.04	1.52
7.96	8.71	9.46	10.22	10.97	12.09	13.22	14.35	15.47	16.97	18.47	19.98	21.48	22.98	25.98	1.53
5.76	6.52	7.27	8.03	8.78	9.91	11.04	12.17	13.30	14.80	16.30	17.80	19.31	20.81	23.81	1.54
7.67	8.43	9.18	9.93	10.68	11.81	12.94	14.06	15.19	16.69	18.19	19.69	21.19	22.69	25.69	1.56
5.17	5.93	6.69	7.45	8.20	9.34	10.47	11.60	12.72	14.23	15.73	17.29	18.74	20.24	23.24	1.57
8.62	9.37	10.13	10.88	11.63	12.75	13.88	15.00	16.13	17.63	19.13	20.63	22.13	23.63	26.63	
7.39	8.14	8.89	9.64	10.40	11.52	12.65	13.78	14.90	16.41	17.91	19.41	20.91	22.41	25.41	1.58
9.10 ^⑤	9.85 ^⑤	10.60 ^⑤	11.35 ^⑤	12.10 ^⑤	13.23 ^⑤	14.35 ^⑤	15.48 ^⑤	16.60 ^⑤	18.10 ^⑤	19.60 ^⑤	21.10 ^⑤	22.60 ^⑤	24.10 ^⑤	27.10 ^⑤	
—	5.34	6.10	6.86	7.62	8.75	9.89	11.02	12.15	13.66	15.16	16.66	18.17	19.67	22.67	1.60
7.10	7.85	8.60	9.36	10.11	11.24	12.37	13.49	14.62	16.12	17.62	19.12	20.63	22.13	25.13	
8.05	8.80	9.55	10.31	11.06	12.19	13.31	14.44	15.56	17.06	18.56	20.07	21.57	23.07	26.07	1.63
—	—	—	—	—	—	—	7.31	8.47	9.99	11.51	13.03	14.54	16.05	19.06	
6.52	7.27	8.03	8.78	9.54	10.66	11.79	12.92	14.05	15.55	17.05	18.56	20.06	21.56	24.56	1.64
7.76	8.52	9.27	10.02	10.77	11.90	13.03	14.15	15.28	16.78	18.28	19.78	21.28	22.74	25.79	1.65
—	—	—	—	—	6.99	8.13	9.27	10.41	11.92	13.43	14.94	16.45	17.95	20.96	1.66
5.93	6.69	7.45	8.20	8.96	10.09	11.22	12.35	13.48	14.98	16.48	17.99	19.49	20.99	23.99	1.67
7.48	8.23	8.98	9.73	10.49	11.61	12.74	13.87	14.99	16.50	18.00	19.50	21.00	22.50	25.50	
9.00 ^⑤	9.75 ^⑤	10.50 ^⑤	11.25 ^⑤	12.00 ^⑤	13.13 ^⑤	14.25 ^⑤	15.38 ^⑤	16.51 ^⑤	18.01 ^⑤	19.51 ^⑤	21.01 ^⑤	22.51 ^⑤	24.01 ^⑤	27.01 ^⑤	
7.19	7.94	8.69	9.45	10.20	11.33	12.46	13.58	14.71	16.22	17.71	19.22	20.72	22.22	25.22	1.68
5.33	6.10	6.86	7.62	8.38	9.51	10.64	11.77	12.99	14.41	15.91	17.42	18.92	20.42	23.43	1.69
4.73	5.50	6.27	7.03	7.79	8.93	10.06	11.20	12.33	13.83	15.34	16.84	18.35	19.85	22.86	1.71
6.60	7.36	8.12	8.87	9.62	10.75	11.88	13.01	14.14	15.64	17.14	18.65	20.15	21.65	24.65	
8.43	9.18	9.93	10.68	11.43	12.56	13.69	14.81	15.94	17.44	18.94	20.44	21.94	23.44	26.44	

Teeth in Mesh	F factor
6 or more	1.00
5	.80
4	.60
3	.40
2	.20

NOTE: Multiply the H.P. ratings shown in the Drive Section Tables by Factor "F" and the width correction factors shown below:

belt width	3/8	1/2	5/8	3/4	7/8	1	1 1/4	1 1/2	1 3/4	2	2 1/2	3
width factor	.28	.35	.42	.57	.71	.86	1.0	1.29	1.56	1.84	2.14	3.36

If the number of teeth in mesh (TIM) is 5 or less, the exact TIM is indicated by the number in a circle following the center distance.

L 3/8" Pitch

Stock Drive Selection

Martin

speed ratio □	pulley combination				driveN speed and hp capacity						center distance, inches†				
	driveR		driveN		3500 rpm driveR speed		1750 rpm driveR speed		1160 rpm driveR speed		according to belt pitch length (PL), inches and corresponding code number (bold type)				
	code: no. of grooves	pitch diameter in.	code: no. of grooves	pitch diameter in.	driveN speed rpm	hp for 1 inch belt	driveN speed rpm	hp for 1 inch belt	driveN speed rpm	hp for 1 inch belt	PL: 12.375 33 teeth 124 L	PL: 15.00 40 teeth 150 L	PL: 18.75 50 teeth 187 L	PL: 21.00 56 teeth 210 L	PL: 22.50 60 teeth 225 L
1.75	48 L	5.730	84 L	10.027	2000	6.27	1000	4.06	663	2.81	—	—	—	—	—
	16 L	1.910	28 L	3.342	2000	2.83	1000	1.45	663	.97	—	—	5.21	6.34	7.10
	12 L	1.432	21 L	2.507	2000	—	1000	1.09■	663	.72	3.05⑤	4.38⑤	6.27⑤	7.40⑤	8.15⑤
1.76	17 L	2.029	30 L	3.581	1983	2.99	992	1.54	657	1.03	—	—	4.92	6.05	6.81
1.78	18 L	2.149	32 L	3.820	1969	3.15	985	1.62	652	1.08	—	—	4.62	5.76	6.52
1.80	40 L	4.775	72 L	8.594	1944	5.87	972	3.47	644	2.36	—	—	—	—	—
	20 L	2.387	36 L	4.297	1944	3.46	972	1.80	644	1.20	—	—	4.02	5.17	5.93
1.82	22 L	2.626	40 L	4.775	1925	3.77	963	1.98	638	1.32	—	—	—	4.57	5.34
1.83	24 L	2.865	44 L	5.252	1909	4.06	955	2.15	633	1.44	—	—	—	—	4.73
	12 L	1.432	22 L	2.626	1909	—	955	1.09■	633	.72	2.95⑤	4.28⑤	6.17⑤	7.30⑤	8.05⑤
1.85	26 L	3.104	48 L	5.730	1896	4.35	948	2.32	628	1.56	—	—	—	—	—
1.86	14 L	1.671	26 L	3.104	1885	2.49■	942	1.27	625	.85	—	3.69	5.59	6.72	7.48
1.88	32 L	3.820	60 L	7.162	1867	5.10	933	2.83	619	1.91	—	—	—	—	—
	17 L	2.029	32 L	3.820	1859	2.99	930	1.54	616	1.03	—	—	4.70	5.85	6.60
	16 L	1.910	30 L	3.581	1867	2.83	933	1.45	619	.97	—	—	5.00	6.14	6.90
1.89	19 L	2.268	36 L	4.297	1847	3.31	924	1.71	612	1.14	—	—	4.10	5.25	6.02
1.90	21 L	2.507	40 L	4.775	1838	3.62	919	1.89	609	1.26	—	—	—	4.65	5.42
1.91	44 L	5.252	84 L	10.027	1833	6.12	917	3.77	607	2.59	—	—	—	—	—
2.00	36 L	4.297	72 L	8.594	1750	5.52	875	3.15	580	2.14	—	—	—	—	—
	30 L	3.581	60 L	7.162	1750	4.86	875	2.66	580	1.79	—	—	—	—	—
	24 L	2.865	48 L	5.730	1750	4.06	875	2.15	580	1.44	—	—	—	—	—
	22 L	2.626	44 L	5.252	1750	3.77	875	1.98	580	1.32	—	—	—	—	4.89
	20 L	2.387	40 L	4.775	1750	3.46	875	1.80	580	1.20	—	—	—	4.73	5.50
	18 L	2.149	36 L	4.297	1750	3.15	875	1.62	580	1.08	—	—	4.18	5.34	6.10
	16 L	1.910	32 L	3.820	1750	2.83	875	1.45	580	.97	—	—	4.79	5.93	6.69
14 L	1.671	28 L	3.342	1750	2.49■	875	1.27	580	.85	—	3.47	5.38	6.52	7.27	
12 L	1.432	24 L	2.865	1750	—	875	1.09■	580	.72	2.72⑤	4.07⑤	5.97⑤	7.10⑤	7.85⑤	
2.09	21 L	2.507	44 L	5.252	1670	3.62	835	1.89	554	1.26	—	—	—	—	4.97
2.10	40 L	4.775	84 L	10.027	1667	5.87	833	3.47	552	2.36	—	—	—	—	—
2.11	19 L	2.268	40 L	4.775	1663	3.31	831	1.71	551	1.14	—	—	—	5.36	5.58
2.12	17 L	2.029	36 L	4.297	1653	2.99	826	1.54	548	1.03	—	—	4.26	5.42	6.18
2.14	28 L	3.342	60 L	7.162	1633	4.61	817	2.49	541	1.67	—	—	—	—	—
	14 L	1.671	30 L	3.581	1633	2.49■	817	1.27	541	.85	—	3.24⑤	5.17	6.31	7.07
2.17	12 L	1.432	26 L	3.104	1615	—	808	1.09■	535	.72	—	3.85⑤	5.76⑤	6.90⑤	7.65⑤
2.18	22 L	2.626	48 L	5.730	1604	3.77	802	1.98	532	1.32	—	—	—	—	—

□ Pulley combinations shown are for conventional speed-reduction ratios; same table can be used for speed step-up ratios by making proper correction of driveN speed and belt hp capacity per inch width.

■ Pulley diameter is below recommended minimum; if used reduced belt life must be expected.

† Center distances shown are **theoretical**; manufacturing tolerances of belt length and pulley diameters can affect actual operating drive center distances.



Stock Drive Selection

L
3/8" Pitch

center distance, inches†															speed ratio □
according to belt pitch length (PL), inches and corresponding code number (bold type)															
PL: 24.00 64 teeth 240 L	PL: 25.50 68 teeth 255 L	PL: 27.00 72 teeth 270 L	PL: 28.50 76 teeth 285 L	PL: 30.00 80 teeth 300 L	PL: 32.25 86 teeth 322 L	PL: 34.50 92 teeth 345 L	PL: 36.75 98 teeth 367 L	PL: 39.00 104 teeth 390 L	PL: 42.00 112 teeth 420 L	PL: 45.00 120 teeth 450 L	PL: 48.00 128 teeth 480 L	PL: 51.00 136 teeth 510 L	PL: 54.00 144 teeth 540 L	PL: 60.00 160 teeth 600 L	
—	—	—	—	—	—	—	—	—	8.35	9.90	11.43	12.96	14.47	17.50	1.75
7.85	8.61	9.36	10.11	10.86	11.99	13.12	14.24	15.37	16.87	18.37	19.88	21.38	22.88	25.88	
8.90 ^⑤	9.65 ^⑤	10.40 ^⑤	11.16 ^⑤	11.91 ^⑤	13.03 ^⑤	14.07 ^⑤	15.29 ^⑤	16.41 ^⑤	17.91 ^⑤	19.41 ^⑤	20.91 ^⑤	22.41 ^⑤	23.91 ^⑤	26.91 ^⑤	
7.56	8.32	9.07	9.82	10.58	11.70	12.83	13.96	15.09	16.59	18.09	19.59	21.09	22.59	25.60	1.76
7.27	8.03	8.78	9.53	10.29	11.42	12.55	13.67	14.80	16.30	17.80	19.31	20.81	22.31	25.31	1.78
—	—	—	—	—	—	—	7.64	8.80	10.33	11.85	13.37	14.89	16.40	19.42	
6.69	7.45	8.20	8.96	9.71	10.84	11.97	13.10	14.23	15.73	17.24	18.74	20.24	21.74	24.74	1.80
6.10	6.86	7.62	8.38	9.13	10.27	11.40	12.53	13.66	15.16	16.66	18.17	19.67	21.17	24.18	1.82
5.50	6.27	7.03	7.79	8.55	9.69	10.82	11.95	13.08	14.59	16.09	17.60	19.10	20.60	23.61	1.83
8.80 ^⑤	9.56 ^⑤	10.31 ^⑤	11.06 ^⑤	11.81 ^⑤	12.94 ^⑤	14.06 ^⑤	15.19 ^⑤	16.32 ^⑤	17.82 ^⑤	19.32 ^⑤	20.82 ^⑤	22.32 ^⑤	23.82 ^⑤	26.82 ^⑤	
4.89	5.67	6.43	7.20	7.96	9.10	10.24	11.37	12.50	14.01	15.52	17.02	18.53	20.03	23.04	1.85
8.23	8.98	9.73	10.49	11.24	12.37	13.49	14.62	15.75	17.25	18.75	20.25	21.75	23.25	26.25	1.86
—	—	—	—	6.15	7.32	8.47	9.61	10.75	12.27	13.78	15.29	16.80	18.31	21.32	
7.36	8.12	8.87	9.62	10.38	11.51	12.64	13.76	14.89	16.39	17.90	19.40	20.90	22.40	25.40	
7.65	8.41	9.16	9.91	10.67	11.80	12.92	14.05	15.18	16.68	18.18	19.68	22.18	22.68	25.69	
6.78	7.53	8.29	9.05	9.80	10.93	12.06	13.19	14.32	15.82	17.33	18.83	20.33	21.83	24.84	1.89
6.19	6.95	7.71	8.46	9.22	10.35	11.49	12.62	13.74	15.25	16.75	18.26	19.76	21.26	24.27	1.90
—	—	—	—	—	—	—	—	—	8.68	10.23	11.76	13.29	14.82	17.85	1.91
—	—	—	—	—	—	6.79	7.96	9.13	10.67	12.19	13.72	15.23	16.75	19.77	
—	—	—	—	6.31	7.48	8.63	9.78	10.92	12.44	13.96	15.47	16.98	18.49	21.50	
5.05	5.83	6.60	7.37	8.13	9.27	10.41	11.55	12.68	14.19	15.70	17.20	18.71	20.21	23.22	
5.67	6.44	7.20	7.96	8.72	9.86	10.99	12.13	13.26	14.77	16.27	17.78	19.28	20.78	23.79	
6.27	7.03	7.79	8.55	9.31	10.44	11.57	12.70	13.83	15.34	16.84	18.35	19.85	21.35	24.36	
6.86	7.62	8.38	9.13	9.89	11.02	12.15	13.28	14.41	15.91	17.42	18.92	20.42	21.92	24.93	
7.45	8.20	8.96	9.71	10.47	11.60	12.73	13.85	14.98	16.48	17.99	19.49	20.99	22.49	25.50	
8.03	8.78	9.54	10.29	11.04	12.17	13.30	14.43	15.55	17.05	18.56	20.06	21.56	23.06	26.06	
8.61 ^⑤	9.36 ^⑤	10.11 ^⑤	10.86 ^⑤	11.62 ^⑤	12.74 ^⑤	13.87 ^⑤	15.00 ^⑤	16.12 ^⑤	17.62 ^⑤	19.13 ^⑤	20.63 ^⑤	22.13 ^⑤	23.62 ^⑤	26.63 ^⑤	
5.75	6.52	7.28	8.05	8.81	9.95	11.08	12.21	13.35	14.85	16.36	17.86	19.37	20.87	23.88	2.09
—	—	—	—	—	—	—	—	—	9.00	10.55	12.10	13.63	15.16	18.19	2.10
6.35	7.12	7.88	8.64	9.40	10.53	11.66	12.79	13.92	15.43	16.93	18.44	19.94	21.44	24.45	2.11
6.95	7.71	8.46	9.22	9.98	11.11	12.24	13.37	14.50	16.00	17.51	19.01	20.51	22.01	25.02	2.12
—	—	—	5.68	6.47	7.64	8.80	9.95	11.09	12.61	14.13	15.64	17.15	18.66	21.68	2.14
7.83	8.58	9.34	10.09	10.85	11.97	13.10	14.23	15.36	16.86	18.36	19.86	21.37	22.87	25.87	
8.41 ^⑤	9.16 ^⑤	9.91 ^⑤	10.67 ^⑤	11.42 ^⑤	12.55 ^⑤	13.67 ^⑤	14.80 ^⑤	15.93 ^⑤	17.43 ^⑤	18.93 ^⑤	20.43 ^⑤	21.94 ^⑤	23.44 ^⑤	26.44 ^⑤	2.17
5.21	5.99	6.77	7.54	8.30	9.44	10.58	11.72	12.85	14.36	15.87	17.38	18.89	20.39	23.40	2.18

Teeth in Mesh	F factor
6 or more	1.00
5	.80
4	.60
3	.40
2	.20

NOTE: Multiply the H.P. ratings shown in the Drive Section Tables by Factor "F" and the width correction factors shown below:

belt width	3/8	7/16	1/2	5/8	3/4	7/8	1	1 1/4	1 1/2	1 3/4	2	2 1/2	3
width factor	.28	.35	.42	.57	.71	.86	1.0	1.29	1.56	1.84	2.14	2.72	3.36

If the number of teeth in mesh (TIM) is 5 or less, the exact TIM is indicated by the number in a circle following the center distance.

L 3/8" Pitch

Stock Drive Selection



speed ratio □	pulley combination				driveN speed and hp capacity						center distance, inches †				
	driveR		driveN		3500 rpm driveR speed		1750 rpm driveR speed		1160 rpm driveR speed		according to belt pitch length (PL), inches and corresponding code number (bold type)				
	code: no. of grooves	pitch diameter in.	code: no. of grooves	pitch diameter in.	driveN speed rpm	hp for 1 inch belt	driveN speed rpm	hp for 1 inch belt	driveN speed rpm	hp for 1 inch belt	PL: 12.375 33 teeth 124 L	PL: 15.00 40 teeth 150 L	PL: 18.75 50 teeth 187 L	PL: 21.00 56 teeth 210 L	PL: 22.50 60 teeth 225 L
2.20	20 L	2.387	44 L	5.252	1590	3.46	795	1.80	527	1.20	—	—	—	4.26	5.05
2.22	18 L	2.149	40 L	4.775	1575	3.15	788	1.62	522	1.08	—	—	—	4.89	5.67
2.25	32 L	3.820	72 L	8.594	1556	5.10	778	2.83	516	1.91	—	—	—	—	—
	16 L	1.910	36 L	4.297	1556	2.83	778	1.45	516	.97	—	—	4.34	5.50	6.27
2.29	21 L	2.507	48 L	5.730	1531	3.62	766	1.89	507	1.26	—	—	—	—	4.49
	14 L	1.671	32 L	3.820	1531	2.49 ■	766	1.27	507	.85	—	—	4.95 ⑤	6.10	6.86
2.31	26 L	3.104	60 L	7.162	1517	4.35	758	2.32	503	1.56	—	—	—	—	—
2.32	19 L	2.268	44 L	5.252	1511	3.31	756	1.71	501	1.14	—	—	—	4.34	5.13
2.33	36 L	4.297	84 L	10.027	1500	5.52	750	3.15	497	2.14	—	—	—	—	—
	12 L	1.432	28 L	3.342	1500	—	750	1.09 ■	497	.72	—	3.63 ④	5.55 ⑤	6.69 ⑤	7.45 ⑤
2.40	30 L	3.581	72 L	8.594	1458	4.86	729	2.66	483	1.79	—	—	—	—	—
	20 L	2.387	48 L	5.730	1458	3.46	729	1.80	483	1.20	—	—	—	—	4.57
2.44	18 L	2.149	44 L	5.252	1432	3.15	716	1.62	475	1.08	—	—	—	4.42	5.21
2.50	24 L	2.865	60 L	7.162	1400	4.06	700	2.15	464	1.44	—	—	—	—	—
	16 L	1.910	40 L	4.775	1400	2.83	700	1.45	464	.97	—	—	—	5.05	5.83
	12 L	1.432	30 L	3.581	1400	—	700	1.09 ■	464	.72	—	3.40 ④	5.34 ⑤	6.48 ⑤	7.24 ⑤
2.53	19 L	2.268	48 L	5.730	1385	3.31	693	1.71	459	1.14	—	—	—	—	4.65
2.57	28 L	3.342	72 L	8.594	1361	4.61	681	2.49	451	1.67	—	—	—	—	—
	14 L	1.671	36 L	4.297	1361	2.49 ■	681	1.27	451	.85	—	—	4.50 ⑤	5.67 ⑤	6.44
2.59	17 L	2.029	44 L	5.252	1352	2.99	676	1.54	448	1.03	—	—	—	4.50	5.29
2.63	32 L	3.820	84 L	10.027	1333	5.10	667	2.83	442	1.91	—	—	—	—	—
2.67	18 L	2.149	48 L	5.730	1312	3.15	656	1.62	435	1.08	—	—	—	—	4.73
	12 L	1.432	32 L	3.820	1312	—	656	1.09 ■	435	.72	—	3.15 ⑤	5.12 ⑤	6.27 ⑤	7.03 ⑤
2.73	22 L	2.626	60 L	7.162	1283	3.77	642	1.98	425	1.32	—	—	—	—	—
2.75	16 L	1.910	44 L	5.252	1272	2.83	636	1.45	422	.97	—	—	—	4.57	5.37
2.77	26 L	3.104	72 L	8.594	1264	4.35	632	2.32	419	1.56	—	—	—	—	—
2.80	30 L	3.581	84 L	10.027	1250	4.86	625	2.66	414	1.79	—	—	—	—	—
2.82	17 L	2.029	48 L	5.730	1240	2.99	620	1.54	411	1.03	—	—	—	—	4.80
2.86	21 L	2.507	60 L	7.162	1225	3.62	613	1.89	406	1.26	—	—	—	—	—
	14 L	1.671	40 L	4.775	1225	2.49 ■	613	1.27	406	.85	—	—	—	5.21	5.99
3.00	28 L	3.342	84 L	10.027	1167	4.61	583	2.49	387	1.67	—	—	—	—	—
	24 L	2.865	72 L	8.594	1167	4.06	583	2.15	387	1.44	—	—	—	—	—
	20 L	2.387	60 L	7.162	1167	3.46	583	1.80	387	1.20	—	—	—	—	—
	16 L	1.910	48 L	5.730	1167	2.83	583	1.45	387	.97	—	—	—	—	4.88
	12 L	1.432	36 L	4.297	1167	—	583	1.09 ■	387	.72	—	—	4.66 ④	5.83 ⑤	6.60 ⑤
3.14	14 L	1.671	44 L	5.252	1114	2.49 ■	557	1.27	369	.85	—	—	—	4.73 ⑤	5.53 ⑤

□ Pulley combinations shown are for conventional speed-reduction ratios; same table can be used for speed step-up ratios by making proper correction of driveN speed and belt hp capacity per inch width.

■ Pulley diameter is below recommended minimum; if used reduced belt life must be expected.

† Center distances shown are **theoretical**; manufacturing tolerances of belt length and pulley diameters can affect actual operating drive center distances.



Stock Drive Selection

L
3/8" Pitch

center distance, inches†															
according to belt pitch length (PL), inches and corresponding code number (bold type)															
PL: 24.00 64 teeth 240 L	PL: 25.50 68 teeth 255 L	PL: 27.00 72 teeth 270 L	PL: 28.50 76 teeth 285 L	PL: 30.00 80 teeth 300 L	PL: 32.25 86 teeth 322 L	PL: 34.50 92 teeth 345 L	PL: 36.75 98 teeth 367 L	PL: 39.00 104 teeth 390 L	PL: 42.00 112 teeth 420 L	PL: 45.00 120 teeth 450 L	PL: 48.00 128 teeth 480 L	PL: 51.00 136 teeth 510 L	PL: 54.00 144 teeth 540 L	PL: 60.00 160 teeth 600 L	speed ratio □
5.83	6.60	7.37	8.13	8.89	10.03	11.17	12.30	13.43	14.94	16.45	17.95	19.46	20.96	23.97	2.20
6.44	7.20	7.96	8.72	9.48	10.62	11.75	12.88	14.01	15.52	17.02	18.53	20.03	21.53	24.54	2.22
—	—	—	—	—	—	7.10	8.29	9.45	11.00	12.53	14.06	15.58	17.09	20.12	2.25
7.03	7.79	8.55	9.31	10.07	11.20	12.33	13.46	14.59	16.09	17.60	19.10	20.60	22.11	25.11	2.29
5.29	6.07	6.85	7.62	8.39	9.53	10.67	11.99	12.94	14.45	15.96	17.47	18.97	20.48	23.49	2.29
7.62	8.38	9.13	9.89	10.64	11.77	12.90	14.03	15.16	16.67	18.17	19.67	21.17	22.68	25.68	2.31
—	—	—	5.84	6.63	7.80	8.97	10.12	11.26	12.79	14.30	15.82	17.33	18.84	21.85	2.31
5.91	6.68	7.45	8.22	8.98	10.12	11.25	12.39	13.52	15.03	16.54	18.04	19.55	21.05	24.06	2.32
—	—	—	—	—	—	—	—	7.72	9.31	10.88	12.43	13.96	15.49	18.54	2.33
8.20 ^⑤	8.96 ^⑤	9.71 ^⑤	10.47 ^⑤	11.22 ^⑤	12.35 ^⑤	13.48 ^⑤	14.61 ^⑤	15.73 ^⑤	17.24 ^⑤	18.74 ^⑤	20.24 ^⑤	21.74 ^⑤	23.24 ^⑤	26.25 ^⑤	2.40
—	—	—	—	—	—	7.26	8.44	9.62	11.16	12.70	14.23	15.75	17.27	20.29	2.40
5.37	6.15	6.93	7.70	8.47	9.61	10.75	11.89	13.03	14.54	16.05	17.56	19.06	20.57	23.58	2.44
5.99	6.77	7.54	8.30	9.06	10.20	11.34	12.48	13.61	15.12	16.63	18.13	19.64	21.14	24.15	2.44
—	—	—	5.99	6.79	7.97	9.13	10.28	11.43	12.96	14.48	15.99	17.50	19.01	22.03	2.50
6.60	7.37	8.13	8.89	9.65	10.79	11.92	13.06	14.19	15.70	17.20	18.71	20.21	21.72	24.72	2.50
8.00 ^⑤	8.76 ^⑤	9.51 ^⑤	10.27 ^⑤	11.02 ^⑤	12.15 ^⑤	13.28 ^⑤	14.41 ^⑤	15.54 ^⑤	17.04 ^⑤	18.54 ^⑤	20.05 ^⑤	21.55 ^⑤	23.05 ^⑤	26.05 ^⑤	2.53
5.45	6.23	7.01	7.78	8.55	9.70	10.84	11.98	13.11	14.63	16.14	17.65	19.15	20.66	23.67	2.53
—	—	—	—	—	6.19	7.41	8.60	9.78	11.33	12.86	14.39	15.92	17.44	20.47	2.57
7.20	7.96	8.72	9.48	10.24	11.37	12.51	13.64	14.77	16.27	17.78	19.28	20.78	22.29	25.29	2.59
6.07	6.85	7.62	8.39	9.15	10.29	11.43	12.56	13.70	15.21	16.72	18.22	19.73	21.23	24.24	2.59
—	—	—	—	—	—	—	—	8.02	9.63	11.20	12.75	14.30	15.83	18.88	2.63
5.53	6.31	7.09	7.87	8.64	9.78	10.92	12.06	13.20	14.72	16.23	17.73	19.24	20.75	23.76	2.67
7.79 ^⑤	8.55 ^⑤	9.31 ^⑤	10.07 ^⑤	10.82 ^⑤	11.95 ^⑤	13.08 ^⑤	14.21 ^⑤	15.34 ^⑤	16.85 ^⑤	18.35 ^⑤	19.85 ^⑤	21.36 ^⑤	22.86 ^⑤	25.86 ^⑤	2.67
—	—	5.33	6.15	6.95	8.13	9.29	10.45	11.60	13.18	14.65	16.16	17.68	19.19	22.21	2.73
6.15	6.93	7.70	8.47	9.23	10.38	11.51	12.65	13.78	15.30	16.80	18.31	19.82	21.32	24.33	2.75
—	—	—	—	—	6.34	7.56	8.76	9.94	11.49	13.03	14.56	16.09	17.61	20.64	2.77
—	—	—	—	—	—	—	—	8.17	9.78	11.36	12.92	14.46	16.00	19.05	2.80
5.61	6.39	7.17	7.95	8.72	9.87	11.01	12.15	13.29	14.80	16.31	17.82	19.33	20.84	23.85	2.82
.....	5.40	6.22	7.02	8.21	9.37	10.53	11.68	13.21	14.73	16.25	17.77	19.28	22.30	2.86
6.77	7.54	8.30	9.06	9.83	10.96	12.10	13.23	14.36	15.87	17.38	18.89	20.39	21.89	24.90	2.86
—	—	—	—	—	—	—	7.08	8.33	9.94	11.52	13.08	14.63	16.16	19.22	3.00
—	—	—	—	—	6.49	7.72	8.92	10.10	11.65	13.20	14.73	16.26	17.78	20.81	3.00
—	—	5.48	6.30	7.10	8.29	9.46	10.61	11.77	13.29	14.82	16.34	17.85	19.36	22.38	3.00
5.68	6.47	7.26	8.03	8.80	9.95	11.10	12.24	13.37	14.89	16.40	17.91	19.42	20.93	23.94	3.00
7.37 ^⑤	8.13 ^⑤	8.89 ^⑤	9.65 ^⑤	10.41 ^⑤	11.55 ^⑤	12.68 ^⑤	13.81 ^⑤	14.94 ^⑤	16.45 ^⑤	17.96 ^⑤	19.46 ^⑤	20.96 ^⑤	22.47 ^⑤	25.47 ^⑤	3.00
6.31 ^⑤	7.09 ^⑤	7.87	8.64	9.40	10.54	11.68	12.82	13.96	15.47	16.98	18.49	19.99	21.50	24.51	3.14

Teeth in Mesh	F factor
6 or more	1.00
5	.80
4	.60
3	.40
2	.20

NOTE: Multiply the H.P. ratings shown in the Drive Section Tables by Factor "F" and the width correction factors shown below:

belt width	3/8	7/16	1/2	5/8	3/4	7/8	1	1 1/4	1 1/2	1 3/4	2	2 1/2	3
width factor	.28	.35	.42	.57	.71	.86	1.0	1.29	1.56	1.84	2.14	2.72	3.36

If the number of teeth in mesh (TIM) is 5 or less, the exact TIM is indicated by the number in a circle following the center distance.

L
3/8" Pitch

Stock Drive Selection

Martin

speed ratio □	pulley combination				driveN speed and hp capacity						center distance, inches†				
	driveR		driveN		3500 rpm driveR speed		1750 rpm driveR speed		1160 rpm driveR speed		according to belt pitch length (PL), inches and corresponding code number (bold type)				
	code: no. of grooves	pitch diameter in.	code: no. of grooves	pitch diameter in.	driveN speed rpm	hp for 1 inch belt	driveN speed rpm	hp for 1 inch belt	driveN speed rpm	hp for 1 inch belt	PL: 12.375 33 teeth 124 L	PL: 15.00 40 teeth 150 L	PL: 18.75 50 teeth 187 L	PL: 21.00 56 teeth 210 L	PL: 22.50 60 teeth 225 L
3.16	19 L	2.268	60 L	7.162	1108	3.31	554	1.71	367	1.14	—	—	—	—	—
3.23	26 L	3.104	84 L	10.027	1084	4.35	542	2.32	359	1.56	—	—	—	—	—
3.27	22 L	2.626	72 L	8.594	1069	3.77	535	1.98	354	1.32	—	—	—	—	—
3.33	18 L 12 L	2.149 1.432	60 L 40 L	7.162 4.775	1050 1050	3.15 —	525 525	1.62 1.09■	348 348	1.08 .72	—	—	—	—	—
3.43	21 L 14 L	2.507 1.671	72 L 48 L	8.594 5.730	1021 1021	3.62 2.49■	510 510	1.89 1.27	338 338	1.26 .85	—	—	—	—	—
3.50	24 L	2.865	84 L	10.027	1000	4.06	500	2.15	331	1.44	—	—	—	—	—
3.53	17 L	2.029	60 L	7.162	992	2.99	496	1.54	329	1.03	—	—	—	—	—
3.60	20 L	2.387	72 L	8.594	972	3.46	486	1.80	322	1.20	—	—	—	—	—
3.66	12 L	1.432	44 L	5.252	955	—	477	1.09■	316	.72	—	—	—	—	—
3.75	16 L	1.910	60 L	7.162	933	2.83	467	1.45	309	.97	—	—	—	—	—
3.79	19 L	2.268	72 L	8.594	924	3.31	462	1.71	306	1.14	—	—	—	—	—
3.82	22 L	2.626	84 L	10.027	916	3.77	458	1.98	304	1.32	—	—	—	—	—
4.00	21 L 18 L 12 L	2.507 2.149 1.432	84 L 72 L 48 L	10.027 8.594 5.730	875 875 875	3.62 3.15 —	438 438 438	1.89 1.62 1.09■	290 290 290	1.26 1.08 .72	—	—	—	—	—
4.20	20 L	2.387	84 L	10.027	833	3.46	417	1.80	276	1.20	—	—	—	—	—
4.23	17 L	2.029	72 L	8.594	826	2.99	413	1.54	274	1.03	—	—	—	—	—
4.29	14 L	1.671	60 L	7.162	817	2.49■	408	1.27	271	.85	—	—	—	—	—
4.42	19 L	2.268	84 L	10.027	792	3.31	396	1.71	262	1.14	—	—	—	—	—
4.50	16 L	1.910	72 L	8.594	778	2.83	389	1.45	258	.97	—	—	—	—	—
4.67	18 L	2.149	84 L	10.027	749	3.15	375	1.62	248	1.08	—	—	—	—	—
4.94	17 L	2.029	84 L	10.027	708	2.99	354	1.54	235	1.03	—	—	—	—	—
5.00	12 L	1.432	60 L	7.162	700	—	350	1.09■	232	.72	—	—	—	—	—
5.14	14 L	1.671	72 L	8.594	681	2.49■	340	1.27	226	.85	—	—	—	—	—
5.25	16 L	1.910	84 L	10.027	667	2.83	333	1.45	221	.97	—	—	—	—	—
6.00	14 L 12 L	1.671 1.432	84 L 72 L	10.027 8.594	583 583	2.49■ —	292 292	1.27 1.09■	193 193	.85 .72	—	—	—	—	—
7.00	12 L	1.432	84 L	10.027	500	—	250	1.09■	166	.72	—	—	—	—	—

□ Pulley combinations shown are for conventional speed-reduction ratios; same table can be used for speed step-up ratios by making proper correction of driveN speed and belt hp capacity per inch width.

■ Pulley diameter is below recommended minimum; if used reduced belt life must be expected.

† Center distances shown are **theoretical**; manufacturing tolerances of belt length and pulley diameters can affect actual operating drive center distances.



Stock Drive Selection

L
3/8" Pitch

center distance, inches†															speed ratio □
according to belt pitch length (PL), inches and corresponding code number (bold type)															
PL: 24.00 64 teeth 240 L	PL: 25.50 68 teeth 255 L	PL: 27.00 72 teeth 270 L	PL: 28.50 76 teeth 285 L	PL: 30.00 80 teeth 300 L	PL: 32.25 86 teeth 322 L	PL: 34.50 92 teeth 345 L	PL: 36.75 98 teeth 367 L	PL: 39.00 104 teeth 390 L	PL: 42.00 112 teeth 420 L	PL: 45.00 120 teeth 450 L	PL: 48.00 128 teeth 480 L	PL: 51.00 136 teeth 510 L	PL: 54.00 144 teeth 540 L	PL: 60.00 160 teeth 600 L	
—	—	5.46	6.38	7.18	8.37	9.54	10.70	11.85	14.50	14.90	16.42	17.94	19.45	22.47	3.16
—	—	—	—	—	—	—	7.22	8.48	10.10	11.68	13.24	14.79	16.33	19.39	3.23
—	—	—	—	—	6.64	7.87	9.07	10.26	11.82	13.36	14.90	16.43	17.95	20.99	3.27
—	—	5.62	6.45	7.26	8.45	9.62	10.78	11.93	13.46	14.99	16.51	18.02	19.54	22.56	3.33
6.93 ^⑤	7.70 ^⑤	8.47 ^⑤	9.23 ^⑤	10.00 ^⑤	11.14 ^⑤	12.27 ^⑤	13.40 ^⑤	14.54 ^⑤	16.05 ^⑤	17.56 ^⑤	19.06 ^⑤	20.57 ^⑤	22.08 ^⑤	25.08 ^⑤	
—	—	—	—	—	6.71	7.95	9.15	10.34	11.90	13.44	14.98	16.51	18.03	21.07	3.43
5.84 ^⑤	6.63 ^⑤	7.42 ^⑤	8.19 ^⑤	8.97 ^⑤	10.12	11.26	12.41	13.55	15.06	16.57	18.08	19.59	21.10	24.11	
—	—	—	—	—	—	—	7.37	8.63	10.25	11.84	13.40	14.95	16.49	19.56	3.50
—	4.84 ^⑤	5.70	6.53	7.34	8.52	9.70	10.86	12.02	13.55	15.07	16.59	18.11	19.62	22.65	3.53
—	—	—	—	—	6.78	8.02	9.23	10.42	11.98	13.53	15.06	16.59	18.12	21.16	3.60
6.47 ^④	7.25 ^④	8.03 ^⑤	8.80 ^⑤	9.57 ^⑤	10.71 ^⑤	11.86 ^⑤	13.00 ^⑤	14.13 ^⑤	15.64 ^⑤	17.16 ^⑤	18.66 ^⑤	20.17 ^⑤	21.68 ^⑤	24.69 ^⑤	3.66
—	4.91 ^⑤	5.77 ^⑤	6.60 ^⑤	7.41	8.60	9.78	10.94	12.10	13.63	15.16	16.68	18.20	19.71	22.73	3.75
—	—	—	—	—	6.86	8.10	9.31	10.51	12.06	13.61	15.15	16.68	18.20	21.24	3.79
—	—	—	—	—	—	—	7.51	8.78	10.40	12.00	13.56	15.12	16.66	19.18	3.82
—	—	—	—	—	—	—	7.58	8.85	10.48	12.07	13.64	15.20	16.74	19.80	4.00
—	—	—	—	5.61 ^⑤	6.93	8.18	9.39	10.58	12.14	13.69	15.23	16.76	18.29	21.33	
5.99 ^④	6.79 ^④	7.58 ^④	8.36 ^④	9.13 ^⑤	10.28 ^⑤	11.43 ^⑤	12.58 ^⑤	13.72 ^⑤	15.23 ^⑤	16.75 ^⑤	18.25 ^⑤	19.77 ^⑤	21.28 ^⑤	24.29 ^⑤	
—	—	—	—	—	—	—	7.66	8.93	10.56	12.15	13.72	15.28	16.82	19.89	4.20
—	—	—	—	5.68 ^⑤	7.00 ^⑤	8.25	9.46	10.65	12.22	13.77	15.31	16.85	18.37	21.42	4.23
—	5.05 ^④	5.92 ^④	6.75 ^⑤	7.57 ^⑤	8.76 ^⑤	9.94 ^⑤	11.11 ^⑤	12.26 ^⑤	13.80	15.33	16.85	18.37	19.88	22.91	4.29
—	—	—	—	—	—	6.38 ^⑤	7.73	9.00	10.64	12.23	13.80	15.36	16.91	19.98	4.42
—	—	—	—	5.75 ^④	7.08 ^⑤	8.33 ^⑤	9.54	10.73	12.30	13.85	15.40	16.93	18.46	21.50	4.50
—	—	—	—	—	—	6.45 ^⑤	7.80 ^⑤	9.08	10.71	12.31	13.88	15.44	16.99	20.06	4.67
—	—	—	—	—	—	6.51 ^④	7.87 ^⑤	9.15 ^⑤	10.79	12.39	13.96	15.52	17.07	20.14	4.94
—	5.19 ^③	6.07 ^④	6.90 ^④	7.72 ^④	8.92 ^④	10.10 ^④	11.27 ^⑤	12.43 ^⑤	13.97 ^⑤	15.49 ^⑤	17.02 ^⑤	18.54 ^⑤	20.06 ^⑤	23.08 ^⑤	5.00
—	—	—	—	5.89 ^④	7.22 ^④	8.48 ^⑤	9.70 ^⑤	10.89 ^⑤	12.46 ^⑤	14.02 ^⑤	15.56 ^⑤	17.10	18.63	21.67	5.14
—	—	—	—	—	—	6.58 ^④	7.94 ^⑤	9.22 ^⑤	10.87	12.47	14.04	15.60	17.15	20.23	5.25
—	—	—	—	—	—	6.72 ^④	8.09 ^④	9.37 ^④	11.02 ^⑤	12.62 ^⑤	14.20 ^⑤	15.76 ^⑤	17.32 ^⑤	20.39 ^⑤	6.00
—	—	—	—	6.03 ^③	7.37 ^④	8.63 ^④	9.85 ^④	11.05 ^④	12.62 ^④	14.18 ^⑤	15.73 ^⑤	17.26 ^⑤	18.79 ^⑤	21.84 ^⑤	
—	—	—	—	—	—	6.86 ^③	8.23 ^③	9.52 ^④	11.17 ^④	12.78 ^④	14.36 ^④	15.93 ^④	17.48 ^⑤	20.56 ^⑤	7.00

Teeth in Mesh	F factor
6 or more	1.00
5	.80
4	.60
3	.40
2	.20

NOTE: Multiply the H.P. ratings shown in the Drive Section Tables by Factor "F" and the width correction factors shown below:

belt width	3/8	7/16	1/2	5/8	3/4	7/8	1	1 1/4	1 1/2	1 3/4	2	2 1/2	3
width factor	.28	.35	.42	.57	.71	.86	1.0	1.29	1.56	1.84	2.14	2.72	3.36

If the number of teeth in mesh (TIM) is 5 or less, the exact TIM is indicated by the number in a circle following the center distance.

H 1/2" Pitch

Stock Drive Selection



speed ratio □	pulley combination				driveN speed and hp capacity						center distance, inches†						
	driveR		driveN		3500 rpm driveR speed		1750 rpm driveR speed		1160 rpm driveR speed		according to belt pitch length (PL), inches and corresponding code number (bold type)						
	code: no. of grooves	pitch diameter in.	code: no. of grooves	pitch diameter in.	driveN speed rpm	hp for 1 inch belt	driveN speed rpm	hp for 1 inch belt	driveN speed rpm	hp for 1 inch belt	PL: 24.00 48 teeth 240 H	PL: 27.00 54 teeth 270 H	PL: 30.00 60 teeth 300 H	PL: 33.00 66 teeth 330 H	PL: 36.00 72 teeth 360 H	PL: 39.00 78 teeth 390 H	PL: 42.00 84 teeth 420 H
1.00	48 H	7.639	48H	7.639	3500	21.63	1750	13.84	1160	9.55	—	—	—	—	—	—	9.01
	44 H	7.003	44 H	7.003	3500	21.01	1750	12.81	1160	8.80	—	—	—	—	—	8.51	10.01
	40 H	6.366	40 H	6.366	3500	20.08	1750	11.79	1160	8.03	—	—	—	—	8.01	9.51	11.01
	36 H	5.730	36 H	5.730	3500	18.89	1750	10.71	1160	7.26	—	—	—	7.51	9.01	10.51	12.01
	32 H	5.093	32 H	5.093	3500	17.40	1750	9.60	1160	6.48	—	5.51	7.01	8.51	10.01	11.51	13.01
	30 H	4.775	30 H	4.775	3500	16.59	1750	9.03	1160	6.08	—	6.01	7.51	9.01	10.51	12.01	13.51
	28 H	4.456	28 H	4.456	3500	15.74	1750	8.46	1160	5.68	5.01	6.51	8.01	9.51	11.01	12.51	14.01
	26 H	4.138	26 H	4.138	3500	14.80	1750	7.88	11.60	5.28	5.51	7.01	8.51	10.01	11.51	13.01	14.51
	24 H	3.820	24 H	3.820	3500	13.82	1750	7.30	1160	4.89	6.01	7.51	9.01	10.51	12.01	13.51	15.01
	22 H	3.501	22 H	3.501	3500	12.84	1750	6.71	1160	4.48	6.51	8.01	9.51	11.01	12.51	14.01	15.51
	21 H	3.342	21 H	3.342	3500	12.31 ■	1750	6.41	1160	4.28	6.76	8.26	9.76	11.26	12.76	14.26	15.76
	20 H	3.183	20 H	3.183	3500	11.77 ■	1750	6.11	1160	4.08	7.01	8.51	10.01	11.51	13.01	14.51	16.01
19 H	3.024	19 H	3.024	3500	11.24 ■	1750	5.81 ■	1160	3.88	7.26	8.76	10.26	11.76	13.26	14.76	16.26	
18 H	2.865	18 H	2.865	3500	10.71 ■	1750	5.52 ■	1160	3.68	7.51	9.01	10.51	12.01	13.51	15.01	16.51	
16 H	2.546	16 H	2.546	3500	—	1750	4.91 ■	1160	3.27 ■	8.01	9.51	11.01	12.51	14.01	15.51	17.01	
1.04	21 H	3.342	22 H	3.501	3342	12.31 ■	1671	6.41	1108	4.28	6.63	8.13	9.63	11.13	12.63	14.14	15.64
1.05	20 H	3.183	21 H	3.342	3333	11.77 ■	1667	6.11	1105	4.08	6.88	8.38	9.88	11.38	12.88	14.39	15.89
	19 H	3.024	20 H	3.183	3325	11.24 ■	1663	5.81 ■	1102	3.88	7.13	8.63	10.13	11.63	13.14	14.64	16.14
	18 H	2.865	19 H	3.024	3314	10.71 ■	1657	5.52 ■	1098	3.68	7.38	8.88	10.38	11.89	13.39	14.89	16.39
1.07	30 H	4.775	32 H	5.093	3281	16.59	1641	9.03	1087	6.08	—	5.75	7.25	8.76	10.26	11.76	13.26
	28 H	4.456	30 H	4.775	3267	15.74	1633	8.46	1083	5.68	—	6.25	7.76	9.26	10.76	12.26	13.76
1.08	26 H	4.138	28 H 4	4.56	3250	14.80	1625	7.88	1077	5.28	5.25	6.75	8.26	9.76	11.26	12.76	14.26
	24 H	3.820	26 H	4.138	3231	13.82	1615	7.30	1071	4.89	5.76	7.26	8.76	10.26	11.76	13.26	14.76
1.09	44 H	7.003	48 H	7.639	3208	21.01	1604	12.84	1063	8.80	—	—	—	—	7.98	9.50	
	22 H	3.501	24 H	3.820	3208	12.84	1604	6.71	1063	4.48	6.26	7.76	9.26	10.76	12.26	13.76	15.26
1.10	40 H	6.366	44 H	7.003	3182	20.08	1591	11.79	1055	8.03	—	—	—	—	7.50	9.00	10.50
	20 H	3.183	22 H	3.501	3182	11.77 ■	1591	6.11	1055	4.08	6.76	8.26	9.76	11.26	12.76	14.26	15.75
	19 H	3.024	21 H	3.342	3167	11.24 ■	1583	5.81 ■	1050	3.88	7.01	8.51	10.01	11.51	13.01	14.51	16.01
1.11	36 H	5.730	40 H	6.366	3150	18.89	1575	10.71	1044	7.26	—	—	—	7.00	8.50	10.00	11.50
	18 H	2.865	20 H	3.183	3150	10.71 ■	1575	5.52 ■	1044	3.68	7.26	8.76	10.26	11.76	13.26	14.76	16.26
1.13	32 H	5.093	36 H	5.730	3111	17.40	1556	9.60	1031	6.48	—	—	6.50	8.00	9.50	11.00	12.50
	16 H	2.546	18 H	2.865	3111	—	1556	4.91 ■	1031	3.27 ■	7.76	9.26	10.76	12.26	13.76	15.26	16.76
1.14	28 H	4.456	32 H	5.093	3063	15.74	1531	8.46	1015	5.68	—	6.00	7.50	9.00	10.50	12.01	13.51
	21 H	3.342	24 H	3.820	3063	12.31 ■	1531	6.41	1015	4.28	6.38	7.88	9.38	10.88	12.38	13.88	15.38
1.15	26 H	4.138	30 H	4.775	3033	14.80	1517	7.88	1005	5.28	5.00	6.50	8.00	9.50	11.00	12.51	14.01
1.16	19 H	3.024	22 H	3.501	3023	11.24 ■	1511	5.81 ■	1002	3.88	6.88	8.38	9.88	11.38	12.88	14.38	15.88
1.17	24 H	3.820	28 H	4.456	3000	13.82	1500	7.30	994	4.89	5.50	7.00	8.50	10.00	11.50	13.01	14.51
	18 H	2.865	21 H	3.342	3000	10.71 ■	1500	5.52 ■	994	3.68	7.13	8.63	10.13	11.63	13.13	14.63	16.13
1.18	22 H	3.501	26 H	4.138	2962	12.84	1481	6.71	982	4.48	6.00	7.50	9.00	10.50	12.01	13.50	15.01
1.19	16 H	2.546	19 H	3.024	2947	—	1474	4.91 ■	977	3.27 ■	7.63	9.13	10.63	12.13	13.63	15.13	16.63
1.20	40 H	6.366	48 H	7.639	2917	20.08	1458	11.79	967	8.03	—	—	—	—	8.48	9.99	
	30 H	4.775	36 H	5.730	2917	16.59	1458	9.03	967	6.08	—	—	6.74	8.24	9.75	11.25	12.75
	20 H	3.183	24 H	3.820	2917	11.77 ■	1458	6.11	967	4.08	6.50	8.00	9.50	11.00	12.51	14.01	15.51

□ Pulley combinations shown are for conventional speed-reduction ratios; same table can be used for speed step-up ratios by making proper correction of driveN speed and belt hp capacity per inch width.

■ Pulley diameter is below recommended minimum; if used reduced belt life must be expected.

† Center distances shown are **theoretical**; manufacturing tolerances of belt length and pulley diameters can affect actual operating drive center distances.



Stock Drive Selection

H 1/2" Pitch

center distance, inches†																	speed ratio □	
according to belt pitch length (PL), inches and corresponding code number (bold type)																		
PL: 45.00 90 teeth 450 H	PL: 48.00 96 teeth 480 H	PL: 51.00 102 teeth 510 H	PL: 54.00 108 teeth 540 H	PL: 57.00 114 teeth 570 H	PL: 60.00 120 teeth 600 H	PL: 63.00 126 teeth 630 H	PL: 66.00 132 teeth 660 H	PL: 70.00 140 teeth 700 H	PL: 75.00 150 teeth 750 H	PL: 80.00 160 teeth 800 H	PL: 85.00 170 teeth 850 H	PL: 90.00 180 teeth 900 H	PL: 100.00 200 teeth 1000 H	PL: 110.00 220 teeth 1100 H	PL: 125.00 250 teeth 1250 H	PL: 140.00 280 teeth 1400 H	PL: 170.00 340 teeth 1700 H	
10.51	12.01	13.51	15.01	16.51	18.01	19.51	21.01	23.01	25.51	28.01	30.51	33.01	38.01	43.01	50.51	58.01	73.01	
11.51	13.01	14.51	16.01	17.51	19.01	20.51	22.01	24.01	26.51	29.01	31.51	34.01	39.01	44.01	51.51	59.01	74.01	
12.51	14.01	15.51	17.01	18.51	20.01	21.51	23.01	25.01	27.51	30.01	32.51	35.01	40.01	45.01	52.51	60.01	75.01	
13.51	15.01	16.51	18.01	19.51	21.01	22.51	24.01	26.01	28.51	31.01	33.51	36.01	41.01	46.01	53.51	61.01	76.01	1.04
14.51	16.01	17.51	19.01	20.51	22.01	23.51	25.01	27.01	29.51	32.01	34.51	37.01	42.01	47.01	54.51	62.01	77.01	
15.01	16.51	18.01	19.51	21.01	22.51	24.01	25.51	27.51	30.01	32.51	35.01	37.51	42.51	47.51	55.01	62.51	77.51	
15.51	17.01	18.51	20.01	21.51	23.01	24.51	26.01	28.01	30.51	33.01	35.51	38.01	43.01	48.01	55.51	63.01	78.01	1.05
16.01	17.51	19.01	20.51	22.01	23.51	25.01	26.51	28.51	31.01	33.51	36.01	38.51	43.51	48.51	56.01	63.51	78.51	
16.51	18.01	19.51	21.01	22.51	24.01	25.51	27.01	29.01	31.51	34.01	36.51	39.01	44.01	49.01	56.51	64.01	79.01	
17.01	18.51	20.01	21.51	23.01	24.51	26.01	27.51	29.51	32.01	34.51	37.01	39.51	44.51	49.51	57.01	64.51	79.51	1.07
17.26	18.76	20.26	21.76	23.26	24.76	26.26	27.76	29.76	32.26	34.76	37.26	39.76	44.76	49.76	57.26	64.76	79.76	
17.51	19.01	20.51	22.01	23.51	25.01	26.51	28.01	30.01	32.51	35.01	37.51	40.01	45.01	50.01	57.51	65.01	80.01	
17.76	19.26	20.76	22.26	23.76	25.26	26.76	28.26	30.26	32.76	35.26	37.76	40.26	45.26	50.26	57.76	65.26	80.26	1.08
18.01	19.51	21.01	22.51	24.01	25.51	27.01	28.51	30.51	33.01	35.51	38.01	40.51	45.51	50.51	58.01	65.51	80.51	
18.51	20.01	21.51	23.01	24.51	26.01	27.51	29.01	31.01	33.51	36.01	38.51	41.01	46.01	51.01	58.51	66.01	81.01	
17.14	18.64	20.14	21.64	23.14	24.64	26.14	27.64	29.64	32.14	34.64	37.14	39.64	44.69	49.64	57.14	64.64	79.64	1.04
17.39	18.89	20.39	21.88	23.39	24.89	26.39	27.89	29.89	32.39	34.89	37.39	39.89	44.89	49.89	57.39	64.89	79.89	
17.64	19.14	20.64	22.14	23.64	25.14	26.64	28.14	30.14	32.64	35.14	37.64	40.14	45.14	50.14	57.64	65.14	80.14	
17.89	19.39	20.89	22.39	23.89	25.39	26.89	28.39	30.39	32.89	35.39	37.89	40.39	45.39	50.39	57.89	65.39	80.39	
14.76	16.26	17.76	19.26	20.76	22.26	23.76	25.26	27.26	29.76	32.26	34.76	37.26	42.26	47.26	54.76	62.26	77.26	1.07
15.26	16.76	18.26	19.76	21.26	22.76	24.26	25.76	27.76	30.26	32.76	35.26	37.76	42.76	47.76	55.26	62.76	77.76	
15.76	17.26	18.76	20.26	21.76	23.26	24.76	26.26	28.26	30.76	33.26	35.76	38.26	43.26	48.26	55.76	63.26	78.26	
16.26	17.76	19.26	20.76	22.26	23.76	25.26	26.76	28.76	31.26	33.76	36.26	38.76	43.76	48.76	56.26	63.76	78.76	1.08
11.00	12.50	14.00	15.51	17.01	18.51	20.01	21.51	23.51	26.01	28.51	31.00	33.51	38.51	43.51	51.01	58.51	73.51	
16.76	18.26	19.76	21.26	22.76	24.26	25.76	27.26	29.26	31.76	34.26	36.76	39.26	44.26	49.26	56.76	64.26	79.26	
12.00	13.50	15.01	16.51	18.01	19.51	21.01	22.51	24.51	27.01	29.51	32.01	34.51	39.51	44.51	52.01	59.51	74.51	1.10
17.26	18.75	20.36	21.76	23.26	24.76	26.26	27.76	29.76	32.26	34.76	37.26	39.76	44.76	49.76	57.26	64.76	79.76	
17.51	19.01	20.51	22.01	23.51	25.01	26.51	28.01	30.01	32.51	35.01	37.51	40.01	45.01	50.01	57.51	65.01	80.01	
13.00	14.50	16.01	17.51	19.01	20.51	22.01	23.51	25.51	28.01	30.51	33.01	35.51	40.51	45.51	53.01	60.51	75.51	1.11
17.76	19.26	20.76	22.26	23.76	25.26	26.76	28.26	30.26	32.76	35.26	37.76	40.26	45.26	50.26	57.76	65.26	80.26	
14.01	15.51	17.01	18.51	20.01	21.51	23.01	24.51	26.51	29.01	31.51	34.01	36.51	41.51	46.51	54.01	61.50	76.51	
18.26	19.76	21.26	22.76	24.26	25.76	27.26	28.76	30.76	32.26	35.76	38.26	40.76	45.76	50.76	58.26	65.76	80.76	1.13
15.01	16.51	18.01	19.51	21.01	22.51	24.01	25.51	27.51	30.01	32.51	35.01	37.51	42.51	47.51	55.01	62.51	77.51	
16.88	18.38	19.88	21.38	22.89	24.39	25.89	27.39	29.39	31.89	34.39	36.89	39.39	44.39	49.39	56.89	64.39	79.39	
15.51	17.01	18.51	20.01	21.51	23.01	24.51	26.01	28.01	30.51	33.01	35.51	38.01	43.01	48.01	55.51	63.01	78.01	1.15
17.38	18.88	20.39	21.89	23.39	24.89	26.39	27.89	29.89	32.39	34.89	37.39	39.89	44.86	49.89	57.39	64.89	79.89	
16.01	17.51	19.01	20.51	22.01	23.51	25.01	26.51	28.51	31.01	33.51	36.01	38.51	43.51	48.51	56.01	63.51	78.51	
17.63	19.13	20.63	22.13	23.64	25.14	26.64	28.14	30.14	32.64	35.14	37.64	40.14	45.14	50.14	57.64	65.14	80.14	1.17
16.51	18.01	19.51	21.01	22.51	24.01	25.51	27.01	29.01	31.51	34.01	36.51	39.01	44.01	49.01	56.51	64.01	79.01	
18.13	19.63	21.14	22.64	24.14	25.64	27.14	28.64	30.64	33.14	35.64	38.14	40.64	45.64	50.64	58.14	65.64	80.64	
11.49	12.99	14.49	16.00	17.50	19.00	20.50	22.00	24.00	26.51	29.00	31.50	34.00	39.01	44.00	51.51	59.01	74.01	1.20
14.25	15.75	17.25	18.75	20.25	21.76	23.26	24.76	26.76	29.26	31.76	34.26	36.76	41.76	46.76	54.26	61.76	76.76	
17.01	18.51	20.01	21.51	23.01	24.51	26.01	27.51	29.51	32.01	34.51	37.01	39.51	44.51	49.51	57.01	64.51	79.51	

Teeth in Mesh	F factor
6 or more	1.00
5	.80
4	.60
3	.40
2	.20

NOTE: Multiply the H.P. ratings shown in the Drive Section Tables by Factor "F" and the width correction factors shown below:

belt width	1/2	5/8	3/4	7/8	1	1 1/4	1 1/2	1 3/4	2	2 1/2	3	3 1/2	4	5	6	7	8
width factor	.42	.57	.71	.86	1.0	1.29	1.56	1.84	2.14	2.72	3.36	4.06	4.76	6.15	7.50	8.89	10.32

If the number of teeth in mesh (TIM) is 5 or less, the exact TIM is indicated by the number in a circle following the center distance.

H 1/2" Pitch

Stock Drive Selection



speed ratio □	pulley combination				driveN speed and hp capacity						center distance, inches†						
	driveR		driveN		3500 rpm driveR speed		1750 rpm driveR speed		1160 rpm driveR speed		according to belt pitch length (PL), inches and corresponding code number (bold type)						
	code: no. of grooves	pitch diameter in.	code: no. of grooves	pitch diameter in.	driveN speed rpm	hp for 1 inch belt	driveN speed rpm	hp for 1 inch belt	driveN speed rpm	hp for 1 inch belt	PL: 24.00 48 teeth 240 H	PL: 27.00 54 teeth 270 H	PL: 30.00 60 teeth 300 H	PL: 33.00 66 teeth 330 H	PL: 36.00 72 teeth 360 H	PL: 39.00 78 teeth 390 H	PL: 42.00 84 teeth 420 H
1.22	36 H	5.730	44 H	7.003	2864	18.89	1432	10.71	949	7.26	—	—	—	—	7.98	9.48	10.99
	18 H	2.865	22 H	3.501	2864	10.71 ■	1432	5.52 ■	949	3.68	7.01	8.50	10.00	11.51	13.01	14.51	16.01
1.23	26 H	4.138	32 H	5.093	2844	14.80	1422	7.88	943	5.28	—	6.24	7.74	9.24	10.75	12.25	13.75
1.24	21 H	3.342	26 H	4.138	2827	12.31 ■	1413	6.41	937	4.28	6.12	7.62	9.12	10.63	12.13	13.63	15.13
1.25	48 H	7.639	60 H	9.549	2800	—	1400	13.84	928	9.55	—	—	—	—	—	—	—
	32 H	5.093	40 H	6.366	2800	17.40	1400	9.60	928	6.48	—	—	7.48	8.98	10.49	11.99	—
	24 H	3.820	30 H	4.775	2800	13.82	1400	7.30	928	4.89	5.24	6.40	8.24	9.75	11.25	12.75	14.25
	16 H	2.546	20 H	3.183	2800	—	1400	4.91 ■	928	3.27 ■	7.50	9.00	10.50	12.01	13.51	15.01	16.51
1.26	19 H	3.024	24 H	3.820	2770	11.24 ■	1385	5.81 ■	918	3.88	6.64	8.12	9.63	11.13	12.63	14.13	15.63
1.27	22 H	3.501	28 H	4.456	2750	12.84	1375	6.71	911	4.48	5.74	7.24	8.74	10.25	11.75	13.25	14.75
1.29	28 H	4.456	36 H	5.730	2722	15.74	1361	8.46	902	5.68	—	5.47	6.98	8.47	9.99	11.49	13.00
1.30	20 H	3.183	26 H	4.138	2692	11.77 ■	1346	6.11	892	4.08	6.24	7.74	9.25	10.75	12.25	13.75	15.26
1.31	16 H	2.546	21 H	3.342	2666	—	1333	4.91 ■	884	3.27 ■	7.37	8.87	10.38	11.88	13.38	14.88	16.38
1.33	36 H	5.730	48 H	7.639	2625	18.89	1313	10.71	870	7.26	—	—	—	7.44	8.96	10.47	—
	30 H	4.775	40 H	6.366	2625	16.59	1313	9.03	870	6.08	—	—	6.20	7.72	9.22	10.73	12.24
	24 H	3.820	32 H	5.093	2625	13.82	1313	7.30	870	4.89	4.97	6.48	7.98	9.49	10.99	12.49	14.00
	21 H	3.342	28 H	4.456	2625	12.31 ■	1313	6.41	870	4.28	5.86	7.36	8.87	10.37	11.87	13.37	14.88
	18 H	2.865	24 H	3.820	2625	10.71 ■	1313	5.52 ■	870	3.68	6.74	8.24	9.75	11.25	12.75	14.25	15.76
1.36	44 H	7.003	60 H	9.549	2567	21.01	1283	12.84	851	8.80	—	—	—	—	—	—	—
	22 H	3.501	30 H	4.775	2567	12.84	1283	6.71	851	4.48	5.47	6.98	8.48	9.99	11.49	12.99	14.50
1.38	32 H	5.093	44 H	7.003	2545	17.40	1273	9.60	844	6.48	—	—	—	6.94	8.45	9.96	11.47
	26 H	4.138	36 H	5.730	2528	14.80	1264	7.88	838	5.28	—	5.70	7.21	8.72	10.23	11.73	13.24
	19 H	3.024	26 H	4.138	2558	11.24 ■	1279	5.81 ■	848	3.88	6.36	7.86	9.37	10.87	12.37	13.87	15.38
	16 H	2.546	22 H	3.501	2545	—	1273	4.91 ■	844	3.27 ■	7.24	8.75	10.25	11.75	13.25	14.75	16.25
1.40	20 H	3.183	28 H	4.456	2500	11.77 ■	1250	6.11	829	4.08	5.97	7.48	8.99	10.49	11.99	13.49	15.00
1.43	28 H	4.456	40 H	6.366	2450	15.74	1225	8.46	812	5.68	—	—	6.50	7.95	9.46	10.97	12.47
	21 H	3.342	30 H	4.775	2450	12.31 ■	1225	6.41	812	4.28	5.59	7.10	8.60	10.11	11.61	13.11	14.62
1.44	18 H	2.865	26 H	4.138	2423	10.71 ■	1212	5.52 ■	803	3.68	6.48	7.98	9.49	10.99	12.49	14.00	15.50
1.45	22 H	3.501	32 H	5.093	2406	12.84	1203	6.71	798	4.48	5.20	6.71	8.22	9.73	11.23	12.73	14.24
1.46	30 H	4.775	44 H	7.003	2386	16.59	1193	9.03	791	6.08	—	—	—	7.17	8.68	10.20	11.70
1.47	19 H	3.024	28 H	4.456	2375	11.24 ■	1187	5.81 ■	787	3.88	6.09	7.60	9.11	10.61	12.11	13.62	15.12
1.50	48 H	7.639	72 H	11.459	2333	21.63	1167	13.84	773	9.55	—	—	—	—	—	—	—
	40 H	6.366	60 H	9.549	2333	20.08	1167	11.79	773	8.03	—	—	—	—	—	—	8.35
	32 H	5.093	48 H	7.639	2333	17.40	1167	9.60	773	6.48	—	—	—	7.90	9.42	10.93	—
	24 H	3.820	36 H	5.730	2333	13.82	1167	7.30	773	4.89	—	5.93	7.44	8.96	10.46	11.97	13.48
	20 H	3.183	30 H	4.775	2333	11.77 ■	1167	6.11	773	4.08	5.70	7.21	8.72	10.23	11.73	13.24	14.74
1.52	16 H	2.546	24 H	3.820	2333	—	1167	4.91 ■	773	3.27 ■	6.98	8.48	9.99	11.49	12.99	14.50	16.00
1.54	21 H	3.342	32 H	5.093	2297	12.31 ■	1148	6.41	761	4.28	5.31	6.83	8.34	9.84	11.35	12.85	14.45
1.54	26 H	4.138	40 H	6.366	2275	14.80	1138	7.88	754	5.28	—	—	6.66	8.18	9.69	11.20	12.71

□ Pulley combinations shown are for conventional speed-reduction ratios; same table can be used for speed step-up ratios by making proper correction of driveN speed and belt hp capacity per inch width.

■ Pulley diameter is below recommended minimum; if used reduced belt life must be expected.

† Center distances shown are **theoretical**; manufacturing tolerances of belt length and pulley diameters can affect actual operating drive center distances.



Stock Drive Selection

H 1/2" Pitch

center distance, inches†																	speed ratio □	
according to belt pitch length (PL), inches and corresponding code number (bold type)																		
PL: 45.00 90 teeth 450 H	PL: 48.00 96 teeth 480 H	PL: 51.00 102 teeth 510 H	PL: 54.00 108 teeth 540 H	PL: 57.00 114 teeth 570 H	PL: 60.00 120 teeth 600 H	PL: 63.00 126 teeth 630 H	PL: 66.00 132 teeth 660 H	PL: 70.00 140 teeth 700 H	PL: 75.00 150 teeth 750 H	PL: 80.00 160 teeth 800 H	PL: 85.00 170 teeth 850 H	PL: 90.00 180 teeth 900 H	PL: 100.00 200 teeth 1000 H	PL: 110.00 220 teeth 1100 H	PL: 125.00 250 teeth 1250 H	PL: 140.00 280 teeth 1400 H	PL: 170.00 340 teeth 1700 H	
12.49	13.99	15.50	17.00	18.50	20.00	21.50	23.00	25.00	27.50	30.00	32.50	35.01	40.01	45.01	52.51	60.01	75.01	
17.51	19.01	20.51	22.01	23.51	25.01	26.51	28.01	30.01	32.51	35.01	37.50	40.04	45.01	50.01	57.51	65.01	80.01	
15.24	16.75	18.25	19.76	21.25	22.76	24.26	25.76	27.76	30.25	32.76	36.26	37.76	42.76	47.76	55.26	62.76	77.76	1.23
16.63	18.13	19.63	21.13	22.63	24.13	25.63	27.13	29.13	31.63	34.13	36.63	39.14	44.14	49.14	56.64	64.14	79.14	1.24
8.95	10.46	11.97	13.47	14.98	16.48	17.98	19.48	21.49	23.99	26.49	28.99	31.50	36.50	41.50	49.00	56.50	71.50	1.25
13.49	15.00	16.50	18.00	19.50	21.00	22.50	24.00	26.00	28.50	31.00	33.50	36.01	41.00	46.01	53.51	61.01	76.01	
15.75	17.25	18.80	20.25	21.76	23.26	24.76	26.25	28.26	30.76	33.26	35.75	38.26	43.26	48.26	55.76	63.26	78.26	
18.01	19.51	21.01	22.51	24.01	25.51	27.01	28.51	30.51	33.01	35.51	38.01	40.51	45.51	50.51	58.01	65.51	80.51	
17.13	18.63	20.13	21.63	23.13	24.63	26.13	27.63	29.64	32.13	34.64	37.13	39.64	44.64	49.64	57.14	64.64	79.64	1.26
16.25	17.75	19.25	20.76	22.26	23.76	25.26	26.76	28.76	31.26	33.76	36.26	38.76	43.76	48.76	56.26	63.76	78.76	1.27
14.50	16.00	17.50	19.00	20.50	22.00	23.50	25.00	27.00	29.50	32.00	34.51	37.01	42.01	47.01	54.51	62.01	77.01	1.29
16.75	18.25	19.76	21.26	22.76	24.26	25.76	27.26	29.26	31.29	34.26	36.76	39.25	44.26	49.26	56.76	64.26	79.26	1.30
17.88	19.38	20.88	22.38	23.88	25.38	26.88	28.38	30.38	32.88	35.39	37.89	40.39	45.39	50.39	57.89	65.39	80.39	1.31
11.97	13.47	14.98	16.48	17.98	19.49	20.99	22.48	24.49	26.99	29.49	32.00	34.50	39.50	44.50	52.00	59.50	74.51	1.33
13.74	15.24	16.74	18.24	19.74	21.25	22.75	24.25	26.25	28.75	31.25	33.75	36.25	41.25	46.25	53.75	61.26	76.26	
15.50	17.00	18.50	20.00	21.50	23.00	24.50	26.00	28.00	30.50	33.00	35.51	38.01	43.00	48.01	55.51	63.01	78.01	
16.38	17.88	19.38	20.88	22.38	23.88	25.38	26.88	28.88	31.38	33.88	36.38	38.88	43.88	48.88	56.38	63.88	78.88	
17.25	18.80	20.26	21.76	23.26	24.76	26.25	27.76	29.76	32.25	34.76	37.26	39.76	44.76	49.76	57.26	64.76	79.76	
9.42	10.93	12.44	13.95	15.45	16.96	18.46	19.97	21.97	24.48	26.98	29.48	31.98	36.99	41.99	49.49	57.00	72.00	1.36
16.00	17.50	19.00	20.50	22.00	23.50	25.00	26.50	28.50	31.00	33.51	36.01	38.50	43.51	48.51	56.01	63.51	78.51	
12.97	14.48	15.98	17.48	18.99	20.49	21.99	23.49	25.49	27.99	30.50	33.00	35.50	40.50	45.50	53.00	60.50	75.51	1.38
14.74	16.24	17.74	19.24	20.75	22.25	23.75	25.25	27.25	29.75	32.25	34.75	37.25	42.25	47.25	54.76	62.26	77.26	
16.88	18.38	19.88	21.38	22.88	24.38	25.88	27.38	29.38	31.88	34.38	36.88	39.38	44.38	49.38	56.88	64.38	79.38	
17.76	19.26	20.76	22.26	23.76	25.26	26.76	28.26	30.26	32.76	35.26	37.76	40.26	45.26	50.26	57.76	65.26	80.26	
16.50	18.00	19.50	21.00	22.50	24.00	25.50	27.00	29.01	31.50	34.01	36.50	39.01	44.00	49.01	56.51	64.01	79.01	1.40
13.98	15.48	16.98	18.48	19.99	21.49	22.99	24.49	26.49	29.00	31.50	34.00	36.50	41.50	46.50	54.00	61.50	76.50	1.43
16.12	17.62	19.12	20.62	22.12	23.63	25.13	26.63	28.63	31.13	33.63	36.13	38.63	43.63	48.63	56.13	63.63	78.64	
17.00	18.50	20.00	21.50	23.00	24.50	26.01	27.50	29.51	32.01	34.51	37.01	39.51	44.51	49.51	57.01	64.51	79.51	1.44
15.74	17.24	18.74	20.24	21.75	23.18	24.75	26.25	28.25	30.75	33.25	35.75	38.25	43.25	48.25	55.76	63.25	78.26	1.45
13.21	14.72	16.22	17.72	19.23	20.73	22.23	23.73	25.74	28.24	30.74	33.24	35.74	40.75	45.75	53.25	60.41	75.75	1.46
16.62	18.12	19.62	21.12	22.62	24.13	25.63	27.13	29.14	31.63	34.13	36.63	39.13	44.13	49.13	56.63	64.13	79.14	1.47
—	—	10.33	11.85	13.37	14.88	16.40	17.91	19.92	22.43	24.94	27.44	29.95	34.96	39.96	47.47	54.98	69.99	1.50
9.88	11.40	12.91	14.42	15.93	17.44	18.94	20.45	22.45	24.96	27.46	29.97	32.47	37.48	42.48	49.98	57.49	72.49	
12.44	13.95	15.46	16.97	18.47	19.97	21.47	22.97	24.98	27.48	29.98	32.49	34.99	39.99	44.99	52.50	60.00	74.99	
14.98	16.48	17.98	19.49	20.99	22.49	23.99	25.49	27.49	30.00	32.50	35.00	37.50	42.50	47.50	55.00	62.50	77.51	
16.24	17.74	19.24	20.75	22.25	23.75	25.25	26.75	28.75	31.25	33.75	36.25	38.75	43.76	48.76	56.27	63.75	78.76	
17.50	19.00	20.50	22.00	23.50	25.00	26.50	28.00	30.01	32.51	35.01	37.50	40.01	45.02	50.01	57.51	65.01	80.01	
15.86	17.36	18.86	20.37	21.87	23.37	24.87	26.32	28.37	30.87	33.38	35.88	38.38	43.38	48.38	55.88	63.88	78.38	1.52
14.21	15.72	17.22	18.73	20.23	21.73	23.23	24.74	26.74	29.24	31.74	34.24	36.75	41.75	46.75	54.25	61.75	76.75	1.54

Teeth in Mesh	F factor
6 or more	1.00
5	.80
4	.60
3	.40
2	.20

NOTE: Multiply the H.P. ratings shown in the Drive Section Tables by Factor "F" and the width correction factors shown below:

belt width	1/2	5/8	3/4	7/8	1	1 1/4	1 1/2	1 3/4	2	2 1/2	3	3 1/2	4	5	6	7	8
width factor	.42	.57	.71	.86	1.0	1.29	1.56	1.84	2.14	2.72	3.36	4.06	4.76	6.15	7.50	8.89	10.32

If the number of teeth in mesh (TIM) is 5 or less, the exact TIM is indicated by the number in a circle following the center distance.

H 1/2" Pitch

Stock Drive Selection



speed ratio □	pulley combination				driveN speed and hp capacity						center distance, inches†						
	driveR		driveN		3500 rpm driveR speed		1750 rpm driveR speed		1160 rpm driveR speed		according to belt pitch length (PL), inches and corresponding code number (bold type)						
	code: no. of grooves	pitch diameter in.	code: no. of grooves	pitch diameter in.	driveN speed rpm	hp for 1 inch belt	driveN speed rpm	hp for 1 inch belt	driveN speed rpm	hp for 1 inch belt	PL: 24.00 48 teeth 240 H	PL: 27.00 54 teeth 270 H	PL: 30.00 60 teeth 300 H	PL: 33.00 66 teeth 330 H	PL: 36.00 72 teeth 360 H	PL: 39.00 78 teeth 390 H	PL: 42.00 84 teeth 420 H
1.56	18 H	2.865	28 H	4.456	2250	10.71 ■	1125	5.52 ■	746	3.68	6.21	7.72	9.22	10.73	12.23	13.74	15.24
1.57	28 H	4.456	44 H	7.003	2227	15.74	1114	8.46	738	5.68	—	—	—	7.40	8.92	10.43	11.94
1.58	19 H	3.024	30 H	4.775	2217	11.24 ■	1108	5.81 ■	735	3.88	5.82	7.33	8.84	10.35	11.85	13.36	14.86
1.60	30 H	4.775	48 H	7.639	2188	16.59	1094	9.03	725	6.08	—	—	—	6.60	8.13	9.65	11.17
	20 H	3.183	32 H	5.093	2188	11.77 ■	1094	6.11	725	4.08	5.42	6.94	8.45	9.96	11.47	12.97	14.48
1.63	44 H	7.003	72 H	11.459	2139	21.01	1069	12.84	709	8.80	—	—	—	—	—	—	—
	22 H	3.501	36 H	5.730	2139	12.84	1069	6.71	709	4.48	—	—	—	—	—	—	—
	16 H	2.546	26 H	4.138	2154	—	1077	4.91 ■	714	3.27 ■	6.71	8.22	9.73	11.23	12.73	14.24	15.74
1.67	36 H	5.730	60 H	9.549	2100	18.89	1050	10.71	696	7.26	—	—	—	—	—	—	8.80
	24 H	3.820	40 H	6.366	2100	13.82	1050	7.30	696	4.89	—	—	—	6.89	8.41	9.93	11.44
	18 H	2.865	30 H	4.775	2100	10.71 ■	1050	5.52 ■	696	3.68	5.93	7.45	8.96	10.46	11.97	13.48	14.98
1.68	19 H	3.024	32 H	5.093	2078	11.24 ■	1039	5.81 ■	689	3.88	5.54	7.06	8.57	10.08	11.59	13.09	14.60
1.69	26 H	4.138	44 H	7.003	2068	14.80	1034	7.88	685	5.28	—	—	—	6.09	7.62	9.15	10.66
1.71	28 H	4.456	48 H	7.639	2042	15.74	1021	8.46	677	5.68	—	—	—	6.82	8.35	9.88	11.40
	21 H	3.342	36 H	5.730	2042	12.31 ■	1021	6.41	677	4.28	4.73	6.27	7.79	9.31	10.82	12.33	13.83
1.75	48 H	7.639	84 H	13.369	2000	21.63	1000	13.84	663	9.55	—	—	—	—	—	—	—
	16 H	2.546	28 H	4.456	2000	—	1000	4.91 ■	663	3.27 ■	6.44	7.95	9.46	10.97	12.47	13.98	15.48
1.78	18 H	2.865	32 H	5.093	1969	10.71 ■	985	5.52 ■	652	3.68	5.65	7.17	8.69	10.20	11.71	13.21	14.72
1.80	40 H	6.366	72 H	11.459	1944	20.08	972	11.79	644	8.03	—	—	—	—	—	—	—
	20 H	3.183	36 H	5.730	1944	11.77 ■	972	6.11	644	4.08	4.84	6.38	7.90	9.42	10.93	12.44	13.95
1.82	22 H	3.501	40 H	6.366	1925	12.84	963	6.71	638	4.48	—	5.57	7.11	8.64	10.16	11.67	13.18
1.83	24 H	3.820	44 H	7.003	1909	13.82	955	7.30	633	4.89	—	—	—	6.30	7.84	9.37	10.89
1.85	26 H	4.138	48 H	7.639	1896	14.80	948	7.88	628	5.28	—	—	—	7.04	8.58	10.11	11.63
1.88	32 H	5.093	60 H	9.549	1867	17.40	933	9.60	619	6.48	—	—	—	—	—	7.68	9.24
	16 H	2.546	30 H	4.775	1867	—	933	4.91 ■	619	3.27 ■	6.16	7.68	9.19	10.70	12.21	13.71	15.22
1.89	19 H	3.024	36 H	5.730	1847	11.24 ■	924	5.81 ■	612	3.88	4.94	6.49	8.02	9.54	11.06	12.56	14.07
1.90	21 H	3.342	40 H	6.366	1838	12.31 ■	919	6.41	609	4.28	—	5.68	7.22	8.75	10.27	11.79	13.30
1.91	44 H	7.003	84 H	13.369	1833	21.01	917	12.84	607	8.80	—	—	—	—	—	—	—
2.00	48 H	7.639	96 H	15.279	1750	21.63	875	13.84	580	9.55	—	—	—	—	—	—	—
	36 H	5.730	72 H	11.459	1750	18.89	875	10.71	580	7.26	—	—	—	—	—	—	—
	30 H	4.775	60 H	9.549	1750	16.59	875	9.03	580	6.08	—	—	—	—	—	7.89	9.45
	24 H	3.820	48 H	7.639	1750	13.82	875	7.30	580	4.89	—	—	—	7.25	8.80	10.33	11.85
	22 H	3.501	44 H	7.003	1750	12.84	875	6.71	580	4.48	—	—	6.52	8.07	9.60	11.12	12.64
	20 H	3.183	40 H	6.366	1750	11.77 ■	875	6.11 ■	580	4.08	—	5.78	7.33	8.86	10.39	11.90	13.41
	18 H	2.865	36 H	5.730	1750	10.71 ■	875	5.52 ■	580	3.68	5.05	6.60	8.13	9.65	11.16	12.68	14.19
	16 H	2.546	32 H	5.093	1750	—	875	4.91 ■	580	3.27 ■	5.87	7.40	8.92	10.43	11.94	13.45	14.96
2.09	21 H	3.342	44 H	7.003	1670	12.31 ■	835	6.41	554	4.28	—	—	—	6.63	8.18	9.71	11.23
2.10	40 H	6.366	84 H	13.369	1667	20.08	833	11.79	552	8.03	—	—	—	—	—	—	—
2.11	19 H	3.024	40 H	6.366	1663	11.24 ■	831	5.81 ■	551	3.88	—	5.89	7.44	8.98	10.50	12.02	13.53

□ Pulley combinations shown are for conventional speed-reduction ratios; same table can be used for speed step-up ratios by making proper correction of driveN speed and belt hp capacity per inch width.

■ Pulley diameter is below recommended minimum; if used reduced belt life must be expected.

† Center distances shown are **theoretical**; manufacturing tolerances of belt length and pulley diameters can affect actual operating drive center distances.



Stock Drive Selection

H 1/2" Pitch

center distance, inches†																	speed ratio □	
according to belt pitch length (PL), inches and corresponding code number (bold type)																		
PL: 45.00 90 teeth 450 H	PL: 48.00 96 teeth 480 H	PL: 51.00 102 teeth 510 H	PL: 54.00 108 teeth 540 H	PL: 57.00 114 teeth 570 H	PL: 60.00 120 teeth 600 H	PL: 63.00 126 teeth 630 H	PL: 66.00 132 teeth 660 H	PL: 70.00 140 teeth 700 H	PL: 75.00 150 teeth 750 H	PL: 80.00 160 teeth 800 H	PL: 85.00 170 teeth 850 H	PL: 90.00 180 teeth 900 H	PL: 100.00 200 teeth 1000 H	PL: 110.00 220 teeth 1100 H	PL: 125.00 250 teeth 1250 H	PL: 140.00 280 teeth 1400 H	PL: 170.00 340 teeth 1700 H	
16.74	18.24	19.75	21.25	22.75	24.25	25.75	27.25	29.25	31.75	34.25	36.49	39.25	44.26	49.25	56.75	64.26	79.26	
13.45	14.95	16.46	17.96	19.47	20.97	22.47	23.98	25.98	28.48	30.99	33.49	35.99	40.99	45.99	53.50	61.00	76.00	1.57
16.36	17.86	19.37	20.87	22.37	23.87	25.37	26.87	28.87	31.37	33.88	36.38	38.88	43.88	48.88	56.38	63.88	78.88	1.58
12.68	14.19	15.69	17.20	18.70	20.21	21.71	23.22	25.22	27.72	30.23	32.13	35.23	40.24	45.24	52.74	60.25	75.25	1.60
15.98	17.48	18.99	20.49	21.99	23.49	24.99	26.49	28.50	31.00	33.50	36.00	38.50	43.50	48.50	56.00	63.52	78.51	
—	—	10.77	12.30	13.83	15.35	16.86	18.37	20.39	22.99	25.42	27.92	30.43	35.44	40.45	47.96	55.47	70.48	1.63
15.22	16.72	18.23	19.73	21.23	22.73	24.24	25.78	27.74	30.24	32.74	35.24	37.75	42.75	47.75	55.25	62.75	77.76	
17.24	18.74	20.25	21.75	23.18	24.75	26.25	27.75	29.75	32.25	34.75	37.25	39.76	44.76	49.76	57.25	64.76	79.77	
10.33	11.85	13.37	14.88	16.40	17.91	19.42	20.92	22.93	25.44	27.94	30.45	32.95	37.96	42.97	50.48	57.98	72.99	1.67
14.45	15.96	17.46	18.97	20.47	21.97	23.48	24.98	26.98	29.48	31.99	34.49	36.99	41.99	47.00	54.50	62.00	77.01	
16.48	17.96	19.49	20.99	22.49	23.99	25.49	26.99	29.00	31.50	34.00	36.50	39.00	44.00	49.00	56.51	64.01	79.01	
16.10	17.60	19.11	20.61	22.11	23.61	25.12	26.62	28.62	31.12	33.62	36.12	38.62	43.63	48.63	56.13	63.63	78.63	1.68
13.68	15.19	16.70	18.20	19.71	21.21	22.72	24.22	26.22	28.73	31.23	33.73	36.23	41.24	46.24	53.74	61.25	76.25	1.69
12.91	14.42	15.93	17.44	18.94	20.45	21.95	23.46	25.46	27.97	30.47	32.97	35.48	40.48	45.48	52.99	60.49	75.49	1.71
15.34	16.84	18.35	19.85	21.35	22.86	24.36	25.86	27.86	30.36	32.87	35.37	37.87	42.87	47.87	55.37	62.88	77.88	
—	—	—	—	11.65	13.19	14.73	16.25	18.28	20.81	23.33	25.85	28.34	33.39	38.40	45.92	53.43	68.45	1.75
16.98	18.49	19.99	21.49	22.99	24.49	26.00	27.49	29.50	32.00	34.50	37.00	39.50	44.50	49.50	57.01	64.50	79.51	
16.22	17.73	19.23	20.73	22.23	23.73	25.24	26.74	28.74	31.24	33.74	36.24	38.75	43.75	48.75	56.25	63.75	78.77	1.78
—	9.67	11.22	12.75	14.28	15.81	17.32	18.84	20.85	23.37	25.88	28.40	30.90	35.92	40.93	48.44	55.95	70.97	1.80
15.46	16.96	18.47	19.97	21.47	22.98	24.48	25.98	28.47	30.99	32.99	35.49	37.99	42.99	48.00	55.50	63.00	78.00	
14.69	16.20	17.70	19.21	20.71	22.21	23.72	25.22	27.22	29.73	32.23	34.73	37.23	42.24	47.24	54.74	62.25	77.25	1.82
13.92	15.43	16.93	18.44	19.95	21.45	22.96	24.46	26.46	28.97	31.47	33.97	36.48	41.48	46.48	53.99	61.49	76.50	1.83
13.14	14.65	16.16	17.67	19.18	20.68	22.19	23.69	25.70	28.21	30.71	33.21	35.72	40.72	45.73	53.24	60.74	75.74	1.85
10.78	12.31	13.83	15.35	16.86	18.37	19.88	21.39	23.40	25.91	28.42	30.93	33.44	38.45	43.45	50.96	58.47	73.48	1.88
16.72	18.23	19.73	21.23	22.73	24.24	25.74	27.24	29.24	31.74	34.24	36.75	39.25	44.25	49.25	56.75	64.26	79.26	
15.58	17.08	18.59	20.09	21.59	23.10	24.60	26.10	28.10	30.61	33.11	35.61	38.11	43.12	48.12	55.63	63.12	78.13	1.89
14.81	16.31	17.82	19.33	20.83	22.33	23.84	25.34	27.34	29.85	32.35	34.85	37.36	42.36	47.36	54.87	62.37	77.37	1.90
—	—	—	10.52	12.08	13.63	15.17	16.70	18.74	21.27	23.79	26.32	28.83	33.86	38.88	46.40	53.92	68.94	1.91
—	—	—	—	—	—	12.94	14.50	16.56	19.12	21.67	24.21	26.74	31.78	36.81	44.35	51.87	66.90	2.00
8.52	10.10	11.65	13.19	14.73	16.25	17.78	19.29	21.32	23.82	26.35	28.87	31.38	36.40	41.41	48.93	56.44	71.45	
11.00	12.53	14.06	15.58	17.09	18.61	20.35	21.63	23.64	26.15	28.66	31.17	33.68	38.69	43.70	51.21	58.71	73.73	
13.37	14.89	16.40	17.91	19.42	20.92	22.43	23.93	25.94	28.45	30.95	33.46	35.96	40.97	45.97	53.48	60.98	75.99	
14.15	15.66	17.17	18.68	20.18	21.69	23.19	24.70	26.70	29.21	31.71	34.22	36.72	41.73	46.73	54.22	61.74	76.74	
14.92	16.43	17.94	19.45	20.95	22.45	23.96	25.46	27.47	29.97	32.47	34.97	37.48	42.48	47.48	54.99	62.49	77.50	
15.69	17.20	18.71	20.21	21.71	23.22	24.72	26.22	28.23	30.73	33.23	35.73	38.24	43.24	48.24	55.74	63.24	78.25	
16.46	17.97	19.47	20.97	22.48	23.98	25.48	26.98	28.99	31.48	33.99	36.49	38.99	43.99	49.00	56.50	64.00	79.01	
14.27	15.78	17.29	18.80	20.30	21.81	23.31	24.82	26.82	29.33	31.83	34.34	36.84	41.85	46.85	54.36	61.86	76.87	2.09
—	—	—	10.94	12.51	14.07	15.61	17.15	19.19	21.73	24.26	26.78	29.30	34.33	39.35	46.88	54.40	69.42	2.10
15.04	16.55	18.06	19.56	21.07	22.57	24.08	25.58	27.59	30.09	32.59	35.10	37.60	42.60	47.61	55.11	62.61	77.62	2.11

Teeth in Mesh F factor

6 or more	1.00
5	.80
4	.60
3	.40
2	.20

NOTE: Multiply the H.P. ratings shown in the Drive Section Tables by Factor "F" and the width correction factors shown below:

belt width	1/2	5/8	3/4	7/8	1	1 1/4	1 1/2	1 3/4	2	2 1/2	3	3 1/2	4	5	6	7	8
width factor	.42	.57	.71	.86	1.0	1.29	1.56	1.84	2.14	2.72	3.36	4.06	4.76	6.15	7.50	8.89	10.32

If the number of teeth in mesh (TIM) is 5 or less, the exact TIM is indicated by the number in a circle following the center distance.

H 1/2" Pitch

Stock Drive Selection



speed ratio □	pulley combination				driveN speed and hp capacity						center distance, inches†						
	driveR		driveN		3500 rpm driveR speed		1750 rpm driveR speed		1160 rpm driveR speed		according to belt pitch length (PL), inches and corresponding code number (bold type)						
	code: no. of grooves	pitch diameter in.	code: no. of grooves	pitch diameter in.	driveN speed rpm	hp for 1 inch belt	driveN speed rpm	hp for 1 inch belt	driveN speed rpm	hp for 1 inch belt	PL: 24.00 48 teeth 240 H	PL: 27.00 54 teeth 270 H	PL: 30.00 60 teeth 300 H	PL: 33.00 66 teeth 330 H	PL: 36.00 72 teeth 360 H	PL: 39.00 78 teeth 390 H	PL: 42.00 84 teeth 420 H
2.14	28 H	4.456	60 H	9.549	1633	15.74	817	8.46	541	5.68	—	—	—	—	—	8.10	9.67
	14 H	2.228	30 H	4.775	1633	—	817	—	541	2.86 ■	6.38	7.90	9.42	10.94	12.44	13.95	15.46
2.18	44 H	7.003	96 H	15.279	1604	21.01	802	12.84	532	8.80	—	—	—	—	—	—	—
	22 H	3.501	48 H	7.639	1604	12.84	802	6.71	532	4.48	—	—	—	7.47	9.02	10.55	12.08
2.20	20 H	3.183	44 H	7.003	1590	11.77 ■	795	6.11	527	4.08	—	—	6.73	8.29	9.82	11.35	12.87
2.22	18 H	2.865	40 H	6.366	1575	10.71 ■	788	5.52 ■	522	3.68	—	6.00	7.55	9.09	10.61	12.13	13.65
2.25	32 H	5.093	72 H	11.459	1556	17.40	778	9.60	516	6.48	—	—	—	—	—	—	—
	16 H	2.546	36 H	5.730	1556	—	778	4.91 ■	516	3.27 ■	5.26	6.82	8.36	9.88	11.40	12.91	14.42
2.29	21 H	3.342	48 H	7.639	1531	12.31 ■	766	6.41	507	4.28	—	4.34	5.99	7.57	9.13	10.67	12.19
2.31	26H	4.138	60 H	9.549	1517	14.80	758	7.88	503	5.28	—	—	—	—	—	8.31	9.88
	19 H	3.024	44 H	7.003	1511	11.24 ■	756	5.81 ■	501	3.88	—	5.25	6.84	8.40	9.93	11.46	12.98
2.33	36 H	5.730	84 H	13.369	1500	18.89	750	10.71	497	7.26	—	—	—	—	—	—	—
2.40	40 H	6.366	96 H	15.279	1458	20.08	729	11.79	483	8.03	—	—	—	—	—	—	—
	30 H	4.775	72 H	11.459	1458	16.59	729	9.03	483	6.08	—	—	—	—	—	—	—
	20 H	3.183	48 H	7.639	1458	11.77 ■	729	6.11	483	4.08	—	—	6.09	7.68	9.24	10.78	12.31
2.44	18 H	2.865	44 H	7.003	1432	10.71 ■	716	5.52 ■	475	3.68	—	5.35	6.95	8.50	10.04	11.57	13.09
2.50	48 H	7.639	120 H	19.099	1400	21.63	700	13.84	464	9.55	—	—	—	—	—	—	—
	24 H	3.820	60 H	9.549	1400	13.82	700	7.30	464	4.89	—	—	—	—	—	8.52	10.10
	16 H	2.546	40 H	6.366	1400	—	700	4.91 ■	464	3.27 ■	—	6.21	7.77	9.31	10.84	12.36	13.88
2.53	19 H	3.024	48 H	7.639	1385	11.24	693	5.81 ■	459	3.88	—	—	6.20	7.79	9.35	10.89	12.42
2.57	28 H	4.456	72 H	11.459	1361	15.74	681	8.46	451	5.68	—	—	—	—	—	—	—
2.63	32 H	5.093	84 H	13.369	1333	17.40	667	9.60	442	6.48	—	—	—	—	—	—	—
2.67	36 H	5.730	96 H	15.279	1312	18.89	656	10.71	435	7.26	—	—	—	—	—	—	—
	18 H	2.865	48 H	7.639	1312	10.71 ■	656	5.52 ■	435	3.68	—	—	6.30	7.89	9.45	11.00	12.53
2.73	44 H	7.003	120 H	19.099	1283	21.01	642	12.84	425	8.80	—	—	—	—	—	—	—
	22 H	3.501	60 H	9.549	1283	12.84	642	6.71	425	4.48	—	—	—	—	7.10	8.73	10.31
2.75	16 H	2.546	44 H	7.003	1272	—	636	4.91 ■	422	3.27 ■	—	5.55 ⑤	7.16	8.72	10.26	11.80	13.32
2.77	26 H	4.138	72 H	11.459	1264	14.80	632	7.88	419	5.28	—	—	—	—	—	—	—
2.80	30 H	4.775	84 H	13.369	1250	16.59	625	9.03	414	6.08	—	—	—	—	—	—	—
2.86	21 H	3.342	60 H	9.549	1225	12.31 ■	613	6.41	406	4.28	—	—	—	—	7.20	8.83	10.42
3.00	40 H	6.366	120 H	19.099	1167	20.08	583	11.79	387	8.03	—	—	—	—	—	—	—
	32 H	5.093	96 H	15.279	1167	17.40	583	9.60	387	6.48	—	—	—	—	—	—	—
	28 H	4.456	84 H	13.369	1167	15.74	583	8.46	387	5.68	—	—	—	—	—	—	—
	24 H	3.820	72 H	11.459	1167	13.82	583	7.30	387	4.89	—	—	—	—	—	—	8.08
	20 H	3.183	60 H	9.549	1167	11.77 ■	583	6.11	387	4.08	—	—	—	—	7.30	8.93	10.52
3.16	19 H	3.024	60 H	9.549	1108	11.24 ■	554	5.81 ■	367	3.88	—	—	—	5.66	7.40	9.04	10.63
3.20	30 H	4.775	96 H	15.279	1094	16.59	547	9.03	363	6.08	—	—	—	—	—	—	—
3.23	26 H	4.138	84 H	13.369	1084	14.80	542	7.88	359	5.28	—	—	—	—	—	—	—

□ Pulley combinations shown are for conventional speed-reduction ratios; same table can be used for speed step-up ratios by making proper correction of driveN speed and belt hp capacity per inch width.

■ Pulley diameter is below recommended minimum; if used reduced belt life must be expected.

† Center distances shown are **theoretical**; manufacturing tolerances of belt length and pulley diameters can affect actual operating drive center distances.



Stock Drive Selection

H 1/2" Pitch

center distance, inches†																	speed ratio □	
according to belt pitch length (PL), inches and corresponding code number (bold type)																		
PL: 45.00 90 teeth 450 H	PL: 48.00 96 teeth 480 H	PL: 51.00 102 teeth 510 H	PL: 54.00 108 teeth 540 H	PL: 57.00 114 teeth 570 H	PL: 60.00 120 teeth 600 H	PL: 63.00 126 teeth 630 H	PL: 66.00 132 teeth 660 H	PL: 70.00 140 teeth 700 H	PL: 75.00 150 teeth 750 H	PL: 80.00 160 teeth 800 H	PL: 85.00 170 teeth 850 H	PL: 90.00 180 teeth 900 H	PL: 100.00 200 teeth 1000 H	PL: 110.00 220 teeth 1100 H	PL: 125.00 250 teeth 1250 H	PL: 140.00 280 teeth 1400 H	PL: 170.00 340 teeth 1700 H	
11.21	12.75	14.28	15.80	17.32	18.84	20.35	21.86	23.87	26.39	28.90	31.41	33.91	38.93	43.94	51.45	58.95	73.97	2.14
16.96	18.47	19.97	21.47	22.98	24.48	25.98	27.48	29.48	31.99	34.49	36.99	39.49	44.49	49.50	57.01	64.50	79.50	
—	—	6.68	8.47	10.15	11.77	13.36	14.93	17.00	19.57	22.12	24.66	27.19	32.13	37.28	44.82	52.35	67.38	2.18
13.60	15.12	16.63	18.14	19.65	21.16	22.67	24.17	26.18	28.69	31.19	33.70	36.20	41.21	46.22	53.72	61.23	76.24	
14.38	15.89	17.40	18.91	20.42	21.93	23.43	24.94	26.94	29.45	31.95	34.46	36.96	41.97	46.97	54.48	61.98	76.99	2.20
15.16	16.67	18.18	19.68	21.19	22.69	24.20	25.70	27.71	30.21	32.71	35.22	37.72	42.73	47.73	55.23	62.74	77.74	2.22
8.93	10.52	12.08	13.63	15.17	16.70	18.23	19.75	21.78	24.30	26.82	29.34	31.85	36.87	41.89	49.41	56.92	71.94	2.25
15.93	17.44	18.94	20.45	21.95	23.46	24.96	26.46	28.47	30.97	33.47	35.98	38.48	43.48	48.49	55.99	63.49	78.50	
13.71	15.23	16.75	18.26	19.77	21.28	22.78	24.29	26.30	28.81	31.31	33.82	36.32	41.33	46.34	53.84	61.35	76.36	2.29
11.44	12.97	14.51	16.03	17.55	19.07	20.58	22.09	24.11	26.62	29.13	31.64	34.15	39.17	44.18	51.69	59.20	74.21	2.31
14.50	16.01	17.18	19.03	20.54	22.05	23.55	25.06	27.06	29.57	32.08	34.58	37.08	42.09	47.09	54.60	62.10	77.11	
—	—	9.75	11.36	12.94	14.50	16.05	17.59	19.64	22.18	24.71	27.24	29.76	34.80	39.83	47.36	54.88	69.91	2.33
—	—	—	—	—	12.18	13.78	15.35	17.43	20.01	22.57	25.11	27.65	32.71	37.75	45.29	52.82	67.87	2.40
9.14	10.76	12.30	13.85	15.39	16.93	18.45	19.98	22.01	24.53	27.05	29.57	32.09	37.11	42.13	49.65	57.16	72.19	
13.83	15.35	16.86	18.37	19.89	21.39	22.90	24.41	26.42	28.92	31.43	33.94	36.44	41.45	46.46	53.97	61.47	76.48	
14.61	16.13	17.64	19.15	20.66	22.16	23.67	25.18	27.18	29.69	32.20	34.70	37.20	42.21	47.22	54.72	62.23	77.24	2.44
—	—	—	—	—	—	—	—	—	15.43	18.09	20.71	23.30	28.43	33.52	41.11	48.67	63.75	2.50
11.65	13.20	14.73	16.25	17.77	19.30	20.81	22.33	24.34	26.86	29.37	31.88	34.39	39.41	44.42	51.93	59.44	74.46	
15.39	16.90	18.41	19.92	21.43	22.93	24.44	25.94	27.95	30.45	32.96	35.46	37.97	42.97	47.97	55.48	62.98	77.99	
13.94	15.46	16.98	18.49	20.00	21.51	23.02	24.53	26.54	29.04	31.55	34.06	36.56	41.57	46.58	54.09	61.59	76.60	2.53
9.34	10.94	12.51	14.07	15.61	17.15	18.68	20.20	22.23	24.76	27.28	29.80	32.32	37.35	42.37	49.89	57.40	72.43	2.57
—	—	10.15	11.77	13.36	14.93	16.49	18.03	20.08	22.63	25.17	27.70	30.23	35.22	40.30	47.83	55.36	70.39	2.63
—	—	—	—	10.95	12.59	14.20	15.78	17.89	20.45	23.01	25.56	28.10	33.17	38.21	45.76	53.30	68.34	2.67
14.06	15.58	17.09	18.61	20.35	21.63	23.14	24.64	26.65	29.16	31.67	34.18	36.68	41.69	46.70	54.21	61.71	76.73	
—	—	—	—	—	—	—	—	—	15.84	18.51	21.13	23.73	28.87	33.97	41.57	49.09	64.23	2.73
11.87	13.42	14.95	16.48	18.00	19.52	21.04	22.56	24.58	27.09	29.61	32.12	34.63	39.65	44.66	52.17	59.69	74.70	
14.84	16.36	17.87	19.38	20.89	22.40	23.91	25.41	27.42	29.93	32.44	34.94	37.45	42.45	47.46	54.97	62.47	77.48	2.75
9.55	11.15	12.73	14.29	15.83	17.37	18.90	20.43	22.46	24.99	27.52	30.04	32.55	37.58	42.60	50.13	57.64	72.67	2.77
—	—	10.35	11.98	13.57	15.14	16.70	18.25	20.30	22.85	25.39	27.95	30.46	35.50	40.53	48.07	55.59	70.63	2.80
11.98	13.52	15.06	16.59	18.12	19.64	21.16	22.67	24.69	27.21	29.72	32.24	34.75	39.77	44.78	52.30	59.93	74.82	2.86
—	—	—	—	—	—	14.61	16.20	18.29	20.88	18.92	21.56	24.16	29.31	34.42	42.03	49.60	64.70	
—	—	—	—	11.34	12.99	23.67	26.18	28.19	30.69	23.45	26.01	28.55	33.62	38.67	46.23	53.77	68.82	
—	—	10.55	12.18	13.78	15.36	16.92	18.47	20.52	23.08	25.62	28.16	30.69	35.73	40.77	48.31	55.83	70.87	
9.75	11.36	12.94	14.50	16.05	17.59	19.13	20.65	22.69	25.22	27.75	30.27	32.79	37.82	42.84	50.37	57.88	72.91	
12.09	13.63	15.17	16.70	18.23	19.75	21.27	22.79	24.81	27.32	29.84	32.35	34.87	39.88	44.90	52.42	59.93	74.95	
14.28	15.80	17.32	18.84	20.35	21.86	23.37	24.88	26.89	29.40	31.91	34.42	36.92	41.93	46.94	54.45	61.96	76.97	
12.19	13.74	15.28	16.82	18.34	19.87	21.39	22.90	24.92	27.44	29.96	32.47	34.98	40.00	45.02	52.54	60.05	75.07	3.16
—	—	—	—	11.54	13.20	14.81	16.41	18.51	21.10	23.67	26.23	28.79	33.85	38.90	46.46	54.00	69.06	3.20
—	9.05	10.75	12.39	13.99	15.57	17.13	18.68	20.74	23.30	25.85	28.38	30.91	35.96	41.00	48.54	56.07	71.11	3.23

Teeth in Mesh	F factor
6 or more	1.00
5	.80
4	.60
3	.40
2	.20

NOTE: Multiply the H.P. ratings shown in the Drive Section Tables by Factor "F" and the width correction factors shown below:

belt width	1/2	5/8	3/4	7/8	1	1 1/4	1 1/2	1 3/4	2	2 1/2	3	3 1/2	4	5	6	7	8
width factor	.42	.57	.71	.86	1.0	1.29	1.56	1.84	2.14	2.72	3.36	4.06	4.76	6.15	7.50	8.89	10.32

If the number of teeth in mesh (TIM) is 5 or less, the exact TIM is indicated by the number in a circle following the center distance.

H 1/2" Pitch

Stock Drive Selection



speed ratio □	pulley combination				driveN speed and hp capacity						center distance, inches †						
	driveR		driveN		3500 rpm driveR speed		1750 rpm driveR speed		1160 rpm driveR speed		according to belt pitch length (PL), inches and corresponding code number (bold type)						
	code: no. of grooves	pitch diameter in.	code: no. of grooves	pitch diameter in.	driveN speed rpm	hp for 1 inch belt	driveN speed rpm	hp for 1 inch belt	driveN speed rpm	hp for 1 inch belt	PL: 24.00 48 teeth 240 H	PL: 27.00 54 teeth 270 H	PL: 30.00 60 teeth 300 H	PL: 33.00 66 teeth 330 H	PL: 36.00 72 teeth 360 H	PL: 39.00 78 teeth 390 H	PL: 42.00 84 teeth 420 H
3.27	22 H	3.501	72 H	11.459	1069	12.84	535	6.71	354	4.48	—	—	—	—	—	—	8.28
3.33	36 H 18 H	5.730 2.865	120 H 60 H	19.099 9.549	1050 1050	18.89 10.71 ■	525 525	10.71 5.52 ■	348 348	7.26 3.68	—	—	—	—	7.50	9.14	10.77
3.43 21 H	28 H 3.342	4.456 72 H	96 H 11.459	15.279 1021	1021 12.31 ■	15.74 510	510 6.41	8.46 338	338 4.28	5.68 —	—	—	—	—	6.58	8.38	—
3.50	24 H	3.820	84 H	13.369	1000	13.82	500	7.30	331	4.89	—	—	—	—	—	—	—
3.60	20 H	3.183	72 H	11.459	972	11.77 ■	486	6.11	322	4.08	—	—	—	—	—	—	8.47
3.69	26 H	4.138	96 H	15.279	948	14.80	474	7.88	314	5.28	—	—	—	—	—	—	—
3.75	32 H 16 H	5.093 2.546	120 H 60 H	19.099 9.549	933 933	17.40 —	467 467	9.60 4.91 ■	309 309	6.48 3.27 ■	—	—	—	—	7.69 ⑤	9.34 ⑤	10.94
3.79	19 H	3.024	72 H	11.459	924	11.24 ■	462	5.81 ■	306	3.88	—	—	—	—	—	—	8.57 ⑤
3.82	22 H	3.501	84 H	13.369	916	12.84	458	6.71	304	4.48	—	—	—	—	—	—	—
4.00	30 H 24 H 21 H 18 H	4.775 3.820 3.342 2.865	120 H 96 H 84 H 72 H	19.099 15.279 13.369 11.459	875 875 875 875	16.59 13.82 12.31 ■ 10.71 ■	438 438 438 438	9.03 7.30 6.41 5.52 ■	290 290 290 290	6.08 4.89 4.28 3.22	—	—	—	—	—	—	8.67
4.20	20 H	3.183	84 H	13.369	833	11.77 ■	417	6.11	276	4.08	—	—	—	—	—	—	—
4.29	28 H	4.456	120 H	19.099	817	15.74	408	8.46	271	5.68	—	—	—	—	—	—	—
4.36	22 H	3.501	96 H	15.279	802	12.84	401	6.71	266	4.48	—	—	—	—	—	—	—
4.42	19 H	3.024	84 H	13.369	792	11.24 ■	396	5.81 ■	262	3.88	—	—	—	—	—	—	—
4.50	16 H	2.546	72 H	11.459	778	—	389	4.91 ■	258	3.27 ■	—	—	—	—	—	—	8.86 ⑤
4.57	21 H	3.342	96 H	15.279	766	12.31 ■	383	6.41	254	4.28	—	—	—	—	—	—	—
4.62	26 H	4.138	120 H	19.099	758	14.80	379	7.88	251	5.28	—	—	—	—	—	—	—
4.67	18 H	2.865	84 H	13.369	749	10.71 ■	375	5.52 ■	248	3.68	—	—	—	—	—	—	—
4.80	20 H	3.183	96 H	15.279	729	11.77 ■	365	6.11	242	4.08	—	—	—	—	—	—	—
5.00	24 H	3.820	120 H	19.099	700	13.82	350	7.30	232	4.89	—	—	—	—	—	—	—
5.05	19 H	3.024	96 H	15.279	693	11.24 ■	346	5.81 ■	230	3.88	—	—	—	—	—	—	—
5.25	16 H	2.546	84 H	13.369	667	—	333	4.91 ■	221	3.27 ■	—	—	—	—	—	—	—
5.33	18 H	2.865	96 H	15.279	656	10.71 ■	323	5.52 ■	217	3.68	—	—	—	—	—	—	—
5.45	22 H	3.501	120 H	19.099	642	12.84	321	6.71	213	4.48	—	—	—	—	—	—	—
5.72	21 H	3.342	120 H	19.099	613	12.31 ■	306	6.41	203	4.28	—	—	—	—	—	—	—
6.00	20 H 16 H	3.183 2.546	120 H 96 H	19.099 15.279	583 583	11.77 ■ —	292 292	6.11 4.91 ■	193 193	4.08 3.27 ■	—	—	—	—	—	—	—
6.32	19 H	3.024	120 H	19.099	554	11.24 ■	277	5.81 ■	184	3.88	—	—	—	—	—	—	—
6.67	18 H	2.865	120 H	19.099	525	10.71 ■	262	5.52 ■	174	3.68	—	—	—	—	—	—	—
7.50	16 H	2.546	120 H	19.099	467	—	233	4.91 ■	155	3.27 ■	—	—	—	—	—	—	—

□ Pulley combinations shown are for conventional speed-reduction ratios; same table can be used for speed step-up ratios by making proper correction of driveN speed and belt hp capacity per inch width.

■ Pulley diameter is below recommended minimum; if used reduced belt life must be expected.

† Center distances shown are **theoretical**; manufacturing tolerances of belt length and pulley diameters can affect actual operating drive center distances.



Stock Drive Selection

H 1/2" Pitch

center distance, inches†																		speed ratio □
according to belt pitch length (PL), inches and corresponding code number (bold type)																		
PL: 45.00 90 teeth 450 H	PL: 48.00 96 teeth 480 H	PL: 51.00 102 teeth 510 H	PL: 54.00 108 teeth 540 H	PL: 57.00 114 teeth 570 H	PL: 60.00 120 teeth 600 H	PL: 63.00 126 teeth 630 H	PL: 66.00 132 teeth 660 H	PL: 70.00 140 teeth 700 H	PL: 75.00 150 teeth 750 H	PL: 80.00 160 teeth 800 H	PL: 85.00 170 teeth 850 H	PL: 90.00 180 teeth 900 H	PL: 100.00 200 teeth 1000 H	PL: 110.00 220 teeth 1100 H	PL: 125.00 250 teeth 1250 H	PL: 140.00 280 teeth 1400 H	PL: 170.00 340 teeth 1700 H	
9.95	11.56	13.15	14.72	16.27	17.81	19.35	20.88	22.91	25.45	27.98	30.50	33.02	38.05	43.08	50.61	58.12	73.15	3.27
—	—	—	—	—	—	9.55	11.50	13.86	16.64	19.34	21.98	24.59	29.75	34.87	42.48	50.06	65.17	3.33
12.30	13.85	15.39	16.93	18.46	19.98	21.50	23.02	25.04	27.56	30.07	32.59	35.10	40.12	45.14	52.66	60.17	75.19	
—	—	—	—	11.73	13.40	15.02	16.62	18.72	21.32	23.89	26.45	29.00	34.08	39.13	46.70	54.24	69.30	3.43
10.05	11.67	13.26	14.82	16.38	17.92	19.46	20.99	23.03	25.56	28.09	30.62	33.14	38.17	43.19	50.72	58.25	73.27	
....	9.24	10.95	12.59	14.20	15.78	17.35	18.90	20.96	23.52	26.07	28.61	31.14	36.20	41.23	48.78	56.35	71.35	3.50
10.15	11.77	13.36	14.93	16.49	18.03	19.57	21.10	23.14	25.68	28.21	30.73	33.25	38.29	43.31	50.84	58.36	73.40	3.60
—	—	—	10.19	11.93	13.60	15.23	16.83	18.93	21.53	24.11	26.67	29.23	34.31	39.36	46.93	54.48	69.54	3.69
—	—	—	—	—	—	—	—	14.25	17.05	19.75	22.40	25.02	30.19	35.31	42.94	50.52	65.64	3.75
12.51	14.07	15.61	17.15	18.68	20.21	21.73	23.26	25.27	27.79	30.31	32.82	35.34	40.36	45.38	52.90	60.41	75.43	
10.25	11.87	13.47	15.04	16.59	18.14	19.68	21.21	23.25	25.79	28.32	30.85	33.37	38.40	43.43	50.96	58.48	73.52	3.79
—	9.43	11.14	12.79	14.40	15.99	17.56	19.12	21.18	23.74	26.30	28.84	31.37	36.43	41.47	49.01	56.54	71.59	3.82
—	—	—	—	—	—	—	—	14.44	17.25	19.96	22.61	25.23	30.41	35.53	43.16	50.75	65.87	4.00
—	—	—	10.38	12.12	13.80	15.43	17.03	19.14	21.75	24.33	27.00	29.45	34.53	39.59	47.16	54.71	69.78	
—	9.53	11.24	12.89	14.51	15.99	17.67	19.22	21.29	23.85	26.41	28.95	31.49	36.54	41.58	49.13	56.66	71.71	
10.35	11.98	13.57	15.14	16.70	18.25	19.79	21.32	23.36	25.90	28.44	30.96	33.48	38.52	43.55	51.08	58.60	73.64	
—	9.62	11.34	12.99	14.61	16.20	17.77	19.33	21.40	23.97	26.52	29.06	31.60	36.66	41.70	49.25	56.78	71.83	4.20
—	—	—	—	—	—	—	—	14.63	17.45	20.16	22.82	25.45	30.63	35.76	43.39	50.98	66.11	4.29
—	—	—	10.57	12.32	14.00	15.63	17.24	19.36	21.96	24.55	27.12	29.67	34.76	39.82	47.39	54.94	70.01	4.36
—	9.72	11.44	13.10	14.71	16.30	17.88	19.44	21.51	24.08	26.63	29.17	31.71	36.77	41.81	49.37	56.90	71.95	4.42
10.55 ^⑤	12.18 ^⑤	13.78	15.36	16.92	18.47	20.01	21.55	23.59	26.13	28.66	31.19	33.72	38.75	43.78	51.32	58.84	73.88	4.50
—	—	—	10.66	12.42	14.10	15.74	17.34	19.46	22.07	24.66	27.23	29.78	34.87	39.94	47.51	55.06	70.13	4.57
—	—	—	—	—	—	—	12.43	14.82	17.65	20.37	23.03	25.66	30.85	35.98	43.62	51.21	66.34	4.62
—	9.81 ^⑤	11.54	13.20	14.82	16.41	17.99	19.55	21.62	24.19	26.74	29.29	31.83	36.89	41.93	49.48	57.02	72.07	4.67
—	—	—	10.75	12.51	14.20	15.84	17.45	19.57	22.18	24.77	27.34	29.90	34.99	40.05	47.63	55.18	70.25	4.80
—	—	—	—	—	—	—	—	15.02	17.84	20.57	23.24	25.87	31.06	36.20	43.84	51.44	66.57	5.00
—	—	—	10.85	12.61	14.30	15.94	17.55	19.67	22.29	24.87	27.45	30.01	35.10	40.17	47.74	55.30	70.37	5.05
—	10.00 ^⑤	11.73 ^⑤	13.40	15.02	16.62	18.20	19.76	21.84	24.39	26.96	29.51	32.05	37.12	42.16	49.72	57.25	72.31	5.25
—	—	—	10.94 ^⑤	12.71 ^⑤	14.40	16.04	17.65	19.78	22.39	24.98	27.56	30.12	35.21	40.28	47.86	55.41	70.49	5.33
—	—	—	—	—	—	—	12.79	15.21	18.04	20.78	23.45	26.08	31.28	36.42	44.07	51.67	66.81	5.45
—	—	—	—	—	—	—	12.89	15.30	18.14	20.88	23.55	26.19	31.39	36.53	44.18	51.78	66.92	5.72
—	—	—	—	—	—	—	12.98 ^⑤	15.40	18.24	20.98	23.66	26.29	31.50	36.64	44.29	51.90	67.04	6.00
—	—	9.20 ^③	11.13 ^④	12.90 ^⑤	14.59 ^⑤	16.24 ^⑤	17.86	19.99	22.61	25.20	27.78	30.34	35.44	40.51	48.09	55.65	70.73	
—	—	—	—	—	—	—	13.07 ^⑤	15.49	18.34	21.08	23.76	26.40	31.61	36.75	44.41	52.01	67.16	6.32
—	—	—	—	—	—	—	13.16 ^⑤	15.59 ^⑤	18.44	21.18	23.86	26.51	31.71	36.86	44.52	52.13	67.27	6.67
—	—	—	—	—	—	—	13.34 ^④	15.78 ^⑤	18.64 ^⑤	21.38 ^⑤	24.07	26.72	31.93	37.08	44.74	52.35	67.50	7.50

Teeth in Mesh	F factor
6 or more	1.00
5	.80
4	.60
3	.40
2	.20

NOTE: Multiply the H.P. ratings shown in the Drive Section Tables by Factor "F" and the width correction factors shown below:

belt width	1/2	5/8	3/4	7/8	1	1 1/4	1 1/2	1 3/4	2	2 1/2	3	3 1/2	4	5	6	7	8
width factor	.42	.57	.71	.86	1.0	1.29	1.56	1.84	2.14	2.72	3.36	4.06	4.76	6.15	7.50	8.89	10.32

If the number of teeth in mesh (TIM) is 5 or less, the exact TIM is indicated by the number in a circle following the center distance.

XH

7/8" Pitch

Stock Drive Selection



speed ratio □	pulley combination				driveN speed and hp capacity					
	driveR		driveN		1750 rpm driveR speed		1160 rpm driveR speed		870 rpm driveR speed	
	code: no. of grooves	pitch diameter in.	code: no. of grooves	pitch diameter in.	driveN speed rpm	hp for 1 inch belt	driveN speed rpm	hp for 1 inch belt	driveN speed rpm	hp for 1 inch belt
1.00	40 XH	11.141	40 XH	11.141	1750	22.22	1160	17.44	870	13.79
	32 XH	8.913	32 XH	8.913	1750	19.87	1160	14.57	870	11.29
	30 XH	8.356	30 XH	8.356	1750	19.06	1160	13.79	870	10.63
	28 XH	7.799	28 XH	7.799	1750	18.16	1160	12.97	870	9.97
	26 XH	7.241	26 XH	7.241	1750	17.17	1160	12.13	870	9.29
	24 XH	6.685	24 XH	6.685	1750	16.14 ■	1160	11.29	870	8.61
	22 XH	6.127	22 XH	6.127	1750	15.03 ■	1160	10.41 ■	870	7.92
	20 XH	5.570	20 XH	5.570	1750	13.85 ■	1160	9.51 ■	870	7.23 ■
	18 XH	5.013	18 XH	5.013	1750	—	1160	8.61 ■	870	6.52 ■
1.07	30 XH	8.356	32 XH	8.913	1641	19.06	1088	13.79	816	10.63
	28 XH	7.799	30 XH	8.356	1633	18.16	1083	12.97	812	9.97
1.08	26 XH	7.241	28 XH	7.799	1625	17.17	1077	12.13	808	9.29
	24 XH	6.685	26 XH	7.241	1615	16.14 ■	1071	11.29	803	8.61
1.09	22 XH	6.127	24 XH	6.685	1604	15.03 ■	1063	10.41 ■	798	7.92
1.10	20 XH	5.570	22 XH	6.127	1591	13.85 ■	1055	9.51 ■	791	7.23 ■
1.11	18 XH	5.013	20 XH	5.570	1575	—	1044	8.61 ■	783	6.52 ■
1.14	28 XH	7.799	32 XH	8.913	1531	18.16	1015	12.97	761	9.97
1.15	26 XH	7.241	30 XH	8.356	1517	17.17	1005	12.13	754	9.29
1.17	24 XH	6.685	28 XH	7.799	1500	16.14 ■	994	11.29	746	8.61
1.18	22 XH	6.127	26 XH	7.241	1481	15.03 ■	982	10.41 ■	736	7.92
1.20	40 XH	11.141	48 XH	13.369	1458	22.22	967	17.44	725	13.79
	20 XH	5.570	24 XH	6.685	1548	13.85 ■	967	9.51 ■	725	7.23 ■
1.22	18 XH	5.013	22 XH	6.127	1432	—	949	8.61 ■	712	6.52 ■
1.23	26 XH	7.241	32 XH	8.913	1422	17.17	943	12.13	707	9.29
1.25	32 XH	8.913	40 XH	11.141	1400	19.87	928	14.57	696	11.29
	24 XH	6.685	30 XH	8.356	1400	16.14 ■	928	11.29	696	8.61
1.27	22 XH	6.127	28 XH	7.799	1375	15.03 ■	911	10.41 ■	684	7.92
1.30	20 XH	5.570	26 XH	7.241	1346	13.85 ■	892	9.51 ■	669	7.23 ■
1.33	30 XH	8.356	40 XH	11.141	1313	19.06	870	13.79	653	10.63
	24 XH	6.685	32 XH	8.913	1313	16.14 ■	870	11.29	653	8.61
	18 XH	5.013	24 XH	6.685	1313	—	870	8.61 ■	653	6.52 ■
1.36	22 XH	6.127	30 XH	8.356	1283	15.03 ■	851	10.41 ■	638	7.92
1.40	20 XH	5.570	28 XH	7.799	1250	13.85 ■	829	9.51 ■	621	7.23 ■
1.43	28 XH	7.799	40 XH	11.141	1225	18.16	812	12.97	609	9.97
1.44	18 XH	5.013	26 XH	7.241	1212	—	803	8.61 ■	602	6.52 ■
1.45	22 XH	6.127	32 XH	8.913	1203	15.03 ■	798	10.41 ■	598	7.92

□ Pulley combinations shown are for conventional speed-reduction ratios; same table can be used for speed step-up ratios by making proper correction of driveN speed and belt hp capacity per inch width.

■ Pulley diameter is below recommended minimum; if used reduced belt life must be expected.

† Center distances shown are **theoretical**; manufacturing tolerances of belt length and pulley diameters can affect actual operating drive center distances.



Stock Drive Selection

XH 7/8" Pitch

center distance, inches†													speed ratio □
according to belt pitch length (PL), inches and corresponding code number (bold type)													
PL: 50.75 58 teeth 507 XH	PL: 56.00 64 teeth 560 XH	PL: 63.00 72 teeth 630 XH	PL: 70.00 80 teeth 700 XH	PL: 77.00 88 teeth 770 XH	PL: 84.00 96 teeth 840 XH	PL: 98.00 112 teeth 980 XH	PL: 112.00 128 teeth 1120 XH	PL: 126.00 144 teeth 1260 XH	PL: 140.00 160 teeth 1400 XH	PL: 154.00 176 teeth 1540 XH	PL: 175.00 200 teeth 1750 XH		
—	—	14.000	17.500	21.000	24.500	31.500	38.500	45.500	52.500	59.500	70.000	1.00	
11.375	14.000	17.500	21.000	24.500	28.000	35.000	42.000	49.000	56.000	63.000	73.500		
12.250	14.875	18.375	21.875	25.375	28.875	35.875	42.875	49.875	56.875	63.875	74.375		
13.125	15.750	19.250	22.750	26.250	29.750	36.750	43.750	50.750	57.750	64.750	75.250		
14.000	16.625	20.125	23.625	27.125	30.625	37.625	44.625	51.625	58.625	65.625	76.125		
14.875	17.500	21.000	24.500	28.000	31.500	38.500	45.500	52.500	59.500	66.500	77.000		
15.750	18.375	21.875	25.375	28.875	32.375	39.375	46.375	53.375	60.375	67.375	77.875		
16.625	19.250	22.750	26.250	29.750	33.250	40.250	47.250	54.250	61.250	68.250	78.750		
17.500	20.125	23.625	27.125	30.625	34.125	41.125	48.125	55.125	62.125	69.125	79.625		
11.809	14.435	17.936	21.436	24.936	28.436	35.437	42.437	49.437	56.437	63.437	73.937	1.07	
12.685	15.310	18.811	22.311	25.811	29.312	36.312	43.312	50.312	57.312	64.312	74.812		
13.560	16.185	19.686	23.186	26.686	30.187	37.187	44.187	51.187	58.187	65.187	75.687	1.08	
14.435	17.060	20.561	24.061	27.561	31.062	38.062	45.062	52.062	59.062	66.062	76.562		
15.310	17.936	21.436	24.936	28.436	31.937	38.937	45.937	52.937	59.937	66.937	77.437	1.09	
16.185	18.811	22.311	25.811	29.312	32.812	39.812	46.812	53.812	60.812	67.812	78.312	1.10	
17.060	19.686	23.186	26.686	30.187	33.687	40.687	47.687	54.687	61.686	68.687	79.187	1.11	
12.238	14.865	18.366	21.868	25.369	28.870	35.871	42.872	49.872	56.872	63.872	74.373	1.14	
13.114	15.740	19.242	22.743	26.244	29.745	36.746	43.747	50.747	57.747	64.747	75.248	1.15	
13.989	16.615	20.117	23.619	27.120	30.620	37.621	44.622	51.622	58.622	65.622	76.123	1.17	
14.865	17.491	20.993	24.494	27.995	31.495	38.496	45.497	52.497	59.497	66.497	76.998	1.18	
—	—	—	15.711	19.218	22.723	29.729	36.733	43.736	50.738	57.740	68.241	1.20	
15.740	18.366	21.868	25.369	28.870	32.371	39.372	46.372	53.372	60.372	67.372	77.873		
16.615	19.242	22.743	26.244	29.745	33.246	40.247	47.247	54.247	61.247	68.247	78.748	1.22	
12.660	15.290	18.794	22.297	25.799	29.300	36.303	43.305	50.306	57.306	64.307	74.808	1.23	
—	12.199	15.711	19.218	22.723	26.226	33.222	40.234	47.237	54.239	61.240	71.741	1.25	
13.537	16.166	19.670	23.173	26.674	30.176	37.178	44.180	51.181	58.181	65.182	75.683		
14.413	17.042	20.546	24.048	27.550	31.051	38.051	45.055	52.056	59.056	66.057	76.558	1.27	
15.290	17.918	21.421	24.924	28.425	31.927	38.929	45.930	52.931	59.931	66.932	77.433	1.30	
—	12.611	16.127	19.639	23.146	26.651	33.659	40.664	47.667	54.670	61.672	72.174	1.33	
13.078	15.711	19.218	22.723	26.226	29.729	36.733	43.736	50.738	57.740	64.740	75.242		
16.166	18.794	22.297	25.799	29.300	32.802	39.804	46.806	53.806	60.806	67.807	78.308		
13.955	16.587	20.094	23.599	27.102	30.605	37.608	44.611	51.613	58.615	65.615	76.117	1.36	
14.833	17.464	20.970	24.475	27.978	31.481	38.484	45.486	52.489	59.490	66.490	76.992	1.40	
10.365	13.017	16.540	20.055	23.566	27.073	34.084	41.091	48.096	55.100	62.102	72.606	1.43	
15.711	18.341	21.847	25.351	28.853	32.356	39.359	46.362	53.364	60.365	67.366	77.867	1.44	
13.491	16.127	19.639	23.146	26.651	30.155	37.161	44.166	51.168	58.171	65.173	75.674	1.45	

Teeth in Mesh	F factor
6 or more	1.00
5	.80
4	.60
3	.40
2	.20

NOTE: Multiply the H.P. ratings shown in the Drive Section Tables by Factor "F" and the width correction factors shown below:

belt width	1	1¼	1½	1¾	2	2½	3	3½	4	5	6	7	8	9	10	11	12	13	14
width factor	1.00	1.29	1.56	1.84	2.14	2.72	3.36	4.06	4.76	6.15	7.50	8.89	10.32	11.70	13.10	14.41	15.84	17.16	18.62

If the number of teeth in mesh (TIM) is 5 or less, the exact TIM is indicated by the number in a circle following the center distance.

XH

7/8" Pitch

Stock Drive Selection

Martin

speed ratio □	pulley combination				driveN speed and hp capacity					
	driveR		driveN		1750 rpm driveR speed		1160 rpm driveR speed		870 rpm driveR speed	
	code: no. of grooves	pitch diameter in.	code: no. of grooves	pitch diameter in.	driveN speed rpm	hp for 1 inch belt	driveN speed rpm	hp for 1 inch belt	driveN speed rpm	hp for 1 inch belt
1.50	40 XH	11.141	60 XH	16.711	1167	22.22	773	17.44	580	13.79
	32 XH	8.913	48 XH	13.369	1167	19.87	773	14.57	580	11.29
	20 XH	5.570	30 XH	8.356	1167	13.85 ■	773	9.51 ■	580	7.23 ■
1.54	26 XH	7.241	40 XH	11.141	1138	17.17	754	12.13	566	9.29
1.56	18 XH	5.013	28 XH	7.799	1125	—	746	8.61 ■	559	6.52 ■
1.60	30 XH	8.356	48 XH	13.369	1094	19.06	725	13.79	544	10.63
	20 XH	5.570	32 XH	8.913	1094	13.85 ■	725	9.51 ■	544	7.23 ■
1.67	24 XH	6.685	40 XH	11.141	1050	16.14 ■	696	11.29	522	8.61
	18 XH	5.013	30 XH	8.356	1050	—	696	8.61 ■	522	6.52 ■
1.71	28 XH	7.799	48 XH	13.369	1021	18.16	677	12.97	508	9.97
1.78	18 XH	5.013	32 XH	8.913	984	—	653	8.61 ■	489	6.52 ■
1.80	40 XH	11.141	72 XH	20.054	972	22.22	644	17.44	483	13.78
1.82	22 XH	6.127	40 XH	11.141	963	15.03 ■	638	10.41 ■	479	7.92
1.85	26 XH	7.241	48 XH	13.369	948	17.17	628	12.13	471	9.29
1.88	32 XH	8.913	60 XH	16.711	933	19.87	618	14.57	464	11.29
2.00	30 XH	8.356	60 XH	16.711	875	19.06	580	13.79	435	10.63
	24 XH	6.685	48 XH	13.369	875	16.14 ■	580	11.29	435	8.61
	20 XH	5.570	40 XH	11.141	875	13.85 ■	580	9.51 ■	435	7.23 ■
2.10	40 XH	11.141	84 XH	23.396	833	22.22	552	17.44	414	13.79
2.14	28 XH	7.799	60 XH	16.711	817	18.16	541	12.97	407	9.97
2.18	22 XH	6.127	48 XH	13.369	802	15.03 ■	531	10.41 ■	399	7.92
2.22	18 XH	5.013	40 XH	11.141	788	—	523	8.61 ■	392	6.52 ■
2.25	32 XH	8.913	72 XH	20.054	778	19.87	516	14.57	387	11.29
2.31	26 XH	7.241	60 XH	16.711	758	17.17	502	12.13	377	9.29
2.40	40 XH	11.141	96 XH	26.738	729	22.22	483	17.44	363	13.79
	30 XH	8.356	72 XH	20.054	729	19.06	483	13.79	363	10.63
	20 XH	5.570	48 XH	13.369	729	13.85 ■	483	9.51 ■	363	7.23 ■
2.50	24 XH	6.685	60 XH	16.711	700	16.14 ■	464	11.29	348	8.61
2.57	28 XH	7.799	72 XH	20.054	681	18.16	451	12.97	339	9.97
2.63	32 XH	8.913	84 XH	23.396	667	19.87	442	14.57	331	11.29
2.67	18 XH	5.013	48 XH	13.369	656	—	434	8.61 ■	326	6.52 ■

□ Pulley combinations shown are for conventional speed-reduction ratios; same table can be used for speed step-up ratios by making proper correction of driveN speed and belt hp capacity per inch width.

■ Pulley diameter is below recommended minimum; if used reduced belt life must be expected.

† Center distances shown are **theoretical**; manufacturing tolerances of belt length and pulley diameters can affect actual operating drive center distances.



Stock Drive Selection

XH 7/8" Pitch

center distance, inches†													speed ratio □
according to belt pitch length (PL), inches and corresponding code number (bold type)													
PL: 50.75 58 teeth 507 XH	PL: 56.00 64 teeth 560 XH	PL: 63.00 72 teeth 630 XH	PL: 70.00 80 teeth 700 XH	PL: 77.00 88 teeth 770 XH	PL: 84.00 96 teeth 840 XH	PL: 98.00 112 teeth 980 XH	PL: 112.00 128 teeth 1120 XH	PL: 126.00 144 teeth 1260 XH	PL: 140.00 160 teeth 1400 XH	PL: 154.00 176 teeth 1540 XH	PL: 175.00 200 teeth 1750 XH		
—	—	—	—	16.388	19.930	26.982	34.011	41.031	48.045	55.055	65.566	1.50	
—	—	13.820	17.357	20.881	24.399	31.421	38.435	45.446	52.453	59.458	69.964		
14.370	17.006	20.515	24.022	27.528	31.031	38.037	45.041	52.044	59.046	66.048	76.550		
10.761	13.421	16.951	20.470	23.983	27.493	34.507	41.517	48.523	55.528	62.532	73.036	1.54	
15.249	17.883	21.392	24.899	28.403	31.907	38.913	45.917	52.919	59.922	66.923	77.425	1.56	
—	—	14.216	17.761	21.290	24.811	31.839	38.857	45.869	52.878	59.885	70.393	1.60	
13.898	16.540	20.055	23.566	27.073	30.580	37.588	44.594	51.598	58.601	65.604	76.107		
11.152	13.820	17.357	20.881	24.399	27.911	34.929	41.941	48.949	55.955	62.961	73.466	1.67	
14.781	17.420	20.934	24.443	27.950	31.455	38.465	45.474	52.474	59.476	66.479	76.982		
—	11.022	14.609	18.161	21.696	25.221	32.255	39.276	46.291	53.302	60.311	70.820	1.71	
14.305	16.951	20.470	23.983	27.493	31.001	38.013	45.021	52.026	59.030	66.034	76.538	1.78	
—	—	—	—	—	16.909	24.087	31.181	38.240	45.280	52.310	62.842	1.80	
11.540	14.216	17.761	21.290	24.811	28.326	35.348	42.363	49.374	56.382	63.388	73.895	1.82	
—	11.399	14.998	18.559	22.100	25.630	32.669	39.694	46.712	53.725	60.736	71.247	1.85	
—	—	—	14.341	17.950	21.521	28.609	35.662	42.697	49.722	56.741	67.262	1.88	
—	—	—	14.716	18.335	21.914	29.102	36.070	43.110	50.138	57.159	67.684	2.00	
—	11.772	15.386	18.954	22.502	26.036	33.081	40.111	47.132	54.147	61.159	71.672		
11.924	14.609	18.161	21.696	25.221	28.740	35.767	42.784	49.797	56.807	63.815	74.323		
—	—	—	—	—	—	20.974	28.207	35.342	42.432	49.495	60.063	2.10	
—	—	—	15.087	18.717	22.304	29.411	36.478	43.522	50.553	57.578	68.104	2.14	
—	12.143	15.770	19.348	22.901	26.439	33.492	40.526	47.549	54.568	61.581	72.097	2.18	
12.304	14.998	18.559	22.100	25.630	29.152	36.183	43.204	50.219	57.230	64.240	74.750	2.22	
—	—	—	—	—	18.400	25.643	32.776	39.860	46.919	53.962	64.509	2.25	
—	—	—	15.457	19.098	22.691	29.810	36.883	43.932	50.968	57.994	68.524	2.31	
—	—	—	—	—	—	—	25.025	32.304	39.477	46.596	57.218	2.40	
—	—	—	—	15.035	18.769	26.028	33.170	40.262	47.325	54.373	64.924		
—	12.513	16.152	19.738	23.298	26.842	33.900	40.940	47.967	54.987	62.003	72.520		
—	—	—	15.824	19.476	23.078	30.209	37.287	44.342	51.380	58.410	68.943	2.50	
—	—	—	—	15.388	19.135	26.411	33.564	40.662	47.731	54.782	65.337	2.57	
—	—	—	—	—	—	22.446	29.739	36.913	44.028	51.111	61.700	2.63	
10.056	12.879	16.531	20.128	23.693	27.241	34.308	41.352	48.382	55.405	62.423	72.943	2.67	

Teeth in Mesh	F factor
6 or more	1.00
5	.80
4	.60
3	.40
2	.20

NOTE: Multiply the H.P. ratings shown in the Drive Section Tables by Factor "F" and the width correction factors shown below:

belt width	1	1¼	1½	1¾	2	2½	3	3½	4	5	6	7	8	9	10	11	12	13	14
width factor	1.00	1.29	1.56	1.84	2.14	2.72	3.36	4.06	4.76	6.15	7.50	8.89	10.32	11.70	13.10	14.41	15.84	17.16	18.62

If the number of teeth in mesh (TIM) is 5 or less, the exact TIM is indicated by the number in a circle following the center distance.

XH

7/8" Pitch

Stock Drive Selection

Martin

speed ratio □	pulley combination				driveN speed and hp capacity					
	driveR		driveN		1750 rpm driveR speed		1160 rpm driveR speed		870 rpm driveR speed	
	code: no. of grooves	pitch diameter in.	code: no. of grooves	pitch diameter in.	driveN speed rpm	hp for 1 inch belt	driveN speed rpm	hp for 1 inch belt	driveN speed rpm	hp for 1 inch belt
2.73	22 XH	6.127	60 XH	16.711	642	15.03 ■	425	10.41 ■	319	7.92
2.77	26 XH	7.241	72 XH	20.054	632	17.17	419	12.13	314	9.29
2.80	30 XH	8.356	84 XH	23.396	625	19.06	414	13.79	311	10.63
3.00	40 XH	11.141	120 XH	33.423	583	22.22	387	17.44	290	13.79
	32 XH	8.913	96 XH	26.738	583	19.87	387	14.57	290	11.29
	28 XH	7.799	84 XH	23.396	583	18.16	387	12.97	290	9.97
	24 XH	6.685	72 XH	20.054	583	16.14 ■	387	11.29	290	8.61
3.20	20 XH	5.570	60 XH	16.711	583	13.85 ■	387	9.51 ■	290	7.23 ■
	30 XH	8.356	96 XH	26.738	547	19.06	363	13.79	272	10.63
3.23	26 XH	7.241	84 XH	23.396	542	17.17	359	12.13	269	9.29
3.27	22 XH	6.127	72 XH	20.054	535	15.03 ■	355	10.41 ■	266	7.92
3.33	18 XH	5.013	60 XH	16.711	525	—	348	8.61 ■	261	6.52 ■
3.43	28 XH	7.799	96 XH	26.738	510	18.16	338	12.97	254	9.97
3.50	24 XH	6.685	84 XH	23.396	500	16.14 ■	331	11.29	249	8.61
3.60	20 XH	5.570	72 XH	20.054	486	13.85 ■	322	9.51 ■	242	7.23 ■
3.69	26 XH	7.241	96 XH	26.738	474	17.17	314	12.13	236	9.29
3.75	32 XH	8.913	120 XH	33.423	467	19.87	309	14.57	232	11.29
3.82	22 XH	6.127	84 XH	23.396	458	15.03 ■	304	10.41 ■	228	7.92
4.00	30 XH	8.356	120 XH	33.423	438	19.06	290	13.79	218	10.63
	24 XH	6.685	96 XH	26.738	438	16.14	290	11.29	218	8.61
	18 XH	5.013	72 XH	20.054	438	—	290	8.61 ■	218	6.52 ■
4.20	20 XH	5.570	84 XH	23.396	416	13.85 ■	276	9.51 ■	207	7.23 ■
4.29	28 XH	7.799	120 XH	33.423	408	18.16	270	12.97	203	9.97
4.36	22 XH	6.127	96 XH	26.738	401	15.03 ■	266	10.41 ■	200	7.92
4.62	26 XH	7.241	120 XH	33.423	379	17.17	251	12.13	188	9.29
4.67	18 XH	5.013	84 XH	23.396	375	—	249	8.61 ■	186	6.52 ■
4.80	20 XH	5.570	96 XH	26.738	365	13.85 ■	242	9.51 ■	181	7.23 ■
5.00	24 XH	6.685	120 XH	33.423	350	16.14 ■	232	11.29	173	8.61
5.33	18 XH	5.013	96 XH	26.738	328	—	217	8.61 ■	162	6.52 ■
5.45	22 XH	6.127	120 XH	33.423	321	15.03 ■	212	10.41 ■	159	7.92
6.00	20 XH	5.570	120 XH	33.423	292	13.85 ■	193	9.51 ■	145	7.23 ■
6.67	18 XH	5.013	120 XH	33.423	262	—	174	8.61 ■	130	6.52 ■

□ Pulley combinations shown are for conventional speed-reduction ratios; same table can be used for speed step-up ratios by making proper correction of driveN speed and belt hp capacity per inch width.

■ Pulley diameter is below recommended minimum; if used reduced belt life must be expected.

† Center distances shown are **theoretical**; manufacturing tolerances of belt length and pulley diameters can affect actual operating drive center distances.



Stock Drive Selection

XH 7/8" Pitch

center distance, inches†												
according to belt pitch length (PL), inches and corresponding code number (bold type)												
PL: 50.75 58 teeth 507 XH	PL: 56.00 64 teeth 560 XH	PL: 63.00 72 teeth 630 XH	PL: 70.00 80 teeth 700 XH	PL: 77.00 88 teeth 770 XH	PL: 84.00 96 teeth 840 XH	PL: 98.00 112 teeth 980 XH	PL: 112.00 128 teeth 1120 XH	PL: 126.00 144 teeth 1260 XH	PL: 140.00 160 teeth 1400 XH	PL: 154.00 176 teeth 1540 XH	PL: 175.00 200 teeth 1750 XH	speed ratio □
—	—	12.417	16.190	19.853	23.463	30.604	37.691	44.749	51.792	58.825	69.360	2.73
—	—	—	—	15.740	19.500	26.793	33.956	41.062	48.136	55.191	65.750	2.77
—	—	—	—	—	—	22.811	30.118	37.302	44.425	51.513	62.107	2.80
—	—	—	—	—	—	—	—	25.528	33.107	40.457	51.286	3.00
—	—	—	—	—	—	18.851	26.485	33.819	41.028	48.173	58.824	
—	—	—	—	—	—	23.175	30.497	37.691	44.820	51.913	62.513	3.20
—	—	—	—	16.090	19.864	27.174	34.347	41.460	48.539	55.598	66.162	
—	—	12.764	16.553	20.228	23.846	30.998	38.092	45.156	52.203	59.238	69.778	3.27
—	—	—	—	—	—	19.191	26.849	34.195	41.414	48.565	59.223	
—	—	—	—	—	15.828	23.538	30.875	38.077	45.214	52.313	62.919	3.33
—	—	—	—	16.440	20.227	27.553	34.738	41.857	48.941	56.004	66.574	
—	—	13.110 ^⑥	16.916	20.602	24.228	31.391	38.492	45.561	52.612	59.651	70.193	3.43
—	—	—	—	—	—	19.531	27.210	34.570	41.798	48.956	59.622	
—	—	—	—	—	16.163	23.899	31.252	38.464	45.608	52.712	63.323	3.50
—	—	—	—	16.788 ^⑥	20.588	27.931	35.126	42.253	49.343	56.410	66.983	
—	—	—	—	—	—	19.870	27.570	34.944	42.181	49.347	60.019	3.69
—	—	—	—	—	—	—	—	26.908	34.553	41.947	52.822	
—	—	—	—	—	16.496	24.259	31.627	38.849	46.000	53.109	63.727	3.82
—	—	—	—	—	—	—	—	27.251	34.913	42.318	53.204	
—	—	—	—	—	—	20.207	27.930	35.317	42.564	49.736	60.416	4.00
—	—	—	13.086 ^⑤	17.134 ^⑥	20.948 ^⑥	28.308	35.514	42.648	49.743	56.814	67.393	
—	—	—	—	—	16.830 ^⑥	24.618	32.001	39.233	46.392	53.506	64.130	4.20
—	—	—	—	—	—	—	—	27.593	35.271	42.688	53.586	
—	—	—	—	—	—	20.544	28.289	35.690	42.945	50.124	60.813	4.36
—	—	—	—	—	—	—	—	27.935	35.630	43.057	53.967	
—	—	—	—	—	17.161 ^⑤	24.977 ^⑥	32.374	39.617	46.782	53.902	64.532	4.67
—	—	—	—	—	—	20.880 ^⑥	28.647	36.061	43.326	50.512	61.208	
—	—	—	—	—	—	—	—	28.277	35.987	43.425	54.347	5.00
—	—	—	—	—	—	21.215 ^⑤	29.004 ^⑥	36.431	43.705	50.899	61.603	
—	—	—	—	—	—	—	—	28.617	36.344	43.793	54.727	5.45
—	—	—	—	—	—	—	—	20.406 ^⑤	28.956 ^⑥	36.699	44.160	
—	—	—	—	—	—	—	—	20.406 ^⑤	28.956 ^⑥	36.699	44.160	6.00
—	—	—	—	—	—	—	—	20.717 ^⑤	29.296 ^⑥	37.055 ^⑥	44.527	

Teeth in Mesh	F factor
6 or more	1.00
5	.80
4	.60
3	.40
2	.20

NOTE: Multiply the H.P. ratings shown in the Drive Section Tables by Factor "F" and the width correction factors shown below:

belt width	1	1¼	1½	1¾	2	2½	3	3½	4	5	6	7	8	9	10	11	12	13	14
width factor	1.00	1.29	1.56	1.84	2.14	2.72	3.36	4.06	4.76	6.15	7.50	8.89	10.32	11.70	13.10	14.41	15.84	17.16	18.62

If the number of teeth in mesh (TIM) is 5 or less, the exact TIM is indicated by the number in a circle following the center distance.

Timing Pulley Other Speeds/ Speed-Up Drives

TABLE 3. Cross Section Selection Chart

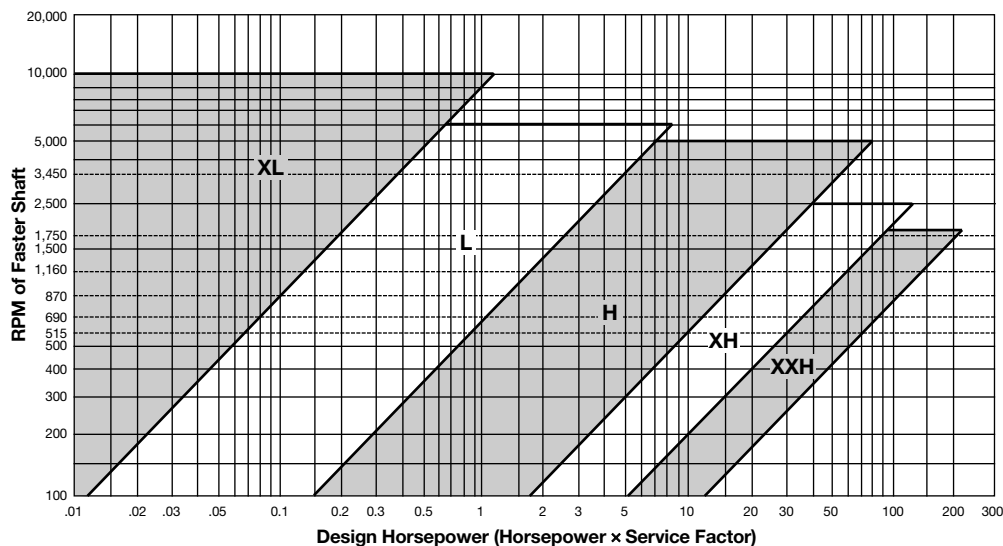

Other Speeds or Speed-Up Drive Selection

- A. The service factor and belt pitch are selected the same as outlined in Steps 1 and 2. Be sure to include the additional factor from Table 3 in your service factor for speed-up drives.
- B. Turn to the Drive Selection Tables for the belt pitch selected.
- C. Divide the rpm of the faster machine by the rpm of the slower machine. This gives the speed ratio. (If you are replacing a chain or gear drive, divide the number of teeth in the larger sprocket or gear by the number of teeth in the smaller sprocket or gear. If you are replacing a flat belt or conventional V-belt drive, divide the diameter of the larger pulley or sheave by the diameter of the smaller pulley or sheave.)
- D. Read the Speed Ratio column of the Table for the belt pitch selected to find the stock speed ratio nearest the ratio you require. Read across to the right to find the pulley combination, center distance, belt number, and Teeth in Mesh (TIM) factor. If you cannot find a speed ratio sufficiently close, use Non-Stock Drive Design.
- E. Turn to basic horsepower rating table for the belt pitch selected. Read down the left-hand column to find the rpm of your **faster** shaft and then across to the right. The horsepower rating per inch of belt width will be found under the column headed by the pulley size you have selected.
- F. If the number of teeth in mesh is five or less, you will have a TIM factor found in Step D. Multiply the basic horsepower per inch of belt width found in Step E by the TIM factor (where applicable) and this will give you the corrected horsepower per inch of belt width.
- G. Divide the design horsepower found in Step A by the corrected horsepower to find the **NOMINAL BELT WIDTH**. This will give you your final belt and pulley width. If the answer contains a fraction, use the next largest stock width.

Most drives can be selected by using the Stock Drive Selection Procedures with the pre-figured drive tables. However, if your drive requires the use of one or more non-stock pulleys due to unusual application or special specifications the following steps can be used to select the correct timing pulleys for your application.

THE FOLLOWING INFORMATION WILL BE REQUIRED TO SELECT THE DRIVE:

1. HORSEPOWER AND TYPE OF DRIVER.
2. THE RPM OF THE DRIVER.
3. THE RPM OF THE DRIVEN MACHINE.
4. SHAFT DIAMETERS AND KEYSEAT DIMENSIONS.
5. THE EXACT OR APPROXIMATE CENTER DISTANCE REQUIRED.
6. OPERATING CONDITIONS OF THE DRIVE.

AN EXAMPLE OF A NON-STOCK TIMING PULLEY DRIVE:

1. THE DRIVER IS A 40 HP, NEMA DESIGN "B" MOTOR.
2. THE SPEED OF THE DRIVER MOTOR IS 1800 RPM (1750 RPM FULL LOAD SPEED).
3. A HAMMERMILL IS TO BE DRIVEN AT 1250 RPM.
4. THE MOTOR SHAFT IS 1 $\frac{1}{4}$ "; AGITATOR SHAFT IS 1 $\frac{5}{16}$ ". BOTH HAVE STANDARD KEYSEATS.
5. THE DRIVE WILL REQUIRE A CENTER DISTANCE OF APPROXIMATELY 24".
6. THE DRIVE IS OPERATED 8 HOURS PER DAY.

SELECTION PROCEDURE

Step 1 — Find the Design Horsepower

- A. Refer to Table 1, from "Stock Drive Selection" for the class driver and to Table 2 for the type driven machine. The class in the Service Factors Table will correspond to the class determined in the Driver Classification Table. Check for any additional Service Factor required for unusual conditions — such as continuous operation and/or use of an idler.

Example: Table 1 places the driver in Class II, and Table 2 shows a hammermill in Class II to have a Service Factor of 1.9.

- B. The design horsepower is found by multiplying the full load horsepower by the Service Factor. This is the horsepower for which you are going to select the drive.

Example: Design horsepower = 40 × 1.9 or 76 hp.

Step 2 — Choose the Belt Pitch

Locate the rpm of the faster shaft on the vertical line of Table 4. Follow this line up to the point where the design horsepower selected in Step 1 intersects this speed. The point at which the lines intersect indicates the recommended belt pitch for your drive.

Example: The table indicates that a $\frac{7}{8}$ inch pitch (XH) belt should be selected.

Step 3 — Find the Speed Ratio

Divide the rpm of the faster machine by the rpm of the slower machine. This gives the speed ratio.

$$\frac{\text{Faster rpm}}{\text{Slower rpm}} = \text{ratio}$$

If you are replacing a chain or gear drive, divide the number of teeth on the larger sprocket or gear by the number of teeth on the smaller.

Example:

$$\frac{1750}{1250} = 1.4 \text{ ratio}$$

Step 4 — Choose the Pulley Sizes

- A. You should try to use one stock pulley for the drive, preferably the larger. If both are standard size you can use the stock number selection tables by the method described under "Stock Drive Selection."
- B. If a minimum or maximum diameter for one of the pulleys is determined by the application, start with that diameter (or number of grooves). Be sure to check for the minimum recommended number of grooves for the belt pitch selected. (page K-4).

Example: The Minimum Pulley Diameter Table indicates the recommended number of grooves is 26.

- C. If no limitations are placed on diameter, multiply the minimum recommended number of grooves for the small pulley by the ratio found in Step 3 to obtain the number of grooves required on the large pulley. If possible, for a more economical drive, use the next larger size stock pulley. To maintain ratio, divide the number of grooves in the large pulley by the ratio — this will give the number of grooves that must be used in the small pulley.

Example: The recommended number of grooves is 26 as determined by Step B above.

Multiply this size by the ratio determined in Step 3 to find the size of the large pulley:

$$26 \times 1.4 = 35.4$$

The next larger stock size is a 40 groove pulley. We divide 40 by the ratio (1.4) to find the number of grooves in the small pulley:

$$\frac{40}{1.4} = 28.6$$

In this case, we use a stock 40 groove pulley. Our pulley sizes have now been determined as:

$$\text{Driver} = 29 \text{ XH, Driven} = 40 \text{ XH}$$

- D. Calculate the RIM speed. RIM speed equals 0.262 × OD of either pulley × rpm of same pulley.

Example: the diameter of our example pulley (29 XH) is determined as 7.967 from the Pulley Diameter Tables.

Non-Stock Drive Design



$$7.967 \times .262 \times 1750 = 3653 \text{ fpm}$$

If RIM speed exceeds 65 fpm, consult *Martin*.

Step 5 — Find Belt Length and Center Distance

A. To calculate belt length when center distance is known:

$$L = 2C + 1.57(D + d) + \frac{(D - d)^2}{4C}$$

Correct centers by adding to (if standard belt is longer) or subtracting from (if standard belt is shorter) one-half the difference between the calculated belt length and standard belt length.

Example: Calculating the belt length on our example drive using a 24 inch center distance:

$$L = 2(24) + 1.57(11.141 + 8.077) + \frac{(11.141 - 8.077)^2}{4(24)} = 78.270$$

From Stock Selection tables standard pitch length is 77.0 inches; therefore, we correct answer to find adjusted center distance:

$$78.270 - 77.0 = 1.270, \quad \frac{1.270}{2} = .635$$

24.0" - .635" = 23.365" Center Distance with 770XH Belt.

B. To calculate centers when belt length is known:

$$C = \frac{b + \sqrt{b^2 - 32(D - d)^2}}{16}$$

Calculating our example center distance using a standard 77.0" pitch length belt:

$$b = 4(77) - 6.28318(11.141 + 8.077) = 187.25$$

$$C = \frac{187.25 + \sqrt{(187.25)^2 - 32(11.141 - 8.077)^2}}{16} = 23.356"$$

VALUES:

C = Center Distance

L = Belt Pitch Length

D = Pitch Diameter Large Pulley

d = Pitch Diameter Small Pulley

b = 4L - 6.28318(D + d)

NOTE: Use these formulas only when you have adjustment available on centers. For fixed center applications, where exact centers are required, consult *Martin*.

Step 6 — Determine Drive Width

A. Turn to the basic horsepower rating table for the belt pitch selected. Read down the left hand column to find the rpm of your faster shaft and then across to the right and the horsepower rating per inch of belt width will be found under the column headed by the pulley size you have selected. Interpolate for sizes not shown.

Example: By interpolating the XH HP Rating Table we find that our example pulley (1750 rpm for the fastest shaft, with 29 teeth in the pulley) has 18.61 hp rating per inch of belt width.

B. Find the number of teeth in mesh.

$$\text{Arc of Contact} = 180^\circ - \frac{60(D - d)}{C}$$

$$\text{Teeth in Mesh} = \frac{\text{Arc of Contact} \times n}{360}$$

n = Number of teeth in small pulley

Example: The number of teeth in mesh for this application:

$$Ac = 180 - \frac{60(11.141 - 8.077)}{23.365} = 172.132$$

$$\text{TIM} = \frac{172.132 \times 29}{360} = 13.866$$

TIM	F factor
6 or more	1.00
5	.80
4	.60
3	.40
2 or more	.20

TEETH IN MESH FACTOR

If the number of teeth in mesh is 5 or less, multiply the horsepower per inch of belt width by the TIM factor. This is the corrected horsepower per inch of belt width.

Example: No TIM factor correction is necessary for our example, since the multiple for 6 or more teeth in mesh is 1.00.

C. Divide the design horsepower found in Step 1b by the corrected horsepower per inch of belt width found in Steps 6a and 6b to find the nominal belt width. If the answer contains a fraction, use the next largest stock width.

Example:

$$\frac{29}{18.61} = 1.56 \text{ nominal width}$$

(Continued on Page K-63)



Nonstock Drive Design

Below we find that a 1.56 width Factor corresponds more closely to a 1½" belt width for ⅝ belt pitch or the next *stock* width of 2". As indicated by the shaded area.

Therefore, our final belt width will be 2.0".

Order *Martin*

- (1) TB 40 XH200
- (1) 4040 × 1¹⁵/₁₆ bushing
- (1) M-T-O TB 29 XH200
- (1) 3535 × 1¹/₈ bushing

(A re-check of bore limits, number of teeth, and width from the Stock Pulley Dimensions, shows that all material is stock.)

Table 4

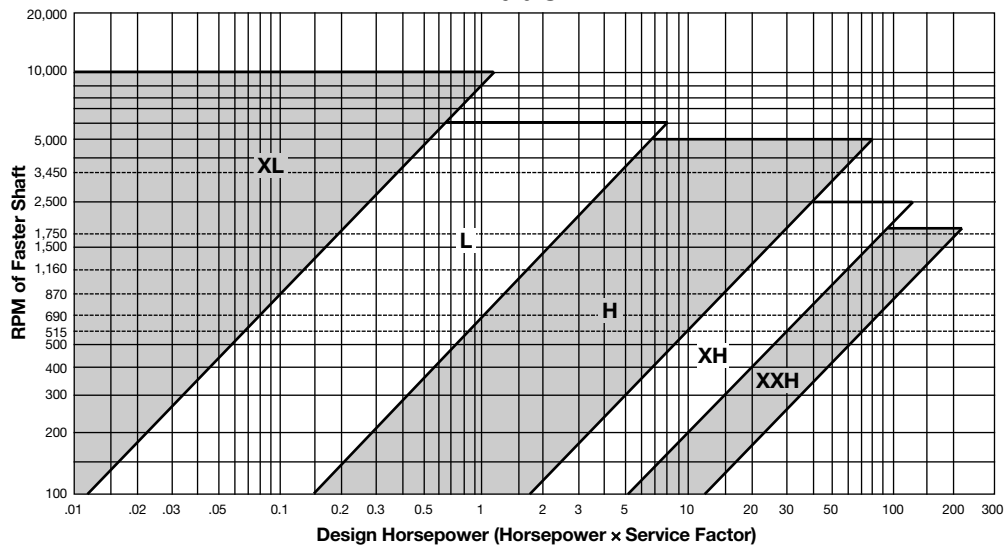

Allowable Working Tensions (T.) in Pounds

Belt Width	¼	⅜	½	⅝	¾	⅞	1	1¼	1½	1¾	2	2½	3	3½	4	5	6	7	8	9	10	11	12	13	14		
⅜"	6	8	11	14	17	23	29	35	41	53	64																
½"			15	19	23	31	39	47	55	71	86	101	118	150	185												
¾"				59	80	99	120	140	181	218	258	300	381	470	568	666	861	1050	1245	1445							
1"								191	246	298	351	409	520	642	775	909	1175	1433	1698	1971	2235	2502	2752	3025	3278	3555	
1½"								234	302	365	431	501	636	786	950	1114	1439	1755	2080	2415	2738	3065	3372	3707	4015	4357	
Width Factor	.15	.21	.28	.35	.42	.57	.71	.86	1.0	1.29	1.56	1.84	2.14	2.72	3.36	4.06	4.76	6.15	7.50	8.89	10.32	11.70	13.10	14.41	15.84	17.16	18.62

Shaded Areas are Stock Width Belts

PULLEYS

Timing Pulley Information



The Positive Drive belt should be installed with a snug fit, neither too tight nor too loose. The belt's positive grip eliminates the need for initial tension. Consequently, a belt, when installed with snug fit (that is, not too taut), assures longer life, less wear on bearings, quieter operation. Pre-loading, often the cause of premature failure, is not necessary. A belt in either the 3/8- or 1 1/4-inch pitch can usually be installed slightly slack (because of deeper tooth section) unless shock loads of reversals are abnormally high. For additional recommendations on timing belt installation and tensioning, please contact the belt manufacturer.

Note:
Experience reveals that an extremely high percentage of Timing Pulley difficulties are caused by using pulley diameters that are too small. As a rule of thumb, a drive carrying the full recommended design loading per inch of belt width should not have a pulley diameter less than the drive belt width — even though the pulley diameter falls within the acceptable range shown in the minimum pulley diameter table.

TIMING PULLEY GROOVE PROFILES

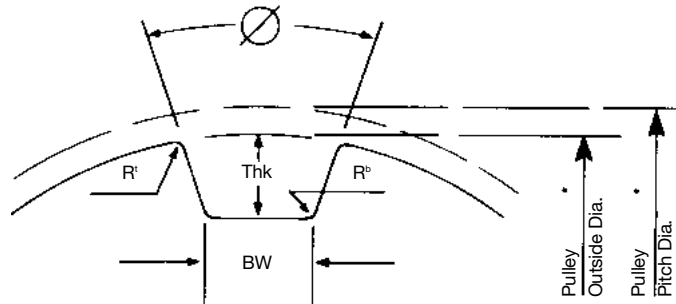

Stock Belt Pitches	Approx. Pitch	Belt Tooth Profile	BW	Thk	O	R ^b	R ^t
1/8 (XL)	.187	F	.068 +.002 -.000	.060 +.000 -.002	40° ± 3°	1/64 MAX.	.015 +.002 -.000
1/8 (XL)	.200	H	.052 +.002 -.000	.065 +.000 -.003	50° ± 3°	1/64 MAX.	.025 +.002 -.000
1/8 (XL)	.234	D	.080 +.003 -.000	.073 +.000 -.004	40° ± 3°	1/32 MAX.	.030 +.005 -.000
3/8 (L)	.375	C	.120 +.004 -.000	.105 +.000 -.004	40° ± 3°	3/64 MAX.	.046 +.005 -.000
1/2 (H)	.500	B	.165 +.005 -.000	.120 +.000 -.005	40° ± 3°	1/16 MAX.	1/16 +.005 -.000
7/8 (XH)	.875	G	.311 +.006 -.000	.281 +.000 -.005	40° ± 3°	5/64 MAX.	3/32 +.005 -.000
1 1/4 (XXH)	1.250	E	.479 +.007 -.000	.406 +.000 -.005	40° ± 3°	1/32 MAX.	1/8 +.005 -.000

PULLEYS



Horsepower Ratings

XL

XL - 1/8" Pitch

RPM of Faster Shaft	HP for a 1" Wide Belt for Various Pulleys*												
	10XL .637 P.D.	11XL .700 P.D.	12XL .764 P.D.	14XL .891 P.D.	15XL .955 P.D.	16XL 1.019 P.D.	18XL 1.146 P.D.	20XL 1.273 P.D.	21XL 1.337 P.D.	23XL 1.401 P.D.	24XL 1.528 P.D.	28XL 1.783 P.D.	30XL 1.910 P.D.
100	.02	.02	.02	.03	.03	.03	.04	.04	.04	.04	.05	.06	.06
200	.04	.04	.05	.06	.06	.07	.07	.08	.08	.09	.10	.11	.12
300	.06	.07	.07	.09	.09	.10	.11	.12	.13	.13	.14	.17	.18
400	.08	.09	.10	.11	.12	.13	.14	.16	.17	.17	.19	.23	.24
500	.10	.11	.12	.14	.15	.16	.18	.20	.21	.22	.24	.29	.30
600	.12	.13	.14	.17	.18	.19	.22	.24	.26	.27	.29	.34	.37
700	.14	.15	.17	.20	.21	.23	.26	.28	.30	.31	.34	.40	.43
800	.16	.17	.19	.23	.24	.26	.30	.33	.34	.36	.40	.46	.49
900	.18	.20	.22	.26	.27	.30	.33	.37	.39	.40	.44	.51	.55
1000	.20	.22	.24	.29	.31	.33	.37	.41	.43	.45	.49	.57	.62
1100	.22	.25	.26	.31	.34	.36	.40	.45	.47	.49	.54	.63	.68
1160	.23	.26	.28	.33	.36	.38	.42	.46	.50	.52	.56	.66	.71
1200	.24	.27	.29	.34	.37	.39	.44	.49	.52	.54	.59	.68	.74
1300	.26	.29	.31	.37	.40	.42	.48	.53	.56	.58	.64	.74	.80
1400	.28	.31	.34	.40	.43	.46	.52	.57	.60	.63	.69	.80	.86
1500	.30	.34	.36	.43	.46	.49	.55	.61	.64	.67	.74	.86	.92
1600	.33	.36	.40	.46	.49	.53	.59	.65	.69	.72	.79	.91	.98
1700	.35	.38	.42	.49	.52	.56	.63	.67	.73	.77	.83	.97	1.04
1750	.36	.39	.43	.50	.53	.58	.64	.72	.75	.79	.86	1.00	1.07
1800	.37	.40	.44	.51	.55	.59	.66	.74	.77	.81	.88	1.03	1.10
2000	.41	.45	.49	.57	.62	.65	.74	.82	.86	.90	.98	1.15	1.23
2200	.45	.49	.54	.63	.68	.72	.81	.90	.94	.99	1.08	1.25	1.34
2400	.49	.54	.59	.68	.74	.79	.88	.98	1.03	1.07	1.18	1.37	1.46
2600	.53	.58	.64	.74	.80	.85	.96	1.06	1.12	1.17	1.25	1.48	1.58
2800	.57	.63	.69	.80	.86	.92	1.03	1.15	1.20	1.26	1.37	1.59	1.71
3000	.61	.67	.74	.86	.92	.98	1.10	1.23	1.28	1.34	1.46	1.71	1.82
3200	.65	.72	.79	.91	.98	1.05	1.18	1.30	1.37	1.43	1.56	1.81	1.94
3400	.69	.77	.83	.97	1.04	1.11	1.25	1.38	1.45	1.52	1.66	1.92	2.05
3500	.72	.79	.86	1.00	1.07	1.15	1.28	1.42	1.49	1.57	1.71	1.98	2.11
3600	.74	.81	.88	1.03	1.10	1.18	1.32	1.46	1.54	1.61	1.75	2.03	2.16
3800	.78	.83	.93	1.09	1.17	1.24	1.39	1.54	1.62	1.70	1.84	2.13	2.27
4000	.82	.90	.98	1.15	1.23	1.30	1.46	1.63	1.71	1.78	1.94	2.24	2.39
4200	.86	.94	1.03	1.20	1.28	1.37	1.53	1.71	1.78	1.86	2.03	2.35	2.50
4400	.90	.99	1.08	1.25	1.34	1.43	1.61	1.78	1.86	1.95	2.12	2.45	2.61
4600	.94	1.03	1.13	1.31	1.40	1.50	1.68	1.86	1.95	2.04	2.21	2.55	2.71
4800	.98	1.07	1.18	1.37	1.46	1.56	1.75	1.94	2.03	2.13	2.30	2.65	2.82
5000	1.02	1.12	1.23	1.42	1.52	1.63	1.82	2.01	2.11	2.20	2.39	2.75	2.92
5500	—	—	—	—	1.67	1.78	2.00	2.20	2.30	2.41	2.61	2.99	3.18
6000	—	—	—	—	1.82	1.94	2.16	2.39	2.50	2.61	2.82	3.23	3.41
6500	—	—	—	—	1.96	2.09	2.34	2.57	2.69	2.80	3.03	3.42	3.64
7000	—	—	—	—	2.11	2.24	2.50	2.75	2.87	2.99	3.23	3.65	3.84
7500	—	—	—	—	2.25	2.39	2.66	2.92	3.05	3.18	3.41	3.84	4.03
8000	—	—	—	—	—	—	2.82	3.10	3.23	3.34	3.59	4.02	4.21
8500	—	—	—	—	—	—	2.97	3.26	3.39	3.52	3.76	4.19	4.37
9000	—	—	—	—	—	—	3.13	3.41	3.55	3.68	3.92	4.34	4.51
9500	—	—	—	—	—	—	3.28	3.56	3.70	3.83	4.07	4.47	4.63
10000	—	—	—	—	—	—	3.41	3.71	3.84	3.97	4.21	4.59	4.72

XL Belt Width Table

Belt Width Factor	.15	.28	.35	.42	.57	.71	.86	1.00	1.29	1.56
Belt Width	1/4	3/8	7/16	1/2	5/8	3/4	7/8	1	1 1/4	1 1/2
Belt Width Code	025	037	043	050	062	075	087	100	125	150

Shaded area indicates stock belt widths.

* HP ratings are for conventional speed-reduction drives.

• Pulley diameter is below recommended minimum. A reduction in belt life should be expected.

Suggest alternate drive, whenever possible.

L

Horsepower Ratings

Martin

L - 3/8" Pitch

RPM of Faster Shaft	HP for a 1" Wide Belt for Various Pulleys*																		
	10L 1.194 P.D.	12L 1.432 P.D.	13L■ 1.552 P.D.	14L 1.671 P.D.	15L■ 1.790 P.D.	16L 1.910 P.D.	17L■ 2.029 P.D.	18L 2.149 P.D.	19L■ 2.268 P.D.	20L 2.387 P.D.	21L■ 2.507 P.D.	22L 2.626 P.D.	24L 2.865 P.D.	26L 3.104 P.D.	28L 3.342 P.D.	30L 3.581 P.D.	32L 3.820 P.D.	40L 4.775 P.D.	48L 5.730 P.D.
100	•.05	.06	.07	.07	.08	.08	.09	.09	.10	.10	.11	.12	.13	.14	.15	.16	.17	.21	.25
200	•.10	.13	.14	.15	.16	.17	.18	.19	.20	.21	.22	.23	.25	.27	.29	.31	.33	.42	.50
300	•.16	.19	.20	.22	.23	.25	.27	.28	.30	.31	.33	.34	.38	.41	.44	.47	.50	.63	.75
400	•.21	.25	.27	.29	.31	.33	.35	.38	.40	.42	.44	.46	.50	.54	.58	.62	.67	.83	1.00
500	•.26	.31	.34	.37	.39	.42	.44	.47	.50	.52	.55	.57	.63	.68	.73	.78	.83	1.04	1.24
600	•.31	.37	.41	.44	.47	.50	.53	.56	.59	.63	.66	.69	.75	.81	.87	.94	1.00	1.24	1.49
700	•.37	.44	.47	.51	.55	.58	.62	.66	.69	.73	.77	.80	.87	.95	1.02	1.09	1.16	1.45	1.73
800	•.42	.50	.54	.58	.62	.67	.71	.75	.79	.83	.87	.92	1.00	1.08	1.16	1.24	1.32	1.65	1.97
870	•.45	.54	.59	.63	.68	.73	.77	.82	.86	.91	.95	1.00	1.08	1.17	1.26	1.35	1.44	1.79	2.14
900	•.47	.56	.61	.66	.70	.75	.80	.84	.89	.94	.98	1.03	1.12	1.21	1.30	1.40	1.49	1.85	2.21
1000	•.52	.62	.68	.73	.78	.83	.89	.94	.99	1.04	1.09	1.14	1.24	1.34	1.45	1.55	1.65	2.05	2.44
1100	•.57	.69	.75	.80	.86	.92	.97	1.03	1.08	1.14	1.20	1.25	1.36	1.48	1.59	1.70	1.81	2.25	2.67
1160	•.60	.72	.79	.85	.91	.97	1.03	1.08	1.14	1.20	1.26	1.32	1.44	1.56	1.67	1.79	1.91	2.36	2.81
1200	•.63	•.75	.81	.88	.94	1.00	1.06	1.12	1.18	1.24	1.30	1.36	1.49	1.61	1.73	1.85	1.97	2.44	2.90
1300	•.68	•.81	.88	.95	1.01	1.08	1.15	1.21	1.28	1.34	1.41	1.48	1.61	1.74	1.87	2.00	2.13	2.63	3.12
1400	•.73	•.87	.95	1.02	1.09	1.16	1.23	1.30	1.38	1.45	1.52	1.59	1.73	1.87	2.01	2.15	2.29	2.82	3.34
1500	•.78	•.94	•1.02	1.09	1.16	1.24	1.32	1.40	1.47	1.55	1.62	1.70	1.85	2.00	2.15	2.30	2.44	3.01	3.55
1600	•.83	•1.00	•1.08	1.16	1.24	1.32	1.41	1.49	1.57	1.65	1.73	1.81	1.97	2.13	2.28	2.44	2.60	3.20	3.76
1700	•.89	•1.06	•1.15	1.23	1.32	1.41	1.49	1.58	1.66	1.75	1.83	1.92	2.09	2.26	2.42	2.59	2.75	3.38	3.97
1750	•.91	•1.09	•1.17	1.27	1.36	1.45	1.54	1.62	1.71	1.80	1.89	1.98	2.15	2.32	2.49	2.66	2.83	3.47	4.06
1800	—	•1.12	•1.21	•1.30	1.39	1.49	1.58	1.67	1.76	1.85	1.94	2.03	2.21	2.38	2.56	2.73	2.90	3.55	4.16
1900	—	•1.18	•1.27	•1.38	1.47	1.57	1.66	1.76	1.85	1.95	2.04	2.14	2.32	2.51	2.69	2.87	3.05	3.73	4.35
2000	—	•1.24	•1.35	•1.45	1.55	1.65	1.75	1.85	1.95	2.05	2.15	2.25	2.44	2.63	2.82	3.01	3.19	3.89	4.54
2200	—	•1.36	•1.48	•1.59	1.70	1.81	1.92	2.03	2.14	2.25	2.35	2.46	2.67	2.88	3.08	3.28	3.49	4.23	4.89
2400	—	•1.49	•1.61	•1.73	1.85	1.97	2.09	2.21	2.32	2.44	2.56	2.67	2.90	3.12	3.34	3.56	3.76	4.54	5.21
2500	—	•1.55	•1.68	•1.80	•1.92	2.05	2.17	2.30	2.42	2.54	2.66	2.78	3.01	3.24	3.47	3.68	3.90	4.69	5.35
2600	—	•1.61	•1.74	•1.87	•2.00	2.13	2.26	2.38	2.51	2.63	2.76	2.99	3.12	3.36	3.59	3.81	4.03	4.83	5.48
2800	—	•1.73	•1.87	•2.01	•2.14	2.29	2.42	2.56	2.69	2.82	2.96	3.09	3.34	3.59	3.83	4.06	4.29	5.10	5.73
3000	—	•1.85	•2.00	•2.15	•2.29	2.44	2.59	2.73	2.87	3.01	3.15	3.29	3.55	3.81	4.06	4.30	4.54	5.35	5.94
3200	—	—	•2.13	•2.28	•2.44	2.60	2.74	2.90	3.04	3.19	3.34	3.48	3.76	4.03	4.29	4.54	4.77	5.57	6.11
3400	—	—	•2.26	•2.42	•2.58	2.75	2.91	3.07	3.22	3.37	3.53	3.67	3.97	4.24	4.50	4.76	4.99	5.78	6.23
3500	—	—	•2.32	•2.49	•2.65	2.83	2.99	3.15	3.31	3.46	3.62	3.77	4.06	4.35	4.61	4.86	5.10	5.87	6.27
3600	—	—	—	•2.55	•2.73	•2.90	•3.07	3.23	3.39	3.55	3.71	3.86	4.16	4.45	4.72	4.97	5.21	5.95	6.31
3800	—	—	—	•2.69	•2.86	•3.03	•3.22	3.40	3.56	3.73	3.89	4.05	4.35	4.64	4.91	5.16	5.40	6.09	6.33
4000	—	—	—	•2.83	•3.00	•3.20	•3.37	3.56	3.73	3.89	4.06	4.23	4.54	4.83	5.10	5.34	5.57	6.21	6.31
4200	—	—	—	—	•3.15	•3.34	•3.53	3.72	3.88	4.06	4.23	4.40	4.72	5.01	5.28	5.52	5.74	6.28	6.23
4400	—	—	—	—	•3.28	•3.49	•3.67	3.86	4.04	4.22	4.40	4.57	4.89	5.19	5.44	5.68	5.88	6.33	†6.09
4600	—	—	—	—	•3.41	•3.63	•3.82	4.01	4.20	4.38	4.56	4.73	5.05	5.34	5.59	5.82	6.01	6.35	†5.89
4800	—	—	—	—	•3.54	•3.77	•3.96	4.17	4.35	4.54	4.72	4.89	5.20	5.48	5.73	5.94	6.12	6.32	†5.63
5000	—	—	—	—	•3.67	•3.91	•4.10	•4.31	•4.50	4.68	4.86	5.04	5.35	5.63	5.86	6.06	6.20	6.26	†5.30
5200	—	—	—	—	•3.81	•4.03	•4.23	•4.45	•4.63	4.82	5.01	5.18	5.48	5.76	5.98	6.15	6.27	†6.16	†4.91
5400	—	—	—	—	•3.93	•4.17	•4.37	•4.59	•4.77	4.96	5.14	5.31	5.61	5.88	6.07	6.23	6.32	†6.01	†4.44
5600	—	—	—	—	•4.05	•4.29	•4.50	•4.72	•4.91	5.09	5.28	5.44	5.73	5.98	6.16	6.28	6.34	†5.83	†3.89
5800	—	—	—	—	•4.17	•4.42	•4.62	•4.84	•5.04	5.22	5.40	5.57	5.84	6.07	6.23	6.32	6.34	†5.60	†3.27
6000	—	—	—	—	•4.29	•4.55	•4.75	•4.97	•5.15	5.34	5.52	5.68	5.93	6.15	6.28	6.35	6.33	†5.32	†2.57

PULLEYS

L Belt Width Table

Belt Width Factor	.28	.35	.42	.57	.71	.86	1.00	1.29	1.56	1.84	2.14	2.72	3.36
Belt Width	3/8	7/16	1/2	5/8	3/4	7/8	1	1 1/4	1 1/2	1 3/4	2	2 1/2	3
Belt Width Code	037	043	050	062	075	087	100	125	150	175	200	250	300

Shaded area indicates stock belt widths.

* HP ratings are for conventional speed-reduction drives.

■ Special non-stock sizes.

† Belt speed exceeds 6500 fpm — consult factory.

• Pulley diameter is below recommended minimum. A reduction in belt life should be expected.

Suggest alternate drive, whenever possible.



Horsepower Ratings

H

H - 1/2" Pitch

RPM of Faster Shaft	HP for a 1" Wide Belt for Various Pulleys*																
	14H 2.228 P.D.	16H 2.546 P.D.	17H 2.706 P.D.	18H 2.865 P.D.	19H 3.024 P.D.	20H 3.183 P.D.	21H 3.342 P.D.	22H 3.501 P.D.	24H 3.820 P.D.	26H 4.138 P.D.	28H 4.456 P.D.	30H 4.775 P.D.	32H 5.093 P.D.	36H 5.730 P.D.	40H 6.366 P.D.	44H 7.003 P.D.	48H 7.639 P.D.
100	.25	.28	.30	.32	.34	.35	.37	.39	.42	.46	.50	.53	.57	.64	.71	.78	.85
200	.50	.57	.60	.64	.67	.71	.74	.78	.85	.92	.99	1.06	1.13	1.27	1.41	1.56	1.70
300	.74	.85	.90	.96	1.01	1.06	1.11	1.17	1.27	1.38	1.49	1.59	1.70	1.91	2.12	2.33	2.54
400	.99	1.13	1.20	1.27	1.34	1.41	1.49	1.56	1.70	1.84	1.98	2.12	2.26	2.54	2.82	3.10	3.38
500	1.24	1.41	1.50	1.59	1.68	1.77	1.86	1.94	2.12	2.30	2.47	2.65	2.82	3.17	3.52	3.87	4.22
600	1.49	1.70	1.80	1.91	2.02	2.12	2.23	2.33	2.54	2.75	2.96	3.17	3.38	3.80	4.22	4.64	5.05
700	1.73	1.98	2.10	2.23	2.35	2.47	2.59	2.72	2.96	3.21	3.45	3.70	3.94	4.43	4.91	5.40	5.88
800	1.98	2.26	2.40	2.54	2.68	2.82	2.96	3.10	3.38	3.66	3.94	4.22	4.50	5.05	5.60	6.15	6.69
900	•2.23	2.54	2.70	2.86	3.01	3.17	3.33	3.49	3.80	4.11	4.43	4.74	5.05	5.67	6.29	6.89	7.50
1000	•2.47	2.82	3.00	3.17	3.35	3.52	3.70	3.87	4.22	4.57	4.91	5.26	5.60	6.29	6.96	7.63	8.30
1100	•2.72	3.10	3.30	3.49	3.68	3.87	4.06	4.26	4.64	5.02	5.40	5.77	6.15	6.90	7.63	8.36	9.08
1160	•2.86	3.27	3.47	3.68	3.88	4.08	4.28	4.48	4.89	5.28	5.68	6.08	6.48	7.26	8.03	8.80	9.55
1200	—	•3.38	3.59	3.80	4.01	4.22	4.43	4.64	5.05	5.46	5.88	6.29	6.69	7.50	8.30	9.08	9.86
1300	—	•3.66	3.89	4.12	4.34	4.57	4.79	5.01	5.46	5.91	6.35	6.79	7.23	8.10	8.95	9.79	10.62
1400	—	•3.94	4.19	4.43	4.67	4.91	5.15	5.39	5.87	6.35	6.83	7.30	7.77	8.69	9.60	10.49	11.36
1500	—	•4.22	•4.48	4.74	5.00	5.26	5.51	5.77	6.28	6.79	7.30	7.80	8.30	9.28	10.24	11.18	12.09
1600	—	•4.50	•4.78	5.05	5.33	5.60	5.87	6.15	6.69	7.23	7.77	8.30	8.82	9.86	10.87	11.85	12.80
1700	—	•4.77	•5.07	5.36	5.65	5.94	6.23	6.52	7.10	7.67	8.23	8.79	9.34	10.43	11.49	12.51	13.50
1750	—	•4.91	•5.22	5.52	5.81	6.11	6.41	6.71	7.30	7.88	8.46	9.03	9.60	10.71	11.79	12.84	13.84
1800	—	•5.05	•5.36	•5.67	5.98	6.28	6.59	6.89	7.50	8.10	8.69	9.28	9.86	10.99	12.09	13.15	14.18
1900	—	•5.42	•5.66	•5.98	6.30	6.62	6.94	7.26	7.90	8.53	9.15	9.76	10.36	11.55	12.69	13.78	14.83
2000	—	•5.60	•5.95	•6.28	6.62	6.96	7.30	7.63	8.29	8.95	9.60	10.24	10.87	12.10	13.27	14.40	15.46
2100	—	—	•6.59	6.94	7.29	7.65	8.00	8.69	9.37	10.05	10.71	11.36	12.63	13.84	14.99	16.08	—
2200	—	•6.89	7.26	7.63	8.00	8.36	9.08	9.79	10.49	11.18	11.85	13.16	14.40	15.57	16.66	—	—
2300	—	—	•7.20	7.58	7.96	8.34	8.72	9.47	10.21	10.93	11.64	12.33	13.68	14.94	16.13	17.23	—
2400	—	—	—	•7.50	7.90	8.29	8.69	9.08	9.85	10.62	11.37	12.09	12.80	14.18	15.46	16.66	17.76
2500	—	—	•7.80	•8.21	8.62	9.03	9.44	10.23	11.02	11.80	12.54	13.27	14.68	15.98	17.18	18.27	—
2600	—	—	—	•8.10	•8.52	8.95	9.37	9.79	10.61	11.42	12.22	12.98	13.72	15.16	16.47	17.67	18.75
2800	—	—	—	•8.69	•9.14	9.59	10.04	10.49	11.35	12.21	13.05	13.84	14.61	16.09	17.41	18.60	19.63
3000	—	—	•9.28	•9.75	10.23	10.70	11.18	12.08	12.98	13.85	14.67	15.46	16.96	18.27	19.42	20.38	—
3200	—	—	•9.85	•10.36	10.85	11.35	11.85	12.79	13.72	14.63	15.46	16.27	17.78	19.06	20.14	20.99	—
3400	—	—	•10.43	•10.95	11.47	11.99	12.51	13.48	14.45	15.37	16.22	17.03	18.53	19.76	20.75	†21.46	—
3500	—	—	•10.71	•11.24	11.77	12.31	12.84	13.82	14.80	15.74	16.59	17.40	18.89	20.08	21.01	†21.63	—
3600	—	—	—	—	•12.07	12.62	13.16	14.16	15.15	16.09	16.95	17.75	19.22	20.37	†21.24	†21.77	—
3800	—	—	—	—	•12.67	13.23	13.79	14.81	15.82	16.78	17.63	18.42	19.85	20.89	†21.60	†21.92	—
4000	—	—	—	•13.24	13.82	14.40	15.44	16.46	17.43	18.27	19.04	20.40	†21.31	†21.83	†21.90	—	—
4200	—	—	—	—	—	•13.81	14.41	15.00	16.04	17.08	18.05	18.87	19.61	20.88	†21.62	†21.93	†21.70
4400	—	—	—	—	—	•14.36	14.97	15.57	16.63	17.67	18.62	19.42	20.12	†21.27	†21.83	†21.87	†21.32
4600	—	—	—	—	•14.90	15.52	16.13	17.18	18.22	19.16	20.57	†21.58	†21.92	†21.67	†20.73	—	—
4800	—	—	—	—	•15.42	•16.05	16.67	17.71	18.74	19.66	20.37	†21.81	†21.89	†21.30	†19.93	—	—
5000	—	—	—	•15.93	•16.56	17.19	18.22	19.23	20.12	20.77	†21.29	†21.95	†21.73	†20.77	—	—	—
5200	—	—	•16.41	•17.05	17.69	18.69	19.68	20.53	†21.11	†21.54	†21.99	†21.44	†20.06	—	—	—	—
5400	—	—	•16.89	•17.53	18.16	19.13	20.09	20.90	†21.39	†21.73	†21.93	†21.02	—	—	—	—	—
5600	—	—	—	•17.34	•17.98	•18.61	19.55	20.47	†21.22	†21.62	†21.85	†21.76	†20.46	—	—	—	—
5800	—	—	—	•17.77	•18.41	•19.04	19.93	20.80	†21.49	†21.78	†21.89	†21.50	†19.75	—	—	—	—
6000	—	—	—	—	—	•18.19	•18.82	•19.41	20.27	†21.10	†21.70	†21.88	†21.85	†21.12	—	—	—

H Belt Width Table

Belt Width Factor	.42	.57	.71	.86	1.00	1.29	1.56	1.84	2.14	2.72	3.36	4.06	4.76	6.15	7.50	8.89	10.32
Belt Width	1/2	5/8	3/4	7/8	1	1 1/4	1 1/2	1 3/4	2	2 1/2	3	3 1/2	4	5	6	7	8
Belt Width Code	050	062	075	087	100	125	150	175	200	250	300	350	400	500	600	700	800

Shaded area indicates stock belt widths.

* HP ratings are for conventional speed-reduction drives.

■ Special non-stock sizes.

† Belt speed exceeds 6500 fpm — consult factory.

• Pulley diameter is below recommended minimum. A reduction in belt life should be expected.

Suggest alternate drive, whenever possible.

PULLEYS

XH

Horsepower Ratings

Martin

XH - 7/8" Pitch

RPM of Faster Shaft	HP for a 1" Wide Belt for Various Pulleys*									
	18 XH 5.013 P.D.	20 XH 5.570 P.D.	22 XH 6.127 P.D.	24 XH 6.685 P.D.	26 XH 7.241 P.D.	28 XH 7.799 P.D.	30 XH 8.356 P.D.	32 XH 8.910 P.D.	40 XH 11.141 P.D.	
100	• .76	.84	.93	1.01	1.11	1.18	1.26	1.34	1.68	
200	•1.51	1.68	1.85	2.02	2.19	2.36	2.52	2.69	3.37	
300	•2.28	2.52	2.78	3.03	3.28	3.54	3.78	4.03	5.02	
400	•3.03	3.37	3.70	4.03	4.37	4.70	5.02	5.36	6.66	
480	•3.63	4.03	4.43	4.82	5.22	5.62	6.00	6.40	7.95	
500	•3.78	• 4.20	4.61	5.02	5.44	5.85	6.26	6.71	8.26	
510	•3.86	• 4.29	4.71	5.12	5.54	5.97	6.37	6.80	8.42	
570	•4.30	• 4.77	5.25	5.72	6.17	6.65	7.10	7.56	9.36	
600	•4.53	• 5.02	5.52	6.00	6.50	6.98	7.47	7.95	9.82	
680	•5.12	• 5.68	6.24	6.80	7.34	7.88	8.42	8.96	11.04	
700	•5.27	• 5.84	6.42	6.98	7.54	8.10	8.66	9.21	11.35	
800	•6.00	• 6.66	7.31	7.95	8.59	9.21	9.83	10.44	12.80	
870	•6.52	• 7.23	7.92	8.61	9.29	9.97	10.63	11.29	13.79	
900	•6.74	• 7.46	• 8.19	8.90	9.59	10.29	10.97	11.64	14.18	
1000	•7.47	• 8.26	• 9.05	9.82	10.59	11.35	12.08	12.80	15.51	
1100	•8.19	• 9.05	• 9.91	10.75	11.56	12.38	13.15	13.92	16.74	
1160	•8.61	• 9.51	•10.41	11.29	12.13	12.97	13.79	14.57	17.44	
1200	—	• 9.83	•10.75	•11.64	12.51	13.37	14.29	14.99	17.89	
1300	—	•10.59	•11.57	•12.51	13.44	14.32	15.18	16.01	18.94	
1400	—	•11.35	•12.37	•13.37	14.32	15.25	16.14	16.98	19.87	
1500	—	•12.08	•13.15	•14.19	15.18	16.14	17.03	17.89	20.71	
1600	—	•12.80	•13.92	•14.99	16.01	16.98	17.14	18.82	21.42	
1700	—	•13.50	•14.66	•15.76	16.80	17.78	18.68	19.51	21.99	
1750	—	•13.85	•15.03	•16.14	17.17	18.16	19.06	19.87	22.22	
1800	—	—	•15.37	•16.51	•17.56	18.53	19.42	20.22	22.35	
1900	—	—	•16.07	•17.22	•18.65	19.23	20.69	20.86	22.70	
2000	—	—	•16.74	•17.89	•18.94	19.87	20.71	21.42	22.84	
2100	—	—	•17.39	•18.53	•19.56	20.48	21.25	21.88	22.81	
2200	—	—	•18.00	•19.43	•20.14	21.01	21.72	22.27	22.61	
2300	—	—	•18.59	•19.70	•20.67	21.47	22.11	22.55	†22.30	
2400	—	—	•19.31	•20.22	•21.14	21.88	22.42	22.75	†21.65	
2500	—	—	—	•20.71	•21.57	•22.22	22.64	22.84	†20.89	
2600	—	—	—	•21.14	•21.94	•22.49	22.80	22.82	†19.92	
2800	—	—	—	•21.89	•22.49	•22.81	22.81	†22.47	—	
3000	—	—	—	•22.42	•22.80	•22.81	†22.44	†21.65	—	
3200	—	—	—	•22.75	•22.82	•22.47	†21.65	†20.33	—	
3400	—	—	—	•22.84	•22.58	•21.78	†20.42	†18.48	—	
3500	—	—	—	•22.81	†•22.34	†•21.29	†19.64	—	—	
3600	—	—	—	•22.71	†•22.02	†•20.72	†18.73	—	—	
3800	—	—	—	†•22.31	†•21.41	†•19.22	—	—	—	
4000	—	—	—	†•21.65	†•19.92	—	—	—	—	
4200	—	—	—	†•20.71	†•18.33	—	—	—	—	
4400	—	—	—	†•19.47	—	—	—	—	—	

PULLEYS

XH, XXH Belt Width Table

Belt Width Factor	1.00	1.29	1.56	1.84	2.14	2.72	3.36	4.06	4.76	6.15	7.50	8.89	10.32	11.70	13.10	14.41	15.84	17.16	18.62
Belt Width	1	1¼	1½	1¾	2	2½	3	3½	4	5	6	7	8	9	10	11	12	13	14
Belt Width Code	100	125	150	175	200	250	300	350	400	500	600	700	800	900	1000	1100	1200	1300	1400

Shaded area indicates stock belt widths.

* HP ratings are for conventional speed-reduction drives.

† Belt speed exceeds 6500 fpm — consult factory.

• Pulley diameter is below recommended minimum. A reduction in belt life should be expected.

Suggest alternate drive, whenever possible.



Timing Pulley Diameters

XL - 1/8" Pitch

No. Teeth	Diameter		No. Teeth	Diameter		No. Teeth	Diameter		No. Teeth	Diameter		No. Teeth	Diameter	
	P.D.	O.D.		P.D.	O.D.		P.D.	O.D.		P.D.	O.D.		P.D.	O.D.
10XL	.637	.617	33XL	2.101	2.081	55XL	3.501	3.481	77XL	4.902	4.882	99XL	6.303	6.283
11XL	.700	.680	34XL	2.165	2.145	56XL	3.565	3.545	78XL	4.966	4.946	100XL	6.346	6.326
12XL	.764	.744	35XL	2.228	2.208	57XL	3.629	3.609	79XL	5.029	5.009	101XL	6.430	6.410
13XL	.828	.808	36XL	2.292	2.272	58XL	3.692	3.672	80XL	5.093	5.073	102XL	6.494	6.474
14XL	.891	.871	37XL	2.355	2.335	59XL	3.756	3.736	81XL	5.157	5.137	103XL	6.557	6.537
15XL	.955	.935	38XL	2.419	2.399	60XL	3.820	3.800	82XL	5.220	5.200	104XL	6.621	6.601
16XL	1.019	.999	39XL	2.483	2.463	61XL	3.883	3.863	83XL	5.284	5.264	105XL	6.685	6.665
17XL	1.082	1.062	40XL	2.546	2.526	62XL	3.947	3.927	84XL	5.348	5.328	106XL	6.748	6.728
18XL	1.146	1.126	41XL	2.610	2.590	63XL	4.011	3.991	85XL	5.411	5.391	107XL	6.812	6.792
19XL	1.210	1.190	42XL	2.674	2.654	64XL	4.074	4.054	86XL	5.475	5.455	108XL	6.875	6.855
20XL	1.273	1.253	43XL	2.737	2.717	65XL	4.138	4.118	87XL	5.539	5.519	109XL	6.939	6.919
21XL	1.337	1.317	44XL	2.801	2.781	66XL	4.202	4.182	88XL	5.602	5.582	110XL	7.003	6.983
22XL	1.401	1.381	45XL	2.865	2.845	67XL	4.265	4.245	89XL	5.666	5.646	111XL	7.066	7.046
23XL	1.464	1.444	46XL	2.928	2.908	68XL	4.329	4.309	90XL	5.730	5.710	112XL	7.130	7.110
24XL	1.528	1.508	47XL	2.992	2.972	69XL	4.393	4.373	91XL	5.793	5.773	113XL	7.194	7.174
25XL	1.592	1.572	48XL	3.056	3.036	70XL	4.456	4.436	92XL	5.857	5.837	114XL	7.257	7.237
26XL	1.655	1.635	49XL	3.119	3.099	71XL	4.520	4.500	93XL	5.921	5.901	115XL	7.321	7.301
27XL	1.719	1.699	50XL	3.183	3.163	72XL	4.584	4.564	94XL	5.984	5.964	116XL	7.385	7.365
28XL	1.783	1.763	51XL	3.247	3.227	73XL	4.647	4.627	95XL	6.048	6.028	117XL	7.448	7.428
29XL	1.846	1.826	52XL	3.310	3.290	74XL	4.711	4.691	96XL	6.112	6.092	118XL	7.512	7.492
30XL	1.910	1.890	53XL	3.374	3.354	75XL	4.775	4.755	97XL	6.175	6.155	119XL	7.576	7.556
31XL	1.974	1.954	54XL	3.438	3.418	76XL	4.838	4.818	98XL	6.239	6.219	120XL	7.639	7.619
32XL	2.037	2.017												

L - 3/8" Pitch

No. Teeth	Diameter		No. Teeth	Diameter		No. Teeth	Diameter		No. Teeth	Diameter		No. Teeth	Diameter	
	P.D.	O.D.		P.D.	O.D.		P.D.	O.D.		P.D.	O.D.		P.D.	O.D.
10L	1.194	1.164	33L	3.939	3.909	56L	6.685	6.655	79L	9.430	9.400	102L	12.175	12.145
11L	1.313	1.283	34L	4.058	4.028	57L	6.804	6.774	80L	9.549	9.519	103L	12.295	12.265
12L	1.432	1.402	35L	4.178	4.148	58L	6.923	6.893	81L	9.669	9.639	104L	12.414	12.384
13L	1.552	1.522	36L	4.297	4.267	59L	7.043	7.013	82L	9.788	9.758	105L	12.533	12.503
14L	1.671	1.641	37L	4.417	4.387	60L	7.162	7.132	83L	9.907	9.877	106L	12.653	12.623
15L	1.790	1.760	38L	4.536	4.506	61L	7.281	7.251	84L	10.027	9.997	107L	12.772	12.742
16L	1.910	1.880	39L	4.655	4.625	62L	7.401	7.371	85L	10.147	10.117	108L	12.892	12.862
17L	2.029	1.999	40L	4.775	4.745	63L	7.520	7.490	86L	10.265	10.235	109L	13.011	12.981
18L	2.149	2.119	41L	4.894	4.864	64L	7.639	7.609	87L	10.385	10.355	110L	13.130	13.100
19L	2.268	2.238	42L	5.013	4.983	65L	7.759	7.729	88L	10.504	10.474	111L	13.250	13.220
20L	2.387	2.357	43L	5.133	5.103	66L	7.878	7.848	89L	10.624	10.594	112L	13.369	13.339
21L	2.507	2.477	44L	5.252	5.222	67L	7.998	7.968	90L	10.743	10.713	113L	13.488	13.458
22L	2.626	2.596	45L	5.371	5.341	68L	8.117	8.087	91L	10.862	10.832	114L	13.608	13.578
23L	2.745	2.715	46L	5.491	5.461	69L	8.236	8.206	92L	10.982	10.952	115L	13.727	13.697
24L	2.865	2.835	47L	5.610	5.580	70L	8.356	8.326	93L	11.101	11.071	116L	13.846	13.816
25L	2.984	2.954	48L	5.730	5.700	71L	8.475	8.445	94L	11.220	11.190	117L	13.966	13.936
26L	3.104	3.074	49L	5.849	5.819	72L	8.594	8.564	95L	11.340	11.310	118L	14.085	14.055
27L	3.223	3.193	50L	5.968	5.938	73L	8.714	8.684	96L	11.459	11.429	119L	14.205	14.175
28L	3.342	3.312	51L	6.088	6.058	74L	8.833	8.803	97L	11.579	11.549	120L	14.324	14.294
29L	3.462	3.432	52L	6.207	6.177	75L	8.952	8.922	98L	11.698	11.668	130L	15.518	15.488
30L	3.581	3.551	53L	6.326	6.296	76L	9.072	9.042	99L	11.817	11.787	140L	16.711	16.681
31L	3.700	3.670	54L	6.446	6.416	77L	9.191	9.161	100	11.937	11.907	150L	17.905	17.875
32L	3.820	3.790	55L	6.565	6.535	78L	9.311	9.261	101L	12.056	12.026			

PULLEYS

Timing Pulley Diameters



H - 1/2" Pitch

No. Teeth	Diameter		No. Teeth	Diameter		No. Teeth	Diameter		No. Teeth	Diameter		No. Teeth	Diameter	
	P.D.	O.D.		P.D.	O.D.		P.D.	O.D.		P.D.	O.D.		P.D.	O.D.
15H	2.387	2.333	35H	5.570	5.516	55H	8.754	8.700	75H	11.937	11.883	95H	15.120	15.066
16H	2.546	2.492	36H	5.730	5.676	56H	8.913	8.859	76H	12.096	12.042	96H	15.225	15.171
17H	2.706	2.652	37H	5.889	5.835	57H	9.072	9.018	77H	12.255	12.201	97H	15.438	15.384
18H	2.865	2.811	38H	6.048	5.994	58H	9.231	9.177	78H	12.414	12.360	98H	15.597	15.543
19H	3.024	2.970	39H	6.207	6.153	59H	9.390	9.336	79H	12.573	12.519	99H	15.756	15.702
20H	3.183	3.129	40H	6.366	6.312	60H	9.549	9.495	80H	12.732	12.678	100H	15.915	15.861
21H	3.342	3.288	41H	6.525	6.471	61H	9.708	9.654	81H	12.892	12.848	102H	16.234	16.180
22H	3.501	3.447	42H	6.685	6.631	62H	9.868	9.814	82H	13.051	12.997	104H	16.552	16.498
23H	3.661	3.607	43H	6.844	6.790	63H	10.027	9.973	83H	13.210	13.156	106H	16.870	16.816
24H	3.820	3.766	44H	7.003	6.949	64H	10.186	10.132	84H	13.369	13.315	108H	17.189	17.135
25H	3.979	3.925	45H	7.162	7.108	65H	10.345	10.291	85H	13.528	13.474	110H	17.507	17.453
26H	4.138	4.084	46H	7.321	7.267	66H	10.504	10.450	86H	13.687	13.633	115H	18.303	18.249
27H	4.297	4.243	47H	7.480	7.426	67H	10.663	10.609	87H	13.846	13.792	120H	19.099	19.045
28H	4.456	4.402	48H	7.639	7.585	68H	10.823	10.769	88H	14.005	13.952	125H	19.894	19.840
29H	4.615	4.561	49H	7.799	7.745	69H	10.982	10.928	89H	14.165	14.111	130H	20.690	20.636
30H	4.775	4.721	50H	7.958	7.904	70H	11.141	11.087	90H	14.324	14.270	135H	21.486	21.432
31H	4.934	4.880	51H	8.117	8.063	71H	11.300	11.246	91H	14.483	14.429	140H	22.282	22.228
32H	5.093	5.039	52H	8.276	8.222	72H	11.459	11.405	92H	14.642	14.588	145H	23.077	23.023
33H	5.252	5.198	53H	8.435	8.381	73H	11.618	11.564	93H	14.801	14.747	150H	23.873	23.819
34H	5.411	5.357	54H	8.594	8.540	74H	11.777	11.723	94H	14.961	14.907	156H	24.828	24.774

XH - 7/8" Pitch

No. Teeth	Diameter		No. Teeth	Diameter		No. Teeth	Diameter		No. Teeth	Diameter		No. Teeth	Diameter	
	P.D.	O.D.		P.D.	O.D.		P.D.	O.D.		P.D.	O.D.		P.D.	O.D.
18XH	5.013	4.903	45XH	12.533	12.423	70XH	19.496	19.386	95XH	26.460	26.350	120XH	33.423	33.313
20XH	5.570	5.460	46XH	12.812	12.702	71XH	19.776	19.666	96XH	26.738	26.628	122XH	33.980	33.870
22XH	6.127	6.017	47XH	13.091	12.981	72XH	20.054	19.944	97XH	27.017	26.907	124XH	34.537	34.427
23XH	6.406	6.296	48XH	13.369	13.259	73XH	20.332	20.222	98XH	27.295	27.185	126XH	35.094	34.984
24XH	6.685	6.575	49XH	13.648	13.538	74XH	20.611	20.501	99XH	27.574	27.464	128XH	35.651	35.541
25XH	6.963	6.853	50XH	13.926	13.816	75XH	20.889	20.779	100XH	27.852	27.742	130XH	36.208	36.098
26XH	7.242	7.132	51XH	14.205	14.095	76XH	21.168	21.058	101XH	28.131	28.021	132XH	36.765	36.655
27XH	7.520	7.410	52XH	14.483	14.373	77XH	21.446	21.336	102XH	28.409	28.299	134XH	37.322	37.212
28XH	7.799	7.689	53XH	14.762	14.652	78XH	21.725	21.615	103XH	28.688	28.578	136XH	37.879	37.769
29XH	8.077	7.967	54XH	15.140	14.930	79XH	21.003	21.893	104XH	28.966	28.856	138XH	38.436	38.326
30XH	8.356	8.246	55XH	15.319	15.209	80XH	22.282	22.172	105XH	29.245	29.135	140XH	38.993	38.883
31XH	8.634	8.524	56XH	15.597	15.487	81XH	22.560	22.450	106XH	29.523	29.413	142XH	39.550	39.440
32XH	8.913	8.803	57XH	15.876	15.766	82XH	22.839	22.729	107XH	29.802	29.692	144XH	40.107	39.997
33XH	9.191	9.081	58XH	16.154	16.044	83XH	23.118	23.008	108XH	30.080	29.970	146XH	40.664	40.554
34XH	9.470	9.360	59XH	16.433	16.323	84XH	23.396	23.286	109XH	30.359	30.249	150XH	41.778	41.668
35XH	9.748	9.638	60XH	16.711	16.601	85XH	23.674	23.564	110XH	30.637	30.527			
36XH	10.027	9.917	61XH	16.990	16.880	86XH	23.953	23.843	111XH	30.916	30.806			
37XH	10.305	10.195	62XH	17.268	17.158	87XH	24.231	24.121	112XH	31.194	31.084			
38XH	10.584	10.474	63XH	17.547	17.437	88XH	24.510	24.400	113XH	31.473	31.363			
39XH	10.862	10.752	64XH	17.825	17.715	89XH	24.788	24.678	114XH	31.751	31.641			
40XH	11.141	11.031	65XH	18.104	17.994	90XH	25.067	24.957	115XH	32.030	31.920			
41XH	11.419	11.309	66XH	18.382	18.272	91XH	25.345	25.235	116XH	32.308	32.198			
42XH	11.698	11.588	67XH	18.661	18.551	92XH	25.624	25.514	117XH	32.587	32.477			
43XH	11.976	11.866	68XH	18.939	18.829	93XH	25.902	25.792	118XH	32.865	32.755			
44XH	12.255	12.145	69XH	19.218	19.108	94XH	26.181	26.071	119XH	33.145	33.035			

PULLEYS

Outside Diameter Tolerances

PULLEY DIA.	O.D. TOL.	PULLEY DIA.	O.D. TOL.	PULLEY DIA.	O.D. TOL.	PULLEY DIA.	O.D. TOL.
0-1"	+0.02 -0.00	2.001" -4"	+0.04 -0.00	7.001" -12"	+0.06 -0.00	20.001 UP	+0.08 -0.00
1.000"-2"	+0.03 -0.00	4.001" -7"	+0.05 -0.00	12.001" -20"	+0.07 -0.00		

STOCK HTS SPROCKETS

FEATURES OF HTS DRIVES

- Positive Slip Proof Engagement
- Wide Speed Range
- Constant Driven Speeds
- Wide Range of Load Capabilities
- No Lubrication
- High Tension Eliminated
- High Mechanical Efficiency
- Economical Operation

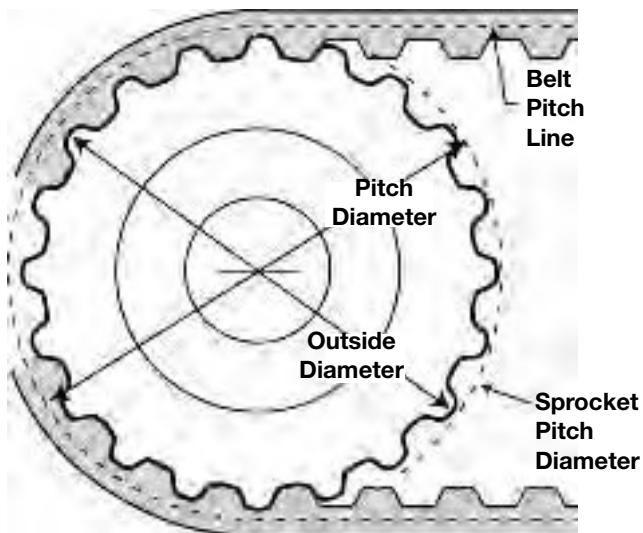
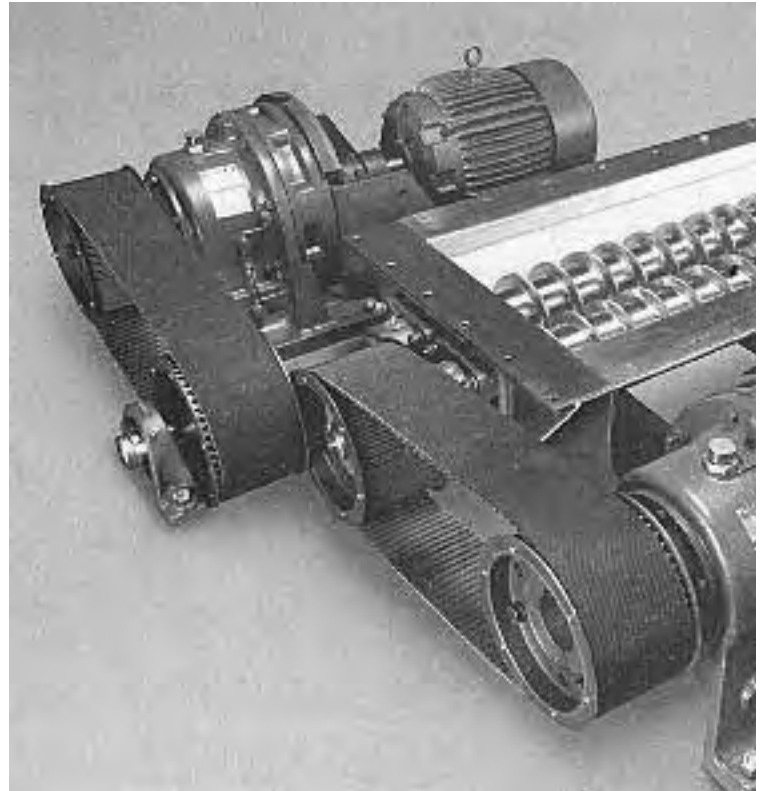

HTS HIGH TORQUE SPROCKETS

- RPP[®] Tooth Profile
- Available in 5mm, 8mm, 14mm & 20mm pitch
- Stocked in QD and Taper Bush Interchangeable Bushing Styles, as well as Stock Bore.

HTS® Drive Specification



HTS BELT DRIVE SPECIFICATIONS

Martin HTS sprockets are manufactured in various sizes, dimensions and capacities to meet industry requirements. This includes a wide range of loads, speeds, and demanding applications.

The following is an explanation of dimensional nomenclature for *Martin* HTS sprockets as well as belts currently available that will operate efficiently with the *Martin* tooth form.

The HTS sprocket has three primary dimensions:
(Number of Teeth/Pitch/Width)

The pitch is the distance in millimeters from the center of one tooth groove to the other and is measured on the sprocket's pitch circle. The pitch circle of the sprocket matches with the pitch line of the belt when in mesh. The sprocket pitch diameter is always greater than its outer diameter.

Note: Belts must be run with sprockets of the same pitch.

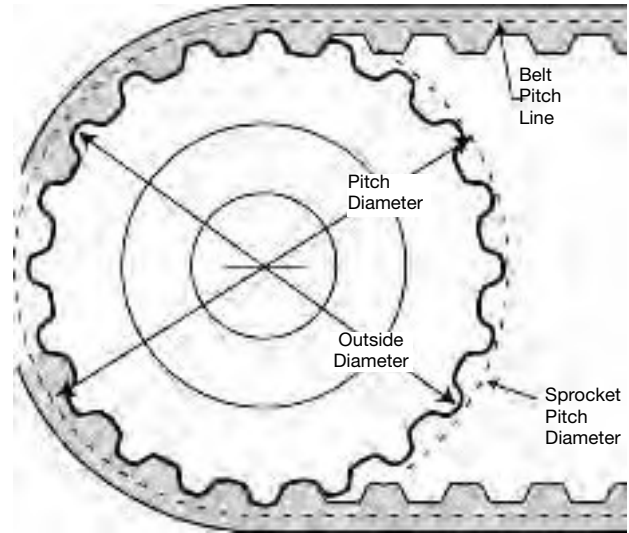
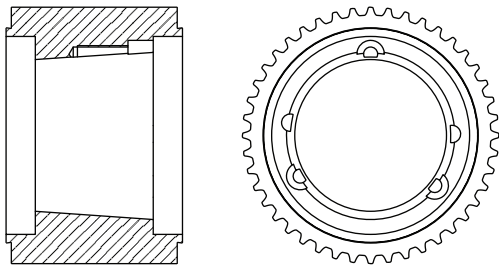

P	30	14M	55 - SK
	Number of Teeth		Bushing or MPB
HTS	Belt Pitch	Belt Width	
	5mm	15, 25	
	8mm	20, 30, 50, 85	
	14mm	40, 55, 85, 115, 170	
	20mm	115, 170, 230, 290, 340	

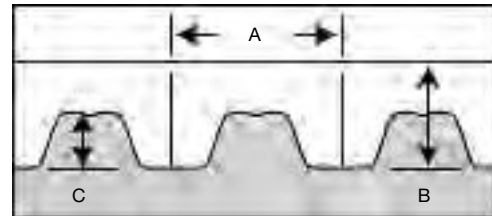

- "P" HTS Sprockets (RPP® Tooth Profile) - Run with RPP®, RPP® Plus®, Hawk Pd™, & HTD® belts.
- "P" HTS Sprockets are designed to run with fiberglass corded belts.
 - Available in 5mm, 8mm, 14mm, 20mm pitches
 - Belt widths: 15mm, 25mm (5mm pitch)
 - 20mm, 30mm, 50mm, 85mm (8mm pitch)
 - 40mm, 55mm, 85mm, 115mm, 170mm (14mm pitch)
 - 115mm, 170mm, 230mm, 290mm, 340mm (20mm pitch)

Belt Pitch	A	B	C
5MM	5MM .197IN.	3.81MM .150IN.	2.08MM .082IN.
8MM	8MM .315IN.	6MM .236IN.	3.4MM .133IN.
14MM	14MM .552IN.	10MM .394IN.	6.0MM .237IN.
20MM	20MM .784IN.	13.2MM .520IN.	8.4MM .330IN.

Hawk Pd™ is a registered trademarks of Goodyear.
RPP® and RPP® Plus® are registered trademarks of Carlisle Power Transmission. HTD® is a registered trademark of Gates Corporation.

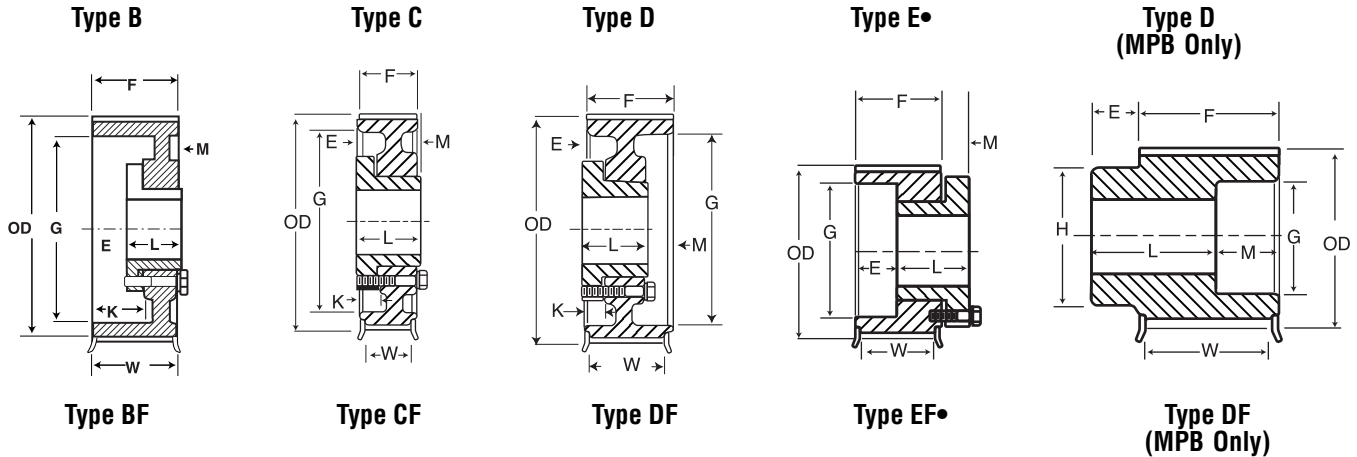

MPB 15mm (.591 in.) Wide Belts (5M-15)																
No. of Teeth	Catalog Number	Bore	Pitch	Diameter (in.)		Type +	Max. Bore	Dimensions (in.)							Weight* Approx. (lbs)	
				O.D.	Flange			E	L	M	K	H	F	G		W
32	P325M15-MPB	1/2	2.005	1.960	2.16	D1F	0.88	0.50	1.73	—	—	1.55	0.84	—	0.65	1.12
34	P345M15-MPB	1/2	2.130	2.085	2.29	D1F	1.00	0.50	1.73	—	—	1.68	0.84	—	0.65	1.25
36	P365M15-MPB	1/2	2.256	2.211	2.41	D1F	1.12	0.50	1.73	—	—	1.80	0.84	—	0.65	1.39
QD 15mm (.591in.) Wide Belts (5M-15)																
38	P385M15-JA	JA	2.381	2.336	2.54	●E1F	1.25	0.67	1.00	0.44	—	—	0.84	1.34	0.65	0.80
40	P405M15-JA	JA	2.506	2.461	2.66	●E1F	1.25	0.67	1.00	0.44	—	—	0.84	1.34	0.65	1.06
44	P445M15-JA	JA	2.757	2.712	2.91	●E1F	1.25	0.67	1.00	0.44	—	—	0.84	1.34	0.65	1.40
48	P485M15-JA	JA	3.008	2.963	3.16	B1F	1.25	0.23	1.00	0.00	0.67	—	0.84	2.36	0.65	1.20
52	P525M15-JA	JA	3.258	3.213	3.41	B1F	1.25	0.23	1.00	0.00	0.67	—	0.84	2.62	0.65	1.43
56	P565M15-SH	SH	3.509	3.464	3.66	D1F	1.68	0.08	1.25	0.06	0.42	—	0.84	2.86	0.65	1.64
60	P605M15-SH	SH	3.760	3.715	3.92	D1F	1.68	0.08	1.25	0.06	0.42	—	0.84	3.12	0.65	1.83
64	P645M15-SH	SH	4.010	3.965	4.16	D1F	1.68	0.08	1.25	0.06	0.42	—	0.84	3.37	0.65	2.16
68	P685M15-SDS	SDS	4.261	4.216	4.41	C1F	2.00	0.08	1.31	0.00	0.48	—	0.84	3.50	0.65	2.48
72	P725M15-SDS	SDS	4.511	4.466	4.66	C1F	2.00	0.08	1.31	0.00	0.48	—	0.84	3.75	0.65	2.84
80	P805M15-SDS	SDS	5.013	4.968	—	C1	2.00	0.08	1.31	0.00	0.48	—	0.84	4.25	0.65	3.61
90	P905M15-SDS	SDS	5.639	5.594	—	C1	2.00	0.08	1.31	0.00	0.48	—	0.84	4.88	0.65	4.69
112	P1125M15-SDS	SDS	7.018	6.973	—	C2	2.00	0.08	1.31	0.00	0.48	—	0.84	6.05	0.65	6.02
MPB 25mm (.984in.) Wide Belts (5M-25)																
32	P325M25-MPB	1/2	2.005	1.960	2.16	D1F	0.88	0.50	1.34	—	—	1.55	1.23	—	1.04	0.84
34	P345M25-MPB	1/2	2.130	2.085	2.29	D1F	1.00	0.50	1.34	—	—	1.68	1.23	—	1.04	0.93
36	P365M25-MPB	1/2	2.256	2.211	2.41	D1F	1.12	0.50	1.34	—	—	1.80	1.23	—	1.04	1.03
QD 25mm (.984in.) Wide Belts (5M-25)																
38	P385M25-JA	JA	2.381	2.336	2.54	●E1F	1.25	0.28	1.00	0.44	—	—	1.23	1.34	1.04	0.61
40	P405M25-JA	JA	2.506	2.461	2.66	●E1F	1.25	0.28	1.00	0.44	—	—	1.23	1.34	1.04	0.72
44	P445M25-JA	JA	2.757	2.712	2.91	●E1F	1.25	0.28	1.00	0.44	—	—	1.23	1.34	1.04	0.95
48	P485M25-JA	JA	3.008	2.963	3.16	C1F	1.25	0.16	1.00	0.00	0.28	—	1.23	2.36	1.04	0.97
52	P525M25-JA	JA	3.258	3.213	3.41	C1F	1.25	0.16	1.00	0.00	0.28	—	1.23	2.62	1.04	1.17
56	P565M25-SH	SH	3.509	3.464	3.66	D1F	1.68	0.50	1.25	0.09	0.00	—	1.23	—	1.04	1.37
60	P605M25-SH	SH	3.760	3.715	3.92	D1F	1.68	0.50	1.25	0.09	0.00	—	1.23	—	1.04	1.68
64	P645M25-SH	SH	4.010	3.965	4.16	D1F	1.68	0.50	1.25	0.09	0.00	—	1.23	—	1.04	1.80
68	P685M25-SDS	SDS	4.261	4.216	4.41	C1F	2.00	0.47	1.31	0.00	0.09	—	1.23	3.50	1.04	2.10
72	P725M25-SDS	SDS	4.511	4.466	4.66	C1F	2.00	0.47	1.31	0.00	0.09	—	1.23	3.75	1.04	2.43
80	P805M25-SDS	SDS	5.013	4.968	—	C1	2.00	0.47	1.31	0.00	0.09	—	1.23	4.25	1.04	3.15
90	P905M25-SDS	SDS	5.639	5.594	—	C1	2.00	0.47	1.31	0.00	0.09	—	1.23	4.88	1.04	4.17
112	P1125M25-SDS	SDS	7.018	6.973	—	C1	2.00	0.47	1.31	0.00	0.09	—	1.23	6.05	1.04	5.16

* Weight Shown is for Sprocket Less Bushing.
● Reverse Mount Only

+ The numbers (1=Solid, 2=Web, 3=Arms) within the "Type" indicates construction, and the letter F indicates the sprocket has flanges.

High Torque Sprockets 8mm

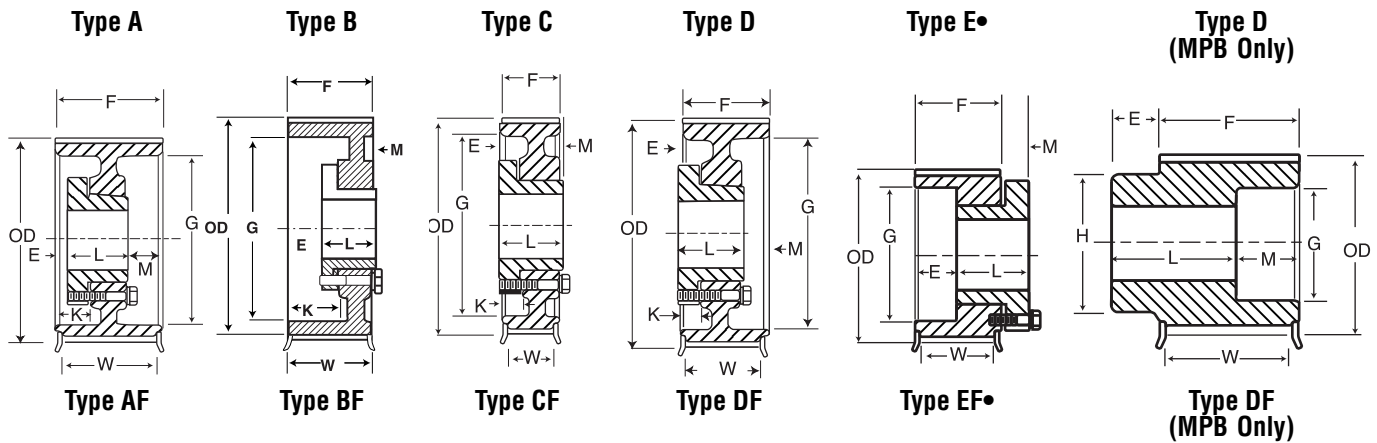

MPB 20mm (.787 in.) Wide Belts (8M-20)

No. of Teeth	Catalog Number	Bore	Pitch	Diameter (in.)		Type +	Max. Bore	Dimensions (in.)							Weight* Approx. (lbs)	
				O.D.	Flange			E	L	M	K	H	F	G		W
20	P208M20-MPB	1/2	2.005	1.951	2.375	D1F	7/8	3/8	1 1/4	0	—	1 1/2	1 1/2	—	7/8	.90
21	P218M20-MPB	1/2	2.105	2.051	2.468	D1F	1	3/8	1 1/4	0	—	1 1/2	1 1/2	—	7/8	1.00
22	P228M20-MPB	1/2	2.206	2.152	2.562	D1F	1 1/16	3/8	1 1/4	0	—	1 1/2	1 1/2	—	7/8	1.60

QD 20mm (.787 in.) Wide Belts (8M-20)

24	P248M20-JA	JA	2.406	2.352	2.750	●E1F	1 1/4	3/16	1 1/8	3/16	—	—	1 1/2	1.34	7/8	1.50
26	P268M20-JA	JA	2.607	2.553	2.937	●E1F	1 1/4	3/16	1 1/8	3/16	—	—	1 1/2	1.34	7/8	1.80
28	P288M20-H	H	2.807	2.753	3.156	●E1F	1 1/4	3/16	1 1/8	3/16	—	—	1 1/2	1.57	7/8	1.40
30	P308M20-H	H	3.008	2.954	3.344	●E1F	1 1/4	3/16	1 1/8	3/16	—	—	1 1/2	1.57	7/8	1.90
32	P328M20-H	H	3.208	3.154	3.562	C1F	1 1/4	3/16	1 1/8	0	1/4	—	1 1/2	2.56	7/8	2.00
34	P348M20-SH	SH	3.409	3.355	3.750	D1F	1 11/16	3/16	1 1/4	3/16	—	—	1 1/2	2.75	7/8	2.20
36	P368M20-SH	SH	3.609	3.555	3.937	D1F	1 11/16	3/16	1 1/4	3/16	—	—	1 1/2	2.82	7/8	2.50
38	P388M20-SH	SH	3.810	3.756	4.156	D1F	1 11/16	3/16	1 1/4	3/16	—	—	1 1/2	3.00	7/8	2.80
40	P408M20-SH	SH	4.010	3.956	4.344	D1F	1 11/16	3/16	1 1/4	3/16	—	—	1 1/2	3.00	7/8	3.00
44	P448M20-SDS	SDS	4.411	4.357	4.750	C1F	2	3/16	1 1/4	0	3/8	—	1 1/2	3.50	7/8	3.20
48	P488M20-SDS	SDS	4.812	4.758	5.157	C1F	2	3/16	1 1/4	0	3/8	—	1 1/2	3.8	7/8	3.40
56	P568M20-SDS	SDS	5.614	5.560	5.937	C1F	2	3/16	1 1/4	0	3/8	—	1 1/2	4.6	7/8	4.50
64	P648M20-SDS	SDS	6.416	6.362	6.750	C1F	2	3/16	1 1/4	0	3/8	—	1 1/2	5.4	7/8	5.50
72	P728M20-SDS	SDS	7.218	7.164	7.562	C1F	2	3/16	1 1/4	0	3/8	—	1 1/2	6.2	7/8	6.00
80	P808M20-SDS	SDS	8.020	7.966	8.375	C2F	2	3/16	1 1/4	0	3/8	—	1 1/2	6.9	7/8	6.50
90	P908M20-SDS	SDS	9.023	8.969	—	C2	2	3/16	1 1/4	0	3/8	—	1 1/2	7.62	—	7.00
112	P1128M20-SK	SK	11.229	11.175	—	C3	2 3/8	3/4	1 1/2	3/8	3/8	—	1 1/2	9.87	—	10.50
144	P1448M20-SF	SF	14.447	14.388	—	C3	2 5/8	3/4	2 1/4	3/8	3/8	—	1 1/2	12.88	—	14.50

Taper Bushed 20mm (.787 in.) Wide Belts (8M-20)

24	P248M20-1108	1108	2.406	2.352	2.75	KF-1	1	1/16	3/8	3/16	—	—	1 1/2	1.783	7/8	.7
26	P268M20-1108	1108	2.607	2.553	2.94	KF-1	1	1/16	3/8	3/16	—	—	1 1/2	1.971	7/8	.9
28	P288M20-1108	1108	2.807	2.753	3.16	KF-1	1	1/16	3/8	3/16	—	—	1 1/2	2.000	7/8	1.2
30	P308M20-1210	1210	3.008	2.954	3.34	KF-1	1 1/4	1/8	1	—	—	—	1 1/2	0	7/8	1.2
32	P328M20-1210	1210	3.208	3.154	3.56	KF-1	1 1/4	1/8	1	—	—	—	1 1/2	0	7/8	1.4
34	P348M20-1610	1610	3.409	3.355	3.75	KF-1	1 11/16	1/8	1	—	—	—	1 1/2	0	7/8	1.4
36	P368M20-1610	1610	3.609	3.555	3.94	KF-1	1 11/16	1/8	1	—	—	—	1 1/2	0	7/8	1.7
38	P388M20-1610	1610	3.810	3.756	4.16	KF-1	1 11/16	1/8	1	—	—	—	1 1/2	0	7/8	2.0
40	P408M20-1610	1610	4.010	3.956	4.34	KF-1	1 11/16	1/8	1	—	—	—	1 1/2	0	7/8	2.4
44	P448M20-2012	2012	4.411	4.357	4.75	CF-1	2 1/2	—	1 1/4	1/8	—	3 7/32	1 1/2	0	7/8	2.6
48	P488M20-2012	2012	4.812	4.758	5.16	CF-1	2 1/2	—	1 1/4	1/8	—	3 3/8	1 1/2	0	7/8	3.4
56	P568M20-2012	2012	5.614	5.560	5.94	CF-1	2 1/2	—	1 1/4	1/8	—	3 3/8	1 1/2	0	7/8	5.3
64	P648M20-2012	2012	6.416	6.362	6.75	CF-1	2 1/2	—	1 1/4	1/8	—	4 1/8	1 1/2	0	7/8	7.5
72	P728M20-2012	2012	7.218	7.164	7.56	CF-1	2 1/2	—	1 1/4	1/8	—	4 1/8	1 1/2	0	7/8	9.9
80	P808M20-2517	2517	8.020	7.966	8.38	CF-2	2 11/16	—	1 1/4	3/8	—	4 1/8	1 1/2	6.900	7/8	11.9
90	P908M20-2517	2517	9.023	8.969	—	C-2	2 11/16	—	1 1/4	3/8	—	—	1 1/2	7.630	—	12.9

* Weight Shown is for Sprocket Less Bushing.
● Reverse Mount Only

+ The numbers (1=Solid, 2=Web, 3=Arms) within the "Type" indicates construction, and the letter F indicates the sprocket has flanges.

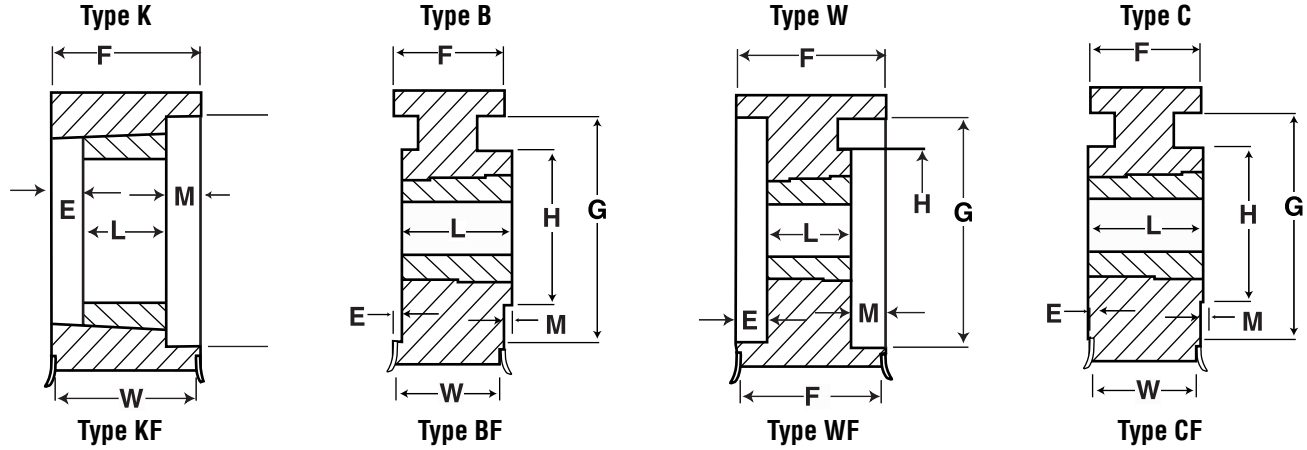

MPB 30mm (1.18in.) Wide Belts (8M-30)																
No. of Teeth	Catalog Number	Bore	Pitch	Diameter (in.)		Type +	Max. Bore	Dimensions (in.)							Weight* Approx. (lbs)	
				O.D.	Flange			E	L	M	K	H	F	G		W
20	P208M30-MPB	½	2.005	1.951	2.375	D1F	¾	¾	2½	0	—	1½	1½	—	1½	1.10
30	P218M30-MPB	½	2.105	2.051	2.468	D1F	1	¾	2½	0	—	1½	1½	—	1½	1.30
22	P228M30-MPB	½	2.206	2.152	2.562	D1F	1⅙	¾	2½	0	—	1½	1½	—	1½	1.40
24	P248M30-MPB	½	2.406	2.352	2.750	D1F	1¼	¾	2½	0	—	1⅝	1½	—	1½	1.80
26	P268M30-MPB	½	2.607	2.553	2.937	D1F	1¼	¾	2½	0	—	2	1½	—	1½	2.20
QD 30mm (1.18in.) Wide Belts (8M-30)																
28	P288M30-H	H	2.807	2.753	3.156	●E1F	1¼	¾	1¼	¾	—	—	1½	1.57	1¼	1.70
30	P308M30-H	H	3.008	2.954	3.344	●E1F	1½	¾	1¼	¾	—	—	1½	1.57	1¼	1.90
32	P328M30-H	H	3.208	3.154	3.562	B1F	1½	¾	1¼	0	¾	—	1½	2.56	1¼	2.10
34	P348M30-SH	SH	3.409	3.355	3.750	A1F	1⅝	¾	1¼	⅙	1⅙	—	1½	2.75	1¼	2.40
36	P368M30-SH	SH	3.609	3.555	3.937	A1F	1⅞	¾	1¼	⅙	1⅙	—	1½	2.82	1¼	2.80
38	P388M30-SH	SH	3.810	3.756	4.156	A1F	1⅞	¾	1¼	⅙	1⅙	—	1½	3.00	1¼	3.20
40	P408M30-SH	SH	4.010	3.956	4.344	A1F	1⅞	¾	1¼	⅙	1⅙	—	1½	3.00	1¼	3.60
44	P448M30-SDS	SDS	4.411	4.357	4.750	B1F	1⅞	¾	1¼	0	¾	—	1½	3.50	1¼	3.80
48	P488M30-SDS	SDS	4.812	4.758	5.157	B1F	2	¾	1¼	0	¾	—	1½	3.80	1¼	4.20
56	P568M30-SDS	SDS	5.614	5.560	5.937	B1F	2	¾	1¼	0	¾	—	1½	4.60	1¼	4.80
64	P648M30-SK	SK	6.416	6.362	6.750	C1F	2	¾	1¼	0	¾	—	1½	5.40	1¼	6.10
72	P728M30-SK	SK	7.218	7.164	7.562	C1F	2½	¾	1¼	0	¾	—	1½	6.20	1¼	6.80
80	P808M30-SK	SK	8.020	7.966	8.375	C2F	2½	¾	1¼	0	¾	—	1½	6.90	1¼	7.50
90	P908M30-SK	SK	9.023	8.969	—	C2	2½	¾	1¼	0	¾	—	1½	7.62	—	11.00
112	P1128M30-SK	SK	11.229	11.175	—	C3	2½	¾	1¼	0	¾	—	1½	9.87	—	13.00
144	P1448M30-SF	SF	14.447	14.383	—	C3	2⅞	¾	2⅞	0	¾	—	1½	12.88	—	25.50
192	P1928M30-E	E	19.249	19.195	—	C3	—	1⅞	2½	⅙	⅙	—	1½	17.63	—	30.00
Taper Bushed 30mm (1.18in.) Wide Belts (8M-30)																
24	P248M30-1108	1108	2.406	2.352	2.75	KF-1	1	½	¾	½	—	—	1½	1.783	1¼	.9
26	P268M30-1108	1108	2.607	2.553	2.94	KF-1	1	½	¾	½	—	—	1½	1.971	1¼	1.2
28	P288M30-1108	1108	2.807	2.753	3.16	KF-1	1	½	¾	½	—	—	1½	2.000	1¼	1.6
30	P308M30-1210	1210	3.008	2.954	3.34	KF-1	1¼	½	1	¾	—	—	1½	2.345	1¼	1.5
32	P328M30-1210	1210	3.208	3.154	3.56	KF-1	1¼	½	1	¾	—	—	1½	2.560	1¼	1.9
34	P348M30-1610	1610	3.409	3.355	3.75	KF-1	1⅞	½	1	¾	—	—	1½	2.750	1¼	2.3
36	P368M30-1610	1610	3.609	3.555	3.94	KF-1	1⅞	½	1	¾	—	—	1½	2.820	1¼	2.2
38	P388M30-1610	1610	3.810	3.756	4.16	KF-1	1⅞	½	1	¾	—	—	1½	3.000	1¼	2.7
40	P408M30-2012	2012	4.010	3.956	4.34	KF-1	2½	—	1¼	—	—	—	1½	3.250	1¼	2.4
44	P448M30-2012	2012	4.411	4.357	4.75	KF-1	2½	—	1¼	—	¼	—	1½	3.500	1¼	3.4
48	P488M30-2012	2012	4.812	4.758	5.16	KF-1	2½	—	1¼	—	¼	—	1½	3.800	1¼	4.5
56	P568M30-2012	2012	5.614	5.560	5.94	KF-1	2½	—	1¼	—	¼	—	1½	4.600	1¼	7.0
64	P648M30-2517	2517	6.416	6.362	6.75	CF-1	2⅞	—	1¼	—	¼	4½	1½	0	1¼	8.9
72	P728M30-2517	2517	7.218	7.164	7.56	CF-1	2⅞	—	1¼	—	¼	4½	1½	0	1¼	12.1
80	P808M30-2517	2517	8.020	7.966	8.38	CF-2	2⅞	—	1¼	—	¼	4½	1½	0	1¼	15.8
90	P908M30-2517	2517	9.023	8.969	—	C-2	2⅞	½	1¼	—	¼	4½	1½	7.630	—	13.8
112	P1128M30-2517	2517	11.229	11.175	—	C-3	2⅞	½	1¼	—	¼	4½	1½	9.880	—	23.5

* Weight Shown is for Sprocket Less Bushing.
● Reverse Mount Only

+ The numbers (1=Solid, 2=Web, 3=Arms) within the "Type" indicates construction, and the letter F indicates the sprocket has flanges.

High Torque Sprockets 8mm

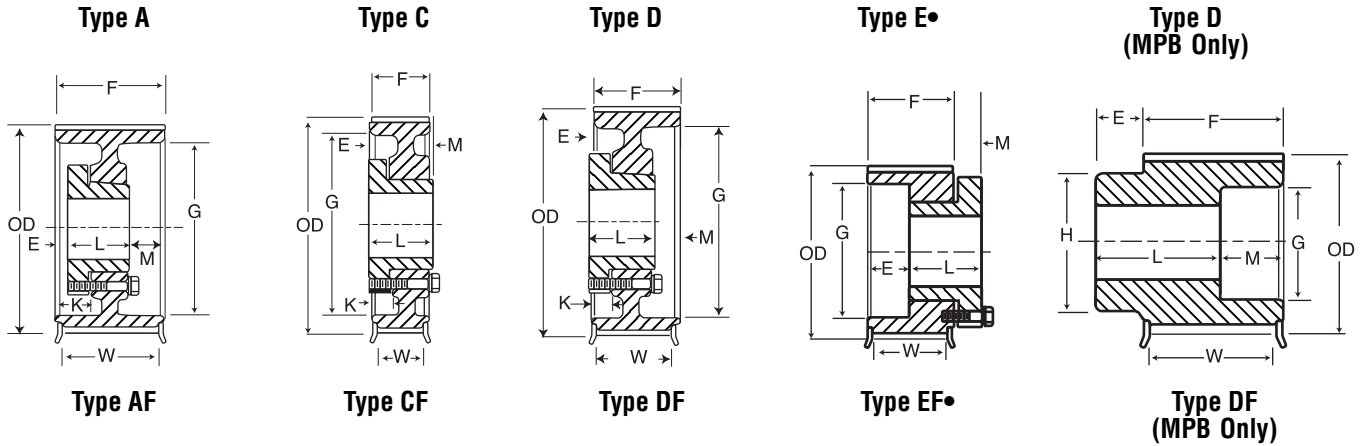

MPB 50mm (1.97 in.) Wide Belts (8M-50)																
No. of Teeth	Catalog Number	Bore	Pitch	Diameter (in.)		Type +	Max. Bore	Dimensions (in.)							Weight* Approx. (lbs)	
				O.D.	Flange			E	L	M	K	H	F	G		W
28	P288M50-MPB	1/2	2.807	2.753	3.156	D1F	1 1/4	3/4	3 3/8	0	—	2 1/2	2 1/2	—	2 1/2	4.2
30	P308M50-MPB	1/2	3.008	2.954	3.344	D1F	1 1/4	3/4	3 3/8	0	—	2 15/32	2 1/2	—	2 1/2	4.9
32	P328M50-MPB	1/2	3.208	3.154	3.562	D1F	1 1/4	3/4	3 3/8	0	—	2 19/32	2 1/2	—	2 1/2	5.4
QD 50mm (1.97 in.) Wide Belts (8M-50)																
32	P328M50-H	H	3.208	3.154	3.562	A1F	1 1/4	1/2	1 1/4	3/8	3/4	—	2 1/2	2.56	2 1/2	2.9
34	P348M50-SH	SH	3.409	3.355	3.750	A1F	1 1/4	0	1 1/4	1 1/8	1/2	—	2 1/2	2.75	2 1/2	3.2
36	P368M50-SH	SH	3.609	3.555	3.937	A1F	1 1/4	0	1 1/4	1 1/8	1/2	—	2 1/2	2.82	2 1/2	3.8
38	P388M50-SH	SH	3.810	3.756	4.156	A1F	1 1/4	0	1 1/4	1 1/8	1/2	—	2 1/2	3.00	2 1/2	4.2
40	P408M50-SH	SH	4.010	3.956	4.344	A1F	1 1/4	0	1 1/4	1 1/8	1/2	—	2 1/2	3.00	2 1/2	4.6
44	P448M50-SD	SD	4.411	4.357	4.750	A1F	2	0	1 1/8	3/8	3/8	—	2 1/2	3.50	2 1/2	5.2
48	P488M50-SD	SD	4.812	4.758	5.157	A1F	2	0	1 1/8	3/8	3/8	—	2 1/2	3.80	2 1/2	6.0
56	P568M50-SK	SK	5.614	5.560	5.937	D1F	2 1/2	1/8	1 1/8	3/8	3/8	—	2 1/2	4.60	2 1/2	7.6
64	P648M50-SK	SK	6.416	6.362	6.750	D1F	2 1/2	1/8	1 1/8	3/8	3/8	—	2 1/2	5.40	2 1/2	10.3
72	P728M50-SK	SK	7.218	7.164	7.562	D1F	2 1/2	1/8	1 1/8	3/8	3/8	—	2 1/2	6.20	2 1/2	13.3
80	P808M50-SF	SF	8.020	7.966	8.326	D1F	2 1/2	1/8	2	3/8	3/8	—	2 1/2	6.90	2 1/2	12.7
90	P908M50-SF	SF	9.023	8.969	—	D2	2 1/2	1/8	2	3/8	3/8	—	2 1/2	7.62	2 1/2	16.0
112	P1128M50-SF	SF	11.229	11.175	—	D3	2 1/2	1/8	2	3/8	3/8	—	2 1/2	9.88	2 1/2	21.0
144	P1448M50-E	E	14.437	14.383	—	D3	3 1/2	1/2	2 1/2	2	3/8	—	2 1/2	12.88	2 1/2	35.0
192	P1928M50-E	E	19.249	19.195	—	D3	3 1/2	1/2	2 1/2	2	3/8	—	2 1/2	17.63	2 1/2	45.0
Taper Bushed 50mm (1.97 in.) Wide Belts (8M-50)																
28	P288M50-1108	1108	2.807	2.753	3.16	KF-1	1	—	7/8	1 1/2	—	—	2 1/2	2.000	2 1/2	2.1
30	P308M50-1210	1210	3.008	2.954	3.34	KF-1	1 1/4	—	1	1 1/8	—	—	2 1/2	2.345	2 1/2	2.2
32	P328M50-1210	1210	3.208	3.154	3.56	KF-1	1 1/4	—	1	1 1/8	—	—	2 1/2	2.560	2 1/2	2.1
34	P348M50-1610	1610	3.409	3.355	3.75	KF-1	1 1/4	—	1	1 1/8	—	—	2 1/2	2.750	2 1/2	2.1
36	P368M50-1610	1610	3.609	3.555	3.94	KF-1	1 1/4	—	1	1 1/8	—	—	2 1/2	2.820	2 1/2	2.7
38	P388M50-1610	1610	3.810	3.756	4.16	KF-1	1 1/4	—	1	1 1/8	—	—	2 1/2	3.000	2 1/2	3.1
40	P408M50-2012	2012	4.010	3.956	4.34	KF-1	2	—	1 1/4	1 1/8	—	—	2 1/2	3.250	2 1/2	3.4
44	P448M50-2012	2012	4.411	4.357	4.75	KF-1	2 1/2	—	1 1/4	1 1/8	—	—	2 1/2	3.500	2 1/2	4.3
48	P488M50-2012	2012	4.812	4.758	5.16	KF-1	2 1/2	—	1 1/4	1 1/8	—	—	2 1/2	3.800	2 1/2	5.5
56	P568M50-2517	2517	5.614	5.560	5.94	KF-1	2 1/2	—	1 1/4	3/8	—	—	2 1/2	4.600	2 1/2	8.1
64	P648M50-2517	2517	6.416	6.362	6.75	KF-1	2 1/2	—	1 1/4	3/8	—	—	2 1/2	5.400	2 1/2	11.7
72	P728M50-2517	2517	7.218	7.164	7.56	KF-1	2 1/2	—	1 1/4	3/8	—	—	2 1/2	6.200	2 1/2	15.7
80	P808M50-2517	2517	8.020	7.966	8.38	KF-1	2 1/2	—	1 1/4	3/8	—	—	2 1/2	6.900	2 1/2	20.3
90	P908M50-3020	3020	9.023	8.969	—	W-1	3 1/4	—	2	3/8	—	—	2 1/2	7.630	2 1/2	31.7
112	P1128M50-3020	3020	11.229	11.175	—	W-3	3 1/4	—	2	3/8	—	6 1/4	2 1/2	9.880	2 1/2	34.7
144	P1448M50-3020	3020	14.437	14.383	—	W-3	3 1/4	—	2	3/8	—	7 1/2	2 1/2	12.880	2 1/2	36.0
192	P1928M50-3020	3020	19.249	19.195	—	W-3	3 1/4	—	2	3/8	—	7 1/2	2 1/2	17.630	2 1/2	67.2

* Weight Shown is for Sprocket Less Bushing.
 ● Reverse Mount Only

+ The numbers (1=Solid, 2=Web, 3=Arms) within the "Type" indicates construction, and the letter F indicates the sprocket has flanges.

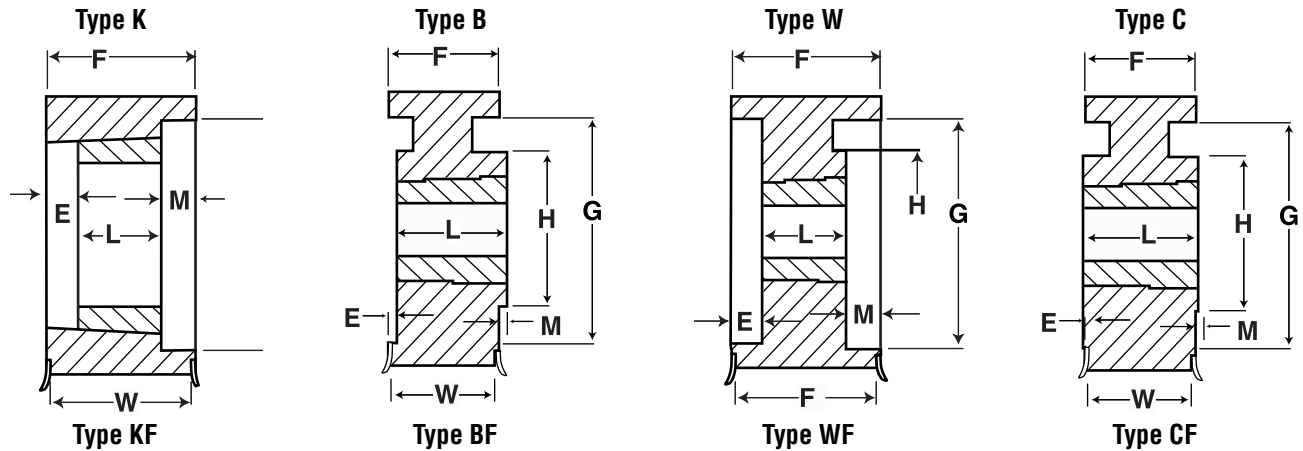

MPB 85mm (3.35 in.) Wide Belts (8M-85)																
No. of Teeth	Catalog Number	Bore	Pitch	Diameter (in.)		Type +	Max. Bore	Dimensions (in.)								Weight Approx. (lbs)
				O.D.	Flange			E	L	M	K	H	F	G	W	
34	P348M85-MPB	3/4	3.409	3.355	3.750	D1F	1 1/16	3/4	4 1/2	0	—	2 5/16	3 3/4	—	3 1/2	10.00
36	P368M85-MPB	3/4	3.609	3.555	3.937	D1F	1 1/4	3/4	4 1/2	0	—	3	3 3/4	—	3 1/2	11.30
38	P388M85-MPB	3/4	3.810	3.756	4.156	D1F	1 5/16	3/4	4 1/2	0	—	3 3/16	3 3/4	—	3 1/2	12.60
40	P408M85-MPB	3/4	4.010	3.956	4.344	D1F	2 1/8	3/4	4 1/2	0	—	3 13/32	3 3/4	—	3 1/2	14.90
44	P448M85-MPB	3/4	4.411	4.357	4.750	D1F	2 1/4	3/4	4 1/2	0	—	3 5/16	3 3/4	—	3 1/2	17.20
48	P488M85-MPB	3/4	4.812	4.758	5.157	D1F	2 1/2	3/4	4 1/2	0	—	4 3/16	3 3/4	—	3 1/2	20.60
56	P568M85-MPB	7/8	5.614	5.560	5.937	D1F	3	3/4	4 1/2	0	—	5	3 3/4	—	3 1/2	28.00
QD 85mm (3.35 in.) Wide Belts (8M-85)																
34	P348M85-SH	SH	3.409	3.355	3.819	A1F	1 1/16	1	1 1/4	1 1/2	1 1/2	—	3 3/4	2.75	3 1/2	4.6
36	P368M85-SH	SH	3.609	3.555	3.937	A1F	1 1/16	1	1 1/4	1 1/2	1 1/2	—	3 3/4	2.82	3 1/2	5.2
38	P388M85-SH	SH	3.810	3.756	4.134	A1F	1 1/16	1	1 1/4	1 1/2	1 1/2	—	3 3/4	3.00	3 1/2	5.8
40	P408M85-SD	SD	4.010	3.956	4.344	A1F	2	1 1/16	1 1/4	1 1/2	1 1/4	—	3 3/4	3.25	3 1/2	5.6
44	P448M85-SD	SD	4.411	4.357	4.750	A1F	2	1 1/16	1 1/4	1 1/2	1 1/4	—	3 3/4	3.50	3 1/2	6.2
48	P488M85-SD	SD	4.812	4.758	5.157	A1F	2	1 1/16	1 1/4	1 1/2	1 1/4	—	3 3/4	3.80	3 1/2	7.8
56	P568M85-SK	SK	5.614	5.560	5.937	A1F	2 3/8	3/4	1 1/4	1 1/2	1 1/4	—	3 3/4	4.60	3 1/2	9.8
64	P648M85-SF	SF	6.416	6.362	6.750	A1F	2 3/8	3/4	1 1/4	1 1/2	1 1/4	—	3 3/4	5.40	3 1/2	13.0
72	P728M85-E	E	7.218	7.164	7.562	A1F	2 5/16	3/4	2	1 1/2	1 1/4	—	3 3/4	6.20	3 1/2	16.0
80	P808M85-E	E	8.020	7.966	8.375	A1F	2 5/16	3/4	2	1 1/2	1 1/4	—	3 3/4	6.90	3 1/2	17.0
90	P908M85-E	E	9.023	8.969	—	A2	2 5/16	3/4	2	1 1/2	1 1/4	—	3 3/4	7.62	—	20.0
112	P1128M85-F	F	11.229	11.175	—	A3	2 5/16	3/4	2	1 1/2	1 1/4	—	3 3/4	9.88	—	28.0
144	P1448M85-F	F	14.447	14.383	—	A3	4	3/4	3 3/4	1 1/2	1 1/4	—	3 3/4	12.88	3 1/2	79.00
192	P1928M85-F	F	19.249	19.195	—	A3	4	3/4	3 3/4	1 1/2	1 1/4	—	3 3/4	17.65	3 1/2	101.42
Taper Bushed 85mm (3.35 in.) Wide Belts (8M-85)																
34	P348M85-1615	1615	3.409	3.355	3.75	WF-1	1 1/16	3/4	1 1/2	1 1/2	—	—	3 3/4	2.750	3 1/2	3.3
36	P368M85-1615	1615	3.609	3.555	3.94	WF-1	1 1/16	3/4	1 1/2	1 1/2	—	—	3 3/4	2.820	3 1/2	4.2
38	P388M85-1615	1615	3.810	3.756	4.16	WF-1	1 1/16	3/4	1 1/2	1 1/2	—	—	3 3/4	3.000	3 1/2	4.7
40	P408M85-2012	2012	4.010	3.956	4.34	WF-1	2 1/8	1 1/4	1 1/4	1 1/4	—	—	3 3/4	3.250	3 1/2	4.7
44	P448M85-2012	2012	4.411	4.357	4.75	WF-1	2 1/4	1 1/4	1 1/4	1 1/4	—	—	3 3/4	3.500	3 1/2	6.4
48	P488M85-2012	2012	4.812	4.758	5.16	WF-1	2 1/2	1 1/4	1 1/4	1 1/4	—	—	3 3/4	3.800	3 1/2	8.0
56	P568M85-2517	2517	5.614	5.560	5.94	WF-1	2 1/16	1	1 1/4	1	—	—	3 3/4	4.500	3 1/2	11.0
64	P648M85-2517	2517	6.416	6.362	6.75	WF-1	2 1/16	1	1 1/4	1	—	—	3 3/4	5.400	3 1/2	15.0
72	P728M85-3020	3020	7.218	7.164	7.56	WF-1	3 1/4	7/8	2	7/8	—	—	3 3/4	6.200	3 1/2	18.2
80	P808M85-3020	3020	8.020	7.966	8.38	WF-1	3 1/4	7/8	2	7/8	—	—	3 3/4	6.900	3 1/2	24.2
90	P908M85-3020	3020	9.023	8.969	—	W-1	3 3/4	7/8	2	7/8	—	—	3 3/4	7.630	—	31.9
112	P1128M85-3020	3020	11.229	11.175	—	W-3	3 3/4	7/8	2	7/8	—	6 1/4	3 3/4	9.880	—	34.6
144	P1448M85-3535	3535	14.437	14.383	—	W-3	3 5/16	7/8	3 1/2	1 1/2	—	7	3 3/4	12.880	—	49.6
192	P1928M85-3535	3535	19.249	19.195	—	W-3	3 5/16	7/8	3 1/2	1 1/2	—	7	3 3/4	17.630	—	81.4

* Weight Shown is for Sprocket Less Bushing.
 • Reverse Mount Only

+ The numbers (1=Solid, 2=Web, 3=Arms), within the "Type" indicates construction and the letter F indicates the sprocket has flanges.

High Torque Sprockets 14mm

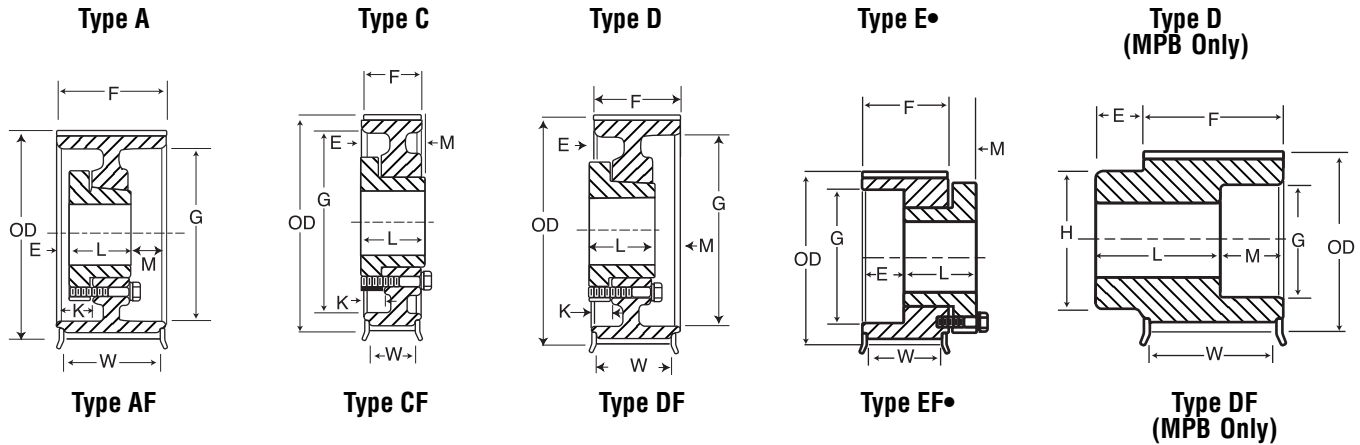

QD 40mm (1.570 in.) Wide Belts (140M-40)																	
No. of Teeth	Catalog Number	Bore	P.D.	Diameter (in.)			Type +	Max. Bore	Dimensions (in.)								Weight Approx. (lbs)
				O.D.	Flange	E			L	M	K	H	F	G	W		
28	P2814M40-SK	SK	4.912	4.802	5.56	●E1F	2 $\frac{1}{2}$	$\frac{7}{8}$	1 $\frac{1}{2}$	$\frac{5}{8}$	—	—	2 $\frac{1}{2}$	3.13	1 $\frac{13}{16}$	5.5	
29	P2914M40-SK	SK	5.088	4.978	5.56	●E1F	2 $\frac{1}{2}$	$\frac{7}{8}$	1 $\frac{1}{2}$	$\frac{5}{8}$	—	—	2 $\frac{1}{2}$	3.13	1 $\frac{13}{16}$	6.5	
30	P3014M40-SK	SK	5.263	5.153	6.13	D1F	2 $\frac{1}{2}$	$\frac{3}{4}$	1 $\frac{1}{2}$	$\frac{7}{16}$	—	—	2 $\frac{1}{2}$	3.92	1 $\frac{13}{16}$	6.0	
32	P3214M40-SK	SK	5.614	5.504	6.13	D1F	2 $\frac{1}{2}$	$\frac{3}{4}$	1 $\frac{1}{2}$	$\frac{7}{16}$	$\frac{7}{16}$	—	2 $\frac{1}{2}$	3.92	1 $\frac{13}{16}$	8.0	
34	P3414M40-SK	SK	5.965	5.855	6.50	D1F	2 $\frac{1}{2}$	$\frac{3}{4}$	1 $\frac{1}{2}$	$\frac{7}{16}$	$\frac{7}{16}$	—	2 $\frac{1}{2}$	4.06	1 $\frac{13}{16}$	8.5	
36	P3614M40-SF	SF	6.316	6.206	6.81	D1F	2 $\frac{1}{2}$	$\frac{3}{4}$	2	$\frac{5}{16}$	$\frac{7}{16}$	—	2 $\frac{1}{2}$	4.69	1 $\frac{13}{16}$	9.5	
38	P3814M40-SF	SF	6.667	6.557	7.16	D1F	2 $\frac{1}{2}$	$\frac{3}{4}$	2	$\frac{5}{16}$	$\frac{7}{16}$	—	2 $\frac{1}{2}$	4.94	1 $\frac{13}{16}$	11.5	
40	P4014M40-SF	SF	7.018	6.909	7.50	D1F	2 $\frac{1}{2}$	$\frac{3}{4}$	2	$\frac{5}{16}$	$\frac{7}{16}$	—	2 $\frac{1}{2}$	5.06	1 $\frac{13}{16}$	13.0	
44	P4414M40-E	E	7.720	7.610	8.22	D1F	3 $\frac{1}{2}$	$\frac{3}{4}$	2 $\frac{1}{2}$	$\frac{1}{2}$	$\frac{1}{4}$	—	2 $\frac{1}{2}$	6.12	1 $\frac{13}{16}$	16.5	
48	P4814M40-E	E	8.421	8.311	8.94	D1F	3 $\frac{1}{2}$	$\frac{3}{4}$	2 $\frac{1}{2}$	$\frac{1}{2}$	$\frac{1}{4}$	—	2 $\frac{1}{2}$	6.50	1 $\frac{13}{16}$	20.0	
52	P5214M40-E	E	9.123	9.013	9.69	D1F	3 $\frac{1}{2}$	$\frac{3}{4}$	2 $\frac{1}{2}$	$\frac{1}{2}$	$\frac{1}{4}$	—	2 $\frac{1}{2}$	7.18	1 $\frac{13}{16}$	24.0	
56	P5614M40-E	E	9.825	9.715	10.38	D1F	3 $\frac{1}{2}$	$\frac{3}{4}$	2 $\frac{1}{2}$	$\frac{1}{2}$	$\frac{1}{4}$	—	2 $\frac{1}{2}$	7.88	1 $\frac{13}{16}$	28.0	
60	P6014M40-E	E	10.527	10.417	11.06	D1F	3 $\frac{1}{2}$	$\frac{3}{4}$	2 $\frac{1}{2}$	$\frac{1}{2}$	$\frac{1}{4}$	—	2 $\frac{1}{2}$	8.50	1 $\frac{13}{16}$	32.0	
64	P6414M40-E	E	11.229	11.119	11.75	D2F	3 $\frac{1}{2}$	$\frac{3}{4}$	2 $\frac{1}{2}$	$\frac{1}{2}$	$\frac{1}{4}$	—	2 $\frac{1}{2}$	9.25	1 $\frac{13}{16}$	29.0	
68	P6814M40-E	E	11.930	11.820	12.50	D2F	3 $\frac{1}{2}$	$\frac{3}{4}$	2 $\frac{1}{2}$	$\frac{1}{2}$	$\frac{1}{4}$	—	2 $\frac{1}{2}$	10.00	1 $\frac{13}{16}$	31.0	
72	P7214M40-E	E	12.632	12.522	13.19	D2F	3 $\frac{1}{2}$	$\frac{3}{4}$	2 $\frac{1}{2}$	$\frac{1}{2}$	$\frac{1}{4}$	—	2 $\frac{1}{2}$	10.69	1 $\frac{13}{16}$	33.0	
80	P8014M40-E	E	14.036	13.926	14.63	D2F	3 $\frac{1}{2}$	$\frac{3}{4}$	2 $\frac{1}{2}$	$\frac{1}{2}$	$\frac{1}{4}$	—	2 $\frac{1}{2}$	12.13	1 $\frac{13}{16}$	38.0	
90	P9014M40-E	E	15.790	15.680	—	D3	3 $\frac{1}{2}$	$\frac{3}{4}$	2 $\frac{1}{2}$	$\frac{1}{2}$	$\frac{1}{4}$	—	2 $\frac{1}{2}$	14.00	—	39.0	
112	P11214M40-E	E	19.650	19.540	—	D3	3 $\frac{1}{2}$	$\frac{3}{4}$	2 $\frac{1}{2}$	$\frac{1}{2}$	$\frac{1}{4}$	—	2 $\frac{1}{2}$	17.80	—	51.0	
144	P14414M40-E	E	25.264	25.154	—	D3	3 $\frac{1}{2}$	$\frac{3}{4}$	2 $\frac{1}{2}$	$\frac{1}{2}$	$\frac{1}{4}$	—	2 $\frac{1}{2}$	23.38	—	80.0	
Taper Bushed 40mm (1.570 in.) Wide Belts (140M-40)																	
28	P2814M40-2012	2012	4.912	4.802	5.56	KF-1	2 $\frac{1}{2}$	—	1 $\frac{1}{4}$	$\frac{7}{8}$	—	—	2 $\frac{1}{2}$	3.375	1 $\frac{13}{16}$	3.5	
29	P2914M40-2012	2012	5.088	4.978	5.56	KF-1	2 $\frac{1}{2}$	—	1 $\frac{1}{4}$	$\frac{7}{8}$	—	—	2 $\frac{1}{2}$	3.375	1 $\frac{13}{16}$	3.9	
30	P3014M40-2012	2012	5.263	5.153	6.13	KF-1	2 $\frac{1}{2}$	—	1 $\frac{1}{4}$	$\frac{7}{8}$	—	—	2 $\frac{1}{2}$	3.928	1 $\frac{13}{16}$	6.4	
32	P3214M40-2012	2012	5.614	5.504	6.13	KF-1	2 $\frac{1}{2}$	—	1 $\frac{1}{4}$	$\frac{7}{8}$	—	—	2 $\frac{1}{2}$	3.928	1 $\frac{13}{16}$	8.0	
34	P3414M40-2012	2012	5.965	5.855	6.50	KF-1	2 $\frac{1}{2}$	—	1 $\frac{1}{4}$	$\frac{7}{8}$	—	—	2 $\frac{1}{2}$	4.063	1 $\frac{13}{16}$	9.4	
36	P3614M40-2517	2517	6.316	6.206	6.81	KF-1	2 $\frac{11}{16}$	—	1 $\frac{1}{4}$	$\frac{3}{8}$	—	—	2 $\frac{1}{2}$	4.688	1 $\frac{13}{16}$	10.5	
38	P3814M40-2517	2517	6.667	6.557	7.16	KF-1	2 $\frac{11}{16}$	—	1 $\frac{1}{4}$	$\frac{3}{8}$	—	—	2 $\frac{1}{2}$	4.813	1 $\frac{13}{16}$	12.2	
40	P4014M40-2517	2517	7.018	6.908	7.50	KF-1	2 $\frac{11}{16}$	—	1 $\frac{1}{4}$	$\frac{3}{8}$	—	—	2 $\frac{1}{2}$	5.188	1 $\frac{13}{16}$	14.2	
44	P4414M40-2517	2517	7.720	7.610	8.22	KF-1	2 $\frac{11}{16}$	—	1 $\frac{1}{4}$	$\frac{3}{8}$	—	—	2 $\frac{1}{2}$	6.125	1 $\frac{13}{16}$	17.6	
48	P4814M40-2517	2517	8.421	8.311	8.94	KF-1	2 $\frac{11}{16}$	—	1 $\frac{1}{4}$	$\frac{3}{8}$	—	—	2 $\frac{1}{2}$	6.500	1 $\frac{13}{16}$	22.0	
52	P5214M40-2517	2517	9.123	9.013	9.69	KF-1	2 $\frac{11}{16}$	—	1 $\frac{1}{4}$	$\frac{3}{8}$	—	—	2 $\frac{1}{2}$	7.188	1 $\frac{13}{16}$	26.5	
56	P5614M40-2517	2517	9.825	9.715	10.38	WF-2	2 $\frac{11}{16}$	—	1 $\frac{1}{4}$	$\frac{3}{8}$	4 $\frac{1}{2}$	—	2 $\frac{1}{2}$	7.875	1 $\frac{13}{16}$	21.5	
60	P6014M40-3020	3020	10.527	10.417	11.06	WF-2	3 $\frac{1}{4}$	—	2	$\frac{1}{8}$	6 $\frac{1}{4}$	—	2 $\frac{1}{2}$	8.500	1 $\frac{13}{16}$	33.7	
64	P6414M40-3020	3020	11.229	11.119	11.75	WF-2	3 $\frac{1}{4}$	—	2	$\frac{1}{8}$	6 $\frac{1}{4}$	—	2 $\frac{1}{2}$	9.250	1 $\frac{13}{16}$	36.5	
68	P6814M40-3020	3020	11.930	11.820	12.50	WF-2	3 $\frac{1}{4}$	—	2	$\frac{1}{8}$	6 $\frac{1}{4}$	—	2 $\frac{1}{2}$	10.000	1 $\frac{13}{16}$	39.3	
72	P7214M40-3020	3020	12.632	12.522	13.19	WF-2	3 $\frac{1}{4}$	—	2	$\frac{1}{8}$	6 $\frac{1}{4}$	—	2 $\frac{1}{2}$	10.688	1 $\frac{13}{16}$	42.6	
80	P8014M40-3020	3020	14.036	13.926	14.63	WF-3	3 $\frac{1}{4}$	—	2	$\frac{1}{8}$	6 $\frac{1}{4}$	—	2 $\frac{1}{2}$	12.125	1 $\frac{13}{16}$	38.8	
90	P9014M40-3020	3020	15.790	15.680	—	W-3	3 $\frac{1}{4}$	—	2	$\frac{1}{8}$	6 $\frac{1}{4}$	—	2 $\frac{1}{2}$	13.563	—	44.5	
112	P11214M40-3020	3020	19.650	19.540	—	W-3	3 $\frac{1}{4}$	—	2	$\frac{1}{8}$	6 $\frac{1}{4}$	—	2 $\frac{1}{2}$	17.375	—	64.9	
144	P14414M40-3020	3020	25.264	25.154	—	W-3	3 $\frac{1}{4}$	—	2	$\frac{1}{8}$	6 $\frac{1}{4}$	—	2 $\frac{1}{2}$	23.000	—	97.4	

* Weight Shown is for Sprocket Less Bushing.

• Reverse Mount Only

+ The numbers (1=Solid, 2=Web, 3=Arms), within the "Type" indicates construction and the letter F indicates the sprocket has flanges.

PULLEYS

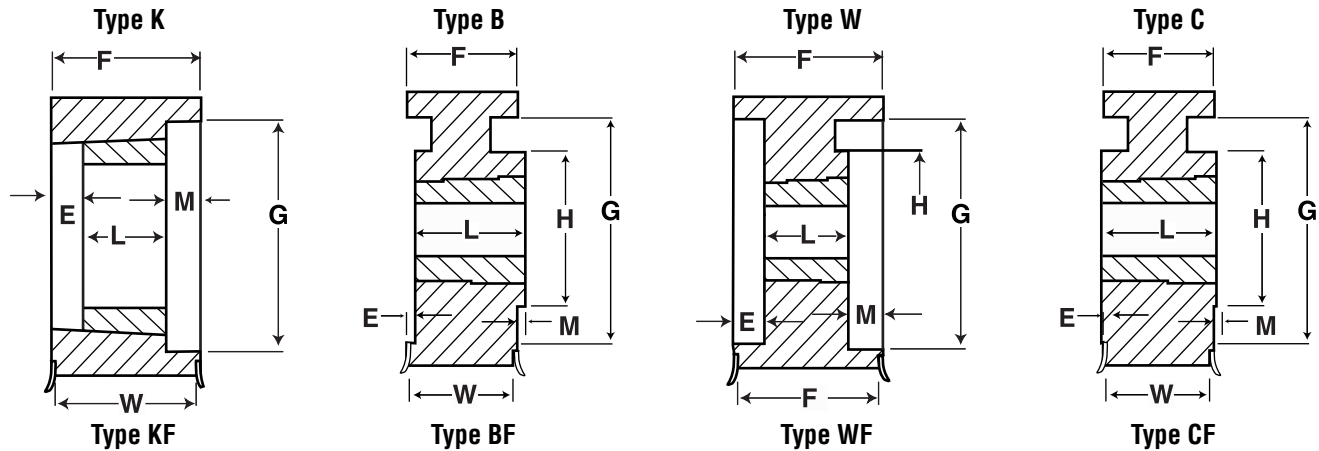

QD 55mm (2.17 in.) Wide Belts (14M-55)																
No. of Teeth	Catalog Number	Bore	P.D.	Diameter (in.)		Type +	Max. Bore	Dimensions (in.)								Weight* Approx. (lbs)
				O.D.	Flange			E	L	M	K	H	F	G	W	
28	P2814M55-SK	SK	4.912	4.808	5.56	●E1F	2%	1½	1%	¾	—	—	2%	3.13	2⅞	7.0
29	P2914M55-SK	SK	5.088	4.983	5.56	●E1F	2%	1½	1%	¾	—	—	2%	3.13	2⅞	8.0
30	P3014M55-SK	SK	5.263	5.157	6.13	A1F	2%	¾	1%	¾	¾	—	2%	3.92	2⅞	7.5
32	P3214M55-SK	SK	5.614	5.507	6.13	A1F	2%	¾	1%	¾	¾	—	2%	3.92	2⅞	9.0
34	P3414M55-SK	SK	5.965	5.858	6.50	A1F	2%	¾	1%	¾	¾	—	2%	4.06	2⅞	10.0
36	P3614M55-SF	SF	6.316	6.208	6.81	A1F	2%	¾	2	¾	¾	—	2%	4.69	2⅞	11.0
38	P3814M55-SF	SF	6.667	6.559	7.16	A1F	2%	¾	2	¾	¾	—	2%	4.94	2⅞	13.0
40	P4014M55-SF	SF	7.018	6.909	7.50	A1F	2%	¾	2	¾	¾	—	2%	5.06	2⅞	15.0
44	P4414M55-E	E	7.720	7.610	8.22	D1F	3½	⅝	2%	⅞	⅞	—	2%	6.12	2⅞	19.0
48	P4814M55-E	E	8.421	8.311	8.94	D1F	3½	⅝	2%	⅞	⅞	—	2%	6.50	2⅞	23.0
52	P5214M55-E	E	9.123	9.013	9.69	D1F	3½	⅝	2%	⅞	⅞	—	2%	7.18	2⅞	27.0
56	P5614M55-E	E	9.825	9.715	10.38	D1F	3½	⅝	2%	⅞	⅞	—	2%	7.88	2⅞	32.0
60	P6014M55-E	E	10.527	10.417	11.06	D1F	3½	⅝	2%	⅞	⅞	—	2%	8.50	2⅞	36.0
64	P6414M55-F	F	11.229	11.119	11.75	C1F	3½	⅞	3%	0	⅞	—	2%	9.25	2⅞	53.0
68	P6814M55-F	F	11.930	11.820	12.50	D2F	4	⅞	3%	0	⅞	—	2%	10.00	2⅞	43.0
72	P7214M55-F	F	12.632	12.522	13.19	C2F	4	⅞	3%	0	⅞	—	2%	10.69	2⅞	49.0
80	P8014M55-F	F	14.036	13.926	14.63	C2F	4	⅞	3%	0	⅞	—	2%	12.13	2⅞	54.0
90	P9014M55-F	F	15.790	15.680	—	C3	4	⅞	3%	0	⅞	—	2%	14.00	—	55.0
112	P11214M55-F	F	19.650	19.540	—	C3	4	⅞	3%	0	⅞	—	2%	17.88	—	71.0
144	P14414M55-F	F	25.264	25.154	—	C3	4	⅞	3%	0	⅞	—	2%	23.38	—	106.0
168	P16814M55-F	F	29.475	29.365	—	C3	4	⅞	3%	0	⅞	—	2%	27.56	—	124.0
192	P19214M55-F	F	33.686	33.576	—	C3	4	⅞	3%	0	⅞	—	2%	31.81	—	146.0
216	P21614M55-F	F	37.896	37.786	—	C3	4	⅞	3%	0	⅞	—	2%	35.75	—	205.0
Taper Bushed 55mm (2.17 in.) Wide Belts (14M-55)																
28	P2814M55-2012	2012	4.912	4.802	5.56	KF-1	2%	—	1¼	1½	—	—	2%	3.375	2⅞	7.4
29	P2914M55-2012	2012	5.088	4.978	5.56	KF-1	2%	—	1¼	1½	—	—	2%	3.375	2⅞	8.4
30	P3014M55-2517	2517	5.263	5.153	6.13	KF-1	2⅞	—	1¾	1	—	—	2%	3.928	2⅞	7.2
32	P3214M55-2517	2517	5.614	5.504	6.13	KF-1	2⅞	—	1¾	1	—	—	2%	3.928	2⅞	9.3
34	P3414M55-2517	2517	5.965	5.855	6.50	KF-1	2⅞	—	1¾	1	—	—	2%	4.063	2⅞	11.2
36	P3614M55-2517	2517	6.316	6.206	6.81	KF-1	2⅞	—	1¾	1	—	—	2%	4.688	2⅞	12.4
38	P3814M55-2517	2517	6.667	6.557	7.16	KF-1	2⅞	—	1¾	1	—	—	2%	4.813	2⅞	14.4
40	P4014M55-2517	2517	7.018	6.908	7.50	KF-1	2⅞	—	1¾	1	—	—	2%	5.188	2⅞	16.7
44	P4414M55-2517	2517	7.720	7.610	8.22	KF-1	2⅞	—	1¾	1	—	—	2%	6.125	2⅞	19.9
48	P4814M55-3020	3020	8.421	8.311	8.94	KF-1	3%	—	2	¾	—	—	2%	6.500	2⅞	29.2
52	P5214M55-3020	3020	9.123	9.013	9.69	KF-1	3%	—	2	¾	—	—	2%	7.188	2⅞	34.5
56	P5614M55-3020	3020	9.825	9.715	10.38	KF-1	3%	—	2	¾	—	—	2%	7.875	2⅞	40.1
60	P6014M55-3020	3020	10.527	10.417	11.06	WF-2	3%	—	2	¾	—	6¼	2%	8.500	2⅞	46.4
64	P6414M55-3020	3020	11.229	11.119	11.75	WF-2	3%	—	2	¾	—	6¼	2%	9.250	2⅞	52.7
68	P6814M55-3020	3020	11.930	11.820	12.50	WF-2	3%	—	2	¾	—	6¼	2%	10.000	2⅞	45.5
72	P7214M55-3020	3020	12.632	12.522	13.19	WF-2	3%	—	2	¾	—	6¼	2%	10.688	2⅞	49.5
80	P8014M55-3020	3020	14.036	13.926	14.63	WF-3	3%	—	2	¾	—	6¼	2%	12.125	2⅞	45.2
90	P9014M55-3020	3020	15.790	15.680	—	W-3	3%	—	2	¾	—	6¼	2%	13.563	—	46.1
112	P11214M55-3020	3020	19.650	19.540	—	W-3	3%	—	2	¾	—	6¼	2%	17.375	—	69.8
144	P14414M55-3020	3020	25.264	25.154	—	W-3	3%	—	2	¾	—	6¼	2%	23.000	—	104.4
192	P19214M55-3535	3535	33.686	33.576	—	C-3	3⅞	0.38	3½	¾	—	7	2%	31.375	—	104.2

* Weight Shown is for Sprocket Less Bushing.

• Reverse Mount Only

+ The numbers (1=Solid, 2=Web, 3=Arms), within the "Type" indicates construction and the letter F indicates the sprocket has flanges.

High Torque Sprockets 14mm

Martin

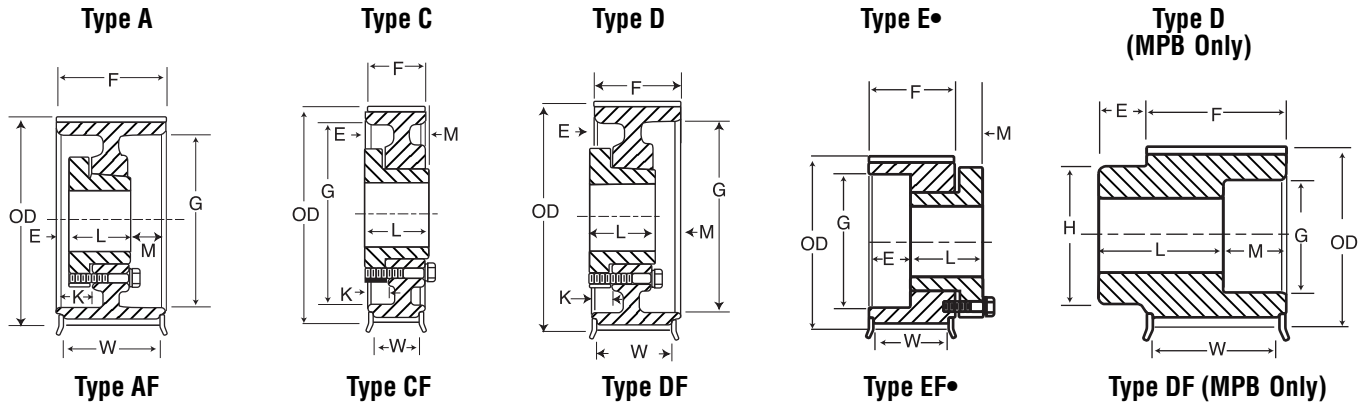

MPB 85mm (3.35in.) Wide Belts (14M-85)																
No. of Teeth	Catalog Number	Bore	P.D.	Diameter (in.)		Type +	Max. Bore	Dimensions (in.)							Weight* Approx. (lbs)	
				O.D.	Flange			E	L	M	K	H	F	G		W
28	P2814M85-MPB	1 1/4	4.912	4.802	5.56	D1F	2 1/16	1	4	1	—	3 1/16	4	3 1/8	3 1/16	18
29	P2914M85-MPB	1 1/4	5.088	4.983	5.56	D1F	2 1/16	1	4	1	—	3 1/16	4	3 1/8	3 1/16	19.4
30	P3014M85-MPB	1 1/4	5.263	5.157	6.13	D1F	2 1/2	1	4	1	—	4 3/4	4	3 29/32	3 1/16	20.6
32	P3214M85-MPB	1 1/4	5.614	5.507	6.13	D1F	2 1/2	1	4	1	—	4 3/4	4	3 29/32	3 1/16	23.4
34	P3414M85-MPB	1 1/4	5.965	5.858	6.50	D1F	2 1/16	1	4	1	—	4 3/4	4	4 1/16	3 1/16	27.4
QD 85mm (3.35in.) Wide Belts (14M-85)																
30	P3014M85-SK	SK	5.293	5.157	6.13	A1F	2 3/8	3/4	1 1/8	1 1/8	1 1/8	—	4	3.92	3 1/16	10
32	P3214M85-SK	SK	5.614	5.507	6.13	A1F	2 3/8	3/4	1 1/8	1 1/8	1 1/8	—	4	3.92	3 1/16	13
34	P3414M85-SK	SK	5.965	5.853	6.13	A1F	2 3/8	3/4	1 1/8	1 1/8	1 1/8	—	4	4.06	3 1/16	14
36	P3614M85-SF	SF	6.316	6.206	6.81	A1F	2 3/8	3/4	2	1 1/4	1 3/8	—	4	4.69	3 1/16	15
38	P3814M85-SF	SF	6.667	6.557	7.16	A1F	2 3/8	3/4	2	1 1/4	1 3/8	—	4	4.94	3 1/16	18
40	P4014M85-SF	SF	7.018	6.909	7.50	A1F	2 3/8	3/4	2	1 1/4	1 3/8	—	4	5.06	3 1/16	20
44	P4414M85-E	E	7.720	7.610	8.22	A1F	3 1/2	5/16	2 3/8	1 1/16	1 3/16	—	4	6.12	3 1/16	25
48	P4814M85-E	E	8.421	8.311	8.94	A1F	3 1/2	5/16	2 3/8	1 1/16	1 3/16	—	4	6.50	3 1/16	29
52	P5214M85-E	E	9.123	9.013	9.69	A1F	3 1/2	5/16	2 3/8	1 1/16	1 3/16	—	4	7.18	3 1/16	32
56	P5614M85-F	F	9.825	9.715	10.38	D1F	4	1/2	3 3/8	3/4	3/4	—	4	7.88	3 1/16	46
60	P6014M85-F	F	10.527	10.417	11.06	D1F	4	1/2	3 3/8	3/4	3/4	—	4	8.50	3 1/16	51
64	P6414M85-F	F	11.229	11.119	11.75	D1F	4	1/2	3 3/8	3/4	3/4	—	4	9.25	3 1/16	62
68	P6814M85-F	F	11.930	11.820	12.50	D2F	4	1/2	3 3/8	3/4	3/4	—	4	10.00	3 1/16	51
72	P7214M85-F	F	12.632	12.522	13.19	D2F	4	1/2	3 3/8	3/4	3/4	—	4	10.69	3 1/16	60
80	P8014M85-F	F	14.036	13.926	14.63	D2F	4	1/2	3 3/8	3/4	3/4	—	4	12.13	3 1/16	66
90	P9014M85-F	F	15.790	15.680	—	D3	4	1/2	3 3/8	3/4	3/4	—	4	14.00	—	69
112	P11214M85-F	F	19.650	19.540	—	D3	4	1/2	3 3/8	3/4	3/4	—	4	17.88	—	89
144	P14414M85-F	F	25.264	25.154	—	D3	4	1/2	3 3/8	3/4	3/4	—	4	23.38	—	127
168	P16814M85-J	J	29.475	29.365	—	D3	4 1/2	1/2	3 3/8	3/4	3/4	—	4	27.56	—	148
192	P19214M85-J	J	33.686	33.576	—	D3	4 1/2	1/2	3 3/8	3/4	3/4	—	4	31.81	—	177
216	P21614M85-J	J	37.896	37.786	—	D3	4 1/2	1/2	3 3/8	3/4	3/4	—	4	35.75	—	251
Taper Bushed 85mm (3.35in.) Wide Belts (14M-85)																
30	P3014M85-2517	2517	5.263	5.153	6.13	WF-1	2 1/2	1/2	1 1/4	1 1/4	—	—	4	3.928	3 1/16	9.7
32	P3214M85-2517	2517	5.614	5.504	6.13	WF-1	2 11/16	7/8	1 1/4	1 1/4	—	—	4	3.928	3 1/16	12.7
34	P3414M85-2517	2517	5.965	5.855	6.50	WF-1	2 11/16	7/8	1 1/4	1 1/4	—	—	4	4.063	3 1/16	15.3
36	P3614M85-3020	3020	6.316	6.206	6.81	WF-1	3 1/4	1 1/2	2	1 13/32	—	—	4	4.688	3 1/16	19.3
38	P3814M85-3020	3020	6.667	6.557	7.16	WF-1	3 1/4	1 1/2	2	1 13/32	—	—	4	4.813	3 1/16	21.9
40	P4014M85-3020	3020	7.018	6.908	7.50	WF-1	3 1/4	1 1/2	2	1 13/32	—	—	4	5.063	3 1/16	25.1
44	P4414M85-3020	3020	7.720	7.610	8.22	WF-1	3 1/4	1 1/2	2	1 13/32	—	—	4	6.125	3 1/16	28.4
48	P4814M85-3020	3020	8.421	8.311	8.94	WF-1	3 1/4	1 1/2	2	1 13/32	—	—	4	6.500	3 1/16	35.4
52	P5214M85-3535	3535	9.123	9.013	9.69	KF-1	3 15/16	—	3 1/2	1/2	—	—	4	7.188	3 1/16	42.9
56	P5614M85-3535	3535	9.825	9.715	10.38	KF-1	3 15/16	—	3 1/2	1/2	—	—	4	7.875	3 1/16	52.4
60	P6014M85-3535	3535	10.527	10.417	11.06	KF-1	3 15/16	—	3 1/2	1/2	—	—	4	8.500	3 1/16	62.7
64	P6414M85-3535	3535	11.229	11.119	11.75	KF-1	3 15/16	—	3 1/2	1/2	—	—	4	9.250	3 1/16	73.6
68	P6814M85-3535	3535	11.930	11.820	12.50	KF-1	3 15/16	—	3 1/2	1/2	—	—	4	10.000	3 1/16	64.2
72	P7214M85-3535	3535	12.632	12.522	13.19	KF-1	3 15/16	—	3 1/2	1/2	—	—	4	10.688	3 1/16	97.4
80	P8014M85-3535	3535	14.036	13.926	14.63	WF-2	3 15/16	—	3 1/2	1/2	—	—	4	12.125	3 1/16	68.4
90	P9014M85-3535	3535	15.790	15.680	—	W-3	3 15/16	—	3 1/2	1/2	—	7	4	13.563	—	69.1
112	P11214M85-3535	3535	19.650	19.540	—	W-3	3 15/16	—	3 1/2	1/2	—	7	4	17.375	—	85.7
144	P14414M85-4040	4040	25.264	25.154	—	W-3	4 7/16	—	4	—	—	8 1/2	4	23.000	—	131.6
168	P16814M85-4040	4040	29.475	29.365	—	W-3	4 7/16	—	4	—	—	8 1/2	4	27.250	—	146.1
192	P19214M85-4040	4040	33.686	33.576	—	W-3	4 7/16	—	4	—	—	8 1/2	4	31.375	—	161.4

* Weight Shown is for Sprocket Less Bushing.

• Reverse Mount Only

+ The numbers (1=Solid, 2=Web, 3=Arms), within the "Type" indicates construction and the letter F indicates the sprocket has flanges.

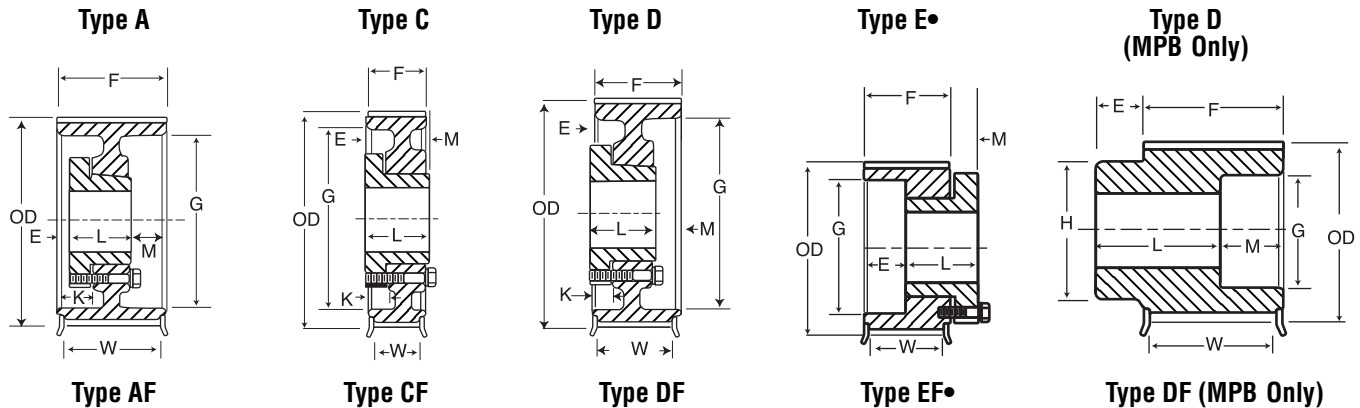

MPB 115mm (4.53 in.) Wide Belts (14M-115)																
No. of Teeth	Catalog Number	Bore	P.D.	Diameter (in.)		Type +	Max. Bore	Dimensions (in.)							Weight* Approx. (lbs)	
				O.D.	Flange			E	L	M	K	H	F	G		W
28	P2814M115-MPB	1/4	4.912	4.808	5.56	D1F	2 5/16	1 1/4	5	1 1/2	—	3 1/16	5 1/4	3 3/8	4 15/16	23.2
29	P2914M115-MPB	1/4	5.088	4.983	5.56	D1F	2 5/16	1 1/4	5	1 1/2	—	3 1/16	5 1/4	3 3/8	4 15/16	24.8
30	P3014M115-MPB	1/4	5.263	5.157	6.13	D1F	2 1/2	1 1/4	5	1 1/2	—	4 3/64	5 1/4	3 39/64	4 15/16	26.4
32	P3214M115-MPB	1/4	5.614	5.507	6.13	D1F	2 1/2	1 1/4	5	1 1/2	—	4 3/64	5 1/4	3 39/64	4 15/16	30.8
34	P3414M115-MPB	1/4	5.965	5.858	6.50	D1F	2 11/16	1 1/4	5	1 1/2	—	4 31/64	5 1/4	4 1/8	4 15/16	35.2
36	P3614M115-MPB	1/4	6.316	6.208	6.81	D1F	3	1 1/4	5	1 1/2	—	4 7/8	5 1/4	4 11/16	4 15/16	38.8
38	P3814M115-MPB	1/4	6.667	6.559	7.16	D1F	3 1/4	1 1/4	5	1 1/2	—	5 11/64	5 1/4	4 15/16	4 15/16	44.4
40	P4014M115-MPB	1/4	7.018	6.909	7.50	D1F	3 3/8	1 1/4	5	1 1/2	—	5 5/16	5 1/4	5 1/8	4 15/16	50
QD 115mm (4.53 in.) Wide Belts (14M-115)																
30	P3014M115-SK	1/4	5.263	5.157	6.13	A1F	2 1/2	1 1/4	1 1/4	2	2	—	5 1/4	3.92	4 15/16	12
32	P3214M115-SK	1/4	5.614	5.507	6.13	A1F	2 1/2	1 1/4	1 1/4	2	2	—	5 1/4	3.92	4 15/16	16
34	P3414M115-SK	1/4	5.965	5.858	6.50	A1F	2 1/2	1 1/4	1 1/4	2	2	—	5 1/4	4.06	4 15/16	17
36	P3614M115-SF	1/4	6.316	6.208	6.81	A1F	3	1 1/4	2	1 1/2	2	—	5 1/4	4.69	4 15/16	18
38	P3814M115-SF	1/4	6.667	6.559	7.16	A1F	3	1 1/4	2	1 1/2	2	—	5 1/4	4.94	4 15/16	22
40	P4014M115-SF	1/4	7.018	6.909	7.50	A1F	3	1 1/4	2	1 1/2	2	—	5 1/4	5.06	4 15/16	25
44	P4414M115-E	E	7.720	7.610	8.22	A1F	3 1/2	1 5/16	2 1/2	1 11/16	1 13/16	—	5 1/4	6.12	4 15/16	30
48	P4814M115-E	E	8.421	8.311	8.94	A1F	4	1 5/16	2 1/2	1 11/16	1 13/16	—	5 1/4	6.50	4 15/16	35
52	P5214M115-F	F	9.123	9.013	9.69	A1F	4	3/8	3 1/2	1 1/4	1 1/8	—	5 1/4	7.18	4 15/16	42
56	P5614M115-F	F	9.825	9.715	10.38	A1F	4	3/8	3 1/2	1 1/4	1 1/8	—	5 1/4	7.88	4 15/16	53
60	P6014M115-F	F	10.527	10.417	11.06	A1F	4 1/2	3/8	3 1/2	1 1/4	1 1/8	—	5 1/4	8.50	4 15/16	60
64	P6414M115-J	J	11.229	11.119	11.75	D1F	4 1/2	3/8	4 1/2	1 1/2	1	—	5 1/4	9.25	4 15/16	76
68	P6814M115-J	J	11.930	11.820	12.50	D1F	4 1/2	3/8	4 1/2	1 1/2	1	—	5 1/4	10.00	4 15/16	83
72	P7214M115-J	J	12.632	12.522	13.19	D1F	4 1/2	3/8	4 1/2	1 1/2	1	—	5 1/4	10.69	4 15/16	99
80	P8014M115-J	J	14.036	13.926	14.63	D2F	4 1/2	3/8	4 1/2	1 1/2	1	—	5 1/4	12.13	4 15/16	87
90	P9014M115-J	J	15.790	15.680	—	D2	4 1/2	3/8	4 1/2	1 1/2	1	—	5 1/4	14.00	—	95
112	P11214M115-J	J	19.650	19.540	—	D3	4 1/2	3/8	4 1/2	1 1/2	1	—	5 1/4	17.88	—	114
144	P14414M115-J	J	25.264	25.154	—	D3	4 1/2	3/8	4 1/2	1 1/2	1	—	5 1/4	23.38	—	166
168	P16814M115-M	M	29.475	29.365	—	D3	5 1/2	3/8	4 1/2	1 1/2	1	—	5 1/4	27.56	—	198
192	P19214M115-M	M	33.686	33.576	—	D3	5 1/2	3/8	4 1/2	1 1/2	1	—	5 1/4	31.81	—	232
216	P21614M115-M	M	37.896	37.786	—	D3	5 1/2	3/8	4 1/2	1 1/2	1	—	5 1/4	35.75	—	307
Taper Bushed 115mm (4.53 in.) Wide Belts (14M-115)																
30	P3014M115-2517	2517	5.263	5.153	6.13	WF-1	2 11/16	1 1/4	1 1/4	1 1/4	—	—	5 1/4	3.928	4 15/16	13.5
32	P3214M115-2517	2517	5.614	5.504	6.13	WF-1	2 11/16	1 1/4	1 1/4	1 1/4	—	—	5 1/4	3.928	4 15/16	17.3
34	P3414M115-2517	2517	5.965	5.855	6.50	WF-1	2 11/16	1 1/4	1 1/4	1 1/4	—	—	5 1/4	4.063	4 15/16	20.9
36	P3614M115-3020	3020	6.316	6.206	6.81	WF-1	3 1/4	1 1/2	2	1 1/2	—	—	5 1/4	4.688	4 15/16	18.6
38	P3814M115-3020	3020	6.667	6.557	7.16	WF-1	3 1/4	1 1/2	2	1 1/2	—	—	5 1/4	4.813	4 15/16	22.5
40	P4014M115-3020	3020	7.018	6.908	7.50	WF-1	3 3/4	1 1/2	2	1 1/2	—	—	5 1/4	5.063	4 15/16	26.8
44	P4414M115-3535	3535	7.720	7.610	8.22	WF-1	3 15/16	7/8	3 1/2	1 3/4	—	—	5 1/4	6.125	4 15/16	30.8
48	P4814M115-3535	3535	8.421	8.311	8.94	WF-1	3 15/16	7/8	3 1/2	1 3/4	—	—	5 1/4	6.500	4 15/16	41.1
52	P5214M115-4040	4040	9.123	9.013	9.69	WF-1	4 1/16	3/4	4	1 3/4	—	—	5 1/4	7.188	4 15/16	46.9
56	P5614M115-4040	4040	9.825	9.715	10.38	WF-1	4 1/16	3/4	4	1 3/4	—	—	5 1/4	7.875	4 15/16	58.3
60	P6014M115-4040	4040	10.527	10.417	11.06	WF-1	4 1/16	3/4	4	1 3/4	—	—	5 1/4	8.500	4 15/16	70.9
64	P6414M115-4545	4545	11.229	11.119	11.75	WF-1	4 15/16	3/4	4 1/2	1 3/4	—	—	5 1/4	9.250	4 15/16	82.1
68	P6814M115-4545	4545	11.930	11.820	12.50	WF-1	4 15/16	3/4	4 1/2	1 3/4	—	—	5 1/4	10.000	4 15/16	97.1
72	P7214M115-4545	4545	12.632	12.522	13.19	WF-1	4 15/16	3/4	4 1/2	1 3/4	—	—	5 1/4	10.688	4 15/16	113.3
80	P8014M115-4545	4545	14.036	13.926	14.63	WF-2	4 15/16	3/4	4 1/2	1 3/4	9 1/2	—	5 1/4	12.125	4 15/16	108.9
90	P9014M115-4545	4545	15.790	15.680	—	W-2	4 15/16	3/4	4 1/2	1 3/4	9 1/2	—	5 1/4	13.563	—	112.9
112	P11214M115-4545	4545	19.650	19.540	—	W-3	4 15/16	3/4	4 1/2	1 3/4	9 1/2	—	5 1/4	17.375	—	122.4
144	P14414M115-4545	4545	25.264	25.154	—	W-3	4 15/16	3/4	4 1/2	1 3/4	9 1/2	—	5 1/4	23.000	—	155.0
168	P16814M115-4545	4545	29.475	29.365	—	W-3	4 15/16	3/4	4 1/2	1 3/4	9 1/2	—	5 1/4	27.250	—	188.0
192	P19214M115-4545	4545	33.686	33.576	—	W-3	4 15/16	3/4	4 1/2	1 3/4	9 1/2	—	5 1/4	31.375	—	318.8
216	P21614M115-6050	6050	37.896	37.786	—	W-3	6	—	5	1 3/4	15 1/2	—	5 1/4	35.625	—	350.3

* Weight Shown is for Sprocket Less Bushing.
 • Reverse Mount Only

+ The numbers (1=Solid, 2=Web, 3=Arms) within the "Type" indicates construction, and the letter F indicates the sprocket has flanges.

High Torque Sprockets 14mm

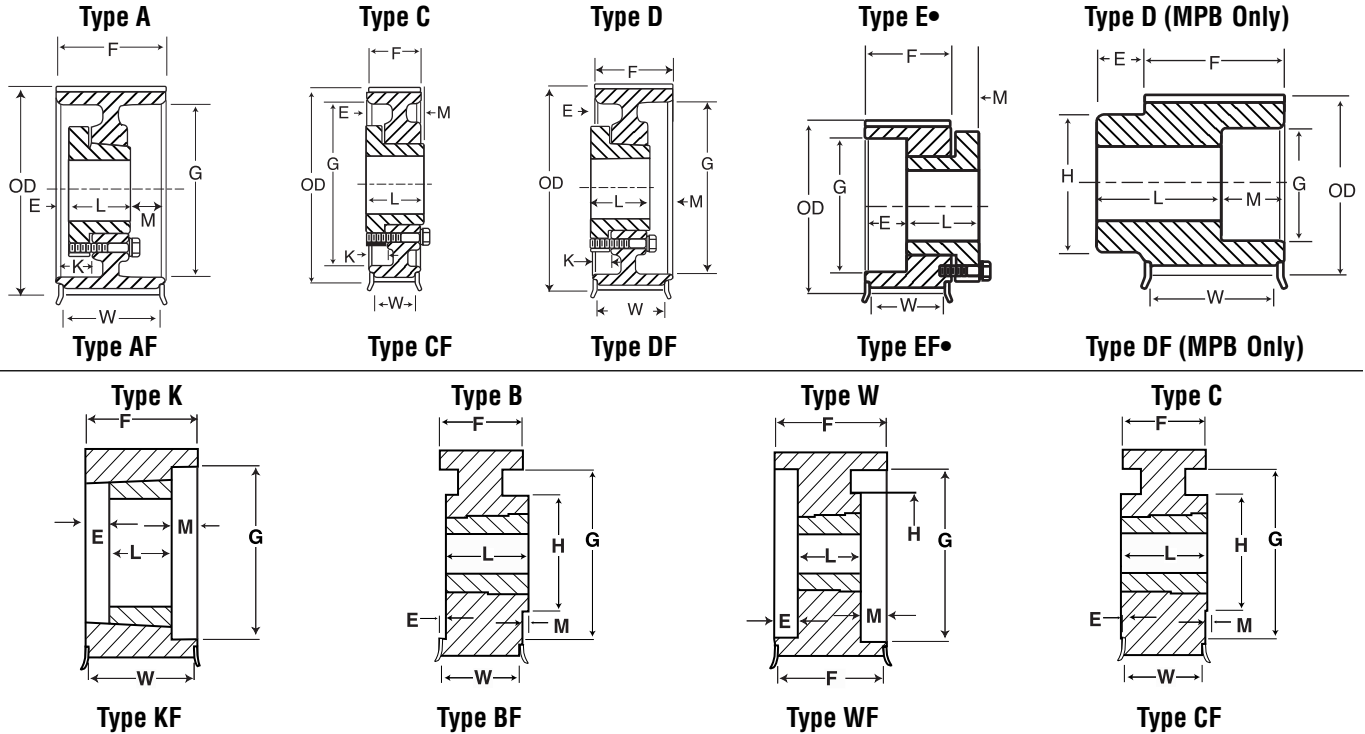

MPB 170mm (6.69 in.) Wide Belts (14M-170)																
No. of Teeth	Catalog Number	Bore	P.D.	Diameter (in.)		Type +	Max. Bore	Dimensions (in.)								Weight* Approx. (lbs)
				O.D.	Flange			E	L	M	K	H	F	G	W	
36	P3614M170-MPB	1½	6.316	6.208	6.81	D1F	3	1¼	6	2½	—	4¾	7%	4 ¹¹ / ₁₆	7 ¹ / ₁₆	47
38	P3814M170-MPB	1½	6.667	6.559	7.16	D1F	3¼	1¼	6	2½	—	5 ¹ / ₁₆	7%	4 ¹⁹ / ₁₆	7 ¹ / ₁₆	55.7
40	P4014M170-MPB	1½	7.018	6.909	7.50	D1F	3 ⁵ / ₁₆	1¼	6	2½	—	5 ⁵ / ₁₆	7%	5 ¹ / ₁₆	7 ¹ / ₁₆	63.7
44	P4414M170-MPB	1½	7.720	7.610	8.22	D1F	4%	1¼	6	2½	—	6 ⁴ / ₆₄	7%	6½	7 ¹ / ₁₆	75.7
48	P4814M170-MPB	1½	8.421	8.311	8.94	D1F	4½	1¼	6	2½	—	6 ¹⁵ / ₆₄	7%	6½	7 ¹ / ₁₆	94
QD 170mm (6.69 in.) Wide Belts (14M-170)																
44	P4414M170-E	E	7.720	7.610	8.22	A1F	3%	2	2½	2¾	2½	—	7%	6.12	7 ¹ / ₁₆	38
48	P4814M170-E	E	8.421	8.311	8.94	A1F	3%	2	2½	2¾	2 ¹ / ₁₆	—	7%	6.50	7 ¹ / ₁₆	45
52	P5214M170-F	F	9.123	9.013	9.69	A1F	4	1 ¹ / ₁₆	3%	2 ¹ / ₁₆	2 ¹ / ₁₆	—	7%	7.18	7 ¹ / ₁₆	52
56	P5614M170-F	F	9.825	9.715	10.38	A1F	4	1 ¹ / ₁₆	3%	2 ¹ / ₁₆	2 ¹ / ₁₆	—	7%	7.88	7 ¹ / ₁₆	65
60	P6014M170-J	J	10.527	10.417	11.06	A1F	4½	1 ¹ / ₁₆	4½	1 ¹ / ₁₆	2½	—	7%	8.50	7 ¹ / ₁₆	75
64	P6414M170-J	J	11.229	11.119	11.75	A1F	4½	1 ¹ / ₁₆	4½	1 ¹ / ₁₆	2½	—	7%	9.25	7 ¹ / ₁₆	91
68	P6814M170-J	J	11.930	11.820	12.50	A1F	4½	1 ¹ / ₁₆	4½	1 ¹ / ₁₆	2½	—	7%	10.00	7 ¹ / ₁₆	96
72	P7214M170-J	J	12.632	12.522	13.19	A1F	4½	1 ¹ / ₁₆	4½	1 ¹ / ₁₆	2½	—	7%	10.69	7 ¹ / ₁₆	115
80	P8014M170-J	J	14.036	13.926	14.63	A2F	4½	1 ¹ / ₁₆	4½	1 ¹ / ₁₆	2½	—	7%	12.13	7 ¹ / ₁₆	107
90	P9014M170-J	J	15.790	15.680	—	A2	4½	1 ¹ / ₁₆	4½	1 ¹ / ₁₆	2½	—	7%	14.00	—	116
112	P11214M170-M	M	19.650	19.540	—	A3	5½	0	6%	¾	1 ¹ / ₁₆	—	7%	17.88	—	175
144	P14414M170-M	M	25.264	25.154	—	A3	5½	0	6%	¾	1 ¹ / ₁₆	—	7%	23.38	—	240
168	P16814M170-M	M	29.475	29.365	—	A3	5½	0	6%	¾	1 ¹ / ₁₆	—	7%	27.56	—	278
192	P19214M170-M	M	33.686	33.576	—	A3	5½	0	6%	¾	1 ¹ / ₁₆	—	7%	31.81	—	322
216	P21614M170-M	M	37.896	37.786	—	A3	5½	0	6%	¾	1 ¹ / ₁₆	—	7%	35.75	—	399
Taper Bushed 170mm (6.69 in.) Wide Belts (14M-170)																
44	P4414M170-3535	3535	7.720	7.610	8.22	WF-1	3 ¹⁵ / ₁₆	1 ¹⁵ / ₁₆	3½	1 ¹⁵ / ₁₆	—	—	7%	6.13	7 ¹ / ₁₆	39.7
48	P4814M170-3535	3535	8.421	8.311	8.94	WF-1	3 ¹⁵ / ₁₆	1 ¹⁵ / ₁₆	3½	1 ¹⁵ / ₁₆	—	—	7%	6.50	7 ¹ / ₁₆	52.8
52	P5214M170-4040	4040	9.123	9.013	9.69	WF-1	4%	1 ¹ / ₁₆	4	1 ¹ / ₁₆	—	—	7%	7.19	7 ¹ / ₁₆	59.8
56	P5614M170-4040	4040	9.825	9.715	10.38	WF-1	4%	1 ¹ / ₁₆	4	1 ¹ / ₁₆	—	—	7%	7.88	7 ¹ / ₁₆	72.4
60	P6014M170-4545	4545	10.527	10.417	11.06	WF-1	4 ¹⁵ / ₁₆	1 ¹ / ₁₆	4½	1 ¹ / ₁₆	—	—	7%	8.50	7 ¹ / ₁₆	83.7
64	P6414M170-4545	4545	11.229	11.119	11.75	WF-1	4 ¹⁵ / ₁₆	1 ¹ / ₁₆	4½	1 ¹ / ₁₆	—	—	7%	9.25	7 ¹ / ₁₆	98.6
68	P6814M170-4545	4545	11.930	11.820	12.50	WF-1	4 ¹⁵ / ₁₆	1 ¹ / ₁₆	4½	1 ¹ / ₁₆	—	—	7%	10.00	7 ¹ / ₁₆	114.4
72	P7214M170-4545	4545	12.632	12.522	13.19	WF-1	4 ¹⁵ / ₁₆	1 ¹ / ₁₆	4½	1 ¹ / ₁₆	—	—	7%	10.69	7 ¹ / ₁₆	131.8
80	P8014M170-4545	4545	14.036	13.926	14.63	WF-2	4 ¹⁵ / ₁₆	1 ¹ / ₁₆	4½	1 ¹ / ₁₆	—	9½	7%	12.13	7 ¹ / ₁₆	129.3
90	P9014M170-4545	4545	15.790	15.680	—	W-2	4 ¹⁵ / ₁₆	1 ¹ / ₁₆	4½	1 ¹ / ₁₆	—	9½	7%	13.56	—	126.8
112	P11214M170-4545	4545	19.650	19.540	—	W-3	4 ¹⁵ / ₁₆	1 ¹ / ₁₆	4½	1 ¹ / ₁₆	—	9½	7%	17.38	—	148.0
144	P14414M170-6050	6050	25.264	25.154	—	W-3	6	1 ¹ / ₁₆	5	1 ¹ / ₁₆	—	15½	7%	23.00	—	208.0
168	P16814M170-6050	6050	29.475	29.365	—	W-3	6	1 ¹ / ₁₆	5	1 ¹ / ₁₆	—	15½	7%	27.25	—	227.0
192	P19214M170-6050	6050	33.686	33.576	—	W-3	6	1 ¹ / ₁₆	5	1 ¹ / ₁₆	—	15½	7%	31.38	—	340.0
216	P21614M170-6050	6050	37.896	37.786	—	W-3	6	1 ¹ / ₁₆	5	1 ¹ / ₁₆	—	15½	7%	35.63	—	390.0

* Weight Shown is for Sprocket Less Bushing.

• Reverse Mount Only

+ The numbers (1=Solid, 2=Web, 3=Arms), within the "Type" indicates construction and the letter F indicates the sprocket has flanges.



High Torque Sprockets 20mm

QD 115mm (4.53 in.) Wide Belts (20M-115)																
No. of Teeth	Catalog Number	Bore	P.D.	Diameter (in.)		Type +	Max. Bore	Dimensions (in.)								Weight* Approx. (lbs)
				O.D.	Flange			E	L	M	K	H	F	G	W	
34	P3420M115-F	F	8.522	8.352	9.449	A1F	4.00	0.44	3.63	1.31	1.44	—	5.38	6.88	5.0	32
36	P3620M115-F	F	9.023	8.853	9.843	A1F	4.00	0.44	3.63	1.31	1.44	—	5.38	7.00	5.0	40
38	P3820M115-F	F	9.524	9.354	10.433	A1F	4.00	0.44	3.63	1.31	1.44	—	5.38	7.56	5.0	45
40	P4020M115-F	F	10.026	9.856	10.827	A1F	4.00	0.44	3.63	1.31	1.44	—	5.38	8.00	5.0	51
44	P4420M115-F	F	11.028	10.858	11.811	A1F	4.00	0.44	3.63	1.31	1.44	—	5.38	8.93	5.0	63
48	P4820M115-J	J	12.031	11.861	12.795	A1F	4.50	0.00	4.50	0.88	1.18	—	5.38	9.93	5.0	84
52	P5220M115-J	J	13.033	12.863	13.764	A2F	4.50	0.00	4.50	0.88	1.18	—	5.38	10.88	5.0	80
56	P5620M115-J	J	14.036	13.866	14.764	A2F	4.50	0.00	4.50	0.88	1.18	—	5.38	11.88	5.0	87
60	P6020M115-J	J	15.038	14.868	15.927	A2F	4.50	0.00	4.50	0.88	1.18	—	5.38	13.06	5.0	94
64	P6420M115-J	J	16.041	15.871	16.929	A2F	4.50	0.00	4.50	0.88	1.18	—	5.38	14.06	5.0	104
68	P6820M115-J	J	17.044	16.874	17.927	A2F	4.50	0.00	4.50	0.88	1.18	—	5.38	15.00	5.0	110
72	P7220M115-J	J	18.046	17.876	18.898	A2F	4.50	0.00	4.50	0.88	1.18	—	5.38	16.00	5.0	119
80	P8020M115-M	M	20.051	19.881	20.866	C2F	5.50	1.25	6.75	0.12	0.18	—	5.38	18.00	5.0	182
90	P9020M115-M	M	22.558	22.388	23.425	C2F	5.50	1.25	6.75	0.12	0.18	—	5.38	20.56	5.0	212
112	P11220M115-M	M	28.072	27.902	—	C3	5.50	1.25	6.75	0.12	0.18	—	5.38	26.38	—	239
144	P14420M115-N	N	36.092	35.922	—	C3	5.87	1.75	8.12	1.00	0.00	—	5.38	34.38	—	341
168	P16820M115-N	N	42.108	41.938	—	C3	5.87	1.75	8.12	1.00	0.00	—	5.38	40.38	—	417
192	P19220M115-N	N	48.123	47.953	—	C3	5.87	1.75	8.12	1.00	0.00	—	5.38	46.25	—	500
216	P21620M115-N	N	54.138	53.968	—	C3	5.77	1.75	8.12	1.00	0.00	—	5.38	52.25	—	566
MPB 170mm (6.69 in.) Wide Belts (20M-170)																
34	P3420M170-MPB	2½	8.522	8.352	9.449	D1F	4.38	1.25	6.50	2.25	—	6.50	7.50	6.50	7.12	82
36	P3620M170-MPB	2½	9.023	8.853	9.843	D1F	4.50	1.25	6.50	2.25	—	7.00	7.50	7.00	7.12	93
QD 170mm (6.69 in.) Wide Belts (20M-170)																
38	P3820M170-J	J	9.524	9.354	10.433	A1F	4.50	1.00	4.50	2.00	2.18	—	7.50	7.56	7.12	56
40	P4020M170-J	J	10.026	9.856	10.827	A1F	4.50	1.00	4.50	2.00	2.18	—	7.50	8.00	7.12	64
44	P4420M170-J	J	11.028	10.858	11.811	A1F	4.50	1.00	4.50	2.00	2.18	—	7.50	8.93	7.12	81
48	P4820M170-M	M	12.031	11.861	12.795	A1F	5.50	0.06	6.75	0.68	1.50	—	7.50	9.93	7.12	113
52	P5220M170-M	M	13.033	12.863	13.764	A1F	5.50	0.06	6.75	0.68	1.50	—	7.50	10.88	7.12	141
56	P5620M170-M	M	14.036	13.866	14.764	A1F	5.50	0.06	6.75	0.68	1.50	—	7.50	11.88	7.12	170
60	P6020M170-M	M	15.038	14.868	15.927	A1F	5.50	0.06	6.75	0.68	1.50	—	7.50	13.06	7.12	199
64	P6420M170-M	M	16.041	15.871	16.929	A2F	5.50	0.06	6.75	0.68	1.50	—	7.50	14.06	7.12	175
68	P6820M170-M	M	17.044	16.874	17.927	A2F	5.50	0.06	6.75	0.68	1.50	—	7.50	15.00	7.12	187
72	P7220M170-M	M	18.046	17.876	18.898	A2F	5.50	0.06	6.75	0.68	1.50	—	7.50	16.00	7.12	196
80	P8020M170-M	M	20.051	19.881	20.866	A2F	5.50	0.06	6.75	0.68	1.50	—	7.50	18.00	7.12	214
90	P9020M170-M	M	22.558	22.388	23.425	A2F	5.50	0.06	6.75	0.68	1.50	—	7.50	20.56	7.12	250
112	P11220M170-N	N	28.072	27.902	—	C3	5.87	0.50	8.12	0.12	1.25	—	7.50	26.25	7.12	309
144	P14420M170-N	N	36.092	35.922	—	C3	5.87	0.50	8.12	0.12	1.25	—	7.50	34.25	—	426
168	P16820M170-P	P	42.108	41.938	—	C3	7.00	0.90	9.38	0.94	1.06	—	7.50	40.25	—	571
192	P19220M170-P	P	48.123	47.953	—	C3	7.00	0.94	9.38	0.94	1.06	—	7.50	46.25	—	652
216	P21620M170-P	P	54.138	53.968	—	C3	7.00	0.94	9.38	0.94	1.06	—	7.50	52.12	—	813
MPB 230mm (9.06 in.) Wide Belts (20M-230)																
38	P3820M230-MPB	2½	9.524	9.354	10.433	D1F	4.75	1.25	7.50	3.63	—	7.50	9.88	7.56	9.50	120
40	P4020M230-MPB	2½	10.026	9.856	10.827	D1F	5.25	1.25	8.50	2.63	—	8.00	9.88	8.00	9.50	147
44	P4420M230-MPB	2½	11.028	10.858	11.811	D1F	5.25	1.25	8.50	2.63	—	8.25	9.88	8.93	9.50	180
QD 230mm (9.06 in.) Wide Belts (20M-230)																
48	P4820M230-M	M	12.031	11.861	12.795	A1F	5.50	0.56	6.75	2.56	2.00	—	9.88	9.93	9.50	129
52	P5220M230-M	M	13.033	12.863	13.764	A1F	5.50	0.56	6.75	2.56	2.00	—	9.88	10.88	9.50	158
56	P5620M230-M	M	14.036	13.866	14.764	A1F	5.50	0.56	6.75	2.56	2.00	—	9.88	11.88	9.50	189
60	P6020M230-M	M	15.038	14.868	15.927	A1F	5.50	0.56	6.75	2.56	2.00	—	9.88	13.06	9.50	217
64	P6420M230-M	M	16.041	15.871	16.929	A2F	5.50	0.56	6.75	2.56	2.00	—	9.88	14.06	9.50	198
68	P6820M230-N	N	17.044	16.874	17.927	A1F	5.87	0.06	8.12	1.69	1.81	—	9.88	15.00	9.50	324
72	P7220M230-N	N	18.046	17.876	18.898	A2F	5.87	0.06	8.12	1.69	1.81	—	9.88	16.00	9.50	287
80	P8020M230-N	N	20.051	19.881	20.866	A2F	5.87	0.06	8.12	1.69	1.81	—	9.88	18.00	9.50	280
90	P9020M230-N	N	22.558	22.388	23.425	A2F	5.87	0.06	8.12	1.69	1.81	—	9.88	20.56	9.50	319
112	P11220M230-N	N	28.072	27.902	—	A3	5.87	0.06	8.12	1.69	1.81	—	9.88	26.25	—	357
144	P14420M230-P	P	36.092	35.922	—	D3	7.00	0.69	9.38	1.19	1.31	—	9.88	34.25	—	535
168	P16820M230-P	P	42.108	41.938	—	D3	7.00	0.69	9.38	1.19	1.31	—	9.88	40.25	—	654
192	P19220M230-W	W	48.123	47.953	—	C3	8.50	0.75	11.38	0.75	1.50	—	9.88	46.00	—	935
216	P21620M230-W	W	54.138	53.968	—	C3	8.50	0.75	11.38	0.75	1.50	—	9.88	52.00	—	1062

* Weight Shown is for Sprocket less Bushing.
 • Reverse Mount Only

+ The numbers (1=Solid, 2=Web, 3=Arms), within the "Type" indicates construction and the letter F indicates the sprocket has flanges.

PULLEYS

High Torque Sprockets 20mm

Martin

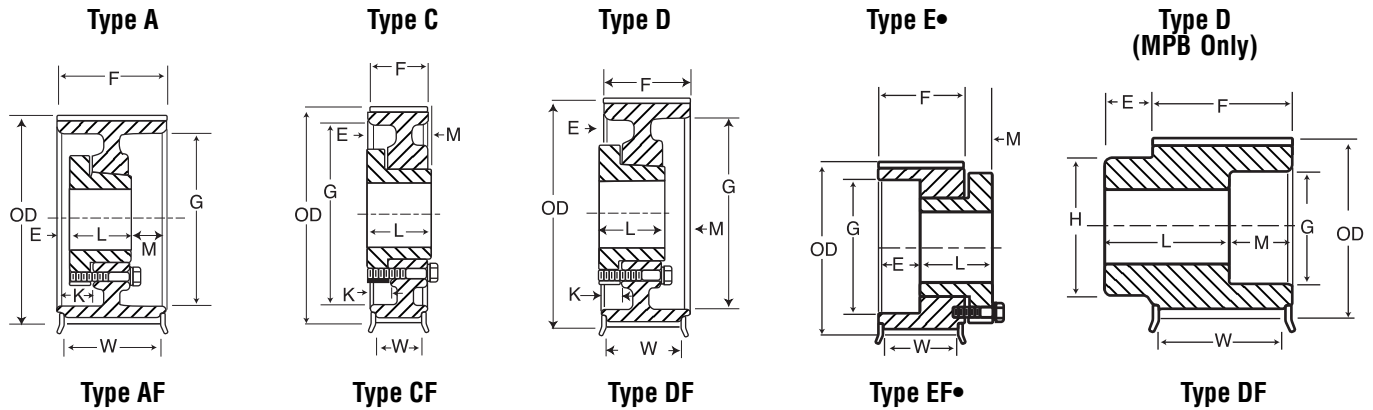

QD 290mm (11.42 in.) Wide Belts (20M-290)																	
No. of Teeth	Catalog Number	Bore	P.D.	Diameter (in.)		Type +	Max. Bore	Dimensions (in.)								Weight Approx. (lbs)	
				O.D.	Flange			E	L	M	H	K	F	G	W		
52	P5220M290-N	N	13.033	12.863	13.764	A1F	5.87	0.75	8.12	2.38	2.50	—	12.25	10.88	11.88	187	
56	P5620M290-N	N	14.036	13.866	14.764	A1F	5.87	0.75	8.12	2.38	2.50	—	12.25	11.88	11.88	223	
60	P6020M290-N	N	15.038	14.868	15.927	A1F	5.87	0.75	8.12	2.38	2.50	—	12.25	13.06	11.88	257	
64	P6420M290-N	N	16.041	15.871	16.929	A1F	5.87	0.75	8.12	2.38	2.50	—	12.25	14.06	11.88	299	
68	P6820M290-N	N	17.044	16.874	17.927	A1F	5.87	0.75	8.12	2.38	2.50	—	12.25	15.00	11.88	346	
72	P7220M290-N	N	18.046	17.876	18.898	A2F	5.87	0.75	8.12	2.38	2.50	—	12.25	16.00	11.88	311	
80	P8020M290-N	N	20.051	19.881	20.866	A2F	5.87	0.75	8.12	2.38	2.50	—	12.25	18.00	11.88	314	
90	P9020M290-N	N	22.558	22.388	23.425	A2F	5.87	0.75	8.12	2.38	2.50	—	12.25	20.56	11.88	359	
112	P11220M290-P	P	28.072	27.902	—	A2	7.00	0.50	9.38	2.38	2.50	—	12.25	26.12	—	513	
144	P14420M290-P	P	36.092	35.922	—	A3	7.00	0.50	9.38	2.38	2.50	—	12.25	34.00	—	637	
168	P16820M290-W	W	42.108	41.938	—	A3	8.50	0.44	11.38	0.44	2.68	—	12.25	40.00	—	891	
192	P19220M290-W	W	48.123	47.953	—	A3	8.50	0.44	11.38	0.44	2.68	—	12.25	46.00	—	1061	
216	P21620M290-W	W	54.138	53.968	—	A3	8.50	0.44	11.38	0.44	2.68	—	12.25	52.00	—	1239	
QD 340 mm (13.39 in.) Wide Belts (20M-340)																	
52	P5220M340-N	N	13.033	12.863	13.764	A1F	5.87	0.75	8.12	5.38	2.50	—	14.25	10.88	13.88	201	
56	P5620M340-N	N	14.036	13.866	14.764	A1F	5.87	0.75	8.12	5.38	2.50	—	14.25	11.88	13.88	239	
60	P6020M340-N	N	15.038	14.868	15.927	A1F	5.87	0.75	8.12	5.38	2.50	—	14.25	13.06	13.88	273	
64	P6420M340-N	N	16.041	15.871	16.929	A1F	5.87	0.75	8.12	5.38	2.50	—	14.25	14.06	13.88	316	
68	P6820M340-N	N	17.044	16.874	17.927	A1F	5.87	0.75	8.12	5.38	2.50	—	14.25	15.00	13.88	364	
72	P7220M340-N	N	18.046	17.876	18.898	A2F	5.87	0.75	8.12	5.38	2.50	—	14.25	16.00	13.88	330	
80	P8020M340-P	P	20.051	19.881	20.866	A2F	7.00	1.50	9.38	3.38	3.50	—	14.25	18.00	13.88	406	
90	P9020M340-P	P	22.558	22.388	23.425	A2F	7.00	1.50	9.38	3.38	3.50	—	14.25	20.56	13.88	426	
112	P11220M340-P	P	28.072	27.902	—	A2	7.00	1.50	9.38	3.38	3.50	—	14.25	26.12	—	543	
144	P14420M340-W	W	36.092	35.922	—	A3	8.50	0.38	11.38	2.50	2.63	—	14.25	34.00	—	814	
168	P16820M340-W	W	42.108	41.938	—	A3	8.50	0.38	11.38	2.50	2.63	—	14.25	40.00	—	947	
192	P19220M340-S	S	48.123	47.953	—	D3	10.00	2.50	15.75	1.00	1.12	—	14.25	46.00	—	1368	
216	P21620M340-S	S	54.138	53.968	—	D3	10.00	2.50	15.75	1.00	1.12	—	14.25	51.88	—	1555	

* Weight Shown is for Sprocket less Bushing.
• Reverse Mount Only

+ The numbers (1=Solid, 2=Web, 3=Arms), within the "Type" indicates construction and the letter F indicates the sprocket has flanges.



HTS® 5mm Sprocket Diameters

No. of Teeth	Diameters mm In.		No. of Teeth	Diameters mm In.		No. of Teeth	Diameters mm In.		No. of Teeth	Diameters mm In.		No. of Teeth	Diameters mm In.	
	PD	OD		PD	OD		PD	OD		PD	OD		PD	OD
13	20.69 0.815	19.55 0.770	43	68.44 2.694	67.30 2.649	73	116.18 4.574	115.04 4.529	103	163.93 6.454	162.79 6.409	133	211.68 8.334	210.54 8.289
14	22.28 0.877	21.14 0.832	44	70.03 2.757	68.89 2.712	74	117.77 4.637	116.63 4.592	104	165.52 6.517	164.38 6.472	134	213.27 8.396	212.13 8.351
15	23.87 0.940	22.73 0.895	45	71.62 2.820	70.48 2.775	75	119.37 4.699	118.23 4.654	105	167.11 6.579	165.97 6.534	135	214.86 8.459	213.72 8.414
16	25.46 1.003	24.32 0.958	46	73.21 2.882	72.07 2.837	76	120.96 4.762	119.82 4.717	106	168.70 6.642	167.56 6.597	136	216.45 8.522	215.31 8.477
17	27.06 1.065	25.92 1.020	47	74.80 2.945	73.66 2.900	77	122.55 4.825	121.41 4.780	107	170.3 6.705	169.16 6.660	137	218.04 8.584	216.90 8.539
18	28.65 1.128	27.51 1.083	48	76.39 3.008	75.25 2.963	78	124.14 4.887	123.00 4.842	108	171.89 6.767	170.75 6.722	138	219.63 8.647	218.49 8.602
19	30.24 1.191	29.10 1.146	49	77.99 3.070	76.85 3.025	79	125.73 4.950	124.59 4.905	109	173.48 6.830	172.34 6.785	139	221.23 8.710	220.09 8.665
20	31.83 1.253	30.69 1.208	50	79.58 3.133	78.94 3.088	80	127.32 5.013	126.18 4.968	110	175.07 6.893	173.93 6.848	140	222.82 8.772	221.68 8.727
21	33.42 1.316	32.28 1.271	51	81.17 3.196	80.03 3.151	81	128.92 5.075	127.78 5.030	111	176.66 6.955	175.52 6.910	141	224.41 8.835	223.27 8.790
22	35.01 1.379	33.87 1.334	52	82.76 3.258	81.62 3.213	82	130.51 5.138	129.37 5.093	112	178.25 7.018	177.11 6.973	142	226.00 8.898	224.86 8.853
23	36.61 1.441	35.47 1.396	53	84.35 3.321	83.21 3.276	83	132.10 5.201	130.96 5.156	113	179.85 7.081	178.71 7.036	143	227.59 8.960	226.45 8.915
24	38.20 1.504	37.06 1.459	54	85.94 3.384	84.80 3.339	84	133.69 5.263	132.55 5.218	114	181.44 7.143	180.30 7.098	144	229.18 9.023	228.04 8.978
25	39.79 1.566	38.65 1.521	55	87.54 3.446	86.40 3.401	85	135.28 5.326	134.14 5.281	115	183.03 7.206	181.89 7.161	145	230.77 9.086	229.63 9.041
26	41.38 1.629	40.24 1.584	56	89.13 3.509	87.99 3.464	86	136.87 5.389	135.73 5.344	116	184.62 7.268	183.48 7.223	146	232.37 9.148	231.23 9.103
27	42.97 1.692	41.83 1.647	57	90.72 3.572	89.58 3.527	87	138.46 5.451	137.32 5.406	117	186.21 7.331	185.07 7.286	147	233.96 9.211	232.82 9.166
28	44.56 1.754	43.42 1.709	58	92.31 3.634	91.17 3.589	88	140.06 5.514	138.92 5.469	118	187.80 7.394	186.66 7.349	148	235.55 9.274	234.41 9.229
29	46.15 1.817	45.01 1.772	59	93.90 3.697	92.76 3.652	89	141.65 5.577	140.51 5.532	119	189.39 7.456	188.25 7.411	149	237.14 9.336	236.00 9.291
30	47.75 1.880	46.61 1.835	60	95.49 3.760	94.35 3.715	90	143.24 5.639	142.10 5.594	120	190.99 7.519	189.85 7.474	150	238.73 9.399	237.59 9.354
31	49.34 1.942	48.20 1.897	61	97.08 3.822	95.94 3.777	91	144.83 5.702	143.69 5.657	121	192.58 7.582	191.44 7.537	151	240.32 9.462	239.18 9.417
32	50.93 2.005	49.79 1.960	62	98.68 3.885	97.54 3.840	92	146.42 5.765	145.28 5.720	122	194.17 7.644	193.03 7.599	152	241.92 9.524	240.78 9.479
33	52.52 2.068	51.38 2.023	63	100.27 3.948	99.13 3.903	93	148.01 5.827	146.87 5.782	123	195.76 7.707	194.62 7.662	153	243.51 9.587	242.37 9.542
34	54.11 2.130	52.97 2.085	64	101.86 4.010	100.72 3.965	94	149.61 5.890	148.47 5.845	124	197.35 7.770	196.21 7.725	154	245.10 9.650	243.96 9.605
35	55.70 2.193	54.56 2.148	65	103.45 4.073	102.31 4.028	95	151.20 5.953	150.06 5.908	125	198.94 7.832	197.80 7.787	155	246.69 9.712	245.55 9.667
36	57.30 2.256	56.16 2.211	66	105.04 4.136	103.90 4.091	96	152.79 6.015	151.65 5.970	126	200.54 7.895	199.40 7.850	156	248.28 9.775	247.14 9.730
37	58.89 2.318	57.75 2.273	67	106.63 4.198	105.49 4.153	97	154.38 6.078	153.24 6.033	127	202.13 7.958	200.99 7.913	157	249.87 9.838	248.73 9.793
38	60.48 2.381	59.34 2.336	68	108.23 4.261	107.09 4.216	98	155.97 6.141	154.83 6.096	128	203.72 8.020	202.58 7.975	158	251.46 9.900	250.32 9.855
39	62.07 2.444	60.93 2.399	69	109.82 4.324	108.68 4.279	99	157.56 6.203	156.42 6.158	129	205.31 8.083	204.17 8.038	159	253.06 9.963	251.92 9.918
40	63.66 2.506	62.52 2.461	70	111.41 4.386	110.27 4.341	100	159.15 6.266	158.01 6.221	130	206.90 8.146	205.76 8.101	160	254.65 10.026	253.51 9.981
41	62.25 2.569	64.11 2.524	71	113.00 4.449	111.86 4.404	101	160.75 6.329	159.61 6.284	131	208.49 8.208	207.35 8.163			
42	66.85 2.632	65.71 2.587	72	114.59 4.511	113.45 4.466	102	162.34 6.391	161.20 6.346	132	210.08 8.271	208.94 8.226			

HTS® 8mm Sprocket Diameters

No. of Teeth	Diameters		No. of Teeth	Diameters		No. of Teeth	Diameters		No. of Teeth	Diameters		No. of Teeth	Diameters	
	PD	mm In. OD		PD	mm In. OD		PD	mm In. OD		PD	mm In. OD		PD	mm In. OD
22	56.02 2.206	54.66 2.152	57	145.15 5.715	143.78 5.660	92	234.28 9.223	232.90 9.169	127	323.41 12.733	322.03 12.678	162	412.53 16.241	411.16 16.187
23	58.57 2.306	57.20 2.252	58	147.70 5.815	146.32 5.761	93	236.82 9.324	235.45 9.270	128	325.95 12.833	324.58 12.779	163	415.08 16.342	413.70 16.288
24	61.12 2.406	59.74 2.352	59	150.24 5.915	148.87 5.861	94	239.37 9.424	238.00 9.370	129	328.50 12.933	327.12 12.879	164	417.62 16.442	416.25 16.388
25	63.66 2.506	62.28 2.452	60	152.79 6.015	151.42 5.961	95	241.92 9.524	240.54 9.470	130	331.04 13.033	329.67 12.979	165	420.17 16.542	418.8 16.488
26	66.21 2.607	64.85 2.553	61	155.34 6.116	153.96 6.062	96	244.46 9.624	243.09 9.570	131	333.59 13.133	332.22 13.079	166	422.72 16.642	421.34 16.588
27	68.75 2.707	67.39 2.653	62	157.88 6.216	156.51 6.162	97	247.01 9.725	245.64 9.671	132	336.14 13.234	334.76 13.180	167	425.26 16.743	423.89 16.689
28	71.30 2.807	70.08 2.759	63	160.43 6.316	159.06 6.262	98	249.55 9.825	248.18 9.771	133	338.68 13.334	337.31 13.280	168	427.81 16.843	426.44 16.789
29	73.85 2.907	72.62 2.859	64	162.97 6.416	161.60 6.362	99	252.10 9.925	250.73 9.871	134	341.23 13.434	339.86 13.380	169	430.35 16.943	428.98 16.889
30	76.39 3.008	75.13 2.958	65	165.52 6.517	164.15 6.463	100	254.65 10.025	253.28 9.971	135	343.77 13.534	342.40 13.480	170	432.90 17.043	431.53 16.989
31	78.94 3.108	77.65 3.057	66	168.07 6.617	166.70 6.563	101	257.19 10.126	255.82 10.072	136	346.32 13.635	344.95 13.581	171	435.45 17.144	434.08 17.090
32	81.49 3.208	80.16 3.156	67	170.61 6.717	169.24 6.663	102	259.74 10.226	258.37 10.172	137	348.87 13.735	347.50 13.681	172	437.99 17.244	436.62 17.190
33	84.03 3.308	82.68 3.255	68	173.16 6.817	171.79 6.763	103	262.29 10.326	260.92 10.272	138	351.41 13.835	350.04 13.781	173	440.54 17.344	439.17 17.290
34	86.58 3.409	85.22 3.355	69	175.71 6.918	174.34 6.864	104	264.83 10.427	263.46 10.372	139	353.96 13.935	352.59 13.881	174	443.09 17.444	441.72 17.390
35	89.13 3.509	87.76 3.455	70	178.25 7.018	176.88 6.964	105	267.38 10.527	266.01 10.473	140	356.51 14.036	355.14 13.982	175	445.63 17.544	444.26 17.491
36	91.67 3.609	90.30 3.555	71	180.80 7.118	179.43 7.064	106	269.93 10.628	268.56 10.573	141	359.05 14.136	357.68 14.082	176	448.18 17.645	446.81 17.591
37	94.22 3.709	92.85 3.655	72	183.35 7.218	181.97 7.164	107	272.47 10.728	271.10 10.673	142	361.60 14.236	360.23 14.182	177	450.73 17.745	449.36 17.691
38	96.77 3.810	95.39 3.756	73	185.89 7.319	184.52 7.265	108	275.02 10.828	273.65 10.771	143	364.15 14.336	362.77 14.282	178	453.27 17.845	451.90 17.791
39	99.31 3.910	97.94 3.856	74	188.44 7.419	187.07 7.365	109	277.57 10.928	276.19 10.874	144	366.69 14.437	365.32 14.383	179	455.82 17.946	454.45 17.892
40	101.86 4.010	100.49 3.956	75	190.99 7.519	189.61 7.465	110	280.11 11.028	278.74 10.974	145	369.24 14.537	367.87 14.483	180	458.37 18.046	456.99 17.992
41	104.41 4.110	103.03 4.056	76	193.53 7.619	192.16 7.565	111	282.66 11.128	281.29 11.074	146	371.79 14.637	370.41 14.583	181	460.91 18.146	459.54 18.092
42	106.95 4.211	105.58 4.157	77	196.08 7.720	194.71 7.666	112	285.21 11.229	283.83 11.175	147	374.33 14.737	372.96 14.683	182	463.46 18.246	462.09 18.192
43	109.50 4.311	108.13 4.257	78	198.63 7.820	197.25 7.766	113	287.75 11.329	286.38 11.275	148	376.88 14.838	375.51 14.784	183	466.01 18.347	464.63 18.293
44	112.05 4.411	110.67 4.357	79	201.17 7.920	199.81 7.866	114	290.30 11.429	288.93 11.375	149	379.43 14.938	378.05 14.884	184	468.55 18.447	467.18 18.393
45	114.59 4.511	113.22 4.457	80	203.72 8.020	202.35 7.966	115	292.85 11.529	291.47 11.475	150	381.97 15.038	380.60 14.984	185	471.10 18.547	469.73 18.493
46	117.14 4.612	115.77 4.558	81	206.26 8.121	204.89 8.067	116	295.39 11.630	294.02 11.576	151	384.52 15.138	383.15 15.084	186	473.65 18.647	472.27 18.593
47	119.68 4.712	118.31 4.658	82	208.81 8.221	207.44 8.167	117	297.94 11.730	296.57 11.676	152	387.06 15.239	385.70 15.185	187	476.19 18.748	474.82 18.694
48	122.23 4.812	120.86 4.758	83	211.36 8.321	209.99 8.267	118	300.48 11.830	299.11 11.776	153	389.61 15.339	388.24 15.285	188	478.74 18.848	477.37 18.794
49	124.78 4.912	123.41 4.858	84	213.90 8.421	212.53 8.367	119	303.03 11.930	301.66 11.876	154	392.16 15.439	390.79 15.385	189	481.28 18.948	479.91 18.894
50	127.32 5.013	125.95 4.959	85	216.45 8.522	215.08 8.468	120	305.58 12.031	304.21 11.977	155	394.70 15.540	393.33 15.486	190	483.83 19.048	482.46 18.994
51	129.87 5.113	128.50 5.059	86	219.00 8.622	217.63 8.568	121	308.12 12.131	306.75 12.077	156	397.25 15.640	395.88 15.586	191	486.38 19.149	485.01 19.095
52	132.42 5.213	131.05 5.159	87	221.54 8.722	220.17 8.668	122	310.67 12.231	309.30 12.177	157	399.80 15.740	398.43 15.686	192	488.92 19.249	487.55 19.195
53	134.96 5.314	133.59 5.259	88	224.09 8.822	222.72 8.768	123	313.22 12.331	311.85 12.227	158	402.34 15.840	400.97 15.786			
54	137.51 5.414	136.14 5.360	89	226.64 8.923	225.27 8.869	124	315.76 12.432	314.39 12.378	159	404.89 15.941	403.52 15.887			
55	140.06 5.514	138.68 5.460	90	229.18 9.023	227.81 8.969	125	318.31 12.532	316.94 12.478	160	407.44 16.041	406.07 15.987			
56	142.60 5.614	141.23 5.560	91	231.73 9.123	230.36 9.069	126	320.86 12.632	319.48 12.578	161	409.98 16.141	408.61 16.087			

PULLEYS



HTS® 14mm Sprocket Diameters

No. of Teeth	Diameters mm In.		No. of Teeth	Diameters mm In.		No. of Teeth	Diameters mm In.		No. of Teeth	Diameters mm In.		No. of Teeth	Diameters mm In.	
	PD	OD		PD	OD		PD	OD		PD	OD		PD	OD
28	124.78 4.912	122.12 4.808	66	294.12 11.579	291.32 11.469	104	463.46 18.246	460.66 18.136	142	632.80 24.913	630.01 24.803	180	802.14 31.580	799.35 31.47
29	129.23 5.088	126.57 4.983	67	298.57 11.755	295.78 11.645	105	467.92 18.422	465.12 18.312	143	637.26 25.089	634.46 24.979	181	806.60 31.756	803.80 31.646
30	133.69 5.263	130.99 5.157	68	303.03 11.930	300.24 11.820	106	472.37 18.597	469.58 18.487	144	641.71 25.264	638.92 25.154	182	811.05 31.931	808.26 31.821
31	138.15 5.439	135.46 5.333	69	307.49 12.106	304.69 11.996	107	476.83 18.773	474.03 18.663	145	646.17 25.440	643.37 25.330	183	815.51 32.107	812.72 31.997
32	142.60 5.614	139.88 5.507	70	311.94 12.281	309.15 12.171	108	481.28 18.948	478.49 18.838	146	650.63 25.615	647.83 25.505	184	819.97 32.252	817.17 32.172
33	147.06 5.790	144.35 5.683	71	316.40 12.457	313.61 12.347	109	485.74 19.124	482.95 19.014	147	655.08 25.791	652.29 25.681	185	824.42 32.458	821.63 32.348
34	151.52 5.965	148.79 5.858	72	320.86 12.632	318.06 12.522	110	490.20 19.299	487.40 19.189	148	659.54 25.966	656.74 25.856	186	828.88 32.633	826.08 32.523
35	155.98 6.141	153.24 6.033	73	325.31 12.808	322.52 12.698	111	494.65 19.475	491.86 19.365	149	663.99 26.141	661.20 26.031	187	833.33 32.808	830.54 32.698
36	160.43 6.316	157.68 6.208	74	329.77 12.983	326.97 12.873	112	499.11 19.650	496.32 19.540	150	668.45 26.317	665.66 26.207	188	837.79 32.954	835.00 32.874
37	164.88 6.491	162.13 6.383	75	334.22 13.158	331.43 13.048	113	503.57 19.825	500.77 19.715	151	672.91 26.492	670.11 26.382	189	842.25 33.159	839.45 33.049
38	169.34 6.667	166.60 6.559	76	338.68 13.334	335.89 13.224	114	508.20 20.001	505.23 19.891	152	677.36 26.668	674.57 26.558	190	846.70 33.335	843.91 33.225
39	173.80 6.842	171.02 6.733	77	343.14 13.509	340.34 13.399	115	512.48 20.176	509.68 20.066	153	681.82 26.843	679.03 26.733	191	851.16 33.510	848.37 33.400
40	178.25 7.018	175.49 6.909	78	347.59 13.685	344.80 13.575	116	516.93 20.352	514.14 20.242	154	690.73 27.194	687.94 27.084	192	855.62 33.686	852.82 33.576
41	182.71 7.193	179.92 7.083	79	352.05 13.860	349.26 13.750	117	521.39 20.527	518.60 20.417	155	690.73 27.194	687.94 27.084	193	860.07 33.861	857.28 33.751
42	187.17 7.369	184.37 7.259	80	356.51 14.036	353.71 13.926	118	525.85 20.703	523.05 20.593	156	695.19 27.370	692.39 27.260	194	864.53 34.037	861.75 33.927
43	191.62 7.544	188.83 7.434	81	360.96 14.211	358.17 14.101	119	530.30 20.878	527.51 20.768	157	699.64 27.545	696.85 27.435	195	868.98 34.212	866.44 34.112
44	196.08 7.720	193.28 7.610	82	365.42 14.387	362.63 14.277	120	534.76 21.054	531.97 20.944	158	704.10 27.720	701.31 27.610	196	873.44 34.387	870.64 34.277
45	200.53 7.895	197.74 7.785	83	369.88 14.562	367.08 14.452	121	539.22 21.229	536.42 21.119	159	708.56 27.896	705.76 27.786	197	877.90 34.553	875.11 34.453
46	204.99 8.071	202.20 7.961	84	374.33 14.737	371.54 14.627	122	543.67 21.404	540.88 21.294	160	713.01 28.071	710.22 27.961	198	882.35 34.738	879.55 34.628
47	209.45 8.246	206.65 8.136	85	378.79 14.913	375.99 14.803	123	548.13 21.580	545.34 21.470	161	717.47 28.247	714.68 28.137	199	886.81 34.914	884.02 34.804
48	213.90 8.421	211.11 8.311	86	383.24 15.068	380.45 14.978	124	552.59 21.755	549.79 21.645	162	721.93 28.422	719.13 28.312	200	891.27 35.089	888.47 34.979
49	218.36 8.597	215.57 8.487	87	387.70 15.264	384.91 15.154	125	557.04 21.931	554.25 21.821	163	726.38 28.598	723.59 28.488	201	895.72 35.265	892.94 35.155
50	222.82 8.772	220.02 8.662	88	392.16 15.439	389.36 15.329	126	561.50 22.106	558.70 21.996	164	730.84 28.773	728.05 28.663	202	900.18 35.440	897.38 35.330
51	227.27 8.948	224.48 8.838	89	396.61 15.615	393.82 15.505	127	565.95 22.282	563.16 22.172	165	735.30 28.949	732.50 28.839	203	906.64 35.616	901.85 35.506
52	231.73 9.123	228.94 9.013	90	401.07 15.790	398.28 15.680	128	570.41 22.457	567.62 22.347	166	739.75 29.124	736.96 29.014	204	909.09 35.791	906.30 35.681
53	236.19 9.299	233.39 9.189	91	405.53 15.966	402.73 15.856	129	574.87 22.633	572.07 22.523	167	744.21 29.299	741.41 29.189	205	913.55 35.966	910.74 35.856
54	240.64 9.474	237.85 9.354	92	409.98 16.141	407.19 16.031	130	579.32 22.808	576.53 22.689	168	748.66 29.475	745.87 29.365	206	918.00 36.142	915.21 36.032
55	245.10 9.650	242.30 9.540	93	414.44 16.316	411.64 16.206	131	583.78 22.983	580.99 22.873	169	753.12 29.650	750.33 29.540	207	922.46 36.317	919.66 36.207
56	249.55 9.825	246.76 9.715	94	418.90 16.492	416.10 16.382	132	588.24 23.159	585.44 23.049	170	757.58 29.826	754.78 29.716	208	926.92 36.493	924.13 36.383
57	254.01 10.000	251.22 9.890	95	423.35 16.667	420.56 16.557	133	592.69 23.334	589.90 23.224	171	762.03 30.001	759.24 29.891	209	931.97 36.668	928.57 36.558
58	258.47 10.176	255.67 10.066	96	427.81 16.843	425.01 16.733	134	597.15 23.510	594.35 23.400	172	766.49 30.177	763.70 30.067	210	936.83 36.844	933.04 36.734
59	262.92 10.351	260.13 10.241	97	432.26 17.018	429.47 16.908	135	601.61 23.685	598.81 23.575	173	770.95 30.352	768.15 3.242	211	940.29 37.019	937.49 36.909
60	267.38 10.527	264.59 10.417	98	436.72 17.194	433.93 17.084	136	606.06 23.861	603.27 23.751	174	775.40 30.528	772.61 30.418	212	944.74 37.195	941.96 37.085
61	271.84 10.702	269.04 10.592	99	441.18 17.369	438.38 17.259	137	610.52 24.036	607.72 23.926	175	779.86 30.703	777.06 30.593	213	949.20 37.370	946.40 37.260
62	276.29 10.878	273.50 10.768	100	445.63 17.545	442.84 17.435	138	614.97 24.212	612.18 24.102	176	784.32 30.878	781.52 30.768	214	953.65 37.545	950.85 37.435
63	280.75 11.053	277.95 10.943	101	450.09 17.720	447.30 17.610	139	619.43 24.387	616.64 24.277	177	788.77 31.054	785.98 30.944	215	958.11 37.721	955.32 37.611
64	285.21 11.229	282.41 11.119	102	454.55 17.895	451.75 17.785	140	623.89 24.562	621.09 24.452	178	793.23 31.228	790.43 31.119	216	962.57 37.896	959.76 37.786
65	289.66 11.404	286.87 11.294	103	459.00 18.071	456.21 17.961	141	628.34 24.738	625.55 24.628	179	797.68 31.405	794.89 31.295			

PULLEYS

HTS® 20mm Sprocket Diameters

No. of Teeth	Diameters		No. of Teeth	Diameters		No. of Teeth	Diameters		No. of Teeth	Diameters		No. of Teeth	Diameters	
	PD	mm In.		PD	mm In.		PD	mm In.		PD	mm In.		PD	mm In.
34	216.45 8.522	212.13 8.352	71	452.00 17.795	447.68 17.625	108	687.55 27.069	683.23 26.899	145	923.10 36.342	918.78 36.172	182	1158.65 45.616	1154.33 45.446
35	222.82 8.772	218.50 8.602	72	458.37 18.046	454.05 17.876	109	693.92 27.320	689.60 27.150	146	929.46 36.593	925.15 36.423	183	1165.01 45.867	1160.70 45.697
36	229.18 9.023	224.87 8.853	73	464.73 18.297	460.41 18.127	110	700.28 27.570	695.96 27.400	147	935.83 36.840	931.51 36.674	184	1171.38 46.117	1167.06 45.947
37	235.55 9.274	231.23 9.104	74	471.10 18.547	466.78 18.377	111	706.65 27.821	702.33 27.651	148	942.20 37.094	937.88 36.924	185	1177.75 46.368	1173.43 46.198
38	241.92 9.524	237.60 9.354	75	477.46 18.798	473.15 18.628	112	713.01 28.071	708.70 27.901	149	948.56 37.345	944.25 37.175	186	1184.11 46.619	1179.79 46.449
39	248.28 9.775	243.96 9.605	76	483.83 19.048	479.51 18.878	113	719.38 28.322	715.06 28.152	150	954.93 37.596	950.61 37.426	187	1190.48 46.859	1186.16 46.699
40	254.65 10.026	250.33 9.855	77	490.20 19.299	485.88 19.129	114	725.75 28.573	721.43 28.403	151	961.30 37.846	956.98 37.676	188	1196.85 47.120	1192.53 46.950
41	261.01 10.276	256.70 10.106	78	496.56 19.550	492.25 19.380	115	732.11 28.823	727.79 28.653	152	967.66 38.097	963.34 37.927	189	1203.21 47.371	1198.89 47.201
42	267.38 10.527	263.06 10.357	79	502.93 19.800	498.61 19.630	116	738.48 29.074	734.16 28.904	153	974.03 38.348	969.71 38.178	190	1209.58 47.621	1205.26 47.451
43	273.75 10.777	269.43 10.607	80	509.30 20.051	504.98 19.881	117	744.85 29.325	740.53 29.155	154	980.39 38.598	976.08 38.428	191	1215.94 47.672	1211.63 47.702
44	280.11 11.028	275.79 10.858	81	515.66 20.302	511.34 20.132	118	751.21 29.575	746.89 29.405	155	986.76 38.849	982.44 38.679	192	1222.31 48.122	1217.99 47.952
45	286.48 11.279	282.16 11.109	82	522.03 20.552	517.71 20.382	119	757.58 29.826	753.26 29.656	156	993.13 39.099	988.81 38.929	193	1228.68 48.373	1224.36 48.203
46	292.85 11.529	288.53 11.469	83	528.39 20.803	524.08 20.633	120	763.94 30.077	759.63 29.907	157	999.49 39.350	995.18 39.180	194	1235.04 48.624	1230.72 48.454
47	299.21 11.780	294.89 11.610	84	534.76 21.054	530.44 20.884	121	770.31 30.327	765.99 30.157	158	1005.86 39.601	1001.54 39.431	195	1241.41 48.874	1237.09 48.704
48	305.58 12.031	301.26 11.861	85	541.13 21.304	536.81 21.134	122	776.68 30.578	772.36 30.408	159	1012.23 39.851	1007.91 39.681	196	1247.77 49.125	1243.46 48.955
49	311.94 12.281	307.63 12.111	86	547.49 21.555	543.18 21.385	123	783.04 30.828	778.72 30.658	160	1018.59 40.102	1014.27 39.932	197	1254.14 49.376	1249.82 49.206
50	318.31 12.532	313.99 12.362	87	553.86 21.805	549.54 21.635	124	789.41 31.079	785.09 30.909	161	1024.96 40.353	1020.64 40.183	198	1260.51 49.626	1256.19 49.456
51	324.68 12.763	320.36 12.613	88	560.23 22.056	555.91 21.886	125	795.77 31.330	791.46 31.160	162	1031.32 40.603	1027.01 40.433	199	1266.87 49.877	1262.56 49.707
52	331.04 13.033	326.72 12.863	89	566.59 22.307	562.27 22.137	126	805.14 31.580	797.82 31.410	163	1037.69 40.854	1033.37 40.684	200	1273.24 50.128	1268.92 49.958
53	337.41 13.284	333.09 13.114	90	572.96 22.557	568.64 22.387	127	808.51 31.831	804.19 31.661	164	1044.06 41.105	1039.74 40.935	201	1279.61 50.378	1275.29 50.208
54	343.77 13.534	339.46 13.364	91	579.32 22.808	575.01 22.638	128	814.87 32.082	810.56 31.912	165	1050.42 41.355	1046.10 41.185	202	1285.97 50.629	1281.65 50.459
55	350.14 13.785	345.82 13.615	92	585.69 23.059	581.37 22.889	129	821.24 32.332	816.92 32.162	166	1056.79 41.606	1052.47 41.436	203	1292.34 50.679	1288.02 50.709
56	356.51 14.036	352.19 13.856	93	592.06 23.309	587.74 23.139	130	827.61 32.583	823.29 32.413	167	1063.16 41.856	1058.34 41.686	204	1298.70 51.130	1294.39 50.960
57	362.87 14.286	358.56 14.116	94	598.42 23.560	594.10 23.390	131	833.97 32.834	829.65 32.664	168	1069.52 42.107	1065.20 41.937	205	1305.07 51.381	1300.75 51.211
58	369.24 14.537	364.92 14.367	95	604.72 23.811	600.47 23.641	132	840.34 33.084	836.02 32.914	169	1075.89 42.358	1071.57 42.188	206	1311.44 51.631	1307.12 51.461
59	375.61 14.788	371.29 14.618	96	611.15 24.061	606.84 23.891	133	846.70 33.335	842.39 33.165	170	1082.25 42.608	1077.94 42.438	207	1317.80 51.882	1313.48 51.712
60	381.97 15.038	377.65 14.868	97	617.52 24.312	613.20 24.142	134	853.07 33.585	848.75 33.415	171	1088.62 42.859	1084.30 42.689	208	1324.17 52.133	1319.85 51.963
61	388.34 15.289	384.02 15.119	98	623.89 24.562	619.57 24.392	135	859.44 33.836	855.12 33.666	172	1094.99 43.110	1090.67 42.940	209	1330.54 52.383	1326.22 52.213
62	394.70 15.540	390.39 15.370	99	630.25 24.813	625.94 24.643	136	865.80 34.087	861.48 33.917	173	1101.35 43.350	1097.03 43.190	210	1336.90 52.634	1332.58 52.464
63	401.07 15.790	396.75 15.620	100	636.62 25.064	632.30 24.894	137	872.17 34.337	867.85 34.167	174	1107.72 43.611	1103.40 43.441	211	1343.27 52.885	1338.95 52.715
64	407.44 16.041	403.12 15.871	101	642.99 25.314	638.67 25.144	138	878.54 34.588	874.22 34.418	175	1114.08 43.862	1109.77 43.692	212	1349.63 53.135	1345.32 52.965
65	413.80 16.291	409.48 16.121	102	649.35 25.565	645.03 25.395	139	884.90 34.839	880.58 34.669	176	1120.45 44.112	1116.13 43.942	213	1356.00 53.386	1351.68 53.216
66	420.17 16.542	415.85 16.372	103	655.72 25.816	651.40 25.646	140	891.27 35.089	886.95 34.919	177	1126.82 44.363	1122.50 44.193	214	1362.37 53.635	1358.05 53.456
67	426.54 16.793	422.22 16.623	104	662.08 26.066	657.77 25.896	141	897.63 35.340	893.32 35.170	178	1133.18 44.614	1128.87 44.444	215	1368.73 53.887	1364.41 53.717
68	432.90 17.043	428.58 16.873	105	668.45 26.317	664.13 26.147	142	904.00 35.591	899.68 35.421	179	1139.55 44.854	1135.23 44.694	216	1375.10 54.136	1370.79 53.958
69	439.27 17.299	434.95 17.124	106	674.82 26.568	670.50 26.398	143	910.37 35.841	906.05 35.671	180	1145.92 45.115	1141.60 44.945			
70	445.63 17.545	441.32 17.375	107	681.18 26.818	676.87 26.648	144	916.73 36.092	912.41 35.922	181	1152.28 45.365	1147.96 45.195			

PULLEYS



HTS DRIVE SELECTION BASED ON RPP® and RPP® PLUS BELT RATINGS

The selection of a stock RPP® and RPP® PLUS Belt Drive involves these simple steps:

- Step 1.** Determine service factor and calculate design horsepower.
- Step 2.** Select pitch using belt pitch selection guide.
- Step 3.** Select drive using pre-engineered drive tables.
- Step 4.** Determine drive width.
- Step 5.** Specify drive components: sprockets, bushings and belts.

To illustrate the design procedure, the following sample problem will be solved simultaneously with the instructions for each step.

Sample Problem

A gear pump is to be driven by 40 HP NEMA, Type B, electric motor with an output speed of 1160 rpm. The gear pump is to be driven at 580 rpm +5%. The center distance is desired to approximately 30 inches, but can be altered +3 inches, if necessary. The motor shaft is 2 3/8 inches and the pump shaft is 3 inches. The pump will operate 2 shifts per day, 5 days per week. The pump sprocket is limited to 18 inches OD. There are no unusual drive conditions.

STEP 1. Determine Design Horsepower

PROCEDURE

To calculate the design HP, it is necessary to determine a service factor based on the power source, driven machine and the type duty required. To choose the service factor, first determine the driver classification for the prime mover. Now find the driven machine type for the application. If your specific application is not listed, choose one with similar load characteristics.

For speed-up drives, an additional service factor must be applied. This add-on factor is dependent upon drive ratio. Refer to table 1c for additional service factors.

To find the design HP, multiply the service factor by the motor nameplate rating or by the brake horsepower developed if an engine is being used.

EXAMPLE

Using Table 1a on page K-90, we find the 1160 rpm 40 HP, NEMA B, motor fall in Class II. Referring to the Class II column in Table 1b, it will be noted that the gear pump has a service factor of 1.4.

Since the pump will run 2 shifts a day, we then add 0.2 from Table 1c to 1.4 for a total service factor of 1.6.

$$\text{Rated HP} \times \text{Service factor} = \text{Design HP}$$
$$40 \times 1.6 = 64\text{HP}$$

STEP 2. Select Belt Pitch

PROCEDURE

Using the design HP calculated above and the rpm of the smaller sprocket; select from the "Belt Pitch Selection Guide" on page K-91 the belt pitch best suited for the application. If the drive falls into two pitches it is usually a good idea to check both pitches, starting with the lighter one.

EXAMPLE

Find 1160 rpm on the horizontal scale and move up to 64 design HP on the vertical scale. The intersection falls into the 14mm pitch area.

Basic Service Factors



To find a basic service factor: First, determine the class of the driveR (prime mover) in table 1a. Then, determine the basic service factor for the application in table 1b - in the same class as the driveR.

1a: driveR (prime mover)

Class of driveR	Class I	Class II	Class III
Momentary Peak Load, % of Rated Load	149%	150 to 249%	250 to 400%
AC Electric Motors:			
Single Phase Squirrel Cage			all
NEMA design A			
3600 rpm	40 HP up	1-1/2 thru 30 HP	1 thru 3 HP
1800 rpm	100 HP up	5 thru 75 HP	
1200 rpm	15 HP up	3/4 thru 10HP	
900 rpm	5 HP up	1/2 thru 3 HP	
NEMA design B			
3600 rpm		5 HP up	1 1/2 thru 3 HP
1800 rpm		5 HP up	1 thru 3 HP
1200 rpm		5 HP up	3/4 thru 3 HP
900 rpm		2 HP up	1 1/2 thru 1 1/2 HP
NEMA design C			
1800 rpm		15 HP up	5 thru 10 HP
1200 rpm		7-1/2 HP up	3 and 5 HP
900 rpm		all	
NEMA design D			all
NEMA design F	all		
Wound Rotor			
1800 rpm		20 HP	2 to 15 HP
1200 rpm		15 HP	2 to 10HP
900 rpm		7-1/2 HP	1 to 5HP
Synchronous		normal torque	high torque
DC Electric Motors	shunt	compound	series
Engines — int combust	8 cyl up	6 cyl	4 cyl or less
Hydraulic Motors,			
Line Shafts			all

1c: Additional Service Factors

Operating Conditions

Intermittent or Seasonal	Sub 0.1
Add for 10-16 hr. service	Add 0.2
Add for 16-24 hr. service	Add 0.4
Add for each idler	Add 0.2

Speed-Up Drives

For speed-up drives, add to the basic service factor the additional factor given below.

Speed-up Ratio range	Additional Factor	Speed-up Ratio Range	Additional Factor
1 to 1.24	none	2.50 to 3.49	.30
1.25 to 1.74	.10	3.50 & over	.40
1.75 to 2.49	.20		

Unusual Conditions

Additional service factors are required for unusual conditions - such as load reversal, heavy shock, plugged motor stop, electric brake. These should be determined by a transmission specialist.

1b: Basic Service factors of driveN Machines

driveN Machines	Class I	Class II	Class III
Agitators, Mixers			
liquid	1.2	1.4	1.6
(paddle or propeller) semi-liquid	1.3	1.5	1.7
Bakery Machinery, Dough Mixers	1.2	1.4	1.6
Brick and Clay Machinery			
augers, mixers, granulators	1.4	1.6	1.8
pug mills	1.6	1.8	2.0
Centrifuges	1.5	1.7	—
Compressors			
reciprocating*	1.6	1.8	2.0
centrifugal	1.4	1.5	1.6
Conveyors			
belt, light package, oven	1.1	1.2	1.3
belt: ore, coal, sand	1.2	1.4	1.6
apron, bucket, elevator, pan	1.4	1.6	1.8
flight, screw	1.4	1.6	1.8
Fans, blowers			
Centrifugal, induced	1.4	1.6	1.8
draft exhausters			
propeller, mine fans,			
positive blowers			
Generators and Exciters	1.4	1.6	1.8
Hammer Mills	1.5	1.7	1.9
Hoists, Elevators	1.4	1.6	1.8
Laundry Machinery			
general	1.2	1.4	1.6
extractors, washers	1.4	1.6	1.8
Line Shafts	1.2	1.4	1.6
Machine Tools			
drill presses,	1.2	1.4	1.6
lathes, screw machines			
boring mills, grinders			
milling machines, shapers			
Mills			
ball, rod, pebble, etc.	—	1.9	2.1
Paper Machinery			
agitators, calendars, dryers	1.2	1.4	1.6
beaters, jordans, Nash pumps	1.4	1.6	1.8
pulpers			
Printing Machinery			
presses, newspaper, rotary,	1.2	1.4	1.6
embossing, flat bed, magazine;			
linotype machines; cutters; folders			
Pumps			
centrifugal, gear, rotary, pipeline	1.2	1.4	1.6
reciprocating*	1.7	1.9	2.1
Rubber Plant Machinery	1.4	1.6	1.8
Saw Mill Machinery	1.4	1.6	1.8
Screens			
vibrating (shakers)	1.3	1.5	—
drum, conical	1.2	1.4	—
Textile Machinery			
looms, spinning frames, twisters	1.3	1.5	1.7
warpers, reels	1.2	1.4	—
Woodworking Machinery			
lathes, band saws	1.2	1.3	—
jointer, circular saws, planers	1.2	1.4	—

*Note: When the driveN sprocket is used as a flywheel to reduce speed fluctuations, a specially constructed sprocket may be required. Consult *Martin* with the WR2 of the unit.

5MM PITCH

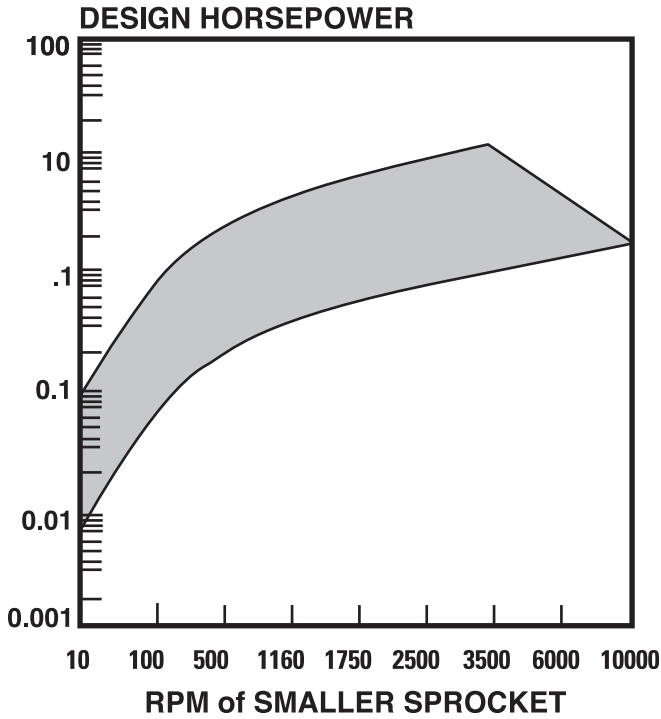

8MM PITCH

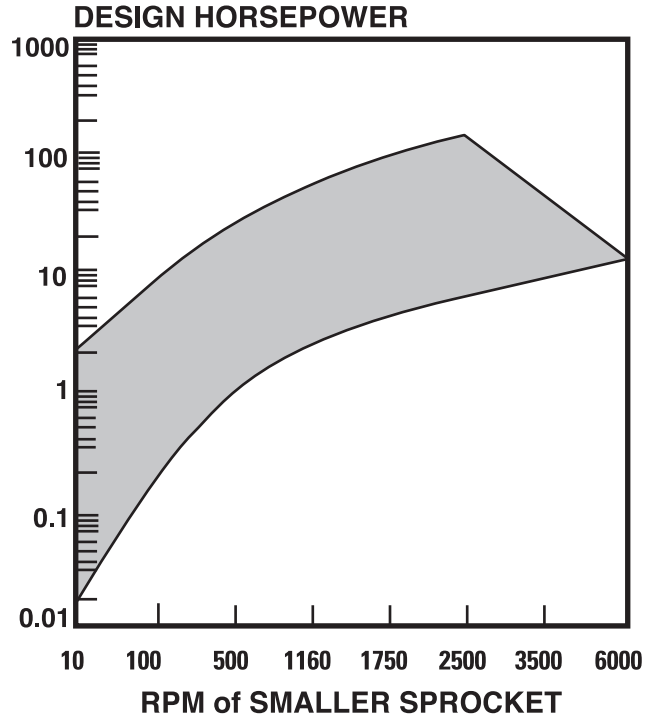

14MM PITCH

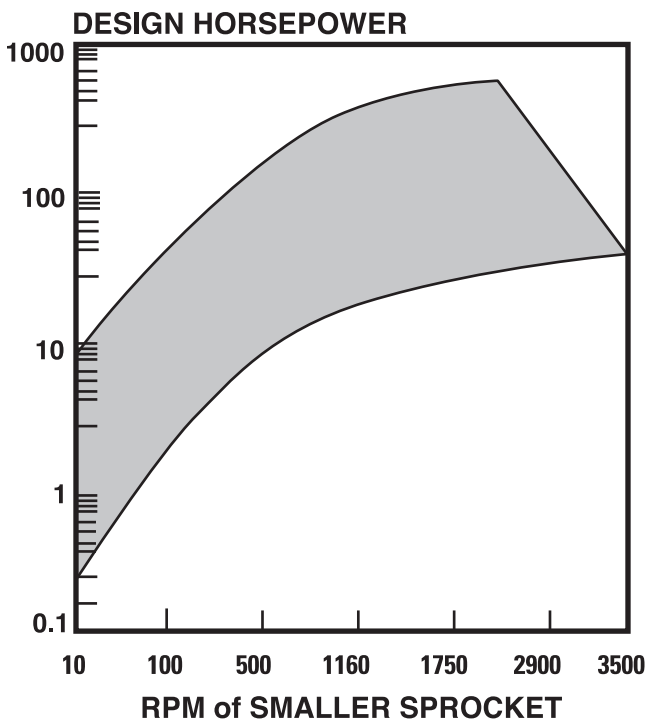

20MM PITCH

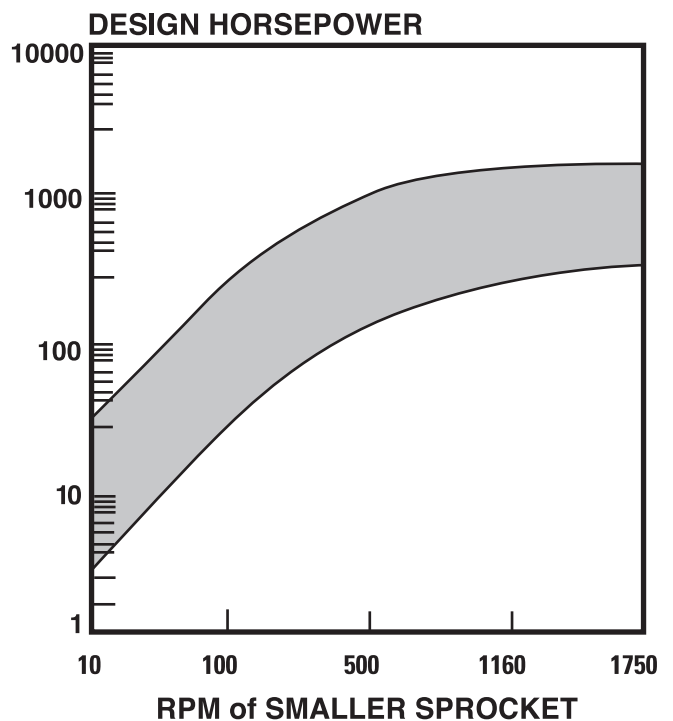

HTS® Drive Selection Procedure



STEP 3. Select Sprocket and Belt Length

PROCEDURE

- a.** Determine speed ratio:
The speed ratio can be determined by any of the following methods.
1. Divide the rpm of the faster shaft by the slower shaft.
 2. Divide the large sprocket diameter by the small sprocket diameter.
 3. Divide the number of teeth of the large sprocket by the number of teeth of the small sprocket.
- b.** Select sprocket combination: turn to the Stock Drive Selection Tables (pages K-94 to K-149) and run down the left hand margin. Moving over within the selected speed ratio block we find the stock sprocket combinations available within this speed ratio. Selection will depend on the center distance required as well as the recommended minimum sprocket diameter for electric motors (see table below).
- c.** After selecting possible sprocket combinations which meet the center distance requirements, select the belt length required by proceeding up the column containing the center distance selected. At the top of the column will be the belt length code designation that will produce that center distance on that particular sprocket combination. Record the length factor given at the top or bottom of the table.

EXAMPLE

$$\text{a. } \frac{\text{rpm of faster shaft}}{\text{rpm of slower shaft}} = \frac{1160}{580} = 2.0$$

Desired ratio if 2.0 to 1

b. Using the Stock Drive Selection Tables for 14mm pitch and 1160 rpm drivers on pages K-132 to K-141, locate the drive ratio of 2.0. Eight combinations are shown on page K-126, all of which will meet the 30 + in. center distance desired. The maximum OD limit of 18 in. on the driveN sprocket and the minimum motor diameter of 6.1 eliminates four of the combinations; and the preference for as close to the 30 in. center distance as possible would favor the 36 to 72. The choice becomes a matter of economics or space. Larger sprockets require a smaller belt width for a given horsepower rating and also means less shaft loading. Although this usually gives a longer belt flex life the drive may have a higher initial cost.

c. Moving up the column in which the center distance appears, we find the 36 to 72 drive will use a 2310mm belt. The length factor in this case is 1.0.

Minimum Recommended Sprocket Pitch Diameters for General Purpose Electric Motors Synchronous Belts

Motor Horsepower	Motor Rpm (60 Cycle and 50 Cycle Electric Motors)					
	575 485*	690 575*	870 725*	1160 950*	1750 1425*	3450 2850*
1/2	—	—	2.0	—	—	—
3/4	—	—	2.2	2.0	—	—
1	2.7	2.3	2.2	2.2	2.0	—
1 1/2	2.7	2.7	2.2	2.2	2.2	2.0
2	3.4	2.7	2.7	2.2	2.2	2.2
3	4.1	3.4	2.7	2.7	2.2	2.2
5	4.1	4.1	3.4	2.7	2.7	2.2
7 1/2	4.7	4.1	4.0	3.4	2.7	2.7
10	5.4	4.7	4.0	4.0	3.4	2.7
15	6.1	5.4	4.7	4.0	4.0	3.4
20	7.4	6.1	5.4	4.7	4.0	4.0
25	8.1	7.4	6.1	5.4	4.0	4.0
30	9.0	8.1	6.1	6.1	4.7	—
40	9.0	9.0	7.4	6.1	5.4	—
50	9.9	9.0	7.6	7.4	6.1	—
60	10.8	9.9	9.0	7.2	6.7	—
75	12.6	11.7	8.6	9.0	7.7	—
100	16.2	13.5	10.8	9.0	7.7	—
125	18.0	16.2	13.5	10.8	9.5	—
150	19.8	18.0	16.2	11.7	9.5	—
200	19.8	19.8	19.8	—	11.9	—
250	19.8	19.8	—	—	—	—
300	24.3	24.3	—	—	—	—

*Indicates 50 cycle RPM electric motors. #Frame 444T use 8.6

Data in the white area is from NEMA Standard MG-1-14-42 of June 1972 and MG-1-14-43 of January, 1968.

The data in the shaded area is a composite of various motor manufacturers data. They are usually conservative, and a smaller sprocket may be permitted. Consult the motor manufacturer data.

STEP 4. Select Belt Width

PROCEDURE

The stock drive selection tables on pages K-94 to K-149 list the horsepower ratings for the various stock belt widths.

To select the proper belt width, find the drive ratio required in the left-hand column. Read across to the appropriate motor rpm (1160 or 1750) and find a horsepower rating equal to or larger than the design horsepower of the drive. Keep in mind that the indicated horsepower rating must be corrected by multiplying it by the length factor, which is in the screened band above and below the center distances (length factors under 1.0 reduce the belt capacity while length factors over 1.0 increase the belt capacity). If the corrected horsepower capacity is equal to or exceeds the design hp, that belt width can be used. If it doesn't exceed the design horsepower, the next larger belt should be used.

Where there are several choices, as in this sample problem, drive limitations will generally control the choice. In addition, the following rules should be followed.

1. The larger the sprocket, the less belt width required.
2. Larger sprockets allow less strenuous flexing and, therefore, give better service life.
3. Avoid drives where the belt widths exceed sprocket diameter.
4. Larger sprockets mean lower shaft pull.

STEP 5. Check and Specify Stock Drive Components

PROCEDURE

- a. Check Sprockets Selected:
Check the sprockets selected in steps 3 and 4 against the design requirements using the dimensions given in the Sprocket Specification Tables on pages K-73 to K-84. Use flange diameter in checking against maximum diameter requirements.
- b. Determine Bushing Type and Check Bore Sizes.
Using the Sprocket Specification Tables, find the bushings to be used with the required sprockets.
- c. Specify stock drive components.

Safety Note WARNING!

FAILURE TO FOLLOW RECOMMENDED APPLICATION INFORMATION AND RECOMMENDED PROCEDURES FOR INSTALLATION, CARE, MAINTENANCE AND STORAGE OF BELTS MAY RESULT IN FAILURE TO PERFORM PROPERLY AND MAY RESULT IN DAMAGE TO PROPERTY AND SERIOUS BODILY INJURY. MAKE SURE THAT BELTS SELECTED FOR ANY APPLICATION ARE RECOMMENDED FOR THAT SERVICE.

EXAMPLE

Refer to the 14mm belt selection tables and locate the 2.00 drive ratio line. According to step 3c, the 36 to 72 tooth combination could be used. Read across the 36 to 72 combination until you reach 88 hp (RPP-85). This horsepower which exceeds the design hp of the drive is located in the 85mm belt width column.

The recommended drive would be as follows:

DriveR sprocket: P3614M85-(SF or 3020)
 DriveN sprocket: P7214M85-(F or 3535)
 Belt: 2310-14M-85

EXAMPLE

From the table on page K80, we find the P7214M85 (QD or TB)driveN sprocket, to have a maximum diameter over the flanges of 13.19 in. This is less than the 18 in. maximum specified.

And, from the table on page K-82, we find that there is no sprocket P2814M170 available, so the final choice will be the 36 to 72 speed ratio sprockets.

DriveR- Either P3614M85-SF or P3614M85-3020

Both choices will satisfy the 2-3/8" bore requirement.

DriveN-P7214M85-F or P7214M85-3535

Again, both choices will satisfy the 3" bore requirement. Choosing a QD bushed drive,

Stock drive components are as follows:

- 1 - 2310-14M-85-R RPPtm Belt
- 1 - P3614M85-SF Sprocket
- 1 - SF bushing with 2 3/8-inch bore
- 1 - P7214M85-F Sprocket
- 1 - F bushing with 3-inch bore

HTS® 5 mm Drive Selection Tables



Drive Ratio	Sprocket Combination				Driven Speeds and Horsepower Ratings								
	Driver		Driven		1160 RPM Driver			1750 RPM Driver			3550 RPM Driver		
	No. Teeth	P.D.	No. Teeth	P.D.	Driven Speed	HP for Belt Widths		Driven Speed	HP for Belt Widths		Driven Speed	HP for Belt Widths	
						15	25		15	25		15	25
Multiply hp rating by belt length factor to determine drive width—BELT LENGTH FACTOR →													
1.00	14	.877	14	.877	1160	0.47	...	1750	0.62	...	3550	1.02	...
1.00	16	1.003	16	1.003	1160	0.55	0.99	1750	0.73	1.32	3550	1.19	2.15
1.00	18	1.128	18	1.128	1160	0.63	1.14	1750	0.84	1.52	3550	1.37	2.47
1.00	20	1.253	20	1.253	1160	0.72	1.29	1750	0.95	1.72	3550	1.55	2.80
1.00	24	1.504	24	1.504	1160	0.89	1.61	1750	1.19	2.14	3550	1.92	3.46
1.00	28	1.754	28	1.754	1160	1.07	1.93	1750	1.43	2.57	3550	2.30	4.15
1.00	30	1.880	30	1.880	1160	1.16	2.10	1750	1.55	2.79	3550	2.49	4.49
1.00	32	2.005	32	2.005	1160	1.26	2.27	1750	1.67	3.01	3550	2.68	4.84
1.00	34	2.130	34	2.130	1160	1.35	2.44	1750	1.80	3.24	3550	2.88	5.19
1.00	36	2.256	36	2.256	1160	1.45	2.61	1750	1.92	3.47	3550	3.07	5.54
1.00	38	2.381	38	2.381	1160	1.54	2.79	1750	2.05	3.70	3550	3.27	5.89
1.00	40	2.506	40	2.506	1160	1.64	2.96	1750	2.18	3.93	3550	3.46	6.24
1.00	44	2.757	44	2.757	1160	1.84	3.32	1750	2.44	4.40	3550	3.85	6.94
1.00	48	3.008	48	3.008	1160	2.04	3.68	1750	2.70	4.88	3550	4.24	7.64
1.00	52	3.258	52	3.258	1160	2.25	4.05	1750	2.97	5.36	3550	4.62	8.33
1.00	56	3.509	56	3.509	1160	2.45	4.42	1750	3.24	5.85	3550	5.00	9.02
1.00	60	3.760	60	3.760	1160	2.66	4.80	1750	3.52	6.34	3550	5.37	9.69
1.00	64	4.010	64	4.010	1160	2.88	5.18	1750	3.79	6.83	3550	5.74	10.40
1.00	68	4.261	68	4.261	1160	3.09	5.57	1750	4.07	7.33	3550	6.10	11.00
1.00	72	4.511	72	4.511	1160	3.31	5.96	1750	4.35	7.84	3550	6.45	11.60
1.05	38	2.381	40	2.506	1102	1.54	2.79	1663	2.05	3.70	3373	3.27	5.89
1.06	36	2.256	38	2.381	1099	1.45	2.61	1658	1.92	3.47	3363	3.07	5.54
1.06	34	2.130	36	2.256	1096	1.35	2.44	1653	1.80	3.24	3353	2.88	5.19
1.06	68	4.261	72	4.511	1096	3.09	5.57	1653	4.07	7.33	3353	6.10	11.00
1.06	32	2.005	34	2.130	1092	1.26	2.27	1647	1.67	3.01	3341	2.68	4.84
1.06	64	4.010	68	4.261	1092	2.88	5.18	1647	3.79	6.83	3341	5.74	10.40
1.07	30	1.880	32	2.005	1088	1.16	2.10	1641	1.55	2.79	3328	2.49	4.49
1.07	60	3.760	64	4.010	1088	2.66	4.80	1641	3.52	6.34	3328	5.37	9.69
1.07	28	1.754	30	1.880	1083	1.07	1.93	1633	1.43	2.57	3313	2.30	4.15
1.07	56	3.509	60	3.760	1083	2.45	4.42	1633	3.24	5.85	3313	5.00	9.02
1.08	52	3.258	56	3.509	1077	2.25	4.05	1625	2.97	5.36	3296	4.62	8.33
1.08	48	3.008	52	3.258	1071	2.04	3.68	1615	2.70	4.88	3277	4.24	7.64
1.09	44	2.757	48	3.008	1063	1.84	3.32	1604	2.44	4.40	3254	3.85	6.94
1.10	40	2.506	44	2.757	1055	1.64	2.96	1591	2.18	3.93	3227	3.46	6.24
1.11	18	1.128	20	1.253	1044	0.63	1.14	1575	0.84	1.52	3195	1.37	2.47
1.11	36	2.256	40	2.506	1044	1.45	2.61	1575	1.92	3.47	3195	3.07	5.54
1.11	72	4.511	80	5.013	1044	3.31	5.96	1575	4.35	7.84	3195	6.45	11.60
1.12	34	2.130	38	2.381	1038	1.35	2.44	1566	1.80	3.24	3176	2.88	5.19
1.13	16	1.003	18	1.128	1031	0.55	0.99	1556	0.73	1.32	3156	1.19	2.15
1.13	32	2.005	36	2.256	1031	1.26	2.27	1556	1.67	3.01	3156	2.68	4.84
1.13	64	4.010	72	4.511	1031	2.88	5.18	1556	3.79	6.83	3156	5.74	10.40
1.13	30	1.880	34	2.130	1024	1.16	2.10	1544	1.55	2.79	3132	2.49	4.49
1.13	60	3.760	68	4.261	1024	2.66	4.80	1544	3.52	6.34	3132	5.37	9.69
1.14	14	.877	16	1.003	1015	0.47	...	1531	0.62	...	3106	1.02	...
1.14	28	1.754	32	2.005	1015	1.07	1.93	1531	1.43	2.57	3106	2.30	4.15
1.14	56	3.509	64	4.010	1015	2.45	4.42	1531	3.24	5.85	3106	5.00	9.02
1.15	52	3.258	60	3.760	1005	2.25	4.05	1517	2.97	5.36	3077	4.62	8.33
1.16	38	2.381	44	2.757	1002	1.54	2.79	1511	2.05	3.70	3066	3.27	5.89
1.17	24	1.504	28	1.754	994	0.89	1.61	1500	1.19	2.14	3043	1.92	3.46
1.17	48	3.008	56	3.509	994	2.04	3.68	1500	2.70	4.88	3043	4.24	7.64
Multiply hp rating by belt length factor to determine drive width—BELT LENGTH FACTOR →													

PULLEYS



HTS® 5 mm Drive Selection Tables

NOMINAL CENTER DISTANCES																					
BELT LENGTH CODE DESIGNATION																					
350	375	400	425	450	475	500	535	565	600	635	670	710	740	800	850	890	950	1000	1050	1125	1195
.8				.9				1.0				1.1				1.2					
5.5	6.0	6.5	7.0	7.5	8.0	8.5	9.2	9.7	10.4	11.1	11.8	12.6	13.2	14.4	15.4	16.1	17.3	18.3	19.3	20.8	22.1
5.3	5.8	6.3	6.8	7.3	7.8	8.3	9.0	9.5	10.2	10.9	11.6	12.4	13.0	14.2	15.2	15.9	17.1	18.1	19.1	20.6	21.9
5.1	5.6	6.1	6.6	7.1	7.6	8.1	8.8	9.4	10.0	10.7	11.4	12.2	12.8	14.0	15.0	15.7	16.9	17.9	18.9	20.4	21.8
4.9	5.4	5.9	6.4	6.9	7.4	7.9	8.6	9.2	9.8	10.5	11.2	12.0	12.6	13.8	14.8	15.6	16.7	17.7	18.7	20.2	21.6
4.5	5.0	5.5	6.0	6.5	7.0	7.5	8.2	8.8	9.5	10.1	10.8	11.6	12.2	13.4	14.4	15.2	16.3	17.3	18.3	19.8	21.2
4.1	4.6	5.1	5.6	6.1	6.6	7.1	7.8	8.4	9.1	9.7	10.4	11.2	11.8	13.0	14.0	14.8	15.9	16.9	17.9	19.4	20.8
3.9	4.4	4.9	5.4	5.9	6.4	6.9	7.6	8.2	8.9	9.5	10.2	11.0	11.6	12.8	13.8	14.6	15.7	16.7	17.7	19.2	20.6
3.7	4.2	4.7	5.2	5.7	6.2	6.7	7.4	8.0	8.7	9.4	10.0	10.8	11.4	12.6	13.6	14.4	15.6	16.5	17.5	19.0	20.4
3.5	4.0	4.5	5.0	5.5	6.0	6.5	7.2	7.8	8.5	9.2	9.8	10.6	11.2	12.4	13.4	14.2	15.4	16.3	17.3	18.8	20.2
3.3	3.8	4.3	4.8	5.3	5.8	6.3	7.0	7.6	8.3	9.0	9.6	10.4	11.0	12.2	13.2	14.0	15.2	16.1	17.1	18.6	20.0
3.2	3.6	4.1	4.6	5.1	5.6	6.1	6.8	7.4	8.1	8.8	9.5	10.2	10.8	12.0	13.0	13.8	15.0	15.9	16.9	18.4	19.8
3.0	3.4	3.9	4.4	4.9	5.4	5.9	6.6	7.2	7.9	8.6	9.3	10.0	10.6	11.8	12.8	13.6	14.8	15.8	16.7	18.2	19.6
...	...	3.5	4.0	4.5	5.0	5.5	6.2	6.8	7.5	8.2	8.9	9.6	10.2	11.4	12.4	13.2	14.4	15.4	16.3	17.8	19.2
...	3.6	4.1	4.6	5.1	5.8	6.4	7.1	7.8	8.5	9.3	9.8	11.0	12.0	12.8	14.0	15.0	15.9	17.4	18.8
...	3.7	4.2	4.7	5.4	6.0	6.7	7.4	8.1	8.9	9.5	10.6	11.6	12.4	13.6	14.6	15.6	17.0	18.4
...	4.3	5.0	5.6	6.3	7.0	7.7	8.5	9.1	10.2	11.2	12.0	13.2	14.2	15.2	16.6	18.0
...	4.6	5.2	5.9	6.6	7.3	8.1	8.7	9.8	10.8	11.6	12.8	13.8	14.8	16.2	17.6
...	4.8	5.5	6.2	6.9	7.7	8.3	9.5	10.4	11.2	12.4	13.4	14.4	15.8	17.2
...	5.1	5.8	6.5	7.3	7.9	9.1	10.0	10.8	12.0	13.0	14.0	15.5	16.8
...	0.0	5.4	6.1	6.9	7.5	8.7	9.6	10.4	11.6	12.6	13.6	15.1	16.4
3.1	3.5	4.0	4.5	5.0	5.5	6.0	6.7	7.3	8.0	8.7	9.4	10.1	10.7	11.9	12.9	13.7	14.9	15.8	16.8	18.3	19.7
3.2	3.7	4.2	4.7	5.2	5.7	6.2	6.9	7.5	8.2	8.9	9.5	10.3	10.9	12.1	13.1	13.9	15.1	16.0	17.0	18.5	19.9
3.4	3.9	4.4	4.9	5.4	5.9	6.4	7.1	7.7	8.4	9.1	9.7	10.5	11.1	12.3	13.3	14.1	15.3	16.2	17.2	18.7	20.1
...	4.9	5.6	6.3	7.1	7.7	8.9	9.8	10.6	11.8	12.8	13.8	15.3	16.6
3.6	4.1	4.6	5.1	5.6	6.1	6.6	7.3	7.9	8.6	9.3	9.9	10.7	11.3	12.5	13.5	14.3	15.5	16.4	17.4	18.9	20.3
...	4.6	5.3	6.0	6.7	7.5	8.1	9.3	10.2	11.0	12.2	13.2	14.2	15.7	17.0
3.8	4.3	4.8	5.3	5.8	6.3	6.8	7.5	8.1	8.8	9.5	10.1	10.9	11.5	12.7	13.7	14.5	15.7	16.6	17.6	19.1	20.5
...	4.4	5.0	5.7	6.4	7.1	7.9	8.5	9.6	10.6	11.4	12.6	13.6	14.6	16.0	17.4
4.0	4.5	5.0	5.5	6.0	6.5	7.0	7.7	8.3	9.0	9.6	10.3	11.1	11.7	12.9	13.9	14.7	15.8	16.8	17.8	19.3	20.7
...	4.1	4.8	5.4	6.1	6.8	7.5	8.3	8.9	10.0	11.0	11.8	13.0	14.0	15.0	16.4	17.8
...	4.0	4.5	5.2	5.8	6.5	7.2	7.9	8.7	9.3	10.4	11.4	12.2	13.4	14.4	15.4	16.8	18.2
...	3.9	4.4	4.9	5.6	6.2	6.9	7.6	8.3	9.1	9.6	10.8	11.8	12.6	13.8	14.8	15.7	17.2	18.6
...	...	3.3	3.8	4.3	4.8	5.3	6.0	6.6	7.3	8.0	8.7	9.5	10.0	11.2	12.2	13.0	14.2	15.2	16.1	17.6	19.0
...	3.2	3.7	4.2	4.7	5.2	5.7	6.4	7.0	7.7	8.4	9.1	9.8	10.4	11.6	12.6	13.4	14.6	15.6	16.5	18.0	19.4
5.0	5.5	6.0	6.5	7.0	7.5	8.0	8.7	9.3	9.9	10.6	11.3	12.1	12.7	13.9	14.9	15.7	16.8	17.8	18.8	20.3	21.7
3.1	3.6	4.1	4.6	5.1	5.6	6.1	6.8	7.4	8.1	8.8	9.4	10.2	10.8	12.0	13.0	13.8	15.0	15.9	16.9	18.4	19.8
...	5.7	6.5	7.1	8.3	9.3	10.0	11.2	12.2	13.2	14.7	16.0
3.3	3.8	4.3	4.8	5.3	5.8	6.3	7.0	7.6	8.3	9.0	9.6	10.4	11.0	12.2	13.2	14.0	15.2	16.1	17.1	18.6	20.0
5.2	5.7	6.2	6.7	7.2	7.7	8.2	8.9	9.4	10.1	10.8	11.5	12.3	12.9	14.1	15.1	15.8	17.0	18.0	19.0	20.5	21.9
3.5	4.0	4.5	5.0	5.5	6.0	6.5	7.2	7.8	8.5	9.2	9.8	10.6	11.2	12.4	13.4	14.2	15.4	16.3	17.3	18.8	20.2
...	5.1	5.8	6.5	7.3	7.9	9.1	10.0	10.8	12.0	13.0	14.0	15.5	16.8
3.7	4.2	4.7	5.2	5.7	6.2	6.7	7.4	8.0	8.7	9.4	10.0	10.8	11.4	12.6	13.6	14.4	15.6	16.5	17.5	19.0	20.4
...	4.8	5.5	6.2	6.9	7.7	8.3	9.4	10.4	11.2	12.4	13.4	14.4	15.8	17.2
5.4	5.9	6.4	6.9	7.4	7.9	8.4	9.1	9.6	10.3	11.0	11.7	12.5	13.1	14.3	15.3	16.0	17.2	18.2	19.2	20.7	22.0
3.9	4.4	4.9	5.4	5.9	6.4	6.9	7.6	8.2	8.9	9.5	10.2	11.0	11.6	12.8	13.8	14.6	15.7	16.7	17.7	19.2	20.6
...	4.6	5.2	5.9	6.6	7.3	8.1	8.7	9.8	10.8	11.6	12.8	13.8	14.8	16.2	17.6
...	4.3	5.0	5.6	6.3	7.0	7.7	8.5	9.1	10.2	11.2	12.0	13.2	14.2	15.2	16.6	18.0
...	3.3	3.8	4.3	4.8	5.3	5.8	6.5	7.1	7.8	8.5	9.2	9.9	10.5	11.7	12.7	13.5	14.7	15.7	16.6	18.1	19.5
4.3	4.8	5.3	5.8	6.3	6.8	7.3	8.0	8.6	9.3	9.9	10.6	11.4	12.0	13.2	14.2	15.0	16.1	17.1	18.1	19.6	21.0
...	3.7	4.2	4.7	5.4	6.0	6.7	7.4	8.1	8.9	9.4	10.6	11.6	12.4	13.6	14.6	15.6	17.0	18.4
.8				.9				1.0				1.1				1.2					

PULLEYS

HTS[®] 5 mm Drive Selection Tables



Drive Ratio	Sprocket Combination				Driven Speeds and Horsepower Ratings								
	Driver		Driven		1160 RPM Driver			1750 RPM Driver			3550 RPM Driver		
	No. Teeth	P.D.	No. Teeth	P.D.	Driven Speed	HP for Belt Widths		Driven Speed	HP for Belt Widths		Driven Speed	HP for Belt Widths	
					15	25		15	25		15	25	
Multiply hp rating by belt length factor to determine drive width—BELT LENGTH FACTOR →													
1.18	34	2.130	40	2.506	986	1.35	2.44	1488	1.80	3.24	3018	2.88	5.19
1.18	68	4.261	80	5.013	986	3.09	5.57	1488	4.07	7.33	3018	6.10	11.0
1.18	44	2.757	52	3.258	982	1.84	3.32	1481	2.44	4.40	3004	3.85	6.94
1.19	32	2.005	38	2.381	977	1.26	2.27	1474	1.67	3.01	2989	2.68	4.84
1.20	20	1.253	24	1.504	967	0.72	1.29	1458	0.95	1.72	2958	1.55	2.80
1.20	30	1.880	36	2.256	967	1.16	2.10	1458	1.55	2.79	2958	2.49	4.49
1.20	40	2.506	48	3.008	967	1.64	2.96	1458	2.18	3.93	2958	3.46	6.24
1.20	60	3.760	72	4.511	967	2.66	4.80	1458	3.52	6.34	2958	5.37	9.69
1.21	28	1.754	34	2.130	955	1.07	1.93	1441	1.43	2.57	2924	2.30	4.15
1.21	56	3.509	68	4.261	955	2.45	4.42	1441	3.24	5.85	2924	5.00	9.02
1.22	36	2.256	44	2.757	949	1.45	2.61	1432	1.92	3.47	2905	3.07	5.54
1.23	52	3.258	64	4.010	943	2.25	4.05	1422	2.97	5.36	2884	4.62	8.33
1.25	16	1.003	20	1.253	928	0.55	0.99	1400	0.73	1.32	2840	1.19	2.15
1.25	24	1.504	30	1.880	928	0.89	1.61	1400	1.19	2.14	2840	1.92	3.46
1.25	32	2.005	40	2.506	928	1.26	2.27	1400	1.67	3.01	2840	2.68	4.84
1.25	48	3.008	60	3.700	928	2.04	3.68	1400	2.70	4.88	2840	4.24	7.64
1.25	64	4.010	80	5.013	928	2.88	5.18	1400	3.79	6.83	2840	5.74	10.4
1.25	72	4.511	90	5.639	928	3.31	5.96	1400	4.35	7.84	2840	6.45	11.6
1.26	38	2.381	48	3.008	918	1.54	2.79	1385	2.05	3.70	2810	3.27	5.89
1.27	30	1.880	38	2.381	916	1.16	2.10	1382	1.55	2.79	2803	2.49	4.49
1.27	44	2.757	56	3.509	911	1.84	3.32	1375	2.44	4.40	2789	3.85	6.94
1.29	14	.877	18	1.128	902	0.47	...	1361	0.62	...	2761	1.02	...
1.29	28	1.754	36	2.256	902	1.07	1.93	1361	1.43	2.57	2761	2.30	4.15
1.29	56	3.509	72	4.511	902	2.45	4.42	1361	3.24	5.85	2761	5.00	9.02
1.29	34	2.130	44	2.757	896	1.35	2.44	1352	1.80	3.24	2743	2.88	5.19
1.30	40	2.506	52	3.258	892	1.64	2.96	1346	2.18	3.93	2731	3.46	6.24
1.31	52	3.258	68	4.261	887	2.25	4.05	1338	2.97	5.36	2715	4.62	8.33
1.32	68	4.261	90	5.639	876	3.09	5.57	1322	4.07	7.33	2682	6.10	11.0
1.33	18	1.128	24	1.504	870	0.63	1.14	1313	0.84	1.52	2663	1.37	2.47
1.33	24	1.504	32	2.005	870	0.89	1.61	1313	1.19	2.14	2663	1.92	3.46
1.33	30	1.880	40	2.506	870	1.16	2.10	1313	1.55	2.79	2663	2.49	4.49
1.33	36	2.256	48	3.008	870	1.45	2.61	1313	1.92	3.47	2663	3.07	5.54
1.33	48	3.008	64	4.010	870	2.04	3.68	1313	2.70	4.88	2663	4.24	7.64
1.33	60	3.760	80	5.013	870	2.66	4.80	1313	3.52	6.34	2663	5.37	9.69
1.36	28	1.754	38	2.381	855	1.07	1.93	1289	1.43	2.57	2616	2.30	4.15
1.36	44	2.757	60	3.760	851	1.84	3.32	1283	2.44	4.40	2603	3.85	6.94
1.37	38	2.381	52	3.258	848	1.54	2.79	1279	2.05	3.70	2594	3.27	5.89
1.38	32	2.005	44	2.757	844	1.26	2.27	1273	1.67	3.01	2582	2.68	4.84
1.38	52	3.258	72	4.511	838	2.25	4.05	1264	2.97	5.36	2564	4.62	8.33
1.40	20	1.253	28	1.754	829	0.72	1.29	1250	0.95	1.72	2536	1.55	2.80
1.40	40	2.506	56	3.509	829	1.64	2.96	1250	2.18	3.93	2536	3.46	6.24
1.41	64	4.010	90	5.639	825	2.88	5.18	1244	3.79	6.83	2524	5.74	10.4
1.41	34	2.130	48	3.008	822	1.35	2.44	1240	1.80	3.24	2515	2.88	5.19
1.42	24	1.504	34	2.130	819	0.89	1.61	1235	1.19	2.14	2506	1.92	3.46
1.42	48	3.008	68	4.261	819	2.04	3.68	1235	2.70	4.88	2506	4.24	7.64
1.43	14	.877	20	1.253	812	0.47	...	1225	0.62	...	2485	1.02	...
1.43	28	1.754	40	2.506	812	1.07	1.93	1225	1.43	2.57	2485	2.30	4.15
1.43	56	3.509	80	5.013	812	2.45	4.42	1225	3.24	5.85	2485	5.00	9.02
1.44	36	2.256	52	3.258	803	1.45	2.61	1212	1.92	3.47	2458	3.07	5.54
1.45	44	2.757	64	4.010	798	1.84	3.32	1203	2.44	4.40	2441	3.85	6.94
Multiply hp rating by belt length factor to determine drive width—BELT LENGTH FACTOR →													

PULLEYS



HTS® 5 mm Drive Selection Tables

NOMINAL CENTER DISTANCES																					
BELT LENGTH CODE DESIGNATION																					
350	375	400	425	450	475	500	535	565	600	635	670	710	740	800	850	890	950	1000	1050	1125	1195
.8				.9				1.0						1.1					1.2		
3.2	3.7	4.2	4.7	5.2	5.7	6.2	6.9	7.5	8.2	8.9	9.5	10.3	10.9	12.1	13.1	13.9	15.1	16.0	17.0	18.5	19.9
...	5.2	5.9	6.7	7.3	8.5	9.4	10.2	11.4	12.4	13.4	14.9	16.2
...	3.6	4.1	4.6	5.1	5.8	6.4	7.1	7.8	8.5	9.3	9.8	11.0	12.0	12.8	14.0	15.0	15.9	17.4	18.8
3.4	3.9	4.4	4.9	5.4	5.9	6.4	7.1	7.7	8.4	9.1	9.7	10.5	11.1	12.3	13.3	14.1	15.3	16.2	17.2	18.7	20.1
4.7	5.2	5.7	6.2	6.7	7.2	7.7	8.4	9.0	9.6	10.3	11.0	11.8	12.4	13.6	14.6	15.4	16.5	17.5	18.5	20.0	21.4
3.6	4.1	4.6	5.1	5.6	6.1	6.6	7.3	7.9	8.6	9.3	9.9	10.7	11.3	12.5	13.5	14.3	15.5	16.4	17.4	18.9	20.3
...	...	3.5	4.0	4.5	5.0	5.5	6.2	6.8	7.5	8.2	8.9	9.6	10.2	11.4	12.4	13.2	14.4	15.4	16.3	17.8	19.2
...	4.6	5.3	6.0	6.7	7.5	8.1	9.2	10.2	11.0	12.2	13.2	14.2	15.6	17.0
3.8	4.3	4.8	5.3	5.8	6.3	6.8	7.5	8.1	8.8	9.4	10.1	10.9	11.5	12.7	13.7	14.5	15.6	16.6	17.6	19.1	20.5
...	4.4	5.0	5.7	6.4	7.1	7.9	8.5	9.6	10.6	11.4	12.6	13.6	14.6	16.0	17.4
2.9	3.4	3.9	4.4	4.9	5.4	5.9	6.6	7.2	7.9	8.6	9.3	10.0	10.6	11.8	12.8	13.6	14.8	15.7	16.7	18.2	19.6
...	4.1	4.8	5.4	6.1	6.8	7.5	8.3	8.9	10.0	11.0	11.8	13.0	14.0	15.0	16.4	17.8
5.1	5.6	6.1	6.6	7.1	7.6	8.1	8.8	9.4	10.0	10.7	11.4	12.2	12.8	14.0	15.0	15.7	16.9	17.9	18.9	20.4	21.8
4.2	4.7	5.2	5.7	6.2	6.7	7.2	7.9	8.5	9.2	9.8	10.5	11.3	11.9	13.1	14.1	14.9	16.0	17.0	18.0	19.5	20.9
3.3	3.8	4.3	4.8	5.3	5.8	6.3	7.0	7.6	8.3	9.0	9.6	10.4	11.0	12.2	13.2	14.0	15.2	16.1	17.1	18.6	20.0
...	4.0	4.5	5.2	5.8	6.5	7.2	7.9	8.7	9.2	10.4	11.4	12.2	13.4	14.4	15.4	16.8	18.2
...	5.4	6.1	6.9	7.5	8.6	9.6	10.4	11.6	12.6	13.6	15.1	16.4
...	6.0	6.6	7.8	8.7	9.5	10.7	11.7	12.7	14.2	15.5
...	3.1	3.6	4.1	4.6	5.1	5.6	6.3	6.9	7.6	8.3	9.0	9.7	10.3	11.5	12.5	13.3	14.5	15.5	16.4	17.9	19.3
3.5	4.0	4.5	5.0	5.5	6.0	6.5	7.2	7.8	8.5	9.2	9.8	10.6	11.2	12.4	13.4	14.2	15.4	16.3	17.3	18.8	20.2
...	3.9	4.4	4.9	5.6	6.2	6.9	7.6	8.3	9.0	9.6	10.8	11.8	12.6	13.8	14.8	15.7	17.2	18.6
5.3	5.8	6.3	6.8	7.3	7.8	8.3	9.0	9.5	10.2	10.9	11.6	12.4	13.0	14.2	15.2	15.9	17.1	18.1	19.1	20.6	21.9
3.7	4.2	4.7	5.2	5.7	6.2	6.7	7.4	8.0	8.7	9.3	10.0	10.8	11.4	12.6	13.6	14.4	15.6	16.5	17.5	19.0	20.4
...	4.8	5.5	6.2	6.9	7.7	8.3	9.4	10.4	11.2	12.4	13.4	14.4	15.8	17.2
3.0	3.5	4.0	4.5	5.0	5.5	6.0	6.7	7.3	8.0	8.7	9.3	10.1	10.7	11.9	12.9	13.7	14.9	15.8	16.8	18.3	19.7
...	...	3.3	3.8	4.3	4.8	5.3	6.0	6.6	7.3	8.0	8.7	9.4	10.0	11.2	12.2	13.0	14.2	15.2	16.1	17.6	19.0
...	4.6	5.2	5.9	6.6	7.3	8.1	8.6	9.8	10.8	11.6	12.8	13.8	14.8	16.2	17.6
...	5.4	6.2	6.8	7.9	8.9	9.7	10.9	11.9	12.9	14.4	15.7
4.8	5.3	5.8	6.3	6.8	7.3	7.8	8.5	9.1	9.7	10.4	11.1	11.9	12.5	13.7	14.7	15.5	16.6	17.6	18.6	20.1	21.5
4.1	4.6	5.1	5.6	6.1	6.6	7.1	7.8	8.4	9.1	9.7	10.4	11.2	11.8	13.0	14.0	14.8	15.9	16.9	17.9	19.4	20.8
3.4	3.9	4.4	4.9	5.4	5.9	6.4	7.1	7.7	8.4	9.1	9.7	10.5	11.1	12.3	13.3	14.1	15.3	16.2	17.2	18.7	20.1
...	3.2	3.7	4.2	4.7	5.2	5.7	6.4	7.0	7.7	8.4	9.0	9.8	10.4	11.6	12.6	13.4	14.6	15.5	16.5	18.0	19.4
...	4.3	5.0	5.6	6.3	7.0	7.7	8.5	9.0	10.2	11.2	12.0	13.2	14.2	15.2	16.6	18.0
...	4.9	5.6	6.3	7.1	7.7	8.8	9.8	10.6	11.8	12.8	13.8	15.2	16.6
3.6	4.1	4.6	5.1	5.6	6.1	6.6	7.3	7.9	8.6	9.2	9.9	10.7	11.3	12.5	13.5	14.3	15.5	16.4	17.4	18.9	20.3
...	3.7	4.2	4.7	5.4	6.0	6.7	7.4	8.1	8.8	9.4	10.6	11.6	12.4	13.6	14.6	15.5	17.0	18.4
...	...	3.4	3.9	4.4	4.9	5.4	6.1	6.7	7.4	8.1	8.8	9.5	10.1	11.3	12.3	13.1	14.3	15.3	16.2	17.7	19.1
3.1	3.6	4.1	4.6	5.1	5.6	6.1	6.8	7.4	8.1	8.8	9.4	10.2	10.8	12.0	13.0	13.8	15.0	15.9	16.9	18.4	19.8
...	4.4	5.0	5.7	6.4	7.1	7.8	8.4	9.6	10.6	11.4	12.6	13.6	14.6	16.0	17.4
4.5	5.0	5.5	6.0	6.5	7.0	7.5	8.2	8.8	9.4	10.1	10.8	11.6	12.2	13.4	14.4	15.2	16.3	17.3	18.3	19.8	21.2
...	3.6	4.1	4.6	5.1	5.8	6.4	7.1	7.8	8.5	9.2	9.8	11.0	12.0	12.8	14.0	15.0	15.9	17.4	18.8
...	5.5	6.3	6.9	8.1	9.1	9.9	11.1	12.1	13.1	14.5	15.9
...	3.3	3.8	4.3	4.8	5.3	5.8	6.5	7.1	7.8	8.5	9.1	9.9	10.5	11.7	12.7	13.5	14.7	15.6	16.6	18.1	19.5
4.0	4.5	5.0	5.5	6.0	6.5	7.0	7.7	8.3	9.0	9.6	10.3	11.1	11.7	12.9	13.9	14.7	15.8	16.8	17.8	19.3	20.7
...	4.1	4.8	5.4	6.1	6.8	7.5	8.2	8.8	10.0	11.0	11.8	13.0	14.0	14.9	16.4	17.8
5.2	5.7	6.2	6.7	7.2	7.7	8.2	8.9	9.4	10.1	10.8	11.5	12.3	12.9	14.1	15.1	15.8	17.0	18.0	19.0	20.5	21.9
3.5	4.0	4.5	5.0	5.5	6.0	6.5	7.2	7.8	8.5	9.1	9.8	10.6	11.2	12.4	13.4	14.2	15.4	16.3	17.3	18.8	20.2
...	5.1	5.8	6.5	7.2	7.8	9.0	10.0	10.8	12.0	13.0	14.0	15.4	16.8
...	...	3.5	4.0	4.5	5.0	5.5	6.2	6.8	7.5	8.2	8.8	9.6	10.2	11.4	12.4	13.2	14.4	15.3	16.3	17.8	19.2
...	4.0	4.5	5.2	5.8	6.5	7.2	7.8	8.6	9.2	10.4	11.4	12.2	13.4	14.4	15.3	16.8	18.2
.8				.9				1.0						1.1					1.2		

PULLEYS

HTS® 5 mm Drive Selection Tables



Drive Ratio	Sprocket Combination				Driven Speeds and Horsepower Ratings								
	Driver		Driven		1160 RPM Driver			1750 RPM Driver			3550 RPM Driver		
	No. Teeth	P.D.	No. Teeth	P.D.	Driven Speed	HP for Belt Widths		Driven Speed	HP for Belt Widths		Driven Speed	HP for Belt Widths	
					15	25		15	25		15	25	
Multiply hp rating by belt length factor to determine drive width—BELT LENGTH FACTOR →													
1.47	30	1.880	44	2.757	791	1.16	2.10	1193	1.55	2.79	2420	2.49	4.49
1.47	38	2.381	56	3.509	787	1.54	2.79	1188	2.05	3.70	2409	3.27	5.89
1.50	16	1.003	24	1.504	773	0.55	0.99	1167	0.73	1.32	2367	1.19	2.15
1.50	20	1.253	30	1.880	773	0.72	1.29	1167	0.95	1.72	2367	1.55	2.80
1.50	24	1.504	36	2.256	773	0.89	1.61	1167	1.19	2.14	2367	1.92	3.46
1.50	32	2.005	48	3.008	773	1.26	2.27	1167	1.67	3.01	2367	2.68	4.84
1.50	40	2.506	60	3.760	773	1.64	2.96	1167	2.18	3.93	2367	3.46	6.24
1.50	48	3.008	72	4.511	773	2.04	3.68	1167	2.70	4.88	2367	4.24	7.64
1.50	60	3.760	90	5.639	773	2.66	4.80	1167	3.52	6.34	2367	5.37	9.69
1.53	34	2.130	52	3.258	758	1.35	2.44	1144	1.80	3.24	2321	2.88	5.19
1.54	52	3.258	80	5.013	754	2.25	4.05	1138	2.97	5.36	2308	4.62	8.33
1.55	44	2.757	68	4.261	751	1.84	3.32	1132	2.44	4.40	2297	3.85	6.94
1.56	18	1.128	28	1.754	746	0.63	1.14	1125	0.84	1.52	2282	1.37	2.47
1.56	36	2.256	56	3.509	746	1.45	2.61	1125	1.92	3.47	2282	3.07	5.54
1.56	72	4.511	112	7.018	746	3.31	5.96	1125	4.35	7.84	2282	6.45	11.6
1.57	28	1.754	44	2.757	738	1.07	1.93	1114	1.43	2.57	2259	2.30	4.15
1.58	38	2.381	60	3.760	735	1.54	2.79	1108	2.05	3.70	2248	3.27	5.89
1.58	24	1.504	38	2.381	733	0.89	1.61	1105	1.19	2.14	2242	1.92	3.46
1.60	20	1.253	32	2.005	725	0.72	1.29	1094	0.95	1.72	2219	1.55	2.80
1.60	30	1.880	48	3.008	725	1.16	2.10	1094	1.55	2.79	2219	2.49	4.49
1.60	40	2.506	64	4.010	725	1.64	2.96	1094	2.18	3.93	2219	3.46	6.24
1.61	56	3.509	90	5.639	722	2.45	4.42	1089	3.24	5.85	2209	5.00	9.02
1.63	32	1.003	52	1.629	714	1.26	2.27	1077	1.67	3.01	2185	2.68	4.84
1.64	44	2.757	72	4.511	709	1.84	3.32	1069	2.44	4.40	2169	3.85	6.94
1.65	34	2.130	56	3.509	704	1.35	2.44	1063	1.80	3.24	2155	2.88	5.19
1.65	68	4.261	112	7.018	704	3.09	5.57	1063	4.07	7.33	2155	6.10	11.0
1.67	18	1.128	30	1.880	696	0.63	1.14	1050	0.84	1.52	2130	1.37	2.47
1.67	24	1.504	40	2.506	696	0.89	1.61	1050	1.19	2.14	2130	1.92	3.46
1.67	36	2.256	60	3.760	696	1.45	2.61	1050	1.92	3.47	2130	3.07	5.54
1.67	48	3.008	80	5.013	696	2.04	3.68	1050	2.70	4.88	2130	4.24	7.64
1.68	38	2.381	64	4.010	689	1.54	2.79	1039	2.05	3.70	2108	3.27	5.89
1.70	20	1.253	34	2.130	682	0.72	1.29	1029	0.95	1.72	2088	1.55	2.80
1.70	40	2.506	68	4.261	682	1.64	2.96	1029	2.18	3.93	2088	3.46	6.24
1.71	14	.877	24	1.504	677	0.47	...	1021	0.62	...	2071	1.02	...
1.71	28	1.754	48	3.008	677	1.07	1.93	1021	1.43	2.57	2071	2.30	4.15
1.73	52	3.258	90	5.639	670	2.25	4.05	1011	2.97	5.36	2051	4.62	8.33
1.73	30	1.880	52	3.258	669	1.16	2.10	1010	1.55	2.79	2048	2.49	4.49
1.75	16	1.003	28	1.754	663	0.55	0.99	1000	0.73	1.32	2029	1.19	2.15
1.75	32	2.005	56	3.509	663	1.26	2.27	1000	1.67	3.01	2029	2.68	4.84
1.75	64	4.010	112	7.018	663	2.88	5.18	1000	3.79	6.83	2029	5.74	10.4
1.76	34	2.130	60	3.760	657	1.35	2.44	992	1.80	3.24	2012	2.88	5.19
1.78	18	1.128	32	2.005	653	0.63	1.14	984	0.84	1.52	1997	1.37	2.47
1.78	36	2.256	64	4.010	653	1.45	2.61	984	1.92	3.47	1997	3.07	5.54
1.79	38	2.381	68	4.261	648	1.54	2.79	978	2.05	3.70	1984	3.27	5.89
1.80	20	1.253	36	2.256	644	0.72	1.29	972	0.95	1.72	1972	1.55	2.80
1.80	40	2.506	72	4.511	644	1.64	2.96	972	2.18	3.93	1972	3.46	6.24
1.82	44	2.757	80	5.013	638	1.84	3.32	963	2.44	4.40	1953	3.85	6.94
1.83	24	1.504	44	2.757	633	0.89	1.61	955	1.19	2.14	1936	1.92	3.46
1.86	28	1.754	52	3.258	625	1.07	1.93	942	1.43	2.57	1912	2.30	4.15
1.87	30	1.880	56	3.509	621	1.16	2.10	938	1.55	2.79	1902	2.49	4.49
Multiply hp rating by belt length factor to determine drive width—BELT LENGTH FACTOR →													

PULLEYS



HTS® 5 mm Drive Selection Tables

NOMINAL CENTER DISTANCES																					
BELT LENGTH CODE DESIGNATION																					
350	375	400	425	450	475	500	535	565	600	635	670	710	740	800	850	890	950	1000	1050	1125	1195
.8				.9				1.0						1.1					1.2		
3.2	3.7	4.2	4.7	5.2	5.7	6.2	6.9	7.5	8.2	8.8	9.5	10.3	10.9	12.1	13.1	13.9	15.1	16.0	17.0	18.5	19.9
...	3.7	4.2	4.7	5.2	5.9	6.5	7.2	7.9	8.5	9.3	9.9	11.1	12.1	12.9	14.1	15.0	16.0	17.5	18.9
4.9	5.4	5.9	6.4	6.9	7.4	7.9	8.6	9.2	9.8	10.5	11.2	12.0	12.6	13.8	14.8	15.5	16.7	17.7	18.7	20.2	21.6
4.4	4.9	5.4	5.9	6.4	6.9	7.4	8.1	8.7	9.3	10.0	10.7	11.5	12.1	13.3	14.3	15.1	16.2	17.2	18.2	19.7	21.1
3.9	4.4	4.9	5.4	5.9	6.4	6.9	7.6	8.2	8.9	9.5	10.2	11.0	11.6	12.8	13.8	14.6	15.7	16.7	17.7	19.2	20.6
2.9	3.4	3.9	4.4	4.9	5.4	5.9	6.6	7.2	7.9	8.5	9.2	10.0	10.6	11.8	12.8	13.6	14.8	15.7	16.7	18.2	19.6
...	3.9	4.4	4.9	5.6	6.2	6.9	7.6	8.2	9.0	9.6	10.8	11.8	12.6	13.8	14.8	15.7	17.2	18.6
...	4.6	5.2	5.9	6.6	7.2	8.0	8.6	9.8	10.8	11.6	12.8	13.8	14.7	16.2	17.6
...	5.7	6.5	7.1	8.3	9.3	10.1	11.3	12.3	13.3	14.7	16.1
...	3.1	3.6	4.1	4.6	5.1	5.6	6.3	6.9	7.6	8.2	8.9	9.7	10.3	11.5	12.5	13.3	14.5	15.4	16.4	17.9	19.3
...	4.5	5.2	5.9	6.6	7.4	8.0	9.2	10.2	11.0	12.2	13.2	14.1	15.6	17.0
...	4.3	5.0	5.6	6.3	6.9	7.6	8.4	9.0	10.2	11.2	12.0	13.2	14.2	15.1	16.6	18.0
4.6	5.1	5.6	6.1	6.6	7.1	7.6	8.3	8.9	9.5	10.2	10.9	11.7	12.3	13.5	14.5	15.3	16.4	17.4	18.4	19.9	21.3
...	...	3.3	3.8	4.3	4.8	5.3	6.0	6.6	7.3	7.9	8.6	9.4	10.0	11.2	12.2	13.0	14.2	15.1	16.1	17.6	19.0
...	6.6	7.6	8.4	9.6	10.6	11.5	13.0	14.4
3.3	3.8	4.3	4.8	5.3	5.8	6.3	7.0	7.6	8.3	8.9	9.6	10.4	11.0	12.2	13.2	14.0	15.2	16.1	17.1	18.6	20.0
...	3.5	4.0	4.5	5.0	5.7	6.3	7.0	7.6	8.3	9.1	9.7	10.9	11.9	12.7	13.9	14.8	15.8	17.3	18.7
3.8	4.3	4.8	5.3	5.8	6.3	6.8	7.5	8.1	8.7	9.4	10.1	10.9	11.5	12.7	13.7	14.5	15.6	16.6	17.6	19.1	20.5
4.3	4.8	5.3	5.8	6.3	6.8	7.3	8.0	8.6	9.2	9.9	10.6	11.4	12.0	13.2	14.2	15.0	16.1	17.1	18.1	19.6	21.0
3.0	3.5	4.0	4.5	5.0	5.5	6.0	6.7	7.3	8.0	8.6	9.3	10.1	10.7	11.9	12.9	13.7	14.9	15.8	16.8	18.3	19.7
...	3.7	4.2	4.7	5.4	6.0	6.6	7.3	8.0	8.8	9.4	10.6	11.6	12.4	13.6	14.5	15.5	17.0	18.4
...	5.2	5.9	6.7	7.3	8.5	9.5	10.3	11.5	12.5	13.4	14.9	16.3
...	3.2	3.7	4.2	4.7	5.2	5.7	6.4	7.0	7.7	8.3	9.0	9.8	10.4	11.6	12.6	13.4	14.6	15.5	16.5	18.0	19.4
...	4.0	4.7	5.3	6.0	6.7	7.4	8.2	8.8	10.0	11.0	11.8	13.0	13.9	14.9	16.4	17.8
...	...	3.4	3.9	4.4	4.9	5.4	6.1	6.7	7.3	8.0	8.7	9.5	10.1	11.3	12.3	13.1	14.3	15.2	16.2	17.7	19.1
...	6.7	7.7	8.5	9.7	10.7	11.7	13.2	14.6
4.5	5.0	5.5	6.0	6.5	7.0	7.5	8.2	8.8	9.4	10.1	10.8	11.6	12.2	13.4	14.4	15.2	16.3	17.3	18.3	19.8	21.2
3.7	4.2	4.7	5.2	5.7	6.2	6.7	7.4	8.0	8.6	9.3	10.0	10.8	11.4	12.6	13.6	14.4	15.5	16.5	17.5	19.0	20.4
...	3.6	4.1	4.6	5.1	5.8	6.4	7.0	7.7	8.4	9.2	9.8	11.0	12.0	12.8	14.0	14.9	15.9	17.4	18.8
...	4.7	5.4	6.1	6.8	7.6	8.2	9.4	10.4	11.2	12.4	13.3	14.3	15.8	17.2
...	3.7	4.2	4.8	5.4	6.0	6.7	7.4	8.1	8.9	9.5	10.7	11.7	12.5	13.7	14.6	15.6	17.1	18.5
4.2	4.7	5.2	5.7	6.2	6.7	7.2	7.9	8.5	9.1	9.8	10.5	11.3	11.9	13.1	14.1	14.9	16.0	17.0	18.0	19.5	20.9
...	3.9	4.4	5.1	5.7	6.4	7.1	7.8	8.6	9.2	10.4	11.4	12.2	13.4	14.3	15.3	16.8	18.2
5.0	5.5	6.0	6.5	7.0	7.5	8.0	8.7	9.2	9.9	10.6	11.3	12.1	12.7	13.9	14.9	15.6	16.8	17.8	18.8	20.3	21.7
3.1	3.6	4.1	4.6	5.1	5.6	6.1	6.8	7.4	8.0	8.7	9.4	10.2	10.8	12.0	13.0	13.8	14.8	15.9	16.9	18.4	19.8
...	5.4	6.1	6.9	7.5	8.7	9.7	10.5	11.7	12.6	13.6	15.1	16.5
...	3.3	3.8	4.3	4.8	5.3	5.8	6.5	7.1	7.7	8.4	9.1	9.9	10.0	11.7	12.7	13.5	14.6	15.6	16.6	18.1	19.5
4.7	5.2	5.7	6.2	6.7	7.2	7.7	8.4	8.9	9.6	10.3	11.0	11.8	5	13.6	14.6	15.4	16.5	17.5	18.5	20.0	21.4
...	...	3.5	4.0	4.5	5.0	5.5	6.2	6.7	7.4	8.1	8.8	9.6	12.4	11.4	12.4	13.2	14.4	15.3	16.3	17.8	19.2
...	10.2	6.9	7.9	8.7	9.9	10.9	11.9	13.4	14.8
...	3.6	4.1	4.7	5.1	5.8	6.4	7.1	7.8	8.5	9.3	...	11.1	12.1	12.9	14.1	15.0	16.0	17.5	18.9
4.4	4.9	5.4	5.9	6.4	6.9	7.4	8.1	8.7	9.3	10.0	10.7	11.5	9.9	13.3	14.3	15.1	16.2	17.2	18.2	19.7	21.1
...	3.8	4.3	4.8	5.5	6.1	6.8	7.5	8.2	9.0	12.1	10.8	11.8	12.6	13.8	14.7	15.7	17.2	18.6
...	4.0	4.5	5.2	5.8	6.5	7.2	7.9	8.7	9.6	10.5	11.5	12.3	13.5	14.4	15.4	16.9	18.3
4.1	4.6	5.1	5.6	6.1	6.6	7.1	7.8	8.4	9.0	9.7	10.4	11.2	9.3	13.0	14.0	14.8	15.9	16.9	17.9	19.4	20.8
...	4.2	4.9	5.5	6.2	6.9	7.6	8.4	11.8	10.2	11.2	12.0	13.2	14.1	15.1	16.6	18.0
...	4.3	4.9	5.6	6.3	7.0	7.8	9.0	9.6	10.6	11.4	12.5	13.5	14.5	16.0	17.4
3.5	4.0	4.5	5.0	5.5	6.0	6.5	7.2	7.7	8.4	9.1	9.8	10.6	8.4	12.4	13.4	14.2	15.3	16.3	17.3	18.8	20.2
...	3.4	3.9	4.4	4.9	5.4	5.9	6.5	7.1	7.8	8.5	9.2	10.0	11.2	11.8	12.8	13.6	14.7	15.7	16.7	18.2	19.6
...	...	3.5	4.0	4.5	5.0	5.5	6.2	6.8	7.5	8.2	8.9	9.7	10.6	11.5	12.5	13.3	14.4	15.4	16.4	17.9	19.3
.8				.9				1.0						1.1					1.2		

PULLEYS

HTS® 5 mm Drive Selection Tables



Drive Ratio	Sprocket Combination				Driven Speeds and Horsepower Ratings								
	Driver		Driven		1160 RPM Driver			1750 RPM Driver			3550 RPM Driver		
	No. Teeth	P.D.	No. Teeth	P.D.	Driven Speed	HP for Belt Widths		Driven Speed	HP for Belt Widths		Driven Speed	HP for Belt Widths	
					15	25		15	25		15	25	
Multiply hp rating by belt length factor to determine drive width—BELT LENGTH FACTOR →													
1.87	60	3.760	112	7.018	621	2.66	4.80	938	3.52	6.34	1902	5.37	9.69
1.88	16	1.003	30	1.880	619	0.55	0.99	933	0.73	1.32	1893	1.19	2.15
1.88	32	2.005	60	3.760	619	1.26	2.27	933	1.67	3.01	1893	2.68	4.84
1.88	48	3.008	90	5.639	619	2.04	3.68	933	2.70	4.88	1893	4.24	7.64
1.88	34	2.130	64	4.010	616	1.35	2.44	930	1.80	3.24	1886	2.88	5.19
1.89	18	1.128	34	2.130	614	0.63	1.14	926	0.84	1.52	1879	1.37	2.47
1.89	36	2.256	68	4.261	614	1.45	2.61	926	1.92	3.47	1879	3.07	5.54
1.89	38	2.381	72	4.511	612	1.54	2.79	924	2.05	3.70	1874	3.27	5.89
1.90	20	1.253	38	2.381	611	0.72	1.29	921	0.95	1.72	1868	1.55	2.80
2.00	14	0.877	28	1.754	580	0.47	...	875	0.62	...	1775	1.02	...
2.00	16	1.003	32	2.005	580	0.55	0.99	875	0.73	1.32	1775	1.19	2.15
2.00	18	1.128	36	2.256	580	0.63	1.14	875	0.84	1.52	1775	1.37	2.47
2.00	20	1.253	40	2.506	580	0.72	1.29	875	0.95	1.72	1775	1.55	2.80
2.00	24	1.504	48	3.008	580	0.89	1.61	875	1.19	2.14	1775	1.92	3.46
2.00	28	1.754	56	3.509	580	1.07	1.93	875	1.43	2.57	1775	2.30	4.15
2.00	30	1.880	60	3.760	580	1.16	2.10	875	1.55	2.79	1775	2.49	4.49
2.00	32	2.005	64	4.010	580	1.26	2.27	875	1.67	3.01	1775	2.68	4.84
2.00	34	2.130	68	4.261	580	1.35	2.44	875	1.80	3.24	1775	2.88	5.19
2.00	36	2.256	72	4.511	580	1.45	2.61	875	1.92	3.47	1775	3.07	5.54
2.00	40	2.506	80	5.013	580	1.64	2.96	875	2.18	3.93	1775	3.46	6.24
2.00	56	3.509	112	7.018	580	2.45	4.42	875	3.24	5.85	1775	5.00	9.02
2.05	44	2.757	90	5.639	567	1.84	3.32	856	2.44	4.40	1736	3.85	6.94
2.11	38	2.381	80	5.013	551	1.54	2.79	831	2.05	3.70	1686	3.27	5.89
2.11	18	1.128	38	2.381	549	0.63	1.14	829	0.84	1.52	1682	1.37	2.47
2.12	34	2.130	72	4.511	548	1.35	2.44	826	1.80	3.24	1676	2.88	5.19
2.13	16	1.003	34	2.130	546	0.55	0.99	824	0.73	1.32	1671	1.19	2.15
2.13	32	2.005	68	4.261	546	1.26	2.27	824	1.67	3.01	1671	2.68	4.84
2.13	30	1.880	64	4.010	544	1.16	2.10	820	1.55	2.79	1664	2.49	4.49
2.14	14	0.877	30	1.880	541	0.47	...	817	0.62	...	1657	1.02	...
2.14	28	1.754	60	3.760	541	1.07	1.93	817	1.43	2.57	1657	2.30	4.15
2.15	52	3.258	112	7.018	539	2.25	4.05	813	2.97	5.36	1648	4.62	8.33
2.17	24	1.504	52	3.258	535	0.89	1.61	808	1.19	2.14	1638	1.92	3.46
2.20	20	1.253	44	2.757	527	0.72	1.29	795	0.95	1.72	1614	1.55	2.80
2.22	18	1.258	40	2.506	522	0.63	1.14	788	0.84	1.52	1598	1.37	2.47
2.22	36	2.256	80	5.013	522	1.45	2.61	788	1.92	3.47	1598	3.07	5.54
2.25	16	1.003	36	2.256	516	0.55	0.99	778	0.73	1.32	1578	1.19	2.15
2.25	32	2.005	72	4.511	516	1.26	2.27	778	1.67	3.01	1578	2.68	4.84
2.25	40	2.506	90	5.639	516	1.64	2.96	778	2.18	3.93	1578	3.46	6.24
2.27	30	1.880	68	4.261	512	1.16	2.10	772	1.55	2.79	1566	2.49	4.49
2.29	14	0.877	32	2.005	508	0.47	...	766	0.62	...	1553	1.02	...
2.29	28	1.754	64	4.010	508	1.07	1.93	766	1.43	2.57	1553	2.30	4.15
2.33	24	1.504	56	3.509	497	0.89	1.61	750	1.19	2.14	1521	1.92	3.46
2.33	48	3.008	112	7.018	497	2.04	3.68	750	2.70	4.88	1521	4.24	7.64
2.35	34	2.130	80	5.013	493	1.35	2.44	744	1.80	3.24	1509	2.88	5.19
2.37	38	2.381	90	5.639	490	1.54	2.79	739	2.05	3.70	1499	3.27	5.89
2.38	16	1.003	38	2.381	488	0.55	0.99	737	0.73	1.32	1495	1.19	2.15
2.40	20	1.253	48	3.008	483	0.72	1.29	729	0.95	1.72	1479	1.55	2.80
2.40	30	1.880	72	4.511	483	1.16	2.10	729	1.55	2.79	1479	2.49	4.49
2.43	14	0.877	34	2.130	478	0.47	...	721	0.62	...	1462	1.02	...
2.43	28	1.754	68	4.261	478	1.07	1.93	721	1.43	2.57	1462	2.30	4.15
Multiply hp rating by belt length factor to determine drive width—BELT LENGTH FACTOR →													

PULLEYS



HTS® 5 mm Drive Selection Tables

NOMINAL CENTER DISTANCES																					
BELT LENGTH CODE DESIGNATION																					
350	375	400	425	450	475	500	535	565	600	635	670	710	740	800	850	890	950	1000	1050	1125	1195
.8			.9				1.0						1.1					1.2			
...	5.9	7.1	8.1	8.9	10.1	11.1	12.1	13.6	15.0	16.5
5.1	5.6	6.1	6.6	7.1	7.6	8.3	8.8	9.5	10.2	10.9	11.7	12.3	13.5	14.5	15.3	16.4	17.4	18.4	19.9	21.3	22.7
...	...	3.7	4.2	4.7	5.2	5.9	6.5	7.2	7.9	8.6	9.4	10.0	11.2	12.2	13.0	14.1	15.1	16.1	17.6	19.0	20.5
...	4.8	5.5	6.3	7.1	7.7	8.9	9.8	10.6	11.8	12.8	13.8	15.3	16.7	18.2
...	3.9	4.4	4.9	5.6	6.2	6.9	7.6	8.3	9.1	9.7	10.9	11.9	12.7	13.8	14.8	15.8	17.3	18.7	20.2
4.8	5.3	5.8	6.3	6.8	7.3	8.0	8.5	9.2	9.9	10.6	11.4	12.0	13.2	14.2	15.0	16.1	17.1	18.1	19.6	21.0	22.4
...	4.1	4.6	5.3	5.9	6.6	7.3	8.0	8.8	9.4	10.6	11.6	12.4	13.5	14.5	15.5	17.0	18.4	19.9
...	4.3	5.0	5.6	6.3	7.0	7.7	8.5	9.1	10.3	11.3	12.1	13.2	14.2	15.2	16.7	18.1	19.6
4.5	5.0	5.5	6.0	6.5	7.0	7.7	8.2	8.9	9.6	10.3	11.1	11.7	12.9	13.9	14.7	15.8	16.8	17.8	19.3	20.7	22.1
5.3	5.8	6.3	6.8	7.3	7.8	8.5	9.0	9.7	10.4	11.1	11.9	12.5	13.7	14.7	15.4	16.6	17.6	18.6	20.1	21.5	22.9
5.0	5.5	6.0	6.5	7.0	7.5	8.2	8.7	9.4	10.1	10.8	11.6	12.2	13.4	14.4	15.1	16.3	17.3	18.3	19.8	21.2	22.6
4.7	5.2	5.7	6.2	6.7	7.2	7.9	8.4	9.1	9.8	10.5	11.3	11.9	13.1	14.1	14.9	16.0	17.0	18.0	19.5	20.9	22.3
4.4	4.9	5.4	5.9	6.4	6.9	7.6	8.1	8.8	9.5	10.2	11.0	11.6	12.8	13.8	14.6	15.7	16.7	17.7	19.2	20.6	22.0
3.8	4.3	4.8	5.3	5.8	6.3	6.9	7.5	8.2	8.9	9.6	10.4	11.0	12.2	13.2	14.0	15.1	16.1	17.1	18.6	20.0	21.4
3.1	3.6	4.1	4.6	5.1	5.6	6.3	6.9	7.6	8.3	9.0	9.8	10.4	11.6	12.6	13.4	14.5	15.5	16.5	18.0	19.4	20.8
...	3.3	3.8	4.3	4.8	5.3	6.0	6.6	7.3	8.0	8.7	9.5	10.1	11.3	12.3	13.1	14.2	15.2	16.2	17.7	19.1	20.5
...	...	3.5	4.0	4.5	5.0	5.7	6.3	7.0	7.7	8.4	9.2	9.8	11.0	12.0	12.8	13.9	14.9	15.9	17.4	18.8	20.3
...	3.7	4.2	4.7	5.4	6.0	6.7	7.4	8.1	8.9	9.5	10.7	11.7	12.5	13.6	14.6	15.6	17.1	18.5	20.0
...	3.9	4.4	5.1	5.7	6.4	7.1	7.8	8.6	9.2	10.4	11.4	12.2	13.3	14.3	15.3	16.8	18.2	19.7
...	4.4	5.1	5.8	6.5	7.2	8.0	8.6	9.8	10.8	11.5	12.7	13.7	14.7	16.2	17.6	19.1
...	6.0	7.3	8.3	9.1	10.3	11.3	12.3	13.8	15.2	16.6
...	5.0	5.7	6.4	7.2	7.8	9.0	10.0	10.8	12.0	13.0	14.0	15.5	16.9	18.3
...	4.5	5.1	5.8	6.6	7.3	8.1	8.7	9.8	10.8	11.6	12.8	13.8	14.8	16.3	17.7	19.1
4.6	5.1	5.6	6.1	6.6	7.1	7.7	8.3	9.0	9.7	10.4	11.2	11.8	13.0	14.0	14.8	15.9	16.9	17.9	19.4	20.8	22.2
...	3.9	4.5	5.2	5.8	6.5	7.2	7.9	8.7	9.3	10.5	11.5	12.2	13.4	14.4	15.4	16.9	18.3	19.7
4.9	5.4	5.9	6.4	6.9	7.4	8.1	8.6	9.3	10.0	10.7	11.5	12.1	13.3	14.3	15.0	16.2	17.2	18.2	19.7	21.1	22.5
...	3.8	4.3	4.8	5.5	6.1	6.8	7.5	8.2	9.0	9.6	10.8	11.8	12.5	13.7	14.7	15.7	17.2	18.6	20.0
...	...	3.6	4.1	4.6	5.1	5.8	6.4	7.1	7.8	8.5	9.3	9.9	11.1	12.1	12.8	14.0	15.0	16.0	17.5	18.9	20.3
5.2	5.7	6.2	6.7	7.2	7.7	8.4	8.9	9.6	10.3	11.0	11.8	12.4	13.6	14.6	15.3	16.5	17.5	18.5	20.0	21.4	22.8
...	3.4	3.9	4.4	4.9	5.4	6.1	6.7	7.4	8.1	8.8	9.6	10.2	11.4	12.4	13.1	14.3	15.3	16.3	17.8	19.2	20.6
...	5.6	6.2	7.4	8.4	9.2	10.5	11.5	12.4	13.9	15.3	16.8
3.5	4.0	4.5	5.0	5.5	6.0	6.7	7.3	8.0	8.7	9.4	10.2	10.8	12.0	13.0	13.8	14.9	15.9	16.9	18.4	19.8	21.2
4.2	4.7	5.2	5.7	6.2	6.6	7.3	7.9	8.6	9.3	10.0	10.8	11.4	12.6	13.6	14.4	15.5	16.5	17.5	19.0	20.4	21.8
4.5	5.0	5.5	6.0	6.5	7.0	7.6	8.2	8.9	9.6	10.3	11.1	11.7	12.9	13.9	14.6	15.8	16.8	17.8	19.3	20.7	22.1
...	4.6	5.2	5.9	6.6	7.3	8.1	8.7	9.9	10.9	11.7	12.9	13.9	14.9	16.4	17.8	19.2
4.8	5.3	5.8	6.3	6.8	7.3	7.9	8.5	9.2	9.9	10.6	11.4	12.0	13.2	14.2	14.9	16.1	17.1	18.1	19.6	21.0	22.4
...	4.0	4.5	5.3	5.9	6.6	7.3	8.0	8.8	9.4	10.6	11.5	12.3	13.5	14.5	15.5	17.0	18.4	19.8
...	5.2	5.9	6.6	7.4	8.0	9.2	10.2	11.0	12.2	13.2	14.2	15.7	17.1	18.5
...	3.8	4.4	4.9	5.6	6.2	6.9	7.6	8.3	9.1	9.7	10.9	11.8	12.6	13.8	14.8	15.8	17.3	18.7	20.1
5.1	5.6	6.1	6.6	7.1	7.6	8.2	8.8	9.5	10.2	10.9	11.7	12.3	13.5	14.5	15.2	16.4	17.4	18.4	19.9	21.3	22.7
...	...	3.7	4.2	4.7	5.2	5.9	6.5	7.2	7.9	8.6	9.4	10.0	11.2	12.2	12.9	14.1	15.1	16.1	17.6	19.0	20.4
3.3	3.8	4.3	4.8	5.3	5.8	6.5	7.1	7.8	8.5	9.2	10.0	10.6	11.8	12.8	13.5	14.7	15.7	16.7	18.2	19.6	21.0
...	5.7	6.4	7.6	8.6	9.4	10.6	11.6	12.6	14.1	15.5	17.0
...	4.0	4.7	5.3	6.0	6.7	7.4	8.2	8.8	10.0	11.0	11.8	13.0	14.0	15.0	16.5	17.9	19.3
...	4.5	5.3	6.0	6.7	7.5	8.1	9.3	10.3	11.1	12.3	13.3	14.3	15.8	17.1	18.6
4.7	5.2	5.7	6.2	6.7	7.2	7.8	8.4	9.1	9.8	10.5	11.3	11.9	13.1	14.1	14.8	16.0	17.0	18.0	19.5	20.9	22.3
3.9	4.4	4.9	5.4	5.9	6.4	7.1	7.7	8.4	9.1	9.8	10.6	11.2	12.4	13.4	14.1	15.3	16.3	17.3	18.8	20.2	21.6
...	3.6	4.1	4.6	5.3	6.0	6.7	7.4	8.1	8.9	9.5	10.6	11.6	12.4	13.6	14.6	15.6	17.1	18.5	19.9
5.0	5.5	6.0	6.5	7.0	7.5	8.1	8.7	9.4	10.1	10.8	11.6	12.2	13.4	14.4	15.1	16.3	17.3	18.3	19.8	21.2	22.6
...	...	3.4	3.9	4.4	5.0	5.7	6.3	7.0	7.7	8.4	9.2	9.8	10.9	11.9	12.7	13.9	14.9	15.9	17.4	18.8	20.2
.8			.9				1.0						1.1					1.2			

PULLEYS

HTS® 5 mm Drive Selection Tables



Drive Ratio	Sprocket Combination				Driven Speeds and Horsepower Ratings								
	Driver		Driven		1160 RPM Driver			1750 RPM Driver			3550 RPM Driver		
	No. Teeth	P.D.	No. Teeth	P.D.	Driven Speed	HP for Belt Widths		Driven Speed	HP for Belt Widths		Driven Speed	HP for Belt Widths	
						15	25		15	25		15	25
Multiply hp rating by belt length factor to determine drive width—BELT LENGTH FACTOR →													
2.44	18	1.128	44	2.757	475	0.63	1.14	716	0.84	1.52	1452	1.37	2.47
2.50	16	1.065	40	2.506	464	0.55	0.99	700	0.73	1.32	1420	1.19	2.15
2.50	24	1.504	60	3.760	464	0.89	1.61	700	1.19	2.14	1420	1.92	3.46
2.50	32	2.005	80	5.013	464	1.26	2.27	700	1.67	3.01	1420	2.68	4.84
2.50	36	2.256	90	5.639	464	1.45	2.61	700	1.92	3.47	1420	3.07	5.54
2.55	44	2.757	112	7.018	456	1.84	3.32	688	2.44	4.40	1395	3.85	6.94
2.57	14	.877	36	2.256	451	0.47	...	681	0.62	...	1381	1.02	...
2.57	28	1.754	72	4.511	451	1.07	1.93	681	1.43	2.57	1381	2.30	4.15
2.60	20	1.253	52	3.258	446	0.72	1.29	673	0.95	1.75	1365	1.55	2.80
2.65	34	2.130	90	5.639	438	1.35	2.44	661	1.80	3.24	1341	2.88	5.19
2.67	18	1.128	48	3.008	435	0.63	1.14	656	0.84	1.52	1331	1.37	2.47
2.67	24	1.504	64	4.010	435	0.89	1.61	656	1.19	2.14	1331	1.92	3.46
2.67	30	1.880	80	5.013	435	1.16	2.10	656	1.55	2.79	1331	2.49	4.49
2.71	14	.877	38	2.381	427	0.47	...	645	0.62	...	1308	1.02	...
2.75	16	1.003	44	2.757	422	0.55	0.99	636	0.73	1.32	1291	1.19	2.15
2.80	20	1.253	56	3.509	414	0.72	1.29	625	0.95	1.72	1268	1.55	2.80
2.80	40	2.506	112	7.018	414	1.64	2.96	625	2.18	3.93	1268	3.46	6.24
2.81	32	2.005	90	5.639	412	1.26	2.27	622	1.67	3.01	1262	2.68	4.84
2.83	24	1.504	68	4.261	409	0.89	1.61	618	1.19	2.14	1253	1.92	3.46
2.86	14	.877	40	2.506	406	0.47	...	613	0.62	...	1243	1.02	...
2.86	28	1.754	80	5.013	406	1.07	1.93	613	1.43	2.57	1243	2.30	4.15
2.89	18	1.128	52	3.258	402	0.63	1.14	606	0.84	1.52	1229	1.37	2.47
2.95	38	2.381	112	7.018	394	1.54	2.79	594	2.05	3.70	1204	3.27	5.89
3.00	16	1.003	48	3.008	387	0.55	0.99	583	0.73	1.32	1183	1.19	2.15
3.00	20	1.253	60	3.760	387	0.72	1.29	583	0.95	1.72	1183	1.55	2.80
3.00	24	1.504	72	4.511	387	0.89	1.61	583	1.19	2.14	1183	1.92	3.46
3.00	30	1.880	90	5.639	387	1.16	2.10	583	1.55	2.79	1183	2.49	4.49
3.11	18	1.128	56	3.509	373	0.63	1.14	563	0.84	1.52	1141	1.37	2.47
3.11	36	2.256	112	7.018	373	1.45	2.61	563	1.92	3.47	1141	3.07	5.54
3.14	14	.877	44	2.757	369	0.47	...	557	0.62	...	1130	1.02	...
3.20	20	1.253	64	4.010	363	0.72	1.29	547	0.95	1.72	1109	1.55	2.80
3.21	28	1.754	90	5.639	361	1.07	1.93	544	1.43	2.57	1104	2.30	4.15
3.25	16	1.003	52	3.258	357	0.55	0.99	538	0.73	1.32	1092	1.19	2.15
3.29	34	2.130	112	7.018	352	1.35	2.44	531	1.80	3.24	1078	2.88	5.19
3.33	18	1.128	60	3.760	348	0.63	1.14	525	0.84	1.52	1065	1.37	2.47
3.33	24	1.504	80	5.013	348	0.89	1.61	525	1.19	2.14	1065	1.92	3.46
3.40	20	1.253	68	4.261	341	0.72	1.29	515	0.95	1.72	1044	1.55	2.80
6.43	14	.877	48	3.008	338	0.47	...	510	0.62	...	1035	1.02	...
3.50	16	1.003	56	3.509	331	0.55	0.99	500	0.73	1.32	1014	1.19	2.15
3.50	32	2.005	112	7.018	331	1.26	2.27	500	1.67	3.01	1014	2.68	4.84
3.56	18	1.128	64	4.010	326	0.63	1.14	492	0.84	1.52	998	1.37	2.47
3.60	20	1.253	72	4.511	322	0.72	1.29	486	0.95	1.72	986	1.55	2.80
3.71	14	.877	52	3.258	312	0.47	...	471	0.62	...	956	1.02	...
3.73	30	1.880	112	7.018	311	1.16	2.10	469	1.55	2.79	951	2.49	4.49
3.75	16	1.003	60	3.760	309	0.55	0.99	467	0.73	1.32	947	1.19	2.15
3.75	24	1.504	90	5.639	309	0.89	1.61	467	1.19	2.14	947	1.92	3.46
3.78	18	1.128	68	4.261	307	0.63	1.14	463	0.84	1.52	940	1.37	2.47
4.00	14	.877	56	3.509	290	0.47	...	438	0.62	...	888	1.02	...
4.00	16	1.003	64	4.010	290	0.55	0.99	438	0.73	1.32	888	1.19	2.15
4.00	18	1.128	72	4.511	290	0.63	1.14	438	0.84	1.52	888	1.37	2.47
Multiply hp rating by belt length factor to determine drive width—BELT LENGTH FACTOR →													

PULLEYS



HTS® 5 mm Drive Selection Tables

NOMINAL CENTER DISTANCES																					
BELT LENGTH CODE DESIGNATION																					
350	375	400	425	450	475	500	535	565	600	635	670	710	740	800	850	890	950	1000	1050	1125	1195
.8				.9				1.0						1.1				1.2			
3.7	4.2	4.7	5.2	5.7	6.2	6.7	7.4	8.0	8.7	9.4	10.1	10.9	11.5	12.7	13.7	14.4	15.6	16.6	17.6	19.1	20.5
4.1	4.6	5.1	5.6	3.1	6.5	7.0	7.7	8.3	9.0	9.7	10.4	11.2	11.8	13.0	14.0	14.7	15.9	16.9	17.9	19.4	20.8
...	3.0	3.6	4.1	4.6	5.1	5.6	6.3	6.9	7.6	8.3	9.0	9.8	10.4	11.6	12.5	13.3	14.5	15.5	16.5	18.0	19.4
...	4.0	4.8	5.4	6.1	6.8	7.5	8.3	8.9	10.1	11.1	11.9	13.1	14.1	15.1	16.6	17.9
...	4.6	5.3	6.1	6.8	7.6	8.2	9.4	10.4	11.2	12.4	13.4	14.4	15.9	17.2
...	5.9	6.5	7.8	8.8	9.6	10.8	11.8	12.8	14.3	15.7
4.4	4.9	5.4	5.9	6.4	6.9	7.3	8.0	8.6	9.3	10.0	10.7	11.5	12.1	13.3	14.3	15.0	16.2	17.2	18.2	19.7	21.1
...	3.7	4.2	4.7	5.4	6.0	6.7	7.4	8.1	8.9	9.5	10.7	11.7	12.5	13.7	14.7	15.7	17.2	18.5
3.2	3.7	4.2	4.7	5.2	5.7	6.2	6.9	7.5	8.2	8.9	9.6	10.4	11.0	12.2	13.1	13.9	15.1	16.1	17.1	18.6	20.0
...	4.7	5.4	6.1	6.9	7.7	8.3	9.5	10.5	11.3	12.5	13.5	14.5	15.9	17.3
3.5	4.0	4.5	5.0	5.5	6.0	6.5	7.2	7.8	8.5	9.2	9.9	10.7	11.3	12.5	13.5	14.2	15.4	16.4	17.4	18.9	20.3
...	...	3.3	3.8	4.3	4.9	5.4	6.1	6.7	7.4	8.1	8.8	9.6	10.2	11.3	12.3	13.1	14.3	15.3	16.3	17.8	19.2
...	4.1	4.9	5.5	6.2	6.9	7.6	8.4	9.0	10.2	11.2	12.0	13.2	14.2	15.2	16.7	18.0
4.3	4.8	5.3	5.8	6.3	6.7	7.2	7.9	8.5	9.2	9.9	10.6	11.4	12.0	13.2	14.2	14.9	16.1	17.1	18.1	19.6	21.0
3.8	4.3	4.8	5.3	5.8	6.3	6.8	7.5	8.1	8.8	9.5	10.2	11.0	11.6	12.8	13.8	14.5	15.7	16.7	17.7	19.2	20.6
2.9	3.5	4.0	4.5	5.0	5.5	6.0	6.7	7.3	8.0	8.7	9.4	10.2	10.8	12.0	12.9	13.7	14.9	15.9	16.9	18.4	19.8
...	5.2	6.1	6.7	7.9	9.0	9.8	11.0	12.0	13.0	14.5	15.9
...	4.8	5.5	6.2	6.9	7.7	8.4	9.6	10.6	11.4	12.6	13.6	14.5	16.0	17.4
...	3.6	4.1	4.6	5.1	5.8	6.4	7.1	7.8	8.5	9.3	9.9	11.1	12.1	12.9	14.1	15.1	16.1	17.6	18.9
4.1	4.6	5.1	5.6	6.1	6.6	7.1	7.8	8.4	9.1	9.8	10.5	11.3	11.9	13.1	14.1	14.8	16.0	17.0	18.0	19.5	20.9
...	4.2	4.9	5.6	6.3	7.0	7.7	8.5	9.1	10.3	11.3	12.1	13.3	14.3	15.3	16.7	18.1
3.3	3.8	4.3	4.8	5.3	5.8	6.3	7.0	7.6	8.3	9.0	9.7	10.5	11.1	12.3	13.2	14.0	15.2	16.2	17.2	18.7	20.0
...	5.3	6.2	6.8	8.0	9.0	9.9	11.1	12.1	13.1	14.6	16.0
3.6	4.1	4.6	5.1	5.6	6.1	6.6	7.3	7.9	8.6	9.3	10.0	10.8	11.4	12.6	13.5	14.3	15.5	16.5	17.5	19.0	20.3
...	3.2	3.7	4.2	4.7	5.3	5.8	6.5	7.1	7.8	8.5	9.2	10.0	10.6	11.7	12.7	13.5	14.7	15.7	16.7	18.2	19.5
...	3.8	4.4	4.9	5.6	6.2	6.9	7.6	8.3	9.1	9.7	10.9	11.9	12.7	13.9	14.9	15.9	17.4	18.7
...	4.2	4.9	5.6	6.3	7.0	7.8	8.4	9.6	10.7	11.5	12.6	13.6	14.6	16.1	17.5
3.0	3.5	4.1	4.6	5.1	5.6	6.1	6.8	7.4	8.1	8.8	9.5	10.3	10.9	12.0	13.0	13.8	15.0	16.0	17.0	18.5	19.8
...	5.4	6.2	6.9	8.1	9.1	9.9	11.2	12.2	13.2	14.7	16.1
3.9	4.4	4.9	5.4	5.9	6.4	6.9	7.6	8.2	8.9	9.6	10.3	11.1	11.7	12.9	13.8	14.6	15.8	16.8	17.8	19.3	20.6
...	...	3.5	4.0	4.5	5.0	5.5	6.2	6.8	7.5	8.2	8.9	9.7	10.3	11.5	12.5	13.3	14.5	15.5	16.5	18.0	19.3
...	4.3	4.9	5.7	6.4	7.1	7.9	8.5	9.7	10.7	11.5	12.7	13.7	14.7	16.2	17.6
3.3	3.9	4.4	4.9	5.4	5.9	6.4	7.1	7.7	8.4	9.1	9.8	10.6	11.2	12.3	13.3	14.1	15.3	16.3	17.3	18.8	20.1
...	5.5	6.3	6.9	8.2	9.2	10.0	11.2	12.2	13.2	14.7	16.1
...	3.3	3.8	4.3	4.8	5.3	5.8	6.6	7.2	7.9	8.6	9.3	10.0	10.6	11.8	12.8	13.6	14.8	15.8	16.8	18.3	19.6
...	3.8	4.4	5.1	5.7	6.4	7.2	7.9	8.7	9.3	10.5	11.5	12.3	13.5	14.5	15.4	16.9	18.3
...	...	3.2	3.7	4.3	4.8	5.3	6.0	6.6	7.3	8.0	8.7	9.5	10.1	11.3	12.3	13.1	14.3	15.3	16.3	17.7	19.1
3.7	4.2	4.7	5.2	5.7	6.2	6.7	7.4	8.0	8.7	9.4	10.1	10.9	11.5	12.6	13.6	14.4	15.6	16.6	17.6	19.1	20.4
3.1	3.6	4.1	4.6	5.2	5.7	6.2	6.9	7.5	8.2	8.9	9.6	10.4	10.9	12.1	13.1	13.9	15.1	16.1	17.1	18.6	19.9
...	5.5	6.4	7.0	8.3	9.3	10.1	11.3	12.3	13.3	14.8	16.2
...	3.0	3.5	4.1	4.6	5.1	5.6	6.3	6.9	7.6	8.3	9.0	9.8	10.4	11.6	12.6	13.4	14.6	15.6	16.6	18.0	19.4
...	3.5	4.0	4.5	5.0	5.8	6.4	7.1	7.8	8.5	9.3	9.9	11.1	12.1	12.9	14.1	15.1	16.1	17.5	18.9
3.4	3.9	4.5	5.0	5.5	6.0	6.5	7.2	7.8	8.5	9.2	9.9	10.7	11.3	12.4	13.4	14.2	15.4	16.4	17.4	18.9	20.2
...	4.9	5.6	6.5	7.1	8.4	9.4	10.2	11.4	12.4	13.4	14.9	16.3
2.8	3.4	3.9	4.4	4.9	5.4	5.9	6.6	7.2	7.9	8.6	9.3	10.1	10.7	11.9	12.9	13.7	14.9	15.9	16.9	18.4	19.7
...	4.5	5.1	5.8	6.6	7.3	8.1	8.7	9.9	10.9	11.7	12.9	13.9	14.9	16.4	17.8
...	...	3.3	3.8	4.3	4.9	5.4	6.1	6.7	7.4	8.1	8.8	9.6	10.2	11.4	12.4	13.2	14.4	15.4	16.4	17.8	19.2
3.2	3.7	4.2	4.7	5.2	5.7	6.3	7.0	7.6	8.3	9.0	9.6	10.4	11.0	12.2	13.2	14.0	15.2	16.2	17.2	18.7	20.0
...	3.1	3.6	4.2	4.7	5.2	5.7	6.4	7.0	7.7	8.4	9.1	9.9	10.5	11.7	12.7	13.5	14.7	15.7	16.7	18.1	19.5
...	3.5	4.1	4.6	5.1	5.8	6.5	7.2	7.9	8.6	9.4	10.0	11.2	12.2	13.0	14.2	15.2	16.1	17.6	19.0
.8				.9				1.0						1.1				1.2			

PULLEYS

HTS® 5 mm Drive Selection Tables



Drive Ratio	Sprocket Combination				Driven Speeds and Horsepower Ratings								
	Driver		Driven		1160 RPM Driver			1750 RPM Driver			3550 RPM Driver		
	No. Teeth	P.D.	No. Teeth	P.D.	Driven Speed	HP for Belt Widths		Driven Speed	HP for Belt Widths		Driven Speed	HP for Belt Widths	
						15	25		15	25		15	25
Multiply hp rating by belt length factor to determine drive width—BELT LENGTH FACTOR →													
4.00	20	1.253	80	5.013	290	0.72	1.29	438	0.95	1.72	888	1.55	2.80
4.00	28	1.754	112	7.018	290	1.07	1.93	438	1.43	2.57	888	2.30	4.15
4.25	16	1.003	68	4.261	273	0.55	0.99	412	0.73	1.32	835	1.19	2.15
4.29	14	.877	60	3.760	271	0.47	...	408	0.62	...	828	1.02	...
4.44	18	1.128	80	5.013	261	0.63	1.14	394	0.84	1.52	799	1.37	2.47
4.50	16	1.003	72	4.511	258	0.55	0.99	389	0.73	1.32	789	1.19	2.15
4.50	20	1.253	90	5.639	258	0.72	1.29	389	0.95	1.72	789	1.55	2.80
4.57	14	.877	64	4.010	254	0.47	...	383	0.62	...	777	1.02	...
4.67	24	1.504	112	7.018	249	0.89	1.61	375	1.19	2.14	761	1.92	3.46
4.86	14	.877	68	4.261	239	0.47	...	360	0.62	...	731	1.02	...
5.00	16	1.003	80	5.013	232	0.55	0.99	350	0.73	1.32	710	1.19	2.15
5.00	18	1.128	90	5.639	232	0.63	1.14	350	0.84	1.52	710	1.37	2.47
5.14	14	.877	72	4.511	226	0.47	...	340	0.62	...	690	1.02	...
5.60	20	1.253	112	7.018	207	0.72	1.29	313	0.95	1.72	634	1.55	2.80
5.63	16	1.003	90	5.639	206	0.55	0.99	311	0.73	1.32	631	1.19	2.15
5.71	14	.877	80	5.013	203	0.47	...	306	0.62	...	621	1.02	...
6.22	18	1.128	112	7.018	186	0.63	1.14	281	0.84	1.52	571	1.37	2.47
6.43	14	.877	90	5.639	180	0.47	...	272	0.62	...	552	1.02	...
7.00	16	1.003	112	7.018	166	0.55	0.99	250	0.73	1.32	507	1.19	2.15
8.00	14	.877	112	7.018	145	0.47	...	219	0.62	...	444	1.02	...
Multiply hp rating by belt length factor to determine drive width—BELT LENGTH FACTOR →													



HTS® 5 mm Drive Selection Tables

NOMINAL CENTER DISTANCES																						
BELT LENGTH CODE DESIGNATION																						
400	425	450	475	500	535	565	600	635	670	710	740	800	850	890	950	1000	1050	1125	1195	1270	1420	
.8		.9				1.0						1.1					1.2					
...	4.0	4.5	5.3	5.9	6.6	7.3	8.0	8.8	9.4	10.7	11.7	12.4	13.6	14.6	15.6	17.1	18.5	20.0	23.0	
...	4.9	5.7	6.6	7.2	8.4	9.5	10.3	11.5	12.5	13.5	15.0	16.4	17.9	20.9	
3.4	3.9	4.4	4.9	5.5	6.2	6.8	7.5	8.2	8.9	9.7	10.3	11.5	12.5	13.3	14.5	15.5	16.5	17.9	19.3	20.8	23.8	
4.0	4.5	5.0	5.5	6.0	6.7	7.3	8.0	8.7	9.4	10.2	10.8	12.0	13.0	13.8	15.0	16.0	17.0	18.4	19.8	21.3	24.3	
...	...	3.5	4.1	4.6	5.4	6.0	6.7	7.4	8.1	8.9	9.5	10.7	11.7	12.5	13.7	14.7	15.7	17.2	18.6	20.1	23.0	
...	3.6	4.2	4.7	5.2	5.9	6.5	7.3	8.0	8.7	9.5	10.1	11.3	12.3	13.1	14.3	15.2	16.2	17.7	19.1	20.6	23.6	
...	3.8	4.6	5.3	6.0	6.7	7.4	8.3	8.9	10.1	11.1	11.9	13.1	14.1	15.1	16.6	18.0	19.5	22.4	
3.7	4.2	4.8	5.3	5.8	6.5	7.1	7.8	8.5	9.2	10.0	10.6	11.8	12.8	13.6	14.8	15.8	16.8	18.2	19.6	21.1	24.1	
...	5.1	5.9	6.7	7.4	8.6	9.6	10.4	11.7	12.7	13.7	15.2	16.6	18.1	21.1	
3.4	4.0	4.5	5.0	5.5	6.3	6.9	7.6	8.3	9.0	9.8	10.4	11.6	12.6	13.4	14.6	15.6	16.5	18.0	19.4	20.9	23.9	
...	...	3.6	4.2	4.7	5.4	6.1	6.8	7.5	8.2	9.0	9.6	10.8	11.8	12.6	13.8	14.8	15.8	17.3	18.7	20.2	23.1	
...	3.9	4.7	5.3	6.1	6.8	7.5	8.3	9.0	10.2	11.2	12.0	13.2	14.2	15.2	16.7	18.1	19.5	22.5	
3.2	3.7	4.2	4.8	5.3	6.0	6.6	7.3	8.1	8.8	9.6	10.2	11.4	12.4	13.2	14.3	15.3	16.3	17.8	19.2	20.7	23.6	
...	5.3	6.0	6.9	7.5	8.8	9.8	10.6	11.8	12.8	13.9	15.4	16.8	18.3	21.2	
...	4.0	4.8	5.4	6.2	6.9	7.6	8.4	9.0	10.3	11.3	12.1	13.3	14.3	15.3	16.8	18.1	19.6	22.6	
...	...	3.7	4.2	4.8	5.5	6.1	6.9	7.6	8.3	9.1	9.7	10.9	11.9	12.7	13.9	14.9	15.9	17.4	18.8	20.3	23.2	
...	4.5	5.3	6.1	7.0	7.6	8.8	9.9	10.7	11.9	12.9	13.9	15.5	16.9	18.4	21.3	
...	4.1	4.8	5.5	6.2	7.0	7.7	8.5	9.1	10.3	11.4	12.2	13.4	14.4	15.4	16.8	18.2	19.7	22.7	
...	4.6	5.4	6.2	7.0	7.7	8.9	10.0	10.8	12.0	13.0	14.0	15.5	16.9	18.4	21.4	
...	4.7	5.5	6.3	7.1	7.8	9.0	10.0	10.9	12.1	13.1	14.1	15.6	17.0	18.5	21.5	
.8		.9				1.0						1.1					1.2					

HTS® 8 mm Drive Selection Tables



DN RPM	Drive Ratio	Sprocket Combination				HP Ratings @ 1750 RPM Driver							
		Driver		Driven		RPPTM Belt Widths				RPPTM PLUS Belt Widths			
		No. Teeth	P.D.	No. Teeth	P.D.	20	30	50	85	20	30	50	85
Multiply hp rating by belt length factor to determine drive width—BELT LENGTH FACTOR →													
1750	1.00	22	2.206	22	2.206	3.99	6.34	11.0	...	5.99	9.47	16.4	...
1750	1.00	24	2.406	24	2.406	4.35	6.91	12.0	...	6.60	10.4	18.1	...
1750	1.00	26	2.607	26	2.607	4.71	7.48	12.9	...	7.22	11.4	19.8	...
1750	1.00	28	2.807	28	2.807	5.61	8.92	15.4	...	7.83	12.4	21.5	...
1750	1.00	30	3.008	30	3.008	6.10	9.70	16.8	...	8.46	13.4	23.2	...
1750	1.00	32	3.208	32	3.208	6.72	10.7	18.5	...	9.08	14.4	24.9	...
1750	1.00	34	3.409	34	3.409	7.67	12.2	21.1	36.7	9.71	15.4	26.6	46.4
1750	1.00	36	3.609	36	3.609	9.85	15.7	27.7	47.1	10.3	16.4	28.4	49.4
1750	1.00	38	3.810	38	3.810	10.3	16.4	28.4	49.4	11.0	17.4	30.1	52.4
1750	1.00	40	4.010	40	4.010	10.8	17.2	29.8	51.8	11.6	18.4	31.9	55.5
1750	1.00	44	4.411	44	4.411	11.8	18.8	32.5	56.4	12.9	20.4	35.4	61.6
1750	1.00	48	4.812	48	4.812	12.7	20.3	35.1	60.9	14.2	22.4	38.9	67.7
1750	1.00	56	5.614	56	5.614	14.6	23.2	40.0	69.6	16.8	26.5	46.0	80.1
1750	1.00	64	6.416	64	6.416	16.3	25.9	44.8	77.8	19.3	30.6	53.1	92.5
1750	1.00	72	7.218	72	7.218	17.9	28.4	49.2	85.5	21.9	34.7	60.2	105
1750	1.00	80	8.020	80	8.020	19.4	30.8	53.3	92.7	24.4	38.7	67.2	117
1663	1.05	38	3.810	40	4.010	10.3	16.4	28.4	49.4	11.0	17.4	30.1	52.4
1658	1.06	36	3.609	38	3.810	9.85	15.7	27.1	47.1	10.3	16.4	28.4	49.4
1653	1.06	34	3.409	36	3.609	7.67	12.2	21.1	36.7	9.71	15.4	26.6	46.4
1647	1.06	32	3.208	34	3.409	6.72	10.7	18.5	...	9.08	14.4	24.9	...
1641	1.07	30	3.008	32	3.208	6.10	9.70	16.8	...	8.46	13.4	23.2	...
1633	1.07	28	2.807	30	3.008	5.61	8.92	15.4	...	7.83	12.4	21.5	...
1625	1.08	26	2.607	28	2.807	4.71	7.48	12.9	...	7.22	11.4	19.8	...
1615	1.08	24	2.406	26	2.607	4.35	6.91	12.0	...	6.60	10.4	18.1	...
1604	1.09	22	2.206	24	2.406	3.99	6.34	11.0	...	5.99	9.47	16.4	...
1604	1.09	44	4.411	48	4.812	11.8	18.8	32.5	56.4	12.9	20.4	35.4	61.6
1591	1.10	40	4.010	44	4.411	10.8	17.2	29.8	51.8	11.6	18.4	31.9	55.5
1575	1.11	36	3.609	40	4.010	9.85	15.7	27.1	47.1	10.3	16.4	28.4	49.4
1575	1.11	72	7.218	80	8.020	17.9	28.4	49.2	85.5	21.9	34.7	60.2	105
1566	1.12	34	3.409	38	3.810	7.67	12.2	21.1	36.7	9.71	15.4	26.6	46.4
1556	1.13	32	3.208	36	3.609	6.72	10.7	18.5	...	9.08	14.4	24.9	...
1556	1.13	64	6.416	72	7.218	16.3	25.9	44.8	77.8	19.3	30.6	53.1	92.5
1556	1.13	80	8.020	90	9.023	19.4	30.8	53.3	92.7	24.4	38.7	67.2	117
1544	1.13	30	3.008	34	3.409	6.10	9.70	16.8	...	8.46	13.4	23.2	...
1531	1.14	28	2.807	32	3.208	5.61	8.92	15.4	...	7.83	12.4	21.5	...
1531	1.14	56	5.614	64	6.416	14.6	23.2	40.0	69.6	16.8	26.5	46.0	80.1
1517	1.15	26	2.607	30	3.008	4.71	7.48	12.9	...	7.22	11.4	19.8	...
1511	1.16	38	3.810	44	4.411	10.3	16.4	28.4	49.4	11.0	17.4	30.1	52.4
1500	1.17	24	2.406	28	2.807	4.35	6.91	12.0	...	6.60	10.4	18.1	...
1500	1.17	48	4.812	56	5.614	12.7	20.3	35.1	60.9	14.2	22.4	38.9	67.7
1488	1.18	34	3.409	40	4.010	7.67	12.2	21.1	36.7	9.71	15.4	26.6	46.4
1481	1.18	22	2.206	26	2.607	3.99	6.34	11.0	...	5.99	9.47	16.4	...
1474	1.19	32	3.208	38	3.810	6.72	10.7	18.5	...	9.08	14.4	24.9	...
1458	1.20	30	3.008	36	3.609	6.10	9.70	16.8	...	8.46	13.4	23.2	...
1458	1.20	40	4.010	48	4.812	10.8	17.2	29.8	51.8	11.6	18.4	31.9	55.5
1441	1.21	28	2.807	34	3.409	5.61	8.92	15.4	...	7.83	12.4	21.5	...
1432	1.22	36	3.609	44	4.411	9.85	15.7	27.1	47.1	10.3	16.4	28.4	49.4
1422	1.23	26	2.607	32	3.208	4.71	7.48	12.9	...	7.22	11.4	19.8	...
1400	1.25	24	2.406	30	3.008	4.35	6.91	12.0	...	6.60	10.4	18.1	...
1400	1.25	32	3.208	40	4.010	6.72	10.7	18.5	...	9.08	14.4	24.9	...
Multiply hp rating by belt length factor to determine drive width—BELT LENGTH FACTOR →													



HTS® 8 mm Drive Selection Tables

NOMINAL CENTER DISTANCES																								
BELT LENGTH CODE DESIGNATION																								
480	536	560	600	640	720	800	880	960	1040	1120	1200	1224	1280	1440	1600	1760	1800	2000	2400	2600	2800			
.8				.9				1.0					1.1				1.2							
6.0	7.1	7.6	8.3	9.1	10.7	12.3	13.9	15.4	17.0	18.6	20.2	20.6	21.7	24.9	28.0	31.2	32.0	35.9	43.8	47.7	51.7			
5.7	6.8	7.2	8.0	8.8	10.4	12.0	13.5	15.1	16.7	18.3	19.8	20.3	21.4	24.6	27.7	30.9	31.7	35.6	43.5	47.4	51.3			
5.4	6.5	6.9	7.7	8.5	10.1	11.7	13.2	14.8	16.4	18.0	19.5	20.0	21.1	24.3	27.4	30.6	31.3	35.3	43.2	47.1	51.0			
5.0	6.1	6.6	7.4	8.2	9.8	11.3	12.9	14.5	16.1	17.6	19.2	19.7	20.8	23.9	27.1	30.2	31.0	35.0	42.8	46.8	50.7			
4.7	5.8	6.3	7.1	7.9	9.5	11.0	12.6	14.2	15.8	17.3	18.9	19.4	20.5	23.6	26.8	29.9	30.7	34.6	42.5	46.5	50.4			
4.4	5.5	6.0	6.8	7.6	9.1	10.7	12.3	13.9	15.4	17.0	18.6	19.1	20.2	23.3	26.5	29.6	30.4	34.3	42.2	46.1	50.1			
...	5.2	5.7	6.5	7.2	8.8	10.4	12.0	13.5	15.1	16.7	18.3	18.7	19.8	23.0	26.1	29.3	30.1	34.0	41.9	45.8	49.8			
...	4.9	5.4	6.1	6.9	8.5	10.1	11.7	13.2	14.8	16.4	18.0	18.4	19.5	22.7	25.8	29.0	29.8	33.7	41.6	45.5	49.5			
...	4.6	5.0	5.8	6.6	8.2	9.8	11.3	12.9	14.5	16.1	17.6	18.1	19.2	22.4	25.5	28.7	29.5	33.4	41.3	45.2	49.1			
...	5.5	6.3	7.9	9.5	11.0	12.6	14.2	15.8	17.3	17.8	18.9	22.1	25.2	28.3	29.1	33.1	40.9	44.9	48.8			
...	5.7	7.2	8.8	10.4	12.0	13.5	15.1	16.7	17.2	18.3	21.4	24.6	27.7	28.5	32.4	40.3	44.3	48.2			
...	6.6	8.2	9.8	11.3	12.9	14.5	16.1	16.5	17.6	20.8	23.9	27.1	27.9	31.8	39.7	43.6	47.6			
...	6.9	8.5	10.1	11.7	13.2	14.8	15.3	16.4	19.5	22.7	25.8	26.6	30.6	38.4	42.4	46.3			
...	7.2	8.8	10.4	12.0	13.5	14.0	15.1	18.3	21.4	24.6	25.4	29.3	37.2	41.1	45.0			
...	9.1	10.7	12.3	12.8	13.6	17.0	20.2	23.3	24.1	28.0	35.9	39.8	43.8			
...	9.5	11.0	11.5	12.6	15.8	18.9	22.1	22.8	26.8	34.7	38.6	42.5			
...	...	4.9	5.7	6.5	8.0	9.6	11.2	12.8	14.3	15.9	17.5	18.0	19.1	22.2	25.4	28.5	29.3	33.2	41.1	45.0	49.0			
...	4.7	5.2	6.0	6.8	8.3	9.9	11.5	13.1	14.6	16.2	17.8	18.3	19.4	22.5	25.7	28.8	29.6	33.5	41.4	45.4	49.3			
...	5.0	5.5	6.3	7.1	8.7	10.2	11.8	13.4	15.0	16.5	18.1	18.6	19.7	22.8	26.0	29.1	29.9	33.9	41.7	45.7	49.6			
4.3	5.4	5.8	6.6	7.4	9.0	10.6	12.1	13.7	15.3	16.9	18.4	18.9	20.0	23.2	26.3	29.5	30.2	34.2	42.0	46.0	49.9			
4.6	5.7	6.1	6.9	7.7	9.3	10.9	12.4	14.0	15.6	17.2	18.7	19.2	20.3	23.5	26.6	29.8	30.6	34.5	42.4	46.3	50.2			
4.9	6.0	6.5	7.2	8.0	9.6	11.2	12.8	14.3	15.9	17.5	19.1	19.5	20.6	23.8	26.9	30.1	30.9	34.8	42.7	46.6	50.6			
5.2	6.3	6.8	7.6	8.3	9.9	11.5	13.1	14.6	16.2	17.8	19.4	19.8	20.9	24.1	27.2	30.4	31.2	35.1	43.0	46.9	50.9			
5.5	6.6	7.1	7.9	8.7	10.2	11.8	13.4	15.0	16.5	18.1	19.7	20.2	21.3	24.4	27.6	30.7	31.5	35.4	43.3	47.2	51.2			
5.8	6.9	7.4	8.2	9.0	10.6	12.1	13.7	15.3	16.9	18.4	20.0	20.5	21.6	24.7	27.9	31.0	31.8	35.7	43.6	47.6	51.5			
...	6.9	8.5	10.1	11.7	13.2	14.8	16.4	16.9	18.0	21.1	24.3	27.4	28.2	32.1	40.0	43.9	47.9			
...	5.2	6.0	7.6	9.1	10.7	12.3	13.9	15.4	17.0	17.5	18.6	21.7	24.9	28.0	28.8	32.8	40.6	44.6	48.5			
...	4.6	5.0	5.8	6.6	8.2	9.8	11.3	12.9	14.5	16.1	17.6	18.1	19.2	22.4	25.5	28.7	29.5	33.4	41.3	45.2	49.1			
...	8.5	10.1	11.7	12.1	13.2	16.4	19.5	22.7	23.5	27.4	35.3	39.2	43.2			
...	4.9	5.4	6.1	6.9	8.5	10.1	11.7	13.2	14.8	16.4	18.0	18.4	19.5	22.7	25.8	29.0	29.8	33.7	41.6	45.5	49.5			
...	5.2	5.7	6.5	7.2	8.8	10.4	12.0	13.5	15.1	16.7	18.3	18.7	19.8	23.0	26.1	29.3	30.1	34.0	41.9	45.8	49.8			
...	8.2	9.8	11.3	12.9	13.4	14.5	17.6	20.8	23.9	24.7	28.7	36.5	40.5	44.4			
...	10.2	10.7	11.8	15.0	18.1	21.3	22.0	26.0	33.9	37.8	41.7			
4.4	5.5	6.0	6.8	7.6	9.1	10.7	12.3	13.9	15.4	17.0	18.6	19.1	20.2	23.3	26.5	29.6	30.4	34.3	42.2	46.1	50.1			
4.7	5.8	6.3	7.1	7.9	9.4	11.0	12.6	14.2	15.7	17.3	18.9	19.4	20.5	23.6	26.8	29.9	30.7	34.6	42.5	46.5	50.4			
...	7.9	9.4	11.0	12.6	14.2	14.6	15.7	18.9	22.0	25.2	26.0	29.9	37.8	41.7	45.7			
5.0	6.1	6.6	7.4	8.2	9.8	11.3	12.9	14.5	16.1	17.6	19.2	19.7	20.8	23.9	27.1	30.2	31.0	35.0	42.8	46.8	50.7			
...	5.3	6.1	7.7	9.3	10.9	12.4	14.0	15.6	17.2	17.6	18.7	21.9	25.0	28.2	29.0	32.9	40.8	44.7	48.7			
5.4	6.5	6.9	7.7	8.5	10.1	11.7	13.2	14.8	16.4	18.0	19.5	20.0	21.1	24.3	27.4	30.6	31.3	35.3	43.2	47.1	51.0			
...	6.0	7.6	9.1	10.7	12.3	13.9	15.4	15.9	17.0	20.2	23.3	26.5	27.2	31.2	39.1	43.0	46.9			
...	4.7	5.2	6.0	6.8	8.3	9.9	11.5	13.1	14.6	16.2	17.8	18.3	19.4	22.5	25.7	28.8	29.6	33.5	41.4	45.4	49.3			
5.7	6.8	7.2	8.0	8.8	10.4	12.0	13.5	15.1	16.7	18.3	19.8	20.3	21.4	24.6	27.7	30.9	31.7	35.6	43.5	47.4	51.3			
...	5.0	5.5	6.3	7.1	8.7	10.2	11.8	13.4	15.0	16.5	18.1	18.6	19.7	22.8	26.0	29.1	29.9	33.9	41.7	45.7	49.6			
4.2	5.3	5.8	6.6	7.4	9.0	10.5	12.1	13.7	15.3	16.9	18.4	18.9	20.0	23.2	26.3	29.4	30.2	34.2	42.0	46.0	49.9			
...	5.7	7.2	8.8	10.4	12.0	13.5	15.1	16.7	17.2	18.3	21.4	24.6	27.7	28.5	32.4	40.3	44.3	48.2			
4.6	5.7	6.1	6.9	7.7	9.3	10.9	12.4	14.0	15.6	17.2	18.7	19.2	20.3	23.5	26.6	29.8	30.6	34.5	42.4	46.3	50.2			
...	5.5	6.3	7.9	9.4	11.0	12.6	14.2	15.7	17.3	17.8	18.9	22.0	25.2	28.3	29.1	33.1	40.9	44.9	48.8			
4.9	6.0	6.5	7.2	8.0	9.6	11.2	12.8	14.3	15.9	17.5	19.1	19.5	20.6	23.8	26.9	30.1	30.9	34.8	42.7	46.6	50.6			
5.2	6.3	6.8	7.6	8.3	9.9	11.5	13.1	14.6	16.2	17.8	19.4	19.8	20.9	24.1	27.2	30.4	31.2	35.1	43.0	46.9	50.9			
...	4.9	5.3	6.1	6.9	8.5	10.1	11.6	13.2	14.8	16.4	18.0	18.4	19.5	22.7	25.8	29.0	29.8	33.7	41.6	45.5	49.4			
.8				.9				1.0					1.1				1.2							

PULLEYS

HTS® 8 mm Drive Selection Tables



DN RPM	Drive Ratio	Sprocket Combination				HP Ratings @ 1750 RPM Driver							
		Driver		Driven		RPPTM Belt Widths				RPPTM PLUS Belt Widths			
		No. Teeth	P.D.	No. Teeth	P.D.	20	30	50	85	20	30	50	85
Multiply hp rating by belt length factor to determine drive width—BELT LENGTH FACTOR →													
1400	1.25	64	6.416	80	8.020	16.30	25.90	44.8	77.8	19.30	30.60	53.1	92.5
1400	1.25	72	7.218	90	9.023	17.90	28.40	49.2	85.5	21.90	34.70	60.2	105.0
1385	1.26	38	3.810	48	4.812	10.30	16.40	28.4	49.4	11.00	17.40	30.1	52.4
1382	1.27	30	3.008	38	3.810	6.10	9.70	16.8	...	8.46	13.40	23.2	...
1375	1.27	22	2.206	28	2.807	3.99	6.34	11.0	...	5.99	9.47	16.4	...
1375	1.27	44	4.411	56	5.614	11.80	18.80	32.5	56.4	12.90	20.40	35.4	61.6
1361	1.29	28	2.807	36	3.609	5.61	8.92	15.4	...	7.83	12.40	21.5	...
1361	1.29	56	5.614	72	7.218	14.60	23.20	40.0	69.6	16.80	26.50	16.0	80.1
1352	1.29	34	3.409	44	4.411	7.67	12.20	21.1	36.7	9.71	15.40	26.6	46.4
1338	1.31	26	2.607	34	3.409	4.71	7.48	12.9	...	7.22	11.40	19.8	...
1313	1.33	24	2.406	32	3.208	4.35	6.91	12.0	...	6.60	10.40	18.1	...
1313	1.33	30	3.008	40	4.010	6.10	9.70	16.8	...	8.46	13.40	23.2	...
1313	1.33	36	3.609	48	4.812	9.85	15.70	27.1	47.1	10.30	16.40	28.4	49.4
1313	1.33	48	4.812	64	6.416	12.70	20.30	35.1	60.9	14.20	22.40	38.9	67.7
1289	1.36	28	2.807	38	3.810	5.61	8.92	15.4	...	7.83	12.40	21.5	...
1283	1.36	22	2.206	30	3.008	3.99	6.34	11.0	...	5.99	9.47	16.4	...
1273	1.38	32	3.208	44	4.411	6.72	10.70	18.5	...	9.08	14.40	24.9	...
1264	1.38	26	2.607	36	3.609	4.71	7.48	12.9	...	7.22	11.40	19.8	...
1250	1.40	40	4.010	56	5.614	10.80	17.20	29.8	51.8	11.60	18.40	31.9	55.5
1250	1.40	80	8.020	112	11.229	19.40	30.80	53.3	92.7	24.40	38.70	67.2	117.0
1244	1.41	64	6.416	90	9.023	16.30	25.90	44.8	77.8	19.30	30.60	53.1	92.5
1240	1.41	34	3.409	48	4.812	7.67	12.20	21.1	36.7	9.71	15.40	26.6	46.4
1235	1.42	24	2.406	34	3.409	4.35	6.91	12.0	...	6.60	10.40	18.1	...
1225	1.43	28	2.807	40	4.010	5.61	8.92	15.4	...	7.83	12.40	21.5	...
1225	1.43	56	5.614	80	8.020	14.60	23.20	40.0	69.6	16.80	26.50	16.0	80.1
1203	1.45	22	2.206	32	3.208	3.99	6.34	11.0	...	5.99	9.47	16.4	...
1203	1.45	44	4.411	64	6.416	11.80	18.80	32.5	56.4	12.90	20.40	35.4	61.6
1197	1.46	26	2.607	38	3.810	4.71	7.48	12.9	...	7.22	11.40	19.8	...
1193	1.47	30	3.008	44	4.411	6.10	9.70	16.8	...	8.46	13.40	23.2	...
1188	1.47	38	3.810	56	5.614	10.30	16.40	28.4	49.4	11.00	17.40	30.1	52.4
1167	1.50	24	2.406	36	3.609	4.35	6.91	12.0	...	6.60	10.40	18.1	...
1167	1.50	32	3.208	48	4.812	6.72	10.70	18.5	...	9.08	14.40	24.9	...
1167	1.50	48	4.812	72	7.218	12.70	20.30	35.1	60.9	14.20	22.40	38.9	67.7
1138	1.54	26	2.607	40	4.010	4.71	7.48	12.9	...	7.22	11.40	19.8	...
1132	1.55	22	2.206	34	3.409	3.99	6.34	11.0	...	5.99	9.47	16.4	...
1125	1.56	36	3.609	56	5.614	9.85	15.70	27.1	47.1	10.30	16.40	28.4	49.4
1125	1.56	72	7.218	112	11.229	17.90	28.40	49.2	85.5	21.90	34.70	60.2	105.0
1114	1.57	28	2.807	44	4.411	5.61	8.92	15.4	...	7.83	12.40	21.5	...
1105	1.58	24	2.406	38	3.810	4.35	6.91	12.0	...	6.60	10.40	18.1	...
1094	1.60	30	3.008	48	4.812	6.10	9.70	16.8	...	8.46	13.40	23.2	...
1094	1.60	40	4.010	64	6.416	10.80	17.20	29.8	51.8	11.60	18.40	31.9	55.5
1089	1.61	56	5.614	90	9.023	14.60	23.20	40.0	69.6	16.80	26.50	16.0	80.1
1069	1.64	22	2.206	36	3.609	3.99	6.34	11.0	...	5.99	9.47	16.4	...
1069	1.64	44	4.411	72	7.218	11.80	18.80	32.5	56.4	12.90	20.40	35.4	61.6
1063	1.65	34	3.409	56	5.614	7.67	12.20	21.1	36.7	9.71	15.40	26.6	46.4
1050	1.67	24	2.406	40	4.010	4.35	6.91	12.0	...	6.60	10.40	18.1	...
1050	1.67	48	4.812	80	8.020	12.70	20.30	35.1	60.9	14.20	22.40	38.9	67.7
1039	1.68	38	3.810	64	4.416	10.30	16.40	28.4	49.4	11.00	17.40	30.1	52.4
1034	1.69	26	2.607	44	4.411	4.71	7.48	12.9	...	7.22	11.40	19.8	...
1021	1.71	28	2.807	48	4.812	5.61	8.92	15.4	...	7.83	12.40	21.5	...
Multiply hp rating by belt length factor to determine drive width—BELT LENGTH FACTOR →													



HTS® 8 mm Drive Selection Tables

NOMINAL CENTER DISTANCES																							
BELT LENGTH CODE DESIGNATION																							
536	560	600	640	720	800	880	960	1040	1120	1200	1224	1280	1440	1600	1760	1800	2000	2400	2600	2800	3048		
.8			.9				1.0					1.1				1.2							
...	9.1	10.7	12.3	12.7	13.8	17.0	20.1	23.3	24.1	28.0	35.9	39.8	43.8	48.7		
...	9.3	10.8	11.3	12.4	15.6	18.7	21.9	22.7	26.6	34.5	38.4	42.4	47.2		
...	5.8	7.4	9.0	10.5	12.1	13.7	15.3	16.8	17.3	18.4	21.6	24.7	27.9	28.7	32.6	40.5	44.4	48.3	53.2		
5.2	5.7	6.4	7.2	8.8	10.4	12.0	13.5	15.1	16.7	18.3	18.7	19.8	23.0	26.1	29.3	30.1	34.0	41.9	45.8	49.8	54.6		
6.6	7.1	7.9	8.7	10.2	11.8	13.4	15.0	16.5	18.1	19.7	20.2	21.3	24.4	27.6	30.7	31.5	35.4	43.3	47.2	51.2	56.1		
...	6.3	7.9	9.4	11.0	12.6	14.2	15.7	16.2	17.3	20.5	23.6	26.8	27.6	31.5	39.4	43.3	47.2	52.1		
5.5	6.0	6.8	7.6	9.1	10.7	12.3	13.9	15.4	17.0	18.6	19.1	20.2	23.3	26.5	29.6	30.4	34.3	42.2	46.1	50.1	55.0		
...	7.2	8.8	10.4	11.9	13.5	14.0	15.1	18.3	21.4	24.6	25.3	29.3	37.2	41.1	45.0	49.9		
...	4.9	5.6	6.4	8.0	9.6	11.2	12.7	14.3	15.9	17.5	17.9	19.1	22.2	25.4	28.5	29.3	33.2	41.1	45.0	49.0	53.9		
5.8	6.3	7.1	7.9	9.4	11.0	12.6	14.2	15.7	17.3	18.9	19.4	20.5	23.6	26.8	29.9	30.7	34.6	42.5	46.5	50.4	55.3		
6.1	6.6	7.4	8.2	9.8	11.3	12.9	14.5	16.1	17.6	19.2	19.7	20.8	23.9	27.1	30.2	31.0	35.0	42.8	46.8	50.7	55.6		
5.0	5.5	6.3	7.1	8.6	10.2	11.8	13.4	15.0	16.5	18.1	18.6	19.7	22.8	26.0	29.1	29.9	33.9	41.7	45.7	49.6	54.5		
...	...	5.2	6.0	7.5	9.1	10.7	12.3	13.8	15.4	17.0	17.5	18.6	21.7	24.9	28.0	28.8	32.8	40.6	44.6	48.5	53.4		
...	6.9	8.5	10.0	11.6	13.2	14.8	15.3	16.4	19.5	22.7	25.8	26.6	30.5	38.4	42.4	46.3	51.2		
5.3	5.8	6.6	7.4	9.0	10.5	12.1	13.7	15.3	16.8	18.4	18.9	20.0	23.1	26.3	29.4	30.2	34.2	42.0	46.0	49.9	54.8		
6.4	6.9	7.7	8.5	10.1	11.6	13.2	14.8	16.4	17.9	19.5	20.0	21.1	24.3	27.4	30.6	31.3	35.3	43.1	47.1	51.0	55.9		
...	5.0	5.8	6.6	8.2	9.7	11.3	12.9	14.5	16.1	17.6	18.1	19.2	22.4	25.5	28.7	29.4	33.4	41.3	45.2	49.1	54.0		
5.6	6.1	6.9	7.7	9.3	10.9	12.4	14.0	15.6	17.2	18.7	19.2	20.3	23.5	26.6	29.8	30.5	34.5	42.4	46.3	50.2	55.1		
...	6.6	8.2	9.7	11.3	12.9	14.5	16.0	16.5	17.6	20.8	23.9	27.1	27.9	31.8	39.7	43.6	47.6	52.4		
...	13.1	16.3	19.5	20.3	24.2	32.1	36.0	40.0	44.9		
...	9.8	11.4	11.9	13.0	16.2	19.3	22.5	23.3	27.2	35.1	39.0	43.0	47.9		
...	18.7	21.9	25.0	28.2	29.0	32.9	40.8	44.7	48.7	53.5		
6.0	6.4	7.2	8.0	9.6	11.2	12.7	14.3	15.9	17.5	19.1	19.5	20.6	23.8	26.9	30.1	30.9	34.8	42.7	46.6	50.6	55.4		
5.2	5.6	6.4	7.2	8.8	10.4	12.0	13.5	15.1	16.7	18.3	18.7	19.8	23.0	26.1	29.3	30.1	34.0	41.9	45.8	49.8	54.6		
...	8.1	9.7	11.3	12.9	13.3	14.4	17.6	20.8	23.9	24.7	28.6	36.5	40.5	44.4	49.3		
6.3	6.8	7.5	8.3	9.9	11.5	13.1	14.6	16.2	17.8	19.4	19.8	20.9	24.1	27.2	30.4	31.2	35.1	43.0	46.9	50.9	55.7		
...	7.2	8.8	10.3	11.9	13.5	15.1	15.6	16.7	19.8	23.0	26.1	26.9	30.9	38.7	42.7	46.6	51.5		
5.5	6.0	6.7	7.5	9.1	10.7	12.3	13.8	15.4	17.0	18.6	19.0	20.2	23.3	26.5	29.6	30.4	34.3	42.2	46.1	50.1	55.0		
4.7	5.1	5.9	6.7	8.3	9.9	11.5	13.1	14.6	16.2	17.8	18.3	19.4	22.5	25.7	28.8	29.6	33.5	41.4	45.4	49.3	54.2		
...	6.7	8.3	9.9	11.5	13.0	14.6	16.2	16.7	17.8	20.9	24.1	27.2	28.0	32.0	39.8	43.8	47.7	52.6		
5.8	6.3	7.1	7.9	9.4	11.0	12.6	14.2	15.7	17.3	18.9	19.4	20.5	23.6	26.8	29.9	30.7	34.6	42.5	46.5	50.4	55.3		
...	...	5.5	6.2	7.8	9.4	11.0	12.6	14.2	15.7	17.3	17.8	18.9	22.0	25.2	28.3	29.1	33.1	40.9	44.9	48.8	53.7		
...	7.8	9.4	11.0	12.5	14.1	14.6	15.7	18.9	22.0	25.2	26.0	29.9	37.8	41.7	45.7	50.5		
5.3	5.8	6.6	7.4	8.9	10.5	12.1	13.7	15.3	16.8	18.4	18.9	20.0	23.1	26.3	29.4	30.2	34.2	42.0	46.0	49.9	54.8		
6.1	6.6	7.4	8.2	9.7	11.3	12.9	14.5	16.1	17.6	19.2	19.7	20.8	23.9	27.1	30.2	31.0	35.0	42.8	46.8	50.7	55.6		
...	6.9	8.4	10.0	11.6	13.2	14.8	16.3	16.8	17.9	21.1	24.2	27.4	28.2	32.1	40.0	43.9	47.9	52.7		
...	10.5	13.7	16.9	20.1	20.8	24.8	32.7	36.6	40.6	45.5		
4.8	5.3	6.1	6.9	8.5	10.0	11.6	13.2	14.8	16.4	17.9	18.4	19.5	22.7	25.8	29.0	29.8	33.7	41.6	45.5	49.4	54.3		
5.6	6.1	6.9	7.7	9.3	10.8	12.4	14.0	15.6	17.2	18.7	19.2	20.3	23.5	26.6	29.8	30.5	34.5	42.4	46.3	50.2	55.1		
...	4.8	5.6	6.4	8.0	9.6	11.1	12.7	14.3	15.9	17.5	17.9	19.0	22.2	25.3	28.5	29.3	33.2	41.1	45.0	49.0	53.9		
...	7.5	9.1	10.6	12.2	13.8	15.4	15.9	17.0	20.1	23.3	26.4	27.2	31.2	39.0	43.0	46.9	51.8		
...	8.8	10.4	12.0	12.5	13.6	16.8	19.9	23.1	23.9	27.8	35.7	39.7	43.6	48.5		
5.9	6.4	7.2	8.0	9.6	11.2	12.7	14.3	15.9	17.5	19.0	19.5	20.6	23.8	26.9	30.1	30.9	34.8	42.7	46.6	50.5	55.4		
...	8.1	9.7	11.2	12.8	14.4	14.9	16.0	19.2	22.3	25.5	26.3	30.2	38.1	42.0	46.0	50.8		
...	5.4	7.0	8.6	10.2	11.8	13.3	14.9	16.5	17.0	18.1	21.2	24.4	27.5	28.3	32.3	40.1	44.1	48.0	52.9		
5.5	5.9	6.7	7.5	9.1	10.7	12.3	13.8	15.4	17.0	18.6	19.0	20.1	23.3	26.4	29.6	30.4	34.3	42.2	46.1	50.1	55.0		
...	8.7	10.3	11.9	13.4	13.9	15.0	18.2	21.4	24.5	25.3	29.2	37.1	41.1	45.0	49.9		
...	6.0	7.6	9.2	10.8	12.4	14.0	15.5	16.0	17.1	20.3	23.4	26.6	27.4	31.3	39.2	43.1	47.1	52.0		
5.0	5.4	6.2	7.0	8.6	10.2	11.8	13.4	14.9	16.5	18.1	18.6	19.7	22.8	26.0	29.1	29.9	33.8	41.7	45.7	49.6	54.5		
...	4.9	5.7	6.5	8.1	9.7	11.3	12.9	14.5	16.0	17.6	18.1	19.2	22.3	25.5	28.6	29.4	33.4	41.2	45.2	49.1	54.0		
.8			.9				1.0					1.1				1.2							

PULLEYS

HTS® 8 mm Drive Selection Tables



DN RPM	Drive Ratio	Sprocket Combination				HP Ratings @ 1750 RPM Driver							
		Driver		Driven		RPPTM Belt Widths				RPPTM PLUS Belt Widths			
		No. Teeth	P.D.	No. Teeth	P.D.	20	30	50	85	20	30	50	85
Multiply hp rating by belt length factor to determine drive width—BELT LENGTH FACTOR													
1013	1.73	22	2.206	38	3.810	3.99	6.34	11.0	...	5.99	9.47	16.4	...
1000	1.75	32	3.208	56	5.614	6.72	10.70	18.5	...	9.08	14.40	24.9	...
1000	1.75	64	6.416	112	11.229	16.30	25.90	44.8	77.8	19.30	30.60	53.1	92.5
984	1.78	36	3.609	64	6.416	9.85	15.70	27.1	47.1	10.30	16.40	28.4	49.4
972	1.80	40	4.010	72	7.218	10.80	17.20	29.8	51.8	11.60	18.40	31.9	55.5
972	1.80	80	8.020	144	14.437	19.40	30.80	53.3	92.7	24.40	38.70	67.2	117.0
963	1.82	22	2.206	40	4.010	3.99	6.34	11.0	...	5.99	9.47	16.4	...
963	1.82	44	4.411	80	8.020	11.80	18.80	32.5	56.4	12.90	20.40	35.4	61.6
955	1.83	24	2.406	44	4.411	4.35	6.91	12.0	...	6.60	10.40	18.1	...
948	1.85	26	2.607	48	4.812	4.71	7.48	12.9	...	7.22	11.40	19.8	...
938	1.87	30	3.008	56	5.614	6.10	9.70	16.8	...	8.46	13.40	23.2	...
933	1.88	48	4.812	90	9.023	12.70	20.30	35.1	60.9	14.20	22.40	38.9	67.7
930	1.88	34	3.409	64	6.416	7.67	12.20	21.1	36.7	9.71	15.40	26.6	46.4
924	1.89	38	3.810	72	7.218	10.30	16.40	28.4	49.4	11.00	17.40	30.1	52.4
875	2.00	22	2.206	44	4.411	3.99	6.34	11.0	...	5.99	9.47	16.4	...
875	2.00	24	2.406	48	4.812	4.35	6.91	12.0	...	6.60	10.40	18.1	...
875	2.00	28	2.807	56	5.614	5.61	8.92	15.4	...	7.83	12.40	21.5	...
875	2.00	32	3.208	64	6.416	6.72	10.70	18.5	...	9.08	14.40	24.9	...
875	2.00	36	3.609	72	7.218	9.85	15.70	27.1	47.1	10.30	16.40	28.4	49.4
875	2.00	40	4.010	80	8.020	10.80	17.20	29.8	51.8	11.60	18.40	31.9	55.5
875	2.00	56	5.614	112	11.229	14.60	23.20	40.0	69.6	16.80	26.50	46.0	80.1
875	2.00	72	7.218	144	14.437	17.90	28.40	49.2	85.5	21.90	34.70	60.2	105.0
856	2.05	44	4.411	90	9.023	11.80	18.80	32.5	56.4	12.90	20.40	35.4	61.6
831	2.11	38	3.810	80	8.020	10.30	16.40	28.4	49.4	11.00	17.40	30.1	52.4
826	2.12	34	3.409	72	7.218	7.67	12.20	21.1	36.7	9.71	15.40	26.6	46.4
820	2.13	30	3.008	64	6.416	6.10	9.70	16.8	...	8.46	13.40	23.2	...
813	2.15	26	2.607	56	5.614	4.71	7.48	12.9	...	7.22	11.40	19.8	...
802	2.18	22	2.206	48	4.812	3.99	6.34	11.0	...	5.99	9.47	16.4	...
788	2.22	36	3.609	80	8.020	9.85	15.70	27.1	47.1	10.30	16.40	28.4	49.4
778	2.25	32	3.208	72	7.218	6.72	10.70	18.5	...	9.08	14.40	24.9	...
778	2.25	40	4.010	90	9.023	10.80	17.20	29.8	51.8	11.60	18.40	31.9	55.5
778	2.25	64	6.416	144	14.437	16.30	25.90	44.8	77.8	19.30	30.60	53.1	92.5
766	2.29	28	2.807	64	6.416	5.61	8.92	15.4	...	7.83	12.40	21.5	...
750	2.33	24	2.406	56	5.614	4.35	6.91	12.0	...	6.60	10.40	18.1	...
750	2.33	48	4.812	112	11.229	12.70	20.30	35.1	60.9	14.20	22.40	38.9	67.7
744	2.35	34	3.409	80	8.020	7.67	12.20	21.1	36.7	9.71	15.40	26.6	46.4
739	2.37	38	3.810	90	9.023	10.30	16.40	28.4	49.4	11.00	17.40	30.1	52.4
729	2.40	30	3.008	72	7.218	6.10	9.70	16.8	...	8.46	13.40	23.2	...
729	2.40	80	8.020	192	19.249	19.40	30.80	53.3	92.7	24.40	38.70	67.2	117.0
711	2.46	26	2.607	64	6.416	4.71	7.48	12.9	...	7.22	11.40	19.8	...
700	2.50	32	3.208	80	8.020	6.72	10.70	18.5	...	9.08	14.40	24.9	...
700	2.50	36	3.609	90	9.023	9.85	15.70	27.1	47.1	10.30	16.40	28.4	49.4
688	2.55	22	2.206	56	5.614	3.99	6.34	11.0	...	5.99	9.47	16.4	...
688	2.55	44	4.411	112	11.229	11.80	18.80	32.5	56.4	12.90	20.40	35.4	61.6
681	2.57	28	2.807	72	7.218	5.61	8.92	15.4	...	7.83	12.40	21.5	...
681	2.57	56	5.614	144	14.437	14.60	23.20	40.0	69.6	16.80	26.50	46.0	80.1
661	2.65	34	3.409	90	9.023	7.67	12.20	21.1	36.7	9.71	15.40	26.6	46.4
656	2.67	24	2.406	64	6.416	4.35	6.91	12.0	...	6.60	10.40	18.1	...
656	2.67	30	3.008	80	8.020	6.10	9.70	16.8	...	8.46	13.40	23.2	...
656	2.67	72	7.218	192	19.249	17.90	28.40	49.2	85.5	21.90	34.70	60.2	105.0
Multiply hp rating by belt length factor to determine drive width—BELT LENGTH FACTOR →													



HTS® 8 mm Drive Selection Tables

NOMINAL CENTER DISTANCES																						
BELT LENGTH CODE DESIGNATION																						
560	600	640	720	800	880	960	1040	1120	1200	1224	1280	1440	1600	1760	1800	2000	2400	2600	2800	3048	3280	
.8		.9				1.0					1.1				1.2							
6.2	7.0	7.8	9.4	11.0	12.6	14.2	15.7	17.3	18.9	19.4	20.5	23.6	26.8	29.9	30.7	34.6	42.5	46.5	50.4	55.3	59.8	
...	...	5.5	7.1	8.7	10.3	11.9	13.5	15.1	16.6	17.1	18.2	21.4	24.5	27.7	28.5	32.4	40.3	44.2	48.2	53.1	57.6	
...	11.1	14.3	17.5	20.6	21.4	25.4	33.3	37.2	41.2	46.1	50.7	
...	6.1	7.7	9.3	10.9	12.5	14.1	15.7	16.2	17.3	20.4	23.6	26.7	27.5	31.5	39.3	43.3	47.2	52.1	56.7	
...	6.7	8.3	9.9	11.5	13.1	14.7	15.2	16.3	19.5	22.6	25.8	26.2	30.5	38.4	42.3	46.3	51.2	55.7	
...	13.5	16.7	17.5	21.5	29.4	33.4	37.3	42.2	46.8	
6.1	6.9	7.7	9.2	10.8	12.4	14.0	15.6	17.1	18.7	19.2	20.3	23.4	26.6	29.8	30.5	34.5	42.4	46.3	50.2	55.1	59.7	
...	7.3	8.9	10.5	12.1	13.7	14.2	15.3	18.5	21.7	24.8	25.6	29.6	37.4	41.4	45.3	50.2	54.8	
5.6	6.4	7.2	8.8	10.3	11.9	13.5	15.1	16.7	18.2	18.7	19.8	23.0	26.1	29.3	30.1	34.0	41.9	45.8	49.8	54.6	59.2	
5.1	5.9	6.7	8.3	9.9	11.4	13.0	14.6	16.2	17.8	18.2	19.3	22.5	25.6	28.8	29.6	33.5	41.4	45.3	49.3	54.2	58.7	
...	...	5.7	7.3	8.9	10.5	12.1	13.6	15.2	16.8	17.3	18.4	21.5	24.7	27.8	28.6	32.6	40.5	44.4	48.3	53.2	57.8	
...	7.7	9.4	11.0	12.6	13.1	14.2	17.3	20.5	23.7	24.5	28.4	36.3	40.3	44.2	49.1	53.7	
...	6.3	7.9	9.5	11.1	12.7	14.2	15.8	16.3	17.4	20.6	23.7	26.9	27.7	31.6	39.5	43.4	47.4	52.3	56.8	
...	6.9	8.5	10.1	11.7	13.3	14.9	15.3	16.4	19.6	22.8	25.9	26.7	30.7	38.5	42.5	46.4	51.3	55.9	
5.7	6.5	7.3	8.9	10.5	12.1	13.7	15.2	16.8	18.4	18.9	20.0	23.1	26.3	29.4	30.2	34.2	42.0	46.0	49.9	54.8	59.4	
5.2	6.0	6.8	8.4	10.0	11.6	13.2	14.8	16.3	17.9	18.4	19.5	22.6	25.8	29.0	29.7	33.7	41.6	45.5	49.4	54.3	58.9	
...	5.0	5.8	7.4	9.0	10.6	12.2	13.8	15.4	16.9	17.4	18.5	21.7	24.8	28.0	28.8	32.7	40.6	44.5	48.5	53.4	57.9	
...	6.4	8.0	9.6	11.2	12.8	14.4	16.0	16.5	17.6	20.7	23.9	27.0	27.8	31.8	39.7	43.6	47.5	52.4	57.0	
...	7.0	8.6	10.2	11.8	13.4	15.0	15.5	16.6	19.8	22.9	26.1	26.9	30.8	38.7	42.6	46.6	51.5	56.0	
...	7.6	9.2	10.8	12.4	14.0	14.5	15.6	18.8	22.0	25.1	25.9	29.9	37.7	41.7	45.6	50.5	55.1	
...	10.0	10.5	11.6	14.8	18.0	21.2	22.0	26.0	33.9	37.8	41.8	46.7	51.3	
...	14.0	17.2	18.0	22.1	30.0	34.0	37.9	42.8	47.4	
...	8.0	9.6	11.2	12.9	13.3	14.5	17.6	20.8	24.0	24.8	28.7	36.6	40.6	44.5	49.4	54.0	
...	7.7	9.4	11.0	12.6	14.2	14.6	15.8	18.9	22.1	25.3	26.1	30.0	37.9	41.8	45.8	50.7	55.2	
...	7.1	8.8	10.4	12.0	13.6	15.2	15.6	16.7	19.9	23.1	26.2	27.0	31.0	38.9	42.8	46.7	51.6	56.2	
...	6.5	8.2	9.8	11.4	13.0	14.5	16.1	16.6	17.7	20.9	24.0	27.2	28.0	31.9	39.8	43.7	47.7	52.6	57.1	
...	5.1	5.9	7.6	9.2	10.8	12.3	13.9	15.5	17.1	17.6	18.7	21.8	25.0	28.1	28.9	32.9	40.8	44.7	48.6	53.5	58.1	
5.3	6.2	7.0	8.6	10.1	11.7	13.3	14.9	16.5	18.1	18.5	19.6	22.8	26.0	29.1	29.9	33.8	41.7	45.7	49.6	54.5	59.0	
...	7.9	9.5	11.1	12.7	14.3	14.8	15.9	19.1	22.2	25.4	26.2	30.2	38.0	42.0	45.9	50.8	55.4	
...	7.3	8.9	10.5	12.1	13.7	15.3	15.8	16.9	20.1	23.2	26.4	27.2	31.1	39.0	42.9	46.9	51.8	56.3	
...	8.3	9.9	11.5	13.1	13.6	14.7	17.9	21.1	24.3	25.1	29.0	36.9	40.9	44.8	49.7	54.3	
...	11.2	14.5	17.8	18.6	22.6	30.6	34.6	38.5	43.4	48.0	
...	6.7	8.3	9.9	11.5	13.1	14.7	16.3	16.7	17.9	21.0	24.2	27.3	28.1	32.1	40.0	43.9	47.8	52.7	57.3	
...	5.3	6.1	7.7	9.3	10.9	12.5	14.1	15.7	17.2	17.7	18.8	22.0	25.1	28.3	29.1	33.0	40.9	44.9	48.8	53.7	58.2	
...	8.9	10.5	11.0	12.2	15.4	18.6	21.8	22.6	26.6	34.5	38.4	42.4	47.3	51.9	
...	8.0	9.6	11.2	12.9	14.5	14.9	16.0	19.2	22.4	25.6	26.4	30.3	38.2	42.1	46.1	51.0	55.5	
...	8.4	10.0	11.7	13.3	13.8	14.9	18.1	21.2	24.4	25.2	29.2	37.1	41.0	45.0	49.9	54.4	
...	7.4	9.0	10.6	12.3	13.8	15.4	15.9	17.0	20.2	23.4	26.5	27.3	31.3	39.2	43.1	47.0	51.9	56.5	
...	17.0	25.2	29.2	33.2	38.1	42.8	
...	6.8	8.4	10.0	11.6	13.2	14.8	16.4	16.9	18.0	21.2	24.3	27.5	28.3	32.2	40.1	44.1	48.0	52.9	57.4	
...	6.5	8.1	9.8	11.4	13.0	14.6	15.1	16.2	19.4	22.5	25.7	26.5	30.5	38.3	42.3	46.2	51.1	55.7	
...	8.5	10.2	11.8	13.4	13.9	15.0	18.2	21.4	24.6	25.4	29.3	37.2	41.2	45.1	50.0	54.6	
...	5.4	6.2	7.8	9.4	11.0	12.6	14.2	15.8	17.4	17.9	19.0	22.1	25.3	28.5	29.2	33.2	41.1	45.0	48.9	53.8	58.4	
...	9.1	10.8	11.3	12.4	15.7	18.9	22.1	22.9	26.9	34.8	38.7	42.7	47.6	52.2	
...	5.9	7.5	9.2	10.8	12.4	14.0	15.6	16.1	17.2	20.3	23.5	26.7	27.5	31.4	39.3	43.2	47.2	52.1	56.7	
...	11.8	15.1	18.3	19.2	23.2	31.2	35.1	39.1	44.0	48.6	
...	7.0	8.7	10.3	11.9	13.6	14.0	14.0	15.2	18.4	21.5	24.7	25.5	29.5	37.4	41.3	45.3	50.2	54.7	
...	...	5.3	6.9	8.6	10.2	11.8	13.4	15.0	16.6	17.0	18.2	21.3	24.5	27.6	28.4	32.4	40.3	44.2	48.1	53.0	57.6	
...	6.6	8.3	9.9	11.5	13.1	14.7	15.2	16.3	19.5	22.7	25.9	26.6	30.6	38.5	42.4	46.4	51.3	55.8	
...	17.5	25.7	29.8	33.8	38.7	43.3	
.8	.9					1.0					1.1				1.2							

PULLEYS

HTS® 8 mm Drive Selection Tables



DN RPM	Drive Ratio	Sprocket Combination				HP Ratings @ 1750 RPM Driver							
		Driver		Driven		RPP™ Belt Widths				RPP™ PLUS Belt Widths			
		No. Teeth	P.D.	No. Teeth	P.D.	20	30	50	85	20	30	50	85
Multiply hp rating by belt length factor to determine drive width—BELT LENGTH FACTOR →													
632	2.77	26	2.607	72	7.218	4.71	7.48	12.9	...	7.22	11.40	19.8	...
625	2.80	40	4.010	112	11.229	10.80	17.20	29.8	51.8	11.60	18.40	31.9	55.5
622	2.81	32	3.208	90	9.023	6.72	10.70	18.5	...	9.08	14.40	24.9	...
613	2.86	28	2.807	80	8.020	5.61	8.92	15.4	...	7.83	12.40	21.5	...
602	2.91	22	2.206	64	6.416	3.99	6.34	11.0	...	5.99	9.47	16.4	...
594	2.95	38	3.810	112	11.229	10.30	16.40	28.4	49.4	11.00	17.40	30.1	52.4
583	3.00	24	2.406	72	7.218	4.35	6.91	12.0	...	6.60	10.40	18.1	...
583	3.00	30	3.008	90	9.023	6.10	9.70	16.8	...	8.46	13.40	23.2	...
583	3.00	48	4.812	144	14.437	12.70	20.30	35.1	60.9	14.20	22.40	38.9	67.7
583	3.00	64	6.416	192	19.249	16.30	25.90	44.8	77.8	19.30	30.60	53.1	92.5
569	3.08	26	2.607	80	8.020	4.71	7.48	12.9	...	7.22	11.40	19.8	...
563	3.11	36	3.609	112	11.229	9.85	15.70	27.1	47.1	10.30	16.40	28.4	49.4
544	3.21	28	2.807	90	9.023	5.61	8.92	15.4	...	7.83	12.40	21.5	...
535	3.27	22	2.206	72	7.218	3.99	6.34	11.0	...	5.99	9.47	16.4	...
535	3.27	44	4.411	144	14.437	11.80	18.80	32.5	56.4	12.90	20.40	35.4	61.6
531	3.29	34	3.409	112	11.229	7.67	12.20	21.1	36.7	9.71	15.40	26.6	46.4
525	3.33	24	2.406	80	8.020	4.35	6.91	12.0	...	6.60	10.40	18.1	...
510	3.43	56	5.614	192	19.249	14.60	23.20	40.0	69.6	16.80	26.50	46.0	80.1
506	3.46	26	2.607	90	9.023	4.71	7.48	12.9	...	7.22	11.40	19.8	...
500	3.50	32	3.208	112	11.229	6.72	10.70	18.5	...	9.08	14.40	24.9	...
486	3.60	40	4.010	144	14.437	10.80	17.20	29.8	51.8	11.60	18.40	31.9	55.5
481	3.64	22	2.206	80	8.020	3.99	6.34	11.0	...	5.99	9.47	16.4	...
469	3.73	30	3.008	112	11.229	6.10	9.70	16.8	...	8.46	13.40	23.2	...
467	3.75	24	2.406	90	9.023	4.35	6.91	12.0	...	6.60	10.40	18.1	...
462	3.79	38	3.810	144	14.437	10.30	16.40	28.4	49.4	11.00	17.40	30.1	52.4
438	4.00	28	2.807	112	11.229	5.61	8.92	15.4	...	7.83	12.40	21.5	...
438	4.00	36	3.609	144	14.437	9.85	15.70	27.1	47.1	10.30	16.40	28.4	49.4
438	4.00	48	4.812	192	19.249	12.70	20.30	35.1	60.9	14.20	22.40	38.9	67.7
428	4.09	22	2.206	90	9.023	3.99	6.34	11.0	...	5.99	9.47	16.4	...
413	4.24	34	3.409	144	14.437	7.67	12.20	21.1	36.7	9.71	15.40	26.6	46.4
406	4.31	26	2.607	112	11.229	4.71	7.48	12.9	...	7.22	11.40	19.8	...
401	4.36	44	4.411	192	19.249	11.80	18.80	32.5	56.4	12.90	20.40	35.4	61.6
389	4.50	32	3.208	144	14.437	6.72	10.70	18.5	...	9.08	14.40	24.9	...
375	4.67	24	2.406	112	11.229	4.35	6.91	12.0	...	6.60	10.40	18.1	...
365	4.80	30	3.008	144	14.437	6.10	9.70	16.8	...	8.46	13.40	23.2	...
365	4.80	40	4.010	192	19.249	10.80	17.20	29.8	51.8	11.60	18.40	31.9	55.5
346	5.05	38	3.810	192	19.249	10.30	16.40	28.4	49.4	11.00	17.40	30.1	52.4
344	5.09	22	2.206	112	11.229	3.99	6.34	11.0	...	5.99	9.47	16.4	...
340	5.14	28	2.807	144	14.437	5.61	8.92	15.4	...	7.83	12.40	21.5	...
328	5.33	36	3.609	192	19.249	9.85	15.7	27.1	47.1	10.30	16.40	28.4	49.4
316	5.54	26	2.607	144	14.437	4.71	7.48	12.9	...	7.22	11.40	19.8	...
310	5.65	34	3.409	192	19.249	7.67	12.20	21.1	36.7	9.71	15.40	26.6	46.4
292	6.00	24	2.406	144	14.437	4.35	6.91	12.0	...	6.60	10.40	18.1	...
292	6.00	32	3.208	192	19.249	6.72	10.70	18.5	...	9.08	14.40	24.9	...
273	6.40	30	3.008	192	19.249	6.10	9.70	16.8	...	8.46	13.40	23.2	...
267	6.55	22	2.206	144	14.437	3.99	6.34	11.0	...	5.99	9.47	16.4	...
255	6.86	28	2.807	192	19.249	5.61	8.92	15.4	...	7.83	12.40	21.5	...
237	7.38	26	2.607	192	19.249	4.71	7.48	12.9	...	7.22	11.40	19.8	...
219	8.00	24	2.406	192	19.249	4.35	6.91	12.0	...	6.60	10.40	18.1	...
201	8.73	22	2.206	192	19.249	3.99	6.34	11.0	...	5.99	9.47	16.4	...
Multiply hp rating by belt length factor to determine drive width—BELT LENGTH FACTOR →													

PULLEYS



HTS® 8 mm Drive Selection Tables

NOMINAL CENTER DISTANCES																						
BELT LENGTH CODE DESIGNATION																						
720	800	880	960	1040	1120	1200	1224	1280	1440	1600	1760	1800	2000	2400	2600	2800	3048	3280	3600	4400	1195	
.9			1.0					1.1				1.2										
6.0	7.7	9.3	10.9	12.5	14.1	15.7	16.2	17.3	20.5	23.7	26.8	27.6	31.6	39.5	43.4	43.4	52.2	56.8	63.1	78.9		
...	9.4	11.1	11.5	12.7	16.0	19.2	22.4	23.2	27.1	35.1	39.0	39.0	47.9	52.5	58.8	74.6		
...	...	7.1	8.8	10.4	12.1	13.7	14.2	15.3	18.5	21.7	24.9	25.7	29.6	37.5	41.5	45.4	50.3	54.9	61.2	77.0		
...	6.7	8.4	10.0	11.7	13.3	14.9	15.4	16.5	19.7	22.8	26.0	26.8	30.8	38.6	42.6	46.5	51.4	56.0	62.3	78.1		
7.1	8.7	10.3	11.9	13.5	15.1	16.7	17.2	18.3	21.5	24.6	27.8	28.6	32.5	40.4	44.4	48.3	53.2	57.8	64.1	79.8		
...	9.5	11.2	11.7	12.8	16.1	19.3	22.5	23.3	27.3	35.2	39.2	43.1	48.0	52.6	58.9	74.7		
6.1	7.8	9.4	11.1	12.7	14.3	15.9	16.3	17.5	20.6	23.8	27.0	27.8	31.7	39.6	43.6	47.5	52.4	57.0	63.3	79.0		
...	...	7.3	8.9	10.6	12.2	13.8	14.3	15.4	18.6	21.8	25.0	25.8	29.8	37.7	41.6	45.6	50.5	55.0	61.3	77.1		
...	12.3	15.6	18.9	19.7	23.7	31.7	35.7	39.7	44.6	49.2	55.5	71.3		
...	13.8	18.1	26.3	30.3	34.3	39.3	43.9	50.3	66.1		
...	6.9	8.5	10.2	11.8	13.4	15.0	15.5	16.6	19.8	23.0	26.2	26.9	30.9	38.8	42.7	46.7	51.6	56.2	62.5	78.2		
...	9.6	11.3	11.8	13.0	16.2	19.4	22.7	23.5	27.4	35.4	39.3	43.3	48.2	52.8	59.1	74.9		
...	...	7.4	9.1	10.7	12.3	14.0	14.5	15.6	18.8	22.0	25.2	25.9	29.9	37.8	41.8	45.7	50.6	55.2	61.5	77.3		
6.3	7.9	9.6	11.2	12.8	14.4	16.0	16.5	17.6	20.8	24.0	27.1	27.9	31.9	39.8	43.7	47.6	52.5	57.1	63.4	79.2		
...	12.5	15.9	19.2	20.0	24.0	32.0	36.0	40.0	44.9	49.5	55.8	71.6		
...	9.8	11.4	11.9	13.1	16.4	19.6	22.8	23.6	27.6	35.5	39.5	43.4	48.3	52.9	59.2	75.0		
...	7.0	8.7	10.3	11.9	13.6	15.2	15.6	16.8	19.9	23.1	26.3	27.1	31.0	38.9	42.9	46.8	51.7	56.3	62.6	78.4		
...	13.5	14.3	18.6	26.8	30.9	34.9	39.9	44.5	50.9	66.7		
...	...	7.5	9.2	10.8	12.5	14.1	14.6	15.7	18.9	22.1	25.3	26.1	30.1	38.0	41.9	45.9	50.8	55.3	61.6	77.4		
...	8.2	9.9	11.6	12.1	13.2	16.5	19.7	22.9	23.7	27.7	35.7	39.6	43.6	48.5	53.1	59.4	75.2		
...	12.8	16.1	19.4	20.2	24.3	32.3	36.3	40.3	45.2	49.8	56.1	71.9		
...	7.1	8.8	10.4	12.1	13.7	15.3	15.8	16.9	20.1	23.3	26.4	27.2	31.2	39.1	43.0	47.0	51.9	56.5	62.8	78.5		
...	8.3	10.0	11.7	12.2	13.4	16.6	19.9	23.1	23.9	27.9	35.8	39.8	43.7	48.6	53.2	59.5	75.3		
...	...	7.6	9.3	11.0	12.6	14.2	14.7	15.9	19.1	22.3	25.4	26.2	30.2	38.1	42.1	46.0	50.9	55.5	61.8	77.6		
...	12.9	16.3	19.6	20.4	24.4	32.5	36.4	40.4	45.3	49.9	56.3	72.1		
...	8.4	10.2	11.8	12.3	13.5	16.8	20.0	23.2	24.0	28.0	36.0	39.9	43.9	48.8	53.4	59.7	75.5		
...	13.1	16.4	19.7	20.5	24.6	32.6	36.6	40.6	45.5	50.1	56.4	72.2		
...	14.0	14.8	19.1	27.4	31.4	35.4	40.4	45.1	51.4	67.3		
...	...	7.8	9.5	11.1	12.8	14.4	14.9	16.0	19.2	22.4	25.6	26.4	30.3	38.3	42.2	46.2	51.1	55.6	61.9	77.7		
...	9.7	13.2	16.5	19.8	20.7	24.7	32.7	36.7	40.7	45.6	50.2	56.6	72.4		
...	8.6	10.3	12.0	12.5	13.6	16.9	20.1	23.4	24.2	28.2	36.1	40.1	44.0	48.9	53.5	59.8	75.6		
...	14.2	15.1	19.4	27.6	31.7	35.7	40.7	45.3	51.7	67.6		
...	9.8	13.3	16.7	20.0	20.8	24.8	32.9	36.9	40.9	45.8	50.4	56.7	72.5		
...	8.7	10.4	12.1	12.6	13.8	17.0	20.3	23.5	24.3	28.3	36.3	40.2	44.2	49.1	53.7	60.0	75.8		
...	10.0	13.4	16.8	20.1	20.9	25.0	33.0	37.0	41.0	45.9	50.5	56.9	72.7		
...	14.5	15.3	19.6	27.9	32.0	36.0	41.0	45.6	52.0	67.9		
...	14.6	15.5	19.7	28.0	32.1	36.1	41.1	45.8	52.1	68.0		
...	8.8	10.5	12.2	12.7	13.9	17.2	20.4	23.6	24.4	28.4	36.4	40.4	44.3	49.2	53.8	60.1	75.9		
...	10.1	13.6	16.9	20.2	21.1	25.1	33.2	37.2	41.1	46.1	50.7	57.0	72.8		
...	14.7	15.6	19.9	28.2	32.2	36.3	41.3	45.9	52.3	68.2		
...	10.2	13.7	17.1	20.4	21.2	25.3	33.3	37.3	41.3	46.2	50.8	57.2	73.0		
...	14.8	15.7	20.0	28.3	32.4	36.4	41.4	46.0	52.4	68.3		
...	10.3	13.8	17.2	20.5	21.3	25.4	33.4	37.4	41.4	46.4	51.0	57.3	73.1		
...	15.0	15.8	20.1	28.4	32.5	36.6	41.5	46.2	52.6	68.5		
...	15.1	16.0	20.3	28.6	32.6	36.7	41.7	46.3	52.7	68.6		
...	9.2	10.5	13.9	17.3	20.6	21.5	25.5	33.6	37.6	41.6	46.5	51.1	57.4	73.3		
...	15.2	16.1	20.4	28.7	32.8	36.8	41.8	46.5	52.9	68.8		
...	11.7	15.3	16.2	20.5	28.8	32.9	37.0	42.0	46.6	53.0	68.9		
...	11.8	15.5	16.3	20.6	29.0	33.1	37.1	42.1	46.8	53.1	69.1		
...	12.0	15.6	16.5	20.8	29.1	33.2	37.2	42.2	46.9	53.3	69.2		
.9			1.0					1.1				1.2										

PULLEYS

HTS® 8 mm Drive Selection Tables



DN RPM	Drive Ratio	Sprocket Combination				HP Ratings @ 1160 RPM Driver							
		Driver		Driven		RPP™ Belt Widths				RPP™ PLUS Belt Widths			
		No. Teeth	P.D.	No. Teeth	P.D.	20	30	50	85	20	30	50	85
Multiply hp rating by belt length factor to determine drive width—BELT LENGTH FACTOR →													
1160	1.00	22	2.206	22	2.206	2.65	4.21	7.28	...	4.41	6.97	12.1	...
1160	1.00	24	2.406	24	2.406	2.89	4.59	7.94	...	4.86	7.68	13.3	...
1160	1.00	26	2.607	26	2.607	3.13	4.97	8.60	...	5.32	8.40	14.6	...
1160	1.00	28	2.807	28	2.807	3.73	5.93	10.30	...	5.78	9.13	15.8	...
1160	1.00	30	3.008	30	3.008	4.07	6.46	11.20	...	6.24	9.86	17.1	...
1160	1.00	32	3.208	32	3.208	4.68	7.45	12.90	...	6.70	10.60	18.4	...
1160	1.00	34	3.409	34	3.409	5.35	8.50	14.70	25.6	7.17	11.30	19.7	34.2
1160	1.00	36	3.609	36	3.609	6.87	10.90	18.90	32.8	7.64	12.10	20.9	36.5
1160	1.00	38	3.810	38	3.810	7.22	11.50	19.80	34.5	8.12	12.80	22.2	38.7
1160	1.00	40	4.010	40	4.010	7.56	12.00	20.80	36.2	8.59	13.60	23.6	41.0
1160	1.00	44	4.411	44	4.411	8.25	13.10	22.70	39.4	9.55	15.10	26.2	45.6
1160	1.00	48	4.812	48	4.812	8.92	14.20	24.50	42.7	10.50	16.60	28.8	50.2
1160	1.00	56	5.614	56	5.614	10.20	16.30	28.10	48.9	12.50	19.70	34.2	59.6
1160	1.00	64	6.416	64	6.416	11.50	18.20	31.60	54.9	14.50	22.80	39.6	69.0
1160	1.00	72	7.218	72	7.218	12.70	20.10	34.80	60.6	16.40	26.00	45.1	78.5
1160	1.00	80	8.020	80	8.020	13.80	21.90	38.00	66.0	18.40	29.20	50.6	88.1
1102	1.05	38	3.810	40	4.010	7.22	11.50	19.80	34.5	8.12	12.80	22.2	38.7
1099	1.06	36	3.609	38	3.810	6.87	10.90	18.90	32.8	7.64	12.10	20.9	36.5
1096	1.06	34	3.409	36	3.609	5.35	8.50	14.70	25.6	7.17	11.30	19.7	34.2
1092	1.06	32	3.208	34	3.409	4.68	7.45	12.90	...	6.70	10.60	18.4	...
1088	1.07	30	3.008	32	3.208	4.07	6.46	11.20	...	6.24	9.86	17.1	...
1083	1.07	28	2.807	30	3.008	3.73	5.93	10.30	...	5.78	9.13	15.8	...
1077	1.08	26	2.607	28	2.807	3.13	4.97	8.60	...	5.32	8.40	14.6	...
1071	1.08	24	2.406	26	2.607	2.89	4.59	7.94	...	4.86	7.68	13.3	...
1063	1.09	22	2.206	24	2.406	2.65	4.21	7.28	...	4.41	6.97	12.1	...
1063	1.09	44	4.411	48	4.812	8.25	13.10	22.70	39.4	9.55	15.10	26.2	45.6
1055	1.10	40	4.010	44	4.411	7.56	12.00	20.80	36.2	8.59	13.60	23.6	41.0
1044	1.11	36	3.609	40	4.010	6.87	10.90	18.90	32.8	7.64	12.10	20.9	36.5
1044	1.11	72	7.218	80	8.020	12.70	20.10	34.80	60.6	16.40	26.00	45.1	78.5
1038	1.12	34	3.409	38	3.810	5.35	8.50	14.70	25.6	7.17	11.30	19.7	34.2
1031	1.13	32	3.208	36	3.609	4.68	7.45	12.90	...	6.70	10.60	18.4	...
1031	1.13	64	6.416	72	7.218	11.50	18.20	31.60	54.9	14.50	22.80	39.6	69.0
1031	1.13	80	8.020	90	9.023	13.80	21.90	38.00	66.0	18.40	29.20	50.6	88.1
1024	1.13	30	3.008	34	3.409	4.07	6.46	11.20	...	6.24	9.86	17.1	...
1015	1.14	28	2.807	32	3.208	3.73	5.93	10.30	...	5.78	9.13	15.8	...
1015	1.14	56	5.614	64	6.416	10.20	16.30	28.10	48.9	12.50	19.70	34.2	59.6
1005	1.15	26	2.607	30	3.008	3.13	4.97	8.60	...	5.32	8.40	14.6	...
1002	1.16	38	3.810	44	4.411	7.22	11.50	19.80	34.5	8.12	12.80	22.2	38.7
994	1.17	24	2.406	28	2.807	2.89	4.59	7.94	...	4.86	7.68	13.3	...
994	1.17	48	4.812	56	5.614	8.92	14.20	24.50	42.7	10.50	16.60	28.8	50.2
986	1.18	34	3.409	40	4.010	5.35	8.50	14.70	25.6	7.17	11.30	19.7	34.2
982	1.18	22	2.206	26	2.607	2.65	4.21	7.28	...	4.41	6.97	12.1	...
977	1.19	32	3.208	38	3.810	4.68	7.45	12.90	...	6.70	10.60	18.4	...
967	1.20	30	3.008	36	3.609	4.07	6.46	11.20	...	6.24	9.86	17.1	...
967	1.20	40	4.010	48	4.812	7.56	12.00	20.80	36.2	8.59	13.60	23.6	41.0
955	1.21	28	2.807	34	3.409	3.73	5.93	10.30	...	5.78	9.13	15.8	...
949	1.22	36	3.609	44	4.411	6.87	10.90	18.90	32.8	7.64	12.10	20.9	36.5
943	1.23	26	2.607	32	3.208	3.13	4.97	8.60	...	5.32	8.40	14.6	...
928	1.25	24	2.406	30	3.008	2.89	4.59	7.94	...	4.86	7.68	13.3	...
928	1.25	32	3.208	40	4.010	4.68	7.45	12.90	...	6.70	10.60	18.4	...
Multiply hp rating by belt length factor to determine drive width—BELT LENGTH FACTOR →													

PULLEYS



HTS® 8 mm Drive Selection Tables

NOMINAL CENTER DISTANCES																								
BELT LENGTH CODE DESIGNATION																								
480	536	560	600	640	720	800	880	960	1040	1120	1200	1224	1280	1440	1600	1760	1800	2000	2400	2600	2800			
.8				.9				1.0					1.1				1.2							
6.0	7.1	7.6	8.3	9.1	10.7	12.3	13.9	15.4	17.0	18.6	20.2	20.6	21.7	24.9	28.0	31.2	32.0	35.9	43.8	47.7	51.7			
5.7	6.8	7.2	8.0	8.8	10.4	12.0	13.5	15.1	16.7	18.3	19.8	20.3	21.4	24.6	27.7	30.9	31.7	35.6	43.5	47.4	51.3			
5.4	6.5	6.9	7.7	8.5	10.1	11.7	13.2	14.8	16.4	18.0	19.5	20.0	21.1	24.3	27.4	30.6	31.3	35.3	43.2	47.1	51.0			
5.0	6.1	6.6	7.4	8.2	9.8	11.3	12.9	14.5	16.1	17.6	19.2	19.7	20.8	23.9	27.1	30.2	31.0	35.0	42.8	46.8	50.7			
4.7	5.8	6.3	7.1	7.9	9.5	11.0	12.6	14.2	15.8	17.3	18.9	19.4	20.5	23.6	26.8	29.9	30.7	34.6	42.5	46.5	50.4			
4.4	5.5	6.0	6.8	7.6	9.1	10.7	12.3	13.9	15.4	17.0	18.6	19.1	20.2	23.3	26.5	29.6	30.4	34.3	42.2	46.1	50.1			
...	5.2	5.7	6.5	7.2	8.8	10.4	12.0	13.5	15.1	16.7	18.3	18.7	19.8	23.0	26.1	29.3	30.1	34.0	41.9	45.8	49.8			
...	4.9	5.4	6.1	6.9	8.5	10.1	11.7	13.2	14.8	16.4	18.0	18.4	19.5	22.7	25.8	29.0	29.8	33.7	41.6	45.5	49.5			
...	4.6	5.0	5.8	6.6	8.2	9.8	11.3	12.9	14.5	16.1	17.6	18.1	19.2	22.4	25.5	28.7	29.5	33.4	41.3	45.2	49.1			
...	5.5	6.3	7.9	9.5	11.0	12.6	14.2	15.8	17.3	17.8	18.9	22.1	25.2	28.3	29.1	33.1	40.9	44.9	48.8			
...	5.7	7.2	8.8	10.4	12.0	13.5	15.1	16.7	17.2	18.3	21.4	24.6	27.7	28.5	32.4	40.3	44.3	48.2			
...	6.6	8.2	9.8	11.3	12.9	14.5	16.1	16.5	17.6	20.8	23.9	27.1	27.9	31.8	39.7	43.6	47.6			
...	6.9	8.5	10.1	11.7	13.2	14.8	15.3	16.4	19.5	22.7	25.8	26.6	30.6	38.4	42.4	46.3			
...	7.2	8.8	10.4	12.0	13.5	14.0	15.1	18.3	21.4	24.6	25.4	29.3	37.2	41.1	45.0			
...	9.1	10.7	12.3	12.8	13.9	17.0	20.2	23.3	24.1	28.0	35.9	39.8	43.8			
...	9.5	11.0	11.5	12.6	15.8	18.9	22.1	22.8	26.8	34.7	38.6	42.5			
...	...	4.9	5.7	6.5	8.0	9.6	11.2	12.8	14.3	15.9	17.5	18.0	19.1	22.2	25.4	28.5	29.3	33.2	41.1	45.0	49.0			
...	4.7	5.2	6.0	6.8	8.3	9.9	11.5	13.1	14.6	16.2	17.8	18.3	19.4	22.5	25.7	28.8	29.6	33.5	41.4	45.4	49.3			
...	5.0	5.5	6.3	7.1	8.7	10.2	11.8	13.4	15.0	16.5	18.1	18.6	19.7	22.8	26.0	29.1	29.9	33.9	41.7	45.7	49.6			
4.3	5.4	5.8	6.6	7.4	9.0	10.6	12.1	13.7	15.3	16.9	18.4	18.9	20.0	23.2	26.3	29.5	30.2	34.2	42.0	46.0	49.9			
4.6	5.7	6.1	6.9	7.7	9.3	10.9	12.4	14.0	15.6	17.2	18.7	19.2	20.3	23.5	26.6	29.8	30.6	34.5	42.4	46.3	50.2			
4.9	6.0	6.5	7.2	8.0	9.6	11.2	12.8	14.3	15.9	17.5	19.1	19.5	20.6	23.8	26.9	30.1	30.9	34.8	42.7	46.6	50.6			
5.2	6.3	6.8	7.6	8.3	9.9	11.5	13.1	14.6	16.2	17.8	19.4	19.8	20.9	24.1	27.2	30.4	31.2	35.1	43.0	46.9	50.9			
5.5	6.6	7.1	7.9	8.7	10.2	11.8	13.4	15.0	16.5	18.1	19.7	20.2	21.3	24.4	27.6	30.7	31.5	35.4	43.3	47.2	51.2			
5.8	6.9	7.4	8.2	9.0	10.6	12.1	13.7	15.3	16.9	18.4	20.0	20.5	21.6	24.7	27.9	31.0	31.8	35.7	43.6	47.6	51.5			
...	6.9	8.5	10.1	11.7	13.2	14.8	16.4	16.9	18.0	21.1	24.3	27.4	28.2	32.1	40.0	43.9	47.9			
...	5.2	6.0	7.6	9.1	10.7	12.3	13.9	15.4	17.0	17.5	18.6	21.7	24.9	28.0	28.8	32.8	40.6	44.6	48.5			
...	4.6	5.0	5.8	6.6	8.2	9.8	11.3	12.9	14.5	16.1	17.6	18.1	19.2	22.4	25.5	28.7	29.5	33.4	41.3	45.2	49.1			
...	8.5	10.1	11.7	12.1	13.2	16.4	19.5	22.7	23.5	27.4	35.3	39.2	43.2			
...	4.9	5.4	6.1	6.9	8.5	10.1	11.7	13.2	14.8	16.4	18.0	18.4	19.5	22.7	25.8	29.0	29.8	33.7	41.6	45.5	49.5			
...	5.2	5.7	6.5	7.2	8.8	10.4	12.0	13.5	15.1	16.7	18.3	18.7	19.8	23.0	26.1	29.3	30.1	34.0	41.9	45.8	49.8			
...	8.2	9.8	11.3	12.9	13.4	14.5	17.6	20.8	23.9	24.7	28.7	36.5	40.5	44.4			
...	10.2	10.7	11.8	15.0	18.1	21.3	22.0	26.0	33.9	37.8	41.7			
4.4	5.5	6.0	6.8	7.6	9.1	10.7	12.3	13.9	15.4	17.0	18.6	19.1	20.2	23.3	26.5	29.6	30.4	34.3	42.2	46.1	50.1			
4.7	5.8	6.3	7.1	7.9	9.4	11.0	12.6	14.2	15.7	17.3	18.9	19.4	20.5	23.6	26.8	29.9	30.7	34.6	42.5	46.5	50.4			
...	7.9	9.4	11.0	12.6	14.2	14.6	15.7	18.9	22.0	25.2	26.0	29.9	37.8	41.7	45.7			
5.0	6.1	6.6	7.4	8.2	9.8	11.3	12.9	14.5	16.1	17.6	19.2	19.7	20.8	23.9	27.1	30.2	31.0	35.0	42.8	46.8	50.7			
...	5.3	6.1	7.7	9.3	10.9	12.4	14.0	15.6	17.2	17.6	18.7	21.9	25.0	28.2	29.0	32.9	40.8	44.7	48.7			
5.4	6.5	6.9	7.7	8.5	10.1	11.7	13.2	14.8	16.4	18.0	19.5	20.0	21.1	24.3	27.4	30.6	31.3	35.3	43.2	47.1	51.0			
...	6.0	7.6	9.1	10.7	12.3	13.9	15.4	15.9	17.0	20.2	23.3	26.5	27.2	31.2	39.1	43.0	46.9			
...	4.7	5.2	6.0	6.8	8.3	9.9	11.5	13.1	14.6	16.2	17.8	18.3	19.4	22.5	25.7	28.8	29.6	33.5	41.4	45.4	49.3			
5.7	6.8	7.2	8.0	8.8	10.4	12.0	13.5	15.1	16.7	18.3	19.8	20.3	21.4	24.6	27.7	30.9	31.7	35.6	43.5	47.4	51.3			
...	5.0	5.5	6.3	7.1	8.7	10.2	11.8	13.4	15.0	16.5	18.1	18.6	19.7	22.8	26.0	29.1	29.9	33.9	41.7	45.7	49.6			
4.2	5.3	5.8	6.6	7.4	9.0	10.5	12.1	13.7	15.3	16.9	18.4	18.9	20.0	23.2	26.3	29.4	30.2	34.2	42.0	46.0	49.9			
...	5.7	7.2	8.8	10.4	12.0	13.5	15.1	16.7	17.2	18.3	21.4	24.6	27.7	28.5	32.4	40.3	44.3	48.2		
4.6	5.7	6.1	6.9	7.7	9.3	10.9	12.4	14.0	15.6	17.2	18.7	19.2	20.3	23.5	26.6	29.8	30.6	34.5	42.4	46.3	50.2			
...	5.5	6.3	7.9	9.4	11.0	12.6	14.2	15.7	17.3	17.8	18.9	22.0	25.2	28.3	29.1	33.1	40.9	44.9	48.8			
4.9	6.0	6.5	7.2	8.0	9.6	11.2	12.8	14.3	15.9	17.5	19.1	19.5	20.6	23.8	26.9	30.1	30.9	34.8	42.7	46.6	50.6			
5.2	6.3	6.8	7.6	8.3	9.9	11.5	13.1	14.6	16.2	17.8	19.4	19.8	20.9	24.1	27.2	30.4	31.2	35.1	43.0	46.9	50.9			
...	4.9	5.3	6.1	6.9	8.5	10.1	11.6	13.2	14.8	16.4	18.0	18.4	19.5	22.7	25.8	29.0	29.8	33.7	41.6	45.5	49.4			
.8				.9				1.0					1.1				1.2							

PULLEYS

HTS® 8 mm Drive Selection Tables



DN RPM	Drive Ratio	Sprocket Combination				HP Ratings @ 1160 RPM Driver							
		Driver		Driven		RPPTM Belt Widths				RPPTM PLUS Belt Widths			
		No. Teeth	P.D.	No. Teeth	P.D.	20	30	50	85	20	30	50	85
Multiply hp rating by belt length factor to determine drive width—BELT LENGTH FACTOR →													
928	1.25	64	6.416	80	8.020	11.50	18.20	31.60	54.9	14.50	22.80	39.6	69.0
928	1.25	72	7.218	90	9.023	12.70	20.10	34.80	60.6	16.40	26.00	45.1	78.5
918	1.26	38	3.810	48	4.812	7.22	11.50	19.80	34.5	8.12	12.80	22.2	38.7
916	1.27	30	3.008	38	3.810	4.07	6.46	11.20	...	6.24	9.86	17.1	...
911	1.27	22	2.206	28	2.807	2.65	4.21	7.28	...	4.41	6.97	12.1	...
911	1.27	44	4.411	56	5.614	8.25	13.10	22.70	39.4	9.55	15.10	26.2	45.6
902	1.29	28	2.807	36	3.609	3.73	5.93	10.30	...	5.78	9.13	15.8	...
902	1.29	56	5.614	72	7.218	10.20	16.30	28.10	48.9	12.50	19.70	34.2	59.6
896	1.29	34	3.409	44	4.411	5.35	8.50	14.70	25.6	7.17	11.30	19.7	34.2
887	1.31	26	2.607	34	3.409	3.13	4.97	8.60	...	5.32	8.40	14.6	...
870	1.33	24	2.406	32	3.208	2.89	4.59	7.94	...	4.86	7.68	13.3	...
870	1.33	30	3.008	40	4.010	4.07	6.46	11.20	...	6.24	9.86	17.1	...
870	1.33	36	3.609	48	4.812	6.87	10.90	18.90	32.8	7.64	12.10	20.9	36.5
870	1.33	48	4.812	64	6.416	8.92	14.20	24.50	42.7	10.50	16.60	28.8	50.2
855	1.36	28	2.807	38	3.810	3.73	5.93	10.30	...	5.78	9.13	15.8	...
851	1.36	22	2.206	30	3.008	2.65	4.21	7.28	...	4.41	6.97	12.1	...
844	1.38	32	3.208	44	4.411	4.68	7.45	12.90	...	6.70	10.60	18.4	...
838	1.38	26	2.607	36	3.609	3.13	4.97	8.60	...	5.32	8.40	14.6	...
829	1.40	40	4.010	56	5.614	7.56	12.00	20.80	36.2	8.59	13.60	23.6	41.0
829	1.40	80	8.020	112	11.229	13.80	21.90	38.00	66.0	18.40	29.20	50.6	88.1
825	1.41	64	6.416	90	9.023	11.50	18.20	31.60	54.9	14.50	22.80	39.6	69.0
822	1.41	34	3.409	48	4.812	5.35	8.50	14.70	25.6	7.17	11.30	19.7	34.2
819	1.42	24	2.406	34	3.409	2.89	4.59	7.94	...	4.86	7.68	13.3	...
812	1.43	28	2.807	40	4.010	3.73	5.93	10.30	...	5.78	9.13	15.8	...
812	1.43	56	5.614	80	8.020	10.20	16.30	28.10	48.9	12.50	19.70	34.2	59.6
798	1.45	22	2.206	32	3.208	2.65	4.21	7.28	...	4.41	6.97	12.1	...
798	1.45	44	4.411	64	6.416	8.25	13.10	22.70	39.4	9.55	15.10	26.2	45.6
794	1.46	26	2.607	38	3.810	3.13	4.97	8.60	...	5.32	8.40	14.6	...
791	1.47	30	3.008	44	4.411	4.07	6.46	11.20	...	6.24	9.86	17.1	...
787	1.47	38	3.810	56	5.614	7.22	11.50	19.80	34.5	8.12	12.80	22.2	38.7
773	1.50	24	2.406	36	3.609	2.89	4.59	7.94	...	4.86	7.68	13.3	...
773	1.50	32	3.208	48	4.812	4.68	7.45	12.90	...	6.70	10.60	18.4	...
773	1.50	48	4.812	72	7.218	8.92	14.20	24.50	42.7	10.50	16.60	28.8	50.2
754	1.54	26	2.607	40	4.010	3.13	4.97	8.60	...	5.32	8.40	14.6	...
751	1.55	22	2.206	34	3.409	2.65	4.21	7.28	...	4.41	6.97	12.1	...
746	1.56	36	3.609	56	5.614	6.87	10.90	18.90	32.8	7.64	12.10	20.9	36.5
746	1.56	72	7.218	112	11.229	12.70	20.10	34.80	60.6	16.40	26.00	45.1	78.5
738	1.57	28	2.807	44	4.411	3.73	5.93	10.30	...	5.78	9.13	15.8	...
733	1.58	24	2.406	38	3.810	2.89	4.59	7.94	...	4.86	7.68	13.3	...
725	1.60	30	3.008	48	4.812	4.07	6.46	11.20	...	6.24	9.83	17.1	...
725	1.60	40	4.010	64	6.416	7.56	12.00	20.80	36.2	8.59	13.60	23.4	41.0
722	1.61	56	5.614	90	9.023	10.20	16.30	28.10	48.9	12.50	19.70	34.2	59.6
709	1.64	22	2.206	36	3.609	2.65	4.21	7.28	...	4.41	6.97	12.1	...
709	1.64	44	4.411	72	7.218	8.25	13.10	22.70	39.4	9.55	15.10	26.2	45.6
704	1.65	34	3.409	56	5.614	5.35	8.50	14.70	25.6	7.17	11.30	19.7	34.2
696	1.67	24	2.406	40	4.010	2.89	4.59	7.94	...	4.86	7.68	13.3	...
696	1.67	48	4.812	80	8.020	8.92	14.20	24.50	42.7	10.50	16.60	28.8	50.2
689	1.68	38	3.810	64	6.416	7.22	11.50	19.80	34.5	8.12	12.80	22.2	38.7
685	1.69	26	2.607	44	4.411	3.13	4.97	8.60	...	5.32	8.40	14.6	...
677	1.71	28	2.807	48	4.812	3.73	5.93	10.30	...	5.78	9.13	15.8	...
Multiply hp rating by belt length factor to determine drive width—BELT LENGTH FACTOR →													

PULLEYS



HTS® 8 mm Drive Selection Tables

NOMINAL CENTER DISTANCES																							
BELT LENGTH CODE DESIGNATION																							
536	560	600	640	720	800	880	960	1040	1120	1200	1224	1280	1440	1600	1760	1800	2000	2400	2600	2800	3048		
.8			.9				1.0					1.1				1.2							
...	9.1	10.7	12.3	12.7	13.8	17.0	20.1	23.3	24.1	28.0	35.9	39.8	43.8	48.7		
...	9.3	10.8	11.3	12.4	15.6	18.7	21.9	22.7	26.6	34.5	38.4	42.4	47.2		
...	5.8	7.4	9.0	10.5	12.1	13.7	15.3	16.8	17.3	18.4	21.6	24.7	27.9	28.7	32.6	40.5	44.4	48.3	53.2		
5.2	5.7	6.4	7.2	8.8	10.4	12.0	13.5	15.1	16.7	18.3	18.7	19.8	23.0	26.1	29.3	30.1	34.0	41.9	45.8	49.8	54.6		
6.6	7.1	7.9	8.7	10.2	11.8	13.4	15.0	16.5	18.1	19.7	20.2	21.3	24.4	27.6	30.7	31.5	35.4	43.3	47.2	51.2	56.1		
...	6.3	7.9	9.4	11.0	12.6	14.2	15.7	16.2	17.3	20.5	23.6	26.8	27.6	31.5	39.4	43.3	47.2	52.1		
5.5	6.0	6.8	7.6	9.1	10.7	12.3	13.9	15.4	17.0	18.6	19.1	20.2	23.3	26.5	29.6	30.4	34.3	42.2	46.1	50.1	55.0		
...	7.2	8.8	10.4	11.9	13.5	14.0	15.1	18.3	21.4	24.6	25.3	29.3	37.2	41.1	45.0	49.9		
...	4.9	5.6	6.4	8.0	9.6	11.2	12.7	14.3	15.9	17.5	17.9	19.1	22.2	25.4	28.5	29.3	33.2	41.1	45.0	49.0	53.9		
5.8	6.3	7.1	7.9	9.4	11.0	12.6	14.2	15.7	17.3	18.9	19.4	20.5	23.6	26.8	29.9	30.7	34.6	42.5	46.5	50.4	55.3		
6.1	6.6	7.4	8.2	9.8	11.3	12.9	14.5	16.1	17.6	19.2	19.7	20.8	23.9	27.1	30.2	31.0	35.0	42.8	46.8	50.7	55.6		
5.0	5.5	6.3	7.1	8.6	10.2	11.8	13.4	15.0	16.5	18.1	18.6	19.7	22.8	26.0	29.1	29.9	33.9	41.7	45.7	49.6	54.5		
...	...	5.2	6.0	7.5	9.1	10.7	12.3	13.8	15.4	17.0	17.5	18.6	21.7	24.9	28.0	28.8	32.8	40.6	44.6	48.5	53.4		
...	6.9	8.5	10.0	11.6	13.2	14.8	15.3	16.4	19.5	22.7	25.8	26.6	30.5	38.4	42.4	46.3	51.2		
5.3	5.8	6.6	7.4	9.0	10.5	12.1	13.7	15.3	16.8	18.4	18.9	20.0	23.1	26.3	29.4	30.2	34.2	42.0	46.0	49.9	54.8		
6.4	6.9	7.7	8.5	10.1	11.6	13.2	14.8	16.4	17.9	19.5	20.0	21.1	24.3	27.4	30.6	31.3	35.3	43.1	47.1	51.0	55.9		
...	5.0	5.8	6.6	8.2	9.7	11.3	12.9	14.5	16.1	17.6	18.1	19.2	22.4	25.5	28.7	29.4	33.4	41.3	45.2	49.1	54.0		
5.6	6.1	6.9	7.7	9.3	10.9	12.4	14.0	15.6	17.2	18.7	19.2	20.3	23.5	26.6	29.8	30.5	34.5	42.4	46.3	50.2	55.1		
...	6.6	8.2	9.7	11.3	12.9	14.5	16.0	16.5	17.6	20.8	23.9	27.1	27.9	31.8	39.7	43.6	47.6	52.4		
...	13.1	16.3	19.5	20.3	24.2	32.1	36.0	40.0	44.9		
...	9.8	11.4	11.9	13.0	16.2	19.3	22.5	23.3	27.2	35.1	39.0	43.0	47.9		
...	...	5.3	6.1	7.7	9.3	10.8	12.4	14.0	15.6	17.2	17.6	18.7	21.9	25.0	28.2	29.0	32.9	40.8	44.7	48.7	53.5		
6.0	6.4	7.2	8.0	9.6	11.2	12.7	14.3	15.9	17.5	19.1	19.5	20.6	23.8	26.9	30.1	30.9	34.8	42.7	46.6	50.6	55.4		
5.2	5.6	6.4	7.2	8.8	10.4	12.0	13.5	15.1	16.7	18.3	18.7	19.8	23.0	26.1	29.3	30.1	34.0	41.9	45.8	49.8	54.6		
...	8.1	9.7	11.3	12.9	13.3	14.4	17.6	20.8	23.9	24.7	28.6	36.5	40.5	44.4	49.3		
6.3	6.8	7.5	8.3	9.9	11.5	13.1	14.6	16.2	17.8	19.4	19.8	20.9	24.1	27.2	30.4	31.2	35.1	43.0	46.9	50.9	55.7		
...	7.2	8.8	10.3	11.9	13.5	15.1	15.6	16.7	19.8	23.0	26.1	26.9	30.9	38.7	42.7	46.6	51.5		
5.5	6.0	6.7	7.5	9.1	10.7	12.3	13.8	15.4	17.0	18.6	19.0	20.2	23.3	26.5	29.6	30.4	34.3	42.2	46.1	50.1	55.0		
4.7	5.1	5.9	6.7	8.3	9.9	11.5	13.1	14.6	16.2	17.8	18.3	19.4	22.5	25.7	28.8	29.6	33.5	41.4	45.4	49.3	54.2		
...	6.7	8.3	9.9	11.5	13.0	14.6	16.2	16.7	17.8	20.9	24.1	27.2	28.0	32.0	39.8	43.8	47.7	52.6		
5.8	6.3	7.1	7.9	9.4	11.0	12.6	14.2	15.7	17.3	18.9	19.4	20.5	23.6	26.8	29.9	30.7	34.6	42.5	46.5	50.4	55.3		
...	...	5.5	6.2	7.8	9.4	11.0	12.6	14.2	15.7	17.3	17.8	18.9	22.0	25.2	28.3	29.1	33.1	40.9	44.9	48.8	53.7		
...	7.8	9.4	11.0	12.5	14.1	14.6	15.7	18.9	22.0	25.2	26.0	29.9	37.8	41.7	45.7	50.5		
5.3	5.8	6.6	7.4	8.9	10.5	12.1	13.7	15.3	16.8	18.4	18.9	20.0	23.1	26.3	29.4	30.2	34.2	42.0	46.0	49.9	54.8		
6.1	6.6	7.4	8.2	9.7	11.3	12.9	14.5	16.1	17.6	19.2	19.7	20.8	23.9	27.1	30.2	31.0	35.0	42.8	46.8	50.7	55.6		
...	6.9	8.4	10.0	11.6	13.2	14.8	16.3	16.8	17.9	21.1	24.2	27.4	28.2	32.1	40.0	43.9	47.9	52.7		
4.8	5.3	6.1	6.9	8.5	10.0	11.6	13.2	14.8	16.4	17.9	18.4	19.5	22.7	25.8	29.0	29.8	33.7	41.6	45.5	49.4	54.3		
5.6	6.1	6.9	7.7	9.3	10.8	12.4	14.0	15.6	17.2	18.7	19.2	20.3	23.5	26.6	29.8	30.5	34.5	42.4	46.3	50.2	55.1		
...	4.8	5.6	6.4	8.0	9.6	11.1	12.7	14.3	15.9	17.5	17.9	19.0	22.2	25.3	28.5	29.3	33.2	41.1	45.0	49.0	53.9		
...	7.5	9.1	10.6	12.2	13.8	15.4	15.9	17.0	20.1	23.3	26.4	27.2	31.2	39.0	43.0	46.9	51.8		
...	8.8	10.4	12.0	12.5	13.6	16.8	19.9	23.1	23.9	27.8	35.7	39.7	43.6	48.5		
5.9	6.4	7.2	8.0	9.6	11.2	12.7	14.3	15.9	17.5	19.0	19.5	20.6	23.8	26.9	30.1	30.9	34.8	42.7	46.6	50.5	55.4		
...	8.1	9.7	11.2	12.8	14.4	14.9	16.0	19.2	22.3	25.5	26.3	30.2	38.1	42.0	46.0	50.8		
...	5.4	7.0	8.6	10.2	11.8	13.3	14.9	16.5	17.0	18.1	21.2	24.4	27.5	28.3	32.3	40.1	44.1	48.0	52.9		
5.5	5.9	6.7	7.5	9.1	10.7	12.3	13.8	15.4	17.0	18.6	19.0	20.1	23.3	26.4	29.6	30.4	34.3	42.2	46.1	50.1	55.0		
...	8.7	10.3	11.9	13.4	13.9	15.0	18.2	21.4	24.5	25.3	29.2	37.1	41.1	45.0	49.9		
...	6.0	7.6	9.2	10.8	12.4	14.0	15.5	16.0	17.1	20.3	23.4	26.6	27.4	31.3	39.2	43.1	47.1	52.0		
5.0	5.4	6.2	7.0	8.6	10.2	11.8	13.4	14.9	16.5	18.1	18.6	19.7	22.8	26.0	29.1	29.9	33.8	41.7	45.7	49.6	54.5		
...	4.9	5.7	6.5	8.1	9.7	11.3	12.9	14.5	16.0	17.6	18.1	19.2	22.3	25.5	28.6	29.4	33.4	41.2	45.2	49.1	54.0		
.8			.9				1.0					1.1				1.2							

PULLEYS

HTS® 8 mm Drive Selection Tables



DN RPM	Drive Ratio	Sprocket Combination				HP Ratings @ 1160 RPM Driver							
		Driver		Driven		RPP™ Belt Widths				RPP™ PLUS Belt Widths			
		No. Teeth	P.D.	No. Teeth	P.D.	20	30	50	85	20	30	50	85
Multiply hp rating by belt length factor to determine drive width—BELT LENGTH FACTOR →													
672	1.73	22	2.206	38	3.810	2.65	4.21	7.28	...	4.41	6.97	12.1	...
663	1.75	32	3.208	56	5.614	4.68	7.45	12.90	...	6.70	10.60	18.4	...
663	1.75	64	6.416	112	11.229	11.50	18.20	31.60	54.9	14.50	22.80	39.6	69.0
653	1.78	36	3.609	64	6.416	6.87	10.90	18.90	32.8	7.64	12.10	20.9	36.5
644	1.80	40	4.010	72	7.218	7.56	12.00	20.80	36.2	8.59	13.60	23.6	41.0
644	1.80	80	8.020	144	14.437	13.80	21.90	38.00	66.0	18.40	29.20	50.6	88.1
638	1.82	22	2.206	40	4.010	2.65	4.21	7.28	...	4.41	6.97	12.1	...
638	1.82	44	4.411	80	8.020	8.25	13.10	22.70	39.4	9.55	15.10	26.2	45.6
633	1.83	24	2.406	44	4.411	2.89	4.59	7.94	...	4.86	7.68	13.3	...
628	1.85	26	2.607	48	4.812	3.13	4.97	8.60	...	5.32	8.40	14.6	...
621	1.87	30	3.008	56	5.614	4.07	6.46	11.20	...	6.24	9.86	17.1	...
619	1.88	48	4.812	90	9.023	8.92	14.20	24.50	42.7	10.50	16.60	28.8	50.2
616	1.88	34	3.409	64	6.416	5.35	8.50	14.70	25.6	7.17	11.30	19.7	34.2
612	1.89	38	3.810	72	7.218	7.22	11.50	19.80	34.5	8.12	12.80	22.2	38.7
580	2.00	22	2.206	44	4.411	2.65	4.21	7.28	...	4.41	6.97	12.1	...
580	2.00	24	2.406	48	4.812	2.89	4.59	7.94	...	4.86	7.68	13.3	...
580	2.00	28	2.807	56	5.614	3.73	5.93	10.30	...	5.78	9.13	15.8	...
580	2.00	32	3.208	64	6.416	4.68	7.45	12.90	...	6.70	10.60	18.4	...
580	2.00	36	3.609	72	7.218	6.87	10.90	18.90	32.8	7.64	12.10	20.9	36.5
580	2.00	40	4.010	80	8.020	7.56	12.00	20.80	36.2	8.59	13.60	23.6	41.0
580	2.00	56	5.614	112	11.229	10.20	16.30	28.10	48.9	12.50	19.70	34.2	59.6
580	2.00	72	7.218	144	14.437	12.70	20.10	34.80	60.6	16.40	26.00	45.1	78.5
567	2.05	44	4.411	90	9.023	8.25	13.10	22.70	39.4	9.55	15.10	26.2	45.6
551	2.11	38	3.810	80	8.020	7.22	11.50	19.80	34.5	8.12	12.80	22.2	38.7
548	2.12	34	3.409	72	7.218	5.35	8.50	14.70	25.6	7.17	11.30	19.7	34.2
544	2.13	30	3.008	64	6.416	4.07	6.46	11.20	...	6.24	9.86	17.1	...
539	2.15	26	2.607	56	5.614	3.13	4.97	8.60	...	5.32	8.40	14.6	...
532	2.18	22	2.206	48	4.812	2.65	4.21	7.28	...	4.41	6.97	12.1	...
522	2.22	36	3.609	80	8.020	6.87	10.90	18.90	32.8	7.64	12.10	20.9	36.5
516	2.25	32	3.208	72	7.218	4.68	7.45	12.90	...	6.70	10.60	18.4	...
516	2.25	40	4.010	90	9.023	7.56	12.00	20.80	36.2	8.59	13.60	23.6	41.0
516	2.25	64	6.416	144	14.437	11.50	18.20	31.60	54.9	14.50	22.80	39.6	69.0
508	2.29	28	2.807	64	6.416	3.73	5.93	10.30	...	5.78	9.13	15.8	...
497	2.33	24	2.406	56	5.614	2.89	4.59	7.94	...	4.86	7.68	13.3	...
497	2.33	48	4.812	112	11.229	8.92	14.20	24.50	42.7	10.50	16.60	28.8	50.2
493	2.35	34	3.409	80	8.020	5.35	8.50	14.70	25.6	7.17	11.30	19.7	34.2
490	2.37	38	3.810	90	9.023	7.22	11.50	19.80	34.5	8.12	12.80	22.2	38.7
483	2.40	30	3.008	72	7.218	4.07	6.46	11.20	...	6.24	9.86	17.1	...
483	2.40	80	8.020	192	19.249	13.80	21.90	38.00	66.0	18.40	29.20	50.6	88.1
471	2.46	26	2.607	64	6.416	3.13	4.97	8.60	...	5.32	8.40	14.6	...
464	2.50	32	3.208	80	8.020	4.68	7.45	12.90	...	6.70	10.60	18.4	...
464	2.50	36	3.609	90	9.023	6.87	10.90	18.90	32.8	7.64	12.10	20.9	36.5
456	2.55	22	2.206	56	5.614	2.65	4.21	7.28	...	4.41	6.97	12.1	...
456	2.55	44	4.411	112	11.229	8.25	13.10	22.70	39.4	9.55	15.10	26.2	45.6
451	2.57	28	2.807	72	7.218	3.73	5.93	10.30	...	5.78	9.13	15.8	...
451	2.57	56	5.614	144	14.437	10.20	16.30	28.10	48.9	12.50	19.70	34.2	59.6
438	2.65	34	3.409	90	9.023	5.35	8.50	14.70	25.6	7.17	11.30	19.7	34.2
435	2.67	24	2.406	64	6.416	2.89	4.59	7.94	...	4.86	7.68	13.3	...
435	2.67	30	3.008	80	8.020	4.07	6.46	11.20	...	6.24	9.86	17.1	...
435	2.67	72	7.218	192	19.249	12.7	20.10	34.80	60.6	16.40	26.00	45.1	78.5
Multiply hp rating by belt length factor to determine drive width—BELT LENGTH FACTOR →													

PULLEYS



HTS® 8 mm Drive Selection Tables

NOMINAL CENTER DISTANCES																						
BELT LENGTH CODE DESIGNATION																						
560	600	640	720	800	880	960	1040	1120	1200	1224	1280	1440	1600	1760	1800	2000	2400	2600	2800	3048	3280	
.8		.9				1.0					1.1				1.2							
6.2	7.0	7.8	9.4	11.0	12.6	14.2	15.7	17.3	18.9	19.4	20.5	23.6	26.8	29.9	30.7	34.6	42.5	46.5	50.4	55.3	59.8	
...	...	5.5	7.1	8.7	10.3	11.9	13.5	15.1	16.6	17.1	18.2	21.4	24.5	27.7	28.5	32.4	40.3	44.2	48.2	53.1	57.6	
...	9.9	11.1	14.3	17.5	20.6	21.4	25.4	33.3	37.2	41.2	46.1	50.7	
...	6.1	7.7	9.3	10.9	12.5	14.1	15.7	16.2	17.3	20.4	23.6	26.7	27.5	31.5	39.3	43.3	47.2	52.1	56.7	
...	6.7	8.3	9.9	11.5	13.1	14.7	15.2	16.3	19.5	22.6	25.8	26.6	30.5	38.4	42.3	46.3	51.2	55.7	
...	13.5	16.7	17.5	21.5	29.4	33.4	37.3	42.2	46.8	
6.1	6.9	7.7	9.2	10.8	12.4	14.0	15.6	17.1	18.7	19.2	20.3	23.4	26.6	29.8	30.5	34.5	42.4	46.3	50.2	55.1	59.7	
...	7.3	8.9	10.5	12.1	13.7	14.2	15.3	18.5	21.7	24.8	25.6	29.6	37.4	41.4	45.3	50.2	54.8	
5.6	6.4	7.2	8.8	10.3	11.9	13.5	15.1	16.7	18.2	18.7	19.8	23.0	26.1	29.3	30.1	34.0	41.9	45.8	49.8	54.6	59.2	
5.1	5.9	6.7	8.3	9.9	11.4	13.0	14.6	16.2	17.8	18.2	19.3	22.5	25.6	28.8	29.6	33.5	41.4	45.3	49.3	54.2	58.7	
...	...	5.7	7.3	8.9	10.5	12.1	13.6	15.2	16.8	17.3	18.4	21.5	24.7	27.8	28.6	32.6	40.5	44.4	48.3	53.2	57.8	
...	7.7	9.4	11.0	12.6	13.1	14.2	17.3	20.5	23.7	24.5	28.4	36.3	40.3	44.2	49.1	53.7	
...	6.3	7.9	9.5	11.1	12.7	14.2	15.8	16.3	17.4	20.6	23.7	26.9	27.7	31.6	39.5	43.4	47.4	52.3	56.8	
...	6.9	8.5	10.1	11.7	13.3	14.9	15.3	16.4	19.6	22.8	25.9	26.7	30.7	38.5	42.5	46.4	51.3	55.9	
5.7	6.5	7.3	8.9	10.5	12.1	13.7	15.2	16.8	18.4	18.9	20.0	23.1	26.3	29.4	30.2	34.2	42.0	46.0	49.9	54.8	59.4	
5.2	6.0	6.8	8.4	10.0	11.6	13.2	14.8	16.3	17.9	18.4	19.5	22.6	25.8	29.0	29.7	33.7	41.6	45.5	49.4	54.3	58.9	
...	5.0	5.8	7.4	9.0	10.6	12.2	13.8	15.4	16.9	17.4	18.5	21.7	24.8	28.0	28.8	32.7	40.6	44.5	48.5	53.4	57.9	
...	6.4	8.0	9.6	11.2	12.8	14.4	16.0	16.5	17.6	20.7	23.9	27.0	27.8	31.8	39.7	43.6	47.5	52.4	57.0	
...	7.0	8.6	10.2	11.8	13.4	15.0	15.5	16.6	19.8	22.9	26.1	26.9	30.8	38.7	42.6	46.6	51.5	56.0	
...	7.6	9.2	10.8	12.4	14.0	14.5	15.6	18.8	22.0	25.1	25.9	29.9	37.7	41.7	45.6	50.5	55.1	
...	10.0	10.5	11.6	14.8	18.0	21.2	22.0	26.0	33.9	37.8	41.8	46.7	51.3	
...	14.0	17.2	18.0	22.1	30.0	34.0	37.9	42.8	47.4	
...	8.0	9.6	11.2	12.9	13.3	14.5	17.6	20.8	24.0	24.8	28.7	36.6	40.6	44.5	49.4	54.0	
...	7.7	9.4	11.0	12.6	14.2	14.6	15.8	18.9	22.1	25.3	26.1	30.0	37.9	41.8	45.8	50.7	55.2	
...	7.1	8.8	10.4	12.0	13.6	15.2	15.6	16.7	19.9	23.1	26.2	27.0	31.0	38.9	42.8	46.7	51.6	56.2	
...	6.5	8.2	9.8	11.4	13.0	14.5	16.1	16.6	17.7	20.9	24.0	27.2	28.0	31.9	39.8	43.7	47.7	52.6	57.1	
...	5.1	5.9	7.6	9.2	10.8	12.3	13.9	15.5	17.1	17.6	18.7	21.8	25.0	28.1	28.9	32.9	40.8	44.7	48.6	53.5	58.1	
5.3	6.2	7.0	8.6	10.1	11.7	13.3	14.9	16.5	18.1	18.5	19.6	22.8	26.0	29.1	29.9	33.8	41.7	45.7	49.6	54.5	59.0	
...	7.9	9.5	11.1	12.7	14.3	14.8	15.9	19.1	22.2	25.4	26.2	30.2	38.0	42.0	45.9	50.8	55.4	59.9	
...	7.3	8.9	10.5	12.1	13.7	15.3	15.8	16.9	20.1	23.2	26.4	27.2	31.1	39.0	42.9	46.9	51.8	56.3	
...	8.3	9.9	11.5	13.1	13.6	14.7	17.9	21.1	24.3	25.1	29.0	36.9	40.9	44.8	49.7	54.3	
...	11.2	14.5	17.8	18.6	22.6	30.6	34.6	38.5	43.4	48.0	
...	6.7	8.3	9.9	11.5	13.1	14.7	16.3	16.7	17.9	21.0	24.2	27.3	28.1	32.1	40.0	43.9	47.8	52.7	57.3	
...	5.3	6.1	7.7	9.3	10.9	12.5	14.1	15.7	17.2	17.7	18.8	22.0	25.1	28.3	29.1	33.0	40.9	44.9	48.8	53.7	58.2	
...	8.9	10.5	11.0	12.2	15.4	18.6	21.8	22.6	26.6	34.5	38.4	42.4	47.3	51.9	
...	8.0	9.6	11.2	12.9	14.5	14.9	16.0	19.2	22.4	25.6	26.4	30.3	38.2	42.1	46.1	51.0	55.5	
...	8.4	10.0	11.7	13.3	13.8	14.9	18.1	21.2	24.4	25.2	29.2	37.1	41.0	45.0	49.9	54.4	
...	7.4	9.0	10.6	12.3	13.8	15.4	15.9	17.0	20.2	23.4	26.5	27.3	31.3	39.2	43.1	47.0	51.9	56.5	
...	17.0	25.2	29.2	33.2	38.1	42.8	
...	6.8	8.4	10.0	11.6	13.2	14.8	16.4	16.9	18.0	21.2	24.3	27.5	28.3	32.2	40.1	44.1	48.0	52.9	57.4	
...	6.5	8.1	9.8	11.4	13.0	14.6	15.1	16.2	19.4	22.5	25.7	26.5	30.5	38.3	42.3	46.2	51.1	55.7	
...	8.5	10.2	11.8	13.4	13.9	15.0	18.2	21.4	24.6	25.4	29.3	37.2	41.2	45.1	50.0	54.6	
...	5.4	6.2	7.8	9.4	11.0	12.6	14.2	15.8	17.4	17.9	19.0	22.1	25.3	28.5	29.2	33.2	41.1	45.0	48.9	53.8	58.4	
...	9.1	10.8	11.3	12.4	15.7	18.9	22.1	22.9	26.9	34.8	38.7	42.7	47.6	52.2	
...	5.9	7.5	9.2	10.8	12.4	14.0	15.6	17.2	20.3	23.5	26.7	27.5	31.4	39.3	43.2	47.2	52.1	56.7	
...	7.0	8.7	10.3	11.9	13.6	14.0	15.2	18.4	21.5	24.7	25.5	29.5	37.4	41.3	45.3	50.2	54.7	
...	...	5.3	6.9	8.6	10.2	11.8	13.4	15.0	16.6	17.0	18.2	21.3	24.5	27.6	28.4	32.4	40.3	44.2	48.1	53.0	57.6	
...	6.6	8.3	9.9	11.5	13.1	14.7	15.2	16.3	19.5	22.7	25.9	26.6	30.6	38.5	42.4	46.4	51.3	55.8	
...	17.5	25.7	29.8	33.8	38.7	43.3	
.8	.9	1.0					1.1				1.2											

PULLEYS

HTS® 8 mm Drive Selection Tables



DN RPM	Drive Ratio	Sprocket Combination				HP Ratings @ 1160 RPM Driver							
		Driver		Driven		RPP™ Belt Widths				RPP™ PLUS Belt Widths			
		No. Teeth	P.D.	No. Teeth	P.D.	20	30	50	85	20	30	50	85
Multiply hp rating by belt length factor to determine drive width—BELT LENGTH FACTOR →													
419	2.77	26	2.607	72	7.218	3.13	4.97	8.60	...	5.32	8.40	14.6	...
414	2.80	40	4.010	112	11.229	7.56	12.00	20.80	36.2	8.59	13.60	23.6	41.0
412	2.81	32	3.208	90	9.023	4.68	7.45	12.90	...	6.70	10.60	18.4	...
406	2.86	28	2.807	80	8.020	3.73	5.93	10.30	...	5.78	9.13	15.8	...
399	2.91	22	2.206	64	6.416	2.65	4.21	7.28	...	4.41	6.97	12.1	...
394	2.95	38	3.810	112	11.229	7.22	11.5	19.80	34.5	8.12	12.80	22.2	38.7
387	3.00	24	2.406	72	7.218	2.89	4.59	7.94	...	4.86	7.68	13.3	...
387	3.00	30	3.008	90	9.023	4.07	6.46	11.20	...	6.24	9.86	17.1	...
387	3.00	48	4.812	144	14.437	8.92	14.20	24.50	42.7	10.50	16.60	28.8	50.2
387	3.00	64	6.416	192	19.249	11.50	18.20	31.60	54.9	14.50	22.8	39.6	69.0
377	3.08	26	2.607	80	8.020	3.13	4.97	8.60	...	5.32	8.40	14.6	...
373	3.11	36	3.609	112	11.229	6.87	10.90	18.90	32.8	7.64	12.10	20.9	36.5
361	3.21	28	2.807	90	9.023	3.73	5.93	10.30	...	5.78	9.13	15.8	...
354	3.27	22	2.206	72	7.218	2.65	4.21	7.28	...	4.41	6.97	12.1	...
354	3.27	44	4.411	144	14.437	8.25	13.10	22.70	39.4	9.55	15.10	26.2	45.6
352	3.29	34	3.409	112	11.229	5.35	8.50	14.70	25.6	7.17	11.30	19.7	34.2
348	3.33	24	2.406	80	8.020	2.89	4.59	7.94	...	4.86	7.68	13.3	...
338	3.43	56	5.614	192	19.249	10.20	16.30	28.10	48.9	12.50	19.70	34.2	59.6
335	3.46	26	2.607	90	9.023	3.13	4.97	8.60	...	5.32	8.40	14.6	...
331	3.50	32	3.208	112	11.229	4.68	7.45	12.90	...	6.70	10.60	18.4	...
322	3.60	40	4.010	144	14.437	7.56	12.00	20.80	36.2	8.59	13.60	23.6	41.0
319	3.64	22	2.206	80	8.020	2.65	4.21	7.28	...	4.41	6.97	12.1	...
311	3.73	30	3.008	112	11.229	4.07	6.46	11.20	...	6.24	9.86	17.1	...
309	3.75	24	2.406	90	9.023	2.89	4.59	7.94	...	4.86	7.68	13.3	...
306	3.79	38	3.810	144	14.437	7.22	11.50	19.80	34.5	8.12	12.8	22.2	38.7
290	4.00	28	2.807	112	11.229	3.73	5.93	10.30	...	5.78	9.13	15.8	...
290	4.00	36	3.609	144	14.437	6.87	10.90	18.90	32.8	7.64	12.10	20.9	36.5
290	4.00	48	4.812	192	19.249	8.92	14.20	24.5	42.7	10.50	16.60	28.8	50.2
284	4.09	22	2.206	90	9.023	2.65	4.21	7.28	...	4.41	6.97	12.1	...
274	4.24	34	3.409	144	14.437	5.35	8.50	14.70	25.6	7.17	11.30	19.7	34.2
269	4.31	26	2.607	112	11.229	3.13	4.97	8.60	...	5.32	8.40	14.6	...
266	4.36	44	4.411	192	19.249	8.25	13.10	22.70	39.4	9.55	15.10	26.2	45.6
258	4.50	32	3.208	144	14.437	4.68	7.45	12.90	...	6.70	10.60	18.4	...
249	4.67	24	2.406	112	11.229	2.89	4.59	7.94	...	4.86	7.68	13.3	...
242	4.80	30	3.008	144	14.437	4.07	6.46	11.20	...	6.24	9.86	17.1	...
242	4.80	40	4.010	192	19.249	7.56	12.00	20.80	36.2	8.59	13.60	23.6	41.0
230	5.05	38	3.810	192	19.249	7.22	11.50	19.80	34.5	8.12	12.80	22.2	38.7
228	5.09	22	2.206	112	11.229	2.65	4.21	7.28	...	4.41	6.97	12.1	...
226	5.14	28	2.807	144	14.437	3.73	5.93	10.30	...	5.78	9.13	15.8	...
218	5.33	36	3.609	192	19.249	6.87	10.90	18.90	32.8	7.64	12.10	20.9	36.5
209	5.54	26	2.607	144	14.437	3.13	4.97	8.60	...	5.32	8.40	14.6	...
205	5.65	34	3.409	192	19.249	5.35	8.50	14.70	25.6	7.17	11.30	19.7	34.2
193	6.00	24	2.406	144	14.437	2.89	4.59	7.94	...	4.86	7.68	13.3	...
193	6.00	32	3.208	192	19.249	4.68	7.45	12.90	...	6.70	10.60	18.4	...
181	6.40	30	3.008	192	19.249	4.07	6.46	11.20	...	6.24	9.86	17.1	...
177	6.55	22	2.206	144	14.437	2.65	4.21	7.28	...	4.41	6.97	12.1	...
169	6.86	28	2.807	192	19.249	3.73	5.93	10.30	...	5.78	9.13	15.8	...
157	7.38	26	2.607	192	19.249	3.13	4.97	8.60	...	5.32	8.40	14.6	...
145	8.00	24	2.406	192	19.249	2.89	4.59	7.94	...	4.86	7.68	13.3	...
133	8.73	22	2.206	192	19.249	2.65	4.21	7.28	...	4.41	6.97	12.1	...
Multiply hp rating by belt length factor to determine drive width—BELT LENGTH FACTOR →													

PULLEYS

HTS® 14 mm Drive Selection Tables



DN RPM	Drive Ratio	Sprocket Combination				HP Ratings @ 1750 RPM Driver									
		Driver		Driven		RPP™ Belt Widths					RPP™ PLUS Belt Widths				
		No. Teeth	P.D.	No. Teeth	P.D.	40	55	85	115	170	40	55	85	115	170
Multiply hp rating by belt length factor to determine drive width—BELT LENGTH FACTOR →															
1750	1.00	28	4.912	28	4.912	22.6	33.0	53.9	74.7	...	38.9	56.9	93.0	129	...
1750	1.00	29	5.088	29	5.088	24.2	35.4	57.7	80.0	...	40.5	59.2	96.8	134	...
1750	1.00	30	5.263	30	5.263	25.8	37.8	61.6	85.5	...	42.1	61.6	101.0	140	...
1750	1.00	32	5.614	32	5.614	29.3	42.9	69.9	97.0	...	45.2	66.3	108.0	150	...
1750	1.00	34	5.965	34	5.965	33.0	48.2	78.7	109.0	...	48.4	71.0	116.0	161	...
1750	1.00	36	6.316	36	6.316	36.9	53.9	88.0	122.0	...	51.6	75.7	124.0	172	...
1750	1.00	38	6.667	38	6.667	39.8	58.1	94.8	132.0	...	54.8	80.4	131.0	182	...
1750	1.00	40	7.018	40	7.018	41.3	60.4	98.6	137.0	207	58.1	85.1	139.0	193	292
1750	1.00	44	7.720	44	7.720	44.3	64.8	106.0	147.0	222	64.4	94.5	155.0	215	325
1750	1.00	48	8.421	48	8.421	47.0	68.7	112.0	156.0	235	70.8	104.0	170.0	236	357
1750	1.00	52	9.123	52	9.123	49.4	72.2	118.0	163.0	247	77.1	113.0	185.0	257	389
1750	1.00	56	9.825	56	9.825	51.5	75.3	123.0	170.0	258	83.3	122.0	200.0	278	421
1750	1.00	60	10.527	60	10.527	53.3	77.9	127.0	176.0	266	89.3	131.0	215.0	299	453
1750	1.00	64	11.229	64	11.229	54.7	80.0	130.0	181.0	273	95.3	140.0	230.0	320	484
1750	1.00	68	11.930	68	11.930	55.8	81.5	133.0	184.0	279	101.0	149.0	244.0	340	515
1750	1.00	72	12.632	72	12.632	56.4	82.5	135.0	187.0	282	107.0	157.0	258.0	359	544
1750	1.00	80	14.036	80	14.036	56.6	82.8	135.0	187.0	283	117.0	173.0	285.0	397	602
1692	1.03	29	5.088	30	5.263	24.2	35.4	57.7	80.0	...	40.5	59.2	96.8	134	...
1690	1.04	28	4.912	29	5.088	22.6	33.0	53.9	74.7	...	38.9	56.9	93.0	129	...
1663	1.05	38	6.667	40	7.018	39.8	58.1	94.8	132.0	...	54.8	80.4	131.0	182	...
1658	1.06	36	6.316	38	6.667	36.9	53.9	88.0	122.0	...	51.6	75.7	124.0	172	...
1653	1.06	34	5.965	36	6.316	33.0	48.2	78.7	109.0	...	48.4	71.0	116.0	161	...
1653	1.06	68	11.930	72	12.632	55.8	81.5	133.0	184.0	279	101.0	149.0	244.0	340	515
1647	1.06	32	5.614	34	5.965	29.3	42.9	69.9	97.0	...	45.2	66.3	108.0	150	...
1647	1.06	64	11.229	68	11.930	54.7	80.0	130.0	181.0	273	95.3	140.0	230.0	320	484
1641	1.07	30	5.263	32	5.614	25.8	37.8	61.6	85.5	...	42.1	61.6	101.0	140	...
1641	1.07	60	10.527	64	11.229	53.3	77.9	127.0	176.0	266	89.3	131.0	215.0	299	453
1633	1.07	28	4.912	30	5.263	22.6	33.0	53.9	74.7	...	38.9	56.9	93.0	129	...
1633	1.07	56	9.825	60	10.527	51.5	75.3	123.0	170.0	258	83.3	122.0	200.0	278	421
1625	1.08	52	9.123	56	9.825	49.4	72.2	118.0	163.0	247	77.1	113.0	185.0	257	389
1615	1.08	48	8.421	52	9.123	47.0	68.7	112.0	156.0	235	70.8	104.0	170.0	236	357
1604	1.09	44	7.720	48	8.421	44.3	64.8	106.0	147.0	222	64.4	94.5	155.0	215	325
1591	1.10	40	7.018	44	7.720	41.3	60.4	98.6	137.0	207	58.1	85.1	139.0	193	292
1586	1.10	29	5.088	32	5.614	24.2	35.4	57.7	80.0	...	40.5	59.2	96.8	134	...
1575	1.11	36	6.316	40	7.018	36.9	53.9	88.0	122.0	...	51.6	75.7	124.0	172	...
1575	1.11	72	12.632	80	14.036	56.4	82.5	135.0	187.0	282	107.0	157.0	258.0	359	544
1566	1.12	34	5.965	38	6.667	33.0	48.2	78.7	109.0	...	48.4	71.0	116.0	161	...
1556	1.13	32	5.614	36	6.316	29.3	42.9	69.9	97.0	...	45.2	66.3	108.0	150	...
1556	1.13	64	11.229	72	12.632	54.7	80.0	130.0	181.0	273	95.3	140.0	230.0	320	484
1556	1.13	80	14.036	90	15.790	56.6	82.8	135.0	187.0	283	117.0	173.0	285.0	397	602
1544	1.13	30	5.263	34	5.965	25.8	37.8	61.6	85.5	...	42.1	61.6	101.0	140	...
1544	1.13	60	10.527	68	11.930	53.3	77.9	127.0	176.0	266	89.3	131.0	215.0	299	453
1531	1.14	28	4.912	32	5.614	22.6	33.0	53.9	74.7	...	38.9	56.9	93.0	129	...
1531	1.14	56	9.825	64	11.229	51.5	75.3	123.0	170.0	258	83.3	122.0	200.0	278	421
1517	1.15	52	9.123	60	10.527	49.4	72.2	118.0	163.0	247	77.1	113.0	185.0	257	389
1511	1.16	38	6.667	44	7.720	39.8	58.1	94.8	132.0	...	54.8	80.4	131.0	182	...
1500	1.17	48	8.421	56	9.825	47.0	68.7	112.0	156.0	235	70.8	104.0	170.0	236	357
1493	1.17	29	5.088	34	5.965	24.2	35.4	57.7	80.0	...	40.5	59.2	96.8	134	...
1488	1.18	34	5.965	40	7.018	33.0	48.2	78.7	109.0	...	48.4	71.0	116.0	161	...
1488	1.18	68	11.930	80	14.036	55.8	81.5	133.0	184.0	279	101.0	149.0	244.0	340	515
Multiply hp rating by belt length factor to determine drive width—BELT LENGTH FACTOR →															



HTS® 14 mm Drive Selection Tables

NOMINAL CENTER DISTANCES																						
BELT LENGTH CODE DESIGNATION																						
966	1190	1400	1610	1778	1890	2100	2310	2450	2590	2800	3150	3360	3500	3850	4326	4578	4956	5320*	5740*	6160*	6860*	
.8	.9	.95	1.0			1.05			1.1						.9							
11.3	15.7	19.8	24.0	27.3	29.5	33.6	37.8	40.5	43.3	47.4	54.3	58.4	61.2	68.1	77.4	82.4	89.8	97.0	105.3	113.5	127.3	
11.0	15.4	19.6	23.7	27.0	29.2	33.4	37.5	40.2	43.0	47.1	54.0	58.2	60.9	67.8	77.2	82.1	89.6	96.7	105.0	113.3	127.1	
10.8	15.2	19.3	23.4	26.7	28.9	33.1	37.2	40.0	42.7	46.9	53.7	57.9	60.6	67.5	76.9	81.9	89.3	96.5	104.7	113.0	126.8	
10.2	14.6	18.7	22.9	26.2	28.4	32.5	36.7	39.4	42.2	46.3	53.2	57.3	60.1	67.0	76.3	81.3	88.7	95.9	104.2	112.4	126.2	
9.7	14.1	18.2	22.3	25.6	27.8	32.0	36.1	38.9	41.6	45.8	52.6	56.8	59.5	66.4	75.8	80.8	88.2	95.4	103.6	111.9	125.7	
9.1	13.5	17.6	21.8	25.1	27.3	31.4	35.6	38.3	41.1	45.2	52.1	56.2	59.0	65.9	75.2	80.2	87.6	94.8	103.1	111.3	125.1	
8.5	13.0	17.1	21.2	24.5	26.7	30.9	35.0	37.8	40.5	44.7	51.5	55.7	58.4	65.3	74.7	79.7	87.1	94.3	102.5	110.8	124.6	
...	12.4	16.5	20.7	24.0	26.2	30.3	34.5	37.2	40.0	44.1	51.0	55.1	57.9	64.8	74.1	79.1	86.5	93.7	102.0	110.2	124.0	
...	11.3	15.4	19.6	22.9	25.1	29.2	33.4	36.1	38.9	43.0	49.9	54.0	56.8	63.7	73.0	78.0	85.4	92.6	100.9	109.1	122.9	
...	10.2	14.3	18.5	21.8	24.0	28.1	32.3	35.0	37.8	41.9	48.8	52.9	55.7	62.6	71.9	76.9	84.3	91.5	99.8	108.0	121.8	
...	...	13.2	17.4	20.7	22.9	27.0	31.1	33.9	36.7	40.8	47.7	51.8	54.6	61.5	70.8	75.8	83.2	90.4	98.7	106.9	120.7	
...	...	12.1	16.3	19.6	21.8	25.9	30.0	32.8	35.6	39.7	46.6	50.7	53.5	60.4	69.7	74.7	82.1	89.3	97.6	105.8	119.6	
...	15.2	18.5	20.7	24.8	29.8	31.7	34.5	38.6	45.5	49.6	52.4	59.3	68.6	73.6	81.0	88.2	96.5	104.7	118.5	
...	14.1	17.4	19.6	23.7	27.8	30.6	33.4	37.5	44.4	48.5	51.3	58.2	67.5	72.5	79.9	87.1	95.4	103.6	117.4	
...	16.3	18.5	22.6	26.7	29.5	32.3	36.4	43.3	47.4	50.2	57.1	66.4	71.4	78.8	86.0	94.3	102.5	116.3	
...	15.2	17.1	21.5	25.6	28.4	31.2	35.3	42.2	46.3	49.1	56.0	65.3	70.3	77.7	84.9	93.2	101.4	115.2	
...	15.2	19.3	23.4	26.2	28.9	33.1	40.0	44.1	46.9	53.8	63.1	68.1	75.5	82.7	91.0	99.2	113.0	
10.9	15.3	19.4	23.6	26.9	29.1	33.2	37.3	40.1	42.9	47.0	53.9	58.0	60.8	67.7	77.0	82.0	89.4	96.6	104.9	113.1	126.9	
11.2	15.6	19.7	23.8	27.1	29.4	33.5	37.6	40.4	43.1	47.3	54.2	58.3	61.0	67.9	77.3	82.3	89.7	96.9	105.1	113.4	127.2	
8.3	12.7	16.8	20.9	24.3	26.5	30.6	34.7	37.5	40.2	44.4	51.3	55.4	58.2	65.0	74.4	79.4	86.8	94.0	102.2	110.5	124.3	
8.8	13.2	17.4	21.5	24.8	27.0	31.1	35.3	38.0	40.8	44.9	51.8	55.9	58.7	65.6	75.0	79.9	87.4	94.5	102.8	111.1	124.8	
9.4	13.8	17.9	22.1	25.4	27.6	31.7	35.8	38.6	41.3	45.5	52.4	56.5	59.3	66.1	75.5	80.5	87.9	95.1	103.4	111.6	125.4	
...	15.7	17.9	22.1	26.2	28.9	31.7	35.8	42.7	46.9	49.6	56.5	65.9	70.8	78.3	85.4	93.7	102.0	115.8	
9.9	14.3	18.5	22.6	25.9	28.1	32.2	36.4	39.1	41.9	46.0	52.9	57.1	59.8	66.7	76.1	81.0	88.5	95.6	103.9	112.2	125.9	
...	13.5	16.8	19.0	23.2	27.3	30.0	32.8	36.9	43.8	48.0	50.7	57.6	67.0	71.9	79.4	86.5	94.8	103.1	116.9	
10.5	14.9	19.0	23.2	26.5	28.7	32.8	36.9	39.7	42.4	46.6	53.5	57.6	60.4	67.2	76.6	81.6	89.0	96.2	104.5	112.7	126.5	
...	14.6	17.9	20.1	24.3	28.4	31.1	33.9	38.0	44.9	49.1	51.8	58.7	68.1	73.0	80.5	87.6	95.9	104.2	118.0	
11.0	15.4	19.6	23.7	27.0	29.2	33.3	37.5	40.2	43.0	47.1	54.0	58.2	60.9	67.8	77.2	82.1	89.6	96.7	105.0	113.3	127.1	
...	...	11.6	15.7	19.0	21.2	25.4	29.5	32.3	35.0	39.1	46.0	50.2	52.9	59.8	69.2	74.1	81.6	88.7	97.0	105.3	119.1	
...	...	12.7	16.8	20.1	22.3	26.5	30.6	33.4	36.1	40.2	47.1	51.3	54.0	60.9	70.3	75.2	82.7	89.8	98.1	106.4	120.2	
...	...	13.8	17.9	21.2	23.4	27.6	31.7	34.5	37.2	41.3	48.2	52.4	55.1	62.0	71.4	76.3	83.8	91.0	99.2	107.5	121.3	
...	10.7	14.9	19.0	22.3	24.5	28.7	32.8	35.6	38.3	42.4	49.3	53.5	56.2	63.1	72.5	77.4	84.9	92.1	100.3	108.6	122.4	
...	11.9	16.0	20.1	23.4	25.6	29.8	33.9	36.7	39.4	43.5	50.4	54.6	57.3	64.2	73.6	78.5	86.0	93.2	101.4	109.7	123.5	
10.6	15.0	19.2	23.3	26.6	28.8	32.9	37.1	39.8	42.6	46.7	53.6	57.7	60.5	67.4	76.8	81.7	89.2	96.3	104.6	112.9	126.6	
8.5	13.0	17.1	21.2	24.5	26.7	30.9	35.0	37.8	40.5	44.6	51.5	55.7	58.4	65.3	74.7	79.7	87.1	94.3	102.5	110.8	124.6	
...	16.3	20.4	24.5	27.3	30.0	34.2	41.1	45.2	48.0	54.8	64.2	69.2	76.6	83.8	92.1	100.3	114.1	
9.1	13.5	17.6	21.8	25.1	27.3	31.4	35.6	38.3	41.1	45.2	52.1	56.2	59.0	65.9	75.2	80.2	87.6	94.8	103.1	111.3	125.1	
9.6	14.1	18.2	22.3	25.6	27.8	32.0	36.1	38.9	41.6	45.8	52.6	56.8	59.5	66.4	75.8	80.8	88.2	95.4	103.6	111.9	125.7	
...	16.3	18.5	22.6	26.7	29.5	32.2	36.4	43.3	47.4	50.2	57.1	66.4	71.4	78.8	86.0	94.3	102.5	116.3	
...	17.9	22.0	24.8	27.6	31.7	38.6	42.7	45.5	52.4	61.7	66.7	74.1	81.3	89.6	97.8	111.6	
10.2	14.6	18.7	22.9	26.2	28.4	32.5	36.7	39.4	42.2	46.3	53.2	57.3	60.1	67.0	76.3	81.3	88.7	95.9	104.2	112.4	126.2	
...	14.0	17.4	19.6	23.7	27.8	30.6	33.3	37.5	44.4	48.5	51.3	58.2	67.5	72.5	79.9	87.1	95.4	103.6	117.4	
10.7	15.2	19.3	23.4	26.7	28.9	33.1	37.2	40.0	42.7	46.9	53.7	57.9	60.6	67.5	76.9	81.9	89.3	96.5	104.7	113.0	126.8	
...	15.1	18.5	20.7	24.8	28.9	31.7	34.4	38.6	45.5	49.6	52.4	59.3	68.6	73.6	81.0	88.2	96.5	104.7	118.5
...	...	12.1	16.3	19.6	21.8	25.9	30.0	32.8	35.6	39.7	46.6	50.7	53.5	60.4	69.7	74.7	82.1	89.3	97.6	105.8	119.6	
...	12.1	16.3	20.4	23.7	25.9	30.0	34.2	36.9	39.7	43.8	50.7	54.8	57.6	64.5	73.9	78.8	86.3	93.4	101.7	110.0	123.7	
...	...	13.2	17.4	20.7	22.9	27.0	31.1	33.9	36.7	40.8	47.7	51.8	54.6	61.5	70.8	75.8	83.2	90.4	98.7	106.9	120.7	
10.3	14.7	18.9	23.0	26.3	28.5	32.7	36.8	39.5	42.3	46.4	53.3	57.5	60.2	67.1	76.5	81.4	88.9	96.0	104.3	112.6	126.4	
8.8	13.2	17.4	21.5	24.8	27.0	31.1	35.3	38.0	40.8	44.9	51.8	55.9	58.7	65.6	75.0	79.9	87.4	94.5	102.8	111.1	124.8	
...	14.6	16.8	20.9	25.1	27.8	30.6	34.7	41.6	45.7	48.5	55.4	64.8	69.7	77.2	84.3	92.6	100.9	114.7	
.8	.9	.95	1.0			1.05			1.1						.9							

* These belts are not available in RPP construction.

PULLEYS

HTS® 14 mm Drive Selection Tables



DN RPM	Drive Ratio	Sprocket Combination				HP Ratings @ 1750 RPM Driver									
		Driver		Driven		RPP™ Belt Widths					RPP™ PLUS Belt Widths				
		No. Teeth	P.D.	No. Teeth	P.D.	40	55	85	115	170	40	55	85	115	170
Multiply hp rating by belt length factor to determine drive width—BELT LENGTH FACTOR →															
1481	1.18	44	7.720	52	9.123	44.3	64.8	106.0	147.0	222	64.4	94.5	155.0	215	325
1474	1.19	32	5.614	38	6.667	29.3	42.9	69.9	97.0	...	45.2	66.3	108.0	150	...
1458	1.20	30	5.263	36	6.316	25.8	37.8	61.6	85.5	...	42.1	61.6	101.0	140	...
1458	1.20	40	7.018	48	8.421	41.3	60.4	98.6	137.0	207	58.1	85.1	139.0	193	292
1458	1.20	60	10.527	72	12.632	53.3	77.9	127.0	176.0	266	89.3	131.0	215.0	299	453
1441	1.21	28	4.912	34	5.965	22.6	33.0	53.9	74.7	...	38.9	56.9	93.0	129	...
1441	1.21	56	9.825	68	11.930	51.5	75.3	123.0	170.0	258	83.3	122.0	200.0	278	421
1432	1.22	36	6.316	44	7.720	36.9	53.9	88.0	122.0	...	51.6	75.7	124.0	172	...
1422	1.23	52	9.123	64	11.229	49.4	72.2	118.0	163.0	247	77.1	113.0	185.0	257	389
1410	1.24	29	5.088	36	6.316	24.2	35.4	57.7	80.0	...	40.5	59.2	96.8	134	...
1400	1.25	32	5.614	40	7.018	29.3	42.9	69.9	97.0	...	45.2	66.3	108.0	150	...
1400	1.25	48	8.421	60	10.527	47.0	68.7	112.0	156.0	235	70.8	104.0	170.0	236	357
1400	1.25	64	11.229	80	14.036	54.7	80.0	130.0	181.0	273	95.3	140.0	230.0	320	484
1400	1.25	72	12.632	90	15.790	56.4	82.5	135.0	187.0	282	107.0	157.0	258.0	359	544
1385	1.26	38	6.667	48	8.421	39.8	58.1	94.8	132.0	...	54.8	80.4	131.0	182	...
1382	1.27	30	5.263	38	6.667	25.8	37.8	61.6	85.5	...	42.1	61.6	101.0	140	...
1375	1.27	44	7.720	56	9.825	44.3	64.8	106.0	147.0	222	64.4	94.5	155.0	215	325
1361	1.29	28	4.912	36	6.316	22.6	33.0	53.9	74.7	...	38.9	56.9	93.0	129	...
1361	1.29	56	9.825	72	12.632	51.5	75.3	123.0	170.0	258	83.3	122.0	200.0	278	421
1352	1.29	34	5.965	44	7.720	33.0	48.2	78.7	109.0	...	48.4	71.0	116.0	161	...
1346	1.30	40	7.018	52	9.123	41.3	60.4	98.6	137.0	207	58.1	85.1	139.0	193	292
1338	1.31	52	9.123	68	11.930	49.4	72.2	118.0	163.0	247	77.1	113.0	185.0	257	389
1336	1.31	29	5.088	38	6.667	24.2	35.4	57.7	80.0	...	40.5	59.2	96.8	134	...
1322	1.32	68	11.930	90	15.790	55.8	81.5	133.0	184.0	279	101.0	149.0	244.0	340	515
1313	1.33	30	5.263	40	7.018	25.8	37.8	61.6	85.5	...	42.1	61.6	101.0	140	...
1313	1.33	36	6.316	48	8.421	36.9	53.9	88.0	122.0	...	51.6	75.7	124.0	172	...
1313	1.33	48	8.421	64	11.229	47.0	68.7	112.0	156.0	235	70.8	104.0	170.0	236	357
1313	1.33	60	10.527	80	14.036	53.3	77.9	127.0	176.0	266	89.3	131.0	215.0	299	453
1289	1.36	28	4.912	38	6.667	22.6	33.0	53.9	74.7	...	38.9	56.9	93.0	129	...
1283	1.36	44	7.720	60	10.527	44.3	64.8	106.0	147.0	222	64.4	94.5	155.0	215	325
1279	1.37	38	6.667	52	9.123	39.8	58.1	94.8	132.0	...	54.8	80.4	131.0	182	...
1273	1.38	32	5.614	44	7.720	29.3	42.9	69.9	97.0	...	45.2	66.3	108.0	150	...
1269	1.38	29	5.088	40	7.018	24.2	35.4	57.7	80.0	...	40.5	59.2	96.80	134	...
1264	1.38	52	9.123	72	12.632	49.4	72.2	118.0	163.0	247	77.1	113.0	185.0	257	389
1250	1.40	40	7.018	56	9.825	41.3	60.4	98.6	137.0	207	58.1	85.1	139.0	193	292
1250	1.40	80	14.036	112	19.650	56.6	82.8	135.0	187.0	283	117.0	173.0	285.0	397	602
1244	1.41	64	11.229	90	15.790	54.7	80.0	130.0	181.0	273	95.3	140.0	230.0	320	484
1240	1.41	34	5.965	48	8.421	33.0	48.2	78.7	109.0	...	48.4	71.0	116.0	161	...
1235	1.42	48	8.421	68	11.930	47.0	68.7	112.0	156.0	235	70.8	104.0	170.0	236	357
1225	1.43	28	4.912	40	7.018	22.6	33.0	53.9	74.7	...	38.9	56.9	93.0	129	...
1225	1.43	56	9.825	80	14.036	51.5	75.3	123.0	170.0	258	83.3	122.0	200.0	278	421
1212	1.44	36	6.316	52	9.123	36.9	53.9	88.0	122.0	...	51.6	75.7	124.0	172	...
1203	1.45	44	7.720	64	11.229	44.3	64.8	106.0	147.0	222	64.4	94.5	155.0	215	325
1193	1.47	30	5.263	44	7.720	25.8	37.8	61.6	85.5	...	42.1	61.6	101.0	140	...
1188	1.47	38	6.667	56	9.825	39.8	58.1	94.8	132.0	...	54.8	80.4	131.0	182	...
1167	1.50	32	5.614	48	8.421	29.3	42.9	69.9	97.0	...	45.2	66.3	108.0	150	...
1167	1.50	40	7.018	60	10.527	41.3	60.4	98.6	137.0	207	58.1	85.1	139.0	193	292
1167	1.50	48	8.421	72	12.632	47.0	68.7	112.0	156.0	235	70.8	104.0	170.0	236	357
1167	1.50	60	10.527	90	15.790	53.3	77.9	127.0	176.0	266	89.3	131.0	215.0	299	453
1153	1.52	29	5.088	44	7.720	24.2	35.4	57.7	80.0	...	40.5	59.2	96.8	134	...
Multiply hp rating by belt length factor to determine drive width—BELT LENGTH FACTOR →															



HTS® 14 mm Drive Selection Tables

NOMINAL CENTER DISTANCES																					
BELT LENGTH CODE DESIGNATION																					
966	1190	1400	1610	1778	1890	2100	2310	2450	2590	2800	3150	3360	3500	3850	4326	4578	4956	5320*	5740*	6160*	6860*
.8	.9	.95	1.0	1.05	1.1	.9															
...	10.2	14.3	18.5	21.8	24.0	28.1	32.2	35.0	37.8	41.9	48.8	52.9	55.7	62.6	71.9	76.9	84.3	91.5	99.8	108.0	121.8
9.4	13.8	17.9	22.0	25.4	27.6	31.7	35.8	38.6	41.3	45.5	52.4	56.5	59.3	66.1	75.5	80.5	87.9	95.1	103.3	111.6	125.4
9.9	14.3	18.5	22.6	25.9	28.1	32.2	36.4	39.1	41.9	46.0	52.9	57.0	59.8	66.7	76.1	81.0	88.5	95.6	103.9	112.2	125.9
...	11.3	15.4	19.6	22.9	25.1	29.2	33.3	36.1	38.9	43.0	49.9	54.0	56.8	63.7	73.0	78.0	85.4	92.6	100.9	109.1	122.9
...	13.5	16.8	19.0	23.1	27.3	30.0	32.8	36.9	43.8	47.9	50.7	57.6	67.0	71.9	79.4	86.5	94.8	103.1	116.9
10.5	14.9	19.0	23.1	26.5	28.7	32.8	36.9	39.7	42.4	46.6	53.5	57.6	60.4	67.2	76.6	81.6	89.0	96.2	104.5	112.7	126.5
...	14.6	17.9	20.1	24.2	28.4	31.1	33.9	38.0	44.9	49.1	51.8	58.7	68.1	73.0	80.5	87.6	95.9	104.2	118.0
...	12.4	16.5	20.7	24.0	26.2	30.3	34.4	37.2	40.0	44.1	51.0	55.1	57.9	64.8	74.1	79.1	86.5	93.7	102.0	110.2	124.0
...	...	11.5	15.7	19.0	21.2	25.3	29.5	32.2	35.0	39.1	46.0	50.2	52.9	59.8	69.2	74.1	81.6	88.7	97.0	105.3	119.1
10.0	14.5	18.6	22.7	26.0	28.2	32.4	36.5	39.3	42.0	46.2	53.1	57.2	59.9	66.8	76.2	81.2	88.6	95.8	104.0	112.3	126.1
9.1	13.5	17.6	21.8	25.1	27.3	31.4	35.5	38.3	41.1	45.2	52.1	56.2	59.0	65.9	75.2	80.2	87.6	94.8	103.1	111.3	125.1
...	...	12.6	16.8	20.1	22.3	26.4	30.6	33.3	36.1	40.2	47.1	51.3	54.0	60.9	70.3	75.2	82.7	89.8	98.1	106.4	120.2
...	15.1	17.3	21.5	25.6	28.4	31.1	35.3	42.1	46.3	49.0	55.9	65.3	70.3	77.7	84.9	93.1	101.4	115.2
...	19.0	23.1	25.9	28.6	32.8	39.7	43.8	46.6	53.5	62.8	67.8	75.2	82.4	90.7	98.9	112.7
...	11.5	15.7	19.8	23.1	25.3	29.5	33.6	36.4	39.1	43.3	50.2	54.3	57.0	63.9	73.3	78.3	85.7	92.9	101.1	109.4	123.2
9.6	14.0	18.2	22.3	25.6	27.8	32.0	36.1	38.9	41.6	45.7	52.6	56.8	59.5	66.4	75.8	80.7	88.2	95.4	103.6	111.9	125.7
...	...	13.7	17.9	21.2	23.4	27.5	31.7	34.4	37.2	41.3	48.2	52.4	55.1	62.0	71.4	76.3	83.8	90.9	99.2	107.5	121.3
10.2	14.6	18.7	22.9	26.2	28.4	32.5	36.7	39.4	42.2	46.3	53.2	57.3	60.1	67.0	76.3	81.3	88.7	95.9	104.2	112.4	126.2
...	14.0	17.3	19.5	23.7	27.8	30.6	33.3	37.5	44.4	48.5	51.2	58.1	67.5	72.5	79.9	87.1	95.4	103.6	117.4
8.2	12.6	16.8	20.9	24.2	26.4	30.6	34.7	37.5	40.2	44.4	51.3	55.4	58.1	65.0	74.4	79.4	86.8	94.0	102.2	110.5	124.3
...	10.7	14.8	19.0	22.3	24.5	28.6	32.8	35.5	38.3	42.4	49.3	53.5	56.2	63.1	72.5	77.4	84.9	92.0	100.3	108.6	122.4
...	15.1	18.4	20.6	24.8	28.9	31.7	34.4	38.6	45.5	49.6	52.4	59.2	68.6	73.6	81.0	88.2	96.5	104.7	118.5
9.8	14.2	18.3	22.5	25.8	28.0	32.1	36.2	39.0	41.7	45.9	52.8	56.9	59.7	66.6	75.9	80.9	88.3	95.5	103.8	112.0	125.8
...	15.3	17.5	21.5	25.6	28.4	31.1	35.3	42.1	46.3	49.0	55.9	65.3	70.3	77.7	84.9	93.1	101.4	115.2
9.3	13.8	17.9	22.0	25.3	27.5	31.7	35.8	38.6	41.3	45.5	52.4	56.5	59.2	66.1	75.5	80.5	87.9	95.1	103.3	111.6	125.4
...	11.8	16.0	20.1	23.4	25.6	29.7	33.9	36.6	39.4	43.5	50.4	54.6	57.3	64.2	73.6	78.5	86.0	93.1	101.4	109.7	123.5
...	...	12.0	16.2	19.5	21.7	25.9	30.0	32.8	35.5	39.7	46.6	50.7	53.5	60.3	69.7	74.7	82.1	89.3	97.6	105.8	119.6
...	15.6	17.8	22.0	26.1	28.9	31.6	35.8	42.7	46.8	49.6	56.5	65.9	70.8	78.3	85.4	93.7	102.0	115.7
9.9	14.3	18.4	22.6	25.9	28.1	32.2	36.4	39.1	41.9	46.0	52.9	57.0	59.8	66.7	76.1	81.0	88.5	95.6	103.9	112.2	125.9
...	...	13.2	17.3	20.6	22.8	27.0	31.1	33.9	36.6	40.8	47.7	51.8	54.6	61.4	70.8	75.8	83.2	90.4	98.7	106.9	120.7
...	11.0	15.1	19.3	22.6	24.8	28.9	33.1	35.8	38.6	42.7	49.6	53.7	56.5	63.4	72.8	77.7	85.2	92.3	100.6	108.9	122.6
8.5	12.9	17.1	21.2	24.5	26.7	30.9	35.0	37.7	40.5	44.6	51.5	55.7	58.4	65.3	74.7	79.6	87.1	94.3	102.5	110.8	124.6
9.5	13.9	18.0	22.2	25.5	27.7	31.8	36.0	38.7	41.5	45.6	52.5	56.6	59.4	66.3	75.6	80.6	88.1	95.2	103.5	111.8	125.5
...	14.5	17.8	20.0	24.2	28.3	31.1	33.9	38.0	44.9	49.0	51.8	58.7	68.1	73.0	80.5	87.6	95.9	104.2	117.9
...	10.1	14.3	18.4	21.7	23.9	28.1	32.2	35.0	37.7	41.9	48.8	52.9	55.7	62.5	71.9	76.9	84.3	91.5	99.8	108.0	121.8
...	18.8	21.6	24.4	28.5	35.4	39.6	42.4	49.3	58.6	63.6	71.1	78.2	86.5	94.8	108.6
...	15.8	20.0	24.1	26.9	29.7	33.8	40.7	44.9	47.6	54.5	63.9	68.9	76.3	83.5	91.8	100.0	113.8
...	12.1	16.2	20.4	23.7	25.9	30.0	34.2	36.9	39.7	43.8	50.7	54.8	57.6	64.5	73.9	78.8	86.3	93.4	101.7	110.0	123.7
...	...	11.4	15.6	18.9	21.1	25.3	29.4	32.2	35.0	39.1	46.0	50.1	52.9	59.8	69.2	74.1	81.6	88.7	97.0	105.3	119.0
9.6	14.0	18.2	22.3	25.6	27.8	32.0	36.1	38.8	41.6	45.7	52.6	56.8	59.5	66.4	75.8	80.7	88.2	95.4	103.6	111.9	125.7
...	16.1	18.3	22.5	26.7	29.4	32.2	36.3	43.2	47.4	50.1	57.0	66.4	71.4	78.8	86.0	94.2	102.5	116.3
...	11.2	15.4	19.5	22.8	25.0	29.2	33.3	36.1	38.8	43.0	49.9	54.0	56.8	63.7	73.0	78.0	85.4	92.6	100.9	109.1	122.9
...	...	12.6	16.7	20.0	22.3	26.4	30.5	33.3	36.1	40.2	47.1	51.2	54.0	60.9	70.3	75.2	82.7	89.8	98.1	106.4	120.2
8.7	13.2	17.3	21.5	24.8	27.0	31.1	35.3	38.0	40.8	44.9	51.8	55.9	58.7	65.6	75.0	79.9	87.4	94.5	102.8	111.1	124.8
...	10.3	14.5	18.7	22.0	24.2	28.3	32.5	35.2	38.0	42.1	49.0	53.2	55.9	62.8	72.2	77.2	84.6	91.8	100.0	108.3	122.1
...	12.3	16.5	20.6	23.9	26.1	30.3	34.4	37.2	39.9	44.1	51.0	55.1	57.9	64.8	74.1	79.1	86.5	93.7	102.0	110.2	124.0
...	...	13.7	17.8	21.1	23.4	27.5	31.6	34.4	37.2	41.3	48.2	52.3	55.1	62.0	71.4	76.3	83.8	90.9	99.2	107.5	121.3
...	15.0	18.3	20.6	24.7	28.9	31.6	34.4	38.5	45.4	49.6	52.3	59.2	68.6	73.6	81.0	88.2	96.4	104.7	118.5
...	16.3	18.5	22.5	26.7	29.4	32.2	36.3	43.2	47.4	50.1	57.0	66.4	71.4	78.8	86.0	94.2	102.5	116.3
8.9	13.3	17.5	21.6	24.9	27.1	31.3	35.4	38.1	40.9	45.0	51.9	56.1	58.8	65.7	75.1	80.1	87.5	94.7	102.9	111.2	125.0

* These belts are not available in RPP construction.

HTS® 14 mm Drive Selection Tables



DN RPM	Drive Ratio	Sprocket Combination				HP Ratings @ 1750 RPM Driver									
		Driver		Driven		RPP™ Belt Widths					RPP™ PLUS Belt Widths				
		No. Teeth	P.D.	No. Teeth	P.D.	40	55	85	115	170	40	55	85	115	170
Multiply hp rating by belt length factor to determine drive width—BELT LENGTH FACTOR →															
1144	1.53	34	5.965	52	9.123	33.0	48.2	78.7	109.0	...	48.4	71.0	116.0	161	...
1138	1.54	52	9.123	80	14.036	49.4	72.2	118.0	163.0	247	77.1	113.0	185.0	257	389
1132	1.55	44	7.720	68	11.930	44.3	64.8	106.0	147.0	222	64.4	94.5	155.0	215	325
1125	1.56	36	6.316	56	9.825	36.9	53.9	88.0	122.0	...	51.6	75.7	124.0	172	...
1125	1.56	72	12.632	112	19.650	56.4	82.5	135.0	187.0	282	107.0	157.0	258.0	359	544
1114	1.57	28	4.912	44	7.720	22.6	33.0	53.9	74.7	...	38.9	56.9	93.0	129	...
1108	1.58	38	6.667	60	10.527	39.8	58.1	94.8	132.0	...	54.8	80.4	131.0	182	...
1094	1.60	30	5.263	48	8.421	25.8	37.8	61.6	85.5	...	42.1	61.6	101.0	140	...
1094	1.60	40	7.018	64	11.229	41.3	60.4	98.6	137.0	207	58.1	85.1	139.0	193	292
1089	1.61	56	9.825	90	15.790	51.5	75.3	123.0	170.0	258	83.3	122.0	200.0	278	421
1077	1.63	32	5.614	52	9.123	29.3	42.9	69.9	97.0	...	45.2	66.3	108.0	150	...
1069	1.64	44	7.720	72	12.632	44.3	64.8	106.0	147.0	222	64.4	94.5	155.0	215	325
1063	1.65	34	5.965	56	9.825	33.0	48.2	78.7	109.0	...	48.4	71.0	116.0	161	...
1063	1.65	68	11.930	112	19.650	55.8	81.5	133.0	184.0	279	101.0	149.0	244.0	340	515
1057	1.66	29	5.088	48	8.421	24.2	35.4	57.7	80.0	...	40.5	59.2	96.8	134	...
1050	1.67	36	6.316	60	10.527	36.9	53.9	88.0	122.0	...	51.6	75.7	124.0	172	...
1050	1.67	48	8.421	80	14.036	47.0	68.7	112.0	156.0	235	70.8	104.0	170.0	236	357
1039	1.68	38	6.667	64	11.229	39.8	58.1	94.8	132.0	...	54.8	80.4	131.0	182	...
1029	1.70	40	7.018	68	11.930	41.3	60.4	98.6	137.0	207	58.1	85.1	139.0	193	292
1021	1.71	28	4.912	48	8.421	22.6	33.0	53.9	74.7	...	38.9	56.9	93.0	129	...
1011	1.73	52	9.123	90	15.790	49.4	72.2	118.0	163.0	247	77.1	113.0	185.0	257	389
1010	1.73	30	5.263	52	9.123	25.8	37.8	61.6	85.5	...	42.1	61.6	101.0	140	...
1000	1.75	32	5.614	56	9.825	29.3	42.9	69.9	97.0	...	45.2	66.3	108.0	150	...
1000	1.75	64	11.229	112	19.650	54.7	80.0	130.0	181.0	273	95.3	140.0	230.0	320	484
992	1.76	34	5.965	60	10.527	33.0	48.2	78.7	109.0	...	48.4	71.0	116.0	161	...
984	1.78	36	6.316	64	11.229	36.9	53.9	88.0	122.0	...	51.6	75.7	124.0	172	...
978	1.79	38	6.667	68	11.930	39.8	58.1	94.8	132.0	...	54.8	80.4	131.0	182	...
976	1.79	29	5.088	52	9.123	24.2	35.4	57.7	80.0	...	40.5	59.2	96.8	134	...
972	1.80	40	7.018	72	12.632	41.3	60.4	98.6	137.0	207	58.1	85.1	139.0	193	292
972	1.80	80	14.036	144	25.264	56.6	82.8	135.0	187.0	283	117.0	173.0	285.0	397	602
963	1.82	44	7.720	80	14.036	44.3	64.8	106.0	147.0	222	64.4	94.5	155.0	215	325
942	1.86	28	4.912	52	9.123	22.6	33.0	53.9	74.7	...	38.9	56.9	93.0	129	...
938	1.87	30	5.263	56	9.825	25.8	37.8	61.6	85.5	...	42.1	61.6	101.0	140	...
938	1.87	60	10.527	112	19.650	53.3	77.9	127.0	85.5	266	89.3	131.0	215.0	299	453
933	1.88	32	5.614	60	10.527	29.3	42.9	69.9	176.0	...	45.2	66.3	108.0	150	...
933	1.88	48	8.421	90	15.790	47.0	68.7	112.0	97.0	235	70.8	104.0	170.0	236	357
930	1.88	34	5.965	64	11.229	33.0	48.2	78.7	156.0	...	48.4	71.0	116.0	161	...
926	1.89	36	6.316	68	11.930	36.9	53.9	88.0	109.0	...	51.6	75.7	124.0	172	...
924	1.89	38	6.667	72	12.632	39.8	58.1	94.8	122.0	...	54.8	80.4	131.0	182	...
906	1.93	29	5.088	56	9.825	24.2	35.4	57.7	132.0	...	40.5	59.2	96.8	134	...
875	2.00	28	4.912	56	9.825	22.6	33.0	53.9	80.0	...	38.9	56.9	93.0	129	...
875	2.00	30	5.263	60	10.527	25.8	37.8	61.6	74.7	...	42.1	61.6	101.0	140	...
875	2.00	32	5.614	64	11.229	29.3	42.9	69.9	85.5	...	45.2	66.3	108.0	150	...
875	2.00	34	5.965	68	11.930	33.0	48.2	78.7	97.0	...	48.4	71.0	116.0	161	...
875	2.00	36	6.316	72	12.632	36.9	53.9	88.0	109.0	...	51.6	75.7	124.0	172	...
875	2.00	40	7.018	80	14.036	41.3	60.4	98.6	122.0	207	58.1	85.1	139.0	193	292
875	2.00	56	9.825	112	19.650	51.5	75.3	123.0	137.0	258	83.3	122.0	200.0	278	421
875	2.00	72	12.632	144	25.264	56.4	82.5	135.0	170.0	282	107.0	157.0	258.0	359	544
856	2.05	44	7.720	90	15.790	44.3	64.8	106.0	187.0	222	64.4	94.5	155.0	215	325
846	2.07	29	5.088	60	10.527	24.2	35.4	57.7	147.0	...	40.5	59.2	96.8	134	...
									80.0						
Multiply hp rating by belt length factor to determine drive width—BELT LENGTH FACTOR →															



HTS® 14 mm Drive Selection Tables

NOMINAL CENTER DISTANCES																					
BELT LENGTH CODE DESIGNATION																					
966	1190	1400	1610	1778	1890	2100	2310	2450	2590	2800	3150	3360	3500	3850	4326	4578	4956	5320*	5740*	6160*	6860*
.8	.9	.95	1.0	1.05	1.1	.9															
...	11.5	15.6	19.8	23.1	25.3	29.4	33.6	36.3	39.1	43.2	50.1	54.3	57.0	63.9	73.3	78.3	85.7	92.9	101.1	109.4	123.2
...	13.3	16.6	18.9	23.0	27.2	29.9	32.7	36.8	43.8	47.9	50.7	57.6	66.9	71.9	79.3	86.5	94.8	103.0	116.8
...	...	11.9	16.1	19.5	21.7	25.8	30.0	32.7	35.5	39.6	46.5	50.7	53.4	60.3	69.7	74.7	82.1	89.3	97.5	105.8	119.6
...	10.6	14.8	18.9	22.3	24.5	28.6	32.8	35.5	38.3	42.4	49.3	53.4	56.2	63.1	72.5	77.4	84.9	92.0	100.3	108.6	122.4
...	19.8	22.6	25.4	29.6	36.5	40.6	43.4	50.3	59.7	64.7	72.1	79.3	87.6	95.8	109.6
...	13.4	17.6	21.7	25.0	27.2	31.4	35.5	38.3	41.0	45.2	52.1	56.2	59.0	65.9	75.2	80.2	87.6	94.8	103.1	111.3	125.1
...	9.7	13.9	18.1	21.4	23.6	27.8	31.9	34.7	37.4	41.6	48.5	52.6	55.4	62.3	71.6	76.6	84.0	91.2	99.5	107.7	121.5
...	12.6	16.7	20.9	24.2	26.4	30.6	34.7	37.4	40.2	44.3	51.2	55.4	58.1	65.0	74.4	79.4	86.8	94.0	102.2	110.5	124.3
...	...	13.1	17.2	20.6	22.8	26.9	31.1	33.8	36.6	40.7	47.6	51.8	54.5	61.4	70.8	75.8	83.2	90.4	98.6	106.9	120.7
...	14.6	16.8	21.0	25.2	27.9	30.7	34.9	41.8	45.9	48.7	55.6	65.0	69.9	77.4	84.6	92.8	101.1	114.9
...	11.7	15.9	20.0	23.4	25.6	29.7	33.9	36.6	39.4	43.5	50.4	54.5	57.3	64.2	73.6	78.5	86.0	93.1	101.4	109.7	123.5
...	15.5	18.9	21.1	25.2	29.4	32.2	34.9	39.1	46.0	50.1	52.9	59.8	69.1	74.1	81.5	88.7	97.0	105.3	119.0
...	10.8	15.0	19.2	22.5	24.7	28.9	33.0	35.8	38.5	42.7	49.6	53.7	56.5	63.4	72.7	77.7	85.1	92.3	100.6	108.8	122.6
...	20.3	23.1	25.9	30.1	37.0	41.2	43.9	50.8	60.2	65.2	72.7	79.8	88.1	96.4	110.2
...	12.7	16.9	21.0	24.3	26.5	30.7	34.8	37.6	40.3	44.5	51.4	55.5	58.3	65.2	74.5	79.5	86.9	94.1	102.4	110.6	124.4
...	10.0	14.2	18.3	21.7	23.9	28.0	32.2	34.9	37.7	41.8	48.7	52.9	55.6	62.5	71.9	76.9	84.3	91.5	99.7	108.0	121.8
...	13.8	17.1	19.4	23.5	27.7	30.5	33.2	37.4	44.3	48.4	51.2	58.1	67.5	72.4	79.9	87.0	95.3	103.6	117.4
...	...	13.3	17.5	20.8	23.0	27.2	31.3	34.1	36.9	41.0	47.9	52.0	54.8	61.7	71.1	76.0	83.5	90.6	98.9	107.2	121.0
...	...	12.4	16.6	20.0	22.2	26.3	30.5	33.3	36.0	40.2	47.1	51.2	54.0	60.9	70.2	75.2	82.6	89.8	98.1	106.4	120.1
...	12.8	17.0	21.1	24.5	26.7	30.8	35.0	37.7	40.5	44.6	51.5	55.6	58.4	65.3	74.7	79.6	87.1	94.2	102.5	110.8	124.6
...	15.1	17.3	21.5	25.7	28.5	31.2	35.4	42.3	46.5	49.2	56.1	65.5	70.5	77.9	85.1	93.4	101.6	115.4
...	12.0	16.1	20.3	23.6	25.8	30.0	34.1	36.9	39.6	43.8	50.7	54.8	57.6	64.5	73.8	78.8	86.2	93.4	101.7	109.9	123.7
...	11.1	15.3	19.4	22.8	25.0	29.1	33.3	36.0	38.8	42.9	49.8	54.0	56.7	63.6	73.0	78.0	85.4	92.6	100.8	109.1	122.9
...	20.8	23.6	26.4	30.6	37.5	41.7	44.4	51.4	60.8	65.7	73.2	80.4	88.6	96.9	110.7
...	10.2	14.4	18.6	21.9	24.1	28.3	32.4	35.2	38.0	42.1	49.0	53.1	55.9	62.8	72.2	77.1	84.6	91.7	100.0	108.3	122.1
...	...	13.5	17.7	21.1	23.3	27.4	31.6	34.4	37.1	41.3	48.2	52.3	55.1	62.0	71.3	76.3	83.7	90.9	99.2	107.5	121.2
...	...	12.7	16.9	20.2	22.4	26.6	30.8	33.5	36.3	40.4	47.3	51.5	54.2	61.1	70.5	75.5	82.9	90.1	98.4	106.6	120.4
...	12.1	16.3	20.4	23.8	26.0	30.1	34.3	37.0	39.8	43.9	50.8	54.9	57.7	64.6	74.0	78.9	86.4	93.5	101.8	110.1	123.9
...	...	11.8	16.0	19.4	21.6	25.7	29.9	32.7	35.4	39.6	46.5	50.6	53.4	60.3	69.7	74.6	82.1	89.3	97.5	105.8	119.6
...	23.6	30.6	34.8	37.6	44.6	54.0	59.0	66.5	73.6	81.9	90.2	104.0
...	14.2	17.6	19.9	24.0	28.2	31.0	33.7	37.9	44.8	49.0	51.7	58.6	68.0	73.0	80.4	87.6	95.9	104.1	117.9
...	12.2	16.4	20.6	23.9	26.1	30.2	34.4	37.1	39.9	44.0	50.9	55.1	57.8	64.7	74.1	79.1	86.5	93.7	102.0	110.2	124.0
...	11.3	15.5	19.7	23.0	25.2	29.4	33.5	36.3	39.1	43.2	50.1	54.2	57.0	63.9	73.3	78.2	85.7	92.8	101.1	109.4	123.2
...	17.0	21.3	24.1	26.9	31.1	38.0	42.2	45.0	51.9	61.3	66.3	73.7	80.9	89.2	97.5	111.2
...	10.4	14.7	18.8	22.2	24.4	28.6	32.7	35.5	38.2	42.4	49.3	53.4	56.2	63.1	72.4	77.4	84.8	92.0	100.3	108.6	122.3
...	15.5	17.8	22.0	26.2	29.0	31.7	35.9	42.8	47.0	49.7	56.7	66.0	71.0	78.5	85.6	93.9	102.2	116.0
...	...	13.8	18.0	21.3	23.5	27.7	31.9	34.6	37.4	41.5	48.4	52.6	55.3	62.2	71.6	76.6	84.0	91.2	99.5	107.7	121.5
...	...	12.9	17.1	20.5	22.7	26.9	31.0	33.8	36.5	40.7	47.6	51.7	54.5	61.4	70.8	75.7	83.2	90.4	98.6	106.9	120.7
...	...	12.0	16.3	19.6	21.8	26.0	30.2	32.9	35.7	39.8	46.8	50.9	53.7	60.6	69.9	74.9	82.4	89.5	97.8	106.1	119.8
...	11.5	15.7	19.8	23.2	25.4	29.5	33.7	36.4	39.2	43.3	50.2	54.4	57.1	64.0	73.4	78.4	85.8	93.0	101.3	109.5	123.3
...	11.6	15.8	20.0	23.3	25.5	29.7	33.8	36.6	39.3	43.5	50.4	54.5	57.3	64.2	73.6	78.5	86.0	93.1	101.4	109.7	123.5
...	10.7	14.9	19.1	22.4	24.7	28.8	33.0	35.7	38.5	42.6	49.5	53.7	56.4	63.3	72.7	77.7	85.1	92.3	100.6	108.8	122.6
...	9.8	14.0	18.2	21.6	23.8	28.0	32.1	34.9	37.6	41.8	48.7	52.8	55.6	62.5	71.9	76.8	84.3	91.5	99.7	108.0	121.8
...	...	13.2	17.4	20.7	22.9	27.1	31.3	34.0	36.8	41.0	47.9	52.0	54.8	61.7	71.0	76.0	83.5	90.6	98.9	107.2	121.0
...	...	12.3	16.5	19.9	22.1	26.3	30.4	33.2	36.0	40.1	47.0	51.2	53.9	60.8	70.2	75.2	82.6	89.8	98.1	106.3	120.1
...	14.7	18.1	20.4	24.5	28.7	31.5	34.3	38.4	45.3	49.5	52.2	59.1	68.5	73.5	80.9	88.1	96.4	104.7	118.5
...	17.5	21.7	24.6	27.4	31.6	38.5	42.7	45.5	52.4	61.8	66.8	74.2	81.4	89.7	98.0	111.8
...	20.2	24.5	31.6	35.8	38.6	45.6	55.0	60.0	67.5	74.7	83.0	91.3	105.1
...	16.0	18.3	22.5	26.7	29.5	32.3	36.4	43.3	47.5	50.3	57.2	66.6	71.5	79.0	86.2	94.4	102.7	116.5
...	10.8	15.0	19.2	22.6	24.8	28.9	33.1	35.9	38.6	42.8	49.7	53.8	56.6	63.5	72.8	77.8	85.3	92.4	100.7	109.0	122.7
.8	.9	.95	1.0	1.05	1.1	.9															

* These belts are not available in RPP construction.

HTS® 14 mm Drive Selection Tables



DN RPM	Drive Ratio	Sprocket Combination				HP Ratings @ 1750 RPM Driver									
		Driver		Driven		RPP™ Belt Widths					RPP™ PLUS Belt Widths				
		No. Teeth	P.D.	No. Teeth	P.D.	40	55	85	115	170	40	55	85	115	170
Multiply hp rating by belt length factor to determine drive width—BELT LENGTH FACTOR →															
833	2.10	80	14.036	168	29.475	56.6	82.8	135.0	187.0	283	117.0	173.0	285.0	397	602
831	2.11	38	6.667	80	14.036	39.8	58.1	94.8	132.0	...	54.8	80.4	131.0	182	...
826	2.12	34	5.965	72	12.632	33.0	48.2	78.7	109.0	...	48.4	71.0	116.0	161	...
826	2.12	68	11.930	144	25.264	55.8	81.5	133.0	184.0	279	101.0	149.0	244.0	340	515
824	2.13	32	5.614	68	11.930	29.3	42.9	69.9	97.0	...	45.2	66.3	108.0	150	...
820	2.13	30	5.263	64	11.229	25.8	37.8	61.6	85.5	...	42.1	61.6	101.0	140	...
817	2.14	28	4.912	60	10.527	22.6	33.0	53.9	74.7	...	38.9	56.9	93.0	129	...
813	2.15	52	9.123	112	19.650	49.4	72.2	118.0	163.0	247	77.1	113.0	185.0	257	389
793	2.21	29	5.088	64	11.229	24.2	35.4	57.7	80.0	...	40.5	59.2	96.8	134	...
788	2.22	36	6.316	80	14.036	36.9	53.9	88.0	122.0	...	51.6	75.7	124.0	172	...
778	2.25	32	5.614	72	12.632	29.3	42.9	69.9	97.0	...	45.2	66.3	108.0	150	...
778	2.25	40	7.018	90	15.790	41.3	60.4	98.6	137.0	207	58.1	85.1	139.0	193	292
778	2.25	64	11.229	144	25.264	54.7	80.0	130.0	181.0	273	95.3	140.0	230.0	320	484
772	2.27	30	5.263	68	11.930	25.8	37.8	61.6	85.5	...	42.1	61.6	101.0	140	...
766	2.29	28	4.912	64	11.229	22.6	33.0	53.9	74.7	...	38.9	56.9	93.0	129	...
750	2.33	48	8.412	112	19.650	47.0	68.7	112.0	156.0	235	70.8	104.0	170.0	236	357
750	2.33	72	12.632	168	29.475	56.4	82.5	135.0	187.0	282	107.0	157.0	258.0	359	544
746	2.34	29	5.088	68	11.930	24.2	35.4	57.7	80.0	...	40.5	59.2	96.8	134	...
744	2.35	34	5.965	80	14.036	33.0	48.2	78.7	109.0	...	48.4	71.0	116.0	161	...
739	2.37	38	6.667	90	15.790	39.8	58.1	94.8	132.0	...	54.8	80.4	131.0	182	...
729	2.40	30	5.263	72	12.632	25.8	37.8	61.6	85.5	...	42.1	61.6	101.0	140	...
729	2.40	60	10.527	144	25.264	53.3	77.9	127.0	176.0	266	89.3	131.0	215.0	299	453
729	2.40	80	14.036	192	33.686	56.6	82.8	135.0	187.0	283	117.0	173.0	285.0	397	602
721	2.43	28	4.912	68	11.930	22.6	33.0	53.9	74.7	...	38.9	56.9	93.0	129	...
708	2.47	68	11.930	168	29.475	55.8	81.5	133.0	184.0	279	101.0	149.0	244.0	340	515
705	2.48	29	5.088	72	12.632	24.2	35.4	57.7	80.0	...	40.5	59.2	96.8	134	...
700	2.50	32	5.614	80	14.036	29.3	42.9	69.9	97.0	...	45.2	66.3	108.0	150	...
700	2.50	36	6.316	90	15.790	36.9	53.9	88.0	122.0	...	51.6	75.7	124.0	172	...
688	2.55	44	7.720	112	19.650	44.3	64.8	106.0	147.0	222	64.4	94.5	155.0	215	325
681	2.57	28	4.912	72	12.632	22.6	33.0	53.9	74.7	...	38.9	56.9	93.0	129	...
681	2.57	56	9.825	144	25.264	51.5	75.3	123.0	170.0	258	83.3	122.0	200.0	278	421
667	2.63	64	11.229	168	29.475	54.7	80.0	130.0	181.0	273	95.3	140.0	230.0	320	484
661	2.65	34	5.965	90	15.790	33.0	48.2	78.7	109.0	...	48.4	71.0	116.0	161	...
656	2.67	30	5.263	80	14.036	25.8	37.8	61.6	85.5	...	42.1	61.6	101.0	140	...
656	2.67	72	12.632	192	33.686	56.4	82.5	135.0	187.0	282	107.0	157.0	258.0	359	544
648	2.70	80	14.036	216	37.896	56.6	82.8	135.0	187.0	283	117.0	173.0	285.0	397	602
634	2.76	29	5.088	80	14.036	24.2	35.4	57.7	80.0	...	40.5	59.2	96.8	134	...
632	2.77	52	9.123	144	25.264	49.4	72.2	118.0	163.0	247	77.1	113.0	185.0	257	389
625	2.80	40	7.018	112	19.650	41.3	60.4	98.6	137.0	207	58.1	85.1	139.0	193	292
625	2.80	60	10.527	168	29.475	53.3	77.9	127.0	176.0	266	89.3	131.0	215.0	299	453
622	2.81	32	5.614	90	15.790	29.3	42.9	69.9	97.0	...	45.2	66.3	108.0	150	...
620	2.82	68	11.930	192	33.686	55.8	81.5	133.0	187.0	279	101.0	149.0	244.0	340	515
613	2.86	28	4.912	80	14.036	22.6	33.0	53.9	74.7	...	38.9	56.9	93.0	129	...
594	2.95	38	6.667	112	19.650	39.8	58.1	94.8	132.0	...	54.8	80.4	131.0	182	...
583	3.00	30	5.263	90	15.790	25.8	37.8	61.6	85.5	...	42.1	61.6	101.0	140	...
583	3.00	48	8.421	144	25.264	47.0	68.7	112.0	156.0	235	70.8	104.0	170.0	236	357
583	3.00	56	9.825	168	29.475	51.5	75.3	123.0	170.0	258	83.3	122.0	200.0	278	421
583	3.00	64	11.229	192	33.686	54.7	80.0	130.0	181.0	273	95.3	140.0	230.0	320	484
583	3.00	72	12.632	216	37.896	56.4	82.5	135.0	187.0	282	107.0	157.0	258.0	359	544
564	3.10	29	5.088	90	15.790	24.2	35.4	57.7	80.0	...	40.5	59.2	96.8	134	...
Multiply hp rating by belt length factor to determine drive width—BELT LENGTH FACTOR →															



HTS® 14 mm Drive Selection Tables

NOMINAL CENTER DISTANCES																					
BELT LENGTH CODE DESIGNATION																					
966	1190	1400	1610	1778	1890	2100	2310	2450	2590	2800	3150	3360	3500	3850	4326	4578	4956	5320*	5740*	6160*	6860*
.8	.9	.95	1.0	1.05	1.1	.9															
...	26.7	31.0	33.8	40.9	50.4	55.4	62.9	70.1	78.4	86.7	100.6
...	15.0	18.4	20.6	24.8	29.0	31.7	34.5	38.7	45.6	49.7	52.5	59.4	68.8	73.8	81.2	88.4	96.7	104.9	118.7
...	...	12.5	16.7	20.1	22.3	26.5	30.7	33.4	36.2	40.4	47.3	51.4	54.2	61.1	70.5	75.4	82.9	90.1	98.3	106.6	120.4
...	20.7	25.0	32.1	36.3	39.1	46.1	55.5	60.5	68.0	75.2	83.5	91.8	105.6
...	...	13.4	17.6	21.0	23.2	27.4	31.5	34.3	37.1	41.2	48.1	52.3	55.0	61.9	71.3	76.3	83.7	90.9	99.2	107.4	121.2
...	...	14.3	18.5	21.8	24.1	28.2	32.4	35.1	37.9	42.1	49.0	53.1	55.9	62.8	72.1	77.1	84.6	91.7	100.0	108.3	122.1
...	...	15.2	19.4	22.7	24.9	29.1	33.2	36.0	38.8	42.9	49.8	53.9	56.7	63.6	73.0	77.9	85.4	92.6	100.8	109.1	122.9
...	17.9	22.2	25.1	27.9	32.1	39.0	43.2	46.0	52.9	62.3	67.3	74.8	82.0	90.2	98.5	112.3
...	...	14.4	18.6	22.0	24.2	28.4	32.5	35.3	38.0	42.2	49.1	53.2	56.0	62.9	72.3	77.2	84.7	91.9	100.1	108.4	122.2
...	15.2	18.6	20.8	25.0	29.2	32.0	34.8	38.9	45.9	50.0	52.8	59.7	69.1	74.0	81.5	88.7	96.9	105.2	119.0
...	...	12.7	17.0	20.4	22.6	26.8	30.9	33.7	36.5	40.6	47.5	51.7	54.5	61.4	70.7	75.7	83.2	90.3	98.6	106.9	120.7
...	13.0	16.5	18.8	23.0	27.2	30.0	32.8	36.9	43.9	48.0	50.8	57.7	67.1	72.1	79.5	86.7	95.0	103.3	117.0
...	21.1	25.5	32.6	36.8	39.6	46.6	56.0	61.0	68.5	75.7	84.0	92.3	106.1
...	...	13.6	17.9	21.2	23.5	27.6	31.8	34.6	37.3	41.5	48.4	52.5	55.3	62.2	71.6	76.5	84.0	91.2	99.4	107.7	121.5
...	...	14.5	18.7	22.1	24.3	28.5	32.6	35.4	38.2	42.3	49.2	53.4	56.1	63.0	72.4	77.4	84.8	92.0	100.3	108.5	122.3
...	18.4	22.7	25.5	28.4	32.6	39.5	43.7	46.5	53.4	62.8	67.8	75.3	82.5	90.8	99.1	112.9
...	27.6	31.9	34.8	41.8	51.4	56.4	63.9	71.1	79.5	87.8	101.6
...	...	13.8	18.0	21.3	23.6	27.8	31.9	34.7	37.5	41.6	48.5	52.7	55.4	62.3	71.7	76.7	84.1	91.3	99.6	107.8	121.6
...	15.4	18.8	21.1	25.3	29.5	32.3	35.0	39.2	46.1	50.3	53.0	59.9	69.3	74.3	81.7	88.9	97.2	105.5	119.3
...	13.3	16.7	19.0	23.2	27.4	30.2	33.0	37.2	44.1	48.3	51.0	58.0	67.4	72.3	79.8	87.0	95.2	103.5	117.3
...	...	13.0	17.2	20.6	22.8	27.0	31.2	34.0	36.7	40.9	47.8	52.0	54.7	61.6	71.0	76.0	83.4	90.6	98.9	107.1	120.9
...	21.6	25.9	33.0	37.3	40.1	47.1	56.5	61.5	69.0	76.2	84.5	92.8	106.7
...	26.8	29.8	37.0	46.6	51.7	59.2	66.5	74.8	83.2	97.0
...	...	13.9	18.1	21.5	23.7	27.9	32.0	34.8	37.6	41.7	48.6	52.8	55.6	62.5	71.8	76.8	84.3	91.4	99.7	108.0	121.8
...	28.1	32.4	35.2	42.3	51.9	56.9	64.4	71.6	80.0	88.3	102.1
...	...	13.1	17.3	20.7	23.0	27.1	31.3	34.1	36.9	41.0	47.9	52.1	54.8	61.8	71.1	76.1	83.6	90.7	99.0	107.3	121.1
...	...	11.3	15.7	19.1	21.3	25.5	29.7	32.5	35.3	39.4	46.4	50.5	53.3	60.2	69.6	74.6	82.0	89.2	97.5	105.7	119.5
...	13.5	17.0	19.2	23.5	27.7	30.5	33.3	37.4	44.4	48.5	51.3	58.2	67.6	72.6	80.1	87.2	95.5	103.8	117.6
...	18.9	23.2	26.0	28.8	33.1	40.0	44.2	47.0	53.9	63.4	68.4	75.8	83.0	91.3	99.6	113.4
...	...	13.2	17.5	20.8	23.1	27.3	31.4	34.2	37.0	41.1	48.1	52.2	55.0	61.9	71.3	76.2	83.7	90.9	99.1	107.4	121.2
...	19.1	22.1	26.4	33.5	37.8	40.6	47.6	57.0	62.1	69.6	76.8	85.1	93.4	107.2
...	28.5	32.9	35.7	42.8	52.4	57.4	64.9	72.1	80.5	88.8	102.6
...	13.7	17.2	19.5	23.7	27.9	30.7	33.5	37.7	44.6	48.8	51.6	58.5	67.9	72.9	80.3	87.5	95.8	104.1	117.8
...	...	11.6	15.9	19.3	21.6	25.8	30.0	32.8	35.5	39.7	46.6	50.8	53.6	60.5	69.9	74.8	82.3	89.5	97.7	106.0	119.8
...	27.8	30.7	37.9	47.6	52.6	60.2	67.5	75.8	84.2	98.1
...	32.8	42.6	47.8	55.4	62.7	71.2	79.5	93.4
...	...	11.7	16.0	19.4	21.7	25.9	30.1	32.9	35.7	39.8	46.8	50.9	53.7	60.6	70.0	75.0	82.4	89.6	97.9	106.1	119.9
...	19.6	22.5	26.9	34.0	38.2	41.1	48.1	57.6	62.6	70.1	77.3	85.6	93.9	107.7
...	14.9	19.3	23.7	26.5	29.3	33.5	40.5	44.7	47.5	54.5	63.9	68.9	76.3	83.5	91.8	100.1	113.9
...	21.7	29.0	33.3	36.2	43.3	52.8	57.9	65.4	72.7	81.0	89.3	103.2
...	13.9	17.4	19.7	24.0	28.2	31.0	33.8	37.9	44.9	49.1	51.8	58.7	68.1	73.1	80.6	87.8	96.0	104.3	118.1
...	28.2	31.1	38.4	48.0	53.1	60.7	68.0	76.3	84.7	98.6
...	...	11.8	16.1	19.6	21.8	26.0	30.2	33.0	35.8	40.0	46.9	51.0	53.8	60.7	70.1	75.1	82.5	89.7	98.0	106.3	120.1
...	15.2	19.6	23.9	26.7	29.6	33.8	40.8	45.0	47.8	54.7	64.1	69.1	76.6	83.8	92.1	100.4	114.2
...	14.2	17.7	19.9	24.2	28.4	31.2	34.0	38.2	45.1	49.3	52.1	59.0	68.4	73.4	80.8	88.0	96.3	104.6	118.4
...	20.0	23.0	27.3	34.5	38.7	41.5	48.6	58.1	63.1	70.6	77.8	86.1	94.4	108.2
...	22.1	29.5	33.8	36.7	43.8	53.3	58.4	65.9	73.2	81.5	89.8	103.7
...	24.2	28.7	31.6	38.8	48.5	53.6	61.2	68.5	76.9	85.2	99.1
...	33.7	43.6	48.7	56.4	63.7	72.1	80.5	94.5
...	14.3	17.8	20.1	24.3	28.5	31.3	34.1	38.3	45.3	49.4	52.2	59.1	68.5	73.5	81.0	88.2	96.4	104.7	118.5
.8	.9	.95	1.0	1.05	1.1	.9															

* These belts are not available in RPP construction.

HTS® 14 mm Drive Selection Tables



DN RPM	Drive Ratio	Sprocket Combination				HP Ratings @ 1750 RPM Driver									
		Driver		Driven		RPP™ Belt Widths					RPP™ PLUS Belt Widths				
		No. Teeth	P.D.	No. Teeth	P.D.	40	55	85	115	170	40	55	85	115	170
Multiply hp rating by belt length factor to determine drive width—BELT LENGTH FACTOR →															
551	3.18	68	11.930	216	37.896	55.8	81.5	133.0	184.0	279	101	149.0	244.0	340	515
547	3.20	60	10.527	192	33.686	53.3	77.9	127.0	176.0	266	89.3	131.0	215.0	299	453
544	3.21	28	4.912	90	15.790	22.6	33.0	53.9	74.7	...	38.9	56.9	93.0	129	...
542	3.23	52	9.123	168	29.475	49.4	72.2	118.0	163.0	247	77.1	113.0	185.0	257	389
535	3.27	44	7.720	144	25.264	44.3	64.8	106.0	147.0	222	64.4	94.5	155.0	215	325
531	3.29	34	5.965	112	19.650	33.0	48.2	78.7	109.0	...	48.4	71.0	116.0	161	...
519	3.38	64	11.229	216	37.896	54.7	80.0	130.0	181.0	273	95.3	140.0	230.0	320	484
510	3.43	56	9.825	192	33.686	51.5	75.3	123.0	170.0	258	83.3	122.0	200.0	278	421
500	3.50	32	5.614	112	19.650	29.3	42.9	69.9	97.0	...	45.2	66.3	108.0	150	...
500	3.50	48	8.421	168	29.475	47.0	68.7	112.0	156.0	235	70.8	104.0	170.0	236	357
486	3.60	40	7.018	144	25.264	41.3	60.4	98.6	137.0	207	58.1	85.1	139.0	193	292
486	3.60	60	10.527	216	37.896	53.3	77.9	127.0	176.0	266	89.3	131.0	215.0	299	453
474	3.69	52	9.123	192	33.686	49.4	72.2	118.0	163.0	247	77.1	113.0	185.0	257	389
469	3.73	30	5.263	112	19.650	25.8	37.8	61.6	85.5	...	42.1	61.6	101.0	140	...
462	3.79	38	6.667	144	25.264	39.8	58.1	94.8	132.0	...	54.8	80.4	131.0	182	...
458	3.82	44	7.720	168	29.475	44.3	64.8	106.0	147.0	222	64.4	94.5	155.0	215	325
454	3.86	56	9.825	216	37.896	51.5	75.3	123.0	170.0	258	83.3	122.0	200.0	278	421
453	3.86	29	5.088	112	19.650	24.2	35.4	57.7	80.0	...	40.5	59.2	96.8	134	...
438	4.00	28	4.912	112	19.650	22.6	33.0	53.9	74.7	...	38.9	56.9	93.0	129	...
438	4.00	36	6.316	144	25.264	36.9	53.9	88.0	122.0	...	51.6	75.7	124.0	172	...
438	4.00	48	8.421	192	33.686	47.0	68.7	112.0	156.0	235	70.8	104.0	170.0	236	357
421	4.15	52	9.123	216	37.896	49.4	72.2	118.0	163.0	247	77.1	113.0	185.0	257	389
417	4.20	40	7.018	168	29.475	41.3	60.4	98.6	137.0	207	58.1	85.1	139.0	193	292
413	4.24	34	5.965	144	25.264	33.0	48.2	78.7	109.0	...	48.4	71.0	116.0	161	...
401	4.36	44	7.720	192	33.686	44.3	64.8	106.0	147.0	222	64.4	94.5	155.0	215	325
396	4.42	38	6.667	168	29.475	39.8	58.1	94.8	132.0	...	54.8	80.4	131.0	182	...
389	4.50	32	5.614	144	25.264	29.3	42.9	69.9	97.0	...	45.2	66.3	108.0	150	...
389	4.50	48	8.421	216	37.896	47.0	68.7	112.0	156.0	235	70.8	104.0	170.0	236	357
375	4.67	36	6.316	168	29.475	36.9	53.9	88.0	122.0	...	51.6	75.7	124.0	172	...
365	4.80	30	5.263	144	25.264	25.8	37.8	61.6	85.5	...	42.1	61.6	101.0	140	...
365	4.80	40	7.018	192	33.686	41.3	60.4	98.6	137.0	207	58.1	85.1	139.0	193	292
356	4.91	44	7.720	216	37.896	44.3	64.8	106.0	147.0	222	64.4	94.5	155.0	215	325
354	4.94	34	5.965	168	29.475	33.0	48.2	78.7	109.0	...	48.4	71.0	116.0	161	...
352	4.97	29	5.088	144	25.264	24.2	35.4	57.7	80.0	...	40.5	59.2	96.8	134	...
346	5.05	38	6.667	192	33.686	39.8	58.1	94.8	132.0	...	54.8	80.4	131.0	182	...
340	5.14	28	4.912	144	25.264	22.6	33.0	53.9	74.7	...	38.9	56.9	93.0	129	...
333	5.25	32	5.614	168	29.475	29.3	42.9	69.9	97.0	...	45.2	66.3	108.0	150	...
328	5.33	36	6.316	192	33.686	36.9	53.9	88.0	122.0	...	51.6	75.7	124.0	172	...
324	5.40	40	7.018	216	37.896	41.3	60.4	98.6	137.0	207	58.1	85.1	139.0	193	292
313	5.60	30	5.263	168	29.475	25.8	37.8	61.6	85.5	...	42.1	61.6	101.0	140	...
310	5.65	34	5.965	192	33.686	33.0	48.2	78.7	109.0	...	48.4	71.0	116.0	161	...
308	5.68	38	6.667	216	37.896	39.8	58.1	94.8	132.0	...	54.8	80.4	131.0	182	...
302	5.79	29	5.088	168	29.475	24.2	35.4	57.7	80.0	...	40.5	59.2	96.8	134	...
292	6.00	28	4.912	168	29.475	22.6	33.0	53.9	74.7	...	38.9	56.9	93.0	129	...
292	6.00	32	5.614	192	33.686	29.3	42.9	69.9	97.0	...	45.2	66.3	108.0	150	...
292	6.00	36	6.316	216	37.896	36.9	53.9	88.0	122.0	...	51.6	75.7	124.0	172	...
275	6.35	34	5.965	216	37.896	33.0	48.2	78.7	109.0	...	48.4	71.0	116.0	161	...
273	6.40	30	5.263	192	33.686	25.8	37.8	61.6	85.5	...	42.1	61.6	101.0	140	...
264	6.62	29	5.088	192	33.686	24.2	35.4	57.7	80.0	...	40.5	59.2	96.8	134	...
259	6.75	32	5.614	216	37.896	29.3	42.9	69.9	97.0	...	45.2	66.3	108.0	150	...
255	6.86	28	4.912	192	33.686	22.6	33.0	53.9	74.7	...	38.9	56.9	93.0	129	...
243	7.20	30	5.263	216	37.896	25.8	37.8	61.6	85.5	...	42.1	61.6	101.0	140	...
235	7.45	29	5.088	216	37.896	24.2	35.4	57.7	80.0	...	40.5	59.2	96.8	134	...
227	7.71	28	4.912	216	37.896	22.6	33.0	53.9	74.7	...	38.9	56.9	93.0	129	...
Multiply hp rating by belt length factor to determine drive width—BELT LENGTH FACTOR →															



HTS® 14 mm Drive Selection Tables

NOMINAL CENTER DISTANCES																						
BELT LENGTH CODE DESIGNATION																						
966	1190	1400	1610	1778	1890	2100	2310	2450	2590	2800	3150	3360	3500	3850	4326	4578	4956	5320*	5740*	6160*	6860*	
.8	.9	.95	1.0	1.05	1.1	.9																
...	15.4	19.8	24.1	27.0	29.8	34.0	41.0	45.2	48.0	55.0	64.4	69.4	76.9	84.1	92.3	100.6	114.4	
...	26.7	34.2	44.0	49.2	56.9	64.2	72.6	81.0	95.0	
...	24.6	29.1	32.1	39.3	49.0	54.1	61.7	69.0	77.4	85.7	99.6	
...	14.4	17.9	20.2	24.4	28.7	31.5	34.3	38.5	45.4	49.6	52.3	59.3	68.7	73.6	81.1	88.3	96.6	104.9	118.7	
...	22.5	29.9	34.3	37.1	44.2	53.8	58.9	66.4	73.7	82.0	90.3	104.2	
...	20.5	23.4	27.8	35.0	39.2	42.0	49.1	58.6	63.6	71.1	78.3	86.6	94.9	108.8	
...	15.4	20.0	24.4	27.2	30.0	34.3	41.3	45.5	48.3	55.2	64.7	69.6	77.1	84.3	92.6	100.9	114.7	
...	27.1	34.6	44.5	49.7	57.4	64.7	73.1	81.5	95.5	
...	25.1	29.6	32.5	39.8	49.5	54.6	62.2	69.5	77.9	86.2	100.1	
...	15.8	20.3	24.6	27.5	30.3	34.5	41.5	45.7	48.5	55.5	64.9	69.9	77.4	84.6	92.9	101.2	115.0	
...	23.0	30.4	34.7	37.6	44.7	54.3	59.4	66.9	74.2	82.5	90.9	104.7	
...	17.9	20.9	23.9	28.3	35.4	39.7	42.5	49.5	59.1	64.1	71.6	78.8	87.1	95.4	109.3	
...	24.6	35.1	45.0	50.1	57.8	65.2	73.6	82.0	96.0	
...	25.5	30.0	33.0	40.2	50.0	55.1	62.7	70.0	78.4	86.7	100.6	
...	41.8	46.0	48.8	55.7	65.2	70.2	77.6	84.8	93.1	101.4	115.2	
...	18.1	21.1	24.1	28.5	35.7	39.9	42.8	49.8	59.3	64.3	71.8	79.1	87.4	95.7	109.5	
...	23.4	30.8	35.2	38.1	45.2	54.8	59.9	67.4	74.7	83.0	91.4	105.2	
...	28.0	35.5	45.4	50.6	58.3	65.7	74.1	82.5	96.5	
...	41.9	46.1	48.9	55.9	65.3	70.3	77.8	85.0	93.3	101.6	115.4	
...	13.7	16.2	20.6	24.6	27.8	30.6	34.9	41.9	46.1	48.9	55.9	65.3	70.3	77.8	85.0	93.3	101.6	115.4	
...	13.8	16.3	20.7	25.1	27.9	30.8	35.0	42.0	46.2	49.0	56.0	65.4	70.4	77.9	85.1	93.4	101.7	115.5	
...	18.3	21.4	24.3	28.7	35.9	40.2	43.0	50.0	59.6	64.6	72.1	79.3	87.6	96.0	109.8	
...	26.0	30.5	33.4	40.7	50.4	55.5	63.2	70.5	78.9	87.2	101.1	
...	25.4	28.5	36.0	45.9	51.1	58.8	66.2	74.6	83.0	97.0
...	23.9	31.3	45.7	55.3	60.4	67.9	75.2	83.5	91.9	105.7
...	18.5	21.6	24.6	28.9	36.1	40.4	43.2	50.3	59.8	64.8	72.3	79.6	87.9	96.2	110.1	
...	26.4	30.9	33.9	41.2	50.9	56.0	63.6	70.9	79.3	87.7	101.6	
...	19.5	24.1	31.5	35.9	38.8	45.9	55.5	60.6	68.2	75.4	83.8	92.1	106.0
...	18.8	21.8	24.8	29.2	36.4	40.6	43.5	50.5	60.1	65.1	72.6	79.8	88.2	96.5	110.3	
...	25.8	28.9	36.4	46.4	51.6	59.3	66.6	75.1	83.5	97.5
...	31.8	36.1	39.0	46.2	55.8	60.8	68.4	75.7	84.0	92.4	106.3	
...	19.0	22.0	25.0	29.4	36.6	40.9	43.7	50.8	60.3	65.3	72.9	80.1	88.4	96.7	110.6	
...	26.8	31.4	34.3	41.6	51.4	56.5	64.1	71.4	79.8	88.2	102.1	
...	26.2	29.3	36.9	46.8	52.0	59.7	67.1	75.6	84.0	98.0
...	19.9	24.5	32.0	46.4	51.1	58.7	66.0	74.5	82.9	96.9
...	19.1	22.1	25.1	29.5	36.7	41.0	43.8	50.9	60.4	65.5	73.0	80.2	88.5	96.9	110.7	
...	27.1	31.6	34.5	41.9	51.6	56.7	64.4	71.7	80.1	88.5	102.4	
...	19.2	22.2	25.2	29.6	36.8	41.1	44.0	51.0	60.6	65.6	73.1	80.3	88.7	97.0	110.8	
...	20.1	24.8	32.2	36.6	39.5	46.69	56.3	61.3	68.8	76.2	84.5	92.9	106.8
...	27.3	31.8	34.8	42.1	51.9	57.0	64.6	71.9	80.3	88.7	102.7	
...	26.7	29.8	37.3	47.3	52.5	60.2	67.6	76.1	84.5	98.5
...	20.3	25.0	32.4	36.8	39.7	46.9	56.5	61.6	69.2	76.4	84.8	93.1	107.0	
...	27.5	32.0	35.0	42.3	52.1	57.2	64.9	72.2	80.6	89.0	102.9	
...	26.9	30.0	37.5	47.5	52.7	60.5	67.8	76.3	84.7	98.7
...	20.5	25.1	32.6	47.0	56.6	61.7	69.3	76.5	84.9	98.3
...	32.7	37.0	39.9	47.1	56.7	61.8	69.4	76.7	85.0	93.4	107.3	
...	27.7	32.2	35.2	42.5	52.3	57.5	65.1	72.4	80.8	89.2	103.2	
...	27.1	30.2	37.8	47.8	53.0	60.7	68.1	76.5	85.0	99.0
...	27.3	30.4	38.0	48.0	53.2	60.9	68.3	76.8	85.2	99.2
...
...	27.9	32.5	35.5	42.8	52.6	57.7	65.3	72.7	81.1	89.5	103.4	
...	28.0	32.6	35.6	42.9	52.7	57.8	65.5	72.8	81.2	89.6	103.5	
...	27.5	30.7	38.2	48.2	53.4	61.2	68.6	77.0	85.5	99.5
...	28.2	32.7	35.7	43.0	52.8	57.9	65.6	72.9	81.3	89.7	103.7	
...	23.0	27.8	30.9	38.4	48.4	53.7	61.4	68.8	77.3	85.7	99.7	
...	23.1	27.9	31.0	38.6	48.6	53.8	61.5	68.9	77.4	85.8	99.8	
...	23.2	28.0	31.1	38.7	48.7	53.9	61.6	69.0	77.5	86.0	100.0	
.8	.9	.95	1.0	1.05	1.1	.9																

* These belts are not available in RPP construction.

PULLEYS

HTS® 14 mm Drive Selection Tables



DN RPM	Drive Ratio	Sprocket Combination				HP Ratings @ 1160 RPM Driver									
		Driver		Driven		RPP™ Belt Widths					RPP™ PLUS Belt Widths				
		No. Teeth	P.D.	No. Teeth	P.D.	40	55	85	115	170	40	55	85	115	170
Multiply hp rating by belt length factor to determine drive width—BELT LENGTH FACTOR →															
1160	1.00	28	4.912	28	4.912	18.2	26.7	43.5	60.3	...	28.9	42.3	69.1	95.8	...
1160	1.00	29	5.088	29	5.088	19.6	28.6	46.6	64.7	...	30.1	44.1	72.0	99.8	...
1160	1.00	30	5.263	30	5.263	20.9	30.6	49.9	69.2	...	31.4	45.9	74.9	104.0	...
1160	1.00	32	5.614	32	5.614	23.8	34.8	56.7	78.6	...	33.8	49.4	80.7	112.0	...
1160	1.00	34	5.965	34	5.965	26.8	39.2	63.9	88.7	...	36.3	53.0	86.6	120.0	...
1160	1.00	36	6.316	36	6.316	30.0	43.9	71.6	99.3	...	38.7	56.7	92.5	128.0	...
1160	1.00	38	6.667	38	6.667	32.6	47.6	77.6	108.0	...	41.2	60.3	98.5	137.0	...
1160	1.00	40	7.018	40	7.018	34.1	49.9	81.4	113.0	171	43.7	64.0	105.0	145.0	219
1160	1.00	44	7.720	44	7.720	37.2	54.4	88.8	123.0	186	48.8	71.4	117.0	162.0	245
1160	1.00	48	8.421	48	8.421	40.2	58.8	96.0	133.0	201	53.9	78.9	129.0	179.0	270
1160	1.00	52	9.123	52	9.123	43.2	63.1	103.0	143.0	216	59.0	86.4	141.0	196.0	296
1160	1.00	56	9.825	56	9.825	46.0	67.3	110.0	152.0	230	64.2	94.0	154.0	213.0	322
1160	1.00	60	10.527	60	10.527	48.8	71.3	116.0	161.0	244	69.3	102.0	166.0	230.0	348
1160	1.00	64	11.229	64	11.229	51.4	75.2	123.0	170.0	257	74.5	109.0	178.0	248.0	375
1160	1.00	68	11.930	68	11.930	54.0	78.9	129.0	179.0	270	79.6	117.0	191.0	265.0	401
1160	1.00	72	12.632	72	12.632	56.4	82.5	135.0	187.0	282	84.8	124.0	203.0	282.0	427
1160	1.00	80	14.036	80	14.036	61.0	89.2	145.0	202.0	305	95.0	139.0	228.0	317.0	479
1121	1.03	29	5.088	30	5.263	19.6	28.6	46.6	64.7	...	30.1	44.1	72.0	99.8	...
1120	1.04	28	4.912	29	5.088	18.2	26.7	43.5	60.3	...	28.9	42.3	69.1	95.8	...
1102	1.05	38	6.67	40	7.018	32.6	47.6	77.6	108.0	...	41.2	60.3	98.5	137.0	...
1099	1.06	36	6.316	38	6.667	30.0	43.9	71.6	99.3	...	38.7	56.7	92.5	128.0	...
1096	1.06	34	5.965	36	6.316	26.8	39.2	63.9	88.7	...	36.3	53.0	86.6	120.0	...
1096	1.06	68	11.930	72	12.632	54.0	78.9	129.0	179.0	270	79.6	117.0	191.0	265.0	401
1092	1.06	32	5.614	34	5.965	23.8	34.8	56.7	78.6	...	33.8	49.4	80.7	112.0	...
1092	1.06	64	11.229	68	11.930	51.4	75.2	123.0	170.0	257	74.5	109.0	178.0	248.0	375
1088	1.07	30	5.263	32	5.614	20.9	30.6	49.9	69.2	...	31.4	45.9	74.9	104.0	...
1088	1.07	60	10.527	64	11.229	48.8	71.3	116.0	161.0	244	69.3	102.0	166.0	230.0	348
1083	1.07	28	4.912	30	5.263	18.2	26.7	43.5	60.3	...	28.9	42.3	69.1	95.8	...
1083	1.07	56	9.825	60	10.527	46.0	67.3	110.0	152.0	230	64.2	94.0	154.0	213.0	322
1077	1.08	52	9.123	56	9.825	43.2	63.1	103.0	143.0	216	59.0	86.4	141.0	196.0	296
1071	1.08	48	8.421	52	9.123	40.2	58.8	96.0	133.0	201	53.9	78.9	129.0	179.0	270
1063	1.09	44	7.720	48	8.421	37.2	54.4	88.8	123.0	186	48.8	71.4	117.0	162.0	245
1055	1.10	40	7.018	44	7.720	34.1	49.9	81.4	113.0	171	43.7	64.0	105.0	145.0	219
1051	1.10	29	5.088	32	5.614	19.6	28.6	46.6	64.7	...	30.1	44.1	72.0	99.8	...
1044	1.11	36	6.316	40	7.018	30.0	43.9	71.6	99.3	...	38.7	56.7	92.5	128.0	...
1044	1.11	72	12.632	80	14.036	56.4	82.5	135.0	187.0	282	84.8	124.0	203.0	282.0	427
1038	1.12	34	5.965	38	6.667	26.8	39.2	63.9	88.7	...	36.3	53.0	86.6	120.0	...
1031	1.13	32	5.614	36	6.316	23.8	34.8	56.7	78.6	...	33.8	49.4	80.7	112.0	...
1031	1.13	64	11.229	72	12.632	51.4	75.2	123.0	170.0	257	74.5	109.0	178.0	248.0	375
1031	1.13	80	14.036	90	15.790	61.0	89.2	145.0	202.0	305	95.0	139.0	228.0	317.0	479
1024	1.13	30	5.263	34	5.965	20.9	30.6	49.9	69.2	...	31.4	45.9	74.9	104.0	...
1024	1.13	60	10.527	68	11.930	48.8	71.3	116.0	161.0	244	69.3	102.0	166.0	230.0	348
1015	1.14	28	4.912	32	5.614	18.2	26.7	43.5	60.3	...	28.9	42.3	69.1	95.8	...
1015	1.14	56	9.825	64	11.229	46.0	67.3	110.0	152.0	230	64.2	94.0	154.0	213.0	322
1005	1.15	52	9.123	60	10.527	43.2	63.1	103.0	143.0	216	59.0	86.4	141.0	196.0	296
1002	1.16	38	6.667	44	7.720	32.6	47.6	77.6	108.0	...	41.2	60.3	98.5	137.0	...
994	1.17	48	8.421	56	9.825	40.2	58.8	96.0	133.0	201	53.9	78.9	129.0	179.0	270
989	1.17	29	5.088	34	5.965	19.6	28.6	46.6	64.7	...	30.1	44.1	72.0	99.8	...
986	1.18	34	5.965	40	7.018	26.8	39.2	63.9	88.7	...	36.3	53.0	86.6	120.0	...
986	1.18	68	11.930	80	14.036	54.0	78.9	129.0	179.0	270	79.6	117.0	191.0	265.0	401
Multiply hp rating by belt length factor to determine drive width—BELT LENGTH FACTOR →															



HTS® 14 mm Drive Selection Tables

NOMINAL CENTER DISTANCES																					
BELT LENGTH CODE DESIGNATION																					
966	1190	1400	1610	1778	1890	2100	2310	2450	2590	2800	3150	3360	3500	3850	4326	4578	4956	5320*	5740*	6160*	6860*
.8	.9	.95	1.0	1.05	1.1	.9															
11.3	15.7	19.8	24.0	27.3	29.5	33.6	37.8	40.5	43.3	47.4	54.3	58.4	61.2	68.1	77.4	82.4	89.8	97.0	105.3	113.5	127.3
11.0	15.4	19.6	23.7	27.0	29.2	33.4	37.5	40.2	43.0	47.1	54.0	58.2	60.9	67.8	77.2	82.1	89.6	96.7	105.0	113.3	127.1
10.8	15.2	19.3	23.4	26.7	28.9	33.1	37.2	40.0	42.7	46.9	53.7	57.9	60.6	67.5	76.9	81.9	89.3	96.5	104.7	113.0	126.8
10.2	14.6	18.7	22.9	26.2	28.4	32.5	36.7	39.4	42.2	46.3	53.2	57.3	60.1	67.0	76.3	81.3	88.7	95.9	104.2	112.4	126.2
9.7	14.1	18.2	22.3	25.6	27.8	32.0	36.1	38.9	41.6	45.8	52.6	56.8	59.5	66.4	75.8	80.8	88.2	95.4	103.6	111.9	125.7
9.1	13.5	17.6	21.8	25.1	27.3	31.4	35.6	38.3	41.1	45.2	52.1	56.2	59.0	65.9	75.2	80.2	87.6	94.8	103.1	111.3	125.1
8.5	13.0	17.1	21.2	24.5	26.7	30.9	35.0	37.8	40.5	44.7	51.5	55.7	58.4	65.3	74.7	79.7	87.1	94.3	102.5	110.8	124.6
...	12.4	16.5	20.7	24.0	26.2	30.3	34.5	37.2	40.0	44.1	51.0	55.1	57.9	64.8	74.1	79.1	86.5	93.7	102.0	110.2	124.0
...	11.3	15.4	19.6	22.9	25.1	29.2	33.4	36.1	38.9	43.0	49.9	54.0	56.8	63.7	73.0	78.0	85.4	92.6	100.9	109.1	122.9
...	10.2	14.3	18.5	21.8	24.0	28.1	32.3	35.0	37.8	41.9	48.8	52.9	55.7	62.6	71.9	76.9	84.3	91.5	99.8	108.0	121.8
...	...	13.2	17.4	20.7	22.9	27.0	31.1	33.9	36.7	40.8	47.7	51.8	54.6	61.5	70.8	75.8	83.2	90.4	98.7	106.9	120.7
...	...	12.1	16.3	19.6	21.8	25.9	30.0	32.8	35.6	39.7	46.6	50.7	53.5	60.4	69.7	74.7	82.1	89.3	97.6	105.8	119.6
...	15.2	18.5	20.7	24.8	28.9	31.7	34.5	38.6	45.5	49.6	52.4	59.3	68.6	73.6	81.0	88.2	96.5	104.7	118.5
...	14.1	17.4	19.6	23.7	27.8	30.6	33.4	37.5	44.4	48.5	51.3	58.2	67.5	72.5	79.9	87.1	95.4	103.6	117.4
...	16.3	18.5	22.6	26.7	29.5	32.3	36.4	43.3	47.4	50.2	57.1	66.4	71.4	78.8	86.0	94.3	102.5	116.3
...	15.2	17.4	21.5	25.6	28.4	31.2	35.3	42.2	46.3	49.1	56.0	65.3	70.3	77.7	84.9	93.2	101.4	115.2
...	15.2	19.3	23.4	26.2	28.9	33.1	40.0	44.1	46.9	53.8	63.1	68.1	75.5	82.7	91.0	99.2	113.0
10.9	15.3	19.4	23.6	26.9	29.1	33.2	37.3	40.1	42.9	47.0	53.9	58.0	60.8	67.7	77.0	82.0	89.4	96.6	104.9	113.1	126.9
11.2	15.6	19.7	23.8	27.1	29.4	33.5	37.6	40.4	43.1	47.3	54.2	58.3	61.0	67.9	77.3	82.3	89.7	96.9	105.1	113.4	127.2
8.3	12.7	16.8	20.9	24.3	26.5	30.6	34.7	37.5	40.2	44.4	51.3	55.4	58.2	65.0	74.4	79.4	86.8	94.0	102.2	110.5	124.3
8.8	13.2	17.4	21.5	24.8	27.0	31.1	35.3	38.0	40.8	44.9	51.8	55.9	58.7	65.6	75.0	79.9	87.4	94.5	102.8	111.1	124.8
9.4	13.8	17.9	22.1	25.4	27.6	31.7	35.8	38.6	41.3	45.5	52.4	56.5	59.3	66.1	75.5	80.5	87.9	95.1	103.4	111.6	125.4
...	15.7	17.9	22.1	26.2	28.9	31.7	35.8	42.7	46.9	49.6	56.5	65.9	70.8	78.3	85.4	93.7	102.0	115.8
9.9	14.3	18.5	22.6	25.9	28.1	32.2	36.4	39.1	41.9	46.0	52.9	57.1	59.8	66.7	76.1	81.0	88.5	95.6	103.9	112.2	125.9
...	13.5	16.8	19.0	23.2	27.3	30.0	32.8	36.9	43.8	48.0	50.7	57.6	67.0	71.9	79.4	86.5	94.8	103.1	116.9
10.5	14.9	19.0	23.2	26.5	28.7	32.8	36.9	39.7	42.4	46.6	53.5	57.6	60.4	67.2	76.6	81.6	89.0	96.2	104.5	112.7	126.5
...	14.6	17.9	20.1	24.3	28.4	31.1	33.9	38.0	44.9	49.1	51.8	58.7	68.1	73.0	80.5	87.6	95.9	104.2	118.0
11.0	15.4	19.6	23.7	27.0	29.2	33.3	37.5	40.2	43.0	47.1	54.0	58.2	60.9	67.8	77.2	82.1	89.6	96.7	105.0	113.3	127.1
...	...	11.6	15.7	19.0	21.2	25.4	29.5	32.3	35.0	39.1	46.0	50.2	52.9	59.8	69.2	74.1	81.6	88.7	97.0	105.3	119.1
...	...	12.7	16.8	20.1	22.3	26.5	30.6	33.4	36.1	40.2	47.1	51.3	54.0	60.9	70.3	75.2	82.7	89.8	98.1	106.4	120.2
...	...	13.8	17.9	21.2	23.4	27.6	31.7	34.5	37.2	41.3	48.2	52.4	55.1	62.0	71.4	76.3	83.8	91.0	99.2	107.5	121.3
...	10.7	14.9	19.0	22.3	24.5	28.7	32.8	35.6	38.3	42.4	49.3	53.5	56.2	63.1	72.5	77.4	84.9	92.1	100.3	108.6	122.4
...	11.9	16.0	20.1	23.4	25.6	29.8	33.9	36.7	39.4	43.5	50.4	54.6	57.3	64.2	73.6	78.5	86.0	93.2	101.4	109.7	123.5
10.6	15.0	19.2	23.3	26.6	28.8	32.9	37.1	39.8	42.6	46.7	53.6	57.7	60.5	67.4	76.8	81.7	89.2	96.3	104.6	112.9	126.6
8.5	13.0	17.1	21.2	24.5	26.7	30.9	35.0	37.8	40.5	44.6	51.5	55.7	58.4	65.3	74.7	79.7	87.1	94.3	102.5	110.8	124.6
...	16.3	20.4	24.5	27.3	30.0	34.2	41.1	45.2	48.0	54.8	64.2	69.2	76.6	83.8	92.1	100.3	114.1
9.1	13.5	17.6	21.8	25.1	27.3	31.4	35.6	38.3	41.1	45.2	52.1	56.2	59.0	65.9	75.2	80.2	87.6	94.8	103.1	111.3	125.1
9.6	14.1	18.2	22.3	25.6	27.8	32.0	36.1	38.9	41.6	45.8	52.6	56.8	59.5	66.4	75.8	80.8	88.2	95.4	103.6	111.9	125.7
...	16.3	18.5	22.6	26.7	29.5	32.2	36.4	43.3	47.4	50.2	57.1	66.4	71.4	78.8	86.0	94.3	102.5	116.3
...	17.9	22.0	24.8	27.6	31.7	38.6	42.7	45.5	52.4	61.7	66.7	74.1	81.3	89.6	97.8	111.6
10.2	14.6	18.7	22.9	26.2	28.4	32.5	36.7	39.4	42.2	46.3	53.2	57.3	60.1	67.0	76.3	81.3	88.7	95.9	104.2	112.4	126.2
...	14.0	17.4	19.6	23.7	27.8	30.6	33.3	37.5	44.4	48.5	51.3	58.2	67.5	72.5	79.9	87.1	95.4	103.6	117.4
10.7	15.2	19.3	23.4	26.7	28.9	33.1	37.2	40.0	42.7	46.9	53.7	57.9	60.6	67.5	76.9	81.9	89.3	96.5	104.7	113.0	126.8
...	15.1	18.5	20.7	24.8	28.9	31.7	34.4	38.6	45.5	49.6	52.4	59.3	68.6	73.6	81.0	88.2	96.5	104.7	118.5
...	...	12.1	16.3	19.6	21.8	25.9	30.0	32.8	35.6	39.7	46.6	50.7	53.5	60.4	69.7	74.7	82.1	89.3	97.6	105.8	119.6
...	12.1	16.3	20.4	23.7	25.9	30.0	34.2	36.9	39.7	43.8	50.7	54.8	57.6	64.5	73.9	78.8	86.3	93.4	101.7	110.0	123.7
...	...	13.2	17.4	20.7	22.9	27.0	31.1	33.9	36.7	40.8	47.7	51.8	54.6	61.5	70.8	75.8	83.2	90.4	98.7	106.9	120.7
10.3	14.7	18.9	23.0	26.3	28.5	32.7	36.8	39.5	42.3	46.4	53.3	57.5	60.2	67.1	76.5	81.4	88.9	96.0	104.3	112.6	126.4
8.8	13.2	17.4	21.5	24.8	27.0	31.1	35.3	38.0	40.8	44.9	51.8	55.9	58.7	65.6	75.0	79.9	87.4	94.5	102.8	111.1	124.8
...	14.6	16.8	20.9	25.1	27.8	30.6	34.7	41.6	45.7	48.5	55.4	64.8	69.7	77.2	84.3	92.6	100.9	114.7
.8	.9	.95	1.0	1.05	1.1	.9															

* These belts are not available in RPP construction.

HTS® 14 mm Drive Selection Tables



DN RPM	Drive Ratio	Sprocket Combination				HP Ratings @ 1160 RPM Driver									
		Driver		Driven		RPP™ Belt Widths					RPP™ PLUS Belt Widths				
		No. Teeth	P.D.	No. Teeth	P.D.	40	55	85	115	170	40	55	85	115	170
Multiply hp rating by belt length factor to determine drive width—BELT LENGTH FACTOR →															
982	1.18	44	7.720	52	9.123	37.2	54.4	88.8	123.0	186	48.8	71.4	117.0	162.0	245
977	1.19	32	5.614	38	6.667	23.8	34.8	56.7	78.6	...	33.8	49.4	80.7	112.0	...
967	1.20	30	5.263	36	6.316	20.9	30.6	49.9	69.2	...	31.4	45.9	74.9	104.0	...
967	1.20	40	7.018	48	8.421	34.1	49.9	81.4	113.0	171	43.7	64.0	105.0	145.0	219
967	1.20	60	10.527	72	12.632	48.8	71.3	116.0	161.0	244	69.3	102.0	166.0	230.0	348
955	1.21	28	4.912	34	5.965	18.2	26.7	43.5	60.3	...	28.9	42.3	69.1	95.8	...
955	1.21	56	9.825	68	11.930	46.0	67.3	110.0	152.0	230	64.2	94.0	154.0	216.0	322
949	1.22	36	6.316	44	7.720	30.0	43.9	71.6	99.3	...	38.7	56.7	92.5	128.0	...
943	1.23	52	9.123	64	11.229	43.2	63.1	103.0	143.0	216	59.0	86.4	141.0	196.0	296
934	1.24	29	5.088	36	6.316	19.6	28.6	46.6	64.7	...	30.1	44.1	72.0	99.8	...
928	1.25	32	5.614	40	7.018	23.8	34.8	56.7	78.6	...	33.8	49.4	80.7	112.0	...
928	1.25	48	8.421	60	10.527	40.2	58.8	96.0	133.0	201	53.9	78.9	129.0	179.0	270
928	1.25	64	11.229	80	14.036	51.4	75.2	123.0	170.0	257	74.5	109.0	178.0	248.0	375
928	1.25	72	12.632	90	15.790	56.4	82.5	135.0	187.0	282	84.8	124.0	203.0	282.0	427
918	1.26	38	6.667	48	8.421	32.6	47.6	77.6	108.0	...	41.2	60.3	98.5	137.0	...
916	1.27	30	5.263	38	6.667	20.9	30.6	49.9	69.2	...	31.4	45.9	74.9	104.0	...
911	1.27	44	7.720	56	9.825	37.2	54.4	88.8	123.0	186	48.8	71.4	117.0	162.0	245
902	1.29	28	4.912	36	6.316	18.2	26.7	43.5	60.3	...	28.9	42.3	69.1	95.8	...
902	1.29	56	9.825	72	12.632	46.0	67.3	110.0	152.0	230	64.2	94.0	154.0	213.0	322
896	1.29	34	5.965	44	7.720	26.8	39.2	63.9	88.7	...	36.3	53.0	86.6	120.0	...
892	1.30	40	7.018	52	9.123	34.1	49.9	81.4	113.0	171	43.7	64.0	105.0	145.0	219
887	1.31	52	9.123	68	11.930	43.2	63.1	103.0	143.0	216	59.0	86.4	141.0	196.0	296
885	1.31	29	5.088	38	6.667	19.6	28.6	46.6	64.7	...	30.1	44.1	72.0	99.8	...
876	1.32	68	11.930	90	15.790	54.0	78.9	129.0	179.0	270	79.6	117.0	191.0	265.0	401
870	1.33	30	5.263	40	7.018	20.9	30.6	49.9	69.2	...	31.4	45.9	74.9	104.0	...
870	1.33	36	6.316	48	8.421	30.0	43.9	71.6	99.3	...	38.7	56.7	92.5	128.0	...
870	1.33	48	8.421	64	11.229	40.2	58.8	96.0	133.0	201	53.9	78.9	129.0	179.0	270
870	1.33	60	10.527	80	14.036	48.8	71.3	116.0	161.0	244	69.3	102.0	166.0	230.0	348
855	1.36	28	4.912	38	6.667	18.2	26.7	43.5	60.3	...	28.9	42.3	69.1	95.8	...
851	1.36	44	7.720	60	10.527	37.2	54.4	88.8	123.0	186	48.8	71.4	117.0	162.0	245
848	1.37	38	6.667	52	9.123	32.6	47.6	77.6	108.0	...	41.2	60.3	98.5	137.0	...
844	1.38	32	5.614	44	7.720	23.8	34.8	56.7	78.6	...	33.8	49.4	80.7	112.0	...
841	1.38	29	5.088	40	7.018	19.6	28.6	46.6	64.7	...	30.1	44.1	72.0	99.8	...
838	1.38	52	9.123	72	12.632	43.2	63.1	103.0	143.0	216	59.0	86.4	141.0	196.0	296
829	1.40	40	7.018	56	9.825	34.1	49.9	81.4	113.0	171	43.7	64.0	105.0	145.0	219
829	1.40	80	14.036	112	19.650	61.0	89.2	145.0	202.0	305	95.0	139.0	228.0	317.0	479
825	1.41	64	11.229	90	15.790	51.4	75.2	123.0	170.0	257	74.5	109.0	178.0	248.0	375
822	1.41	34	5.965	48	8.421	26.8	39.2	63.9	88.7	...	36.3	53.0	86.6	120.0	...
819	1.42	48	8.421	68	11.930	40.2	58.8	96.0	133.0	201	53.9	78.9	129.0	179.0	270
812	1.43	28	4.912	40	7.018	18.2	26.7	43.5	60.3	...	28.9	42.3	69.1	95.8	...
812	1.43	56	9.825	80	14.036	46.0	67.3	110.0	152.0	230	64.2	94.0	154.0	213.0	322
803	1.44	36	6.316	52	9.123	30.0	43.9	71.6	99.3	...	38.7	56.7	92.5	128.0	...
798	1.45	44	7.720	64	11.229	37.2	54.4	88.8	123.0	186	48.8	71.4	117.0	162.0	245
791	1.47	30	5.263	44	7.720	20.9	30.6	49.9	69.2	...	31.4	45.9	74.9	104.0	...
787	1.47	38	6.667	56	9.825	32.6	47.6	77.6	108.0	...	41.2	60.3	98.5	137.0	...
773	1.50	32	5.614	48	8.421	23.8	34.8	56.7	78.6	...	33.8	49.4	80.7	112.0	...
773	1.50	40	7.018	60	10.527	34.1	49.9	81.4	113.0	171	43.7	64.0	105.0	145.0	219
773	1.50	48	8.421	72	12.632	40.2	58.8	96.0	133.0	201	53.9	78.9	129.0	179.0	270
773	1.50	60	10.527	90	15.790	48.8	71.3	116.0	161.0	244	69.3	102.0	166.0	230.0	348
Multiply hp rating by belt length factor to determine drive width—BELT LENGTH FACTOR →															



HTS® 14 mm Drive Selection Tables

NOMINAL CENTER DISTANCES																					
BELT LENGTH CODE DESIGNATION																					
966	1190	1400	1610	1778	1890	2100	2310	2450	2590	2800	3150	3360	3500	3850	4326	4578	4956	5320*	5740*	6160*	6860*
.8	.9	.95	1.0	1.05	1.1	.9															
...	10.2	14.3	18.5	21.8	24.0	28.1	32.2	35.0	37.8	41.9	48.8	52.9	55.7	62.6	71.9	76.9	84.3	91.5	99.8	108.0	121.8
9.4	13.8	17.9	22.0	25.4	27.6	31.7	35.8	38.6	41.3	45.5	52.4	56.5	59.3	66.1	75.5	80.5	87.9	95.1	103.3	111.6	125.4
9.9	14.3	18.5	22.6	25.9	28.1	32.2	36.4	39.1	41.9	46.0	52.9	57.0	59.8	66.7	76.1	81.0	88.5	95.6	103.9	112.2	125.9
...	11.3	15.4	19.6	22.9	25.1	29.2	33.3	36.1	38.9	43.0	49.9	54.0	56.8	63.7	73.0	78.0	85.4	92.6	100.9	109.1	122.9
...	13.5	16.8	19.0	23.1	27.3	30.0	32.8	36.9	43.8	47.9	50.7	57.6	67.0	71.9	79.4	86.5	94.8	103.1	116.9
10.5	14.9	19.0	23.1	26.5	28.7	32.8	36.9	39.7	42.4	46.6	53.5	57.6	60.4	67.2	76.6	81.6	89.0	96.2	104.5	112.7	126.5
...	14.6	17.9	20.1	24.2	28.4	31.1	33.9	38.0	44.9	49.1	51.8	58.7	68.1	73.0	80.5	87.6	95.9	104.2	118.0
...	12.4	16.5	20.7	24.0	26.2	30.3	34.4	37.2	40.0	44.1	51.0	55.1	57.9	64.8	74.1	79.1	86.5	93.7	102.0	110.2	124.0
...	...	11.5	15.7	19.0	21.2	25.3	29.5	32.2	35.0	39.1	46.0	50.2	52.9	59.8	69.2	74.1	81.6	88.7	97.0	105.3	119.1
10.0	14.5	18.6	22.7	26.0	28.2	32.4	36.5	39.3	42.0	46.2	53.1	57.2	59.9	66.8	76.2	81.2	88.6	95.8	104.0	112.3	126.1
9.1	13.5	17.6	21.8	25.1	27.3	31.4	35.5	38.3	41.1	45.2	52.1	56.2	59.0	65.9	75.2	80.2	87.6	94.8	103.1	111.3	125.1
...	...	12.6	16.8	20.1	22.3	26.4	30.6	33.3	36.1	40.2	47.1	51.3	54.0	60.9	70.3	75.2	82.7	89.8	98.1	106.4	120.2
...	15.1	17.3	21.5	25.6	28.4	31.1	35.3	42.1	46.3	49.0	55.9	65.3	70.3	77.7	84.9	93.1	101.4	115.2
...	19.0	23.1	25.9	28.6	32.8	39.7	43.8	46.6	53.5	62.8	67.8	75.2	82.4	90.7	98.9	112.7
...	11.5	15.7	19.8	23.1	25.3	29.5	33.6	36.4	39.1	43.3	50.2	54.3	57.0	63.9	73.3	78.3	85.7	92.9	101.1	109.4	123.2
9.6	14.0	18.2	22.3	25.6	27.8	32.0	36.1	38.9	41.6	45.7	52.6	56.8	59.5	66.4	75.8	80.7	88.2	95.4	103.6	111.9	125.7
...	...	13.7	17.9	21.2	23.4	27.5	31.7	34.4	37.2	41.3	48.2	52.4	55.1	62.0	71.4	76.3	83.8	90.9	99.2	107.5	121.3
10.2	14.6	18.7	22.9	26.2	28.4	32.5	36.7	39.4	42.2	46.3	53.2	57.3	60.1	67.0	76.3	81.3	88.7	95.9	104.2	112.4	126.2
...	14.0	17.3	19.5	23.7	27.8	30.6	33.3	37.5	44.4	48.5	51.2	58.1	67.5	72.5	79.9	87.1	95.4	103.6	117.4
8.2	12.6	16.8	20.9	24.2	26.4	30.6	34.7	37.5	40.2	44.4	51.3	55.4	58.1	65.0	74.4	79.4	86.8	94.0	102.2	110.5	124.3
...	10.7	14.8	19.0	22.3	24.5	28.6	32.8	35.5	38.3	42.4	49.3	53.5	56.2	63.1	72.5	77.4	84.9	92.0	100.3	108.6	122.4
...	15.1	18.4	20.6	24.8	28.9	31.7	34.4	38.6	45.5	49.6	52.4	59.2	68.6	73.6	81.0	88.2	96.5	104.7	118.5
9.8	14.2	18.3	22.5	25.8	28.0	32.1	36.2	39.0	41.7	45.9	52.8	56.9	59.7	66.6	75.9	80.9	88.3	95.5	103.8	112.0	125.8
...	19.5	23.6	26.4	29.2	33.3	40.2	44.3	47.1	54.0	63.4	68.3	75.8	82.9	91.2	99.5	113.3
9.3	13.8	17.9	22.0	25.3	27.5	31.7	35.8	38.6	41.3	45.5	52.4	56.5	59.2	66.1	75.5	80.5	87.9	95.1	103.3	111.6	125.4
...	11.8	16.0	20.1	23.4	25.6	29.7	33.9	36.6	39.4	43.5	50.4	54.6	57.3	64.2	73.6	78.5	86.0	93.1	101.4	109.7	123.5
...	...	12.0	16.2	19.5	21.7	25.9	30.0	32.8	35.5	39.7	46.6	50.7	53.5	60.3	69.7	74.7	82.1	89.3	97.6	105.8	119.6
...	15.6	17.8	22.0	26.1	28.9	31.6	35.8	42.7	46.8	49.6	56.5	65.9	70.8	78.3	85.4	93.7	102.0	115.7
9.9	14.3	18.4	22.6	25.9	28.1	32.2	36.4	39.1	41.9	46.0	52.9	57.0	59.8	66.7	76.1	81.0	88.5	95.6	103.9	112.2	125.9
...	...	13.2	17.3	20.6	22.8	27.0	31.1	33.9	36.6	40.8	47.7	51.8	54.6	61.4	70.8	75.8	83.2	90.4	98.7	106.9	120.7
...	11.0	15.1	19.3	22.6	24.8	28.9	33.1	35.8	38.6	42.7	49.6	53.7	56.5	63.4	72.8	77.7	85.2	92.3	100.6	108.9	122.6
8.5	12.9	17.1	21.2	24.5	26.7	30.9	35.0	37.7	40.5	44.6	51.5	55.7	58.4	65.3	74.7	79.6	87.1	94.3	102.5	110.8	124.6
9.5	13.9	18.0	22.2	25.5	27.7	31.8	36.0	38.7	41.5	45.6	52.5	56.6	59.4	66.3	75.6	80.6	88.1	95.2	103.5	111.8	125.5
...	14.5	17.8	20.0	24.2	28.3	31.1	33.9	38.0	44.9	49.0	51.8	58.7	68.1	73.0	80.5	87.6	95.9	104.2	117.9
...	10.1	14.3	18.4	21.7	23.9	28.1	32.2	35.0	37.7	41.9	48.8	52.9	55.7	62.5	71.9	76.9	84.3	91.5	99.8	108.0	121.8
...	18.8	21.6	24.4	28.5	35.4	39.6	42.4	49.3	58.6	63.6	71.1	78.2	86.5	94.8	108.6
...	15.8	20.0	24.1	26.9	29.7	33.8	40.7	44.9	47.6	54.5	63.9	68.9	76.3	83.5	91.8	100.0	113.8
...	12.1	16.2	20.4	23.7	25.9	30.0	34.2	36.9	39.7	43.8	50.7	54.8	57.6	64.5	73.9	78.8	86.3	93.4	101.7	110.0	123.7
...	...	11.4	15.6	18.9	21.1	25.3	29.4	32.2	35.0	39.1	46.0	50.1	52.9	59.8	69.2	74.1	81.6	88.7	97.0	105.3	119.0
9.6	14.0	18.2	22.3	25.6	27.8	32.0	36.1	38.8	41.6	45.7	52.6	56.8	59.5	66.4	75.8	80.7	88.2	95.4	103.6	111.9	125.7
...	16.1	18.3	22.5	26.7	29.4	32.2	36.3	43.2	47.4	50.1	57.0	66.4	71.4	78.8	86.0	94.2	102.5	116.3
...	11.2	15.4	19.5	22.8	25.0	29.2	33.3	36.1	38.8	43.0	49.9	54.0	56.8	63.7	73.0	78.0	85.4	92.6	100.9	109.1	122.9
...	...	12.6	16.7	20.0	22.3	26.4	30.5	33.3	36.1	40.2	47.1	51.2	54.0	60.9	70.3	75.2	82.7	89.8	98.1	106.4	120.2
8.7	13.2	17.3	21.5	24.8	27.0	31.1	35.3	38.0	40.8	44.9	51.8	55.9	58.7	65.6	75.0	79.9	87.4	94.5	102.8	111.1	124.8
...	10.3	14.5	18.7	22.0	24.2	28.3	32.5	35.2	38.0	42.1	49.0	53.2	55.9	62.8	72.2	77.2	84.6	91.8	100.0	108.3	122.1
...	12.3	16.5	20.6	23.9	26.1	30.3	34.4	37.2	39.9	44.1	51.0	55.1	57.9	64.8	74.1	79.1	86.5	93.7	102.0	110.2	124.0
...	...	13.7	17.8	21.1	23.4	27.5	31.6	34.4	37.2	41.3	48.2	52.3	55.1	62.0	71.4	76.3	83.8	90.9	99.2	107.5	121.3
...	15.0	18.3	20.6	24.7	28.9	31.6	34.4	38.5	45.4	49.6	52.3	59.2	68.6	73.6	81.0	88.2	96.4	104.7	118.5
...	16.3	20.5	24.7	27.4	30.2	34.3	41.3	45.4	48.2	55.1	64.4	69.4	76.9	84.0	92.3	100.6	114.3
8.9	13.3	17.5	21.6	24.9	27.1	31.3	35.4	38.1	40.9	45.0	51.9	56.1	58.8	65.7	75.1	80.1	87.5	94.7	102.9	111.2	125.0
.8	.9	.95	1.0	1.05	1.1	.9															

* These belts are not available in RPP construction.

HTS® 14 mm Drive Selection Tables



DN RPM	Drive Ratio	Sprocket Combination				HP Ratings @ 1160 RPM Driver									
		Driver		Driven		RPP™ Belt Widths					RPP™ PLUS Belt Widths				
		No. Teeth	P.D.	No. Teeth	P.D.	40	55	85	115	170	40	55	85	115	170
Multiply hp rating by belt length factor to determine drive width—BELT LENGTH FACTOR →															
758	1.53	34	5.965	52	9.123	26.8	39.2	63.9	88.7	...	36.3	53.0	86.6	120.0	...
754	1.54	52	9.123	80	14.036	43.2	63.1	103.0	143.0	216	59.0	86.4	141.0	196.0	296
751	1.55	44	7.720	68	11.930	37.2	54.4	88.8	123.0	186	48.8	71.4	117.0	162.0	245
746	1.56	36	6.316	56	9.825	30.0	43.9	71.6	99.3	...	38.7	56.7	92.5	128.0	...
746	1.56	72	12.632	112	19.650	56.4	82.5	135.0	187.0	282	84.8	124.0	203	282.0	427
738	1.57	28	4.912	44	7.720	18.2	26.7	43.5	60.3	...	28.9	42.3	69.1	95.8	...
735	1.58	38	6.667	60	10.527	32.6	47.6	77.6	108.0	...	41.2	60.3	98.5	137.0	...
725	1.60	30	5.263	48	8.421	20.9	30.6	49.9	69.2	...	31.4	45.9	74.9	104.0	...
725	1.60	40	7.018	64	11.229	34.1	49.9	81.4	113.0	171	43.7	64.0	105.0	145.0	219
722	1.61	56	9.825	90	15.790	46.0	67.3	110.0	152.0	230	64.2	94.0	154.0	213.0	322
714	1.63	32	5.614	52	9.123	23.8	34.8	56.7	78.6	...	33.8	49.4	80.7	112.0	...
709	1.64	44	7.720	72	12.632	37.2	54.4	88.8	123.0	186	48.8	71.4	117.0	162.0	245
704	1.65	34	5.965	56	9.825	26.8	39.2	63.9	88.7	...	36.3	53.0	86.6	120.0	...
704	1.65	68	11.930	112	19.650	54.0	78.9	129.0	179.0	270	79.6	117.0	191.0	265.0	401
701	1.66	29	5.088	48	8.421	19.6	28.6	46.6	64.7	...	30.1	44.1	72.0	99.8	...
696	1.67	36	6.316	60	10.527	30.0	43.9	71.6	99.3	...	38.7	56.7	92.5	128.0	...
696	1.67	48	8.421	80	14.036	40.2	58.8	96.0	133.0	201	53.9	78.9	129.0	179.0	270
689	1.68	38	6.667	64	11.229	32.6	47.6	77.6	108.0	...	41.2	60.3	98.5	137.0	...
682	1.70	40	7.018	68	11.930	34.1	49.9	81.4	113.0	171	43.7	64.0	105.0	145.0	219
677	1.71	28	4.912	48	8.421	18.2	26.7	43.5	60.3	...	28.9	42.3	69.1	95.8	...
670	1.73	52	9.123	90	15.790	43.2	63.1	103.0	143.0	216	59.0	86.4	141.0	196.0	296
669	1.73	30	5.263	52	9.123	20.9	30.6	49.9	69.2	...	31.4	45.9	74.9	104.0	...
663	1.75	32	5.614	56	9.825	23.8	34.8	56.7	78.6	...	33.8	49.4	80.7	112.0	...
663	1.75	64	11.229	112	19.650	51.4	75.2	123.0	170.0	257	74.5	109.0	178.0	248.0	375
657	1.76	34	5.965	60	10.527	26.8	39.2	63.9	88.7	...	36.3	53.0	86.6	120.0	...
653	1.78	36	6.316	64	11.229	30.0	43.9	71.6	99.3	...	38.7	56.7	92.5	128.0	...
648	1.79	38	6.667	68	11.930	32.6	47.6	77.6	108.0	...	41.2	60.3	98.5	137.0	...
647	1.79	29	5.088	52	9.123	19.6	28.6	46.6	64.7	...	30.1	44.1	72.0	99.8	...
644	1.80	40	7.018	72	12.632	34.1	49.9	81.4	113.0	171	43.7	64.0	105.0	145.0	219
644	1.80	80	14.036	144	25.264	61.0	89.2	145.0	202.0	305	95.0	139.0	228.0	317.0	479
638	1.82	44	7.720	80	14.036	37.2	54.4	88.8	123.0	186	48.8	71.4	117.0	162.0	245
625	1.86	28	4.912	52	9.123	18.2	26.7	43.5	60.3	...	28.9	42.3	69.1	95.8	...
621	1.87	30	5.263	56	9.825	20.9	30.6	49.9	69.2	...	31.4	45.9	74.9	104.0	...
621	1.87	60	10.527	112	19.650	48.8	71.3	116.0	161.0	244	69.3	102.0	166.0	230.0	348
619	1.88	32	5.614	60	10.527	23.8	34.8	56.7	78.6	...	33.8	49.4	80.7	112.0	...
619	1.88	48	8.421	90	15.790	40.2	58.8	96.0	133.0	201	53.9	78.9	129.0	179.0	270
616	1.88	34	5.965	64	11.229	26.8	39.2	63.9	88.7	...	36.3	53.0	86.6	120.0	...
614	1.89	36	6.316	68	11.930	30.0	43.9	71.6	99.3	...	38.7	56.7	92.5	128.0	...
612	1.89	38	6.667	72	12.632	32.6	47.6	77.6	108.0	...	41.2	60.3	98.5	137.0	...
601	1.93	29	5.088	56	9.825	19.6	28.6	46.6	64.7	...	30.1	44.1	72.0	99.8	...
580	2.00	28	4.912	56	9.825	18.2	26.7	43.5	60.3	...	28.9	42.3	69.1	95.8	...
580	2.00	30	5.263	60	10.527	20.9	30.6	49.9	69.2	...	31.4	45.9	74.9	104.0	...
580	2.00	32	5.614	64	11.229	23.8	34.8	56.7	78.6	...	33.8	49.4	80.7	112.0	...
580	2.00	34	5.965	68	11.930	26.8	39.2	63.9	88.7	...	36.3	53.0	86.6	120.0	...
580	2.00	36	6.316	72	12.632	30.0	43.9	71.6	99.3	...	38.7	56.7	92.5	128.0	...
580	2.00	40	7.018	80	14.036	34.1	49.9	81.4	113.0	171	43.7	64.0	105.0	145.0	219
580	2.00	56	9.825	112	19.650	46.0	67.3	110.0	152.0	230	64.2	94.0	154.0	213.0	322
580	2.00	72	12.632	144	25.264	56.4	82.5	135.0	187.0	282	84.8	124.0	203.0	282.0	427
567	2.05	44	7.720	90	15.790	37.2	54.4	88.8	123.0	186	48.8	71.4	117.0	162.0	245
561	2.07	29	5.088	60	10.527	19.6	28.6	46.6	64.7	...	30.1	44.1	72.0	99.8	...
Multiply hp rating by belt length factor to determine drive width—BELT LENGTH FACTOR →															



HTS® 14 mm Drive Selection Tables

NOMINAL CENTER DISTANCES																						
BELT LENGTH CODE DESIGNATION																						
966	1190	1400	1610	1778	1890	2100	2310	2450	2590	2800	3150	3360	3500	3850	4326	4578	4956	5320*	5740*	6160*	6860*	
.8	.9	.95	1.0	1.05	1.1	.9																
...	11.5	15.6	19.8	23.1	25.3	29.4	33.6	36.3	39.1	43.2	50.1	54.3	57.0	63.9	73.3	78.3	85.7	92.9	101.1	109.4	123.2	
...	13.3	16.6	18.9	23.0	27.2	29.9	32.7	36.8	43.8	47.9	50.7	57.6	66.9	71.9	79.3	86.5	94.8	103.0	116.8	
...	...	11.9	16.1	19.5	21.7	25.8	30.0	32.7	35.5	39.6	46.5	50.7	53.4	60.3	69.7	74.7	82.1	89.3	97.5	105.8	119.6	
...	10.6	14.8	18.9	22.3	24.5	28.6	32.8	35.5	38.3	42.4	49.3	53.4	56.2	63.1	72.5	77.4	84.9	92.0	100.3	108.6	122.4	
...	19.8	22.6	25.4	29.6	36.5	40.6	43.4	50.3	59.7	64.7	72.1	79.3	87.6	95.8	109.6	
...	13.4	17.6	21.7	25.0	27.2	31.4	35.5	38.3	41.0	45.2	52.1	56.2	59.0	65.9	75.2	80.2	87.6	94.8	103.1	111.3	125.1	
...	9.7	13.9	18.1	21.4	23.6	27.8	31.9	34.7	37.4	41.6	48.5	52.6	55.4	62.3	71.6	76.6	84.0	91.2	99.5	107.7	121.5	
...	12.6	16.7	20.9	24.2	26.4	30.6	34.7	37.4	40.2	44.3	51.2	55.4	58.1	65.0	74.4	79.4	86.8	94.0	102.2	110.5	124.3	
...	...	13.1	17.2	20.6	22.8	26.9	31.1	33.8	36.6	40.7	47.6	51.8	54.5	61.4	70.8	75.8	83.2	90.4	98.6	106.9	120.7	
...	14.6	16.8	21.0	25.2	27.9	30.7	34.9	41.8	45.9	48.7	55.6	65.0	69.9	77.4	84.6	92.8	101.1	114.9	
...	11.7	15.9	20.0	23.4	25.6	29.7	33.9	36.6	39.4	43.5	50.4	54.5	57.3	64.2	73.6	78.5	86.0	93.1	101.4	109.7	123.5	
...	15.5	18.9	21.1	25.2	29.4	32.2	34.9	39.1	46.0	50.1	52.9	59.8	69.1	74.1	81.5	88.7	97.0	105.3	119.0	
...	10.8	15.0	19.2	22.5	24.7	28.9	33.0	35.8	38.5	42.7	49.6	53.7	56.5	63.4	72.7	77.7	85.1	92.3	100.6	108.8	122.6	
...	20.3	23.1	25.9	30.1	37.0	41.2	43.9	50.8	60.2	65.2	72.7	79.8	88.1	96.4	110.2	
...	12.7	16.9	21.0	24.3	26.5	30.7	34.8	37.6	40.3	44.5	51.4	55.5	58.3	65.2	74.5	79.5	86.9	94.1	102.4	110.6	124.4	
...	10.0	14.2	18.3	21.7	23.9	28.0	32.2	34.9	37.7	41.8	48.7	52.9	55.6	62.5	71.9	76.9	84.3	91.5	99.7	108.0	121.8	
...	13.8	17.1	19.4	23.5	27.7	30.5	33.2	37.4	44.3	48.4	51.2	58.1	67.5	72.4	79.9	87.0	95.3	103.6	117.4	
...	...	13.3	17.5	20.8	23.0	27.2	31.3	34.1	36.9	41.0	47.9	52.0	54.8	61.7	71.1	76.0	83.5	90.6	98.9	107.2	121.0	
...	...	12.4	16.6	20.0	22.2	26.3	30.5	33.3	36.0	40.2	47.1	51.2	54.0	60.9	70.2	75.2	82.6	89.8	98.1	106.4	120.1	
...	12.8	17.0	21.1	24.5	26.7	30.8	35.0	37.7	40.5	44.6	51.5	55.6	58.4	65.3	74.7	79.6	87.1	94.2	102.5	110.8	124.6	
...	15.1	17.3	21.5	25.7	28.5	31.2	35.4	42.3	46.5	49.2	56.1	65.5	70.5	77.9	85.1	93.4	101.6	115.4	
...	12.0	16.1	20.3	23.6	25.8	30.0	34.1	36.9	39.6	43.8	50.7	54.8	57.6	64.5	73.8	78.8	86.2	93.4	101.7	109.9	123.7	
...	11.1	15.3	19.4	22.8	25.0	29.1	33.3	36.0	38.8	42.9	49.8	54.0	56.7	63.6	73.0	78.0	85.4	92.6	100.8	109.1	122.9	
...	20.8	23.6	26.4	30.6	37.5	41.7	44.4	51.4	60.8	65.7	73.2	80.4	88.6	96.9	110.7	
...	10.2	14.4	18.6	21.9	24.1	28.3	32.4	35.2	38.0	42.1	49.0	53.1	55.9	62.8	72.2	77.1	84.6	91.7	100.0	108.3	122.1	
...	...	13.5	17.7	21.1	23.3	27.4	31.6	34.4	37.1	41.3	48.2	52.3	55.1	62.0	71.3	76.3	83.7	90.9	99.2	107.5	121.2	
...	...	12.7	16.9	20.2	22.4	26.6	30.8	33.5	36.3	40.4	47.3	51.5	54.2	61.1	70.5	75.5	82.9	90.1	98.4	106.6	120.4	
...	12.1	16.3	20.4	23.8	26.0	30.1	34.3	37.0	39.8	43.9	50.8	54.9	57.7	64.6	74.0	78.9	86.4	93.5	101.8	110.1	123.9	
...	...	11.8	16.0	19.4	21.6	25.7	29.9	32.7	35.4	39.6	46.5	50.6	53.4	60.3	69.7	74.6	82.1	89.3	97.5	105.8	119.6	
...	23.6	30.6	34.8	37.6	44.6	54.0	59.0	66.5	73.6	81.9	90.2	104.0	
...	14.2	17.6	19.9	24.0	28.2	31.0	33.7	37.9	44.8	49.0	51.7	58.6	68.0	73.0	80.4	87.6	95.9	104.1	117.9	
...	12.2	16.4	20.6	23.9	26.1	30.2	34.4	37.1	39.9	44.0	50.9	55.1	57.8	64.7	74.1	79.1	86.5	93.7	102.0	110.2	124.0	
...	11.3	15.5	19.7	23.0	25.2	29.4	33.5	36.3	39.1	43.2	50.1	54.2	57.0	63.9	73.3	78.2	85.7	92.8	101.1	109.4	123.2	
...	17.0	21.3	24.1	26.9	31.1	38.0	42.2	45.0	51.9	61.3	66.3	73.7	80.9	89.2	97.5	111.2
...	10.4	14.7	18.8	22.2	24.4	28.6	32.7	35.5	38.2	42.4	49.3	53.4	56.2	63.1	72.4	77.4	84.8	92.0	100.3	108.6	122.3	
...	15.5	17.8	22.0	26.2	29.0	31.7	35.9	42.8	47.0	49.7	56.7	66.0	71.0	78.5	85.6	93.9	102.2	116.0	
...	...	13.8	18.0	21.3	23.5	27.7	31.9	34.6	37.4	41.5	48.4	52.6	55.3	62.2	71.6	76.6	84.0	91.2	99.5	107.7	121.5	
...	...	12.9	17.1	20.5	22.7	26.9	31.0	33.8	36.5	40.7	47.6	41.7	54.5	61.4	70.8	75.7	83.2	90.4	98.6	106.9	120.7	
...	...	12.0	16.3	19.6	21.8	26.0	30.2	32.9	35.7	39.8	46.8	50.9	53.7	60.6	69.9	74.9	82.4	89.5	97.8	106.1	119.8	
...	11.5	15.7	19.8	23.2	25.4	29.5	33.7	36.4	39.2	43.3	50.2	54.4	57.1	64.0	73.4	78.4	85.8	93.0	101.3	109.5	123.3	
...	11.6	15.8	20.0	23.3	25.5	29.7	33.8	36.6	39.3	43.5	50.4	54.5	57.3	64.2	73.5	78.5	86.0	93.1	101.4	109.7	123.4	
...	10.7	14.9	19.1	22.4	24.7	28.8	33.0	35.7	38.5	42.6	49.5	53.7	56.4	63.3	72.7	77.7	85.1	92.3	100.6	108.8	122.6	
...	9.8	14.0	18.2	21.6	23.8	28.0	32.1	34.9	37.6	41.8	48.7	52.8	55.6	62.5	71.9	76.8	84.3	91.5	99.7	108.0	121.8	
...	...	13.2	17.4	20.7	22.9	27.1	31.3	34.0	36.8	41.0	47.9	52.0	54.8	61.7	71.0	76.0	83.5	90.6	98.9	107.2	121.0	
...	...	12.3	16.5	19.9	22.1	26.3	30.4	33.2	36.0	40.1	47.0	51.2	53.9	60.8	70.2	75.2	82.6	89.8	98.1	106.3	120.1	
...	14.7	18.1	20.4	24.5	28.7	31.5	34.3	38.4	45.3	49.5	52.2	59.1	68.5	73.5	80.9	88.1	96.4	104.7	118.5	
...	17.5	21.7	24.6	27.4	31.6	38.5	42.7	45.5	52.4	61.8	66.8	74.2	81.4	89.7	98.0	111.8	
...	20.2	24.5	31.6	35.8	38.6	45.6	55.0	60.0	67.5	74.7	83.0	91.3	105.1	
...	16.0	18.3	22.5	26.7	29.5	32.3	36.4	43.3	47.5	50.3	57.2	66.6	71.5	79.0	86.2	94.4	102.7	116.5	
...	10.8	15.0	19.2	22.6	24.8	28.9	33.1	35.9	38.6	42.8	49.7	53.8	56.6	63.5	72.8	77.8	85.3	92.4	100.7	109.0	122.7	
.8	.9	.95	1.0	1.05	1.1	.9																

* These belts are not available in RPP construction.

HTS® 14 mm Drive Selection Tables



DN RPM	Drive Ratio	Sprocket Combination				HP Ratings @ 1160 RPM Driver									
		Driver		Driven		RPP™ Belt Widths					RPP™ PLUS Belt Widths				
		No. Teeth	P.D.	No. Teeth	P.D.	40	55	85	115	170	40	55	85	115	170
Multiply hp rating by belt length factor to determine drive width—BELT LENGTH FACTOR →															
552	2.10	80	14.036	168	29.475	61.0	89.2	145.0	202.0	305	95.0	139.0	228.0	317.0	479
551	2.11	38	6.667	80	14.036	32.6	47.6	77.6	108.0	...	41.2	60.3	98.5	137.0	...
548	2.12	34	5.965	72	12.632	26.8	39.2	63.9	88.7	...	36.3	53.0	86.6	120.0	...
548	2.12	68	11.930	144	25.264	54.0	78.9	129.0	179.0	270	79.6	117.0	191.0	265.0	401
546	2.13	32	5.614	68	11.930	23.8	34.8	56.7	78.6	...	33.8	49.4	80.7	112.0	...
544	2.13	30	5.263	64	11.930	20.9	30.6	49.9	69.2	...	31.4	45.9	74.9	104.0	...
541	2.14	28	4.912	60	10.527	18.2	26.7	43.5	60.3	...	28.9	42.3	69.1	95.8	...
539	2.15	52	9.123	112	19.650	43.2	63.1	103.0	143.0	216	59.0	86.4	141.0	196.0	296
526	2.21	29	5.088	64	11.229	19.6	28.6	46.6	64.7	...	30.1	44.1	72.0	99.8	...
522	2.22	36	6.316	80	14.036	30.0	43.9	71.6	99.3	...	38.7	56.7	92.5	128.0	...
516	2.25	32	5.614	72	12.632	23.8	34.8	56.7	78.6	...	33.8	49.4	80.7	112.0	...
516	2.25	40	7.018	90	15.790	34.1	49.9	81.4	113.0	171	43.7	64.0	105.0	145.0	219
516	2.25	64	11.229	144	25.264	51.4	75.2	123.0	170.0	257	74.5	109.0	178.0	248.0	375
512	2.27	30	5.263	68	11.930	20.9	30.6	49.9	69.2	...	31.4	45.9	74.9	104.0	...
508	2.29	28	4.912	64	11.229	18.2	26.7	43.5	60.3	...	28.9	42.3	69.1	95.8	...
497	2.33	48	8.412	112	19.650	40.2	58.8	96.0	133.0	201	53.9	78.9	129.0	179.0	270
497	2.33	72	12.632	168	29.475	56.4	82.5	135.0	187.0	282	84.8	124.0	203.0	282.0	427
495	2.34	29	5.088	68	11.930	19.6	28.6	46.6	64.7	...	30.1	44.1	72.0	99.8	...
493	2.35	34	5.965	80	14.036	26.8	39.2	63.9	88.7	...	36.3	53.0	86.6	120.0	...
490	2.37	38	6.667	90	15.790	32.6	47.6	77.6	108.0	...	41.2	60.3	98.5	137.0	...
483	2.40	30	5.263	72	12.632	20.9	30.6	49.9	69.2	...	31.4	45.9	74.9	104.0	...
483	2.40	60	10.527	144	25.264	48.8	71.3	116.0	161.0	244	69.3	102.0	166.0	230.0	348
483	2.40	80	14.036	192	33.686	61.0	89.2	145.0	202.0	305	95.0	139.0	228.0	317.0	479
478	2.43	28	4.912	68	11.930	18.2	26.7	43.5	60.3	...	28.9	42.3	69.1	95.8	...
470	2.47	68	11.930	168	29.475	54.0	78.9	129.0	179.0	270	79.6	117.0	191	265.0	401
467	2.48	29	5.088	72	12.632	19.6	28.6	46.6	64.7	...	30.1	44.1	72.0	99.8	...
464	2.50	32	5.614	80	14.036	23.8	34.8	56.7	78.6	...	33.8	49.4	80.7	112.0	...
464	2.50	36	6.316	90	15.790	30.0	43.9	71.6	99.3	...	38.7	56.7	92.5	128.0	...
456	2.55	44	7.720	112	19.650	37.2	54.4	88.8	123.0	186	48.8	71.4	117.0	162.0	245
451	2.57	28	4.912	72	12.632	18.2	26.7	43.5	60.3	...	28.9	42.3	69.1	95.8	...
451	2.57	56	9.825	144	25.264	46.0	67.3	110.0	152.0	230	64.2	94.0	154.0	213.0	322
442	2.63	64	11.229	168	29.475	51.4	75.2	123.0	170.0	257	74.5	109.0	178.0	248.0	375
438	2.65	34	5.965	90	15.790	26.8	39.2	63.9	88.7	...	36.3	53.0	86.6	120.0	...
435	2.67	30	5.263	80	14.036	20.9	30.6	49.9	69.2	...	31.4	45.9	74.9	104.0	...
435	2.67	72	12.632	192	33.686	56.4	82.5	135.0	187.0	282	84.8	124.0	203.0	282.0	427
430	2.70	80	14.036	216	37.896	61.0	89.2	145.0	202.0	305	95.0	139.0	228.0	317.0	479
421	2.76	29	5.088	80	14.036	19.6	28.6	46.6	64.7	...	30.1	44.1	72.0	99.8	...
419	2.77	52	9.123	144	25.264	43.2	63.1	103.0	143.0	216	59.0	86.4	141.0	196.0	296
414	2.80	40	7.018	112	19.650	34.1	49.9	81.4	113.0	171	43.7	64.0	105.0	145.0	219
414	2.80	60	10.527	168	29.475	48.8	71.3	116.0	161.0	244	69.3	102.0	166.0	230.0	348
412	2.81	32	5.614	90	15.790	23.8	34.8	56.7	78.6	...	33.8	49.4	80.7	112.0	...
411	2.82	68	11.930	192	33.686	54.0	78.9	129.0	179.0	270	79.6	117.0	191.0	265.0	401
406	2.86	28	4.912	80	14.036	18.2	26.7	43.5	60.3	...	28.9	42.3	69.1	95.8	...
394	2.95	38	6.667	112	19.650	32.6	47.6	77.6	108.0	...	41.2	60.3	98.5	137.0	...
387	3.00	30	5.263	90	15.790	20.9	30.6	49.9	69.2	...	31.4	45.9	74.9	104.0	...
387	3.00	48	8.421	144	25.264	40.2	58.8	96.0	133.0	201	53.9	78.9	129.0	179.0	270
387	3.00	56	9.825	168	29.475	46.0	67.3	110.0	152.0	230	64.2	94.0	154.0	213.0	322
387	3.00	64	11.229	192	33.686	51.4	75.2	123.0	170.0	257	74.5	109.0	178.0	248.0	375
387	3.00	72	12.632	216	37.896	56.4	82.5	135.0	187.0	282	84.8	124.0	203.0	282.0	427
374	3.10	29	5.088	90	15.790	19.6	28.6	46.6	64.7	...	30.1	44.1	72.0	99.8	...
Multiply hp rating by belt length factor to determine drive width—BELT LENGTH FACTOR →															



HTS® 14 mm Drive Selection Tables

NOMINAL CENTER DISTANCES																					
BELT LENGTH CODE DESIGNATION																					
966	1190	1400	1610	1778	1890	2100	2310	2450	2590	2800	3150	3360	3500	3850	4326	4578	4956	5320*	5740*	6160*	6860*
.8	.9	.95	1.0	1.05	1.1	.9															
...	26.7	31.0	33.8	40.9	50.4	55.4	62.9	70.1	78.4	86.7	100.6
...	15.0	18.4	20.6	24.8	29.0	31.7	34.5	38.7	45.6	49.7	52.5	59.4	68.8	73.8	81.2	88.4	96.7	104.9	118.7
...	...	12.5	16.7	20.1	22.3	26.5	30.7	33.4	36.2	40.4	47.3	51.4	54.2	61.1	70.5	75.4	82.9	90.1	98.3	106.6	120.4
...	20.7	25.0	32.1	36.3	39.1	46.1	55.5	60.5	68.0	75.2	83.5	91.8	105.6
...	...	13.4	17.6	21.0	23.2	27.4	31.5	34.3	37.1	41.2	48.1	52.3	55.0	61.9	71.3	76.3	83.7	90.9	99.2	107.4	121.2
...	...	14.3	18.5	21.8	24.1	28.2	32.4	35.1	37.9	42.1	49.0	53.1	55.9	62.8	72.1	77.1	84.6	91.7	100.0	108.3	122.1
...	...	15.2	19.4	22.7	24.9	29.1	33.2	36.0	38.8	42.9	49.8	53.9	56.7	63.6	73.0	77.9	85.4	92.6	100.8	109.1	122.9
...	17.9	22.2	25.1	27.9	32.1	39.0	43.2	46.0	52.9	62.3	67.3	74.8	82.0	90.2	98.5	112.3
...	...	14.4	18.6	22.0	24.2	28.4	32.5	35.3	38.0	42.2	49.1	53.2	56.0	62.9	72.3	77.2	84.7	91.9	100.1	108.4	122.2
...	15.2	18.6	20.8	25.0	29.2	32.0	34.8	38.9	45.9	50.0	52.8	59.7	69.1	74.0	81.5	88.7	96.9	105.2	119.0
...	...	12.7	17.0	20.4	22.6	26.8	30.9	33.7	36.5	40.6	47.5	51.7	54.5	61.4	70.7	75.7	83.2	90.3	98.6	106.9	120.7
...	13.0	16.5	18.8	23.0	27.2	30.0	32.8	36.9	43.9	48.0	50.8	57.7	67.1	72.1	79.5	86.7	95.0	103.3	117.0
...	21.1	25.5	32.6	36.8	39.6	46.6	56.0	61.0	68.5	75.7	84.0	92.3	106.1
...	...	13.6	17.9	21.2	23.5	27.6	31.8	34.6	37.3	41.5	48.4	52.5	55.3	62.2	71.6	76.5	84.0	91.2	99.4	107.7	121.5
...	...	14.5	18.7	22.1	24.3	28.5	32.6	35.4	38.2	42.3	49.2	53.4	56.1	63.0	72.4	77.4	84.8	92.0	100.3	108.5	122.3
...	18.4	22.7	25.5	28.4	32.6	39.5	43.7	46.5	53.4	62.8	67.8	75.3	82.5	90.8	99.1	112.9
...	27.6	31.9	34.8	41.8	51.4	56.4	63.9	71.1	79.5	87.8	101.6
...	...	13.8	18.0	21.3	23.6	27.8	31.9	34.7	37.5	41.6	48.5	52.7	55.4	62.3	71.7	76.7	84.1	91.3	99.6	107.8	121.6
...	15.4	18.8	21.1	25.3	29.5	32.3	35.0	39.2	46.1	50.3	53.0	59.9	69.3	74.3	81.7	88.9	97.2	105.5	119.3
...	13.3	16.7	19.0	23.2	27.4	30.2	33.0	37.2	44.1	48.3	51.0	58.0	67.4	72.3	79.8	87.0	95.2	103.5	117.3
...	...	13.0	17.2	20.6	22.8	27.0	31.2	34.0	36.7	40.9	47.8	52.0	54.7	61.6	71.0	76.0	83.4	90.6	98.9	107.1	120.9
...	21.6	25.9	33.0	37.3	40.1	47.1	56.5	61.5	69.0	76.2	84.5	92.8	106.7
...	26.8	29.8	37.0	46.6	51.7	59.2	66.5	74.8	83.2	97.0
...	...	13.9	18.1	21.5	23.7	27.9	32.0	34.8	37.6	41.7	48.6	52.8	55.6	62.5	71.8	76.8	84.3	91.4	99.7	108.0	121.8
...	28.1	32.4	35.2	42.3	51.9	56.9	64.4	71.6	80.0	88.3	102.1
...	...	13.1	17.3	20.7	23.0	27.1	31.3	34.1	36.9	41.0	47.9	52.1	54.8	61.8	71.1	76.1	83.6	90.7	99.0	107.3	121.1
...	...	11.3	15.7	19.1	21.3	25.5	29.7	32.5	35.3	39.4	46.4	50.5	53.3	60.2	69.6	74.6	82.0	89.2	97.5	105.7	119.5
...	13.5	17.0	19.2	23.5	27.7	30.5	33.3	37.4	44.4	48.5	51.3	58.2	67.6	72.6	80.1	87.2	95.5	103.8	117.6
...	18.9	23.2	26.0	28.8	33.1	40.0	44.2	47.0	53.9	63.4	68.4	75.8	83.0	91.3	99.6	113.4
...	...	13.2	17.5	20.8	23.1	27.3	31.4	34.2	37.0	41.1	48.1	52.2	55.0	61.9	71.3	76.2	83.7	90.9	99.1	107.4	121.2
...	19.1	22.1	26.4	33.5	37.8	40.6	47.6	57.0	62.1	69.6	76.8	85.1	93.4	107.2
...	28.5	32.9	35.7	42.8	52.4	57.4	64.9	72.1	80.5	88.8	102.6
...	13.7	17.2	19.5	23.7	27.9	30.7	33.5	37.7	44.6	48.8	51.6	58.5	67.9	72.9	80.3	87.5	95.8	104.1	117.8
...	...	11.6	15.9	19.3	21.6	25.8	30.0	32.8	35.5	39.7	46.6	50.8	53.6	60.5	69.9	74.8	82.3	89.5	97.7	106.0	119.8
...	27.8	30.7	37.9	47.6	52.6	60.2	67.5	75.8	84.2	98.1
...	32.8	42.6	47.8	55.4	62.7	71.2	79.5	93.4
...	...	11.7	16.0	19.4	21.7	25.9	30.1	32.9	35.7	39.8	46.8	50.9	53.7	60.6	70.0	75.0	82.4	89.6	97.9	106.1	119.9
...	19.6	22.5	26.9	34.0	38.2	41.1	48.1	57.6	62.6	70.1	77.3	85.6	93.9	107.7
...	14.9	19.3	23.7	26.5	29.3	33.5	40.5	44.7	47.5	54.5	63.9	68.9	76.3	83.5	91.8	100.1	113.9
...	21.7	29.0	33.3	36.2	43.3	52.8	57.9	65.4	72.7	81.0	89.3	103.2
...	13.9	17.4	19.7	24.0	28.2	31.0	33.8	37.9	44.9	49.1	51.8	58.7	68.1	73.1	80.6	87.8	96.0	104.3	118.1
...	28.2	31.1	38.4	48.0	53.1	60.7	68.0	76.3	84.7	98.6
...	...	11.8	16.1	19.6	21.8	26.0	30.2	33.0	35.8	40.0	46.9	51.0	53.8	60.7	70.1	75.1	82.5	89.7	98.0	106.3	120.1
...	15.2	19.6	23.9	26.7	29.6	33.8	40.8	45.0	47.8	54.7	64.1	69.1	76.6	83.8	92.1	100.4	114.2
...	14.2	17.7	19.9	24.2	28.4	31.2	34.0	38.2	45.1	49.3	52.1	59.0	68.4	73.4	80.8	88.0	96.3	104.6	118.4
...	20.0	23.0	27.3	34.5	38.7	41.5	48.6	58.1	63.1	70.6	77.8	86.1	94.4	108.2
...	22.1	29.5	33.8	36.7	43.8	53.3	58.4	65.9	73.2	81.5	89.8	103.7
...	24.2	28.7	31.6	38.8	48.5	53.6	61.2	68.5	76.9	85.2	99.1
...	33.7	43.6	48.7	56.4	63.7	72.1	80.5	94.5
...	14.3	17.8	20.1	24.3	28.5	31.3	34.1	38.3	45.3	49.4	52.2	59.1	68.5	73.5	81.0	88.2	96.4	104.7	118.5
.8	.9	.95	1.0	1.05	1.1	.9															

* These belts are not available in RPP construction.

HTS® 14 mm Drive Selection Tables



DN RPM	Drive Ratio	Sprocket Combination				HP Ratings @ 1160 RPM Driver									
		Driver		Driven		RPP™ Belt Widths					RPP™ PLUS Belt Widths				
		No. Teeth	P.D.	No. Teeth	P.D.	40	55	85	115	170	40	55	85	115	170
Multiply hp rating by belt length factor to determine drive width—BELT LENGTH FACTOR →															
373	3.11	36	6.316	112	19.650	30.0	43.9	71.6	99.3	...	38.7	56.7	92.5	128.0	...
365	3.18	68	11.930	216	37.896	54.0	78.9	129.0	179.0	270	79.6	117.0	191.0	265.0	401
363	3.20	60	10.527	192	33.686	48.8	71.3	116.0	161.0	244	69.3	102.0	166.0	230.0	348
361	3.21	28	4.912	90	15.790	18.2	26.7	43.5	60.3	...	28.9	42.3	69.1	95.8	...
359	3.23	52	9.123	168	29.475	43.2	63.1	103.0	143.0	216	59.0	86.4	141.0	196.0	296
354	3.27	44	7.720	144	25.264	37.2	54.4	88.8	123.0	186	48.8	71.4	117.0	162.0	245
352	3.29	34	5.965	112	19.650	26.8	39.2	63.9	88.7	...	36.3	53.0	86.6	120.0	...
344	3.38	64	11.229	216	37.896	51.4	75.2	123.0	170.0	257	74.5	109.0	178.0	248.0	375
338	3.43	56	9.825	192	33.686	46.0	67.3	110.0	152.0	230	64.2	94.0	154.0	213.0	322
331	3.50	32	5.614	112	19.650	23.8	34.8	56.7	78.6	...	33.8	49.4	80.7	112.0	...
331	3.50	48	8.421	168	37.896	40.2	58.8	96.0	133.0	201	53.9	78.9	129.0	179.0	270
322	3.60	40	7.018	144	33.686	34.1	49.9	81.4	113.0	171	43.7	64.0	105.0	145.0	219
322	3.60	60	10.527	216	19.650	48.8	71.3	116.0	161.0	244	69.3	102.0	166.0	230.0	348
314	3.69	52	9.123	192	29.475	43.2	63.1	103.0	143.0	216	59.0	86.4	141.0	196.0	296
311	3.73	30	5.263	112	25.264	20.9	30.6	49.9	69.2	...	31.4	45.9	74.9	104.0	...
306	3.79	38	6.667	144	37.896	32.6	47.6	77.6	108.0	...	41.2	60.3	98.5	137.0	...
304	3.82	44	7.720	168	33.686	37.2	54.4	88.8	123.0	186	48.8	71.4	117.0	162.0	245
301	3.86	56	9.825	216	19.650	46.0	67.3	110.0	152.0	230	64.2	94.0	154.0	213.0	322
300	3.86	29	5.088	112	25.264	19.6	28.6	46.6	64.7	...	30.1	44.1	72.0	99.8	...
290	4.00	28	4.912	112	29.475	18.2	26.7	43.5	60.3	...	28.9	42.3	69.1	95.8	...
290	4.00	36	6.316	144	37.896	30.0	43.9	71.6	99.3	...	38.7	56.7	92.5	128.0	...
290	4.00	48	8.421	192	19.650	40.2	58.8	96.0	133.0	201	53.9	78.9	129.0	179.0	270
279	4.15	52	9.123	216	19.650	43.2	63.1	103.0	143.0	216	59.0	86.4	141.0	196.0	296
276	4.20	40	7.018	168	25.264	34.1	49.9	81.4	113.0	171	43.7	64.0	105.0	145.0	219
274	4.24	34	5.965	144	33.686	26.8	39.2	63.9	88.7	...	36.3	53.0	86.6	120.0	...
266	4.36	44	7.720	192	37.896	37.2	54.4	88.8	123.0	186	48.8	71.4	117.0	162.0	245
262	4.42	38	6.667	168	29.475	32.6	47.6	77.6	108.0	...	41.2	60.3	98.5	137.0	...
258	4.50	32	5.614	144	25.264	23.8	34.8	56.7	78.6	...	33.8	49.4	80.7	112.0	...
258	4.50	48	8.421	216	33.686	40.2	58.8	96.0	133.0	201	53.9	78.9	129.0	179.0	270
249	4.67	36	6.316	168	29.475	30.0	43.9	71.6	99.3	...	38.7	56.7	92.5	128.0	...
242	4.80	30	5.263	144	25.264	20.9	30.6	49.9	69.2	...	31.4	45.9	74.9	104.0	...
242	4.80	40	7.018	192	37.896	34.1	49.9	81.4	113.0	171	43.7	64.0	105.0	145.0	219
236	4.91	44	7.720	216	29.475	37.2	54.4	88.8	123.0	186	48.8	71.4	117.0	162.0	245
235	4.94	34	5.965	168	25.264	26.8	39.2	63.9	88.7	...	36.3	53.0	86.6	120.0	...
234	4.97	29	5.088	144	33.686	19.6	28.6	46.6	64.7	...	30.1	44.1	72.0	99.8	...
230	5.05	38	6.667	192	37.896	32.6	47.6	77.6	108.0	...	41.2	60.3	98.5	137.0	...
226	5.14	28	4.912	144	29.475	18.2	26.7	43.5	60.3	...	28.9	42.3	69.1	95.8	...
221	5.25	32	5.614	168	25.264	23.8	34.8	56.7	78.6	...	33.8	49.4	80.7	112.0	...
218	5.33	36	6.316	192	33.686	30.0	43.9	71.6	99.3	...	38.7	56.7	92.5	128.0	...
215	5.40	40	7.018	216	25.264	34.1	49.9	81.4	113.0	171	43.7	64.0	105.0	145.0	219
207	5.60	30	5.263	168	29.475	20.9	30.6	49.9	69.2	...	31.4	45.9	74.9	104.0	...
205	5.65	34	5.965	192	33.686	32.6	39.2	63.9	88.7	...	36.3	53.0	86.6	120.0	...
204	5.68	38	6.667	216	37.896	20.9	47.6	77.6	108.0	...	41.2	60.3	98.5	137.0	...
200	5.79	29	5.088	168	29.475	19.6	28.6	46.6	64.7	...	30.1	44.1	72.0	99.8	...
193	6.00	28	4.912	168	33.686	18.2	26.7	43.5	60.3	...	28.9	42.3	69.1	95.8	...
193	6.00	32	5.614	192	37.896	23.8	34.8	56.7	78.6	...	33.8	49.4	80.7	112.0	...
193	6.00	36	6.316	216	29.475	30.0	43.9	71.6	99.3	...	38.7	56.7	92.5	128.0	...
183	6.35	34	5.965	216	29.475	26.8	39.2	63.9	88.7	...	36.3	53.0	86.6	120.0	...
181	6.40	30	5.263	192	33.686	20.9	30.6	49.9	69.2	...	31.4	45.9	74.9	104.0	...
175	6.62	29	5.088	192	37.896	19.6	28.6	46.6	64.7	...	30.1	44.1	72.0	99.8	...
172	6.75	32	5.614	216	37.896	23.8	34.8	56.7	78.6	...	33.8	49.4	80.7	112.0	...
169	6.86	28	4.912	192	33.686	18.2	26.7	43.5	60.3	...	28.9	42.3	69.1	95.8	...
161	7.20	30	5.263	216	33.686	20.9	30.6	49.9	69.2	...	31.4	45.9	74.9	104.0	...
156	7.45	29	5.088	216	37.896	19.6	28.6	46.6	64.7	...	30.1	44.1	72.0	99.8	...
150	7.71	28	4.912	216	33.686	18.2	26.7	43.5	60.3
Multiply hp rating by belt length factor to determine drive width—BELT LENGTH FACTOR →															



HTS® 14 mm Drive Selection Tables

NOMINAL CENTER DISTANCES																						
BELT LENGTH CODE DESIGNATION																						
966	1190	1400	1610	1778	1890	2100	2310	2450	2590	2800	3150	3360	3500	3850	4326	4578	4956	5320*	5740*	6160*	6860*	
.8	.9	.95	1.0	1.05	1.1	.9																
...	15.4	19.8	24.1	27.0	29.8	34.0	41.0	45.2	48.0	55.0	64.4	69.4	76.9	84.1	92.3	100.6	114.4	
...	26.7	34.2	44.0	49.2	56.9	64.2	72.6	81.0	95.0	
...	24.6	29.1	32.1	39.3	49.0	54.1	61.7	69.0	77.4	85.7	99.6	
...	14.4	17.9	20.2	24.4	28.7	31.5	34.3	38.5	45.4	49.6	52.3	59.3	68.7	73.6	81.1	88.3	96.6	104.9	118.7	
...	22.5	29.9	34.3	37.1	44.2	53.8	58.9	66.4	73.7	82.0	90.3	104.2	
...	20.5	23.4	27.8	35.0	39.2	42.0	49.1	58.6	63.6	71.1	78.3	86.6	94.9	108.8	
...	15.4	20.0	24.4	27.2	30.0	34.3	41.3	45.5	48.3	55.2	64.7	69.6	77.1	84.3	92.6	100.9	114.7	
...	27.1	34.6	44.5	49.7	57.4	64.7	73.1	81.5	95.5	
...	25.1	29.6	32.5	39.8	49.5	54.6	62.2	69.5	77.9	86.2	100.1	
...	15.8	20.3	24.6	27.5	30.3	34.5	41.5	45.7	48.5	55.5	64.9	69.9	77.4	84.6	92.9	101.2	115.0	
...	23.0	30.4	34.7	37.6	44.7	54.3	59.4	66.9	74.2	82.5	90.9	104.7	
...	17.9	20.9	23.9	28.3	35.4	39.7	42.5	49.5	59.1	64.1	71.6	78.8	87.1	95.4	109.3	
...	24.6	35.1	45.0	50.1	57.8	65.2	73.6	82.0	96.0	
...	25.5	30.0	33.0	40.2	50.0	55.1	62.7	70.0	78.4	86.7	100.6	
...	41.8	46.0	48.8	55.7	65.2	70.2	77.6	84.8	93.1	101.4	115.2	
...	18.1	21.1	24.1	28.5	35.7	39.9	42.8	49.8	59.3	64.3	71.8	79.1	87.4	95.7	109.5	
...	23.4	30.8	35.2	38.1	45.2	54.8	59.9	67.4	74.7	83.0	91.4	105.2	
...	28.0	35.5	45.4	50.6	58.3	65.7	74.1	82.5	96.5	
...	41.9	46.1	48.9	55.9	65.3	70.3	77.8	85.0	93.3	101.6	115.4	
...	13.7	16.2	20.6	24.6	27.8	30.6	34.9	42.0	46.2	49.0	56.0	65.4	70.4	77.9	85.1	93.4	101.7	115.5
...	18.3	21.4	24.3	28.7	35.9	40.2	43.0	50.0	59.6	64.6	72.1	80.5	88.9	102.8	
...	26.0	30.5	33.4	40.7	50.4	55.5	63.2	70.5	78.9	87.2	101.1	
...	25.4	28.5	36.0	45.9	51.1	58.8	66.2	74.6	83.0	97.0
...	23.9	31.3	41.2	46.3	54.0	61.4	69.8	78.2	91.6	105.0
...	31.3	35.7	38.5	45.7	55.3	60.4	67.9	75.2	83.5	91.9	105.7	
...	18.5	21.6	24.6	28.9	36.1	40.4	43.2	50.3	59.8	64.8	72.3	80.7	89.1	103.0	
...	26.4	30.9	33.9	41.2	50.9	56.0	63.6	70.9	79.3	87.7	101.6	
...	31.5	35.9	38.8	45.9	55.5	60.6	68.2	75.4	83.8	92.1	106.0	
...	18.8	21.8	24.8	29.2	36.4	40.6	43.5	50.5	60.1	65.1	72.6	79.8	88.2	96.5	110.3	
...	25.8	28.9	36.4	46.4	51.6	59.3	66.6	75.1	83.5	97.5
...	31.8	36.1	39.0	46.2	55.8	60.8	68.4	75.7	84.0	92.4	106.3	
...	19.0	22.0	25.0	29.4	36.6	40.9	43.7	50.8	60.3	65.3	72.9	80.1	88.4	96.7	110.6
...	26.8	31.4	34.3	41.6	51.4	56.5	64.1	71.4	79.8	88.2	102.1	
...	26.2	29.3	36.9	46.8	52.0	59.7	67.1	75.6	84.0	98.0
...	19.9	24.5	32.0	36.4	39.2	46.4	56.0	61.1	68.7	82.6
...	32.0	36.4	39.2	46.4	56.0	61.1	68.7	75.9	84.3	92.6	106.5	
...	19.1	22.1	25.1	29.5	36.7	41.0	43.8	50.9	60.4	65.5	73.0	80.2	88.5	96.9	110.7
...	27.1	31.6	34.5	41.9	51.6	56.7	64.4	71.7	80.1	88.5	102.4	
...	36.8	41.1	44.0	51.0	60.6	65.6	73.1	80.3	88.7	97.0	110.8	
...	32.2	36.6	39.5	46.69	56.3	61.3	68.8	76.2	84.5	92.9	106.8	
...	27.3	31.8	34.8	42.1	51.9	57.0	64.6	71.9	80.3	88.7	102.7	
...	26.7	29.8	37.3	47.3	52.5	60.2	67.6	76.1	84.5	98.5
...	20.3	25.0	32.4	36.8	39.7	46.9	56.5	61.6	69.2	76.4	84.8	93.1	107.0	
...	27.5	32.0	35.0	42.3	52.1	57.2	64.9	72.2	80.6	89.0	102.9	
...	26.9	30.0	37.5	47.5	52.7	60.5	67.8	76.3	84.7	98.7
...	32.6	36.9	39.8	47.0	56.6	61.7	69.3	76.5	84.9	93.3	107.2	
...	32.7	37.0	39.9	47.1	56.7	61.8	69.4	76.7	85.0	93.4	107.3	
...	27.7	32.2	35.2	42.5	52.3	57.5	65.1	72.4	80.8	89.2	103.2	
...	27.1	30.2	37.8	47.8	53.0	60.7	68.1	76.5	85.0	99.0
...	27.3	30.4	38.0	48.0	53.2	60.9	68.3	76.8	85.2	99.2
...
...	27.9	32.5	35.5	42.8	52.6	57.7	65.3	72.7	81.1	89.5	103.4	
...	28.0	32.6	35.6	42.9	52.7	57.8	65.5	72.8	81.2	89.6	103.5	
...	27.5	30.7	38.2	48.2	53.4	61.2	68.6	77.0	85.5	99.5
...	28.2	32.7	35.7	43.0	52.8	57.9	65.6	72.9	81.3	89.7	103.7	
...	23.0	27.8	30.9	38.4	48.4	53.7	61.4	68.8	77.3	85.7	99.7	
...	23.1	27.9	31.0	38.6	48.6	53.8	61.5	68.9	77.4	85.8	99.8	
...	23.2	28.0	31.1	38.7	48.7	53.9	61.6	69.0	77.5	86.0	100.0	
.8	.9	.95	1.0	1.05	1.1	.9																

* These belts are not available in RPP construction.

HTS® 20 mm Drive Selection Tables



Drive Ratio	Sprocket Combination				Driven Speeds and Horsepower Ratings											
	Driver		Driven		Driven Speed*	1160 RPM Driver					1750 RPM Driver					
	No. Teeth	P.D.	No. Teeth	P.D.		RPP™ for Belt Widths					RPP™ for Belt Widths					
					115	170	230	290	340	115	170	230	290	340		
Multiply hp rating by belt length factor to determine drive width →																
1.00	34	8.522	34	8.522	1160	245	380	1750	311	486
1.00	36	9.023	36	9.023	1160	257	400	1750	322	504
1.00	38	9.524	38	9.524	1160	269	418	584	1750	333	521	730
1.00	40	10.026	40	10.026	1160	281	437	610	1750	342	536	752
1.00	44	11.028	44	11.028	1160	303	472	659	1750	356	560	787
1.00	48	12.031	48	12.031	1160	323	504	705	902	...	1750	365	576	812	1042	...
1.00	52	13.033	52	13.033	1160	342	534	747	956	...	1750	368	583	824	1059	...
1.00	56	14.036	56	14.036	1160	359	561	785	1006	1190	1750	364	581	823	1059	1256
1.00	60	15.038	60	15.038	1160	373	585	820	1050	1242	1750
1.00	64	16.041	64	16.041	1160	386	605	849	1089	1288	1750
1.00	68	17.043	68	17.043	1160	396	622	874	1121	1327	1750
1.00	72	18.046	72	18.046	1160	404	636	894	1148	1359	1750
1.00	80	20.051	80	20.051	1160	411	651	918	1180	1398	1750
1.00	90	22.557	90	22.557	1160	1750
1.05	38	9.524	40	10.026	1102	269	418	584	1663	333	521	730
1.06	36	9.023	38	9.524	1099	257	400	1658	322	504
1.06	34	8.522	36	9.023	1096	245	380	1653	311	486
1.06	68	17.043	72	18.046	1096	396	622	874	1121	1327	1653
1.06	64	16.041	68	17.043	1092	286	605	849	1089	1288	1647
1.07	60	15.038	64	16.041	1088	373	585	820	1050	1242	1641
1.07	56	14.036	60	15.038	1083	359	561	785	1006	1190	1633	364	581	823	...	1256
1.08	52	13.033	56	14.036	1077	342	534	747	956	...	1625	368	583	824	1059	...
1.08	48	12.031	52	13.033	1071	323	504	705	902	...	1615	365	576	812	1059	...
1.09	44	11.028	48	12.031	1063	303	472	659	1604	356	560	787	1042	...
1.10	40	10.026	44	11.028	1055	281	437	610	1591	342	536	752
1.11	36	9.023	40	10.026	1044	257	400	1575	322	504
1.11	72	18.046	80	20.051	1044	404	636	894	1148	1359	1575
1.12	34	8.522	38	9.524	1038	245	380	1566	311	486
1.13	64	16.041	72	18.046	1031	386	605	849	1089	1288	1556
1.13	80	20.051	90	22.557	1031	411	651	918	1180	1398	1556
1.13	60	15.038	68	17.043	1024	373	585	820	1050	1242	1544
1.14	56	14.036	64	16.041	1015	359	561	785	1006	1190	1531	364	581	823	1059	1256
1.15	52	13.033	60	15.038	1005	342	534	747	956	...	1517	368	583	824	1059	...
1.16	38	9.524	44	11.028	1002	269	418	584	1511	333	521	730
1.17	48	12.031	56	14.036	994	323	504	705	902	...	1500	365	576	812	1042	...
1.18	34	8.522	40	10.026	986	245	380	1488	311	486
1.18	68	17.043	80	20.051	986	396	622	874	1121	1327	1488
1.18	44	11.028	52	13.033	982	303	472	659	1481	356	560	787
1.20	40	10.026	48	12.031	967	281	437	610	1458	342	536	752
1.20	60	15.038	72	18.046	967	373	585	820	1050	1242	1458
1.21	56	14.036	68	17.043	955	359	561	785	1006	1190	1441	364	581	823	1059	1256
1.22	36	9.023	44	11.028	949	257	400	1432	322	504
1.23	52	13.033	64	16.041	943	342	534	747	956	...	1422	368	583	824	1059	...
1.24	90	22.557	112	28.072	932	1406
1.25	48	12.031	60	15.038	928	323	504	705	902	...	1400	365	576	812	1042	...
1.25	64	16.041	80	20.051	928	386	605	849	1089	1288	1400
1.25	72	18.046	90	22.557	928	404	636	894	1148	1359	1400
1.26	38	9.524	48	12.031	918	269	418	584	1385	333	521	730
1.27	44	11.028	56	14.036	911	303	472	659	1375	356	560	787
1.29	56	14.036	72	18.046	902	359	561	785	1006	1190	1361	364	581	823	1059	1256
Multiply hp rating by belt length factor to determine drive width →																

* All 20M RPP drives operating above 1000 RPM may require a sound dampening belt guard to reduce noise emission.



HTS® 20 mm Drive Selection Tables

Drive Ratio	Sprocket Combination				Nominal Center Distance										
	Driver		Driven		Belt Length Code Designation										
	No. Teeth	P.D.	No. Teeth	P.D.	2000	2500	3400	3800	4200	4600	5000	5400	5800	6200	6600
BELT LENGTH FACTOR →					.8	.85	.95	1.0		1.05	.85		.9		
1.00	34	8.522	34	8.522	26.0	35.8	53.6	61.4	69.3	77.2	85.0	92.9	100.8	108.7	116.5
1.00	36	9.023	36	9.023	25.2	35.0	52.8	60.6	68.5	76.4	84.3	92.1	100.0	107.9	115.8
1.00	38	9.524	38	9.524	24.4	34.3	52.0	59.1	67.7	75.6	83.5	91.3	99.2	107.1	115.0
1.00	40	10.026	40	10.026	23.6	33.5	51.2	59.1	66.9	74.8	82.7	90.6	98.4	106.3	114.2
1.00	44	11.028	44	11.028	22.1	31.9	49.6	57.5	65.4	73.2	81.1	89.0	96.9	104.7	112.6
1.00	48	12.031	48	12.031	20.5	30.3	48.0	55.9	63.8	71.7	79.5	87.4	95.3	103.2	111.0
1.00	52	13.033	52	13.033	18.9	28.8	46.5	54.3	62.2	70.1	78.0	85.8	93.7	101.6	109.5
1.00	56	14.036	56	14.036	17.3	27.2	44.9	52.8	60.6	68.5	76.4	84.3	92.1	100.0	107.9
1.00	60	15.038	60	15.038	...	25.6	43.3	51.2	59.1	66.9	74.8	82.7	90.6	98.4	106.3
1.00	64	16.041	64	16.041	...	24.0	41.7	49.6	57.5	65.4	73.2	81.1	89.0	96.9	104.7
1.00	68	17.043	68	17.043	...	22.5	40.2	48.0	55.9	63.8	71.1	79.5	87.4	95.3	103.2
1.00	72	18.046	72	18.046	...	20.9	38.6	46.5	54.3	62.2	70.1	78.0	85.8	93.7	101.6
1.00	80	20.051	80	20.051	35.4	43.3	51.2	59.1	66.9	74.8	82.7	90.6	98.4
1.00	90	22.557	90	22.557	31.5	39.4	47.3	55.1	63.0	70.9	78.8	86.6	94.5
1.05	38	9.524	40	10.026	24.0	33.9	51.6	59.5	67.3	75.2	83.1	91.0	98.8	106.7	114.6
1.06	36	9.023	38	9.524	24.8	34.7	52.4	60.2	68.1	76.0	83.9	91.7	99.6	107.5	115.4
1.06	34	8.522	36	9.023	25.6	35.4	53.2	61.0	68.9	76.8	84.7	92.5	100.4	108.3	116.1
1.06	68	17.043	72	18.046	...	21.7	39.4	47.3	55.1	64.6	70.9	78.8	86.6	94.5	102.4
1.06	64	16.041	68	17.043	...	23.2	41.0	48.8	56.7	66.2	72.5	80.3	88.2	96.1	103.9
1.07	60	15.038	64	16.041	...	24.8	42.5	50.4	58.3	67.7	74.0	81.9	89.8	97.6	105.5
1.07	56	14.036	60	15.038	16.5	26.4	44.1	52.0	59.9	69.3	75.6	83.5	91.3	99.2	107.1
1.08	52	13.033	56	14.036	18.1	28.0	45.7	53.6	61.4	70.9	77.2	85.0	92.9	100.8	108.7
1.08	48	12.031	52	13.033	19.7	29.5	47.3	55.1	63.0	72.4	78.7	86.6	94.5	102.4	110.2
1.09	44	11.028	48	12.031	21.3	31.1	48.8	56.7	64.6	74.0	80.3	88.2	96.1	103.9	111.8
1.10	40	10.026	44	11.028	22.8	32.7	50.4	58.3	66.1	75.6	81.9	89.8	97.6	105.5	113.4
1.11	36	9.023	40	10.026	24.4	34.3	52.0	59.8	67.7	76.6	83.5	91.3	99.2	107.1	115.0
1.11	72	18.046	80	20.051	37.0	44.9	52.8	61.4	68.5	76.4	84.3	92.1	100.0
1.12	34	8.522	38	9.524	25.2	35.0	52.8	60.6	68.5	76.4	84.3	92.1	100.0	107.9	115.8
1.13	64	16.041	72	18.046	...	22.4	40.2	48.0	55.9	64.6	71.7	79.5	87.4	95.3	103.2
1.13	80	20.051	90	22.557	33.5	41.3	49.2	57.5	65.4	73.2	81.1	89.0	96.9
1.13	60	15.038	68	17.043	...	24.0	41.7	49.6	57.5	65.4	73.2	81.1	89.0	96.9	104.7
1.14	56	14.036	64	16.041	...	25.6	43.3	51.2	59.1	66.9	74.8	82.7	90.6	98.4	106.3
1.15	52	13.033	60	15.038	17.3	27.2	44.9	52.8	60.6	68.5	76.4	84.3	92.1	100.0	107.9
1.16	38	9.524	44	11.028	23.2	33.1	50.8	58.7	66.5	74.4	82.3	90.2	98.0	105.9	113.8
1.17	48	12.031	56	14.036	18.9	28.7	46.5	54.3	62.2	70.1	78.0	85.8	93.7	101.6	109.5
1.18	34	8.522	40	10.026	24.8	34.6	52.4	60.2	68.1	76.0	83.9	91.7	99.6	107.5	115.4
1.18	68	17.043	80	20.051	37.8	45.7	53.5	61.4	69.3	77.2	85.0	92.9	100.8
1.18	44	11.028	52	13.033	20.5	30.3	48.0	55.9	63.8	71.7	79.5	87.4	95.3	103.2	111.0
1.20	40	10.026	48	12.031	22.0	31.9	49.6	57.5	65.4	73.2	81.1	89.0	96.9	104.7	112.6
1.20	60	15.038	72	18.046	...	23.2	40.9	48.8	56.7	64.6	72.4	80.3	88.2	96.1	103.9
1.21	56	14.036	68	17.043	...	24.8	42.5	50.4	58.3	66.1	74.0	81.9	89.8	97.6	105.5
1.22	36	9.023	44	11.028	23.6	33.5	51.2	59.1	66.9	74.8	82.7	90.6	98.4	106.3	114.2
1.23	52	13.033	64	16.041	...	26.3	44.1	52.0	59.8	67.7	75.6	83.5	91.3	99.2	107.1
1.24	90	22.557	112	28.072	34.9	42.8	50.7	58.6	66.5	74.4	82.3	90.1
1.25	48	12.031	60	15.038	18.1	27.9	45.7	53.5	61.4	69.3	77.2	85.0	92.9	100.8	108.7
1.25	64	16.041	80	20.051	...	20.8	38.5	46.4	54.3	62.2	70.1	77.9	85.8	93.7	101.6
1.25	72	18.046	90	22.557	35.0	42.9	50.7	58.6	66.5	74.4	82.3	90.1	98.0
1.26	38	9.524	48	12.031	22.4	32.3	50.0	57.9	65.7	73.6	81.5	89.4	97.2	105.1	113.0
1.27	44	11.028	56	14.036	19.6	29.5	47.2	55.1	63.0	70.9	78.7	86.6	94.5	102.4	110.2
1.29	56	14.036	72	18.046	...	23.9	41.7	49.6	57.5	65.3	73.2	81.1	89.0	96.8	104.7
BELT LENGTH FACTOR →					.8	.85	.95	1.0		1.05	.85		.9		

HTS® 20 mm Drive Selection Tables



Drive Ratio	Sprocket Combination				Driven Speeds and Horsepower Ratings											
	Driver		Driven		Driven Speed*	1160 RPM Driver RPP™ for Belt Widths					1750 RPM Driver RPP™ for Belt Widths					
	No. Teeth	P.D.	No. Teeth	P.D.		115	170	230	290	340	115	170	230	290	340	
	Multiply hp rating by belt length factor to determine drive width →															
1.29	34	8.522	44	11.028	896	245	380	1352	311	486
1.30	40	10.026	52	13.033	892	281	437	610	1346	342	536	752
1.31	52	13.033	68	17.043	887	342	534	747	956	...	1338	368	583	824	1059	...
1.32	68	17.043	90	22.557	876	396	622	874	1121	1327	1322
1.33	36	9.023	48	12.031	870	257	400	1313	322	504
1.33	48	12.031	64	16.041	870	323	504	705	902	...	1313	365	576	812	1042	...
1.33	60	15.038	80	20.051	870	373	585	820	1050	1242	1313
1.36	44	11.028	60	15.038	851	303	472	659	1283	356	560	787
1.37	38	9.524	52	13.033	848	269	418	584	1279	333	521	730
1.38	52	13.033	72	18.046	838	342	534	747	956	...	1264	368	583	824	1059	...
1.40	40	10.026	56	14.036	829	281	437	610	1250	342	536	752
1.40	80	20.051	112	28.072	829	411	651	918	1180	1398	1250
1.41	64	16.041	90	22.557	825	386	605	849	1089	1288	1244
1.41	34	8.522	48	12.031	822	245	380	1240	311	486
1.42	48	12.031	68	17.043	819	323	504	705	902	...	1235	365	576	812	1042	...
1.43	56	14.036	80	20.051	812	359	561	785	1006	1190	1225	364	581	823	1059	1256
1.44	36	9.023	52	13.033	803	257	400	1212	322	504
1.45	44	11.028	64	16.041	798	303	472	659	1203	356	560	787
1.47	38	9.524	56	14.036	787	269	418	584	1188	333	521	730
1.50	40	10.026	60	15.038	773	281	437	610	1167	342	536	752
1.50	48	12.031	72	18.046	773	323	504	705	902	...	1167	365	576	812	1042	...
1.50	60	15.038	90	22.557	773	373	585	820	1050	1242	1167
1.53	34	8.522	52	13.033	758	245	380	1144	311	486
1.54	52	13.033	80	20.051	754	342	534	747	956	...	1138	368	583	824	1059	...
1.55	44	11.028	68	17.043	751	303	472	659	1132	356	560	787
1.56	36	9.023	56	14.036	746	257	400	1125	322	504
1.56	72	18.046	112	28.072	746	404	636	894	1148	1359	1125
1.58	38	9.524	60	15.038	735	269	418	584	1108	333	521	730
1.60	40	10.026	64	16.041	725	281	437	610	1094	342	536	752
1.60	90	22.557	144	36.092	725	1094
1.61	56	14.036	90	22.557	722	359	561	785	1006	1190	1089	364	581	823	1059	1256
1.64	44	11.028	72	18.046	709	303	472	659	1069	356	560	787
1.65	34	8.522	56	14.036	704	245	380	1063	311	486
1.65	68	17.043	112	28.072	704	396	622	874	1121	1327	1063
1.67	36	9.023	60	15.038	696	257	400	1050	322	504
1.67	48	12.031	80	20.051	696	323	504	705	902	...	1050	365	576	812	1042	...
1.68	38	9.524	64	16.041	689	269	418	584	1039	333	521	730
1.70	40	10.026	68	17.043	682	281	437	610	1029	342	536	752
1.73	52	13.033	90	22.557	670	342	534	747	956	...	1011	368	583	824	1059	...
1.75	64	16.041	112	28.072	663	386	605	849	1089	1288	1000
1.76	34	9.023	60	15.038	657	245	380	992	311	486
1.78	36	9.023	64	16.041	653	257	400	984	322	504
1.79	38	9.524	68	17.043	648	269	418	584	978	333	521	730
1.80	40	10.026	72	18.046	644	281	437	610	972	342	536	752
1.80	80	20.051	144	36.092	644	411	651	918	1180	1398	972
1.82	44	11.028	80	20.051	638	303	472	659	963	356	560	787
1.87	60	15.038	112	28.072	621	373	585	820	1050	1242	938
1.87	90	22.557	168	42.108	621	938
1.88	48	12.031	90	22.557	619	323	504	705	902	...	933	365	576	812	1042	...
1.88	34	8.522	64	16.041	616	245	380	930	311	486
Multiply hp rating by belt length factor to determine drive width →																

* All 20M RPP drives operating above 1000 RPM may require a sound dampening belt guard to reduce noise emission.



HTS® 20 mm Drive Selection Tables

Drive Ratio	Sprocket Combination				Nominal Center Distance										
	Driver		Driven		Belt Length Code Designation										
	No. Teeth	P.D.	No. Teeth	P.D.	2000	2500	3400	3800	4200	4600	5000	5400	5800	6200	6600
BELT LENGTH FACTOR →					.8	.85	.95	1.0		1.05	.85		.9		
1.29	34	8.522	44	11.028	24.0	33.8	51.6	59.4	67.3	75.2	83.1	90.9	98.8	106.7	114.6
1.30	40	10.026	52	13.033	21.2	31.1	48.8	56.7	64.6	72.4	80.3	88.2	96.1	103.9	111.8
1.31	52	13.033	68	17.043	...	25.5	43.3	51.2	59.0	66.9	74.8	82.7	90.5	98.4	106.3
1.32	68	17.043	90	22.557	35.7	43.6	51.5	59.4	67.3	75.2	83.0	90.9	98.8
1.33	36	9.023	48	12.031	22.8	32.6	50.4	58.3	66.1	74.0	81.9	89.8	97.6	105.5	113.4
1.33	48	12.031	64	16.041	17.2	27.1	44.8	52.7	60.6	68.5	76.4	84.2	92.1	100.0	107.9
1.33	60	15.038	80	20.051	...	21.5	39.3	47.2	55.1	63.0	70.8	78.7	86.6	94.5	102.3
1.36	44	11.028	60	15.038	18.8	28.7	46.4	54.3	62.2	70.1	77.9	85.8	93.7	101.6	109.4
1.37	38	9.824	52	13.033	21.6	31.5	49.2	57.1	64.9	72.8	80.7	88.6	96.4	104.3	112.2
1.38	52	13.033	72	18.046	...	24.7	42.5	50.3	58.2	66.1	74.0	81.9	89.7	97.6	105.5
1.40	40	10.026	56	14.036	20.4	30.3	48.0	55.9	63.8	71.6	79.5	87.4	95.3	103.1	111.0
1.40	80	20.051	112	28.072	28.9	36.8	44.7	52.6	60.5	68.4	76.3	84.2	92.1
1.41	64	16.041	90	22.557	36.5	44.4	52.3	60.2	68.0	75.9	83.8	91.7	99.6
1.41	34	8.522	48	12.031	23.2	33.0	50.8	58.6	66.5	74.4	82.3	90.1	98.0	105.9	113.8
1.42	48	12.031	68	17.043	...	26.3	44.0	51.9	59.8	67.7	75.6	83.4	91.3	99.2	107.1
1.43	56	14.036	80	20.051	...	22.2	40.0	47.9	55.8	63.7	71.6	79.5	87.4	95.2	103.1
1.44	36	9.023	52	13.033	22.0	31.8	49.6	57.5	65.3	73.2	81.1	89.0	96.8	104.7	112.6
1.45	44	11.028	64	16.041	17.9	27.8	45.6	53.5	61.4	69.3	77.1	85.0	92.9	100.8	108.6
1.47	38	9.524	56	14.036	20.7	30.6	48.4	56.3	64.1	72.0	79.9	87.8	95.6	103.5	111.4
1.50	40	10.026	60	15.038	19.5	29.4	47.2	55.1	62.9	70.8	78.7	86.6	94.5	102.3	110.2
1.50	48	12.031	72	18.046	...	25.4	43.2	51.1	59.0	66.9	74.7	82.6	90.5	98.4	106.3
1.50	60	15.038	90	22.557	37.2	45.1	53.0	60.9	68.8	76.7	84.6	92.5	100.3
1.53	34	8.522	52	13.033	22.3	32.2	50.0	57.8	65.7	73.6	81.5	89.3	97.2	105.1	113.0
1.54	52	13.033	80	20.051	...	23.0	40.8	48.7	56.6	64.5	72.4	80.2	88.1	96.0	103.9
1.55	44	11.028	68	17.043	17.0	27.0	44.8	52.7	60.6	68.4	76.3	84.2	92.1	100.0	107.8
1.56	36	9.023	56	14.036	21.1	31.0	48.8	56.6	64.5	72.4	80.3	88.2	96.0	103.9	111.8
1.56	72	18.046	112	28.072	30.3	38.2	46.2	54.1	62.0	69.9	77.8	85.7	93.6
1.58	38	9.524	60	15.038	19.9	29.8	47.6	55.4	63.3	71.2	79.1	87.0	94.8	102.7	110.6
1.60	40	10.026	64	16.041	18.6	28.6	46.4	54.3	62.1	70.0	77.9	85.8	93.7	101.5	109.4
1.60	90	22.557	144	36.092	36.0	44.0	51.9	59.8	67.8	75.7	83.6
1.61	56	14.036	90	22.557	37.9	45.9	53.8	61.7	69.6	77.4	85.3	93.2	101.1
1.64	44	11.028	72	18.046	...	26.1	44.0	51.9	59.7	67.6	75.5	83.4	91.3	99.2	107.0
1.65	34	8.522	56	14.036	21.5	31.4	49.1	57.0	64.9	72.8	80.7	88.5	96.4	104.3	112.2
1.65	68	17.043	112	28.072	31.0	39.0	46.9	54.8	62.7	70.7	78.5	86.4	94.3
1.67	36	9.023	60	15.038	20.2	30.2	47.9	55.8	63.7	71.6	79.5	87.4	95.2	103.1	111.0
1.67	48	12.031	80	20.051	...	23.7	41.5	49.4	57.3	65.2	73.1	81.0	88.9	96.8	104.7
1.68	38	9.524	64	16.401	19.0	28.9	46.7	54.6	62.5	70.4	78.3	86.2	94.0	101.9	109.8
1.70	40	10.026	68	17.043	17.8	27.7	45.5	53.4	61.3	69.2	77.1	85.0	92.9	100.7	108.6
1.73	52	13.033	90	22.557	...	20.7	38.7	46.6	54.5	62.4	70.3	78.2	86.1	94.0	101.9
1.75	64	16.041	112	2.072	31.7	39.7	47.6	55.6	63.5	71.4	79.3	87.2	95.1
1.76	34	9.023	60	15.038	20.6	30.5	48.3	56.2	64.1	72.0	79.9	87.7	95.6	103.5	111.4
1.78	36	9.023	64	16.041	19.4	29.3	47.1	55.0	62.9	70.8	78.7	86.5	94.4	102.3	110.2
1.79	38	9.524	68	17.043	18.1	28.1	45.9	53.8	61.7	69.6	77.5	85.4	93.2	101.1	109.0
1.80	40	10.026	72	18.046	16.8	26.9	44.7	52.6	60.5	68.4	76.3	84.2	92.0	99.9	107.8
1.80	80	20.051	144	36.092	37.7	45.7	53.7	61.7	69.6	77.5	85.4
1.82	44	11.028	80	20.051	...	24.4	42.3	50.2	58.1	66.0	73.9	81.8	89.7	97.5	105.4
1.87	60	15.038	112	28.072	32.4	40.4	48.4	56.3	64.2	72.1	80.0	87.9	95.8
1.87	90	22.557	168	42.108	38.5	46.6	54.6	62.6	70.6	78.5
1.88	48	12.031	90	22.557	...	21.4	39.4	47.3	55.3	63.2	71.1	79.0	86.8	94.7	102.6
1.88	34	8.522	64	16.041	19.7	29.7	47.5	55.4	63.3	71.2	79.0	86.9	94.8	102.7	110.6
BELT LENGTH FACTOR →					.8	.85	.95	1.0		1.05	.85		.9		

PULLEYS

HTS® 20 mm Drive Selection Tables



Drive Ratio	Sprocket Combination				Driven Speeds and Horsepower Ratings											
	Driver		Driven		Driven Speed*	1160 RPM Driver					1750 RPM Driver					
	No. Teeth	P.D.	No. Teeth	P.D.		RPP™ for Belt Widths					RPP™ for Belt Widths					
						115	170	230	290	340	115	170	230	290	340	
Multiply hp rating by belt length factor to determine drive width →																
1.89	36	9.023	68	17.043	614	257	400	926	322	504	
1.89	38	9.524	72	18.046	612	269	418	584	924	333	521	730	...	
2.00	34	8.522	68	17.043	580	245	380	875	311	486	
2.00	36	9.023	72	18.046	580	257	400	875	322	504	
2.00	40	10.026	80	20.051	580	281	437	610	875	342	536	752	...	
2.00	56	14.036	112	28.072	580	359	561	785	1006	1190	875	364	581	823	1059	1256
2.00	72	18.046	144	36.092	580	404	636	894	1148	1359	875
2.05	44	11.028	90	22.557	567	303	472	659	856	356	560	787
2.10	80	20.051	168	42.108	552	411	651	918	1180	1398	833
2.11	38	9.524	80	20.051	551	269	418	584	831	333	521	730
2.12	34	8.522	72	18.046	548	245	380	826	311	486
2.12	68	17.043	144	36.092	548	396	622	874	1121	1327	826
2.13	90	22.557	192	48.123	544	820
2.15	52	13.033	112	28.072	539	342	534	747	956	...	813	368	583	824
2.22	36	9.023	80	20.051	522	257	400	788	322	504	...	1059	...
2.25	40	10.026	90	22.557	516	281	437	610	778	342	536	752
2.25	64	16.041	144	36.092	516	386	605	849	1089	1288	778
2.33	48	12.031	112	28.072	497	323	504	705	902	...	750	365	576	812
2.33	72	18.046	168	42.108	497	404	636	894	1148	1359	750	1042	...
2.35	34	8.522	80	20.051	493	245	380	744	311	486
2.37	38	9.524	90	22.557	490	269	418	584	739	333	521	730
2.40	60	15.038	144	36.092	483	373	585	820	1050	1242	729
2.40	80	20.051	192	48.123	483	411	651	918	1180	1398	729
2.40	90	22.557	216	54.139	483	729
2.47	68	17.043	168	42.108	470	396	622	874	1121	1327	708
2.50	36	9.023	90	22.557	464	257	400	700	322	504
2.55	44	11.028	112	28.072	456	303	472	659	688	356	560	787
2.57	56	14.036	144	36.092	451	359	561	785	1006	1190	681	364	581	823	1059	1256
2.63	64	16.041	168	42.108	442	386	605	849	1089	1288	667
2.65	34	8.522	90	22.557	438	245	380	661	311	486
2.67	72	18.046	192	48.123	435	404	636	894	1148	1359	656
2.70	80	20.051	216	54.139	430	411	651	918	1180	1398	648
2.77	52	13.033	144	36.092	419	342	534	747	956	...	632	368	583	824	1059	...
2.80	40	10.026	112	28.072	414	281	437	610	625	342	536	752
2.80	60	15.038	168	42.108	414	373	585	820	1050	1242	625
2.82	68	17.043	192	48.123	411	396	622	874	1121	1327	620
2.95	38	9.524	112	54.139	394	269	418	584	594	333	521	730
3.00	48	12.031	144	28.072	387	323	504	705	902	...	583	365	576	812	1042	...
3.00	56	14.036	168	54.139	387	359	561	785	1006	1190	583	364	581	823	1059	1256
3.00	64	16.041	192	48.123	387	386	605	849	1089	1288	583
3.00	72	18.046	216	54.139	387	404	636	894	1148	1359	583
3.11	36	9.023	112	28.072	373	257	400	563	322	504
3.18	68	17.043	216	54.139	365	396	622	874	1121	1327	551
3.20	60	15.038	192	48.123	363	373	585	820	1050	1242	547
3.23	52	13.033	168	42.108	359	342	534	747	956	...	542	368	583	824	1059	...
3.27	44	11.028	144	36.092	354	303	472	659	535	356	560	787
3.29	34	8.522	112	28.072	352	245	380	531	311	486
3.38	64	16.041	216	54.139	344	386	605	849	1089	1288	519
3.43	56	14.036	192	48.123	338	359	561	785	1006	1190	510	364	581	823	1059	1256
3.50	48	12.031	168	42.108	331	323	504	705	902	...	500	365	576	812	1042	...
Multiply hp rating by belt length factor to determine drive width →																

* All 20M RPP drives operating above 1000 RPM may require a sound dampening belt guard to reduce noise emission.

PULLEYS



HTS® 20 mm Drive Selection Tables

Drive Ratio	Sprocket Combination				Nominal Center Distance										
	Driver		Driven		Belt Length Code Designation										
	No. Teeth	P.D.	No. Teeth	P.D.	2000	2500	3400	3800	4200	4600	5000	5400	5800	6200	6600
BELT LENGTH FACTOR →					.8	.85	.95	1.0		1.05	.85		.9		
1.89	36	9.023	68	17.043	18.4	28.4	46.3	54.2	62.1	70.0	77.9	85.7	93.6	101.5	109.4
1.89	38	9.524	72	18.046	17.2	27.2	45.1	53.0	60.9	68.8	76.7	84.5	92.4	100.3	108.2
2.00	34	8.522	68	17.043	18.8	28.8	46.6	54.6	62.5	70.3	78.2	86.1	94.0	101.9	109.8
2.00	36	9.023	72	18.046	17.5	27.6	45.4	53.3	61.2	69.1	77.0	84.9	92.8	100.7	108.6
2.00	40	10.026	80	20.051	...	25.1	43.0	50.9	58.8	66.7	74.6	82.5	90.4	98.3	106.2
2.00	56	14.036	112	28.072	33.1	41.1	49.1	57.0	65.0	72.9	80.8	88.7	96.6
2.00	72	18.046	144	36.092	30.9	39.1	47.1	55.1	63.1	71.1	79.0	86.9
2.05	44	11.028	90	22.557	...	22.1	40.1	48.1	56.0	63.9	71.8	79.7	87.6	95.5	103.4
2.10	80	20.051	168	42.108	40.2	48.3	56.4	64.4	72.3	80.3
2.11	38	9.524	80	20.051	...	25.4	43.4	51.3	59.2	67.1	75.0	82.9	90.8	98.7	106.6
2.12	34	8.522	72	18.046	17.8	27.9	45.8	53.7	61.6	69.5	77.4	85.3	93.2	101.1	109.0
2.12	68	17.043	144	36.092	31.6	39.8	47.8	55.8	63.8	71.8	79.7	87.6
2.13	90	22.557	192	48.123	40.9	49.1	57.2	65.2	73.2
2.15	52	13.033	112	28.072	33.8	41.8	49.8	57.8	65.7	73.6	81.5	89.4	97.3
2.22	36	9.023	80	20.051	...	25.8	43.7	51.7	59.6	67.5	75.4	83.3	91.2	99.1	106.9
2.25	40	10.026	90	22.557	...	22.7	40.8	48.8	56.7	64.6	72.6	80.5	88.4	96.2	104.1
2.25	64	16.041	144	36.092	32.3	40.4	48.5	56.5	64.5	72.5	80.4	88.4
2.33	48	12.031	112	28.072	34.5	42.5	50.5	58.5	66.4	74.4	82.3	90.2	98.1
2.33	72	18.046	168	42.108	33.2	41.5	49.7	57.7	65.8	73.8	81.7
2.35	34	8.522	80	20.051	...	26.1	44.1	52.0	59.9	67.9	75.8	83.7	91.5	99.4	107.3
2.37	38	9.524	90	18.046	...	23.1	41.2	49.2	57.1	65.0	72.9	80.8	88.7	96.6	104.5
2.40	60	15.038	144	36.092	32.9	41.1	49.2	57.3	65.2	73.2	81.2	89.1
2.40	80	20.051	192	48.123	42.5	50.7	58.9	67.0	75.0
2.40	90	22.557	216	28.072	43.1	51.4	59.6	67.8
2.47	68	17.043	168	20.051	33.9	42.2	50.3	58.4	66.5	74.5	82.5
2.50	36	9.023	90	22.557	...	23.4	41.5	49.5	57.5	65.4	73.3	81.2	89.1	97.0	104.9
2.55	44	11.028	112	36.092	35.1	43.2	51.2	59.2	67.1	75.1	83.0	90.9	98.8
2.57	56	14.036	144	28.072	33.6	41.8	49.9	58.0	66.0	73.9	81.9	89.8
2.63	64	16.041	168	42.108	34.5	42.9	51.0	59.1	67.2	75.2	83.2
2.65	34	8.522	90	20.051	...	23.7	41.9	49.9	57.8	65.7	73.7	81.6	89.5	97.4	105.3
2.67	72	18.046	192	22.557	35.4	43.8	52.1	60.3	68.3	76.4
2.70	80	20.051	216	36.092	44.8	53.1	61.3	69.5
2.77	52	13.033	144	28.072	34.2	42.5	50.6	58.7	66.7	74.7	82.6	90.6
2.80	40	10.026	112	42.108	35.8	43.9	51.9	59.9	67.9	75.8	83.7	91.7	99.6
2.80	60	15.038	168	20.051	35.2	43.5	51.7	59.8	67.9	75.9	83.9
2.82	68	17.043	192	22.557	36.1	44.5	52.8	60.9	69.0	77.1
2.95	38	9.524	112	36.092	36.2	44.3	52.3	60.3	68.2	76.2	84.1	92.0	99.9
3.00	48	12.031	144	48.123	26.4	34.9	43.1	51.3	59.3	67.4	75.4	83.3	91.3
3.00	56	14.036	168	54.139	35.8	44.2	52.4	60.5	68.6	76.6	84.6
3.00	64	16.041	192	42.108	36.7	45.1	53.4	61.6	69.7	77.8
3.00	72	18.046	216	22.557	46.1	54.4	62.7	70.8
3.11	36	9.023	112	28.072	36.5	44.6	52.6	60.6	68.6	76.5	84.5	92.4	100.3
3.18	68	17.043	216	36.092	38.1	46.7	55.1	63.3	71.5
3.20	60	15.038	192	42.108	37.3	45.8	54.1	62.3	70.4	78.5
3.23	52	13.033	168	22.557	36.5	44.8	53.1	61.2	69.3	77.3	85.3
3.27	44	11.028	144	48.123	27.1	35.6	43.8	52.0	60.0	68.1	76.1	84.1	92.0
3.29	34	8.522	112	54.139	36.8	44.9	53.0	61.0	69.0	76.9	84.8	92.8	100.7
3.38	64	16.041	216	36.092	38.8	47.3	55.7	64.0	72.2
3.43	56	14.036	192	28.072	38.0	46.4	54.8	63.0	71.1	79.2
3.50	48	12.031	168	42.108	37.1	45.5	53.7	61.9	70.0	78.0	86.0
BELT LENGTH FACTOR →					.8	.85	.95	1.0		1.05	.85		.9		

PULLEYS

HTS® 20 mm Drive Selection Tables



Drive Ratio	Sprocket Combination				Driven Speeds and Horsepower Ratings											
	Driver		Driven		Driven Speed*	1160 RPM Driver					1750 RPM Driver					
	No. Teeth	P.D.	No. Teeth	P.D.		RPP™ for Belt Widths					RPP™ for Belt Widths					
						115	170	230	290	340	115	170	230	290	340	
Multiply hp rating by belt length factor to determine drive width →																
3.60	40	10.026	144	36.092	322	281	437	610	486	342	536	752
3.60	60	15.038	216	54.139	322	373	585	820	1050	1242	486
3.69	52	13.033	192	48.123	314	342	534	747	956	...	474	368	583	824	1059	...
3.79	38	9.524	144	36.092	306	269	418	584	462	333	521	730
3.82	44	11.028	168	42.108	304	303	472	659	458	356	560	787
3.86	56	14.036	216	54.139	301	359	561	785	1006	1190	454	364	581	823	1059	1256
4.00	36	9.023	144	36.092	290	257	400	438	322	504
4.00	48	12.031	192	48.123	290	323	504	705	902	...	438	365	576	812	1042	...
4.15	52	13.033	216	54.139	279	342	534	747	956	...	421	368	583	824	1059	...
4.20	40	10.026	168	42.108	276	281	437	610	417	342	536	752
4.24	34	8.522	144	36.092	274	245	380	413	311	486
4.36	44	11.028	192	48.123	266	303	472	659	401	356	560	787
4.42	38	9.524	168	42.108	262	269	418	584	396	333	521	730
4.50	48	12.031	216	54.139	258	323	504	705	902	...	389	365	576	812	1042	...
4.67	36	9.023	168	42.108	249	257	400	375	322	504
4.80	40	10.026	192	48.123	242	281	437	610	365	342	536	752
4.91	44	11.028	216	54.139	236	303	472	659	356	356	560	787
4.94	34	8.522	168	42.108	235	245	380	354	311	486
5.05	38	9.524	192	48.123	230	269	418	584	346	333	521	730
5.33	36	9.023	192	48.123	218	257	400	328	322	504
5.40	40	10.026	216	54.139	215	281	437	610	324	342	536	752
5.65	34	8.522	192	48.123	205	245	380	310	311	486
5.68	38	9.524	216	54.139	204	269	418	584	308	333	521	730
6.00	36	9.023	216	54.139	193	257	400	292	322	504
6.35	34	8.522	216	54.139	183	245	380	275	311	486
Multiply hp rating by belt length factor to determine drive width →																

* All 20M RPP drives operating above 1000 RPM may require a sound dampening belt guard to reduce noise emission.



HTS® 20 mm Drive Selection Tables

Drive	Sprocket Combination				Nominal Center Distance										
	Driver		Driven		Belt Length Code Designation										
	Ratio	No. Teeth	P.D.	No. Teeth	P.D.	2000	2500	3400	3800	4200	4600	5000	5400	5800	6200
BELT LENGTH FACTOR →					.8	.85	.95	1.0		1.05	.85		.9		
3.60	40	10.026	144	36.092	27.7	36.2	44.5	52.6	60.7	68.8	76.8	84.8	92.7
3.60	60	15.038	216	54.139	39.4	48.0	56.4	64.7	72.9
3.69	52	13.033	192	48.123	38.6	47.1	55.4	63.6	71.8	79.9
3.79	38	9.524	144	36.092	28.0	36.5	44.8	53.0	61.1	69.1	77.1	85.1	93.1
3.82	44	11.028	168	42.108	29.1	37.8	46.1	54.4	62.6	70.6	78.7	86.7
3.86	56	14.036	216	54.139	40.0	48.6	57.0	65.3	73.5
4.00	36	9.023	144	36.092	28.3	36.9	45.1	53.3	61.4	69.5	77.5	85.5	93.4
4.00	48	12.031	192	48.123	39.2	47.7	56.1	64.3	72.5	80.6
4.15	52	13.033	216	54.139	40.7	49.3	57.7	66.0	74.2
4.20	40	10.026	168	42.108	29.7	38.4	46.8	55.1	63.2	71.3	79.4	87.4
4.24	34	8.522	144	36.092	28.7	37.2	45.5	53.7	61.8	69.8	77.8	85.8	93.8
4.36	44	11.028	192	48.123	39.9	48.4	56.7	65.0	73.1	81.2
4.42	38	9.524	168	42.108	30.1	38.7	47.1	55.4	63.6	71.7	79.7	87.8
4.50	48	12.031	216	54.139	41.3	49.9	58.3	66.7	74.9
4.67	36	9.023	168	42.108	30.4	39.0	47.5	55.7	63.9	72.0	80.1	88.1
4.80	40	10.026	192	48.123	31.7	40.5	49.0	57.4	65.6	73.8	81.9
4.91	44	11.028	216	54.139	41.9	50.6	59.0	67.3	75.6
4.94	34	8.522	168	4.108	30.7	39.4	47.8	56.1	64.2	72.4	80.4	88.5
5.05	38	9.524	192	48.123	32.0	40.8	49.4	57.7	66.0	74.2	82.3
5.33	36	9.023	192	48.123	32.3	41.1	49.7	58.0	66.3	74.5	82.6
5.40	40	10.026	216	54.139	42.5	51.2	59.6	68.0	76.2
5.65	34	8.522	192	48.123	32.6	41.4	50.0	58.4	66.6	74.8	83.0
5.68	38	9.524	216	54.139	33.9	42.9	51.5	60.0	68.3	76.6
6.00	36	9.023	216	54.139	34.2	43.2	51.8	60.3	68.6	76.9
6.35	34	8.522	216	54.139	34.5	43.5	52.1	60.6	69.0	77.2
BELT LENGTH FACTOR →					.8	.85	.95	1.0		1.05	.85		.9		

5 mm RPP® Belt Horsepower Ratings



The following tables represent the horsepower ratings for each belt at the pre-determined No. of Teeth, Pitch Diameters and rpm's. These ratings must be multiplied by the applicable belt length factor to obtain corrected HP rating.

		15mm (.59 in.) wide belt (5M-15)																		
No. of Teeth	PD	14	16	18	20	24	28	32	34	36	38	40	44	48	52	56	60	64	68	72
		mm in.	22.30 .878	25.48 1.003	28.65 1.128	31.84 1.253	38.21 1.504	44.58 1.755	50.93 2.005	54.11 2.130	57.30 2.256	60.48 2.381	63.66 2.506	70.03 2.757	76.39 3.008	82.76 3.258	89.13 3.509	95.49 3.760	101.86 4.010	108.23 4.261
Smallest Sprocket RPM	1160	0.47	0.55	0.63	0.72	0.89	1.07	1.26	1.35	1.45	1.54	1.64	1.84	2.04	2.25	2.45	2.66	2.88	3.09	3.31
	1460	0.55	0.64	0.74	0.84	1.05	1.26	1.48	1.59	1.70	1.81	1.93	2.16	2.39	2.63	2.87	3.11	3.36	3.61	3.86
	1750	0.62	0.73	0.84	0.95	1.19	1.43	1.67	1.80	1.92	2.05	2.18	2.44	2.70	2.97	3.24	3.52	3.79	4.07	4.35
	2900	0.88	1.04	1.19	1.35	1.68	2.01	2.35	2.53	2.70	2.87	3.05	3.40	3.76	4.11	4.47	4.82	5.18	5.53	5.87
	3500	1.01	1.18	1.36	1.54	1.90	2.28	2.66	2.85	3.04	3.24	3.43	3.82	4.20	4.58	4.96	5.34	5.70	6.06	6.42
	10	0.01	0.01	0.01	0.01	0.01	0.02	0.02	0.02	0.02	0.02	0.03	0.03	0.03	0.03	0.04	0.04	0.04	0.05	0.05
	20	0.01	0.02	0.02	0.02	0.03	0.03	0.04	0.04	0.04	0.05	0.05	0.06	0.06	0.07	0.07	0.08	0.09	0.09	0.10
	40	0.03	0.03	0.04	0.04	0.05	0.06	0.08	0.08	0.09	0.09	0.10	0.11	0.13	0.14	0.15	0.16	0.17	0.18	0.19
	60	0.04	0.05	0.06	0.06	0.08	0.10	0.11	0.12	0.13	0.14	0.15	0.17	0.19	0.21	0.22	0.24	0.26	0.27	0.29
	100	0.08	0.10	0.11	0.13	0.13	0.16	0.19	0.20	0.22	0.23	0.25	0.28	0.32	0.35	0.37	0.40	0.43	0.45	0.48
	200	0.14	0.16	0.18	0.21	0.26	0.31	0.37	0.40	0.42	0.45	0.48	0.54	0.60	0.66	0.72	0.78	0.85	0.91	0.96
	300	0.18	0.21	0.25	0.28	0.35	0.42	0.49	0.53	0.56	0.60	0.64	0.72	0.80	0.88	0.96	1.04	1.12	1.21	1.29
	400	0.22	0.26	0.30	0.34	0.42	0.51	0.60	0.64	0.69	0.74	0.78	0.88	0.97	1.07	1.17	1.27	1.37	1.48	1.58
	500	0.26	0.30	0.35	0.40	0.50	0.60	0.70	0.75	0.81	0.86	0.91	1.02	1.14	1.25	1.37	1.49	1.61	1.73	1.85
	600	0.29	0.35	0.40	0.45	0.56	0.68	0.79	0.85	0.91	0.98	1.04	1.16	1.29	1.42	1.55	1.69	1.82	1.96	2.10
	800	0.36	0.42	0.49	0.55	0.69	0.83	0.97	1.04	1.12	1.19	1.27	1.42	1.58	1.74	1.90	2.06	2.23	2.39	2.56
	1000	0.42	0.49	0.57	0.65	0.80	0.97	1.13	1.22	1.31	1.39	1.48	1.66	1.84	2.03	2.21	2.40	2.60	2.79	2.99
	1600	0.58	0.69	0.79	0.90	1.11	1.34	1.57	1.69	1.81	1.93	2.05	2.30	2.55	2.80	3.05	3.31	3.57	3.84	4.10
2000	0.68	0.80	0.92	1.05	1.30	1.56	1.83	1.97	2.11	2.25	2.39	2.67	2.96	3.25	3.54	3.84	4.13	4.43	4.73	
2500	0.80	0.94	1.08	1.22	1.52	1.82	2.13	2.29	2.45	2.61	2.77	3.09	3.42	3.75	4.08	4.42	4.75	5.08	5.41	
4000	1.10	1.29	1.48	1.68	2.08	2.48	2.89	3.10	3.30	3.51	3.71	4.12	4.52	4.91	5.30	5.68	6.04	6.39	6.73	
6000	1.45	1.69	1.93	2.18	2.67	3.15	3.62	3.85	4.08	4.29	4.51	4.90	5.27	5.59	5.88	6.11	6.28	
8000	1.74	2.01	2.29	2.56	3.09	3.58	4.02	4.22	4.40	4.57	4.71	4.93	5.06	
10000	1.97	2.27	2.56	2.83	3.33	3.74	4.04	4.14	4.20	4.22	
12000	2.16	2.46	2.73	2.98	3.37	3.59	3.61	
		25mm (.98 in.) wide belt (5M-25)																		
Smallest Sprocket RPM	1160	0.84	0.99	1.14	1.29	1.61	1.93	2.27	2.44	2.61	2.79	2.96	3.32	3.68	4.05	4.42	4.80	5.18	5.57	5.96
	1460	0.99	1.16	1.34	1.52	1.89	2.27	2.66	2.86	3.06	3.27	3.47	3.89	4.31	4.74	5.18	5.62	6.06	6.51	6.96
	1750	1.12	1.32	1.52	1.72	2.14	2.57	3.01	3.24	3.47	3.70	3.93	4.40	4.88	5.36	5.85	6.34	6.83	7.33	7.84
	2900	1.59	1.87	2.15	2.44	3.03	3.63	4.24	4.55	4.87	5.18	5.50	6.14	6.78	7.42	8.06	8.70	9.33	9.97	10.59
	3500	1.82	2.13	2.45	2.77	3.43	4.11	4.80	5.14	5.49	5.84	6.19	6.88	7.58	8.27	8.95	9.62	10.29	10.94	11.57
	10	0.01	0.02	0.02	0.02	0.02	0.03	0.03	0.04	0.04	0.04	0.05	0.05	0.06	0.06	0.07	0.07	0.08	0.08	0.09
	20	0.03	0.03	0.03	0.04	0.05	0.06	0.07	0.07	0.08	0.08	0.09	0.10	0.11	0.13	0.14	0.14	0.15	0.16	0.17
	40	0.05	0.06	0.07	0.08	0.10	0.12	0.14	0.15	0.16	0.17	0.18	0.20	0.23	0.25	0.27	0.29	0.31	0.33	0.35
	60	0.08	0.09	0.10	0.12	0.14	0.17	0.20	0.22	0.24	0.25	0.27	0.31	0.34	0.38	0.41	0.43	0.46	0.49	0.52
	100	0.15	0.18	0.20	0.23	0.24	0.29	0.34	0.37	0.39	0.42	0.45	0.51	0.57	0.63	0.68	0.72	0.77	0.82	0.87
	200	0.25	0.29	0.33	0.38	0.47	0.57	0.66	0.71	0.76	0.82	0.87	0.97	1.08	1.19	1.30	1.41	1.53	1.64	1.74
	300	0.33	0.38	0.44	0.50	0.62	0.75	0.88	0.95	1.02	1.08	1.15	1.29	1.43	1.58	1.73	1.87	2.03	2.18	2.33
	400	0.40	0.47	0.54	0.61	0.76	0.92	1.08	1.16	1.24	1.33	1.41	1.58	1.75	1.93	2.11	2.29	2.48	2.66	2.85
	500	0.47	0.55	0.63	0.72	0.89	1.07	1.26	1.36	1.45	1.55	1.65	1.85	2.05	2.26	2.47	2.68	2.89	3.11	3.33
	600	0.53	0.62	0.72	0.81	1.01	1.22	1.43	1.54	1.65	1.76	1.87	2.10	2.33	2.56	2.80	3.04	3.29	3.53	3.78
	800	0.65	0.76	0.88	1.00	1.24	1.49	1.75	1.88	2.02	2.15	2.29	2.56	2.85	3.13	3.42	3.72	4.01	4.31	4.62
	1000	0.76	0.89	1.03	1.16	1.45	1.74	2.05	2.20	2.36	2.51	2.67	2.99	3.32	3.66	3.99	4.34	4.68	5.03	5.39
	1600	1.05	1.24	1.42	1.62	2.01	2.42	2.83	3.05	3.26	3.48	3.70	4.14	4.59	5.04	5.51	5.97	6.44	6.92	7.39
2000	1.23	1.45	1.66	1.89	2.35	2.82	3.30	3.55	3.80	4.05	4.30	4.81	5.33	5.86	6.39	6.92	7.45	7.99	8.53	
2500	1.44	1.69	1.94	2.20	2.73	3.28	3.84	4.13	4.41	4.70	4.99	5.58	6.17	6.77	7.36	7.96	8.56	9.16	9.76	
4000	1.99	2.33	2.68	3.03	3.75	4.48	5.21	5.58	5.95	6.32	6.69	7.42	8.15	8.86	9.56	10.23	10.89	11.52	12.13	
6000	2.61	3.04	3.48	3.93	4.81	5.68	6.53	6.95	7.35	7.74	8.12	8.84	9.50	10.09	10.59	11.01	11.33	
8000	3.13	3.63	4.13	4.62	5.57	6.46	7.25	7.61	7.94	8.23	8.49	8.89	9.12	
10000	3.56	4.10	4.62	5.11	6.01	6.74	7.28	7.46	7.57	7.61	
12000	3.89	4.43	4.93	5.38	6.08	6.48	6.50	

Drives falling within the shaded area may be considered noisy and require a sound dampening guard to reduce noise emission.



8 mm RPP® Belt Horsepower Ratings

The following tables represent the horsepower ratings for each belt at the pre-determined No. of Teeth, Pitch Diameters and rpm's. These ratings must be multiplied by the applicable belt length factor to obtain corrected HP rating.

		20mm (.79 in.) wide belt (8M-20)																
No. of Teeth	PD	22	24	26	28	30	32	34	36	38	40	44	48	56	64	72	80	
		mm in.	56.02 2.206	61.12 2.406	66.21 2.607	71.30 2.807	76.39 3.008	81.49 3.208	86.58 3.409	91.67 3.609	96.77 3.810	101.86 4.010	112.05 4.411	122.23 4.812	142.60 5.614	162.97 6.416	183.35 7.218	203.72 8.020
Smallest Sprocket RPM	1160	2.65	2.89	3.13	3.73	4.07	4.68	5.35	6.87	7.22	7.56	8.25	8.92	10.23	11.48	12.67	13.80	
	1460	3.33	3.63	3.93	4.69	5.10	5.74	6.55	8.41	8.83	9.26	10.09	10.90	12.48	13.98	15.40	16.74	
	1750	3.99	4.35	4.71	5.61	6.10	6.72	7.67	9.85	10.34	10.84	11.80	12.75	14.56	16.28	17.89	19.39	
	2900	6.57	7.15	7.73	9.22	10.01	10.81	11.82	13.19	13.81	14.43	15.62	16.75	18.85	20.70	22.29	23.59	
	3500	7.89	8.59	9.28	11.05	11.99	12.94	13.91	15.50	16.22	16.92	18.25	19.51	21.78	23.67	
	10	0.02	0.03	0.03	0.04	0.04	0.05	0.06	0.06	0.07	0.08	0.09	0.09	0.11	0.12	0.14	0.16	
	20	0.05	0.05	0.06	0.07	0.09	0.10	0.11	0.13	0.15	0.16	0.17	0.19	0.22	0.25	0.28	0.31	
	40	0.09	0.10	0.12	0.15	0.17	0.20	0.23	0.26	0.30	0.31	0.34	0.37	0.44	0.50	0.56	0.62	
	60	0.14	0.15	0.19	0.22	0.26	0.30	0.34	0.39	0.44	0.47	0.51	0.56	0.65	0.75	0.84	0.94	
	100	0.23	0.26	0.31	0.37	0.43	0.50	0.57	0.64	0.74	0.78	0.86	0.94	1.09	1.25	1.40	1.56	
	200	0.46	0.51	0.61	0.72	0.84	0.97	1.10	1.29	1.48	1.56	1.71	1.86	2.14	2.41	2.67	2.93	
	300	0.69	0.75	0.88	1.04	1.21	1.39	1.59	1.93	2.15	2.26	2.47	2.68	3.08	3.47	3.85	4.21	
	400	0.91	1.00	1.14	1.34	1.57	1.81	2.06	2.58	2.79	2.93	3.20	3.47	3.99	4.49	4.97	5.44	
	500	1.14	1.25	1.39	1.64	1.92	2.21	2.52	3.22	3.41	3.58	3.91	4.23	4.86	5.48	6.07	6.64	
	600	1.37	1.50	1.64	1.94	2.26	2.60	2.97	3.82	4.02	4.21	4.60	4.98	5.72	6.44	7.13	7.79	
	800	1.83	1.99	2.16	2.58	2.92	3.37	3.84	4.94	5.19	5.44	5.94	6.43	7.38	8.30	9.18	10.03	
	1000	2.28	2.49	2.70	3.22	3.56	4.11	4.69	6.02	6.33	6.64	7.24	7.83	8.98	10.09	11.15	12.16	
	1200	2.74	2.99	3.24	3.86	4.19	4.83	5.51	7.07	7.44	7.79	8.50	9.19	10.53	11.82	13.04	14.20	
	1400	3.19	3.48	3.77	4.50	4.86	5.53	6.31	8.10	8.51	8.92	9.73	10.51	12.04	13.49	14.86	16.16	
	1600	3.65	3.98	4.31	5.13	5.58	6.22	7.09	9.11	9.57	10.03	10.92	11.80	13.49	15.10	16.62	18.04	
	2000	4.55	4.96	5.37	6.40	6.96	7.55	8.61	11.06	11.61	12.16	13.23	14.28	16.29	18.17	19.92	21.54	
	2500	5.68	6.18	6.69	7.97	8.66	9.36	10.43	11.55	12.11	12.66	13.73	14.75	16.67	18.41	19.95	21.28	
	4000	8.98	9.77	10.54	12.55	13.60	14.67	15.75	17.30	18.07	18.82	20.25	21.57	23.86	
	6000	12.48	13.50	14.49	15.45	16.37	17.26	18.10	18.91	19.67	24.72	
	8000	14.24	15.26	16.21	17.09	17.88	
			30mm (1.18 in.) wide belt (8M-30)															
	Smallest Sprocket RPM	1160	4.21	4.59	4.97	5.93	6.46	7.45	8.50	10.92	11.47	12.03	13.12	14.19	16.26	18.25	20.14	21.95
		1460	5.30	5.77	6.25	7.46	8.10	9.12	10.41	13.36	14.04	14.72	16.04	17.34	19.84	22.22	24.48	26.61
1750		6.34	6.91	7.48	8.92	9.70	10.69	12.20	15.66	16.45	17.23	18.77	20.27	23.15	25.88	28.44	30.84	
2900		10.44	11.37	12.30	14.66	15.91	17.19	18.80	20.97	21.96	22.94	24.83	26.64	29.98	32.92	35.44	37.51	
3500		12.55	13.66	14.75	17.58	19.06	20.57	22.11	24.64	25.78	26.89	29.02	31.03	34.62	
10		0.04	0.04	0.05	0.06	0.07	0.08	0.09	0.10	0.12	0.12	0.14	0.15	0.17	0.20	0.22	0.25	
20		0.07	0.08	0.10	0.12	0.14	0.16	0.18	0.21	0.24	0.25	0.27	0.30	0.35	0.40	0.45	0.50	
40		0.15	0.16	0.20	0.23	0.27	0.32	0.36	0.41	0.47	0.50	0.55	0.59	0.69	0.79	0.89	0.99	
60		0.22	0.24	0.29	0.35	0.41	0.47	0.54	0.62	0.71	0.74	0.82	0.89	1.04	1.19	1.34	1.49	
100		0.36	0.41	0.49	0.58	0.68	0.79	0.90	1.03	1.18	1.24	1.36	1.49	1.74	1.98	2.23	2.48	
200		0.73	0.80	0.97	1.14	1.33	1.54	1.75	2.05	2.35	2.48	2.72	2.95	3.40	3.83	4.25	4.66	
300		1.09	1.19	1.40	1.65	1.92	2.22	2.53	3.07	3.43	3.59	3.93	4.25	4.90	5.52	6.12	6.70	
400		1.45	1.59	1.81	2.14	2.49	2.87	3.28	4.10	4.44	4.66	5.09	5.51	6.34	7.14	7.91	8.66	
500		1.82	1.98	2.21	2.61	3.05	3.51	4.01	5.12	5.42	5.69	6.21	6.73	7.73	8.71	9.65	10.55	
600		2.18	2.38	2.61	3.08	3.59	4.14	4.73	6.07	6.39	6.70	7.31	7.92	9.10	10.24	11.34	12.39	
800		2.91	3.17	3.43	4.10	4.65	5.35	6.11	7.85	8.26	8.66	9.45	10.23	11.74	13.20	14.60	15.94	
1000		3.63	3.96	4.29	5.12	5.67	6.53	7.45	9.57	10.06	10.55	11.51	12.45	14.28	16.04	17.73	19.33	
1200		4.36	4.75	5.14	6.13	6.67	7.68	8.76	11.25	11.82	12.39	13.51	14.61	16.75	18.79	20.73	22.58	
1400		5.08	5.54	6.00	7.15	7.77	8.79	10.03	12.88	13.54	14.19	15.46	16.72	19.14	21.44	23.63	25.70	
1600		5.80	6.32	6.85	8.16	8.87	9.89	11.28	14.48	15.21	15.94	17.37	18.76	21.46	24.01	26.42	28.69	
2000		7.24	7.89	8.54	10.18	11.06	12.01	13.70	17.58	18.46	19.33	21.04	22.71	25.89	28.89	31.68	34.25	
2500		9.03	9.83	10.64	12.68	13.77	14.88	16.58	18.37	19.26	20.13	21.83	23.46	26.51	29.27	31.72	33.84	
4000		14.28	15.53	16.76	19.96	21.63	23.33	25.05	27.50	28.73	29.93	32.20	34.29	37.94	
6000		19.85	21.47	23.04	24.56	26.03	27.44	28.78	30.06	31.27	39.30	
8000		22.64	24.27	25.78	27.17	28.43	

Drives falling within the shaded area may be considered noisy and require a sound dampening guard to reduce noise emission.
RPP® is a registered trademark of Carlisle Power Transmission Products, Inc.

8 mm RPP® Belt Horsepower Ratings



The following tables represent the horsepower ratings for each belt at the pre-determined No. of Teeth, Pitch Diameters and rpm's. These ratings must be multiplied by the applicable belt length factor to obtain corrected HP rating.

		50mm (1.97 in.) wide belt (8M-50)												
Smallest Sprocket RPM	No. of Teeth	28	30	32	34	36	38	40	44	48	56	64	72	80
	PD													
	mm	71.30	76.39	81.49	86.58	91.67	96.77	101.86	112.05	122.23	142.60	162.97	183.35	203.72
	in.	2.807	3.008	3.208	3.409	3.609	3.810	4.010	4.411	4.812	5.614	6.416	7.218	8.020
Smallest Sprocket RPM	1160	10.26	11.18	12.88	14.70	18.88	19.85	20.80	22.69	24.54	28.12	31.56	34.84	37.96
	1460	12.89	14.02	15.78	18.01	23.11	24.29	25.45	27.74	29.98	34.31	38.43	42.34	46.02
	1750	15.43	16.77	18.49	21.10	27.08	28.45	29.80	32.46	35.05	40.04	44.76	49.19	53.33
	2900	25.35	27.52	29.73	32.51	36.26	37.99	39.68	42.95	46.08	51.84	56.93	61.30	64.88
	3500	30.40	32.97	35.59	38.25	42.62	44.60	46.52	50.20	53.66	59.88	65.10
	10	0.10	0.12	0.14	0.16	0.18	0.20	0.21	0.24	0.26	0.30	0.34	0.39	0.43
	20	0.20	0.24	0.27	0.31	0.35	0.41	0.43	0.47	0.51	0.60	0.69	0.77	0.86
	40	0.40	0.47	0.55	0.62	0.71	0.81	0.86	0.94	1.03	1.20	1.37	1.54	1.71
	60	0.60	0.71	0.82	0.94	1.06	1.22	1.29	1.41	1.54	1.80	2.06	2.32	2.57
	100	1.01	1.18	1.36	1.56	1.77	2.04	2.14	2.36	2.57	3.00	3.43	3.86	4.29
	200	1.97	2.30	2.66	3.03	3.55	4.07	4.29	4.71	5.10	5.88	6.62	7.35	8.06
	300	2.85	3.32	3.83	4.38	5.32	5.93	6.22	6.79	7.36	8.47	9.54	10.58	11.59
	400	3.70	4.31	4.97	5.68	7.09	7.68	8.05	8.80	9.53	10.96	12.34	13.68	14.97
	500	4.52	5.27	6.08	6.94	8.86	9.38	9.84	10.75	11.64	13.38	15.06	16.68	18.25
	600	5.33	6.21	7.16	8.17	10.50	11.05	11.59	12.65	13.70	15.74	17.71	19.61	21.43
	800	7.08	8.03	9.26	10.57	13.58	14.28	14.97	16.34	17.69	20.30	22.82	25.25	27.57
	1000	8.85	9.80	11.29	12.89	16.56	17.41	18.25	19.91	21.54	24.70	27.75	30.66	33.44
	1200	10.61	11.53	13.28	15.15	19.45	20.45	21.43	23.37	25.28	28.96	32.49	35.86	39.06
1400	12.37	13.44	15.21	17.36	22.28	23.41	24.54	26.75	28.91	33.10	37.09	40.87	44.45	
1600	14.12	15.35	17.10	19.51	25.04	26.31	27.57	30.04	32.45	37.11	41.52	45.70	49.61	
2000	17.61	19.13	20.77	23.69	30.40	31.93	33.44	36.39	39.27	44.79	49.96	54.78	59.24	
2500	21.93	23.82	25.74	28.68	31.77	33.31	34.82	37.75	40.59	45.86	50.63	54.86	58.53	
4000	34.52	37.41	40.34	43.32	47.56	49.70	51.76	55.68	59.31	65.63	
6000	42.49	45.02	47.46	49.78	51.99	54.08	67.97	
8000	47.00	49.17	
		85mm (3.35 in.) wide belt (8M-85)												
Smallest Sprocket RPM	1160	25.56	32.82	34.49	36.16	39.44	42.65	48.88	54.85	60.55	65.97
	1460	31.30	40.18	42.22	44.24	48.22	52.12	59.64	66.80	73.59	80.00
	1750	36.67	47.07	49.45	51.80	56.42	60.92	69.60	77.80	85.50	92.70
	2900	56.51	63.03	66.03	68.97	74.66	80.09	90.11	98.96	106.54	112.78
	3500	66.48	74.09	77.52	80.85	87.25	93.27	104.09	113.15
	10	0.27	0.31	0.35	0.37	0.41	0.45	0.52	0.60	0.67	0.75
	20	0.54	0.62	0.71	0.75	0.82	0.89	1.04	1.19	1.34	1.49
	40	1.09	1.23	1.42	1.49	1.64	1.79	2.09	2.38	2.68	2.98
	60	1.63	1.85	2.12	2.24	2.46	2.68	3.13	3.58	4.02	4.47
	100	2.71	3.08	3.54	3.73	4.10	4.47	5.22	5.96	6.71	7.45
	200	5.27	6.16	7.08	7.45	8.19	8.87	10.21	11.51	12.78	14.00
	300	7.61	9.24	10.30	10.81	11.81	12.79	14.72	16.58	18.39	20.14
	400	9.87	12.32	13.35	14.00	15.29	16.56	19.05	21.45	23.78	26.02
	500	12.06	15.40	16.31	17.11	18.68	20.23	23.25	26.18	29.00	31.72
	600	14.21	18.26	19.20	20.14	21.99	23.81	27.35	30.78	34.08	37.26
	800	18.37	23.60	24.82	26.02	28.40	30.74	35.29	39.67	43.88	47.92
	1000	22.41	28.78	30.25	31.72	34.60	37.44	42.94	48.23	53.29	58.12
	1200	26.33	33.81	35.54	37.25	40.63	43.93	50.35	56.48	62.33	67.90
1400	30.17	38.73	40.70	42.65	46.49	50.25	57.53	64.46	71.04	77.27	
1600	33.91	43.53	45.74	47.92	52.21	56.41	64.50	72.18	79.43	86.24	
2000	41.18	52.85	55.50	58.12	63.26	68.26	77.85	86.84	95.22	102.96	
2500	49.86	55.22	57.90	60.52	65.62	70.53	79.71	88.00	95.36	101.73	
4000	75.30	82.67	86.38	89.97	96.79	103.10	114.07	
6000	86.53	90.37	94.00	118.15	
8000	

Drives falling within the shaded area may be considered noisy and require a sound dampening guard to reduce noise emission.



14 mm RPP® Belt Horsepower Ratings

The following tables represent the horsepower ratings for each belt at the pre-determined No. of Teeth, Pitch Diameters and rpm's. These ratings must be multiplied by the applicable belt length factor to obtain corrected HP rating.

40mm (1.57 in.) wide belt (14M-40)																			
No. of Teeth	28	29	30	32	34	36	38	40	44	48	52	56	60	64	68	72	80		
	mm	124.78	129.23	133.69	142.60	151.51	160.43	169.34	178.25	196.08	213.90	231.73	249.55	267.38	285.21	303.03	320.86	356.51	
PD in.	4.912	5.088	5.263	5.614	5.965	6.316	6.667	7.018	7.720	8.421	9.123	9.825	10.527	11.229	11.930	12.632	14.036		
Smallest Sprocket RPM	1160	18.24	19.55	20.91	23.77	26.81	30.02	32.56	34.13	37.22	40.24	43.17	46.01	48.77	51.42	53.97	56.42	60.98	
	1460	20.70	22.18	23.72	26.93	30.35	33.96	36.72	38.35	41.50	44.48	47.29	49.92	52.35	54.58	56.60	58.39	61.29	
	1750	22.58	24.19	25.85	29.32	33.00	36.89	39.76	41.35	44.32	47.02	49.42	51.51	53.27	54.70	55.76	56.44	56.61	
	2900	33.08	33.94	34.76	36.30	37.69	40.50	42.71	43.04	42.92	42.39	
	3500	37.55	38.32	39.04	40.27	41.24	41.92	42.31	42.39
	10	0.26	0.28	0.30	0.35	0.40	0.45	0.47	0.49	0.55	0.62	0.68	0.75	0.80	0.86	0.91	0.96	1.07	
	20	0.52	0.56	0.60	0.69	0.79	0.89	0.93	0.99	1.11	1.23	1.36	1.49	1.60	1.71	1.82	1.93	2.14	
	40	1.04	1.12	1.21	1.39	1.58	1.79	1.86	1.98	2.22	2.47	2.72	2.98	3.21	3.42	3.64	3.85	4.28	
	60	1.55	1.68	1.81	2.08	2.37	2.68	2.79	2.97	3.33	3.70	4.08	4.47	4.81	5.13	5.45	5.77	6.42	
	100	2.59	2.80	3.01	3.47	3.96	4.47	4.66	4.95	5.55	6.16	6.80	7.45	8.02	8.55	9.09	9.62	10.69	
	200	5.18	5.59	6.03	6.94	7.87	8.83	9.31	9.89	11.09	12.32	13.59	14.90	16.03	17.10	18.16	19.23	21.36	
	300	7.26	7.79	8.34	9.49	10.71	12.01	13.11	13.87	15.39	16.95	18.53	20.13	21.76	23.42	25.10	26.81	30.29	
	400	8.98	9.63	10.30	11.72	13.23	14.83	16.19	17.10	18.94	20.81	22.71	24.62	26.56	28.52	30.51	32.51	36.59	
	500	10.53	11.30	12.09	13.75	15.52	17.40	18.97	20.02	22.13	24.27	26.42	28.59	30.78	32.99	35.22	37.46	41.99	
	600	11.96	12.82	13.72	15.61	17.62	19.75	21.51	22.68	25.03	27.39	29.76	32.14	34.54	36.94	39.35	41.76	46.62	
	800	14.50	15.55	16.63	18.92	21.35	23.92	26.02	27.38	30.09	32.80	35.49	38.17	40.84	43.49	46.12	48.73	53.88	
	1000	16.69	17.90	19.15	21.77	24.56	27.51	29.87	31.37	34.34	37.26	40.14	42.97	45.75	48.47	51.13	53.73	58.74	
	1200	18.60	19.94	21.33	24.24	27.33	30.60	33.17	34.76	37.87	40.90	43.83	46.67	49.40	52.02	54.53	56.92	61.31	
1400	20.25	21.70	23.21	26.36	29.71	33.25	35.97	37.60	40.76	43.77	46.62	49.32	51.85	54.19	56.35	58.32	61.63		
1600	21.67	23.22	24.81	28.17	31.72	35.48	38.31	39.93	43.02	45.90	48.54	50.95	53.11	55.00	56.61	57.93	59.65		
1800	22.86	24.49	26.16	29.67	33.39	37.31	40.19	41.76	44.68	47.30	49.60	51.57	53.18	54.42	55.27	55.71	...		
2000	24.37	25.53	27.26	30.88	34.72	38.75	41.63	43.10	45.74	47.98	49.79	51.15	52.03	52.41	52.27		
2500	29.47	30.32	31.14	32.72	36.59	40.69	43.34	44.31	45.74	46.43	46.33	45.40		
3000	33.91	34.76	35.58	37.09	38.43	40.20	42.26	42.40	42.28		
4000	40.27	40.86	41.35	42.07	42.38		
55mm (2.17in.) wide belt (14M-55)																			
1160	26.67	28.59	30.58	34.75	39.19	43.89	47.60	49.90	54.42	58.82	63.11	67.27	71.29	75.18	78.91	82.49	89.15		
1460	30.26	32.43	34.67	39.38	44.37	49.65	53.69	56.07	60.67	65.03	69.14	72.98	76.53	79.79	82.75	85.37	89.60		
1750	33.02	35.37	37.79	42.87	48.25	53.93	58.13	60.45	64.80	68.74	72.25	75.31	77.89	79.96	81.52	82.52	82.77		
2900	48.37	49.62	50.82	53.07	55.10	59.21	62.43	62.92	62.75	61.98		
3500	54.90	56.03	57.07	58.87	60.29	61.29	61.86	61.97		
10	0.38	0.41	0.44	0.51	0.58	0.65	0.68	0.72	0.81	0.90	0.99	1.09	1.17	1.25	1.33	1.41	1.56		
20	0.76	0.82	0.88	1.01	1.16	1.31	1.36	1.45	1.62	1.80	1.99	2.18	2.35	2.50	2.66	2.81	3.13		
40	1.51	1.64	1.76	2.03	2.31	2.62	2.72	2.89	3.24	3.61	3.98	4.36	4.69	5.00	5.32	5.63	6.25		
60	2.27	2.45	2.64	3.04	3.47	3.92	4.09	4.34	4.87	5.41	5.97	6.54	7.04	7.50	7.97	8.44	9.38		
100	3.79	4.09	4.41	5.07	5.78	6.54	6.81	7.24	8.11	9.01	9.94	10.90	11.72	12.51	13.29	14.07	15.63		
200	7.57	8.18	8.81	10.14	11.51	12.91	13.61	14.47	16.21	18.02	19.87	21.78	23.43	24.99	26.55	28.11	31.22		
300	10.62	11.39	12.19	13.87	15.66	17.55	19.17	20.27	22.51	24.78	27.09	29.44	31.82	34.24	36.70	39.19	44.29		
400	13.12	14.08	15.06	17.14	19.35	21.69	23.66	25.00	27.70	30.43	33.19	36.00	38.83	41.70	44.60	47.53	53.50		
500	15.40	16.51	17.67	20.10	22.69	25.44	27.73	29.27	32.36	35.48	38.63	41.81	45.01	48.23	51.49	54.76	61.39		
600	17.48	18.75	20.06	22.82	25.76	28.87	31.45	33.16	36.59	40.04	43.51	46.99	50.49	54.00	57.52	61.06	68.16		
800	21.19	22.73	24.32	27.66	31.21	34.97	38.04	40.03	44.00	47.95	51.89	55.81	59.71	63.58	67.42	71.24	78.78		
1000	24.40	26.17	27.99	31.83	35.90	40.22	43.67	45.87	50.20	54.48	58.69	62.82	66.88	70.86	74.75	78.56	85.87		
1200	27.19	29.15	31.18	35.43	39.95	44.74	48.50	50.82	55.37	59.80	64.08	68.23	72.22	76.05	79.72	83.21	89.64		
1400	29.61	31.73	33.93	38.54	43.43	48.61	52.60	54.98	59.59	63.99	68.16	72.10	75.80	79.23	82.39	85.27	90.11		
1600	31.68	33.94	36.28	41.18	46.38	51.87	56.01	58.38	62.89	67.10	70.97	74.49	77.64	80.41	82.77	84.70	87.22		
1800	33.43	35.80	38.25	43.38	48.81	54.55	58.76	61.05	65.32	69.15	72.52	75.90	77.75	79.56	80.80	81.44	...		
2000	35.63	37.32	39.85	45.15	50.75	56.66	60.87	63.01	66.87	70.14	72.79	74.78	76.07	76.63	76.42		
2500	43.09	44.33	45.53	47.83	53.49	59.49	63.36	64.79	66.87	67.88	67.74	66.37		
3000	49.58	50.82	52.01	54.22	56.18	58.78	61.79	61.98	61.81		
4000	58.87	59.73	60.46	61.50	61.96		

Drives falling within the shaded area may be considered noisy and require a sound dampening guard to reduce noise emission. RPP® is a registered trademark of Carlisle Power Transmission Products, Inc.

PULLEYS

14 mm RPP® Belt Horsepower Ratings



The following tables represent the horsepower ratings for each belt at the pre-determined No. of Teeth, Pitch Diameters and rpm's. These ratings must be multiplied by the applicable belt length factor to obtain corrected HP rating.

		85mm (3.35 in.) wide belt (14M-85)																	
No. of Teeth	PD	28	29	30	32	34	36	38	40	44	48	52	56	60	64	68	72	80	
		mm in.	124.78 4.912	129.23 5.088	133.69 5.263	142.60 5.614	151.51 5.965	160.43 6.316	169.34 6.667	178.25 7.018	196.08 7.720	213.90 8.421	231.73 9.123	249.55 9.825	267.38 10.527	285.21 11.229	303.03 11.930	320.86 12.632	356.51 14.036
Smallest Sprocket RPM	1160	43.50	46.64	49.88	56.69	63.93	71.60	77.64	81.40	88.77	95.96	102.96	109.74	116.31	122.64	128.73	134.57	145.43	
	1460	49.37	52.91	56.57	64.24	72.38	80.99	87.58	91.47	98.98	106.09	112.79	119.05	124.85	130.17	134.99	139.27	146.17	
	1750	53.87	57.69	61.65	69.93	78.71	87.98	94.83	98.61	105.70	112.13	117.86	122.85	127.06	130.45	132.98	134.61	135.02	
	2900	78.90	80.95	82.91	86.58	89.89	96.59	101.85	102.64	102.37	101.11	
	3500	89.57	91.40	93.10	96.04	98.35	99.99	100.91	101.09
	10	0.62	0.67	0.72	0.83	0.94	1.07	1.11	1.18	1.32	1.47	1.62	1.78	1.91	2.04	2.17	2.30	2.55	
	20	1.24	1.33	1.44	1.65	1.89	2.13	2.22	2.36	2.65	2.94	3.24	3.56	3.83	4.08	4.34	4.59	5.10	
	40	2.47	2.67	2.87	3.31	3.77	4.27	4.44	4.72	5.29	5.88	6.49	7.11	7.65	8.16	8.67	9.18	10.20	
	60	3.71	4.00	4.31	4.96	5.66	6.40	6.66	7.08	7.94	8.82	9.73	10.67	11.48	12.24	13.01	13.77	15.30	
	100	6.18	6.67	7.19	8.27	9.43	10.67	11.11	11.80	13.23	14.70	16.22	17.78	19.13	20.40	21.68	22.95	25.50	
	200	12.35	13.34	14.37	16.54	18.78	21.05	22.21	23.60	26.45	29.39	32.42	35.53	38.23	40.77	43.32	45.86	50.94	
	300	17.32	18.58	19.89	22.63	25.54	28.63	31.27	33.07	36.72	40.42	44.19	48.02	51.91	55.85	59.86	63.93	72.24	
	400	21.41	22.97	24.58	27.96	31.56	35.38	38.60	40.78	45.18	49.64	54.15	58.72	63.34	68.02	72.76	77.54	87.28	
	500	25.12	26.94	28.83	32.80	37.02	41.49	45.24	47.74	52.79	57.88	63.02	68.20	73.42	78.69	83.99	89.34	100.15	
	600	28.52	30.59	32.73	37.23	42.02	47.10	51.31	54.10	59.70	65.33	70.98	76.66	81.37	88.09	93.84	99.61	111.19	
	800	34.57	37.08	39.67	45.12	50.91	57.05	62.05	65.30	71.77	78.23	84.65	91.04	97.40	103.71	109.99	116.21	128.51	
	1000	39.81	42.69	45.67	51.92	58.57	65.61	71.25	74.82	81.90	88.88	95.74	102.49	109.11	115.60	121.95	128.15	140.09	
	1200	44.36	47.56	50.86	57.80	65.18	72.98	79.12	82.91	90.33	97.55	104.54	111.30	117.81	124.07	130.05	135.75	146.23	
	1400	48.30	51.77	55.35	62.87	70.85	79.29	85.80	89.68	97.21	104.38	111.20	117.63	123.65	129.25	134.41	139.10	147.00	
	1600	51.68	55.37	59.18	67.18	75.65	84.61	91.36	95.23	102.60	109.46	115.78	121.52	126.66	131.17	135.02	138.17	142.28	
1800	54.53	58.40	62.40	70.76	79.63	88.98	95.85	99.59	106.56	112.81	118.30	122.99	126.83	129.79	131.81	132.86	...		
2000	58.13	60.88	65.01	73.66	82.80	92.43	99.30	102.79	109.09	114.43	118.75	121.99	124.10	125.01	124.67		
2500	70.30	72.31	74.27	78.03	87.26	97.05	103.36	105.69	109.09	110.74	110.50	108.27		
3000	80.88	82.91	84.85	88.45	91.66	95.89	100.79	101.11	100.83		
4000	96.04	97.44	98.63	100.33	101.08		
		115mm (4.53in.) wide belt (14M-115)																	
Smallest Sprocket RPM	1160	60.33	64.69	69.19	78.63	88.67	99.30	107.69	112.90	123.13	133.10	142.80	152.21	161.32	170.10	178.55	186.65	201.72	
	1460	68.47	73.38	78.46	89.10	100.39	112.33	121.48	126.88	137.28	147.15	156.44	165.12	173.17	180.55	187.23	193.17	202.73	
	1750	74.71	80.02	85.51	97.00	109.17	122.02	131.53	136.78	146.61	155.53	163.48	170.39	176.23	180.93	184.44	186.70	187.27	
	2900	109.44	112.27	115.00	120.09	124.68	133.98	141.27	142.37	141.98	140.24	
	3500	124.23	126.78	129.13	133.21	136.41	138.68	139.97	140.21	
	10	0.86	0.93	1.00	1.15	1.31	1.48	1.54	1.64	1.84	2.04	2.25	2.47	2.65	2.83	3.01	3.18	3.54	
	20	1.71	1.85	1.99	2.29	2.62	2.96	3.08	3.27	3.67	4.08	4.50	4.93	5.31	5.66	6.01	6.37	7.08	
	40	3.43	3.70	3.99	4.59	5.23	5.92	6.16	6.55	7.34	8.16	9.00	9.86	10.61	11.32	12.03	12.74	14.15	
	60	5.14	5.55	5.98	6.88	7.85	8.88	9.24	9.82	11.01	12.24	13.50	14.80	15.92	16.98	18.04	19.10	21.22	
	100	8.57	9.25	9.97	11.47	13.08	14.80	15.41	16.37	18.35	20.39	22.49	24.66	26.53	28.30	30.06	31.83	35.37	
	200	17.13	18.50	19.93	22.94	26.05	29.20	30.80	32.73	36.69	40.76	44.96	49.29	53.02	56.55	60.08	63.60	70.65	
	300	24.03	25.78	27.58	31.38	35.43	39.71	43.37	45.87	50.93	56.07	61.29	66.60	71.99	77.47	83.03	88.67	100.20	
	400	29.70	31.85	34.09	38.78	43.77	49.07	53.54	56.56	62.67	68.85	75.11	81.45	87.86	94.35	100.91	107.55	121.06	
	500	34.84	37.37	39.99	45.49	51.34	57.55	62.74	66.22	73.22	80.28	87.41	94.59	101.84	109.14	116.50	123.91	138.91	
	600	39.55	42.42	45.39	51.64	58.28	65.32	71.16	75.03	82.80	90.61	98.45	106.33	114.24	122.19	130.16	138.16	154.22	
	800	47.95	51.43	55.02	62.57	70.61	79.13	86.06	90.57	99.55	108.50	117.41	126.28	135.09	143.85	152.55	161.19	178.24	
	1000	55.22	59.21	63.34	72.01	81.23	91.00	98.82	103.78	113.60	123.27	132.79	142.15	151.34	160.34	169.14	177.75	194.30	
	1200	61.53	65.96	70.55	80.17	90.40	101.23	109.74	114.99	125.29	135.30	145.00	154.37	163.41	172.08	180.38	188.28	202.83	
	1400	66.99	71.80	76.77	87.20	98.27	109.98	119.01	124.39	134.82	144.78	154.23	163.15	171.50	179.27	186.42	192.93	203.89	
	1600	71.68	76.80	82.09	93.17	104.93	117.36	126.72	132.09	142.31	151.82	160.58	168.55	175.68	181.94	187.27	191.64	197.34	
1800	75.63	81.00	86.54	98.15	110.44	123.42	132.95	138.14	147.80	156.47	164.08	170.59	175.92	180.02	182.82	184.28	...		
2000	80.63	84.44	90.18	102.16	114.84	128.20	137.73	142.57	151.31	158.71	164.70	169.20	172.12	173.39	172.91		
2500	97.50	100.29	103.02	108.23	121.03	134.61	143.36	146.59	151.31	153.59	153.27	150.18		
3000	112.18	115.00	117.69	122.68	127.13	133.00	139.80	140.24	139.85		
4000	133.21	135.15	136.79	139.15	140.20		

Drives falling within the shaded area may be considered noisy and require a sound dampening guard to reduce noise emission.
RPP® is a registered trademark of Carlisle Power Transmission Products, Inc.



14 mm & 20 mm RPP® Belt Horsepower Ratings

The following tables represent the horsepower ratings for each belt at the pre-determined No. of Teeth, Pitch Diameters and rpm's. These ratings must be multiplied by the applicable belt length factor to obtain corrected HP rating.

170mm (6.69in.) wide belt (14M-170)																
No. of Teeth			36	38	40	44	48	52	56	66	64	68	72	80		
	PD	mm in.	160.43 6.316	169.34 6.667	178.25 7.018	196.08 7.720	213.90 8.421	231.73 9.123	249.55 9.825	267.38 10.527	285.21 11.229	303.03 11.930	320.86 12.632	356.51 14.036		
Smallest Sprocket RPM	1160	150.10	162.78	170.65	186.11	201.18	215.84	230.06	243.83	257.10	269.87	282.11	304.89			
	1460	169.79	183.61	191.77	207.50	222.41	236.45	249.59	261.74	272.90	282.99	291.97	306.43			
	1750	184.44	198.81	206.73	221.60	235.08	247.09	257.55	266.37	273.48	278.78	282.20	283.06			
	2900	202.50	213.53	215.19	214.60	211.97			
	3500	209.62	211.56	211.93			
	10	2.24	2.33	2.47	2.77	3.08	3.40	3.73	4.01	4.28	4.55	4.81	5.35			
	20	4.47	4.66	4.95	5.55	6.16	6.80	7.45	8.02	8.56	9.09	9.63	10.70			
	40	8.95	9.31	9.90	11.10	12.33	13.60	14.91	16.04	17.11	18.18	19.25	21.39			
	60	13.42	13.97	14.85	16.64	18.49	20.40	22.36	24.06	25.67	27.27	28.87	32.08			
	100	22.37	23.29	24.74	27.74	30.82	34.00	37.27	40.10	42.77	45.44	48.11	53.46			
	200	44.14	46.56	49.47	55.45	61.61	67.96	74.49	80.14	85.48	90.81	96.14	106.79			
	300	60.03	65.55	69.33	76.97	84.74	92.64	100.67	108.82	117.10	125.50	134.03	151.46			
	400	74.17	80.93	85.50	94.72	104.06	113.53	123.10	132.80	142.61	152.53	162.57	182.97			
	500	86.99	94.84	100.09	110.67	121.34	132.11	142.97	153.92	164.96	176.09	187.29	209.96			
	600	98.74	107.56	113.41	125.15	136.95	148.81	160.72	172.68	184.68	196.73	208.82	233.11			
	800	119.60	130.08	136.89	150.47	164.00	177.46	190.86	204.19	217.43	230.58	243.63	269.41			
	1000	137.54	149.37	156.86	171.70	186.32	200.71	214.86	228.74	242.35	255.66	268.66	293.68			
	1200	153.01	165.87	173.81	189.37	204.50	219.16	233.33	246.99	260.10	272.64	284.58	306.57			
	1400	166.23	179.87	188.02	203.79	218.83	233.12	246.60	259.23	270.97	281.77	291.61	308.17			
	1600	177.38	191.54	199.65	215.10	229.48	242.72	254.76	265.54	275.00	283.06	289.67	298.27			
1800	186.54	200.95	208.79	223.39	236.50	248.01	257.84	265.90	272.09	276.34	278.54	...				
2000	193.77	208.17	215.49	228.70	239.89	248.95	255.75	260.16	262.07	261.35				
2500	203.46	216.69	221.57	228.71	232.15	231.66	226.99				
3000	201.02	211.31	211.98	211.38				
4000				
115mm (4.53 in.) wide belt (20M-115)																
No. of Teeth			34	36	38	40	44	48	52	56	60	64	68	72	80	90
	PD	mm in.	216.46 8.522	229.18 9.023	241.91 9.524	254.66 10.026	280.11 11.028	305.59 12.031	331.04 13.033	356.51 14.036	381.97 15.038	407.44 16.041	432.89 17.043	458.37 18.046	509.30 20.051	572.95 22.557
Smallest Sprocket RPM	870	199.41	210.20	220.85	231.35	251.85	271.65	290.69	308.91	326.25	342.64	358.04	372.36	397.58	422.03	
	960	214.31	225.69	236.88	247.87	269.18	289.56	308.93	327.19	344.28	360.10	374.57	387.63	409.12	426.50	
	1160	244.73	257.05	269.02	280.65	302.76	323.22	341.91	358.67	373.36	385.83	395.94	403.55	410.65	...	
	1460	283.02	295.65	307.61	318.87	339.13	356.15	369.63	379.29	384.84	385.98	382.43	
	1750	310.91	322.38	332.71	341.83	356.21	365.02	367.76	363.94	
	10	2.82	2.98	3.15	3.32	3.65	3.98	4.31	4.64	4.97	5.31	5.64	5.97	6.63	7.46	
	20	5.64	5.97	6.30	6.63	7.30	7.96	8.62	9.29	9.95	10.61	11.28	11.94	13.27	14.92	
	40	11.28	11.94	12.60	13.27	14.59	15.92	17.24	18.57	19.90	21.22	22.55	23.87	26.52	29.84	
	60	16.91	17.91	18.90	19.90	21.88	23.87	25.86	27.85	29.84	31.82	33.81	35.80	39.77	44.73	
	100	28.18	29.84	31.49	33.15	36.46	39.77	43.08	46.39	49.69	53.00	56.30	59.61	66.21	74.44	
	200	56.30	59.61	62.91	66.21	72.80	79.38	85.95	92.52	99.07	105.62	112.15	118.66	131.66	147.82	
	300	84.31	89.24	94.15	99.07	108.88	118.66	128.42	138.14	147.82	157.46	167.07	176.63	195.61	219.06	
	400	109.02	115.29	121.54	127.77	140.19	152.52	164.77	176.93	189.00	200.98	212.84	224.60	247.77	276.01	
	500	130.16	137.58	144.97	152.33	166.95	181.43	195.75	209.91	223.90	237.70	251.30	264.69	290.81	322.08	
	600	150.19	158.66	167.09	175.46	192.04	208.38	224.46	240.27	255.78	270.97	285.83	300.33	328.19	360.67	
	700	169.22	178.65	187.99	197.26	215.54	233.44	250.94	268.01	284.61	300.71	316.29	331.31	359.55	391.14	
	800	187.30	197.57	207.73	217.77	237.46	256.60	275.15	293.05	310.27	326.75	342.45	357.32	384.38	412.70	
	900	204.46	215.46	226.30	236.97	257.78	277.81	296.99	315.27	332.58	348.84	364.00	377.97	402.13	424.49	
	1000	220.70	232.31	243.70	254.86	276.45	296.99	316.38	334.52	351.34	366.73	380.60	392.86	412.18	425.61	
	1100	236.00	248.09	259.90	271.40	293.42	314.05	333.15	350.61	366.30	380.10	391.88	401.53	413.90	415.11	
1200	250.36	262.79	274.86	286.53	308.61	328.88	347.18	363.35	377.23	388.66	397.47	403.51	406.62	...		
1400	276.10	288.78	300.87	312.34	333.29	351.38	366.35	377.95	385.91	390.00	389.94		
1600	297.67	309.93	312.32	331.78	349.75	363.46	372.52	376.56	375.19		
1800	314.73	325.84	335.71	344.26	357.17	364.02	364.26		
2000	326.94	336.08	343.52	349.16	354.68	351.91		

Drives falling within the shaded area may be considered noisy and require a sound dampening guard to reduce noise emission.
RPP® is a registered trademark of Carlisle Power Transmission Products, Inc.

20 mm RPP® Belt Horsepower Ratings



The following tables represent the horsepower ratings for each belt at the pre-determined No. of Teeth, Pitch Diameters and rpm's. These ratings must be multiplied by the applicable belt length factor to obtain corrected HP rating.

170mm (6.69 in.) wide belt (20M-170)															
No. of Teeth															
	34	36	38	40	44	48	52	56	60	64	68	72	80	90	
PD	mm	216.46	229.18	241.91	254.66	280.11	305.59	331.04	356.51	381.97	407.44	432.89	458.37	509.30	572.95
	in.	8.522	9.023	9.524	10.026	11.028	12.031	13.033	14.036	15.038	16.041	17.043	18.046	20.051	22.557
Smallest Sprocket RPM	870	309.54	326.35	342.95	359.33	391.35	422.34	452.20	480.84	508.18	534.12	558.58	581.47	622.16	662.56
	960	332.79	350.55	368.02	385.19	418.56	450.54	481.02	509.87	536.98	562.21	585.47	606.61	642.08	672.38
	1160	380.41	399.70	418.49	436.76	471.60	504.02	533.81	560.75	584.62	605.21	622.31	635.71	650.52	...
	1460	440.83	460.80	479.79	497.74	530.30	558.06	580.60	597.48	608.28	612.57	609.92
	1750	485.60	504.07	520.85	535.84	560.12	576.17	583.24	580.60
	10	4.37	4.63	4.88	5.14	5.65	6.17	6.68	7.20	7.71	8.22	8.74	9.25	10.28	11.57
	20	8.74	9.25	9.77	10.28	11.31	12.34	13.37	14.39	15.42	16.45	17.48	18.51	20.56	23.13
	40	17.48	18.51	19.53	20.56	22.62	24.67	26.73	28.78	30.84	32.89	34.95	37.00	41.11	46.25
	60	26.21	27.76	29.30	30.84	33.92	37.00	40.09	43.17	46.25	49.33	52.41	55.49	61.65	69.34
	100	43.68	46.25	48.82	51.38	56.52	61.65	66.78	71.90	77.03	82.15	87.28	92.40	102.63	115.40
	200	87.28	92.40	97.51	102.63	112.85	123.05	133.25	143.43	153.59	163.74	173.87	183.98	204.14	229.22
	300	130.70	138.34	145.97	153.59	168.81	183.98	199.11	214.19	229.22	244.19	259.10	273.95	303.44	339.88
	400	169.03	178.75	188.45	198.12	217.38	236.53	255.55	274.44	293.20	311.81	330.26	348.55	384.61	428.63
	500	201.83	213.35	224.83	236.26	258.96	281.46	303.73	325.75	347.52	369.00	390.20	411.09	451.87	500.82
	600	232.94	246.11	259.20	272.21	297.99	323.41	348.45	373.08	397.27	421.00	444.22	466.93	510.64	561.80
700	262.52	277.18	291.72	306.14	334.60	362.50	389.80	416.47	442.44	467.68	492.14	515.78	560.38	610.65	
800	290.67	306.65	322.47	338.11	368.82	398.72	427.74	455.80	482.85	508.81	533.62	557.19	600.38	646.22	
900	317.41	334.56	351.47	368.13	400.64	432.01	462.14	490.92	518.26	544.06	568.21	590.63	629.84	667.27	
1000	342.77	360.89	378.70	396.16	430.00	462.27	492.85	521.59	548.36	573.02	595.44	615.47	647.85	672.47	
1100	366.72	385.63	404.12	422.16	456.79	489.36	519.67	547.55	572.81	595.27	614.75	631.07	653.48	660.43	
1200	389.24	408.74	427.69	446.06	480.93	513.12	542.39	568.52	591.25	610.36	627.77	643.44	667.34	688.57	
1400	429.85	449.85	468.99	487.21	520.70	549.96	574.61	594.26	608.55	617.10	619.92	615.92	600.38	561.80	
1600	464.21	483.74	501.98	518.86	548.23	571.30	587.50	596.28	597.05	
1800	491.85	509.82	525.95	540.15	562.32	575.53	578.98	
2000	512.27	527.47	540.15	550.17	561.70	560.97	

230mm (9.06 in.) wide belt (20M-230)															
No. of Teeth															
	38	40	44	48	52	56	60	64	68	72	80	90			
PD	mm	241.91	254.66	280.11	305.59	331.04	356.51	381.97	407.44	432.89	458.37	509.30	572.95		
	in.	9.524	10.026	11.028	12.031	13.033	14.036	15.038	16.041	17.043	18.046	20.051	22.557		
Smallest Sprocket RPM	870	478.45	501.36	546.19	589.62	631.52	671.77	710.26	746.86	781.45	813.91	871.96	930.35		
	960	513.56	537.61	584.38	629.28	672.15	712.81	751.10	786.87	819.95	850.18	901.41	946.46		
	1160	584.44	610.10	659.15	704.91	747.11	785.45	819.64	849.39	874.42	894.44	918.25	...		
	1460	671.12	696.54	742.88	782.73	815.51	840.63	857.52	865.61	864.30		
	1750	730.14	751.76	787.25	811.61	823.82	822.89		
	10	6.81	7.16	7.88	8.60	9.31	10.03	10.75	11.46	12.18	12.89	14.33	16.12		
	20	13.61	14.33	15.76	17.19	18.62	20.06	21.49	22.92	24.36	25.79	28.65	32.23		
	40	27.22	28.65	31.52	34.38	37.25	40.11	42.98	45.84	48.70	51.57	57.29	64.45		
	60	40.83	42.98	47.27	51.57	55.86	60.16	64.45	68.74	73.04	77.33	85.91	96.63		
	100	68.03	71.61	78.76	85.91	93.06	100.21	107.35	114.49	121.63	128.76	143.02	160.83		
	200	135.90	143.02	157.27	171.50	185.71	199.90	214.07	228.21	242.34	256.43	284.55	319.52		
	300	203.44	214.07	235.28	256.43	277.53	298.56	319.52	340.40	361.20	381.91	423.07	473.93		
	400	262.67	276.15	303.02	329.42	356.26	382.62	408.79	434.76	460.53	486.07	536.46	598.00		
	500	313.41	329.35	361.03	392.43	423.52	454.27	484.68	514.71	544.34	573.56	630.65	699.26		
	600	361.38	379.54	415.53	451.04	486.03	520.46	554.30	587.51	620.04	651.87	713.22	785.21		
700	406.80	426.94	466.70	505.71	543.92	581.25	617.65	653.06	687.41	720.64	783.49	854.63			
800	449.79	471.65	514.61	556.46	597.13	636.50	674.50	711.03	745.98	779.28	840.51	906.01			
900	490.37	513.68	559.23	603.21	645.51	686.00	724.53	760.97	795.19	827.06	883.18	937.67			
1000	528.54	553.01	600.47	645.82	688.87	729.43	767.33	802.37	834.38	863.16	910.32	947.81			
1100	564.23	589.55	638.23	684.10	726.93	766.46	802.45	834.66	862.83	886.71	920.65	934.57			
1200	597.40	632.22	672.35	717.86	759.41	796.70	829.41	857.20	879.77	896.79	912.88	...			
1400	655.77	681.52	729.05	770.84	806.40	835.20	856.74	870.51	875.99			
1600	702.83	726.89	769.10	802.78	827.16	841.49	845.00			
1800	737.64	758.20	790.90	811.49	818.87			
2000	759.16	774.20	792.75	794.71			

Drives falling within the shaded area may be considered noisy and require a sound dampening guard to reduce noise emission. RPP® is a registered trademark of Carlisle Power Transmission Products, Inc.



20 mm RPP® Belt Horsepower Ratings

The following tables represent the horsepower ratings for each belt at the pre-determined No. of Teeth, Pitch Diameters and rpm's. These ratings must be multiplied by the applicable belt length factor to obtain corrected HP rating.

290mm (11.42 in.) wide belt (20M-290)										
No. of Teeth			52	56	60	64	68	72	80	90
	PD	mm in.	331.04 13.033	356.51 14.036	381.97 15.938	407.44 16.041	432.89 17.043	458.37 18.046	509.30 20.051	572.95 22.557
Smallest Sprocket RPM	870		807.70	859.33	908.73	955.75	1000.23	1042.03	1116.95	1192.75
	960		859.88	912.09	961.32	1007.37	1050.02	1089.07	1155.54	1214.69
	1160		956.45	1005.89	1050.10	1088.72	1121.37	1147.70	1179.92	...
	1460		1045.65	1078.65	1101.28	1112.79	1112.46
	1750		1058.89	1059.25
	10		11.90	12.81	13.73	14.65	15.56	16.48	18.31	20.60
	20		23.80	25.63	27.46	29.29	31.12	32.95	36.61	41.19
	40		47.59	51.25	54.91	58.57	62.23	65.89	73.21	82.35
	60		71.38	76.87	82.35	87.84	93.32	98.81	109.77	123.48
	100		118.91	128.04	137.17	146.30	155.42	164.53	182.76	205.51
	200		237.30	255.43	273.54	291.62	309.67	327.59	363.62	408.32
	300		354.65	381.53	408.32	435.01	461.60	488.08	540.70	605.74
	400		455.29	488.99	522.46	555.67	588.62	621.29	685.74	764.49
	500		541.30	580.64	619.53	657.95	695.87	733.26	806.35	894.25
	600		621.29	665.35	708.66	751.17	792.84	833.61	912.25	1004.62
	700		695.40	743.20	789.83	835.20	879.24	921.87	1002.58	1094.10
	800		763.59	814.05	862.78	909.64	954.53	997.32	1076.15	1160.77
	900		825.67	877.61	927.09	973.93	1017.97	1059.05	1131.59	1202.53
1000		881.38	933.50	982.26	1027.42	1068.75	1106.01	1167.41	1217.12	
1100		930.40	981.30	1027.73	1069.39	1105.96	1137.13	1182.02	1202.19	
1200		972.37	1020.52	1062.88	1099.06	1128.64	1151.22	1173.77	...	
1400		1033.58	1071.18	1099.62	1118.26	1162.45	
1600		1061.68	1081.18	1087.03	
1800		1053.10	
2000		
340mm (13.39 in.) wide belt (20M-340)										
No. of Teeth			52	56	60	64	68	72	80	90
PD	mm in.		331.04 13.033	356.51 14.036	381.97 15.938	407.44 16.041	432.89 17.043	458.37 18.046	509.30 20.051	572.95 22.557
Smallest Sprocket RPM	870		954.52	1015.63	1074.12	1129.82	1182.55	1232.13	1321.11	1411.41
	960		1016.33	1078.16	1136.51	1191.11	1241.74	1288.14	1367.32	1438.22
	1160		1130.90	1189.59	1242.15	1288.15	1327.16	1358.76	1397.98	...
	1460		1237.44	1277.01	1304.41	1318.78	1319.27
	1750		1254.78	1256.21
	10		14.06	15.14	16.22	17.30	18.38	19.46	21.62	24.33
	20		28.11	30.27	32.43	34.60	36.76	38.92	43.24	48.65
	40		56.22	60.54	64.86	69.18	73.51	77.83	86.47	97.27
	60		84.31	90.79	97.27	103.75	110.23	116.71	129.66	145.85
	100		140.45	151.24	162.02	172.80	183.57	194.34	215.87	242.74
	200		280.30	301.72	323.11	344.46	365.79	387.07	429.51	482.32
	300		418.92	450.67	482.32	513.86	545.27	576.56	638.72	715.58
	400		537.82	577.64	617.18	656.42	695.36	733.97	810.15	903.24
	500		639.46	685.95	731.91	777.32	822.15	866.35	952.78	1056.74
	600		734.00	786.09	837.29	887.56	936.84	985.06	1078.11	1187.47
	700		821.64	878.17	933.32	986.99	1039.11	1089.57	1185.15	1293.65
	800		902.31	962.01	1019.67	1075.15	1128.32	1179.03	1272.51	1373.06
	900		975.80	1037.29	1095.89	1151.40	1203.63	1252.37	1338.60	1423.24
1000		1041.81	1103.56	1161.37	1214.96	1264.06	1308.39	1381.66	1441.54	
1100		1099.96	1160.63	1215.46	1265.00	1308.57	1345.80	1399.82	1425.21	
1200		1149.83	1207.03	1257.45	1300.60	1336.03	1363.25	1391.17	...	
1400		1222.91	1267.83	1302.02	1324.72	1335.16	
1600		1257.12	1280.92	1288.72	
1800		1248.30	
2000		

Drives falling within the shaded area may be considered noisy and require a sound dampening guard to reduce noise emission.
RPP® is a registered trademark of Carlisle Power Transmission Products, Inc.

PULLEYS

8 mm RPP® Plus Belt Horsepower Ratings



The following tables represent the horsepower ratings for each belt at the pre-determined No. of Teeth, Pitch Diameters and rpm's. These ratings must be multiplied by the applicable belt length factor to obtain corrected HP rating.

		20mm (.79 in.) wide belt (8M-20)																
No. of Teeth	PD	22	24	26	28	30	32	34	36	38	40	44	48	56	64	72	80	
		mm in.	56.02 2.206	61.12 2.406	66.21 2.607	71.30 2.807	76.39 3.008	81.49 3.208	86.58 3.409	91.67 3.609	96.77 3.810	101.86 4.010	112.05 4.411	122.23 4.812	142.60 5.614	162.97 6.416	183.35 7.218	203.72 8.020
Smallest Sprocket RPM	1160	4.41	4.86	5.32	5.78	6.24	6.70	7.17	7.64	8.12	8.59	9.55	10.52	12.47	14.45	16.44	18.44	
	1460	5.24	5.77	6.31	6.85	7.40	7.95	8.50	9.06	9.62	10.18	11.31	12.44	14.73	17.04	19.35	21.66	
	1750	5.99	6.60	7.22	7.83	8.46	9.08	9.71	10.34	10.98	11.61	12.89	14.18	16.75	19.33	21.90	24.45	
	2900	8.68	9.55	10.42	11.30	12.17	13.05	13.92	14.80	15.67	16.54	18.27	19.98	23.31	26.51	29.53	32.33	
	3500	9.93	10.92	11.90	12.88	13.86	14.83	15.80	16.77	17.72	18.67	20.53	22.35	25.81	28.98	
	10	0.07	0.08	0.08	0.09	0.10	0.10	0.11	0.12	0.12	0.13	0.14	0.15	0.18	0.21	0.23	0.26	
	20	0.14	0.15	0.17	0.18	0.19	0.21	0.22	0.23	0.24	0.26	0.28	0.31	0.36	0.41	0.46	0.51	
	40	0.28	0.31	0.33	0.36	0.39	0.41	0.44	0.46	0.49	0.51	0.57	0.62	0.72	0.82	0.93	1.03	
	60	0.42	0.46	0.50	0.54	0.58	0.62	0.66	0.70	0.73	0.77	0.85	0.93	1.08	1.24	1.39	1.54	
	100	0.70	0.77	0.84	0.90	0.97	1.03	1.09	1.16	1.22	1.29	1.42	1.54	1.80	2.06	2.32	2.57	
	200	1.18	1.30	1.43	1.55	1.67	1.80	1.93	2.05	2.18	2.31	2.57	2.83	3.37	3.91	4.46	5.02	
	300	1.60	1.77	1.93	2.10	2.27	2.44	2.61	2.78	2.96	3.13	3.48	3.84	4.56	5.30	6.04	6.80	
	400	1.99	2.19	2.40	2.60	2.81	3.02	3.24	3.45	3.67	3.88	4.32	4.76	5.66	6.57	7.49	8.43	
	500	2.35	2.59	2.83	3.08	3.33	3.57	3.83	4.08	4.33	4.59	5.11	5.63	6.69	7.76	8.85	9.96	
	600	2.69	2.97	3.25	3.53	3.81	4.10	4.39	4.67	4.97	5.26	5.85	6.45	7.66	8.89	10.14	11.40	
	800	3.34	3.68	4.03	4.38	4.73	5.08	5.44	5.80	6.16	6.52	7.25	7.99	9.49	11.01	12.54	14.09	
	1000	3.95	4.35	4.76	5.17	5.58	6.00	6.42	6.84	7.27	7.70	8.56	9.43	11.19	12.97	14.77	16.58	
	1200	4.53	4.99	5.45	5.92	6.40	6.87	7.35	7.84	8.32	8.81	9.79	10.78	12.79	14.81	16.85	18.89	
	1400	5.08	5.59	6.12	6.64	7.17	7.71	8.24	8.78	9.32	9.87	10.97	12.07	14.30	16.54	18.79	21.04	
	1600	5.61	6.18	6.75	7.33	7.92	8.50	9.09	9.69	10.28	10.88	12.09	13.30	15.73	18.17	20.61	23.04	
	2000	6.62	7.29	7.96	8.64	9.32	10.01	10.70	11.39	12.09	12.78	14.18	15.58	18.37	21.15	23.90	26.60	
	2500	7.79	8.58	9.37	10.16	10.96	11.76	12.55	13.36	14.16	14.96	16.55	18.15	21.29	24.36	27.34	30.19	
	4000	10.91	11.97	13.04	14.09	15.14	16.18	17.21	18.22	19.23	20.21	22.13	23.97	27.37	
	6000	14.24	15.52	16.76	17.97	19.13	20.24	21.30	22.30	23.24	24.10	
	8000	16.71	17.91	19.09	20.16	21.11	
			30mm (1.18 in.) wide belt (8M-30)															
	Smallest Sprocket RPM	1160	6.97	7.68	8.40	9.13	9.86	10.59	11.33	12.08	12.83	13.58	15.10	16.63	19.72	22.84	26.00	29.17
		1460	8.28	9.12	9.97	10.83	11.69	12.56	13.44	14.32	15.20	16.09	17.87	19.67	23.30	26.95	30.61	34.27
1750		9.47	10.43	11.40	12.38	13.37	14.36	15.35	16.35	17.35	18.36	20.38	22.42	26.50	30.59	34.67	38.71	
2900		13.73	15.10	16.48	17.87	19.25	20.64	22.03	23.42	24.80	26.18	28.93	31.65	36.97	42.09	46.94	51.48	
3500		15.71	17.27	18.82	20.38	21.93	23.48	25.02	26.55	28.08	29.59	32.56	35.47	41.02	46.15	
10		0.11	0.12	0.13	0.14	0.15	0.16	0.17	0.18	0.19	0.20	0.22	0.24	0.28	0.33	0.37	0.41	
20		0.22	0.24	0.26	0.28	0.31	0.33	0.35	0.37	0.39	0.41	0.45	0.49	0.57	0.65	0.73	0.81	
40		0.45	0.49	0.53	0.57	0.61	0.65	0.69	0.73	0.77	0.81	0.89	0.98	1.14	1.30	1.46	1.63	
60		0.67	0.73	0.79	0.85	0.92	0.98	1.04	1.10	1.16	1.22	1.34	1.46	1.71	1.95	2.20	2.44	
100		1.11	1.22	1.32	1.42	1.53	1.63	1.73	1.83	1.93	2.03	2.24	2.44	2.85	3.25	3.66	4.07	
200		1.87	2.06	2.25	2.45	2.64	2.84	3.04	3.24	3.45	3.65	4.06	4.48	5.32	6.18	7.05	7.93	
300		2.53	2.79	3.05	3.32	3.58	3.85	4.12	4.39	4.67	4.95	5.50	6.07	7.21	8.37	9.55	10.74	
400		3.14	3.46	3.79	4.12	4.45	4.78	5.11	5.45	5.79	6.13	6.83	7.52	8.94	10.38	11.84	13.32	
500		3.71	4.09	4.48	4.86	5.25	5.65	6.05	6.44	6.85	7.25	8.07	8.89	10.56	12.26	13.99	15.73	
600		4.26	4.69	5.13	5.58	6.02	6.47	6.93	7.39	7.85	8.31	9.24	10.19	12.10	14.05	16.02	18.01	
800		5.28	5.82	6.37	6.92	7.47	8.03	8.59	9.16	9.73	10.30	11.46	12.63	14.99	17.39	19.82	22.28	
1000		6.24	6.88	7.52	8.17	8.82	9.48	10.15	10.82	11.49	12.16	13.53	14.90	17.68	20.50	23.35	26.22	
1200		7.15	7.88	8.62	9.36	10.11	10.86	11.62	12.38	13.15	13.92	15.48	17.05	20.21	23.41	26.64	29.88	
1400		8.02	8.84	9.67	10.50	11.33	12.18	13.03	13.88	14.74	15.60	17.33	19.08	22.60	26.16	29.72	33.30	
1600		8.86	9.76	10.67	11.59	12.51	13.44	14.37	15.31	16.26	17.20	19.11	21.02	24.87	28.74	32.62	36.48	
2000		10.45	11.51	12.58	13.66	14.74	15.83	16.92	18.01	19.11	20.22	22.43	24.64	29.07	33.49	37.86	42.16	
2500		12.32	13.56	14.81	16.07	17.33	18.59	19.86	21.12	22.39	23.66	26.20	28.72	33.72	38.62	43.38	47.95	
4000		17.26	18.95	20.63	22.31	23.97	25.63	27.27	28.89	30.49	32.07	35.15	38.10	43.60	
6000		22.57	24.62	26.61	28.54	30.41	32.21	33.92	35.55	37.09	38.52	
8000		26.58	28.53	30.45	32.22	33.80	

Drives falling within the shaded area may be considered noisy and require a sound dampening guard to reduce noise emission.
RPP® PLUS is a trademark of Carlisle Power Transmission Products, Inc.



8 mm RPP® Plus Belt Horsepower Ratings

The following tables represent the horsepower ratings for each belt at the pre-determined No. of Teeth, Pitch Diameters and rpm's. These ratings must be multiplied by the applicable belt length factor to obtain corrected HP rating.

50mm (1.97 in.) wide belt (8M-50)															
No. of Teeth	PD	28	30	32	34	36	38	40	44	48	56	64	72	80	
		mm in.	71.30 2.807	76.39 3.008	81.49 3.208	86.58 3.409	91.67 3.609	96.77 3.810	101.86 4.010	112.05 4.411	122.23 4.812	142.60 5.614	162.97 6.416	183.35 7.218	203.72 8.020
Smallest Sprocket RPM	1160	15.83	17.10	18.37	19.66	20.95	22.25	23.55	26.18	28.84	34.20	39.63	45.11	50.61	
	1460	18.78	20.28	21.79	23.31	24.83	26.37	27.91	31.01	34.13	40.43	46.77	53.13	59.50	
	1750	21.48	23.18	24.90	26.63	28.36	30.11	31.86	35.37	38.90	46.00	53.11	60.20	67.25	
	2900	31.01	33.42	35.83	38.25	40.66	43.07	45.47	50.25	54.99	64.28	73.24	81.77	89.78	
	3500	35.38	38.08	40.78	43.46	46.13	48.78	51.42	56.61	61.70	71.44	80.48	
	10	0.25	0.26	0.28	0.30	0.32	0.34	0.35	0.39	0.42	0.49	0.56	0.63	0.71	
	20	0.49	0.53	0.56	0.60	0.63	0.67	0.71	0.78	0.85	0.99	1.13	1.27	1.41	
	40	0.99	1.06	1.13	1.20	1.27	1.34	1.41	1.55	1.69	1.98	2.26	2.57	2.82	
	60	1.48	1.59	1.69	1.80	1.90	2.01	2.12	2.33	2.54	2.96	3.39	3.81	4.23	
	100	2.47	2.65	2.82	3.00	3.17	3.35	3.53	3.88	4.23	4.94	5.64	6.35	7.05	
	200	4.24	4.59	4.93	5.28	5.62	5.97	6.33	7.04	7.76	9.22	10.71	12.22	13.75	
	300	5.75	6.21	6.68	7.15	7.62	8.10	8.58	9.54	10.52	12.50	14.51	16.56	18.63	
	400	7.14	7.71	8.29	8.87	9.46	10.05	10.64	11.84	13.05	15.50	18.00	20.53	23.10	
	500	8.44	9.11	9.80	10.48	11.18	11.87	12.57	13.99	15.42	18.32	21.27	24.26	27.28	
	600	9.67	10.45	11.23	12.02	12.81	13.61	14.41	16.03	17.67	20.99	24.36	27.78	31.24	
	800	11.99	12.96	13.92	14.90	15.88	16.87	17.87	19.87	21.90	26.00	30.17	34.38	38.64	
	1000	14.17	15.31	16.45	17.60	18.76	19.92	21.10	23.46	25.84	30.67	35.56	40.50	45.48	
	1200	16.23	17.53	18.84	20.16	21.48	22.81	24.15	26.85	29.57	35.06	40.62	46.22	51.85	
	1400	18.21	19.66	21.12	22.60	24.08	25.56	27.06	30.07	33.10	39.22	45.39	51.59	57.80	
	1600	20.10	21.70	23.31	24.93	26.56	28.20	29.84	33.15	36.47	43.17	49.89	56.63	63.34	
	2000	23.69	25.57	27.46	29.35	31.26	33.16	35.08	38.92	42.77	50.48	58.16	65.77	73.27	
	2500	27.87	30.06	32.26	34.46	36.66	38.87	41.08	45.49	49.88	58.60	67.14	75.46	83.48	
	4000	38.74	41.65	44.53	47.39	50.22	53.01	55.77	61.17	66.37	76.06	
	6000	49.69	52.97	56.14	59.17	62.06	64.80	67.36	
	8000	56.32	59.17	
	85mm (3.35 in.) wide belt (8M-85)														
	Smallest Sprocket RPM	1160	34.22	36.47	38.73	41.01	45.59	50.21	59.56	69.01	78.55	88.14
		1460	40.58	43.24	45.91	48.59	53.99	59.43	70.40	81.45	92.54	103.65
1750		46.37	49.39	52.42	55.47	61.59	67.75	80.11	92.51	104.88	117.18	
2900		66.62	70.83	75.03	79.22	87.57	95.85	112.09	127.77	142.72	156.80	
3500		75.73	80.39	85.02	89.62	98.70	107.60	124.67	140.56	
10		0.52	0.55	0.58	0.61	0.68	0.74	0.86	0.98	1.11	1.23	
20		1.04	1.11	1.17	1.23	1.35	1.47	1.72	1.97	2.21	2.46	
40		2.09	2.21	2.33	2.46	2.70	2.95	3.44	3.93	4.42	4.91	
60		3.13	3.32	3.50	3.68	4.05	4.42	5.16	5.90	6.63	7.37	
100		5.22	5.53	5.83	6.14	6.76	7.37	8.60	9.83	11.05	12.28	
200		9.18	9.79	10.40	11.02	12.26	13.51	16.06	18.65	21.28	23.94	
300		12.45	13.27	14.10	14.93	16.61	18.31	21.76	25.27	28.83	32.43	
400		15.44	16.46	17.49	18.52	20.61	22.71	26.99	31.34	35.75	40.22	
500		18.25	19.46	20.67	21.89	24.35	26.84	31.89	37.02	42.23	47.50	
600		20.92	22.30	23.69	25.09	27.91	30.76	36.54	42.42	48.37	54.40	
800		25.94	27.65	29.37	31.11	34.60	38.12	45.27	52.52	59.87	67.28	
1000		30.64	32.66	34.69	36.73	40.84	45.00	53.40	61.92	70.52	79.20	
1200		35.09	37.40	39.72	42.05	46.75	51.48	61.05	70.73	80.49	90.30	
1400		39.34	41.92	44.51	47.12	52.36	57.64	68.30	79.04	89.85	100.67	
1600		43.41	46.25	49.10	51.96	57.72	63.51	75.18	86.90	98.64	110.36	
2000		51.11	54.43	57.75	61.09	67.78	74.49	87.93	101.33	114.62	127.73	
2500		60.01	63.86	67.70	71.55	79.24	86.91	102.12	117.05	131.60	145.65	
4000		82.60	87.54	92.44	97.26	106.71	115.82	132.86	
6000		103.36	108.45	113.29	117.83	
8000		

Drives falling within the shaded area may be considered noisy and require a sound dampening guard to reduce noise emission.
RPP® PLUS is a trademark of Carlisle Power Transmission Products, Inc.

14 mm RPP® Plus Belt Horsepower Ratings



The following tables represent the horsepower ratings for each belt at the pre-determined No. of Teeth, Pitch Diameters and rpm's. These ratings must be multiplied by the applicable belt length factor to obtain corrected HP rating.

		40mm (1.57 in.) wide belt (14M-40)																	
No. of Teeth	PD	28	29	30	32	34	36	38	40	44	48	52	56	60	64	68	72	80	
		mm in.	4.912	5.088	5.263	5.614	5.965	6.316	6.667	7.018	7.720	8.421	9.123	9.825	10.527	11.229	11.930	12.632	14.036
Smallest Sprocket RPM	1160	28.94	30.14	31.36	33.80	36.26	38.73	41.23	43.74	48.79	53.89	59.01	64.16	69.31	74.47	79.63	84.77	94.99	
	1460	34.19	35.60	37.02	39.86	42.73	45.61	48.50	51.40	57.21	63.04	68.85	74.65	80.42	86.13	91.78	97.37	108.26	
	1750	38.88	40.47	42.06	45.24	48.44	51.65	54.85	58.05	64.44	70.79	77.07	83.26	89.34	95.29	101.10	106.74	117.43	
	2900	54.18	56.21	58.22	62.19	66.09	69.89	73.60	77.19	84.01	90.26	
	3500	60.06	62.14	64.18	68.14	71.93	75.53	78.93	82.10
	10	0.53	0.54	0.56	0.60	0.64	0.68	0.71	0.75	0.83	0.90	0.98	1.05	1.13	1.20	1.28	1.35	1.50	
	20	1.05	1.09	1.13	1.20	1.28	1.35	1.43	1.50	1.65	1.80	1.95	2.10	2.25	2.40	2.55	2.70	3.00	
	40	2.10	2.18	2.25	2.40	2.55	2.70	2.85	3.00	3.30	3.60	3.90	4.21	4.51	4.81	5.11	5.41	6.01	
	60	3.15	3.27	3.38	3.60	3.83	4.06	4.28	4.51	4.96	5.41	5.86	6.31	6.76	7.21	7.66	8.11	9.01	
	100	4.64	4.84	5.04	5.43	5.84	6.25	6.66	7.07	7.91	8.77	9.64	10.51	11.26	12.01	12.76	13.51	15.02	
	200	7.81	8.14	8.47	9.14	9.82	10.50	11.19	11.89	13.31	14.74	16.20	17.68	19.18	20.70	22.23	23.78	26.92	
	300	10.58	11.03	11.48	12.38	13.30	14.23	15.16	16.11	18.02	19.97	21.94	23.95	25.97	28.02	30.09	32.18	36.43	
	400	13.12	13.68	14.23	15.36	16.49	17.64	18.80	19.97	22.35	24.75	27.20	29.67	32.18	34.71	37.27	39.85	45.09	
	500	15.50	16.16	16.82	18.14	19.49	20.84	22.21	23.59	26.39	29.23	32.10	35.02	37.96	40.94	43.95	46.98	53.12	
	600	17.76	18.51	19.27	20.79	22.32	23.87	25.44	27.01	30.21	33.45	36.73	40.06	43.41	46.80	50.22	53.67	60.64	
	800	22.00	22.93	23.86	25.73	27.63	29.54	31.46	33.41	37.33	41.31	45.33	49.39	53.49	57.62	61.77	65.94	74.35	
	1000	25.95	27.04	28.13	30.33	32.55	34.79	37.04	39.31	43.89	48.52	53.19	57.90	62.62	67.37	72.13	76.90	86.44	
	1200	29.66	30.90	32.14	34.64	37.15	39.69	42.24	44.81	49.97	55.17	60.40	65.65	70.90	76.15	81.39	86.61	96.97	
	1400	33.17	34.54	35.92	38.69	41.48	44.29	47.10	49.93	55.60	61.30	66.99	72.68	78.34	83.97	89.55	95.08	105.91	
	1600	36.50	38.00	39.50	42.52	45.55	48.59	51.64	54.70	60.81	66.91	72.98	79.00	84.95	90.82	96.59	102.25	113.16	
1800	39.65	41.27	42.89	46.13	49.38	52.63	55.88	59.13	65.60	72.02	78.35	84.59	90.69	96.66	102.45	108.06	...		
2000	42.65	44.37	46.08	49.52	52.96	56.39	59.81	63.22	69.96	76.60	83.09	89.42	95.54	101.43	107.07		
2500	49.45	51.37	53.29	57.10	60.87	64.60	68.28	71.90	78.94	85.66	92.01	97.94		
3000	55.26	57.31	59.34	63.33	67.23	71.03	74.71	78.27	84.96		
4000	63.77	65.78	67.72	71.41	74.82		
		55mm (2.17 in.) wide belt (14M-55)																	
Smallest Sprocket RPM	1160	42.33	44.09	45.87	49.44	53.05	56.68	60.33	64.01	71.42	78.89	86.41	93.97	101.54	109.13	116.72	124.30	139.38	
	1460	50.02	52.09	54.17	58.34	62.55	66.77	71.01	75.26	83.81	92.37	100.94	109.48	117.99	126.43	134.80	143.07	159.27	
	1750	56.92	59.24	61.58	66.26	70.95	75.66	80.37	85.09	94.50	103.86	113.14	122.31	131.34	140.20	148.86	157.30	173.40	
	2900	79.55	82.55	85.53	91.42	97.22	102.89	108.43	113.83	124.12	133.64	
	3500	88.40	91.50	94.55	100.49	106.21	111.67	116.86	121.74
	10	0.77	0.80	0.82	0.88	0.93	0.99	1.04	1.10	1.21	1.32	1.43	1.54	1.65	1.76	1.87	1.98	2.20	
	20	1.54	1.59	1.65	1.76	1.87	1.98	2.09	2.20	2.42	2.63	2.85	3.07	3.29	3.51	3.73	3.95	4.39	
	40	3.07	3.18	3.29	3.51	3.73	3.95	4.17	4.39	4.83	5.27	5.71	6.15	6.59	7.03	7.47	7.90	8.78	
	60	4.61	4.78	4.94	5.27	5.60	5.93	6.26	6.59	7.25	7.90	8.56	9.22	9.88	10.54	11.20	11.86	13.17	
	100	6.79	7.07	7.36	7.95	8.54	9.13	9.73	10.34	11.57	12.82	14.09	15.37	16.47	17.56	18.66	19.76	21.95	
	200	11.41	11.90	12.38	13.36	14.35	15.35	16.36	17.38	19.45	21.55	23.69	25.85	28.04	30.26	32.50	34.76	39.36	
	300	15.47	16.12	16.78	18.10	19.45	20.80	22.17	23.55	26.35	29.20	32.08	35.01	37.97	40.97	44.00	47.06	53.27	
	400	19.18	19.99	20.81	22.45	24.12	25.80	27.49	29.20	32.67	36.20	39.77	43.39	47.05	50.76	54.50	58.28	65.94	
	500	22.67	23.63	24.59	26.53	28.49	30.47	32.48	34.49	38.58	42.74	46.95	51.21	55.52	59.88	64.28	68.72	77.70	
	600	25.98	27.07	28.17	30.39	32.64	34.91	37.19	39.50	44.18	48.92	53.72	58.59	63.50	68.46	73.47	78.52	88.72	
	800	32.18	33.53	34.89	37.63	40.40	43.20	46.02	48.86	54.61	60.43	66.32	72.27	78.27	84.32	90.41	96.53	108.86	
	1000	37.95	39.54	41.14	44.36	47.61	50.89	54.19	57.51	64.23	71.01	77.86	84.75	91.69	98.66	105.65	112.66	126.70	
	1200	43.39	45.20	47.02	50.67	54.36	58.08	61.81	65.57	73.15	80.78	88.46	96.17	103.89	111.61	119.33	127.03	142.33	
	1400	48.53	50.54	52.56	56.62	60.71	64.82	68.96	73.10	81.44	89.81	98.19	106.56	114.91	123.22	131.47	139.64	155.71	
	1600	53.42	55.61	57.82	62.25	66.70	71.16	75.64	80.13	89.13	98.11	107.06	115.95	124.75	133.45	142.02	150.44	166.75	
1800	58.06	60.42	62.80	67.56	72.33	77.11	81.90	86.68	96.22	105.69	115.06	124.30	133.38	142.27	150.93	159.34	...		
2000	62.46	64.99	67.51	72.57	77.62	82.68	87.72	92.74	102.71	112.54	122.18	131.60	140.75	149.60	158.10		
2500	72.51	75.34	78.17	83.79	89.38	94.90	100.36	105.74	116.24	126.32	135.89	144.90		
3000	81.17	84.20	87.20	93.14	98.95	104.63	110.15	115.51	125.65		
4000	94.11	97.14	100.09	105.71	110.96	

Drives falling within the shaded area may be considered noisy and require a sound dampening guard to reduce noise emission.
RPP® PLUS is a trademark of Carlisle Power Transmission Products, Inc.



14 mm RPP® Plus Belt Horsepower Ratings

The following tables represent the horsepower ratings for each belt at the pre-determined No. of Teeth, Pitch Diameters and rpm's. These ratings must be multiplied by the applicable belt length factor to obtain corrected HP rating.

		85mm (3.35 in.) wide belt (14M-85)																	
No. of Teeth	PD	28	29	30	32	34	36	38	40	44	48	52	56	60	64	68	72	80	
		mm in.	124.78 4.912	129.23 5.088	133.69 5.263	142.60 5.614	151.51 5.965	160.43 6.316	169.34 6.667	178.25 7.018	196.08 7.720	213.90 8.421	231.73 9.123	249.55 9.825	267.38 10.527	285.21 11.229	303.03 11.930	320.86 12.632	356.51 14.036
Smallest Sprocket RPM	1160	69.08	71.96	74.86	80.70	86.59	92.52	98.49	104.50	116.62	128.84	141.15	153.52	165.94	178.38	190.82	203.26	228.05	
	1460	81.66	85.05	88.44	95.27	102.14	109.04	115.98	122.95	136.94	150.98	165.03	179.06	193.04	206.94	220.73	234.38	261.18	
	1750	92.95	96.76	100.57	108.24	115.93	123.64	131.37	139.10	154.55	169.93	185.21	200.33	215.24	229.90	244.26	258.30	285.20	
	2900	130.22	135.17	140.08	149.82	159.40	168.81	178.02	187.01	204.23	220.30	
	3500	145.00	150.14	155.22	165.13	174.69	183.87	192.62	200.91
	10	1.25	1.30	1.34	1.43	1.52	1.61	1.70	1.79	1.97	2.15	2.33	2.51	2.69	2.87	3.04	3.22	3.58	
	20	2.51	2.60	2.69	2.87	3.04	3.22	3.40	3.58	3.94	4.30	4.66	5.01	5.37	5.73	6.09	6.45	7.16	
	40	5.01	5.19	5.37	5.73	6.09	6.45	6.81	7.16	7.88	8.60	9.31	10.03	10.75	11.46	12.18	12.90	14.33	
	60	7.52	7.79	8.06	8.60	9.13	9.67	10.21	10.75	11.82	12.90	13.97	15.04	16.12	17.19	18.27	19.34	21.49	
	100	11.07	11.54	12.01	12.96	13.92	14.89	15.88	16.87	18.87	20.91	22.99	25.07	26.86	28.65	30.44	32.23	35.81	
	200	18.62	19.41	20.20	21.80	23.41	25.05	26.69	28.36	31.73	35.16	38.64	42.17	45.75	49.36	53.02	56.72	64.21	
	300	25.23	26.30	27.37	29.54	31.72	33.94	36.17	38.42	42.99	47.63	52.34	57.12	61.95	66.84	71.79	76.78	86.91	
	400	31.30	32.62	33.95	36.63	39.34	42.09	44.85	47.65	53.30	59.05	64.88	70.79	76.77	82.82	88.93	95.10	107.60	
	500	36.98	38.54	40.11	43.28	46.48	49.72	52.98	56.28	62.95	69.73	76.60	83.56	90.59	97.71	104.89	112.14	126.81	
	600	42.38	44.16	45.96	49.59	53.25	56.95	60.69	64.45	72.08	79.82	87.67	95.60	103.63	111.73	119.91	128.16	144.83	
	800	52.50	54.71	56.93	61.41	65.93	70.49	75.10	79.74	89.12	98.63	108.25	117.97	127.78	137.67	147.62	157.63	177.80	
	1000	61.93	64.53	67.14	72.40	77.70	83.05	88.45	93.88	104.85	115.94	127.13	138.41	149.76	161.17	172.62	184.10	207.12	
	1200	70.81	73.77	76.74	82.71	88.74	94.81	100.92	107.07	119.45	131.95	144.51	157.14	169.79	182.46	195.13	207.77	232.93	
	1400	79.23	82.51	85.81	92.45	99.13	105.86	112.62	119.41	133.05	146.76	160.50	174.24	187.96	201.62	215.19	228.67	255.20	
	1600	87.21	90.81	94.41	101.66	108.94	116.25	123.59	130.95	145.69	160.43	175.13	189.75	204.26	218.61	232.77	246.71	273.79	
1800	94.82	98.69	102.57	110.37	118.19	126.03	133.87	141.72	157.38	172.96	188.40	203.65	218.65	233.37	247.76	261.77	...		
2000	102.05	106.18	110.31	118.60	126.90	135.19	143.47	151.72	168.13	184.34	200.27	215.87	231.08	245.82	260.05		
2500	118.58	123.23	127.87	137.13	146.32	155.43	164.45	173.35	190.76	207.53	223.55	238.70		
3000	132.91	137.91	142.87	152.69	162.32	171.75	180.95	189.89	206.92		
4000	154.72	159.79	164.73	174.23	183.15	
		115mm (4.53 in.) wide belt (14M-115)																	
Smallest Sprocket RPM	1160	95.83	9.83	103.86	111.96	120.13	128.36	136.65	144.99	161.82	178.79	195.89	213.08	230.33	247.62	264.93	282.23	316.71	
	1460	113.30	118.00	122.71	132.19	141.73	151.32	160.96	170.64	190.08	209.59	229.13	248.65	268.10	287.45	306.66	325.69	363.08	
	1750	128.98	134.27	139.57	150.21	160.90	171.62	182.36	193.10	214.59	236.01	257.28	278.34	299.13	319.60	339.67	359.29	396.99	
	2900	180.90	187.78	194.64	208.21	221.59	234.73	247.61	260.19	284.35	306.95	
	3500	201.60	208.79	215.89	229.76	243.17	256.06	268.39	280.09
	10	1.74	1.80	1.86	1.99	2.11	2.24	2.36	2.48	2.73	2.98	3.23	3.48	3.73	3.97	4.22	4.47	4.97	
	20	3.48	3.60	3.73	3.97	4.22	4.47	4.72	4.97	5.47	5.96	6.46	6.96	7.45	7.95	8.45	8.94	9.94	
	40	6.96	7.20	7.45	7.95	8.45	8.94	9.44	9.94	10.93	11.92	12.92	13.91	14.90	15.90	16.89	17.89	19.87	
	60	10.43	10.81	11.18	11.92	12.67	13.41	14.16	14.90	16.40	17.89	19.38	20.87	22.36	23.85	25.34	26.83	29.81	
	100	15.36	16.01	16.66	17.98	19.31	20.66	22.02	23.39	26.18	29.01	31.88	34.77	37.26	39.74	42.22	44.71	49.67	
	200	25.83	26.92	28.02	30.23	32.47	34.74	37.03	39.34	44.02	48.77	53.90	58.49	63.45	68.47	73.54	78.67	89.06	
	300	35.00	36.48	37.93	40.97	44.00	47.07	50.17	53.29	59.63	66.07	72.60	79.23	85.93	92.71	99.57	106.50	120.55	
	400	43.41	45.24	47.09	50.81	54.57	58.37	62.21	66.09	73.94	81.91	90.00	98.19	106.49	114.88	123.35	131.91	149.26	
	500	51.30	53.46	55.64	60.03	64.47	68.96	73.49	78.06	87.32	96.72	106.25	115.90	125.67	135.54	145.50	155.56	175.93	
	600	58.78	61.26	63.75	68.78	73.86	79.00	84.18	89.40	99.99	110.73	121.61	132.62	143.76	155.01	166.35	177.80	200.94	
	800	72.83	75.89	78.97	85.18	91.45	97.78	104.17	110.61	123.64	136.83	150.19	163.68	177.29	191.01	204.83	218.73	246.75	
	1000	85.91	89.52	93.14	100.43	107.79	115.22	122.70	130.24	145.47	160.86	176.40	192.07	207.83	223.68	239.59	255.55	287.54	
	1200	98.24	102.34	106.46	114.75	123.12	131.54	140.03	148.56	165.76	183.11	200.57	218.11	235.70	253.31	270.93	288.52	323.53	
	1400	109.92	114.48	119.06	128.27	137.56	146.89	156.28	165.71	184.66	203.72	222.82	241.93	261.00	280.01	298.92	317.69	354.70	
	1600	121.01	126.00	131.01	141.07	151.18	161.34	171.54	181.76	202.25	222.75	243.21	263.56	283.76	303.77	323.52	342.98	380.84	
1800	131.58	136.96	142.35	153.18	164.05	174.94	185.58	196.76	218.55	240.23	261.73	282.99	303.93	324.48	344.60	364.21	...		
2000	141.63	147.37	153.12	164.64	176.17	187.70	199.22	210.71	233.55	256.13	278.36	300.15	321.40	342.04	361.99		
2500	164.64	171.12	177.58	190.46	203.26	215.96	228.53	240.96	265.27	288.74	311.20	332.50		
3000	184.66	191.62	198.55	212.24	225.69	238.87	251.75	264.28	288.19		
4000	215.32	222.44	229.38	242.74	255.33	

Drives falling within the shaded area may be considered noisy and require a sound dampening guard to reduce noise emission.
RPP® Plus is a trademarks of Carlisle Power Transmission Products, Inc.

14 mm RPP® Plus Belt Horsepower Ratings



The following tables represent the horsepower ratings for each belt at the pre-determined No. of Teeth, Pitch Diameters and rpm's. These ratings must be multiplied by the applicable belt length factor to obtain corrected HP rating.

		170mm (6.69 in.) wide belt (14M-170)											
No. of Teeth		36	38	40	44	48	52	56	60	64	68	72	80
	PD	mm	160.43	169.34	178.25	196.08	213.90	231.73	249.55	267.38	285.21	303.03	320.86
	in.	6.316	6.667	7.018	7.720	8.421	9.123	9.825	10.527	11.229	11.930	12.632	14.036
Smallest Sprocket RPM	1160	194.06	206.60	219.22	244.67	270.36	296.23	322.25	348.37	374.56	400.77	426.98	479.26
	1460	228.82	243.40	258.05	287.48	317.03	346.62	376.20	405.69	435.04	464.19	493.08	549.88
	1750	259.57	275.83	292.11	324.67	357.13	389.39	421.35	452.93	484.03	514.56	544.44	601.92
	2900	355.58	375.18	394.35	431.21	465.80
	3500	388.41	407.28	425.24
	10	3.38	3.57	3.75	4.13	4.51	4.88	5.26	5.63	6.01	6.38	6.76	7.51
	20	6.76	7.13	7.51	8.26	9.01	9.76	10.51	11.26	12.02	12.77	13.52	15.02
	40	13.52	14.27	15.02	16.52	18.02	19.52	21.03	22.53	24.03	25.53	27.03	30.04
	60	20.28	21.40	22.53	24.78	27.03	29.29	31.54	33.79	36.04	38.30	40.55	45.05
	100	31.23	33.28	35.36	39.57	43.85	48.19	52.56	56.32	60.07	63.82	67.58	75.08
	200	52.51	55.96	59.46	66.53	72.72	81.02	88.42	95.91	103.49	111.16	118.90	134.62
	300	71.15	75.83	80.55	90.13	99.86	109.74	119.75	129.89	140.14	150.51	160.98	182.22
	400	88.23	94.04	99.89	111.76	123.81	136.04	148.43	160.97	173.65	186.46	199.40	225.62
	500	104.24	111.09	118.00	131.99	146.20	160.61	175.20	189.96	204.89	219.95	235.16	265.95
	600	119.41	127.24	135.14	151.14	167.38	183.83	200.48	217.32	234.33	251.49	268.79	303.79
	800	147.82	157.47	167.21	186.90	206.86	227.05	247.46	268.05	288.81	309.71	330.75	373.14
	1000	174.18	185.50	196.90	219.93	243.22	266.73	290.43	314.28	338.27	362.35	386.51	434.96
	1200	198.88	211.71	224.62	250.65	276.90	303.32	329.87	356.51	383.19	409.88	436.53	489.62
	1400	222.11	236.32	250.58	279.28	308.12	337.05	366.00	394.91	423.73	452.41	480.89	537.08
	1600	244.00	259.43	274.91	305.94	337.00	368.00	398.86	429.51	459.87	489.88	519.46	577.07
	1800	264.60	281.12	297.65	330.67	363.55	396.17	428.44	460.24	491.50	522.11	551.99	...
	2000	283.96	301.41	318.83	353.48	387.75	421.51	454.63	486.98	518.43	548.87
	2500	326.92	346.01	364.89	401.86	437.61	471.88	504.45
	3000	361.91	381.53	400.64	437.17
	4000

Drives falling within the shaded area may be considered noisy and require a sound dampening guard to reduce noise emission.
RPP® Plus is a trademarks of Carlisle Power Transmission Products, Inc.

SPROCKET DIAMETER AND SPEED

Drives that you'll find in the Belt Width Selection Tables on pages K-94 through K-149, use diameters that may reduce belt life. Amount of reduction will depend on speed. The higher the speed, the more reduction. Drives are included for use where speed ratio or space requirements have to be met.

Blank spaces in the lower right-hand portions of the Belt Width Selections Tables are evident because sprocket rim speed is greater than 6,500 feet per minute. Beyond this speed, centrifugal forces may prohibit safe use of stock grey cast iron sprockets. For rim speeds that exceed 6,500 feet per minute, contact *Martin* for other solutions.

USE OF FLANGED SPROCKETS

Guide flanges are necessary to keep the belt on the sprocket. Due to tracking characteristics, even on the best aligned drives, belts can ride off the edge of sprockets. Flanges can prevent this ride-off. On all drives using stock or made-to-order sprockets, you should check the following conditions when selecting flanged sprockets:

1. On all HTS sprocket drives using two sprockets, minimum flanging calls for two flanges on one sprocket or one flange on each sprocket's opposite side.
2. On drives where the center distance is more than eight times the small sprocket diameters, both sides of the sprockets should be flanged.
3. On vertical shaft drives, one sprocket should be flanged on both sides. All other system sprockets should be flanged bottom side only.
4. All drives with more than two sprockets, minimum flanging calls for two flanges on every other sprocket, or one flange on every sprocket at alternating sides.

On made-to-order sprockets, flanges should be securely fastened. Use welding, shrink fit, mechanical fasteners, or other accepted methods.

Recommended minimum flange dimensions are shown here:

Flange Dimensions (In.)

Belt Section	Nominal Flange Thickness	Nominal Flange Height*
8mm	$\frac{3}{32}$	$\frac{21}{64}$
14mm	$\frac{1}{8}$	$\frac{5}{8}$

*Consult factory for exact dimensions.

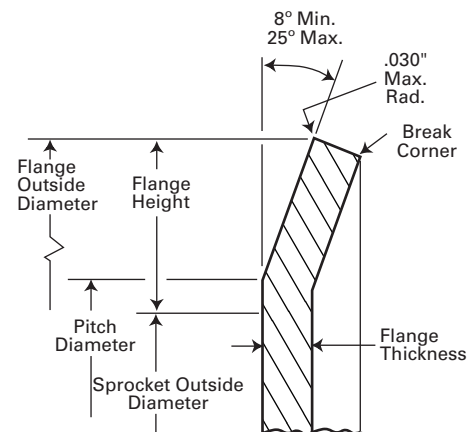

This nomograph shows the maximum speed limit (in rpm) for a standard statically balanced sprocket of a given diameter and face width. To use, lay a straight edge between diameter and face width. Read maximum rpm recommended for standard balance where edge crosses slanted line. For faster speeds, dynamic balancing is recommended.

Example: If a 20 in. diameter × 10 in. (230 mm) face width sprocket runs faster than 1100 rpm, dynamic balancing is recommended.

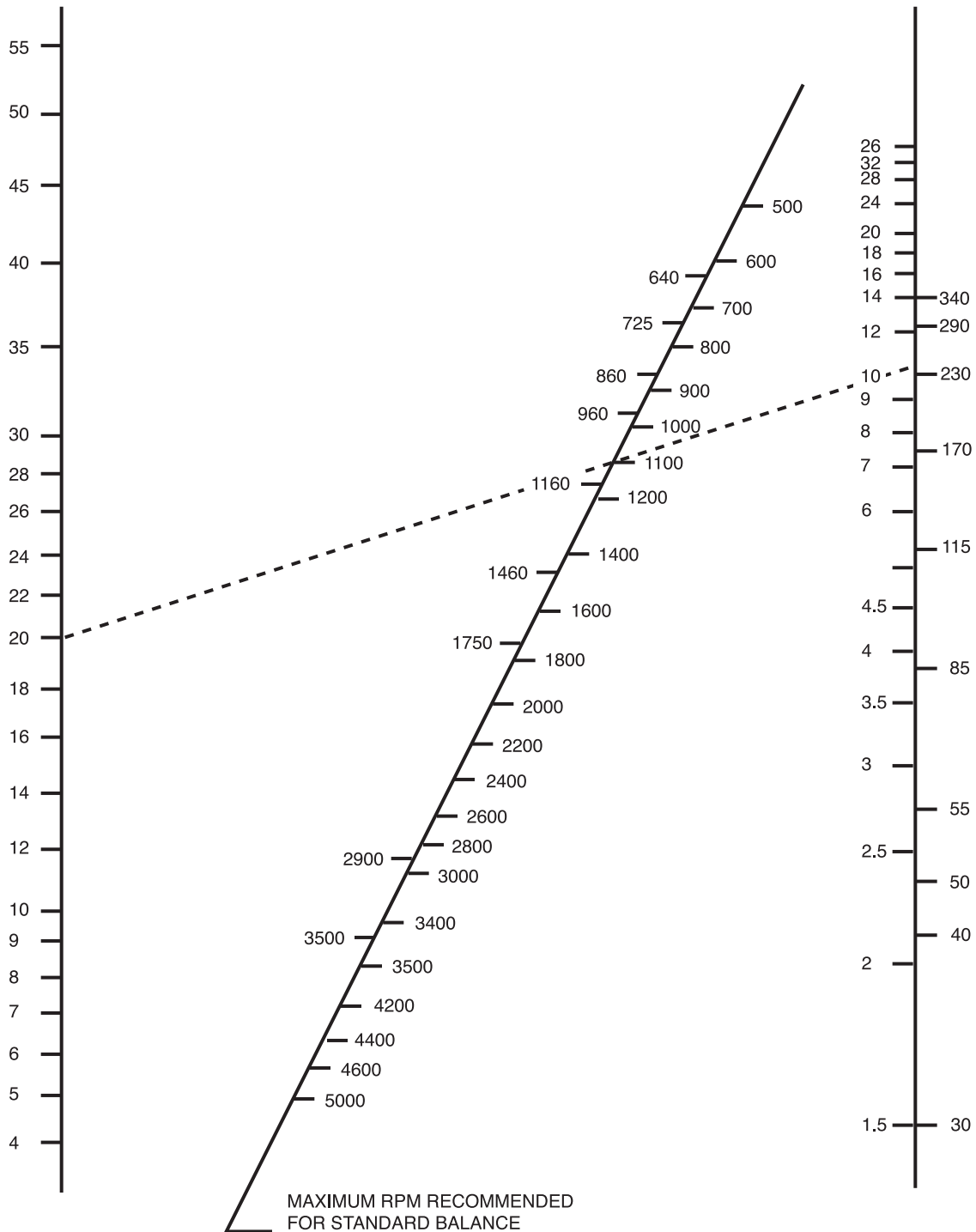

PULLEYS

WARNING: When belt speeds exceed 6500 feet per minute, special materials must be used; consult *Martin* for special design requirements.

FIXED (NON-ADJUSTABLE) CENTERS

Positive belt applications with fixed centers are not recommended for any drive other than low or no torque drives (other than motion transfer). Fixed center refers to enacting tolerances. Positive belt length tolerances are usually less than that found in other applications. It is a fact that no belt can be manufactured without some tolerance. There are basic geometric tolerances involved with fixed center drives. There is no allowance for proper tensioning and accepted maintenance procedures cannot be utilized.

Because proper tensioning procedures cannot be followed, improper belt tension can result in reduced performance. By using inside idlers, many of these potential problems can be corrected.

IDLERS

Only use idlers as a necessary function...as a means to apply tension when centers are not adjustable. They should be installed on the belt drive's slack side. For inside idlers, grooved sprockets are recommended up to 40 grooves. On larger diameters, flat, uncrowned idlers can be used. Inside idler diameters should not be smaller than the smallest loaded sprocket in the system. Outside or backside idlers should be flat and uncrowned. Flanges are also recommended with diameters that are not smaller than $\frac{1}{3}$ times the smallest loaded sprocket in the system.

Hold to a minimum the idler arc of contact. All idlers have to be securely locked in place during start-up and operation.

For positive belt applications, in most cases, the use of spring-loaded idlers is not recommended. A positive belt can generate sufficient tension to overcome any reasonable force imposed by a spring-loaded idler. You get belt ratcheting in this situation because the idler is not effective. Any strong spring force that imposes artificially high belt tension could be excessive, reducing belt life. Your one exception, a motion transfer application.

CENTER DISTANCE AND BELT LENGTH

To closely estimate a tentative center distance, consider equal to the large sprocket diameter, or $\frac{1}{2}(D+3d)$, whichever is larger. You can then select a tentative belt length by solving any one of the following formulas:

Formula 1

$$\text{Tentative Belt Length} = 1.57 (D + d) + (\text{Tentative Center Distance} \times 2)$$

Where: D = diameter of large sprocket

d = diameter of small sprocket

Formula 2

$$L_p = 2C + 1.57 (D + d) + \frac{(D - d)^2}{4C}$$

Where: L_p = belt length, inches
 D = diameter of large sprocket, inches
 d = diameter of small sprocket, inches
 C = center distance, inches

Formula 3

$$L_p = 2C = \cos \phi + \frac{\pi (D + d)}{2} + \frac{\pi \phi (D - d)}{180}$$

Where: L_p = pitch length of belt, inches
 C = center distance, inches
 D = diameter of large sprocket, inches
 d = diameter of small sprocket, inches

Formula 4

$$C = \frac{K + \sqrt{K^2 - 32 (D - d)^2}}{16}$$

Where: $K = 4L_p - 6.28 (D + d)$

TEETH IN MESH

Standard horsepower ratings in this catalog are based on a minimum of six teeth in mesh between the sprocket and the belt. If there are less than six teeth in mesh, your ratings must be corrected for excessive tooth loading (see correction factor table below). For non-stock drives not listed in the Drive Selection Tables, the teeth in mesh can be calculated by using this formula:

Formula 5

$$\text{Teeth in Mesh} = \left[0.5 - \left(\frac{D - d}{6C} \right) \right] N_g$$

Where: D = pitch diameter, large sprocket, inches
 d = pitch diameter, small sprocket, inches
 C = center distance, inches
 N_g = number of grooves in small sprocket

Teeth in Mesh Correction Factor

Teeth in Mesh	Factor K_{tm}
6 or more	1.00
5	.80
4	.60
3	.40
2	.20

DRIVE ALIGNMENT

To assure proper drive alignment, you should refer to the information in this section for center distance alignment. The alternative is to change the idler position, so that the belt can be slipped onto the drive easily. When you install the belt, never force it over the flange. This may cause belt tensile damage.

Positive belts are most sensitive to misalignment, so never use this kind of drive in applications where misalignment is prevalent. Inconsistent belt wear and premature tensile failure may result.

The two most common types of misalignment can be seen in the drawings below. Parallel misalignment is caused when the driver and driven shafts are parallel, but the two sprockets lie in different planes. When the two shafts are not parallel, the drive is angularly misaligned.

A fleeting angle (shown here) shows where the belt enters and exits the sprocket, and equals the sum of the parallel and angular misalignments.

Any degree of sprocket misalignment will result in some belt life reduction. Misalignment of all positive belt drives should not exceed $\frac{1}{4}$ " or $\frac{1}{16}$ " per foot of center distance. Alignment should be checked with a good straight-edge tool applied to their machined side surfaces from driver to driven and from driven to driver shafts. This way the effect of parallel and angular misalignment can be observed.

Drive misalignment can also cause problems of belt tracking. Some tracking is normal and will not affect performance.

However, where center distance is greater than eight times the small sprocket diameter, tracking can be a problem. Special adjustment may be needed. You have to correct the parallel position of the two sprockets until one flange guides the belt in the system and the belt tracks fully on all sprockets. Regardless of the drive's center distance, the best operation will be with the belt contacting only one flange in the system.

You will find the real application problem when the belt contacts flanges on opposite sides of the sprockets. This traps the belt into undesirable parallel misalignment.

Improper bushing installation can result in the entire bushing/sprocket assembly to be "cocked" on the shaft. This leads to angular misalignment. Be sure to follow *Martin*'s bushing installation instructions.

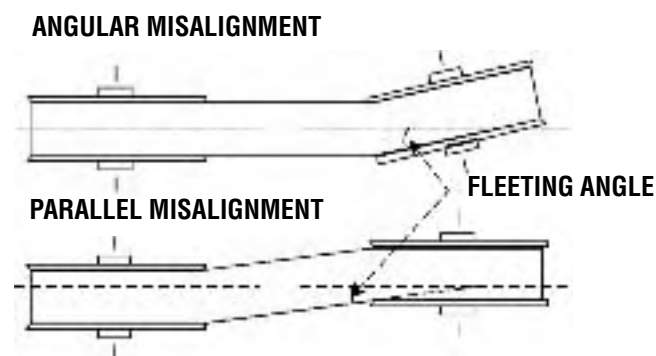

INSTALLATION AND TENSIONING ALLOWANCES

We do not recommend fixed center drives. To avoid belt damage and excessive wear, refer to the Distance Allowance Charts (Page K-168). The standard installation allowance is the minimum decrease in the center distance required to install a belt when flanged sprockets are removed from their shafts for belt installation. The charts first column spells this out with more comprehensive information needed for the minimum increase in center distance required for a belt's tension during its normal life.

If a belt is to be installed over flanged sprockets without removing them, the additional installation center distance allowances shown in the second table must be added to the first table data.

Distance Allowance Chart

Belt Length (in.)	*Standard Installation Allowance	Tensioning Allowance (Any Drive)
20 and under	0.04"	0.03"
Over 20 to 40	0.05"	0.03"
Over 40 to 60	0.07"	0.04"
Over 60 to 90	0.09"	0.05"
Over 90 to 120	0.11"	0.05"
Over 120 to 160	0.14"	0.05"
Over 160 to 190	0.17"	0.05"
Over 190 to 260	0.21"	0.05"

* Flanged Sprockets Removed for Installation.

HTS BELT TENSIONING AND DEFLECTION FORCE

Lay the belt on the sprockets, adjusting the takeup, so that the belt teeth mesh securely with sprocket grooves. Measure the belt span "t." Then tighten the belt, so that it deflects $\frac{1}{64}$ " for each inch of belt span when a force is applied. (See Table below.)

Example: A 14mm pitch belt, 85mm wide, with a span of 30" and a maximum force of 28 lbs. applied, should deflect $\frac{30}{64}$ inch. Deflection $\frac{1}{64}$ per inch of span. (Measure the span length "t" as shown in the sketch below.)

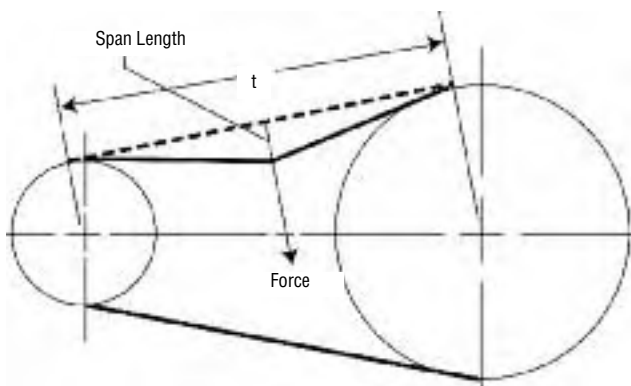

$$t = \sqrt{C^2 - \left(\frac{D-d}{2}\right)^2}$$

These ranges of deflection forces are applicable for drive installation. Actual operation tension depends on the number of teeth mesh, system rigidity, peak loads, etc.

Belt Pitch	Belt Width	Force*
5mm	9mm	9 to 18 oz.
	15mm	1 to 2 lbs.
	25mm	1-1/2 to 3 lbs.
8mm	20mm	3 to 4 lbs.
	30mm	5 to 6-1/2 lbs.
	50mm	9 to 12 lbs.
	85mm	16 to 20 lbs.
14mm	40 mm	10 to 13 lbs.
	55mm	15 to 18 lbs.
	85 mm	23 to 28 lbs.
	115mm	32 to 39 lbs.
20mm	170mm	48 to 57 lbs.
	115mm	45 to 55 lbs.
	170mm	70 to 85 lbs.
	230mm	95 to 120 lbs.
	290mm	120 to 150 lbs.
	340mm	145 to 180 lbs.

*Force applies to speeds exceeding 600 rpm.

NOTE: For belts wider than 2", you can avoid belt distortion by placing a $\frac{3}{4}$ " or 1" metal strip across the belt between belt and tension tester.



MPC™ and High HP HTS® Sprockets

MPC Synchronous Sprockets

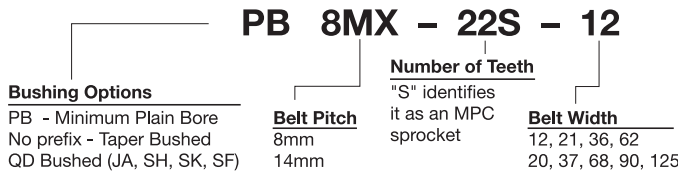

MPC Synchronous Sprockets run with Poly Chain® GT®2 and Falcon Pd™ belts.

MPC Synchronous Sprockets - available in your desired configuration.

- Available in 8mm and 14mm pitches
 - Belt widths:
 - 12mm, 21mm, 36mm, 62mm (8mm pitch)
 - 20mm, 37mm, 68mm, 90mm, 125mm (14mm pitch)
 - Available in QD, TB or other special adapters.
 - Special diameters and widths, as well as special materials, are also available.

Introducing our newest synchronous sprocket.

Whether it's Poly Chain® GT®2 or Falcon Pd™ we will make the sprocket to complete your drives. The addition of our MPC sprocket line makes *Martin* your one stop shop for all your synchronous sprocket needs. Match your sprocket to your favorite belt.

High HP HTS Synchronous Sprockets

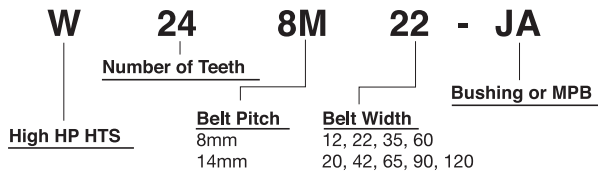

“W” High HP HTS Sprockets (RPP® Tooth Profile) – Run with Hawk Pd™, Panther®, QT Power Chain™ belts.

“W” High HP HTS Sprockets are designed to run with latest design, higher horsepower belts.

Martin's High HP HTS Sprockets are designed to run with today's highest horsepower RPP® profile belts.

High HP HTS Synchronous Sprockets allow you more flexibility in your selection criteria. The expanded line allows you to fit the application with the most cost effective sprockets.

- Available in 8mm and 14mm pitches
- Belt widths: 12mm, 22mm, 35mm, 60mm (8mm pitch)
20mm, 42mm, 65mm, 90mm, 120mm (14mm pitch)
Available in QD, TB or MPB styles from stock.
- Typical Part Number: W248M22-JA

High HP HTS® Sprockets 8mm



Type A

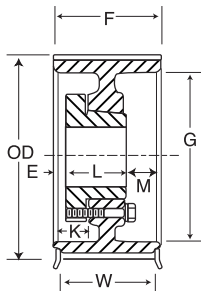

Type AF

Type C

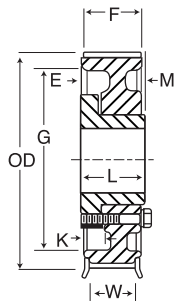

Type CF

Type D

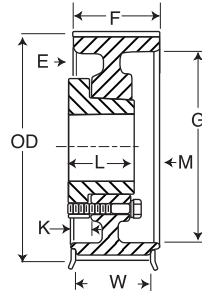

Type DF

Type E•

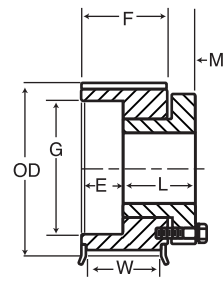

Type EF•

8mm Pitch, 12 mm (.47 in.) Wide Belts (8M-12)

No. of Teeth	Catalog Number	Bore	Pitch	Diameter (in.)		Type +	Max. Bore	Dimensions (in.)								Weight* Approx. (lbs)
				O.D.	Flange			E	L	M	K	H	F	G	W	
22	W228M12-MPB	MPB	2.206	2.154	2.562	MPB	1.188	0.623	1.452	1.620	0.827	...	0.577	1.0
24	W248M12-JA	JA	2.406	2.354	2.750	E1F•	1.250	0.265	1.063	0.500	0.000	...	0.827	1.340	0.577	0.5
26	W268M12-JA	JA	2.607	2.554	2.937	E1F•	1.250	0.265	1.063	0.500	0.000	...	0.827	1.340	0.577	0.6
28	W288M12-H	H	2.807	2.755	3.156	E1F•	1.500	-0.048	1.250	0.375	0.000	...	0.827	1.570	0.577	0.7
30	W308M12-H	H	3.008	2.955	3.344	E1F•	1.500	-0.048	1.250	0.375	0.000	...	0.827	1.570	0.577	0.9
32	W328M12-H	H	3.208	3.155	3.562	E1F•	1.500	-0.048	1.250	0.375	0.000	...	0.827	1.570	0.577	1.1
34	W348M12-SH	SH	3.409	3.355	3.750	D1F	1.688	0.500	1.313	0.014	0.000	...	0.827	2.750	0.577	1.1
36	W368M12-SH	SH	3.609	3.556	3.937	D1F	1.688	0.500	1.313	0.014	0.000	...	0.827	2.820	0.577	1.3
38	W388M12-SH	SH	3.810	3.756	4.156	D1F	1.688	0.500	1.313	0.014	0.000	...	0.827	3.000	0.577	1.6
40	W408M12-SH	SH	4.010	3.956	4.344	D1F	1.688	0.500	1.313	0.014	0.000	...	0.827	3.000	0.577	1.9
44	W448M12-SDS	SDS	4.411	4.357	4.750	C1F	2.000	0.548	1.375	0.000	0.077	...	0.827	3.500	0.577	2.1
48	W488M12-SDS	SDS	4.812	4.757	5.157	C1F	2.000	0.548	1.375	0.000	0.077	...	0.827	3.800	0.577	2.7
56	W568M12-SDS	SDS	5.614	5.558	5.937	C1F	2.000	0.548	1.375	0.000	0.077	...	0.827	4.600	0.577	4.0
64	W648M12-SDS	SDS	6.416	6.359	6.750	C1F	2.000	0.548	1.375	0.000	0.077	...	0.827	5.400	0.577	5.5
72	W728M12-SDS	SDS	7.218	7.160	7.562	C1F	2.000	0.548	1.375	0.000	0.077	...	0.827	6.200	0.577	7.3
80	W808M12-SDS	SDS	8.020	7.961	8.375	C2F	2.000	0.548	1.375	0.000	0.077	...	0.827	6.900	0.577	9.2
90	W908M12-SDS	SDS	9.023	8.963	...	C2	2.000	0.548	1.375	0.000	0.077	...	0.827	7.625	...	9.5
112	W1128M12-SK	SK	11.229	11.166	...	C3	2.625	0.688	1.938	0.423	0.000	...	0.827	9.875	...	13.3
144	W1448M12-SK	SK	14.447	14.370	...	C3	2.625	0.688	1.938	0.423	0.000	...	0.827	12.875	...	19.1
192	W1928M12-SF	SF	19.249	19.176	...	C3	2.938	0.813	2.063	0.423	0.000	...	0.827	17.625	...	23.0

8mm Pitch, 22 mm (.86 in.) Wide Belts (8M-22)

22	W228M22-MPB	MPB	2.206	2.154	2.562	MPB1F	1.188	0.619	1.840	0.000	...	1.625	1.22	...	0.97	1.3
24	W248M22-JA	JA	2.406	2.354	2.750	E1F•	1.250	0.658	1.063	0.500	0.000	...	1.22	1.34	0.97	0.7
26	W268M22-JA	JA	2.607	2.554	2.937	E1F•	1.250	0.658	1.063	0.500	0.000	...	1.22	1.34	0.97	1.0
28	W288M22-H	H	2.807	2.755	3.156	E1F•	1.500	0.345	1.250	0.375	0.000	...	1.22	1.57	0.97	1.1
30	W308M22-H	H	3.008	2.955	3.344	E1F•	1.500	0.345	1.250	0.375	0.000	...	1.22	1.57	0.97	1.3
32	W328M22-H	H	3.208	3.155	3.562	C1F•	1.500	0.030	1.250	0.000	0.345	...	1.22	1.57	0.97	1.7
34	W348M22-SH	SH	3.409	3.355	3.750	D1F	1.688	0.092	1.313	0.000	0.408	...	1.22	2.75	0.97	1.3
36	W368M22-SH	SH	3.609	3.556	3.937	D1F	1.688	0.092	1.313	0.000	0.408	...	1.22	2.82	0.97	1.6
38	W388M22-SH	SH	3.810	3.756	4.156	D1F	1.688	0.092	1.313	0.000	0.408	...	1.22	3.00	0.97	1.9
40	W408M22-SH	SH	4.010	3.956	4.344	D1F	1.688	0.092	1.313	0.000	0.408	...	1.22	3.00	0.97	2.3
44	W448M22-SDS	SDS	4.411	4.357	4.750	D1F	2.000	0.155	1.375	0.000	0.470	...	1.22	3.50	0.97	2.5
48	W488M22-SDS	SDS	4.812	4.757	5.157	D1F	2.000	0.155	1.375	0.000	0.470	...	1.22	3.80	0.97	3.2
56	W568M22-SDS	SDS	5.614	5.558	5.937	D1F	2.000	0.155	1.375	0.000	0.470	...	1.22	4.60	0.97	4.6
64	W648M22-SK	SK	6.416	6.359	6.750	D1F	2.625	0.438	1.938	-0.280	0.250	...	1.22	5.40	0.97	7.7
72	W728M22-SK	SK	7.218	7.160	7.562	D1F	2.625	0.438	1.938	-0.280	0.250	...	1.22	6.20	0.97	9.1
80	W808M22-SK	SK	8.020	7.961	8.375	D2F	2.625	0.438	1.938	-0.280	0.250	...	1.22	6.90	0.97	9.1
90	W908M22-SK	SK	9.023	8.963	...	D2	2.625	0.438	1.938	-0.280	0.250	...	1.22	7.63	...	12.0
112	W1128M22-SK	SK	11.229	11.166	...	D3	2.625	0.438	1.938	-0.280	0.250	...	1.22	9.88	...	15.3
144	W1448M22-SF	SF	14.447	14.370	...	D3	2.938	0.563	2.063	-0.280	0.250	...	1.22	12.88	...	19.1
192	W1928M22-E	E	19.249	19.176	...	C3	3.500	1.202	2.625	0.202	-0.202	...	1.22	17.63	...	38.4

* Weight Shown is for Sprocket Less Bushing.

• Reverse Mount Only

+ The numbers (1=Solid, 2=Web, 3=Arms) within the "Type" indicates construction, and the letter F indicates the sprocket has flanges.



High HP HTS® Sprockets 8mm

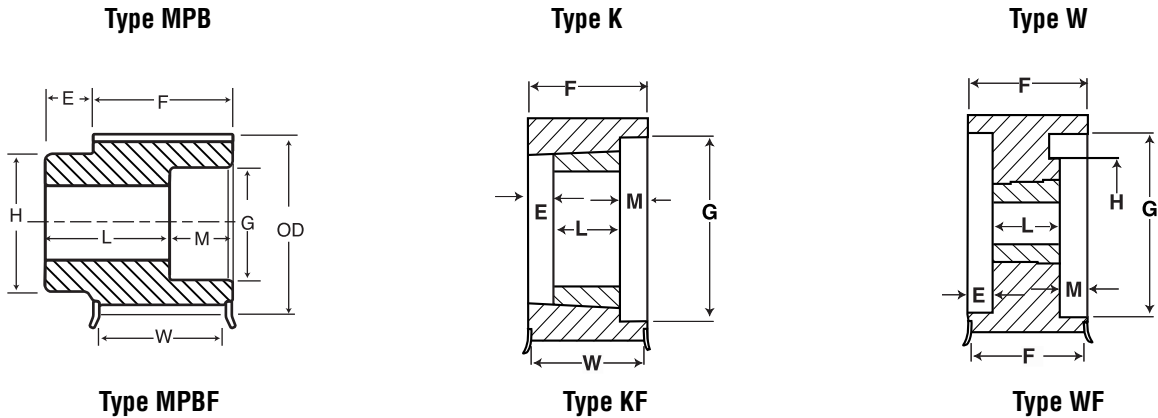

8mm Pitch, 35 mm (1.38in.) Wide Belts (8M - 35)																
No. of Teeth	Catalog Number	Bore	Pitch	Diameter (in.)		Type +	Max. Bore	Dimensions (in.)							Weight* Approx. (lbs)	
				O.D.	Flange			E	L	M	K	H	F	G		W
22	W228M35-MPB	MPB	2.206	2.154	2.56	MBP1F	1.188	0.618	2.3500	1.6250	1.73	...	1.428	1.6
24	W248M35-MPB	MPB	2.406	2.354	2.75	MBP1F	1.250	0.618	2.3500	1.8125	1.73	...	1.428	2
26	W268M35-MPB	MPB	2.607	2.554	2.94	MBP1F	1.375	0.618	2.3500	2.0000	1.73	...	1.428	2.4
28	W288M35-H	H	2.807	2.755	3.16	E1F●	1.500	0.855	1.2500	0.375	0.000	...	1.73	1.570	1.428	1.5
30	W308M35-H	H	3.008	2.955	3.34	E1F●	1.500	0.855	1.2500	0.375	0.000	...	1.73	1.570	1.428	1.9
32	W328M35-H	H	3.208	3.155	3.56	A1F●	1.500	0.245	1.2500	0.235	0.620	...	1.73	1.570	1.428	2.4
34	W348M35-SH	SH	3.409	3.355	3.75	A1F	1.688	0.120	1.3125	0.298	0.620	...	1.73	2.750	1.428	2.4
36	W368M35-SH	SH	3.609	3.556	3.94	A1F	1.688	0.120	1.3125	0.298	0.620	...	1.73	2.820	1.428	2.8
38	W388M35-SH	SH	3.810	3.756	4.16	A1F	1.688	0.120	1.3125	0.298	0.620	...	1.73	3.000	1.428	3.0
40	W408M35-SH	SH	4.010	3.956	4.34	A1F	1.688	0.120	1.3125	0.298	0.620	...	1.73	3.000	1.428	2.8
44	W448M35-SD	SD	4.411	4.357	4.75	D1F	2.000	0.313	1.8125	0.232	0.250	...	1.73	3.500	1.428	3.1
48	W488M35-SD	SD	4.812	4.757	5.16	D1F	2.000	0.313	1.8125	0.232	0.250	...	1.73	3.800	1.428	3.5
56	W568M35-SK	SK	5.614	5.558	5.94	D1F	2.625	0.438	1.9375	0.230	0.250	...	1.73	4.600	1.428	5.3
64	W648M35-SK	SK	6.416	6.359	6.75	D1F	2.625	0.438	1.9375	0.230	0.250	...	1.73	5.400	1.428	8.4
72	W728M35-SK	SK	7.218	7.160	7.56	D1F	2.625	0.438	1.9375	0.230	0.250	...	1.73	6.200	1.428	9.1
80	W808M35-SF	SF	8.020	7.961	8.38	D1F	2.938	0.563	2.0625	0.230	0.250	...	1.73	6.900	1.428	15.1
90	W908M35-SF	SF	9.023	8.963	...	D2	2.938	0.563	2.0625	0.230	0.250	...	1.73	7.625	...	20.7
112	W1128M35-SF	SF	11.229	11.166	...	A3	2.938	0.563	2.0625	0.230	0.250	...	1.73	9.875	...	18.0
144	W1448M35-E	E	14.447	14.370	...	C3	3.500	0.893	2.6250	0.000	0.107	...	1.73	12.875	...	38.0
192	W1928M35-E	E	19.249	19.176	...	C3	3.500	0.893	2.6250	0.000	0.107	...	1.73	17.625	...	53.0
8mm Pitch, 60 mm (2.36 in.) Wide Belts (8M-60)																
22	W228M60-MPB	MPB	2.206	2.154	2.562	MPB1F	1.188	0.619	3.375	1.625	2.756	...	2.506	2.2
24	W248M60-MPB	MPB	2.406	2.354	2.750	MPB1F	1.250	0.619	3.375	1.813	2.756	...	2.506	2.7
26	W268M60-MPB	MPB	2.607	2.554	2.937	MPB1F	1.375	0.619	3.375	2.000	2.756	...	2.506	3.3
28	W288M60-MPB	MPB	2.807	2.755	3.156	MPB1F	1.500	0.619	3.375	2.281	2.756	...	2.506	4.4
30	W308M60-MPB	MPB	3.008	2.955	3.344	MPB1F	1.563	0.619	3.375	2.468	2.756	...	2.506	5.1
32	W328M60-MPB	MPB	3.208	3.155	3.562	MPB1F	1.625	0.619	3.375	2.593	2.756	...	2.506	5.9
34	W348M60-MPB	MPB	3.409	3.355	3.750	MPB1F	1.688	0.619	3.375	2.796	2.756	...	2.506	6.6
36	W368M60-MPB	MPB	3.609	3.556	3.937	MPB1F	1.750	0.619	3.375	3.000	2.756	...	2.506	7.8
36	W368M60-2012	2012*	3.609	3.556	3.937	K1F	2.000	1.506	1.250	0.000	2.756	2.820	2.506	2.3
38	W388M60-MPB	MPB	3.810	3.756	4.156	MPB1F	1.938	0.619	3.375	3.188	2.756	...	2.506	8.8
38	W388M60-2012	2012*	3.810	3.756	4.156	K1F	2.000	1.506	1.250	0.000	2.756	3.000	2.506	2.8
40	W408M60-MPB	MPB	4.010	3.956	4.344	MPB1F	2.125	0.619	3.375	3.813	2.756	...	2.506	9.8
40	W408M60-2012	2012*	4.010	3.956	4.344	W1F	2.000	1.506	1.250	0.000	2.756	3.000	2.506	2.3
44	W448M60-2517	2517	4.411	4.357	4.750	W1F	2.500	0.503	1.750	0.503	2.756	3.500	2.506	5.4
48	W488M60-2517	2517	4.812	4.757	5.157	W1F	2.500	0.503	1.750	0.503	2.756	3.800	2.506	3.2
56	W568M60-3020	3020	5.614	5.558	5.937	W1F	3.000	0.378	2.000	0.378	2.756	4.600	2.506	6.3
64	W648M60-SF	SF	6.416	6.359	6.750	A1F	2.938	-0.061	2.063	0.754	0.752	...	2.756	5.400	2.506	9.8
72	W728M60-E	E	7.218	7.160	7.562	A1F	3.500	0.000	2.625	0.131	1.000	...	2.756	6.200	2.506	12.8
80	W808M60-E	E	8.020	7.961	8.375	A1F	3.500	0.000	2.625	0.131	1.000	...	2.756	6.900	2.506	19.3
90	W908M60-E	E	9.023	8.963	...	A1	3.500	0.000	2.625	0.131	1.000	...	2.756	7.625	...	20.7
112	W1128M60-F	F	11.229	11.166	...	C3	4.000	0.869	3.625	0.000	0.256	...	2.756	9.875	...	50.3
144	W1448M60-F	F	14.447	14.370	...	C3	4.000	0.869	3.625	0.000	0.256	...	2.756	12.875	...	73.2
192	W1928M60-F	F	19.249	19.176	...	C3	4.000	0.869	3.625	0.000	0.256	...	2.756	17.625	...	81.3

+ The numbers (1=Solid, 2=Web, 3=Arms) within the "Type" indicates construction, and the letter F indicates the sprocket has flanges.

* Weight Shown is for Sprocket Less Bushing.

● Reverse Mount Only

PULLEYS

High HP HTS® Sprockets 14mm

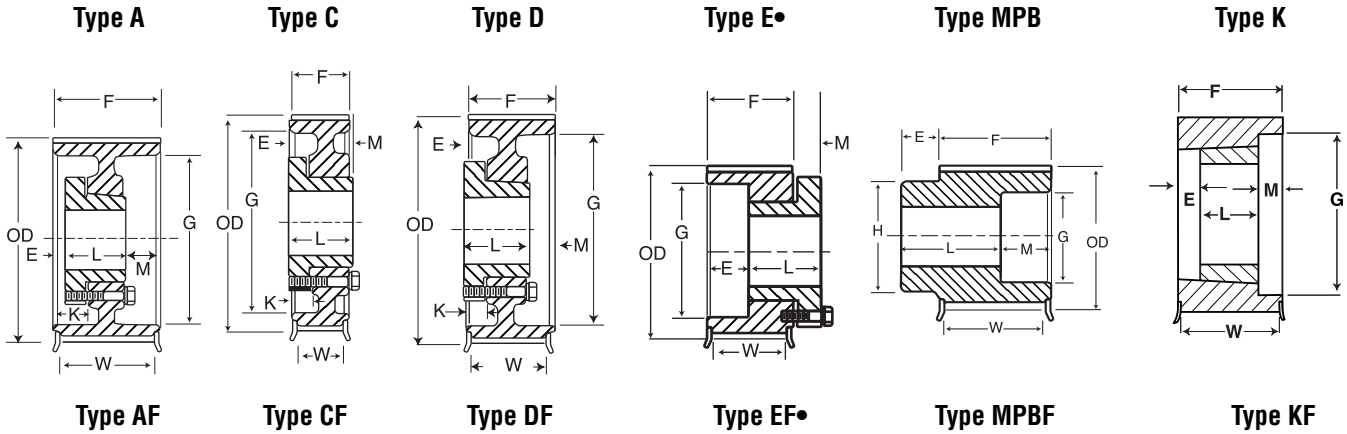

14mm Pitch, 20 mm (.79in.) Wide Belts (14M - 20)

No. of Teeth	Catalog Number	Bore	Pitch	Diameter (in.)		Type +	Max. Bore	Dimensions (in.)								Weight* Approx. (lbs)
				O.D.	Flange			E	L	M	K	H	F	G	W	
28	W2814M20-SK	SK	4.912	4.805	5.56	D1F	2.625	0.688	1.938	-0.030	0.000	..	1.220	2.740	0.908	3.6
29	W2914M20-SK	SK	5.088	4.981	5.56	D1F	2.625	0.688	1.938	-0.030	0.000	..	1.220	2.740	0.908	4.0
30	W3014M20-SK	SK	5.263	5.156	6.13	D1F	2.625	0.688	1.938	-0.030	0.000	..	1.220	2.740	0.908	4.4
32	W3214M20-SK	SK	5.614	5.507	6.13	D1F	2.625	0.688	1.938	-0.030	0.000	..	1.220	2.740	0.908	5.3
34	W3414M20-SK	SK	5.965	5.857	6.5	D1F	2.625	0.688	1.938	-0.030	0.000	..	1.220	2.740	0.908	6.2
36	W3614M20-SF	SF	6.316	6.208	6.81	C1F	2.938	0.813	2.063	-0.030	0.000	..	1.220	3.050	0.908	5.7
38	W3814M20-SF	SF	6.667	6.559	7.16	C1F	2.938	0.813	2.063	-0.030	0.000	..	1.220	3.050	0.908	6.5
40	W4014M20-SF	SF	7.018	6.910	7.5	C1F	2.938	0.813	2.063	-0.030	0.000	..	1.220	3.050	0.908	7.6
44	W4414M20-E	E	7.720	7.611	8.22	C1F	3.500	1.000	2.625	0.405	0.000	..	1.220	...	0.908	10.2
48	W4814M20-E	E	8.421	8.312	8.94	C1F	3.500	1.000	2.625	0.405	0.000	..	1.220	...	0.908	13.0
52	W5214M20-E	E	9.123	9.014	9.69	C1F	3.500	1.000	2.625	0.405	0.000	..	1.220	...	0.908	16.7
56	W5614M20-E	E	9.825	9.715	10.38	C1F	3.500	1.000	2.625	0.405	0.000	..	1.220	...	0.908	20.4
60	W6014M20-E	E	10.527	10.417	11.06	C1F	3.500	1.000	2.625	0.405	0.000	..	1.220	...	0.908	23.6
64	W6414M20-E	E	11.229	11.118	11.75	C1F	3.500	1.000	2.625	0.405	0.000	..	1.220	...	0.908	27.1
68	W6814M20-E	E	11.930	11.820	12.5	C2F	3.500	1.000	2.625	0.405	0.000	..	1.220	...	0.908	26.8
72	W7214M20-E	E	12.632	12.521	13.19	C2F	3.500	1.000	2.625	0.405	0.000	..	1.220	...	0.908	29.6
80	W8014M20-E	E	14.036	13.924	14.63	C2F	3.500	1.000	2.625	0.405	0.000	..	1.220	...	0.908	35.3
90	W9014M20-E	E	15.790	15.677	...	C3	3.500	1.188	2.625	0.218	-0.188	..	1.220	13.563	...	36.6
112	W11214M20-E	E	19.650	19.535	...	C3	3.500	1.188	2.625	0.218	-0.188	..	1.220	17.375	...	48.0
144	W14414M20-E	E	25.264	25.147	...	C3	3.500	1.188	2.625	0.218	-0.188	..	1.220	23.000	...	59.4
168	W16814M20-F	F	29.475	29.355	...	C3	4.000	1.563	3.625	0.842	-0.438	..	1.220	27.250	...	98.4
192	W19214M20-J	J	33.686	33.564	...	C3	4.500	1.938	4.500	1.342	-0.626	..	1.220	31.375	...	147.4
216	W21614M20-J	J	37.896	37.772	...	C3	4.500	1.938	4.500	1.342	-0.626	..	1.220	35.625	...	155.6

14mm Pitch, 42 mm (1.65 in.) Wide Belts (14M-42)

28	W2814M42-SK	SK	4.912	4.805	5.56	E1F•	2.625	0.837	1.938	0.688	2.087	2.740	1.774	5.5
29	W2914M42-SK	SK	5.088	4.981	5.56	E1F•	2.625	0.837	1.938	0.688	2.087	2.740	1.774	6.2
30	W3014M42-SK	SK	5.263	5.156	6.13	D1F	2.625	0.267	1.938	0.416	0.421	..	2.087	3.920	1.774	5.9
32	W3214M42-SK	SK	5.614	5.507	6.13	D1F	2.625	0.267	1.938	0.416	0.42	..	2.087	3.920	1.774	7.4
34	W3414M42-SF	SF	5.965	5.857	6.50	D1F	2.938	0.391	2.063	0.415	0.421	..	2.087	3.920	1.774	8.8
36	W3614M42-SF	SF	6.316	6.208	6.81	D1F	2.938	0.391	2.063	0.415	0.421	..	2.087	4.688	1.774	7.8
38	W3814M42-SF	SF	6.667	6.559	7.16	D1F	2.938	0.391	2.063	0.415	0.421	..	2.087	4.938	1.774	9.2
40	W4014M42-SF	SF	7.018	6.910	7.50	D1F	2.938	0.391	2.063	0.415	0.421	..	2.087	5.063	1.774	10.8
44	W4414M42-E	E	7.720	7.611	8.22	D1F	3.500	0.772	2.625	0.234	0.228	..	2.087	6.125	1.774	13.1
48	W4814M42-E	E	8.421	8.312	8.94	D1F	3.500	0.772	2.625	0.234	0.228	..	2.087	6.500	1.774	17.2
52	W5214M42-E	E	9.123	9.014	9.69	D1F	3.500	0.772	2.625	0.234	0.228	..	2.087	7.188	1.774	21.2
56	W5614M42-E	E	9.825	9.715	10.38	D1F	3.500	0.772	2.625	0.234	0.228	..	2.087	7.875	1.774	25.6
60	W6014M42-E	E	10.527	10.417	11.06	D1F	3.500	0.772	2.625	0.234	0.228	..	2.087	8.500	1.774	30.3
64	W6414M42-E	E	11.229	11.118	11.75	D1F	3.500	0.772	2.625	0.234	0.228	..	2.087	9.250	1.774	35.1
68	W6814M42-E	E	11.930	11.820	12.50	D2F	3.500	0.772	2.625	0.234	0.228	..	2.087	10.000	1.774	33.7
72	W7214M42-E	E	12.632	12.521	13.19	D2F	3.500	0.772	2.625	0.234	0.228	..	2.087	10.688	1.774	37.3
80	W8014M42-E	E	14.036	13.924	14.63	D2F	3.500	0.772	2.625	0.234	0.228	..	2.087	12.125	1.774	44.5
90	W9014M42-F	F	15.790	15.677	...	C3	4.000	1.125	3.625	0.413	2.087	13.563	...	50.8
112	W11214M42-F	F	19.650	19.535	...	C3	4.000	1.125	3.625	0.413	2.087	17.375	...	77.3
144	W14414M42-F	F	25.264	25.147	...	C3	4.000	1.125	3.625	0.413	2.087	23.000	...	97.4
168	W16814M42-F	F	29.475	29.355	...	C3	4.000	1.125	3.625	0.413	2.087	27.250	...	119.3
192	W19214M42-J	J	33.686	33.564	...	C3	4.500	1.505	4.500	0.908	...	-0.192	2.087	31.375	...	173.5
216	W21614M42-J	J	37.896	37.772	...	C3	4.500	1.505	4.500	0.908	...	-0.192	2.087	35.625	...	206.0

* Weight Shown is for Sprocket Less Bushing.

• Reverse Mount Only

+ The numbers (1=Solid, 2=Web, 3=Arms) within the "Type" indicates construction, and the letter F indicates the sprocket has flanges.

PULLEYS



High HP HTS® Sprockets 14mm

14mm Pitch, 65 mm (2.56in.) Wide Belts (14M - 65)																
No. of Teeth	Catalog Number	Bore	Pitch	Diameter (in.)		Type +	Max. Bore	Dimensions (in.)								Weight* Approx. (lbs)
				O.D.	Flange			E	L	M	K	H	F	G	W	
28	W2814M65-MPB	MPB	4.912	4.805	5.56	MPB1F	2.313	1.000	4.032	0.000	-	3.688	3.032	0.000	2.719	15
29	W2914M65-MPB	MPB	5.088	4.981	5.56	MPB1F	2.313	1.000	4.032	0.000	-	3.688	3.032	0.000	2.719	16
30	W3014M65-MPB	MPB	5.263	5.156	6.13	MPB1F	2.500	1.000	4.032	0.000	-	4.141	3.032	0.000	2.719	18
32	W3214M65-MPB	MPB	5.614	5.507	6.13	MPB1F	2.500	1.000	4.032	0.000	-	4.141	3.032	0.000	2.719	20.2
34	W3414M65-MPB	MPB	5.965	5.857	6.50	MPB1F	2.688	1.000	4.032	0.000	-	4.484	3.032	0.000	2.719	23.4
36	W3614M65-MPB	MPB	6.316	6.208	6.81	MPB1F	3.000	1.000	4.032	0.000	-	4.875	3.032	0.000	2.719	24.5
36	W3614M65-3030	3030*	6.316	6.208	6.81	MPB1F	3.000	0.032	3.000	0.000	-	0.000	3.032	0.000	2.719	10.8
38	W3814M65-MPB	MPB	6.667	6.559	7.16	MPB1F	3.250	1.000	4.032	0.000	-	5.172	3.032	0.000	2.719	27.6
38	W3814M65-3030	3030*	6.667	6.559	7.16	MPB1F	3.000	0.032	3.000	0.000	-	0.000	3.032	0.000	2.719	13.4
40	W4014M65-MPB	MPB	7.018	6.910	7.50	MPB1F	3.438	1.000	4.032	0.000	-	5.563	3.032	0.000	2.719	31.5
40	W4014M65-3535	3535*	7.018	6.910	7.50	C1F	3.500	0.468	3.500	0.000	-	6.125	3.032	3.875	2.719	13.2
44	W4414M65-E	E	7.720	7.611	8.22	D1F	3.500	0.125	2.625	0.532	0.875	...	3.032	6.125	2.719	16.2
48	W4814M65-E	E	8.421	8.312	8.94	D1F	3.500	0.125	2.625	0.532	0.875	...	3.032	6.500	2.719	21.4
52	W5214M65-E	E	9.123	9.014	9.69	D1F	3.500	0.125	2.625	0.532	0.875	...	3.032	7.188	2.719	25.9
56	W5614M65-F	F	9.825	9.715	10.38	C1F	4.000	0.594	3.625	0.000	0.531	...	3.032	7.875	2.719	36.3
60	W6014M65-F	F	10.527	10.417	11.06	C1F	4.000	0.594	3.625	0.000	0.531	...	3.032	8.500	2.719	43.5
64	W6414M65-F	F	11.229	11.118	11.75	C1F	4.000	0.594	3.625	0.000	0.531	...	3.032	9.250	2.719	51.0
68	W6814M65-F	F	11.930	11.820	12.50	C2F	4.000	0.594	3.625	0.000	0.531	7.750	3.032	10.000	2.719	47.9
72	W7214M65-F	F	12.632	12.521	13.19	C2F	4.000	0.594	3.625	0.000	0.531	7.750	3.032	10.688	2.719	52.7
80	W8014M65-F	F	14.036	13.924	14.63	C2F	4.000	0.594	3.625	0.000	0.531	7.750	3.032	12.125	2.719	61.2
90	W9014M65-F	F	15.790	15.677	...	C3	4.000	0.594	3.625	0.000	0.531	7.750	3.032	13.563	...	59.8
112	W11214M65-J	J	19.650	19.535	...	C3	4.500	1.250	4.500	0.219	0.063	9.000	3.032	17.375	...	104.2
144	W14414M65-M	M	25.264	25.147	...	C3	5.500	2.063	6.750	1.657	-0.500	11.375	3.032	23.000	...	197.3
168	W16814M65-M	M	29.475	29.355	...	C3	5.500	2.063	6.750	1.657	-0.500	11.375	3.032	27.250	...	207.0
192	W19214M65-M	M	33.686	33.564	...	C3	5.500	2.063	6.750	1.657	-0.500	11.375	3.032	31.375	...	173.5
216	W21614M65-M	M	37.896	37.772	...	C3	5.500	2.063	6.750	1.657	-0.500	11.375	3.032	35.625	...	253.0
14mm Pitch, 90 mm (3.54 in.) Wide Belts (14M-90)																
28	W2814M90-MPB	MPB	4.912	4.805	5.56	MPB1F	2.313	1.000	5.055	3.688	4.055	0.000	3.743	18.9
29	W2914M90-MPB	MPB	5.088	4.981	5.56	MPB1F	2.313	1.000	5.055	3.688	4.055	0.000	3.743	20.2
30	W3014M90-MPB	MPB	5.263	5.156	6.13	MPB1F	2.500	1.000	5.055	4.141	4.055	0.000	3.743	10.9
32	W3214M90-MPB	MPB	5.614	5.507	6.13	MPB1F	2.500	1.000	5.055	4.141	4.055	0.000	3.743	13.9
34	W3414M90-MPB	MPB	5.965	5.857	6.50	MPB1F	2.688	1.000	5.055	4.484	4.055	0.000	3.743	16.7
36	W3614M90-MPB	MPB	6.316	6.208	6.81	MPB1F	3.000	1.000	5.055	4.875	4.055	0.000	3.743	31.4
38	W3814M90-MPB	MPB	6.667	6.559	7.16	MPB1F	3.250	1.000	5.055	5.172	4.055	4.938	3.743	35.5
40	W4014M90-3535	3535	7.018	6.910	7.50	K1F	3.500	0.555	3.500	0.000	4.055	...	3.743	17.1
44	W4414M90-3535	3535	7.720	7.611	8.22	K1F	4.000	0.555	3.500	0.000	4.055	...	3.743	24.8
48	W4814M90-4040	4040	8.421	8.312	8.94	K1F	4.000	0.555	4.000	0.000	4.055	...	3.743	27.0
52	W5214M90-F	F	9.123	9.014	9.69	D1F	4.000	0.347	3.625	0.778	0.778	...	4.055	7.188	3.743	34.7
56	W5614M90-F	F	9.825	9.715	10.38	D1F	4.000	0.347	3.625	0.778	0.778	...	4.055	7.875	3.743	36.3
60	W6014M90-F	F	10.527	10.417	11.06	D1F	4.000	0.347	3.625	0.778	0.778	...	4.055	8.500	3.743	49.8
64	W6414M90-F	F	11.229	11.118	11.75	D1F	4.000	0.347	3.625	0.778	0.778	...	4.055	9.250	3.743	57.6
68	W6814M90-F	F	11.930	11.820	12.50	D2F	4.000	0.347	3.625	0.778	0.778	...	4.055	10.000	3.743	54.8
72	W7214M90-F	F	12.632	12.521	13.19	D2F	4.000	0.347	3.625	0.778	0.778	...	4.055	10.688	3.743	60.0
80	W8014M90-J	J	14.036	13.924	14.63	C2F	4.500	0.375	4.500	0.070	0.938	...	4.055	12.125	3.743	81.5
90	W9014M90-J	J	15.790	15.677	...	C3	4.500	0.375	4.500	0.070	0.938	...	4.055	13.563	...	77.4
112	W11214M90-J	J	19.650	19.535	...	C3	4.500	0.375	4.500	0.070	0.938	...	4.055	17.375	...	116.2
144	W14414M90-M	M	25.264	25.147	...	C3	5.500	1.563	6.750	1.132	0.000	11.375	4.055	23.000	...	220.0
168	W16814M90-M	M	29.475	29.355	...	C3	5.500	1.563	6.750	1.132	0.000	11.375	4.055	27.250	...	207.0
192	W19214M90-M	M	33.686	33.564	...	C3	5.500	1.563	6.750	1.132	0.000	11.375	4.055	31.375	...	268.4
216	W21614M90-M	M	37.896	37.772	...	C3	5.500	1.563	6.750	1.132	0.000	11.375	4.055	35.625	...	278.1
14mm Pitch, 120 mm (4.72 in.) Wide Belts (14M-120)																
28	W2814M120-MPB	MPB	4.912	4.805	5.56	MPB1F	2.313	1.000	4.986	1.250	...	3.688	5.236	3.125	4.924	22.0
29	W2914M120-MPB	MPB	5.088	4.981	5.56	MPB1F	2.313	1.000	4.986	1.250	...	3.688	5.236	3.125	4.924	23.8
30	W3014M120-MPB	MPB	5.263	5.156	6.13	MPB1F	2.500	1.000	4.986	1.250	...	4.141	5.236	3.906	4.924	25.1
32	W3214M120-MPB	MPB	5.614	5.507	6.13	MPB1F	2.500	1.000	4.986	1.250	...	4.141	5.236	3.906	4.924	29
34	W3414M120-MPB	MPB	5.965	5.857	6.50	MPB1F	2.688	1.000	4.986	1.250	...	4.484	5.236	4.063	4.924	33.7
36	W3614M120-MPB	MPB	6.316	6.208	6.81	MPB1F	3.000	1.000	4.986	1.250	...	4.875	5.236	4.688	4.924	34.0
38	W3814M120-MPB	MPB	6.667	6.559	7.16	MPB1F	3.250	1.000	4.986	1.250	...	5.172	5.236	4.938	4.924	38.4
40	W4014M120-MPB	MPB	7.018	6.910	7.50	MPB1F	3.438	1.000	4.986	1.250	...	5.563	5.236	5.063	4.924	43.4
44	W4414M120-3535	3535	7.720	7.611	8.22	K1F	4.000	0.868	3.500	0.868	5.236	5.875	4.924	24.8
48	W4814M120-4040	4040	8.421	8.312	8.94	K1F	4.000	0.618	4.000	0.618	5.236	6.625	4.924	31.8
52	W5214M120-F	F	9.123	9.014	9.69	A1F	4.000	1.125	3.625	1.361	1.375	...	5.236	7.188	4.924	34.7
56	W5614M120-F	F	9.825	9.715	10.38	A1F	4.000	1.125	3.625	1.361	1.375	...	5.236	7.875	4.924	48.4
60	W6014M120-F	F	10.527	10.417	11.06	A1F	4.000	1.125	3.625	1.361	1.375	...	5.236	8.500	4.924	57.1
64	W6414M120-J	J	11.229	11.118	11.75	D1F	4.500	0.293	4.500	1.029	1.020	...	5.236	9.250	4.924	69.7
68	W6814M120-J	J	11.930	11.820	12.50	D1F	4.500	0.293	4.500	1.029	1.020	...	5.236	10.000	4.924	80.4
72	W7214M120-J	J	12.632	12.521	13.19	D1F	4.500	0.293	4.500	1.029	1.020	...	5.236	10.688	4.924	92.2
80	W8014M120-J	J	14.036	13.924	14.63	D2F	4.500	0.293	4.500	1.029	1.020	...	5.236	12.125	4.924	92.5
90	W9014M120-M	M	15.790	15.677	...	C2	5.500	1.514	6.750	0.000	0.049	10.000	5.236	13.563	...	134.5
112	W11214M120-M	M	19.650	19.535	...	C3	5.500	1.514	6.750	0.000	0.049	11.375	5.236	17.375	...	193.4
144	W14414M120-M	M	25.264	25.147	...	C3	5.500	1.514	6.750	0.000	0.049	11.375	5.236	23.000	...	234.6
168	W16814M120-M	M	29.475	29.355	...	C3	5.500	1.514	6.750	0.000	0.049	11.375	5.236	27.250	...	245.8
192	W19214M120-N	N	33.686	33.564	...	C3	6.000	1.875	8.125	1.014	0.000	12.000	5.236	31.375	...	381.5

+ The numbers (1=Solid, 2=Web, 3=Arms) within the "Type" indicates construction, and the letter F indicates the sprocket has flanges.

* Weight Shown is for Sprocket Less Bushing.
● Reverse Mount Only

PULLEYS

High HP HTS® 8mm Drive Selection Tables



Sprocket Combination					HP Ratings @1750 RPM Driver											
Drive	Driver		Driven		DN	RPP Panther Belt Widths (mm)										
Ratio	No. Teeth	P.D.	No. Teeth	P.D.	RPM	12	22	35	60	480	560	600	640	720	800	
Multiply HP rating by the belt length factor to determine drive width - BELT LENGTH FACTOR										0.8	0.8	0.8	0.9	0.9	0.9	
1.00	80	8.02	80	8.02	1750	26.51	48.64	77.42	132.74							
1.00	72	7.22	72	7.22	1750	23.77	43.62	69.42	119.03							
1.00	64	6.42	64	6.42	1750	21.02	38.57	61.39	105.26							
1.00	56	5.61	56	5.61	1750	18.27	33.52	53.35	91.47						6.9	
1.00	48	4.81	48	4.81	1750	15.52	28.47	45.32	77.70				5.0	6.6	8.2	
1.00	44	4.41	44	4.41	1750	14.15	25.96	41.31	70.84			4.9	5.7	7.2	8.8	
1.00	40	4.01	40	4.01	1750	12.78	23.45	37.32	63.99		4.7	5.5	6.3	7.9	9.5	
1.00	38	3.81	38	3.81	1750	12.10	22.20	35.33	60.58		5.0	5.8	6.6	8.2	9.8	
1.00	36	3.61	36	3.61	1750	11.42	20.95	33.35	57.18	3.8	5.4	6.1	6.9	8.5	10.1	
1.00	34	3.41	34	3.41	1750	10.74	19.71	31.37	53.79	4.1	5.7	6.5	7.2	8.8	10.4	
1.00	32	3.21	32	3.21	1750	10.07	18.47	29.40	50.41	4.4	6.0	6.8	7.6	9.1	10.7	
1.00	30	3.01	30	3.01	1750	9.40	17.24	27.43	47.04	4.7	6.3	7.1	7.9	9.5	11.0	
1.00	28	2.81	28	2.81	1750	8.72	16.01	25.47	43.68	5.0	6.6	7.4	8.2	9.8	11.3	
1.00	26	2.61	26	2.61	1750	8.06	14.78	23.53	40.34	5.4	6.9	7.7	8.5	10.1	11.7	
1.00	24	2.41	24	2.41	1750	7.39	13.56	21.59	37.01	5.7	7.2	8.0	8.8	10.4	12.0	
1.00	22	2.21	22	2.21	1750	6.73	12.35	19.66	33.71	6.0	7.6	8.4	9.1	10.7	12.3	
1.05	38	3.81	40	4.01	1663	12.10	22.20	35.33	60.58		4.9	5.7	6.5	8.0	9.6	
1.06	36	3.61	38	3.81	1658	11.42	20.95	33.35	57.18		5.2	6.0	6.8	8.4	9.9	
1.06	34	3.41	36	3.61	1653	10.74	19.71	31.37	53.79	3.9	5.5	6.3	7.1	8.7	10.2	
1.06	32	3.21	34	3.41	1647	10.07	18.47	29.40	50.41	4.3	5.8	6.6	7.4	9.0	10.6	
1.07	30	3.01	32	3.21	1641	9.40	17.24	27.43	47.04	4.6	6.1	6.9	7.7	9.3	10.9	
1.07	28	2.81	30	3.01	1633	8.72	16.01	25.47	43.68	4.9	6.5	7.2	8.0	9.6	11.2	
1.08	26	2.61	28	2.81	1625	8.06	14.78	23.53	40.34	5.2	6.8	7.6	8.4	9.9	11.5	
1.08	24	2.41	26	2.61	1615	7.39	13.56	21.59	37.01	5.5	7.1	7.9	8.7	10.2	11.8	
1.09	44	4.41	48	4.81	1604	14.15	25.96	41.31	70.84				5.4	6.9	8.5	
1.09	22	2.21	24	2.41	1604	6.73	12.35	19.66	33.71	5.8	7.4	8.2	9.0	10.6	12.1	
1.10	40	4.01	44	4.41	1591	12.78	23.45	37.32	63.99		4.4	5.2	6.0	7.6	9.1	
1.11	72	7.22	80	8.02	1575	23.77	43.62	69.42	119.03							
1.11	36	3.61	40	4.01	1575	11.42	20.95	33.35	57.18		5.0	5.8	6.6	8.2	9.8	
1.12	34	3.41	38	3.81	1566	10.74	19.71	31.37	53.79	3.8	5.4	6.1	6.9	8.5	10.1	
1.13	80	8.02	90	9.02	1556	26.51	48.64	77.42	132.74							
1.13	64	6.42	72	7.22	1556	21.02	38.57	61.39	105.26							
1.13	32	3.21	36	3.61	1556	10.07	18.47	29.40	50.41	4.1	5.7	6.5	7.2	8.8	10.4	
1.13	30	3.01	34	3.41	1544	9.40	17.24	27.43	47.04	4.4	6.0	6.8	7.6	9.1	10.7	
1.14	56	5.61	64	6.42	1531	18.27	33.52	53.35	91.47							
1.14	28	2.81	32	3.21	1531	8.72	16.01	25.47	43.68	4.7	6.3	7.1	7.9	9.5	11.0	
1.15	26	2.61	30	3.01	1517	8.06	14.78	23.53	40.34	5.0	6.6	7.4	8.2	9.8	11.3	
1.16	38	3.81	44	4.41	1511	12.10	22.20	35.33	60.58		4.6	5.4	6.1	7.7	9.3	
1.17	48	4.81	56	5.61	1500	15.52	28.47	45.32	77.70					6.0	7.6	
1.17	24	2.41	28	2.81	1500	7.39	13.56	21.59	37.01	5.4	6.9	7.7	8.5	10.1	11.7	
1.18	34	3.41	40	4.01	1488	10.74	19.71	31.37	53.79		5.2	6.0	6.8	8.3	9.9	
1.18	22	2.21	26	2.61	1481	6.73	12.35	19.66	33.71	5.7	7.2	8.0	8.8	10.4	12.0	
1.19	32	3.21	38	3.81	1474	10.07	18.47	29.40	50.41	3.9	5.5	6.3	7.1	8.7	10.2	
1.20	40	4.01	48	4.81	1458	12.78	23.45	37.32	63.99		4.9	5.7	6.5	8.1	9.7	
1.20	30	3.01	36	3.61	1458	9.40	17.24	27.43	47.04	4.2	5.8	6.6	7.4	9.0	10.6	
1.21	28	2.81	34	3.41	1441	8.72	16.01	25.47	43.68	4.6	6.1	6.9	7.7	9.3	10.9	
1.22	36	3.61	44	4.41	1432	11.42	20.95	33.35	57.18		4.7	5.5	6.3	7.9	9.4	
1.23	26	2.61	32	3.21	1422	8.06	14.78	23.53	40.34	4.9	6.5	7.2	8.0	9.6	11.2	
1.25	72	7.22	90	9.02	1400	23.77	43.62	69.42	119.03							
1.25	64	6.42	80	8.02	1400	21.02	38.57	61.39	105.26							
1.25	32	3.21	40	4.01	1400	10.07	18.47	29.40	50.41	3.8	5.3	6.1	6.9	8.5	10.1	
1.25	24	2.41	30	3.01	1400	7.39	13.56	21.59	37.01	5.2	6.8	7.6	8.3	9.9	11.5	
1.26	38	3.81	48	4.81	1385	12.10	22.20	35.33	60.58		5.0	5.8	6.6	8.2	9.8	
1.27	44	4.41	56	5.61	1375	14.15	25.96	41.31	70.84					6.3	7.9	
1.27	30	3.01	38	3.81	1382	9.40	17.24	27.43	47.04	4.1	5.7	6.4	7.2	8.8	10.4	
1.27	22	2.21	28	2.81	1375	6.73	12.35	19.66	33.71	5.5	7.1	7.9	8.7	10.2	11.8	
1.29	56	5.61	72	7.22	1361	18.27	33.52	53.35	91.47							
1.29	34	3.41	44	4.41	1352	10.74	19.71	31.37	53.79		4.9	5.7	6.4	8.0	9.6	
1.29	28	2.81	36	3.61	1361	8.72	16.01	25.47	43.68	4.4	6.0	6.8	7.6	9.1	10.7	
1.31	26	2.61	34	3.41	1338	8.06	14.78	23.53	40.34	4.7	6.3	7.1	7.9	9.4	11.0	
1.33	48	4.81	64	6.42	1313	15.52	28.47	45.32	77.70						6.9	
1.33	36	3.61	48	4.81	1313	11.42	20.95	33.35	57.18		4.4	5.2	6.0	7.5	9.1	
1.33	30	3.01	40	4.01	1313	9.40	17.24	27.43	47.04	3.9	5.5	6.3	7.1	8.7	10.7	
1.33	24	2.41	34	3.21	1313	7.39	13.56	21.59	37.01	5.0	6.6	7.4	8.2	9.8	11.3	
1.36	28	2.81	38	3.81	1289	8.72	16.01	25.47	43.68	4.2	5.8	6.6	7.4	9.0	10.5	
Multiply HP rating by the belt length factor to determine drive width - BELT LENGTH FACTOR										0.8	0.8	0.8	0.9	0.9	0.9	



High HP HTS® 8mm Drive Selection Tables

Theoretical Center Distance in Inches for Various Belt Lengths																				
Belt Length Code (mm)																				
880	960	1040	1120	1200	1224	1280	1440	1600	1760	1800	2000	2200	2400	2600	2800	3048	3280	3600	4400	Drive
0.9	1	1	1	1	1	1.1	1.1	1.1	1.2	1.2	1.2	1.2	1.3	1.3	1.4	1.4	1.4	1.5	1.5	Ratio
7.2	7.6	9.1	9.5	11.0	11.5	12.6	15.8	18.9	22.1	22.8	26.8	30.7	34.7	38.6	42.5	47.4	52.0	58.3	74.0	1.00
8.5	8.8	10.4	10.7	12.3	12.8	13.9	17.0	20.2	23.3	24.1	28.0	32.0	35.9	39.8	43.8	48.7	53.2	59.5	75.3	1.00
9.8	10.1	11.7	13.2	14.8	15.3	16.4	19.5	22.7	25.8	26.6	30.6	34.5	38.4	42.4	46.3	51.2	55.8	62.1	77.8	1.00
10.4	11.3	12.9	14.5	16.1	16.5	17.6	20.8	23.9	27.1	27.9	31.8	35.8	39.7	43.6	47.6	52.4	57.0	63.3	79.1	1.00
11.0	12.0	13.5	15.1	16.7	17.2	18.3	21.4	24.6	27.7	28.5	32.4	36.4	40.3	44.3	48.2	53.1	57.6	63.9	79.7	1.00
11.3	12.6	14.2	15.8	17.3	17.8	18.9	22.1	25.2	28.4	29.1	33.1	37.0	40.9	44.9	48.8	53.7	58.3	64.6	80.3	1.00
11.7	12.9	14.5	16.1	17.6	18.1	19.2	22.4	25.5	28.7	29.5	33.4	37.3	41.3	45.2	49.1	54.0	58.6	64.9	80.6	1.00
12.0	13.2	14.8	16.4	18.0	18.4	19.5	22.7	25.8	29.0	29.8	33.7	37.6	41.6	45.5	49.5	54.3	58.9	65.2	80.9	1.00
12.3	13.5	15.1	16.7	18.3	18.7	19.8	23.0	26.1	29.3	30.1	34.0	38.0	41.9	45.8	49.8	54.7	59.2	65.5	81.3	1.00
12.6	13.9	15.4	17.0	18.6	19.1	20.2	23.3	26.5	29.6	30.4	34.3	38.3	42.2	46.1	50.1	55.0	59.5	65.8	81.6	1.00
12.9	14.2	15.8	17.3	18.9	19.4	20.5	23.6	26.8	29.9	30.7	34.7	38.6	42.5	46.5	50.4	55.3	59.8	66.1	81.9	1.00
13.2	14.5	16.1	17.6	19.2	19.7	20.8	23.9	27.1	30.2	31.0	35.0	38.9	42.8	46.8	50.7	55.6	60.2	66.5	82.2	1.00
13.5	14.8	16.4	18.0	19.5	20.0	21.1	24.3	27.4	30.6	31.3	35.3	39.2	43.2	47.1	51.0	55.9	60.5	66.8	82.5	1.00
13.5	15.1	16.7	18.3	19.8	20.3	21.4	24.6	27.7	30.9	31.7	35.6	39.5	43.5	47.4	51.3	56.2	60.8	67.1	82.8	1.00
13.9	15.4	17.0	18.6	20.2	20.6	21.7	24.9	28.0	31.2	32.0	35.9	39.8	43.8	47.7	51.7	56.5	61.1	67.4	83.2	1.00
11.2	12.8	14.3	15.9	17.5	18.0	19.1	22.2	25.4	28.5	29.3	33.2	37.2	41.1	45.0	49.0	53.9	58.4	64.7	80.5	1.05
11.5	13.1	14.7	16.2	17.8	18.3	19.4	22.5	25.7	28.8	29.6	33.5	37.5	41.4	45.4	49.3	54.2	58.7	65.0	80.8	1.06
11.8	13.4	15.0	16.5	18.1	18.6	19.7	22.8	26.0	29.1	29.9	33.9	37.8	41.7	45.7	49.6	54.5	59.1	65.4	81.1	1.06
12.1	13.7	15.3	16.9	18.4	18.9	20.0	23.2	26.3	29.5	30.2	34.2	38.1	42.1	46.0	49.9	54.8	59.4	65.7	81.4	1.06
12.4	14.0	15.6	17.2	18.7	19.2	20.1	23.5	26.6	29.8	30.6	34.5	38.4	42.4	46.3	50.2	55.1	59.7	66.0	81.7	1.07
12.8	14.3	15.9	17.5	19.1	19.5	20.6	23.8	26.9	30.1	30.9	34.8	38.7	42.7	46.6	50.6	55.4	60.0	66.3	82.1	1.07
13.1	14.7	16.2	17.8	19.4	19.8	20.9	24.1	27.2	30.4	31.2	35.1	39.1	43.0	46.9	50.9	55.8	60.3	66.6	82.4	1.08
13.4	15.0	16.5	18.1	19.7	20.2	21.3	24.4	27.6	30.7	31.5	35.4	39.4	43.3	47.2	51.2	56.1	60.6	66.9	82.7	1.08
10.1	11.7	13.2	14.8	16.4	16.9	18.0	21.1	24.3	27.4	28.2	32.1	36.1	40.0	43.9	47.9	52.8	57.3	63.6	79.4	1.09
13.7	15.3	16.9	18.4	20.0	20.5	21.6	24.7	27.9	31.0	31.8	35.8	39.7	43.6	47.6	51.6	56.4	60.5	67.2	83.0	1.09
10.7	12.3	13.9	15.4	17.0	17.5	18.6	21.7	24.9	28.0	28.8	32.8	36.7	40.6	44.6	48.5	53.4	58.0	64.3	80.0	1.10
		8.5	10.1	11.7	12.1	13.2	16.4	19.5	22.7	23.5	27.4	31.3	35.3	39.2	43.2	48.0	52.6	58.9	74.6	1.11
11.3	12.9	14.5	16.1	17.6	18.1	19.2	22.4	25.5	28.7	29.5	33.4	37.3	41.3	45.2	49.1	54.0	58.6	64.9	80.6	1.11
11.7	13.2	14.8	16.4	18.0	18.4	19.5	22.7	25.8	29.0	29.8	33.7	37.6	41.6	45.5	49.5	54.3	58.9	65.2	80.9	1.12
	8.2	9.8	11.3	12.9	13.4	14.5	17.6	20.8	23.9	24.7	28.7	32.6	36.5	40.5	44.4	49.3	53.9	60.2	75.9	1.13
12.0	13.5	15.1	16.7	18.3	18.7	19.8	23.0	26.1	29.3	30.1	34.0	38.0	41.9	45.8	49.8	54.7	59.2	65.5	81.3	1.13
12.3	13.9	15.4	17.0	18.6	19.1	20.2	23.3	26.5	29.6	30.4	34.3	38.3	42.2	46.1	50.1	55.0	59.5	65.8	81.6	1.13
7.9	9.4	11.0	12.6	14.2	14.6	15.7	18.9	22.0	25.2	26.0	29.9	33.9	37.8	41.7	45.7	50.6	55.1	61.4	77.2	1.14
12.6	14.8	15.8	17.3	18.9	19.4	20.5	23.6	26.8	29.9	30.7	34.7	38.6	42.5	46.5	50.4	55.3	59.8	66.1	81.9	1.14
12.9	14.5	16.1	17.6	19.2	19.7	20.8	23.9	27.1	30.2	31.0	35.0	38.9	42.8	46.8	50.7	55.6	60.2	66.5	82.2	1.15
10.9	12.4	14.0	15.6	17.2	17.6	18.7	21.9	25.0	28.2	29.0	32.9	36.9	40.8	44.7	48.7	53.5	58.1	64.4	80.2	1.16
9.1	10.7	12.3	13.9	15.4	15.9	17.0	20.2	23.3	26.5	27.2	31.2	35.1	39.1	43.0	46.9	51.8	56.4	62.7	78.4	1.17
13.2	14.8	16.4	18.0	19.5	20.0	21.1	24.3	27.4	30.6	31.3	35.3	39.2	43.2	47.1	51.0	55.9	60.5	66.8	82.5	1.17
11.5	13.1	14.6	16.2	17.8	18.3	19.4	22.5	25.7	28.8	29.6	33.5	37.5	41.4	45.4	49.3	54.2	58.7	65.0	80.8	1.18
13.5	15.1	16.7	18.3	19.8	20.3	21.4	24.6	27.7	30.9	31.7	35.6	39.5	43.5	47.4	51.3	56.2	60.8	67.1	82.8	1.18
11.8	13.4	15.0	16.5	18.1	18.6	19.7	22.8	26.0	29.1	29.9	33.9	37.8	41.7	45.7	49.6	54.5	59.1	65.4	81.1	1.19
10.4	12.0	13.5	15.1	16.7	17.2	18.3	21.4	24.6	27.7	28.5	32.4	36.4	40.3	44.3	48.2	53.1	57.6	63.9	79.7	1.20
12.1	13.7	15.3	16.9	18.4	18.9	20.0	23.2	26.3	29.5	30.2	34.2	38.1	42.1	46.0	49.9	54.8	59.4	65.7	81.4	1.20
12.4	14.0	15.6	17.2	18.7	19.2	20.3	23.5	26.6	29.8	30.6	34.5	38.4	42.4	46.3	50.2	55.1	59.7	66.0	81.7	1.21
11.2	12.6	14.2	15.7	17.3	17.8	18.9	22.0	25.2	28.3	29.1	33.1	37.0	40.9	44.9	48.8	53.7	58.3	64.6	80.3	1.22
12.8	14.3	15.9	17.5	19.1	19.5	20.6	23.8	26.9	30.1	30.9	34.8	38.7	42.7	46.6	50.6	55.4	60.0	66.3	82.1	1.23
		9.3	10.8	11.3	12.4	13.5	16.6	19.7	22.8	23.6	27.5	31.4	35.3	39.2	43.1	47.9	52.7	59.0	74.7	1.25
	7.5	9.1	10.7	12.3	12.7	13.8	17.0	20.1	23.3	24.1	28.0	32.0	35.9	39.8	43.8	48.7	53.2	59.5	75.3	1.25
11.7	13.2	14.8	16.4	18.0	18.4	19.5	22.7	25.8	29.0	29.8	33.7	37.6	41.6	45.5	49.5	54.3	58.9	65.2	80.9	1.25
13.1	14.6	16.2	17.8	19.4	19.8	20.9	24.1	27.2	30.4	31.2	35.1	39.1	43.0	46.9	50.9	55.8	60.3	66.6	82.4	1.25
10.5	12.1	13.7	15.3	16.8	17.3	18.4	21.6	24.7	27.9	28.7	32.6	36.5	40.5	44.4	48.3	53.2	57.8	64.1	79.8	1.26
9.4	11.0	12.6	14.2	15.7	16.2	17.3	20.5	23.6	26.8	27.6	31.5	35.4	39.4	43.3	47.2	52.1	56.7	63.0	78.7	1.27
12.0	13.5	15.1	16.7	18.3	18.7	19.8	23.0	26.1	29.3	30.1	34.0	38.0	41.9	45.8	49.8	54.6	59.2	65.5	81.3	1.27
13.4	15.0	16.5	18.1	19.7	20.2	21.3	24.4	27.6	30.7	31.5	35.4	39.4	43.3	47.2	51.2	56.1	60.6	66.9	82.7	1.27
7.2	8.8	10.4	11.9	13.5	14.0	15.1	18.3	21.4	24.6	25.3	29.3	33.2	37.2	41.1	45.0	49.9	54.5	60.8	76.5	1.29
11.2	12.8	14.3	15.9	17.5	18.0	19.1	22.2	25.4	28.5	29.3	33.2	37.2	41.1	45.0	49.0	53.9	58.4	64.7	80.5	1.29
12.3	13.9	15.4	17.0	18.6	19.1	20.2	23.3	26.5	29.6	30.4	34.3	38.3	42.2	46.1	50.1	55.0	59.5	65.8	81.6	1.29
12.6	14.2	15.7	17.3	18.9	19.4	20.5	23.6	26.8	29.9	30.7	34.6	38.6	42.5	46.5	50.4	55.3	59.8	66.1	81.9	1.31
8.5	10.1	11.6	13.2	14.8	15.3	16.4	19.5	22.7	25.8	26.6	30.5	34.5	38.4	42.4	46.3	51.2	55.7	62.0	77.8	1.33
10.7	12.3	13.9	15.4	17.0	17.5	18.6	21.7	24.9	28.0	28.8	32.8	36.7	40.6	44.6	48.5	53.4	58.0	64.3	80.0	1.33
11.8	13.4	15.0	16.5	18.1	18.6	19.7	22.8	26.0	29.1	29.9	33.9	37.8	41.7	45.7	49.6	54.5	59.1	65.4	81.1	1.33
12.9	14.5	16.1	17.6	19.2	19.7	20														

High HP HTS® 8mm Drive Selection Tables



Sprocket Combination					HP Ratings @1750 RPM Driver											
Drive	Driver		Driven		DN	RPP Panther Belt Widths (mm)										
Ratio	No. Teeth	P.D.	No. Teeth	P.D.	RPM	12	22	35	60	480	560	600	640	720	800	
Multiply HP rating by the belt length factor to determine drive width - BELT LENGTH FACTOR										0.8	0.8	0.8	0.9	0.9	0.9	
1.36	22	2.21	30	3.01	1283	6.73	12.35	19.66	33.71	5.3	6.9	7.7	8.5	10.1	11.7	
1.38	32	3.21	44	4.41	1273	10.07	18.47	29.40	50.41		5.0	5.8	6.6	8.2	9.8	
1.38	26	2.61	36	3.61	1264	8.06	14.78	23.53	40.34	4.5	6.1	6.9	7.7	9.3	10.9	
1.40	80	8.02	112	11.23	1250	26.51	48.64	77.42	132.74							
1.40	40	4.01	56	5.61	1250	12.78	23.45	37.32	63.99				5.0	6.6	8.2	
1.41	64	6.42	90	9.02	1244	21.02	38.57	61.39	105.26							
1.41	34	3.41	48	4.81	1240	10.74	19.71	31.37	53.79		4.5	5.3	6.1	7.7	9.3	
1.42	24	2.41	34	3.41	1235	7.39	13.56	21.59	37.01	4.9	6.4	7.2	8.0	9.6	11.2	
1.43	56	5.61	80	8.02	1225	18.27	33.52	53.35	91.47							
1.43	28	2.81	40	4.01	1225	8.72	16.01	25.47	43.68	4.1	5.6	6.4	7.2	8.8	10.4	
1.45	44	4.41	64	6.42	1203	14.15	25.96	41.31	70.84					5.6	7.2	
1.45	22	2.21	32	3.21	1203	6.73	12.35	19.66	33.71	5.2	6.8	7.5	8.3	9.9	11.5	
1.46	26	2.61	38	3.81	1197	8.06	14.78	23.53	40.34	4.4	6.0	6.7	7.5	9.1	10.7	
1.47	38	3.81	56	5.61	1188	12.10	22.20	35.33	60.58				5.1	6.7	8.3	
1.47	30	3.01	44	4.41	1193	9.40	17.24	27.43	47.04		5.2	5.9	6.7	8.3	9.9	
1.50	48	4.81	72	7.22	1167	15.52	28.47	45.32	77.70						6.2	
1.50	32	3.21	48	4.81	1167	10.07	18.47	29.40	50.41		4.7	5.5	6.3	7.8	9.4	
1.50	24	2.41	36	3.61	1167	7.39	13.56	21.59	37.01	4.7	6.3	7.1	7.9	9.4	11.0	
1.54	26	2.61	40	4.01	1138	8.06	14.78	23.53	40.34	4.2	5.8	6.6	7.4	9.0	10.5	
1.55	22	2.21	34	3.41	1132	6.73	12.35	19.66	33.71	5.0	6.6	7.4	8.2	9.8	11.3	
1.56	72	7.22	112	11.23	1125	23.77	43.62	69.42	119.03							
1.56	36	3.61	56	5.61	1125	11.42	20.95	33.35	57.18				5.3	6.9	8.4	
1.57	28	2.81	44	4.41	1114	8.72	16.01	25.47	43.68	3.7	5.3	6.1	6.9	8.5	10.1	
1.58	24	2.41	38	3.81	1105	7.39	13.56	21.59	37.01	4.5	6.1	6.9	7.7	9.3	10.8	
1.60	40	4.01	64	6.42	1094	12.78	23.45	37.32	63.99					5.9	7.5	
1.60	30	3.01	48	4.81	1094	9.40	17.24	27.43	47.04		4.8	5.6	6.4	8.0	9.6	
1.61	56	5.61	90	9.02	1089	18.27	33.52	53.35	91.47						6.5	
1.64	44	4.41	72	7.22	1069	14.15	25.96	41.31	70.84						6.5	
1.64	22	2.21	36	3.61	1069	6.73	12.35	19.66	33.71	4.8	6.4	7.2	8.0	9.6	11.2	
1.65	34	3.41	56	5.61	1063	10.74	19.71	31.37	53.79			4.6	5.4	7.0	8.6	
1.67	48	4.81	80	8.02	1050	15.52	28.47	45.32	77.70							
1.67	24	2.41	40	4.01	1050	7.39	13.56	21.59	37.01	4.3	5.9	6.7	7.5	9.1	10.7	
1.68	38	3.81	64	6.42	1039	12.10	22.20	35.33	60.58					6.0	7.6	
1.69	26	2.61	44	4.41	1034	8.06	14.78	23.53	40.34	3.8	5.4	6.2	7.0	8.6	10.2	
1.71	28	2.81	48	4.81	1021	8.72	16.01	25.47	43.68		4.9	5.7	6.5	8.1	9.7	
1.73	22	2.21	38	3.81	1013	6.73	12.35	19.66	33.71	4.7	6.3	7.0	7.8	9.4	11.0	
1.75	64	6.42	112	11.23	1000	21.02	38.57	61.39	105.26							
1.75	32	3.21	56	5.61	1000	10.07	18.47	29.40	50.41			4.7	5.5	7.1	8.7	
1.78	36	3.61	64	6.42	984	11.42	20.95	33.35	57.18					6.1	7.8	
1.80	80	8.02	144	14.44	972	26.51	48.64	77.42	132.74							
1.80	40	4.01	72	7.22	972	12.78	23.45	37.32	63.99						6.7	
1.82	44	4.41	80	8.02	963	14.15	25.96	41.31	70.84							
1.82	22	2.21	40	4.01	963	6.73	12.35	19.66	33.71	4.5	6.1	6.9	7.7	9.3	10.8	
1.83	24	2.41	44	4.41	955	7.39	13.56	21.59	37.01	4.0	5.6	6.4	7.2	8.8	10.4	
1.85	26	2.61	48	4.81	948	8.06	14.78	23.53	40.34		5.1	5.9	6.7	8.3	9.9	
1.87	30	3.01	56	5.61	938	9.40	17.24	27.43	47.04			4.9	5.7	7.3	8.9	
1.88	48	4.81	90	9.02	933	15.52	28.47	45.32	77.70							
1.88	34	3.41	64	6.42	930	10.74	19.71	31.37	53.79					6.3	7.9	
1.89	38	3.81	72	7.22	924	12.10	22.20	35.33	60.58						6.9	
2.00	72	7.22	144	14.44	875	23.77	43.62	69.42	119.03							
2.00	56	5.61	112	11.23	875	18.27	33.52	53.35	91.47							
2.00	40	4.01	80	8.02	875	12.78	23.45	37.32	63.99							
2.00	36	3.61	72	7.22	875	11.42	20.95	33.35	57.18						7.0	
2.00	32	3.21	64	6.42	875	10.07	18.47	29.40	50.41					6.4	8.0	
2.00	28	2.81	56	5.61	875	8.72	16.01	25.47	43.68			5.0	5.8	7.4	9.0	
2.00	24	2.41	48	4.81	875	7.39	13.56	21.59	37.01		5.2	6.0	6.8	8.4	10.0	
2.00	22	2.21	44	4.41	875	6.73	12.35	19.66	33.71	4.1	5.7	6.5	7.3	8.9	10.5	
2.05	44	4.41	90	9.02	856	14.15	25.96	41.31	70.84							
2.11	38	3.81	80	8.02	831	12.10	22.20	35.33	60.58						6.1	
2.12	34	3.41	72	7.22	826	10.74	19.71	31.37	53.79					5.5	7.2	
2.13	30	3.01	64	6.42	820	9.40	17.24	27.43	47.04				4.9	6.6	8.2	
2.15	26	2.61	56	5.61	813	8.06	14.78	23.53	40.34		4.3	5.1	6.0	7.6	9.2	
2.18	22	2.21	48	4.81	802	6.73	12.35	19.66	33.71	3.7	5.4	6.2	7.0	8.6	10.2	
2.22	36	3.61	80	8.02	788	11.42	20.95	33.35	57.18						6.2	
2.25	64	6.42	144	14.44	778	21.02	38.57	61.39	105.26							
Multiply HP rating by the belt length factor to determine drive width - BELT LENGTH FACTOR										0.8	0.8	0.8	0.9	0.9	0.9	



High HP HTS® 8mm Drive Selection Tables

Theoretical Center Distance in Inches for Various Belt Lengths																				
Belt Length Code (mm)																				
880	960	1040	1120	1200	1224	1280	1440	1600	1760	1800	2000	2200	2400	2600	2800	3048	3280	3600	4400	Drive Ratio
0.9	1	1	1	1	1	1.1	1.1	1.1	1.2	1.2	1.2	1.2	1.3	1.3	1.4	1.4	1.4	1.5	1.5	
13.2	14.8	16.4	18.0	19.5	20.0	21.1	24.3	27.4	30.6	31.3	35.3	39.2	43.2	47.1	51.0	55.9	60.5	66.8	82.5	1.36
11.3	12.9	14.5	16.1	17.6	18.1	19.2	22.4	25.5	28.7	29.4	33.4	37.3	41.3	45.2	49.1	54.0	58.6	64.9	80.6	1.38
12.4	14.0	15.6	17.2	18.7	19.2	20.3	23.5	26.6	29.8	30.6	34.5	38.4	42.4	46.3	50.2	55.1	59.7	66.0	81.7	1.38
						10.0	13.1	16.3	19.5	20.3	24.2	28.1	32.1	36.0	40.0	44.9	49.4	55.7	71.5	1.40
9.7	11.3	12.9	14.5	16.0	16.5	17.6	20.8	23.9	27.1	27.9	31.8	35.7	39.7	43.6	47.6	52.4	57.0	63.3	79.1	1.40
		8.2	9.8	11.4	11.9	13.0	16.2	19.3	22.5	23.3	27.2	31.2	35.1	39.0	43.0	47.9	52.4	58.7	74.5	1.41
10.8	12.4	14.0	15.6	17.2	17.6	18.7	21.9	25.0	28.2	29.0	32.9	36.8	40.8	44.7	48.7	53.5	58.1	64.4	80.2	1.41
12.8	14.3	15.9	17.5	19.1	19.5	20.6	23.8	26.9	30.1	30.9	34.8	38.7	42.7	46.6	50.6	55.4	60.0	66.3	82.1	1.42
	8.1	9.7	11.3	12.9	13.3	14.4	17.6	20.8	23.9	24.7	28.6	32.6	36.5	40.5	44.4	49.3	53.8	60.2	75.9	1.43
12.0	13.5	15.1	16.7	18.3	18.7	19.8	23.0	26.1	29.3	30.1	34.0	38.0	41.9	45.8	49.8	54.6	59.2	65.5	81.3	1.43
8.8	10.4	11.9	13.5	15.1	15.6	16.7	19.8	23.0	26.1	26.9	30.9	34.8	38.7	42.7	46.6	51.5	56.1	62.4	78.1	1.45
13.1	14.6	16.2	17.8	19.4	19.8	20.9	24.1	27.2	30.4	31.2	35.1	39.1	43.0	46.9	50.9	55.8	60.3	66.6	82.4	1.45
12.3	13.9	15.4	17.0	18.6	19.1	20.2	23.3	26.5	29.6	30.4	34.3	38.3	42.2	46.1	50.1	55.0	59.5	65.8	81.6	1.46
9.9	11.5	13.0	14.6	16.2	16.7	17.8	20.9	24.1	27.2	28.0	32.0	35.9	39.8	43.8	47.7	52.6	57.2	63.5	79.2	1.47
11.5	13.1	14.6	16.2	17.8	18.3	19.4	22.5	25.7	28.8	29.6	33.5	37.5	41.4	45.4	49.3	54.2	58.7	65.0	80.8	1.47
7.8	9.4	11.0	12.5	14.1	14.6	15.7	18.9	22.0	25.2	26.0	29.9	33.8	37.8	41.7	45.7	50.5	55.1	61.4	77.2	1.50
11.0	12.6	14.2	15.7	17.3	17.8	18.9	22.0	25.2	28.3	29.1	33.1	37.0	40.9	44.9	48.8	53.7	58.3	64.6	80.3	1.50
12.6	14.2	15.7	17.3	18.9	19.4	20.5	23.6	26.8	29.9	30.7	34.6	38.6	42.5	46.5	50.4	55.3	59.8	66.1	81.9	1.50
12.1	13.7	15.3	16.8	18.4	18.9	20.0	23.1	26.3	29.4	30.2	34.2	38.1	42.0	46.0	49.9	54.8	59.4	65.7	81.4	1.54
12.9	14.5	16.1	17.6	19.2	19.7	20.8	23.9	27.1	30.2	31.0	35.0	38.9	42.8	46.8	50.7	55.6	60.2	66.5	82.2	1.55
					9.4	10.5	13.7	16.9	20.1	20.9	24.8	28.8	32.7	36.6	40.6	45.5	50.0	56.3	72.1	1.56
10.0	11.6	13.2	14.8	16.4	16.8	17.9	21.1	24.2	27.4	28.2	32.1	36.1	40.0	43.9	47.9	52.8	57.3	63.6	79.4	1.56
11.6	13.2	14.8	16.4	17.9	18.4	19.5	22.7	25.8	29.0	29.8	33.7	37.6	41.6	45.5	49.4	54.3	58.9	65.2	80.9	1.57
12.4	14.0	15.6	17.2	18.7	19.2	20.3	23.5	26.6	29.8	30.5	34.5	38.4	42.4	46.3	50.2	55.1	59.7	66.0	81.7	1.58
9.1	10.6	12.2	13.8	15.4	15.9	17.0	20.1	23.3	26.4	27.2	31.2	35.1	39.0	43.0	46.9	51.8	56.4	62.7	78.4	1.60
11.1	12.7	14.3	15.9	17.5	17.9	19.0	22.2	25.3	28.5	29.3	33.2	37.2	41.1	45.0	49.0	53.9	58.4	64.7	80.5	1.60
		8.8	10.4	12.0	12.5	13.6	16.8	19.9	23.1	23.9	27.8	31.8	35.7	39.7	43.6	48.5	53.0	59.4	75.1	1.61
8.1	9.7	11.3	12.8	14.4	14.9	16.0	19.2	22.3	25.5	26.3	30.2	34.1	38.1	42.0	46.0	50.9	55.4	61.7	77.5	1.64
12.7	14.3	15.9	17.5	19.0	19.5	20.6	23.8	26.9	30.1	30.9	34.8	38.7	42.7	46.6	50.6	55.4	60.0	66.3	82.0	1.64
10.2	11.8	3.3	14.9	16.5	17.0	18.1	21.2	24.4	27.5	28.3	32.3	36.2	40.1	44.1	48.0	52.9	57.5	63.8	79.5	1.65
7.1	8.7	10.3	11.9	13.5	13.9	15.0	18.2	21.4	24.5	25.3	29.3	33.2	37.1	41.1	45.0	49.9	54.5	60.8	76.5	1.67
12.3	13.8	15.4	17.0	18.6	19.0	20.1	23.3	26.4	29.6	30.4	34.3	38.3	42.2	46.1	50.1	55.0	59.5	65.8	81.6	1.67
9.2	10.8	12.4	14.0	15.5	16.0	17.1	20.3	23.4	26.6	27.4	31.3	35.3	39.2	43.1	47.1	52.0	56.5	62.8	78.6	1.68
11.8	13.4	14.9	16.5	18.1	18.6	19.7	22.8	26.0	29.1	29.9	33.9	37.8	41.7	45.7	49.6	54.5	59.1	65.4	81.1	1.69
11.3	12.9	14.5	16.0	17.6	18.1	19.2	22.3	25.5	28.6	29.4	33.4	37.3	41.3	45.2	49.1	54.0	58.6	64.9	80.6	1.71
12.6	14.2	15.7	17.3	18.9	19.4	20.5	23.6	26.8	29.9	30.7	34.6	38.6	42.5	46.5	50.4	55.3	59.8	66.1	81.9	1.73
			9.5	9.9	11.1	14.3	17.5	20.7	23.9	24.7	28.6	32.6	36.5	40.5	44.4	49.3	53.8	60.2	75.9	1.75
10.3	11.9	13.5	15.1	16.7	17.1	18.2	21.4	24.5	27.7	28.5	32.4	36.4	40.3	44.2	48.2	53.1	57.6	63.9	79.7	1.75
9.3	10.9	12.5	14.1	15.7	16.2	17.3	20.4	23.6	26.7	27.5	31.5	35.4	39.4	43.3	47.2	52.1	56.7	63.0	78.7	1.78
						13.5	16.7	17.5	21.5	25.5	29.4	33.4	37.3	41.3	45.2	49.1	54.0	60.3	76.0	1.80
8.4	10.0	11.5	13.1	14.7	15.2	16.3	19.5	22.6	25.8	26.6	30.5	34.5	38.4	42.3	46.3	51.2	55.7	62.0	77.8	1.80
7.3	9.0	10.6	12.2	13.7	14.2	15.3	18.5	21.7	24.8	25.6	29.6	33.5	37.4	41.4	45.3	50.2	54.8	61.1	76.8	1.82
12.4	14.0	15.6	17.1	18.7	19.2	20.3	23.5	26.6	29.8	30.5	34.5	38.4	42.4	46.3	50.2	55.1	59.7	66.0	81.7	1.82
11.9	13.5	15.1	16.7	18.2	18.7	19.8	23.0	26.1	29.3	30.1	34.0	37.9	41.9	45.8	49.8	54.6	59.2	65.5	81.3	1.83
11.4	13.0	14.6	16.2	17.8	18.2	19.3	22.5	25.7	28.8	29.6	33.5	37.5	41.4	45.3	49.3	54.2	58.7	65.0	80.8	1.85
10.5	12.1	13.6	15.2	16.8	17.3	18.4	21.5	24.7	27.8	28.6	32.6	36.5	40.5	44.4	48.3	53.2	57.8	64.1	79.8	1.87
	7.7	9.4	11.0	12.6	13.1	14.2	17.4	20.5	23.7	24.5	28.4	32.4	36.3	40.3	44.2	49.1	53.7	59.7	75.7	1.88
9.5	11.1	12.7	14.3	15.8	16.3	17.4	20.6	23.7	26.9	27.7	31.6	35.6	39.5	43.4	47.4	52.3	56.8	63.1	78.9	1.88
8.5	10.1	11.7	13.3	14.9	15.3	16.5	19.6	22.8	25.9	26.7	30.7	34.6	38.5	42.5	46.4	51.3	55.9	62.2	77.9	1.89
						14.0	17.3	18.1	22.1	26.1	30.0	34.0	37.9	41.9	45.8	50.7	55.2	61.5	77.3	2.00
7.6	9.2	10.8	12.4	14.0	14.5	15.6	18.8	22.0	25.1	25.9	29.9	33.8	37.7	41.7	45.6	50.5	55.1	61.4	77.1	2.00
8.6	10.2	11.8	13.4	15.0	15.5	16.6	19.8	22.9	26.1	26.9	30.8	34.8	38.7	42.6	46.6	51.5	56.0	62.3	78.1	2.00
9.6	11.2	12.8	14.4	16.0	16.5	17.6	20.7	23.9	27.0	27.8	31.8	35.7	39.7	43.6	47.5	52.4	57.0	63.3	79.0	2.00
10.6	12.2	13.8	15.4	17.0	17.4	18.5	21.7	24.8	28.0	28.8	32.7	36.7	40.6	44.5	48.5	53.4	57.9	64.2	80.0	2.00
11.6	13.2	14.8	16.3	17.9	18.4	19.5	22.7	25.8	29.0	29.7	33.7	37.6	41.6	45.5	49.4	54.3	58.9	65.2	80.9	2.00
12.1	13.7	15.2	16.8	18.4	18.9	20.0	23.1	26.3	29.4	30.2	34.2	38.1	42.0	46.0	49.9	54.8	59.4	65.7	81.4	2.00
	8.0	9.6	11.3	12.9	13.3	14.4	17.6	20.8	24.0	24.8	28.7	32.7	36.6	40.6	44.5	49.4	54.0	60.3	76.0	2.05
7.7	9.4	11.0	12.6	14.2	14.7	15.8	18.9	22.1	25.3	26.1	30.0	34.0	37.9	41.8	45.8	50.7	55.2	61.5	77.3	2.11
8.8	10.4	12.0	13.6	15.2	15.6	16.7	19.9	23.1	26.2	27.0	31.0	34.9	38.9	42.8	46.7	51.6	56.2	62.5	78.2	2.12
9.8	11.4	13.0	14.6	16.1	16.6	17.7	20.9	24.0	27.2	28.0	31.9	35.9	39.8	43.8	47.7	52.6	57.1	63.4	79.2	2.13
10.8	12.4	13.9	15.5	17.1	17.6	18.7	21.8	25.0	28.2	28.9	32.9	36.8	40.8	44.7	48.6	53.5	58.1	64.4	80.1	2.15
11.7	13.3	14.9	16.5	18.1	18.5	19.6	22.8	26.0	29.1	29.9	33.8	37.8	41.7	45.7	49.6	54.5	59.0	65.3		

High HP HTS® 8mm Drive Selection Tables



Sprocket Combination						HP Ratings @1750 RPM Driver									
Drive	Driver		Driven		DN	RPP Panther Belt Widths (mm)									
Ratio	No. Teeth	P.D.	No. Teeth	P.D.	RPM	12	22	35	60	480	560	600	640	720	800
Multiply HP rating by the belt length factor to determine drive width - BELT LENGTH FACTOR										0.8	0.8	0.8	0.9	0.9	0.9
2.25	40	4.01	90	9.02	778	12.78	23.45	37.32	63.99						
2.25	32	3.21	72	7.22	778	10.07	18.47	29.40	50.41						
2.29	28	2.81	64	6.42	766	8.72	16.01	25.47	43.68			5.0	6.7	5.6	7.3
2.33	48	4.81	112	11.23	750	15.52	28.47	45.32	77.70						
2.33	24	2.41	56	5.61	750	7.39	13.56	21.59	37.01						
2.35	34	3.41	80	8.02	744	10.74	19.71	31.37	53.79		4.4	5.3	6.1	7.7	9.3
2.37	38	3.81	90	9.02	739	12.10	22.20	35.33	60.58						6.4
2.40	80	8.02	192	19.25	729	26.51	48.64	77.42	132.74						
2.40	30	3.01	72	7.22	729	9.40	17.24	27.43	47.04					5.8	7.4
2.46	26	2.61	64	6.42	711	8.06	14.78	23.53	40.34				5.2	6.8	8.5
2.50	36	3.61	90	9.02	700	11.42	20.95	33.35	57.18						
2.50	32	3.21	80	8.02	700	10.07	18.47	29.40	50.41						6.5
2.55	44	4.41	112	11.23	688	14.15	25.96	41.31	70.84						
2.55	22	2.21	56	5.61	688	6.73	12.35	19.66	33.71		4.6	5.4	6.2	7.9	9.5
2.57	56	5.61	144	14.44	681	18.27	33.52	53.35	91.47						
2.57	28	2.81	72	7.22	681	8.72	16.01	25.47	43.68					5.9	7.6
2.65	34	3.41	90	9.02	661	10.74	19.71	31.37	53.79						
2.67	72	7.22	192	19.25	656	23.77	43.62	69.42	119.03						
2.67	30	3.01	80	8.02	656	9.40	17.24	27.43	47.04						6.6
2.67	24	2.41	64	6.42	656	7.39	13.56	21.59	37.01			4.4	5.3	7.0	8.6
2.77	26	2.61	72	7.22	632	8.06	14.78	23.53	40.34					6.0	7.7
2.80	40	4.01	112	11.23	625	12.78	23.45	37.32	63.99						
2.81	32	3.21	90	9.02	622	10.07	18.47	29.40	50.41						
2.86	28	2.81	80	8.02	613	8.72	16.01	25.47	43.68						6.7
2.91	22	2.21	64	6.42	602	6.73	12.35	19.66	33.71			4.5	5.4	7.1	8.7
2.95	38	3.81	112	11.23	594	12.10	22.20	35.33	60.58						
3.00	64	6.42	192	19.25	583	21.02	38.57	61.39	105.26						
3.00	48	4.81	144	14.44	583	15.52	28.47	45.32	77.70						
3.00	30	3.01	90	9.02	583	9.40	17.24	27.43	47.04						
3.00	24	2.41	72	7.22	583	7.39	13.56	21.59	37.01					6.1	7.8
3.08	26	2.61	80	8.02	569	8.06	14.78	23.53	40.34						6.9
3.11	36	3.61	112	11.23	563	11.42	20.95	33.35	57.18						
3.21	28	2.81	90	9.02	544	8.72	16.01	25.47	43.68						
3.27	44	4.41	144	14.44	535	14.15	25.96	41.31	70.84						
3.27	22	2.21	72	7.22	535	6.73	12.35	19.66	33.71					6.3	8.0
3.29	34	3.41	112	11.23	531	10.74	19.71	31.37	53.79						
3.33	24	2.41	80	8.02	525	7.39	13.56	21.59	37.01						7.0
3.43	56	5.61	192	19.25	510	18.27	33.52	53.35	91.47						
3.46	26	2.61	90	9.02	506	8.06	14.78	23.53	40.34						
3.50	32	3.21	112	11.23	500	10.07	18.47	29.40	50.41						
3.60	40	4.01	144	14.44	486	12.78	23.45	37.32	63.99						
3.64	22	2.21	80	8.02	481	6.73	12.35	19.66	33.71					5.3	7.1
3.73	30	3.01	112	11.23	469	9.40	17.24	27.43	47.04						
3.75	24	2.41	90	9.02	467	7.39	13.56	21.59	37.01						5.8
3.79	38	3.81	144	14.44	462	12.10	22.20	35.33	60.58						
4.00	48	4.81	192	19.25	438	15.52	28.47	45.32	77.70						
4.00	36	3.61	144	14.44	438	11.42	20.95	33.35	57.18						
4.00	28	2.81	112	11.23	438	8.72	16.01	25.47	43.68						
4.09	22	2.21	90	9.02	428	6.73	12.35	19.66	33.71						5.9
4.24	34	3.41	144	14.44	413	10.74	19.71	31.37	53.79						
4.31	26	2.61	112	11.23	406	8.06	14.78	23.53	40.34						
4.36	44	4.41	192	19.25	401	14.15	25.96	41.31	70.84						
4.50	32	3.21	144	14.44	389	10.07	18.47	29.40	50.41						
4.67	24	2.41	112	11.23	375	7.39	13.56	21.59	37.01						
4.80	40	4.01	192	19.25	365	12.78	23.45	37.32	63.99						
4.80	30	3.01	144	14.44	365	9.40	17.24	27.43	47.04						
5.05	38	3.81	192	19.25	346	12.10	22.20	35.33	60.58						
5.09	22	2.21	112	11.23	344	6.73	12.35	19.66	33.71						
5.14	28	2.81	144	14.44	340	8.72	16.01	25.47	43.68						
5.33	36	3.61	192	19.25	328	11.42	20.95	33.35	57.18						
5.54	26	2.61	144	14.44	316	8.06	14.78	23.53	40.34						
5.65	34	3.41	192	19.25	310	10.74	19.71	31.37	53.79						
6.00	32	3.21	192	19.25	292	10.07	18.47	29.40	50.41						
6.00	24	2.41	144	14.44	292	7.39	13.56	21.59	37.01						
6.40	30	3.01	192	19.25	273	9.40	17.24	27.43	47.04						
6.55	22	2.21	144	14.44	267	6.73	12.35	19.66	33.71						
6.86	28	2.81	192	19.25	255	8.72	16.01	25.47	43.68						
7.38	26	2.61	192	19.25	237	8.06	14.78	23.53	40.34						
8.00	24	2.41	192	19.25	219	7.39	13.56	21.59	37.01						
8.73	22	2.21	192	19.25	201	6.73	12.35	19.66	33.71						
Multiply HP rating by the belt length factor to determine drive width - BELT LENGTH FACTOR										0.8	0.8	0.8	0.9	0.9	0.9



High HP HTS® 8mm Drive Selection Tables

Theoretical Center Distance in Inches for Various Belt Lengths																					
Belt Length Code (mm)																					
880	960	1040	1120	1200	1224	1280	1440	1600	1760	1800	2000	2200	2400	2600	2800	3048	3280	3600	4400	Drive	
0.9	1	1	1	1	1	1.1	1.1	1.1	1.2	1.2	1.2	1.2	1.3	1.3	1.4	1.4	1.4	1.5	1.5	Ratio	
6.6	8.3	9.9	11.5	13.2	13.6	14.8	17.9	21.1	24.3	25.1	29.0	33.0	36.9	40.9	44.8	49.7	54.3	60.6	76.3	2.25	
8.9	10.5	12.1	13.7	15.3	15.8	16.9	20.1	23.2	26.4	27.2	31.1	35.1	39.0	43.0	46.9	51.8	56.3	62.7	78.4	2.25	
9.9	11.5	13.1	14.7	16.3	16.8	17.9	21.0	24.2	27.3	28.1	32.1	36.0	40.0	43.9	47.8	52.7	57.3	63.6	79.4	2.29	
			8.9	10.5	11.0	12.2	15.4	18.6	21.8	22.6	26.6	30.5	34.5	38.5	42.4	47.3	51.9	58.2	74.0	2.33	
10.9	12.5	14.1	15.7	17.3	17.7	18.8	22.0	25.2	28.3	29.1	33.0	37.0	40.9	44.9	48.8	53.7	58.3	64.6	80.3	2.33	
8.0	9.6	11.3	12.9	14.5	14.9	16.1	19.2	22.4	25.6	26.4	30.3	34.3	38.2	42.1	46.1	51.0	55.5	61.9	77.6	2.35	
6.7	8.4	10.1	11.7	13.3	13.8	14.9	18.1	21.3	24.4	25.2	29.2	33.1	37.1	41.0	45.0	49.9	54.4	60.7	76.5	2.37	
											17.0	21.1	25.2	29.2	33.2	38.2	42.8	49.1	65.0	2.40	
9.1	10.7	12.3	13.9	15.5	15.9	17.0	20.2	23.4	26.5	27.3	31.3	35.2	39.2	43.1	47.0	51.9	56.5	62.8	78.6	2.40	
10.1	11.7	13.3	14.8	16.4	16.9	18.0	21.2	24.3	27.5	28.3	32.2	36.2	40.1	44.1	48.0	52.9	57.5	63.8	79.5	2.46	
6.9	8.5	10.2	11.8	13.4	13.9	15.0	18.2	21.4	24.6	25.4	29.3	33.3	37.2	41.2	45.1	50.0	54.6	60.9	76.7	2.50	
8.2	9.8	11.4	13.0	14.6	15.1	16.2	19.4	22.6	25.7	26.5	30.5	34.4	38.4	42.3	46.2	51.1	55.7	62.0	77.8	2.50	
			9.1	10.8	11.3	12.4	15.7	18.9	22.1	22.9	26.9	30.8	34.8	38.8	42.7	47.6	52.2	58.5	74.3	2.55	
11.1	12.6	14.2	15.8	17.4	17.9	19.0	22.1	25.3	28.5	29.2	33.2	37.1	41.1	45.0	49.0	53.8	58.4	64.7	80.5	2.55	
							11.8	15.1	18.4	19.2	23.2	27.2	31.2	35.2	39.1	44.0	48.6	54.9	70.7	2.57	
9.2	10.8	12.4	14.0	15.6	16.1	17.2	20.4	23.5	26.7	27.5	31.4	35.4	39.3	43.3	47.2	52.1	56.7	63.0	78.7	2.57	
7.0	8.7	10.3	12.0	13.6	14.1	15.2	18.4	21.6	24.7	25.5	29.5	33.4	37.4	41.3	45.3	50.2	54.7	61.0	76.8	2.65	
											13.3	17.5	21.7	25.8	29.8	33.8	38.7	43.4	49.7	65.6	2.67
8.3	9.9	11.5	13.2	14.8	15.2	16.3	19.5	22.7	25.9	26.7	30.6	34.6	38.5	42.5	46.4	51.3	55.9	62.2	77.9	2.67	
10.2	11.8	13.4	15.0	16.6	17.1	18.2	21.3	24.5	27.6	28.4	32.4	36.3	40.3	44.2	48.2	53.0	57.6	63.9	79.7	2.67	
9.3	10.9	12.5	14.1	15.7	16.2	17.3	20.5	23.7	26.8	27.6	31.6	35.5	39.5	43.4	47.4	52.2	56.8	63.1	78.9	2.77	
		7.6	9.4	11.1	11.6	12.7	16.0	19.2	22.4	23.2	27.2	31.1	35.1	39.1	43.0	47.9	52.5	58.8	74.6	2.80	
7.1	8.8	10.5	12.1	13.7	14.2	15.3	18.5	21.7	24.9	25.7	29.6	33.6	37.5	41.5	45.4	50.3	54.9	61.2	77.0	2.81	
8.4	10.1	11.7	13.3	14.9	15.4	16.5	19.7	22.8	26.0	26.8	30.8	34.7	38.7	42.6	46.5	51.4	56.0	62.3	78.1	2.86	
10.3	11.9	13.5	15.1	16.7	17.2	18.3	21.5	24.6	27.8	28.6	32.5	36.5	40.4	44.4	48.3	53.2	57.8	64.1	79.8	2.91	
		7.8	9.5	11.2	11.7	12.9	16.1	19.3	22.5	23.3	27.3	31.3	35.2	39.2	43.2	48.1	52.6	58.9	74.7	2.95	
									12.9	13.8	18.1	22.2	26.3	30.3	34.4	39.3	43.9	50.3	66.2	3.00	3.00
7.2	8.9	10.6	12.2	13.9	14.3	15.5	18.7	21.8	25.0	25.8	29.8	33.7	37.7	41.6	45.6	50.5	55.0	61.3	77.1	3.00	
9.5	11.1	12.7	14.3	15.9	16.4	17.5	20.7	23.8	27.0	27.8	31.7	35.7	39.6	43.6	47.5	52.4	57.0	63.3	79.0	3.00	
8.5	10.2	11.8	13.4	15.0	15.5	16.6	19.8	23.0	26.2	27.0	30.9	34.9	38.8	42.8	46.7	51.6	56.2	62.5	78.2	3.08	
		7.9	9.6	11.3	11.8	13.0	16.2	19.5	22.7	23.5	27.5	31.4	35.4	39.3	43.3	48.2	52.8	59.1	74.9	3.11	
7.4	9.1	10.7	12.4	14.0	14.5	15.6	18.8	22.0	25.2	26.0	29.9	33.9	37.8	41.8	45.7	50.6	55.2	61.5	77.3	3.21	
							12.5	15.9	19.2	20.0	24.0	28.1	32.1	36.0	40.0	44.9	49.5	55.8	71.6	3.27	
9.6	11.2	12.8	14.4	16.0	16.5	17.6	20.8	24.0	27.1	27.9	31.9	35.8	39.8	43.7	47.7	52.5	57.1	63.4	79.2	3.27	
		8.0	9.8	11.5	12.0	13.1	16.4	19.6	22.8	23.6	27.6	31.6	35.5	39.5	43.5	48.4	52.9	59.2	75.0	3.29	
8.7	10.3	12.0	13.6	15.2	15.7	16.8	20.0	23.1	26.3	27.1	31.1	35.0	39.0	42.9	46.9	51.7	56.3	62.6	78.4	3.33	
									13.3	14.2	18.6	22.8	26.9	30.9	34.9	39.9	44.5	50.9	66.7	3.43	3.43
7.5	9.2	10.9	12.5	14.1	14.6	15.7	18.9	22.1	25.3	26.1	30.1	34.0	38.0	41.9	45.9	50.8	55.3	61.7	77.4	3.46	
		8.1	9.9	11.6	12.1	13.3	16.5	19.8	23.0	23.8	27.7	31.7	35.7	39.6	43.6	48.5	53.1	59.4	75.2	3.50	3.50
							12.8	16.2	19.5	20.3	24.3	28.3	32.3	36.3	40.3	45.2	49.8	56.1	71.9	3.60	3.60
8.8	10.5	12.1	13.7	15.3	15.8	16.9	20.1	23.3	26.5	27.3	31.2	35.2	39.1	43.1	47.0	51.9	56.5	62.8	78.5	3.64	3.64
		8.2	10.0	11.7	12.2	13.4	16.7	19.9	23.1	23.9	27.9	31.9	35.8	39.8	43.7	48.7	53.2	59.5	75.3	3.73	3.73
7.6	9.3	11.0	12.6	14.3	14.8	15.9	19.1	22.3	25.5	26.3	30.2	34.2	38.1	42.1	46.0	50.9	55.5	61.8	77.6	3.75	3.75
						9.3	12.9	16.3	19.6	20.4	24.5	28.5	32.5	36.5	40.4	45.4	50.0	56.3	72.1	3.79	3.79
									13.8	14.7	19.1	23.3	27.4	31.5	35.5	40.5	45.1	51.5	67.3	4.00	4.00
							9.4	13.0	16.4	17.2	21.5	25.6	29.6	33.6	37.6	41.6	46.5	52.8	68.6	4.00	4.00
							13.5	16.8	20.0	20.8	24.8	28.8	32.8	36.8	40.8	45.7	51.0	57.3	73.1	4.00	4.00
							16.0	19.2	22.4	23.2	27.2	31.2	35.2	39.2	43.2	48.1	52.6	58.9	74.7	4.09	4.09
							9.5	13.2	16.6	17.4	21.7	25.8	29.8	33.8	37.8	42.7	48.0	54.3	70.1	4.24	4.24
									14.1	15.0	19.4	23.6	27.7	31.7	35.8	40.7	45.4	51.8	67.6	4.31	4.31
									14.1	15.0	19.4	23.6	27.7	31.7	35.8	40.7	45.4	51.8	67.6	4.36	4.36
							9.7	13.3	16.7	17.5	21.9	26.0	30.0	34.0	38.0	42.9	48.2	54.5	70.3	4.50	4.50
									13.3	14.2	18.6	22.8	26.9	30.9	34.9	39.9	44.5	50.9	66.7	4.67	4.67
									14.3	15.2	19.6	23.8	27.9	32.0	36.0	41.0	45.7	52.0	67.9	4.80	4.80
							9.8	13.4	16.8	17.6	22.0	26.1	30.1	34.1	38.1	43.0	48.3	54.6	70.4	4.80	4.80
									14.4	15.3	19.7	23.9	28.1	32.1	36.2	41.2	45.8	52.2	68.1	5.05	5.05
									14.4	15.3	19.7	23.9	28.1	32.1	36.2	41.2	45.8	52.2	68.1	5.09	5.09
	6.8	8.7	10.5	12.2	12.7	13.9	17.2	20.5	23.7	24.5	28.5	32.4	36.4	40.4	44.3	49.2	53.8	60.2	75.9	5.14	5.14
							9.9	13.5	16.9	17.7	22.1	26.2	30.2	34.2	38.2	43.1	48.4	54.7	70.5	5.33	5.33
									14.5	15.5	19.9	24.1	28.2	32.3	36.3	41.3	46.0	52.3	68.2	5.54	5.54
									14.7	15.6	20.0	24.2	28.3	32.4	36.5	41.5	46.1	52.5	68.4	5.65	5.65
									14.8	15.7	20.1	24.3	28.5	32.6	36.6	41.6	46.2	52.6	68.5	6.00	6.00
									20.5	21.4	25.4	29.5	33.5	37.5	41.5	46.4	51.0	57.3	73.1	6.00	6.00
									14.9	15.8	20.2	24.5	28.6	32.7	36.7	41.7	46.4	52.8	68.7	6.40	6.40
									15.0	15.9	20.4	24.6	28.7	32.8	36.9	41.9	46.5	52.9	68.8	6.55	6.55
									15.1	16.1	20.5	24.7	28.9	33.0	37.0	42.0	46.7	53.1	69.0	7.38	7.38
									15.3	16.2	20.6	24.9	29.0	33.1	37.2	42.2	46.8	53			

High HP HTS® 14mm Drive Selection Tables



Sprocket Combination					HP Ratings @1750 RPM Driver						HP Ratings@1160 RPM					
Drive Ratio	Driver		Driven		DN RPM	RPP Panther Belt Widths (mm)					DN RPM	RPP Panther Belt Widths (mm)				
	No. Teeth	P.D.	No. Teeth	P.D.		20	42	65	90	120		20	42	65	90	120
Multiply HP rating by the belt length factor to determine drive width - BELT LENGTH FACTOR																
1.00	80	14.04	80	14.04	1750						1160	97.34	204.63	316.79	438.71	585.01
1.00	72	12.63	72	12.63	1750	114.01	239.67	371.04	513.84	685.19	1160	88.19	185.40	287.03	397.49	530.05
1.00	68	11.93	68	11.93	1750	108.63	228.36	353.54	489.60	652.87	1160	83.54	175.62	271.89	376.53	502.09
1.00	64	11.23	64	11.23	1750	103.08	216.69	335.47	464.58	619.51	1160	78.84	165.74	256.60	355.35	473.85
1.00	60	10.53	60	10.53	1750	97.37	204.69	316.89	438.84	585.19	1160	74.10	155.77	241.16	333.97	445.34
1.00	56	9.83	56	9.83	1750	91.51	192.37	297.82	412.43	549.97	1160	69.31	145.71	225.58	312.40	416.58
1.00	52	9.12	52	9.12	1750	85.51	179.76	278.29	385.39	513.91	1160	64.49	135.57	209.88	290.65	387.58
1.00	48	8.42	48	8.42	1750	79.38	166.87	258.34	357.77	477.08	1160	59.63	125.36	194.07	268.75	358.38
1.00	44	7.72	44	7.72	1750	73.13	153.74	238.02	329.62	439.54	1160	54.74	115.07	178.15	246.71	328.99
1.00	40	7.02	40	7.02	1750	66.78	140.39	217.34	300.98	401.35	1160	49.82	104.73	162.14	224.54	299.42
1.00	38	6.67	38	6.67	1750	63.57	133.63	206.88	286.50	382.04	1160	47.35	99.54	154.10	213.41	284.58
1.00	36	6.32	36	6.32	1750	60.33	126.83	196.35	271.91	362.59	1160	44.88	94.34	146.05	202.26	269.71
1.00	34	5.97	34	5.97	1750	57.07	119.98	185.75	257.23	343.02	1160	42.40	89.12	137.98	191.08	254.80
1.00	32	5.61	32	5.61	1750	53.80	113.09	175.08	242.46	323.32	1160	39.91	83.90	129.89	179.88	239.86
1.00	30	5.26	30	5.26	1750	50.50	106.16	164.36	227.61	303.52	1160	37.42	78.67	121.79	168.66	224.90
1.00	29	5.09	29	5.09	1750	48.85	102.69	158.97	220.16	293.57	1160	36.17	76.05	117.73	163.04	217.41
1.00	28	4.91	28	4.91	1750	47.19	99.20	153.58	212.68	283.61	1160	34.93	73.42	113.67	157.42	209.91
1.03	29	5.09	30	5.26	1692	48.85	102.69	158.97	220.16	293.57	1121	36.17	76.05	117.73	163.04	217.41
1.04	28	4.91	29	5.09	1690	47.19	99.20	153.58	212.68	283.61	1120	34.93	73.42	113.67	157.42	209.91
1.05	38	6.67	40	7.02	1663	63.57	133.63	206.88	286.50	382.04	1102	47.35	99.54	154.10	213.41	284.58
1.06	36	6.32	38	6.67	1658	60.33	126.83	196.35	271.91	362.59	1099	44.88	94.34	146.05	202.26	269.71
1.06	68	11.93	72	12.63	1653	108.63	228.36	353.54	489.60	652.87	1096	83.54	175.62	271.89	376.53	502.09
1.06	34	5.97	36	6.32	1653	57.07	119.98	185.75	257.23	343.02	1096	42.40	89.12	137.98	191.08	254.80
1.06	64	11.23	68	11.93	1647	103.08	216.69	335.47	464.58	619.51	1092	78.84	165.74	256.60	355.35	473.85
1.06	32	5.61	34	5.97	1647	53.80	113.09	175.08	242.46	323.32	1092	39.91	83.90	129.89	179.88	239.86
1.07	60	10.53	64	11.23	1641	97.37	204.69	316.89	438.84	585.19	1088	74.10	155.77	241.16	333.97	445.34
1.07	30	5.26	32	5.61	1641	50.50	106.16	164.36	227.61	303.52	1088	37.42	78.67	121.79	168.66	224.90
1.07	56	9.83	60	10.53	1633	91.51	192.37	297.82	412.43	549.97	1083	69.31	145.71	225.58	312.40	416.58
1.07	28	4.91	30	5.26	1633	47.19	99.20	153.58	212.68	283.61	1083	34.93	73.42	113.67	157.42	209.91
1.08	52	9.12	56	9.83	1625	85.51	179.76	278.29	385.39	513.91	1077	64.49	135.57	209.88	290.65	387.58
1.08	48	8.42	52	9.12	1615	79.38	166.87	258.34	357.77	477.08	1071	59.63	125.36	194.07	268.75	358.38
1.09	44	7.72	48	8.42	1604	73.13	153.74	238.02	329.62	439.54	1063	54.74	115.07	178.15	246.71	328.99
1.10	40	7.02	44	7.72	1591	66.78	140.39	217.34	300.98	401.35	1055	49.82	104.73	162.14	224.54	299.42
1.10	29	5.09	32	5.61	1586	48.85	102.69	158.97	220.16	293.57	1051	36.17	76.05	117.73	163.04	217.41
1.11	72	12.63	80	14.04	1575	114.01	239.67	371.04	513.84	685.19	1044	88.19	185.40	287.03	397.49	530.05
1.11	36	6.32	40	7.02	1575	60.33	126.83	196.35	271.91	362.59	1044	44.88	94.34	146.05	202.26	269.71
1.12	34	5.97	38	6.67	1566	57.07	119.98	185.75	257.23	343.02	1038	42.40	89.12	137.98	191.08	254.80
1.13	64	11.23	72	12.63	1556	103.08	216.69	335.47	464.58	619.51	1031	78.84	165.74	256.60	355.35	473.85
1.13	32	5.61	36	6.32	1556	53.80	113.09	175.08	242.46	323.32	1031	39.91	83.90	129.89	179.88	239.86
1.13	80	14.04	90	15.79	1556						1031	97.34	204.63	316.79	438.71	585.01
1.13	60	10.53	68	11.93	1544	97.37	204.69	316.89	438.84	585.19	1024	74.10	155.77	241.16	333.97	445.34
1.13	30	5.26	34	5.97	1544	50.50	106.16	164.36	227.61	303.52	1024	37.42	78.67	121.79	168.66	224.90
1.14	56	9.83	64	11.23	1531	91.51	192.37	297.82	412.43	549.97	1015	69.31	145.71	225.58	312.40	416.58
1.14	28	4.91	32	5.61	1531	47.19	99.20	153.58	212.68	283.61	1015	34.93	73.42	113.67	157.42	209.91
1.15	52	9.12	60	10.53	1517	85.51	179.76	278.29	385.39	513.91	1005	64.49	135.57	209.88	290.65	387.58
1.16	38	6.67	44	7.72	1511	63.57	133.63	206.88	286.50	382.04	1002	47.35	99.54	154.10	213.41	284.58
1.17	48	8.42	56	9.83	1500	79.38	166.87	258.34	357.77	477.08	994	59.63	125.36	194.07	268.75	358.38
1.17	29	5.09	34	5.97	1493	48.85	102.69	158.97	220.16	293.57	989	36.17	76.05	117.73	163.04	217.41
1.18	68	11.93	80	14.04	1488	108.63	228.36	353.54	489.60	652.87	986	83.54	175.62	271.89	376.53	502.09
1.18	34	5.97	40	7.02	1488	57.07	119.98	185.75	257.23	343.02	986	42.40	89.12	137.98	191.08	254.80
1.18	44	7.72	52	9.12	1481	73.13	153.74	238.02	329.62	439.54	982	54.74	115.07	178.15	246.71	328.99
1.19	32	5.61	38	6.67	1474	53.80	113.09	175.08	242.46	323.32	977	39.91	83.90	129.89	179.88	239.86
1.20	60	10.53	72	12.63	1458	97.37	204.69	316.89	438.84	585.19	967	74.10	155.77	241.16	333.97	445.34
1.20	40	7.02	48	8.42	1458	66.78	140.39	217.34	300.98	401.35	967	49.82	104.73	162.14	224.54	299.42
1.20	30	5.26	36	6.32	1458	50.50	106.16	164.36	227.61	303.52	967	37.42	78.67	121.79	168.66	224.90
1.21	56	9.83	68	11.93	1441	91.51	192.37	297.82	412.43	549.97	955	69.31	145.71	225.58	312.40	416.58
1.21	28	4.91	34	5.97	1441	47.19	99.20	153.58	212.68	283.61	955	34.93	73.42	113.67	157.42	209.91
1.22	36	6.32	44	7.72	1432	60.33	126.83	196.35	271.91	362.59	949	44.88	94.34	146.05	202.26	269.71
1.23	52	9.12	64	11.23	1422	85.51	179.76	278.29	385.39	513.91	943	64.49	135.57	209.88	290.65	387.58
1.24	29	5.09	36	6.32	1410	48.85	102.69	158.97	220.16	293.57	934	36.17	76.05	117.73	163.04	217.41
1.25	72	12.63	80	14.04	1400	114.01	239.67	371.04	513.84	685.19	928	88.19	185.40	287.03	397.49	530.05
1.25	64	11.23	72	12.63	1400	103.08	216.69	335.47	464.58	619.51	928	78.84	165.74	256.60	355.35	473.85
1.25	48	8.42	60	10.53	1400	79.38	166.87	258.34	357.77	477.08	928	59.63	125.36	194.07	268.75	358.38
1.25	32	5.61	40	7.02	1400	53.80	113.09	175.08	242.46	323.32	928	39.91	83.90	129.89	179.88	239.86
1.26	38	6.67	48	8.42	1385	63.57	133.63	206.88	286.50	382.04	918	47.35	99.54	154.10	213.41	284.58
1.27	30	5.26	38	6.67	1382	50.50	106.16	164.36	227.61	303.52	916	37.42	78.67	121.79	168.66	224.90
Multiply HP rating by the belt length factor to determine drive width - BELT LENGTH FACTOR																

PULLEYS



High HP HTS® 14mm Drive Selection Tables

Theoretical Center Distance in Inches for Various Belt Lengths

Theoretical Center Distance in Inches for Various Belt Lengths																		
Belt Length Code (mm)																		
966	1190	1400	1610	1778	1890	2100	2310	2450	2590	2800	3150	3360	3500	3850	4326	4578	4956	Drive
0.8	0.8	0.9	0.9	0.95	0.95	1	1	1.05	1.05	1.1	1.1	1.15	1.15	1.2	1.2	1.25	1.25	Ratio
				15.2	15.2	19.3	23.4	26.2	28.9	33.1	40.0	44.1	46.9	53.7	63.1	68.1	75.5	1.00
				17.4	17.4	21.5	25.6	28.4	31.1	35.3	42.2	46.3	49.1	55.9	65.3	70.3	77.7	1.00
			13.0	16.3	18.5	22.6	26.7	29.5	32.2	36.4	43.3	47.4	50.2	57.1	66.4	71.4	78.8	1.00
			14.1	17.4	19.6	23.7	27.8	30.6	33.4	37.5	44.4	48.5	51.3	58.2	67.5	72.5	79.9	1.00
		11.0	15.2	18.5	20.7	24.8	28.9	31.7	34.5	38.6	45.5	49.6	52.4	59.3	68.6	73.6	81.0	1.00
		12.1	16.3	19.6	21.8	25.9	30.0	32.8	35.6	39.7	46.6	50.7	53.5	60.4	69.7	74.7	82.1	1.00
		13.2	17.4	20.7	22.9	27.0	31.1	33.9	36.7	40.8	47.7	51.8	54.6	61.5	70.8	75.8	83.2	1.00
	10.2	14.3	18.5	21.8	24.0	28.1	32.2	35.0	37.8	41.9	48.8	52.9	55.7	62.6	71.9	76.9	84.3	1.00
	11.3	15.4	19.6	22.9	25.1	29.2	33.4	36.1	38.9	43.0	49.9	54.0	56.8	63.7	73.0	78.0	85.4	1.00
8.0	12.4	16.5	20.7	24.0	26.2	30.3	34.5	37.2	40.0	44.1	51.0	55.1	57.9	64.8	74.1	79.1	86.5	1.00
8.5	13.0	17.1	21.2	24.5	26.7	30.9	35.0	37.8	40.5	44.7	51.5	55.7	58.4	65.3	74.7	79.7	87.1	1.00
9.1	13.5	17.6	21.8	25.1	27.3	31.4	35.6	38.3	41.1	45.2	52.1	56.2	59.0	65.9	75.2	80.2	87.6	1.00
9.7	14.1	18.2	22.3	25.6	27.8	32.0	36.1	38.9	41.6	45.8	52.6	56.8	59.5	66.4	75.8	80.8	88.2	1.00
10.2	14.6	18.7	22.9	26.2	28.4	32.5	36.7	39.4	42.2	46.3	53.2	57.3	60.1	67.0	76.3	81.3	88.7	1.00
10.8	15.2	19.3	23.4	26.7	28.9	33.1	37.2	40.0	42.7	46.9	53.7	57.9	60.6	67.5	76.9	81.9	89.3	1.00
11.0	15.4	19.6	23.7	27.0	29.2	33.4	37.5	40.2	43.0	47.1	54.0	58.2	60.9	67.8	77.2	82.1	89.6	1.00
11.3	15.7	19.8	24.0	27.3	29.5	33.6	37.8	40.5	43.3	47.4	54.3	58.4	61.2	68.1	77.4	82.4	89.8	1.00
10.9	15.3	19.4	23.6	26.9	29.1	33.2	37.3	40.1	42.9	47.0	53.9	58.0	60.8	67.7	77.0	82.0	89.4	1.03
11.2	15.6	19.7	23.8	27.2	29.4	33.5	37.6	40.4	43.1	47.3	54.2	58.3	61.0	67.9	77.3	82.3	89.7	1.04
8.3	12.7	16.8	20.9	24.3	26.5	30.6	34.7	37.5	40.2	44.4	51.3	55.4	58.2	65.0	74.4	79.4	86.8	1.05
8.8	13.2	17.4	21.5	24.8	27.0	31.1	35.3	38.0	40.8	44.9	51.8	55.9	58.7	65.6	75.0	79.9	87.4	1.06
			12.4	15.7	17.9	22.0	26.2	28.9	31.7	35.8	42.7	46.9	49.6	56.5	65.9	70.8	78.3	1.06
9.4	13.8	17.9	22.1	25.4	27.6	31.7	35.8	38.6	41.3	45.5	52.4	56.5	59.3	66.1	75.5	80.5	87.9	1.06
			13.5	16.8	19.0	23.2	27.3	30.0	32.8	36.9	43.8	48.0	50.7	57.6	67.0	71.9	79.4	1.06
9.9	14.3	18.5	22.6	25.9	28.1	32.2	36.4	39.1	41.9	46.0	52.9	57.1	59.8	66.7	76.1	81.0	88.5	1.06
			14.6	17.9	20.1	24.3	28.4	31.1	33.9	38.0	44.9	49.1	51.8	58.7	68.1	73.0	80.5	1.07
10.5	14.9	19.0	23.2	26.5	28.7	32.8	36.9	39.7	42.4	46.6	53.5	57.6	60.4	67.2	76.6	81.6	89.0	1.07
			11.6	15.7	19.0	21.2	25.4	29.5	32.2	35.0	42.0	46.0	48.7	55.6	65.0	69.9	77.4	1.07
11.0	15.4	19.6	23.7	27.0	29.2	33.4	37.5	40.2	43.0	47.1	54.0	58.2	60.9	67.8	77.2	82.1	89.6	1.07
			12.7	16.8	20.1	22.3	26.5	30.6	33.3	36.1	43.0	47.1	49.8	56.7	66.1	71.0	78.5	1.08
	9.6	13.8	17.9	21.2	23.4	27.6	31.7	34.5	37.2	41.3	48.2	52.4	55.1	62.0	71.4	76.3	83.8	1.08
	10.7	14.9	19.0	22.3	24.5	28.7	32.8	35.6	38.3	42.4	49.3	53.5	56.2	63.1	72.5	77.4	84.9	1.09
	11.9	16.0	20.1	23.4	25.6	29.8	33.9	36.7	39.4	43.5	50.4	54.6	57.3	64.2	73.6	78.5	86.0	1.10
10.6	15.0	19.2	23.3	26.6	28.8	32.9	37.1	39.8	42.6	46.7	53.6	57.7	60.5	67.4	76.8	81.7	89.2	1.10
			14.0	16.2	20.4	24.5	27.3	30.0	32.8	35.6	42.5	46.6	49.3	56.2	65.6	70.5	78.0	1.11
			14.0	16.2	20.4	24.5	27.3	30.0	32.8	35.6	42.5	46.6	49.3	56.2	65.6	70.5	78.0	1.11
8.5	12.6	17.1	21.2	24.5	26.7	30.9	35.0	37.8	40.5	44.7	51.5	55.7	58.4	65.3	74.7	79.7	87.1	1.11
9.1	13.5	17.6	21.8	25.1	27.3	31.4	35.6	38.3	41.1	45.2	52.1	56.2	59.0	65.9	75.2	80.2	87.6	1.12
			12.9	16.2	18.5	22.6	26.7	29.5	32.2	36.4	43.3	47.4	50.2	57.1	66.4	71.4	78.8	1.13
9.6	14.1	18.2	22.3	25.6	27.8	32.0	36.1	38.9	41.6	45.8	52.6	56.8	59.5	66.4	75.8	80.8	88.2	1.13
			17.9	22.0	24.8	28.9	33.1	35.8	38.6	42.7	49.5	53.7	56.4	63.3	72.7	77.6	85.0	1.13
			14.0	16.2	20.4	24.5	27.3	30.0	32.8	35.6	42.5	46.6	49.3	56.2	65.6	70.5	78.0	1.13
			14.0	16.2	20.4	24.5	27.3	30.0	32.8	35.6	42.5	46.6	49.3	56.2	65.6	70.5	78.0	1.13
10.2	14.6	18.7	22.9	26.2	28.4	32.5	36.7	39.4	42.2	46.3	53.2	57.3	60.1	67.0	76.3	81.3	88.7	1.13
			11.0	15.1	18.5	20.7	24.8	28.9	31.7	34.4	41.3	45.4	48.1	55.0	64.4	69.3	76.8	1.14
10.7	15.2	19.3	23.4	26.7	28.9	33.1	37.2	40.0	42.7	46.9	53.7	57.9	60.6	67.5	76.9	81.9	89.3	1.14
			12.1	16.2	19.6	21.8	25.9	30.0	32.8	35.5	42.4	46.5	49.2	56.1	65.5	70.4	77.9	1.15
			12.1	16.2	19.6	21.8	25.9	30.0	32.8	35.5	42.4	46.5	49.2	56.1	65.5	70.4	77.9	1.15
7.7	12.1	16.3	20.4	23.7	25.9	30.0	34.2	36.9	39.7	43.8	50.7	54.8	57.6	64.5	73.9	78.8	86.3	1.16
			13.2	17.4	20.7	22.9	27.0	31.1	33.9	36.7	43.6	47.7	50.5	57.4	66.8	71.7	79.2	1.17
10.3	14.7	18.9	23.0	26.3	28.5	32.7	36.8	39.5	42.3	46.4	53.3	57.4	60.2	67.1	76.5	81.4	88.9	1.17
			14.6	16.8	20.9	25.1	27.8	30.6	33.4	37.5	44.4	48.5	51.3	58.2	67.6	72.5	80.0	1.18
8.8	13.2	17.4	21.5	24.8	27.0	31.1	35.3	38.0	40.8	44.9	51.8	55.9	58.7	65.6	75.0	79.9	87.4	1.18
			10.2	14.3	18.5	21.8	24.0	28.1	32.2	35.0	41.9	45.0	47.7	54.6	64.0	68.9	76.4	1.18
9.4	13.8	17.9	22.0	25.4	27.6	31.7	35.8	38.6	41.3	45.5	52.4	56.5	59.3	66.1	75.5	80.5	87.9	1.19
			13.5	16.8	19.0	23.1	27.3	30.0	32.8	36.9	43.8	47.9	50.7	57.6	67.0	71.9	79.4	1.20
			11.3	15.4	19.6	22.9	25.1	29.2	33.3	36.1	43.0	47.1	49.8	56.7	66.1	71.0	78.5	1.20
9.9	14.3	18.5	22.6	25.9	28.1	32.2	36.4	39.1	41.9	46.0	52.9	57.1	59.8	66.7	76.1	81.0	88.5	1.20
			14.6	17.9	20.1	24.2	28.3	31.1	33.9	38.0	44.9	49.0	51.8	58.7	68.1	73.0	80.5	1.21
10.5	14.9	19.0	23.1	26.5	28.7	32.8	36.9	39.7	42.4	46.6	53.5	57.6	60.4	67.2	76.6	81.6	89.0	1.21
8.0	12.4	16.5	20.7	24.0	26.2	30.3	34.4	37.2	40.0	44.1	51.0	55.1	57.9	64.8	74.1	79.1	86.5	1.22
			11.5	15.7	19.0	21.2	25.3	29.5	32.2	35.0	42.0	46.0	48.7	55.6	65.0	69.9	77.4	1.23
10.0	14.5	18.6	22.7	26.0	28.2	32.4	36.5	39.3	42.0	46.2	53.1	57.2	59.9	66.8	76.2	81.2	88.6	1.24
				15.1	14.8	19.0	23.1	25.9	28.6	32.8	39.7	43.8	46.6	53.4	62.8	67.8	75.2	1.25
				17.3	17.3	21.5	25.6	28.4	31.1	35.3	42.2	46.3	49.0	55.9	65.3	70.3	77.7	1.25
		12.6	16.8	20.1	22.3	26.4	30.6	33.3	36.1	40.2	47.1	51.3	54.0	60.9	70.3	75.2	82.7	1.25
9.1	13.5	17.6	21.8	25.1	27.3	31.4	35.5	38.3	41.1	45.2	52.1	56.2	59.0	65.9	75.2	80.2	87.6	1.25
			11.5	15.7	19.8	23.1	25.3	29.5	33.6	36.4	43.3	47.4	50.2	57.1	66.4	71.4	78.8	1.25
			11.5	15.7	19.8	23.1	25.3	29.5	33.6	36.4	43.3	47.4	50.2	57.1	66.4	71.4	78.8	1.25
9.6	14.0	18.2	22.3	25.6	27.8	32.0	36.1	38.9	41.6	45.7	52.6	56.8	59.5	66.4	75.8	80.7	88.2	1.27

High HP HTS® 14mm Drive Selection Tables



Sprocket Combination					HP Ratings @1750 RPM Driver						HP Ratings@1160 RPM					
Drive Ratio	Driver		Driven		DN RPM	RPP Panther Belt Widths (mm)					DN RPM	RPP Panther Belt Widths (mm)				
	No. Teeth	P.D.	No. Teeth	P.D.		20	42	65	90	120		20	42	65	90	120
Multiply HP rating by the belt length factor to determine drive width - BELT LENGTH FACTOR																
1.27	44	7.72	56	9.83	1375	73.13	153.74	238.02	329.62	439.54	911	54.74	115.07	178.15	246.71	328.99
1.29	56	9.83	72	12.63	1361	91.51	192.37	297.82	412.43	549.97	902	69.31	145.71	225.58	312.40	416.58
1.29	28	4.91	36	6.32	1361	47.19	99.20	153.58	212.68	283.61	902	34.93	73.42	113.67	157.42	209.91
1.29	34	5.97	44	7.72	1352	57.07	119.98	185.75	257.23	343.02	896	42.40	89.12	137.98	191.08	254.80
1.30	40	7.02	52	9.12	1346	66.78	140.39	217.34	300.98	401.35	892	49.82	104.73	162.14	224.54	299.42
1.31	52	9.12	68	11.93	1338	85.51	179.76	278.29	385.39	513.91	887	64.49	135.57	209.88	290.65	387.58
1.31	29	5.09	38	6.67	1336	48.85	102.69	158.97	220.16	293.57	885	36.17	76.05	117.73	163.04	217.41
1.32	68	11.93	90	15.79	1322	108.63	228.36	353.54	489.60	652.87	876	83.54	175.62	271.89	376.53	502.09
1.33	60	10.53	80	14.04	1313	97.37	204.69	316.89	438.84	585.19	870	74.10	155.77	241.16	333.97	445.34
1.33	48	8.42	64	11.23	1313	79.38	166.87	258.34	357.77	477.08	870	59.63	125.36	194.07	268.75	358.38
1.33	36	6.32	48	8.42	1313	60.33	126.83	196.35	271.91	362.59	870	44.88	94.34	146.05	202.26	269.71
1.33	30	5.26	40	7.02	1313	50.50	106.16	164.36	227.61	303.52	870	37.42	78.67	121.79	168.66	224.90
1.36	28	4.91	38	6.67	1289	47.19	99.20	153.58	212.68	283.61	855	34.93	73.42	113.67	157.42	209.91
1.36	44	7.72	60	10.53	1283	73.13	153.74	238.02	329.62	439.54	851	54.74	115.07	178.15	246.71	328.99
1.37	38	6.67	52	9.12	1279	63.57	133.63	206.88	286.50	382.04	848	47.35	99.54	154.10	213.41	284.58
1.38	32	5.61	44	7.72	1273	53.80	113.09	175.08	242.46	323.32	844	39.91	83.90	129.89	179.88	239.86
1.38	29	5.09	40	7.02	1269	48.85	102.69	158.97	220.16	293.57	841	36.17	76.05	117.73	163.04	217.41
1.38	52	9.12	72	12.63	1264	85.51	179.76	278.29	385.39	513.91	838	64.49	135.57	209.88	290.65	387.58
1.40	80	14.04	112	19.65	1250	103.08	216.69	335.47	464.58	619.51	829	97.34	204.63	316.79	438.71	585.01
1.40	40	7.02	56	9.83	1250	66.78	140.39	217.34	300.98	401.35	829	49.82	104.73	162.14	224.54	299.42
1.41	64	11.23	90	15.79	1244	103.08	216.69	335.47	464.58	619.51	825	78.84	165.74	256.60	355.35	473.85
1.41	34	5.97	48	8.42	1240	57.07	119.98	185.75	257.23	343.02	822	42.40	89.12	137.98	191.08	254.80
1.42	48	8.42	68	11.93	1235	79.38	166.87	258.34	357.77	477.08	819	59.63	125.36	194.07	268.75	358.38
1.43	56	9.83	80	14.04	1225	91.51	192.37	297.82	412.43	549.97	812	69.31	145.71	225.58	312.40	416.58
1.43	28	4.91	40	7.02	1225	47.19	99.20	153.58	212.68	283.61	812	34.93	73.42	113.67	157.42	209.91
1.44	36	6.32	52	9.12	1212	60.33	126.83	196.35	271.91	362.59	803	44.88	94.34	146.05	202.26	269.71
1.45	44	7.72	64	11.23	1203	73.13	153.74	238.02	329.62	439.54	798	54.74	115.07	178.15	246.71	328.99
1.47	30	5.26	44	7.72	1193	50.50	106.16	164.36	227.61	303.52	791	37.42	78.67	121.79	168.66	224.90
1.47	38	6.67	56	9.83	1188	63.57	133.63	206.88	286.50	382.04	787	47.35	99.54	154.10	213.41	284.58
1.50	60	10.53	90	15.79	1167	97.37	204.69	316.89	438.84	585.19	773	74.10	155.77	241.16	333.97	445.34
1.50	48	8.42	72	12.63	1167	79.38	166.87	258.34	357.77	477.08	773	59.63	125.36	194.07	268.75	358.38
1.50	40	7.02	60	10.53	1167	66.78	140.39	217.34	300.98	401.35	773	49.82	104.73	162.14	224.54	299.42
1.50	32	5.61	48	8.42	1167	53.80	113.09	175.08	242.46	323.32	773	39.91	83.90	129.89	179.88	239.86
1.52	29	5.09	44	7.72	1153	48.85	102.69	158.97	220.16	293.57	765	36.17	76.05	117.73	163.04	217.41
1.53	34	5.97	52	9.12	1144	57.07	119.98	185.75	257.23	343.02	758	42.40	89.12	137.98	191.08	254.80
1.54	52	9.12	80	14.04	1138	85.51	179.76	278.29	385.39	513.91	754	64.49	135.57	209.88	290.65	387.58
1.55	44	7.72	68	11.93	1132	73.13	153.74	238.02	329.62	439.54	751	54.74	115.07	178.15	246.71	328.99
1.56	72	12.63	112	19.65	1125	114.01	239.67	371.04	513.84	685.19	746	88.19	185.40	287.03	397.49	530.05
1.56	36	6.32	56	9.83	1125	60.33	126.83	196.35	271.91	362.59	746	44.88	94.34	146.05	202.26	269.71
1.57	28	4.91	44	7.72	1114	47.19	99.20	153.58	212.68	283.61	738	34.93	73.42	113.67	157.42	209.91
1.58	38	6.67	60	10.53	1108	63.57	133.63	206.88	286.50	382.04	735	47.35	99.54	154.10	213.41	284.58
1.60	40	7.02	64	11.23	1094	66.78	140.39	217.34	300.98	401.35	725	49.82	104.73	162.14	224.54	299.42
1.60	30	5.26	48	8.42	1094	50.50	106.16	164.36	227.61	303.52	725	37.42	78.67	121.79	168.66	224.90
1.61	56	9.83	90	15.79	1089	91.51	192.37	297.82	412.43	549.97	722	69.31	145.71	225.58	312.40	416.58
1.63	32	5.61	52	9.12	1077	53.80	113.09	175.08	242.46	323.32	714	39.91	83.90	129.89	179.88	239.86
1.64	44	7.72	72	12.63	1069	73.13	153.74	238.02	329.62	439.54	709	54.74	115.07	178.15	246.71	328.99
1.65	68	11.93	112	19.65	1063	108.63	228.36	353.54	489.60	652.87	704	83.54	175.62	271.89	376.53	502.09
1.65	34	5.97	56	9.83	1063	57.07	119.98	185.75	257.23	343.02	704	42.40	89.12	137.98	191.08	254.80
1.66	29	5.09	48	8.42	1057	48.85	102.69	158.97	220.16	293.57	701	36.17	76.05	117.73	163.04	217.41
1.67	48	8.42	80	14.04	1050	79.38	166.87	258.34	357.77	477.08	696	59.63	125.36	194.07	268.75	358.38
1.67	36	6.32	60	10.53	1050	60.33	126.83	196.35	271.91	362.59	696	44.88	94.34	146.05	202.26	269.71
1.68	38	6.67	64	11.23	1039	63.57	133.63	206.88	286.50	382.04	689	47.35	99.54	154.10	213.41	284.58
1.70	40	7.02	68	11.93	1029	66.78	140.39	217.34	300.98	401.35	682	49.82	104.73	162.14	224.54	299.42
1.71	28	4.91	48	8.42	1021	47.19	99.20	153.58	212.68	283.61	677	34.93	73.42	113.67	157.42	209.91
1.73	52	9.12	90	15.79	1011	85.51	179.76	278.29	385.39	513.91	670	64.49	135.57	209.88	290.65	387.58
1.73	30	5.26	52	9.12	1010	50.50	106.16	164.36	227.61	303.52	669	37.42	78.67	121.79	168.66	224.90
1.75	64	11.23	112	19.65	1000	103.08	216.69	335.47	464.58	619.51	663	78.84	165.74	256.60	355.35	473.85
1.75	32	5.61	56	9.83	1000	53.80	113.09	175.08	242.46	323.32	663	39.91	83.90	129.89	179.88	239.86
1.76	34	5.97	60	10.53	992	57.07	119.98	185.75	257.23	343.02	657	42.40	89.12	137.98	191.08	254.80
1.78	36	6.32	64	11.23	984	60.33	126.83	196.35	271.91	362.59	653	44.88	94.34	146.05	202.26	269.71
1.79	38	6.67	68	11.93	978	63.57	133.63	206.88	286.50	382.04	648	47.35	99.54	154.10	213.41	284.58
1.79	29	5.09	52	9.12	976	48.85	102.69	158.97	220.16	293.57	647	36.17	76.05	117.73	163.04	217.41
1.80	80	14.04	144	25.26	972	103.08	216.69	335.47	464.58	619.51	644	97.34	204.63	316.79	438.71	585.01
1.80	40	7.02	72	12.63	972	66.78	140.39	217.34	300.98	401.35	644	49.82	104.73	162.14	224.54	299.42
1.82	44	7.72	80	14.04	963	73.13	153.74	238.02	329.62	439.54	638	54.74	115.07	178.15	246.71	328.99
1.86	28	4.91	52	9.12	942	47.19	99.20	153.58	212.68	283.61	625	34.93	73.42	113.67	157.42	209.91

Multiply HP rating by the belt length factor to determine drive width - BELT LENGTH FACTOR



High HP HTS® 14mm Drive Selection Tables

Theoretical Center Distance in Inches for Various Belt Lengths																		
Belt Length Code (mm)																		
966	1190	1400	1610	1778	1890	2100	2310	2450	2590	2800	3150	3360	3500	3850	4326	4578	4956	Drive
0.8	0.8	0.9	0.9	0.95	0.95	1	1	1.05	1.05	1.1	1.1	1.15	1.15	1.2	1.2	1.25	1.25	Ratio
10.2	9.6	13.7	17.9	21.2	23.4	27.5	31.7	34.4	37.2	41.3	48.2	52.4	55.1	62.0	71.4	76.3	83.8	1.27
	14.6	18.7	22.9	17.3	19.5	23.7	27.8	30.6	33.3	37.5	44.4	48.5	51.2	58.1	67.5	72.5	79.9	1.29
	8.2	12.7	16.8	20.9	24.2	26.4	30.6	34.7	37.5	40.2	44.4	51.3	55.4	58.1	65.0	74.4	79.4	1.29
9.8	10.7	14.8	19.0	22.3	24.5	28.6	32.8	35.5	38.3	42.4	49.3	53.5	56.2	63.1	72.5	77.4	84.9	1.30
	14.2	10.9	15.1	18.4	20.6	24.8	28.9	31.7	34.4	38.6	45.5	49.6	52.3	59.2	68.6	73.6	81.0	1.31
		18.3	22.5	25.8	28.0	32.1	36.2	39.0	41.7	45.9	52.8	56.9	59.7	66.6	75.9	80.9	88.3	1.31
9.3	11.8	15.3	19.5	23.6	26.4	29.2	33.3	26.4	29.2	33.3	40.2	44.3	47.1	54.0	63.4	68.3	75.8	1.32
		17.8	22.0	26.1	28.9	31.6	35.8	28.9	31.6	35.8	42.7	46.8	49.6	56.5	65.8	70.8	78.3	1.33
	14.3	12.0	16.2	19.5	21.7	25.9	30.0	32.8	35.5	39.7	46.6	50.7	53.5	60.3	69.7	74.7	82.1	1.33
9.9	13.8	17.9	22.0	25.3	27.6	31.7	35.8	38.6	41.3	45.5	52.4	56.5	59.3	66.1	75.5	80.5	87.9	1.33
	14.3	18.4	22.6	25.9	28.1	32.2	36.4	39.1	41.9	46.0	52.9	57.0	59.8	66.7	76.1	81.0	88.5	1.36
	11.0	13.2	17.3	20.6	22.8	27.0	31.1	33.9	36.6	40.8	47.7	51.8	54.6	61.4	70.8	75.8	83.2	1.36
8.5	12.9	17.1	21.2	24.5	26.7	30.9	35.0	37.7	40.5	44.6	51.5	55.7	58.4	65.3	74.7	79.6	87.1	1.38
	13.9	18.0	22.2	25.5	27.7	31.8	36.0	38.7	41.5	45.6	52.5	56.6	59.4	66.3	75.6	80.6	88.1	1.38
		10.1	14.5	17.8	20.0	24.2	28.3	31.1	33.9	38.0	44.9	49.0	51.8	58.7	68.1	73.0	80.5	1.38
7.6	12.1	18.8	21.6	24.4	28.5	21.6	24.4	28.5	35.4	39.6	46.3	50.5	53.3	60.2	69.6	74.5	82.0	1.40
		14.3	18.4	21.7	23.9	28.1	32.2	35.0	37.7	41.9	48.8	52.9	55.7	62.5	71.9	76.9	84.3	1.40
	9.6	12.1	16.2	20.4	23.6	27.8	31.0	26.9	29.7	33.8	40.7	44.9	47.6	54.5	63.9	68.9	76.3	1.41
9.6	14.0	11.4	15.6	18.9	21.2	25.3	29.4	32.2	35.0	39.1	46.0	50.1	52.9	59.8	69.2	74.1	81.6	1.42
		18.2	22.3	25.6	27.8	32.0	36.1	38.8	41.6	45.7	52.6	56.8	59.5	66.4	75.8	80.7	88.2	1.43
	11.2	15.4	19.5	22.8	25.0	29.2	33.3	36.1	38.8	43.0	49.9	54.0	56.8	63.7	73.0	78.0	85.4	1.44
8.7	12.6	16.7	20.0	22.3	26.4	30.5	33.3	33.3	36.1	40.2	47.1	51.2	54.0	60.9	70.3	75.2	82.7	1.45
	13.2	17.3	21.5	24.8	27.0	31.1	35.3	38.0	40.8	44.9	51.8	55.9	58.7	65.6	75.0	79.9	87.4	1.47
	10.4	14.5	18.7	22.0	24.2	28.3	32.5	35.2	38.0	42.1	49.0	53.2	55.9	62.8	72.2	77.2	84.6	1.47
7.9	9.5	10.8	15.0	18.3	20.6	24.7	28.9	27.4	30.2	34.4	41.3	45.5	48.2	55.1	64.4	69.4	76.5	1.50
		13.7	17.8	21.2	23.4	27.5	31.6	34.4	37.2	41.3	48.2	52.3	55.1	62.0	71.4	76.3	83.8	1.50
	8.9	12.3	16.5	20.6	23.9	26.1	30.3	34.4	37.2	39.9	44.1	51.0	55.1	57.9	64.8	74.1	79.1	86.5
9.0	13.3	15.6	19.8	23.1	25.3	29.5	33.6	36.3	39.1	43.2	50.1	54.3	57.0	63.9	73.3	78.3	85.7	1.52
		11.5	15.6	19.8	23.1	25.3	29.5	33.6	36.3	39.1	43.2	50.1	54.3	57.0	63.9	73.3	78.3	85.7
	11.2	15.4	19.5	22.8	25.0	29.2	33.3	36.1	38.8	43.0	49.9	54.0	56.8	63.7	73.0	78.0	85.4	1.54
8.9	9.5	10.8	15.0	18.3	20.6	24.7	28.9	27.4	30.2	34.4	41.3	45.5	48.2	55.1	64.4	69.4	76.5	1.54
		13.7	17.8	21.2	23.4	27.5	31.6	34.4	37.2	41.3	48.2	52.3	55.1	62.0	71.4	76.3	83.8	1.54
	8.9	12.3	16.5	20.6	23.9	26.1	30.3	34.4	37.2	39.9	44.1	51.0	55.1	57.9	64.8	74.1	79.1	86.5
8.1	9.7	11.9	16.1	19.5	21.7	25.8	30.0	32.7	35.5	39.6	46.5	50.7	53.4	60.3	69.7	74.7	82.1	1.55
		13.4	17.6	21.7	25.0	27.3	31.4	35.5	38.3	41.0	45.2	52.1	56.2	59.0	65.9	75.2	80.2	87.6
	10.6	14.8	18.9	22.3	24.5	28.6	32.8	35.5	38.3	42.4	49.3	53.4	56.2	63.1	72.5	77.4	84.9	1.56
8.1	12.6	13.9	18.1	21.4	23.6	27.8	31.9	34.7	37.4	41.6	48.5	52.6	55.4	62.3	71.6	76.6	84.0	1.58
		16.7	20.9	24.2	26.4	30.6	34.7	37.5	40.2	44.3	51.2	55.4	58.1	65.0	74.4	79.4	86.8	1.60
	11.7	15.9	20.0	23.4	25.6	29.7	33.9	36.6	39.4	43.5	50.4	54.5	57.3	64.2	73.6	78.5	86.0	1.63
8.2	10.9	11.3	15.5	18.9	21.1	25.2	29.3	32.2	34.9	39.1	46.0	50.1	52.9	59.8	69.1	74.1	81.5	1.64
		12.7	16.9	21.0	24.3	26.5	30.7	34.8	37.6	40.3	44.5	51.4	55.5	58.3	65.2	74.5	79.5	86.9
	9.1	13.3	17.5	20.8	23.0	27.2	31.3	34.1	36.9	41.0	47.9	52.0	54.8	61.7	71.1	76.0	83.5	1.68
8.4	12.8	12.4	16.6	20.0	22.2	26.3	30.5	33.3	36.0	40.2	47.1	51.2	54.0	60.9	70.2	75.2	82.6	1.70
		17.0	21.2	24.5	26.7	30.8	35.0	37.7	40.5	44.6	51.5	55.6	58.4	65.3	74.7	79.6	87.1	1.71
	9.3	13.6	17.7	21.1	23.3	27.5	31.6	34.4	37.1	41.3	48.2	52.3	55.1	62.0	71.3	76.3	83.7	1.78
7.5	12.0	16.1	20.3	23.6	25.8	30.0	34.1	36.9	39.6	43.8	50.7	54.8	57.6	64.5	73.8	78.8	86.2	1.73
		11.1	15.3	19.5	22.8	25.0	29.1	33.3	36.0	38.8	42.9	49.8	54.0	56.7	63.6	73.0	78.0	85.4
	10.2	14.4	18.6	21.9	24.1	28.3	32.4	35.2	38.0	42.1	49.0	53.1	55.9	62.8	72.2	77.1	84.6	1.76
7.6	12.1	13.6	17.7	21.1	23.3	27.5	31.6	34.4	37.1	41.3	48.2	52.3	55.1	62.0	71.3	76.3	83.7	1.78
		12.7	16.9	20.2	22.4	26.6	30.8	33.5	36.3	40.4	47.3	51.5	54.2	61.1	70.5	75.5	82.9	1.79
	9.3	13.6	17.7	21.1	23.3	27.5	31.6	34.4	37.1	41.3	48.2	52.3	55.1	62.0	71.3	76.3	83.7	1.78
7.7	12.2	16.4	20.6	23.9	26.1	30.2	34.4	37.2	39.9	44.0	50.9	55.1	57.8	64.7	74.1	79.1	86.5	1.86
		14.3	18.5	21.8	24.0	28.1	32.3	35.1	37.9	42.0	48.9	53.1	55.8	62.7	72.1	77.1	84.6	1.76
	9.3	13.6	17.7	21.1	23.3	27.5	31.6	34.4	37.1	41.3	48.2	52.3	55.1	62.0	71.3	76.3	83.7	1.78
7.6	12.1	16.3	20.4	23.8	26.0	30.1	34.3	37.0	39.8	43.9	50.8	54.9	57.7	64.6	74.0	78.9	86.4	1.79
		11.8	16.0	19.4	21.6	25.8	29.9	32.7	35.4	39.6	46.5	50.6	53.4	60.3	69.7	74.6	82.1	1.80
	9.3	13.6	17.7	21.1	23.3	27.5	31.6	34.4	37.1	41.3	48.2	52.3	55.1	62.0	71.3	76.3	83.7	1.78
7.7	12.2	16.4	20.6	23.9	26.1	30.2	34.4	37.2	39.9	44.0	50.9	55.1	57.8	64.7	74.1	79.1	86.5	1.86
		14.3	18.5	21.8	24.0	28.1	32.3	35.1	37.9	42.0	48.9	53.1	55.8	62.7	72.1	77.1	84.6	1.76
	9.3	13.6	17.7	21.1	23.3	27.5	31.6	34.4	37.1	41.3	48.2	52.3	55.1	62.0	71.3	76.3	83.7	1.78
966	1190	1400	1610	1778	1890	2100	2310	2450	2590	2800	3150	3360	3500	3850	4326	4578	4956	Drive Ratio

PULLEYS

High HP HTS® 14mm Drive Selection Tables



Sprocket Combination					HP Ratings @1750 RPM Driver						HP Ratings@1160 RPM					
Drive Ratio	Driver		Driven		DN RPM	RPP Panther Belt Widths (mm)					DN RPM	RPP Panther Belt Widths (mm)				
	No. Teeth	P.D.	No. Teeth	P.D.		20	42	65	90	120		20	42	65	90	120
Multiply HP rating by the belt length factor to determine drive width - BELT LENGTH FACTOR																
1.87	60	10.53	112	19.65	938	97.37	204.69	316.89	438.84	585.19	621	74.10	155.77	241.16	333.97	445.34
1.87	30	5.26	56	9.83	938	50.50	106.16	164.36	227.61	303.52	621	37.42	78.67	121.79	168.66	224.90
1.88	48	8.42	90	15.79	933	79.38	166.87	258.34	357.77	477.08	619	59.63	125.36	194.07	268.75	358.38
1.88	32	5.61	60	10.53	933	53.80	113.09	175.08	242.46	323.32	619	39.91	83.90	129.89	179.88	239.86
1.88	34	5.97	64	11.23	930	57.07	119.98	185.75	257.23	343.02	616	42.40	89.12	137.98	191.08	254.80
1.89	36	6.32	68	11.93	926	60.33	126.83	196.35	271.91	362.59	614	44.88	94.34	146.05	202.26	269.71
1.89	38	6.67	72	12.63	924	63.57	133.63	206.88	286.50	382.04	612	47.35	99.54	154.10	213.41	284.58
1.93	29	5.09	56	9.83	906	48.85	102.69	158.97	220.16	293.57	601	36.17	76.05	117.73	163.04	217.41
2.00	72	12.63	144	25.26	875	114.01	239.67	371.04	513.84	685.19	580	88.19	185.40	287.03	397.49	530.05
2.00	56	9.83	112	19.65	875	91.51	192.37	297.82	412.43	549.97	580	69.31	145.71	225.58	312.40	416.58
2.00	40	7.02	80	14.04	875	66.78	140.39	217.34	300.98	401.35	580	49.82	104.73	162.14	224.54	299.42
2.00	36	6.32	72	12.63	875	60.33	126.83	196.35	271.91	362.59	580	44.88	94.34	146.05	202.26	269.71
2.00	34	5.97	68	11.93	875	57.07	119.98	185.75	257.23	343.02	580	42.40	89.12	137.98	191.08	254.80
2.00	32	5.61	64	11.23	875	53.80	113.09	175.08	242.46	323.32	580	39.91	83.90	129.89	179.88	239.86
2.00	30	5.26	60	10.53	875	50.50	106.16	164.36	227.61	303.52	580	37.42	78.67	121.79	168.66	224.90
2.00	28	4.91	56	9.83	875	47.19	99.20	153.58	212.68	283.61	580	34.93	73.42	113.67	157.42	209.91
2.05	44	7.72	90	15.79	856	73.13	153.74	238.02	329.62	439.54	567	54.74	115.07	178.15	246.71	328.99
2.07	29	5.09	60	10.53	846	48.85	102.69	158.97	220.16	293.57	561	36.17	76.05	117.73	163.04	217.41
2.10	80	14.04	168	29.48	833	108.63	228.36	353.54	489.60	652.87	552	97.34	204.63	316.79	438.71	585.01
2.11	38	6.67	80	14.04	831	63.57	133.63	206.88	286.50	382.04	551	47.35	99.54	154.10	213.41	284.58
2.12	68	11.93	144	25.26	826	108.63	228.36	353.54	489.60	652.87	548	83.54	175.62	271.89	376.53	502.09
2.12	34	5.97	72	12.63	826	57.07	119.98	185.75	257.23	343.02	548	42.40	89.12	137.98	191.08	254.80
2.13	32	5.61	68	11.93	824	53.80	113.09	175.08	242.46	323.32	546	39.91	83.90	129.89	179.88	239.86
2.13	30	5.26	64	11.23	820	50.50	106.16	164.36	227.61	303.52	544	37.42	78.67	121.79	168.66	224.90
2.14	28	4.91	60	10.53	817	47.19	99.20	153.58	212.68	283.61	541	34.93	73.42	113.67	157.42	209.91
2.15	52	9.12	112	19.65	813	85.51	179.76	278.29	385.39	513.91	539	64.49	135.57	209.88	290.65	387.58
2.21	29	5.09	64	11.23	793	48.85	102.69	158.97	220.16	293.57	526	36.17	76.05	117.73	163.04	217.41
2.22	36	6.32	80	14.04	788	60.33	126.83	196.35	271.91	362.59	522	44.88	94.34	146.05	202.26	269.71
2.25	64	11.23	144	25.26	778	103.08	216.69	335.47	464.58	619.51	516	78.84	165.74	256.60	355.35	473.85
2.25	40	7.02	90	15.79	778	66.78	140.39	217.34	300.98	401.35	516	49.82	104.73	162.14	224.54	299.42
2.25	32	5.61	72	12.63	778	53.80	113.09	175.08	242.46	323.32	516	39.91	83.90	129.89	179.88	239.86
2.27	30	5.26	68	11.93	772	50.50	106.16	164.36	227.61	303.52	512	37.42	78.67	121.79	168.66	224.90
2.29	28	4.91	64	11.23	766	47.19	99.20	153.58	212.68	283.61	508	34.93	73.42	113.67	157.42	209.91
2.33	72	12.63	168	29.48	750	114.01	239.67	371.04	513.84	685.19	497	88.19	185.40	287.03	397.49	530.05
2.33	48	8.42	112	19.65	750	79.38	166.87	258.34	357.77	477.08	497	59.63	125.36	194.07	268.75	358.38
2.34	29	5.09	68	11.93	746	48.85	102.69	158.97	220.16	293.57	495	36.17	76.05	117.73	163.04	217.41
2.35	34	5.97	80	14.04	744	57.07	119.98	185.75	257.23	343.02	493	42.40	89.12	137.98	191.08	254.80
2.37	38	6.67	90	15.79	739	63.57	133.63	206.88	286.50	382.04	490	47.35	99.54	154.10	213.41	284.58
2.40	80	14.04	192	33.69	729	108.63	228.36	353.54	489.60	652.87	483	97.34	204.63	316.79	438.71	585.01
2.40	60	10.53	144	25.26	729	97.37	204.69	316.89	438.84	585.19	483	74.10	155.77	241.16	333.97	445.34
2.40	30	5.26	72	12.63	729	50.50	106.16	164.36	227.61	303.52	483	37.42	78.67	121.79	168.66	224.90
2.43	28	4.91	68	11.93	721	47.19	99.20	153.58	212.68	283.61	478	34.93	73.42	113.67	157.42	209.91
2.47	68	11.93	168	29.48	708	108.63	228.36	353.54	489.60	652.87	470	83.54	175.62	271.89	376.53	502.09
2.48	29	5.09	72	12.63	705	48.85	102.69	158.97	220.16	293.57	467	36.17	76.05	117.73	163.04	217.41
2.50	36	6.32	90	15.79	700	60.33	126.83	196.35	271.91	362.59	464	44.88	94.34	146.05	202.26	269.71
2.50	32	5.61	80	14.04	700	53.80	113.09	175.08	242.46	323.32	464	39.91	83.90	129.89	179.88	239.86
2.55	44	7.72	112	19.65	688	73.13	153.74	238.02	329.62	439.54	456	54.74	115.07	178.15	246.71	328.99
2.57	56	9.83	144	25.26	681	91.51	192.37	297.82	412.43	549.97	451	69.31	145.71	225.58	312.40	416.58
2.57	28	4.91	72	12.63	681	47.19	99.20	153.58	212.68	283.61	451	34.93	73.42	113.67	157.42	209.91
2.63	64	11.23	168	29.48	667	103.08	216.69	335.47	464.58	619.51	442	78.84	165.74	256.60	355.35	473.85
2.65	34	5.97	90	15.79	661	57.07	119.98	185.75	257.23	343.02	438	42.40	89.12	137.98	191.08	254.80
2.67	30	5.26	80	14.04	656	50.50	106.16	164.36	227.61	303.52	435	37.42	78.67	121.79	168.66	224.90
2.67	72	12.63	192	33.69	656	114.01	239.67	371.04	513.84	685.19	435	88.19	185.40	287.03	397.49	530.05
2.70	80	14.04	216	37.90	648	108.63	228.36	353.54	489.60	652.87	430	97.34	204.63	316.79	438.71	585.01
2.76	29	5.09	80	14.04	634	48.85	102.69	158.97	220.16	293.57	421	36.17	76.05	117.73	163.04	217.41
2.77	52	9.12	114	25.26	632	85.51	179.76	278.29	385.39	513.91	419	64.49	135.57	209.88	290.65	387.58
2.80	60	10.53	168	29.48	625	97.37	204.69	316.89	438.84	585.19	414	74.10	155.77	241.16	333.97	445.34
2.80	40	7.02	112	19.65	625	66.78	140.39	217.34	300.98	401.35	414	49.82	104.73	162.14	224.54	299.42
2.81	32	5.61	90	15.79	622	53.80	113.09	175.08	242.46	323.32	412	39.91	83.90	129.89	179.88	239.86
2.82	68	11.93	192	33.69	620	108.63	228.36	353.54	489.60	652.87	411	83.54	175.62	271.89	376.53	502.09
2.86	28	4.91	80	14.04	613	47.19	99.20	153.58	212.68	283.61	406	34.93	73.42	113.67	157.42	209.91
2.95	38	6.67	112	19.65	594	63.57	133.63	206.88	286.50	382.04	394	47.35	99.54	154.10	213.41	284.58
3.00	72	12.63	216	37.90	583	114.01	239.67	371.04	513.84	685.19	387	88.19	185.40	287.03	397.49	530.05
3.00	64	11.23	192	33.69	583	103.08	216.69	335.47	464.58	619.51	387	78.84	165.74	256.60	355.35	473.85
3.00	56	9.83	168	29.48	583	91.51	192.37	297.82	412.43	549.97	387	69.31	145.71	225.58	312.40	416.58
3.00	48	8.42	144	25.26	583	79.38	166.87	258.34	357.77	477.08	387	59.63	125.36	194.07	268.75	358.38

Multiply HP rating by the belt length factor to determine drive width - BELT LENGTH FACTOR



High HP HTS® 14mm Drive Selection Tables

Theoretical Center Distance in Inches for Various Belt Lengths																			
Belt Length Code (mm)																			
966	1190	1400	1610	1778	1890	2100	2310	2450	2590	2800	3150	3360	3500	3850	4326	4578	4956	Drive	
0.8	0.8	0.9	0.9	0.95	0.95	1	1	1.05	1.05	1.1	1.1	1.15	1.15	1.2	1.2	1.25	1.25	Ratio	
	11.3	15.5	19.7	23.0	25.3	17.0	21.3	24.1	26.9	31.1	38.0	42.2	45.0	51.9	61.3	66.3	73.7	1.87	
			12.1	15.6	17.8	29.4	33.5	36.3	39.1	43.2	50.1	54.2	57.0	63.9	73.3	78.2	85.7	1.87	
	10.5	14.7	18.9	22.2	24.4	22.0	26.2	29.0	31.8	35.9	42.8	47.0	49.8	56.7	66.0	71.0	78.5	1.88	
	9.6	13.8	18.0	21.3	23.6	27.7	31.9	34.6	37.4	41.5	48.4	52.6	55.3	62.2	71.6	76.6	84.0	1.88	
		12.9	17.1	20.5	22.7	26.9	31.0	33.8	36.6	40.7	47.6	51.7	54.5	61.4	70.8	75.7	83.2	1.89	
		12.0	16.3	19.6	21.8	26.0	30.2	32.9	35.7	39.9	46.8	50.9	53.7	60.6	69.9	74.9	82.4	1.89	
	11.5	15.7	19.8	23.2	25.4	29.5	33.7	36.4	39.2	43.3	50.2	54.4	57.1	64.0	73.4	78.4	85.8	1.93	
						17.5	21.8	24.6	27.4	31.6	38.5	42.7	45.5	52.4	61.8	66.8	74.3	2.00	
			14.7	18.1	20.4	24.6	28.7	31.5	34.3	38.4	45.3	49.5	52.2	59.2	68.5	73.5	81.0	2.00	
		12.3	16.5	19.9	22.1	26.3	30.4	33.2	36.0	40.1	47.0	51.2	53.9	60.8	70.2	75.2	82.6	2.00	
		13.2	17.4	20.7	23.0	27.1	31.3	34.0	36.8	41.0	47.9	52.0	54.8	61.7	71.0	76.0	83.5	2.00	
	9.8	14.1	18.3	21.6	23.8	27.97	32.1	34.9	37.7	41.8	48.7	52.8	55.6	62.5	71.9	76.8	84.3	2.00	
	10.7	14.9	19.1	22.4	24.7	28.8	33.0	35.7	38.5	42.6	49.5	53.7	56.4	63.3	72.7	77.7	85.1	2.00	
	11.6	15.8	20.0	23.3	25.5	29.7	33.8	36.6	39.3	43.5	50.4	54.5	57.3	64.2	73.5	78.5	86.0	2.00	
			12.6	16.0	18.3	22.5	26.7	29.5	32.3	36.4	43.4	47.5	50.3	57.2	66.6	71.5	79.0	2.05	
	10.8	15.1	19.2	22.6	24.8	29.0	33.1	35.9	38.6	42.8	49.7	53.8	56.6	63.5	72.8	77.8	85.3	2.07	
		10.7	15.0	18.4	20.6	24.8	29.0	31.8	34.5	38.7	45.6	49.8	52.5	59.4	68.8	73.8	81.2	2.11	
		12.5	16.8	20.1	22.4	26.5	30.7	33.5	36.2	40.4	47.3	51.4	54.2	61.1	70.5	75.4	82.9	2.12	
	9.1	13.4	17.6	21.0	23.2	27.4	31.5	34.3	37.1	41.2	48.1	52.3	55.0	61.9	71.3	76.3	83.7	2.13	
	10.0	14.3	18.5	21.8	24.1	28.2	32.4	35.2	37.9	42.1	49.0	53.1	55.9	62.8	72.1	77.1	84.6	2.13	
	10.9	15.2	19.4	22.7	24.9	29.1	33.2	36.0	38.8	42.9	49.8	53.9	56.7	63.6	73.0	77.9	85.4	2.14	
						18.0	22.3	25.1	27.9	32.1	39.1	43.2	46.0	52.9	62.3	67.3	74.8	2.15	
						28.4	32.5	35.3	38.1	42.2	49.1	53.2	56.0	62.9	72.3	77.2	84.7	2.21	
	10.1	14.4	18.6	22.0	24.2	28.4	32.5	35.3	38.1	42.2	49.1	53.2	56.0	62.9	72.3	77.2	84.7	2.21	
		10.9	15.2	18.6	20.9	25.1	29.2	32.0	34.8	38.9	45.9	50.0	52.8	59.7	69.1	74.0	81.5	2.22	
			13.0	16.5	18.8	23.0	27.2	30.0	32.8	36.9	43.9	48.0	50.8	57.7	67.1	72.1	79.5	2.25	
		12.7	17.0	20.4	22.6	26.8	30.9	33.7	36.5	40.6	47.6	51.7	54.5	61.4	70.7	75.7	83.2	2.25	
	9.3	13.7	17.9	21.2	23.5	27.6	31.8	34.6	37.3	41.5	48.4	52.5	55.3	62.2	71.6	76.5	84.0	2.27	
	10.3	14.5	18.8	22.1	24.3	28.5	32.6	35.4	38.2	42.3	49.2	53.4	56.1	63.0	72.4	77.4	84.8	2.29	
											27.6	32.0	34.8	41.9	51.4	56.4	63.9	2.33	
						18.4	22.7	25.6	28.4	32.6	39.6	43.7	46.5	53.5	62.9	67.8	75.3	2.33	
	9.4	13.8	18.0	21.4	23.6	27.8	31.9	34.7	37.5	41.6	48.5	52.7	55.4	62.3	71.7	76.7	84.1	2.34	
		11.1	15.5	18.9	21.1	25.3	29.5	32.3	35.0	39.2	46.1	50.3	53.0	59.9	69.3	74.3	81.8	2.35	
			13.3	16.7	19.0	23.3	27.5	30.3	33.0	37.2	44.1	48.3	51.1	58.0	67.4	72.3	79.8	2.37	
											26.8	29.8	37.0	46.6	51.7	59.3	66.8	2.40	
						18.6	21.6	26.0	33.1	37.3	44.1	47.1	56.6	61.6	69.1	74.0	81.5	2.40	
		13.0	17.2	20.6	22.9	27.0	31.2	34.0	36.7	40.9	47.8	52.0	54.7	61.6	71.0	76.0	83.4	2.40	
	9.5	13.9	18.1	21.5	23.7	27.9	32.1	34.8	37.6	41.7	48.7	52.8	55.6	62.5	71.8	76.8	84.3	2.43	
											20.7	28.1	32.4	35.3	42.4	51.9	56.9	64.4	2.47
			13.1	17.4	20.7	23.0	27.2	31.3	34.1	36.9	41.0	47.9	52.1	54.9	61.8	71.1	76.1	83.6	2.48
			13.5	17.0	19.3	23.5	27.7	30.5	33.3	37.5	44.4	48.6	51.3	58.2	67.6	72.6	80.1	2.50	
		11.3	15.7	19.1	21.4	25.6	29.7	32.5	35.3	39.5	46.4	50.5	53.3	60.2	69.6	74.6	82.0	2.50	
					14.5	18.9	23.2	26.1	28.9	33.1	40.1	44.2	47.0	54.0	63.4	68.4	75.8	2.55	
								19.1	22.1	26.4	33.6	37.8	40.6	47.6	57.1	62.1	69.6	2.57	
	8.8	13.2	17.5	20.9	23.1	27.3	31.5	34.2	37.0	41.2	48.1	52.2	55.0	61.9	71.3	76.2	83.7	2.57	
										21.2	28.6	32.9	35.8	42.8	52.4	57.4	65.0	2.63	
		13.7	17.2	19.5	23.7	28.0	30.8	33.5	37.7	44.7	48.8	51.6	58.5	67.9	72.9	80.3	2.65		
		11.6	15.9	19.3	21.6	25.8	30.0	32.8	35.6	39.7	46.6	50.8	53.6	60.5	69.9	74.8	82.3	2.67	
											23.2	27.7	30.7	37.9	47.6	52.7	60.3	2.67	
		11.7	16.1	19.5	21.7	25.9	30.1	32.9	35.7	39.9	46.8	50.9	53.7	60.6	70.0	75.0	82.4	2.70	
								19.5	22.5	26.9	34.0	38.3	41.1	48.1	57.6	62.6	70.1	2.77	
										21.6	29.0	33.4	36.2	43.3	52.9	57.9	65.5	2.80	
											40.6	44.8	47.5	54.5	63.9	68.9	76.4	2.80	
			13.9	17.4	19.7	24.0	28.2	31.0	33.8	38.0	44.9	49.1	51.8	58.8	68.2	73.1	80.6	2.81	
											23.6	28.2	31.2	38.4	48.1	53.2	60.8	2.82	
		11.8	16.2	19.6	21.8	26.1	30.3	33.0	35.8	40.0	46.9	51.1	53.8	60.7	70.1	75.1	82.6	2.86	
					15.1	19.6	23.9	26.8	29.6	33.8	40.8	45.0	47.8	54.7	64.2	69.1	76.6	2.95	
											24.1	28.6	31.6	38.9	48.6	53.7	61.3	3.00	
											29.5	33.8	36.7	43.8	53.4	58.4	66.0	3.00	
							16.9	20.0	23.0	27.4	34.5	38.8	41.6	48.6	58.1	63.1	70.6	3.00	
966	1190	1400	1610	1778	1890	2100	2310	2450	2590	2800	3150	3360	3500	3850	4326	4578	4956	Drive Ratio	

PULLEYS

High HP HTS® 14mm Drive Selection Tables



Sprocket Combination					HP Ratings @1750 RPM Driver						HP Ratings@1160 RPM					
Drive Ratio	Driver		Driven		DN RPM	RPP Panther Belt Widths (mm)					DN RPM	RPP Panther Belt Widths (mm)				
	No. Teeth	P.D.	No. Teeth	P.D.		20	42	65	90	120		20	42	65	90	120
Multiply HP rating by the belt length factor to determine drive width - BELT LENGTH FACTOR																
3.00	30	5.26	90	15.79	583	50.50	106.16	164.36	227.61	303.52	387	37.42	78.67	121.79	168.66	224.90
3.10	29	5.09	90	15.79	564	48.85	102.69	158.97	220.16	293.57	374	36.17	76.05	117.73	163.04	217.41
3.11	36	6.32	112	19.65	563	60.33	126.83	196.35	271.91	362.59	373	44.88	94.34	146.05	202.26	269.71
3.18	68	11.93	216	37.90	551	108.63	228.36	353.54	489.60	652.87	365	83.54	175.62	271.89	376.53	502.09
3.20	60	10.53	192	33.69	547	97.37	204.69	316.89	438.84	585.19	363	74.10	155.77	241.16	333.97	445.34
3.21	28	4.91	90	15.79	544	47.19	99.20	153.58	212.68	283.61	361	34.93	73.42	113.67	157.42	209.91
3.23	52	9.12	168	29.48	542	85.51	179.76	278.29	385.39	513.91	359	64.49	135.57	209.88	290.65	387.58
3.27	44	7.72	144	25.26	535	73.13	153.74	238.02	329.62	439.54	354	54.74	115.07	178.15	246.71	328.99
3.29	34	5.97	112	19.65	531	57.07	119.98	185.75	257.23	343.02	352	42.40	89.12	137.98	191.08	254.80
3.38	64	11.23	216	37.90	519	103.08	216.69	335.47	464.58	619.51	344	78.84	165.74	256.60	355.35	473.85
3.43	56	9.83	192	33.69	510	91.51	192.37	297.82	412.43	549.97	338	69.31	145.71	225.58	312.40	416.58
3.50	48	8.42	168	29.48	500	79.38	166.87	258.34	357.77	477.08	331	59.63	125.36	194.07	268.75	358.38
3.50	32	5.61	112	19.65	500	53.80	113.09	175.08	242.46	323.32	331	39.91	83.90	129.89	179.88	239.86
3.60	60	10.53	216	37.90	486	97.37	204.69	316.89	438.84	585.19	322	74.10	155.77	241.16	333.97	445.34
3.60	40	7.02	144	25.26	486	66.78	140.39	217.34	300.98	401.35	322	49.82	104.73	162.14	224.54	299.42
3.69	52	9.12	192	33.69	474	85.51	179.76	278.29	385.39	513.91	314	64.49	135.57	209.88	290.65	387.58
3.73	30	5.26	112	19.65	469	50.50	106.16	164.36	227.61	303.52	311	37.42	78.67	121.79	168.66	224.90
3.79	38	6.67	144	25.26	462	63.57	133.63	206.88	286.50	382.04	306	47.35	99.54	154.10	213.41	284.58
3.82	44	7.72	168	29.48	458	73.13	153.74	238.02	329.62	439.54	304	54.74	115.07	178.15	246.71	328.99
3.86	56	9.83	216	37.90	454	91.51	192.37	297.82	412.43	549.97	301	69.31	145.71	225.58	312.40	416.58
3.86	29	5.09	112	19.65	453	48.85	102.69	158.97	220.16	293.57	300	36.17	76.05	117.73	163.04	217.41
4.00	48	8.42	192	33.69	438	79.38	166.87	258.34	357.77	477.08	290	59.63	125.36	194.07	268.75	358.38
4.00	36	6.32	144	25.26	438	60.33	126.83	196.35	271.91	362.59	290	44.88	94.34	146.05	202.26	269.71
4.00	28	4.91	112	19.65	438	47.19	99.20	153.58	212.68	283.61	290	34.93	73.42	113.67	157.42	209.91
4.15	52	9.12	216	37.90	421	85.51	179.76	278.29	385.39	513.91	279	64.49	135.57	209.88	290.65	387.58
4.20	40	7.02	168	29.48	417	66.78	140.39	217.34	300.98	401.35	276	49.82	104.73	162.14	224.54	299.42
4.24	34	5.97	144	25.26	413	57.07	119.98	185.75	257.23	343.02	274	42.40	89.12	137.98	191.08	254.80
4.36	44	7.72	192	33.69	401	73.13	153.74	238.02	329.62	439.54	266	54.74	115.07	178.15	246.71	328.99
4.42	38	6.67	168	29.48	396	63.57	133.63	206.88	286.50	382.04	262	47.35	99.54	154.10	213.41	284.58
4.50	48	8.42	216	37.90	389	79.38	166.87	258.34	357.77	477.08	258	59.63	125.36	194.07	268.75	358.38
4.50	32	5.61	144	25.26	389	53.80	113.09	175.08	242.46	323.32	258	39.91	83.90	129.89	179.88	239.86
4.67	36	6.32	168	29.48	375	60.33	126.83	196.35	271.91	362.59	249	44.88	94.34	146.05	202.26	269.71
4.80	40	7.02	192	33.69	365	66.78	140.39	217.34	300.98	401.35	242	49.82	104.73	162.14	224.54	299.42
4.80	30	5.26	144	25.26	365	50.50	106.16	164.36	227.61	303.52	242	37.42	78.67	121.79	168.66	224.90
4.91	44	7.72	216	37.90	356	73.13	153.74	238.02	329.62	439.54	236	54.74	115.07	178.15	246.71	328.99
4.94	34	5.97	168	29.48	354	57.07	119.98	185.75	257.23	343.02	235	42.40	89.12	137.98	191.08	254.80
4.97	29	5.09	144	25.26	352	48.85	102.69	158.97	220.16	293.57	234	36.17	76.05	117.73	163.04	217.41
5.05	38	6.67	192	33.69	346	63.57	133.63	206.88	286.50	382.04	230	47.35	99.54	154.10	213.41	284.58
5.14	28	4.91	144	25.26	340	47.19	99.20	153.58	212.68	283.61	226	34.93	73.42	113.67	157.42	209.91
5.25	32	5.61	168	29.48	333	53.80	113.09	175.08	242.46	323.32	221	39.91	83.90	129.89	179.88	239.86
5.33	36	6.32	192	33.69	328	60.33	126.83	196.35	271.91	362.59	218	44.88	94.34	146.05	202.26	269.71
5.40	40	7.02	216	37.90	324	66.78	140.39	217.34	300.98	401.35	215	49.82	104.73	162.14	224.54	299.42
5.60	30	5.26	168	29.48	313	50.50	106.16	164.36	227.61	303.52	207	37.42	78.67	121.79	168.66	224.90
5.65	34	5.97	192	33.69	310	57.07	119.98	185.75	257.23	343.02	205	42.40	89.12	137.98	191.08	254.80
5.68	38	6.67	216	37.90	308	63.57	133.63	206.88	286.50	382.04	204	47.35	99.54	154.10	213.41	284.58
5.79	29	5.09	168	29.48	302	48.85	102.69	158.97	220.16	293.57	200	36.17	76.05	117.73	163.04	217.41
6.00	36	6.32	216	37.90	292	60.33	126.83	196.35	271.91	362.59	193	44.88	94.34	146.05	202.26	269.71
6.00	32	5.61	192	33.69	292	53.80	113.09	175.08	242.46	323.32	193	39.91	83.90	129.89	179.88	239.86
6.00	28	4.91	168	29.48	292	47.19	99.20	153.58	212.68	283.61	193	34.93	73.42	113.67	157.42	209.91
6.35	34	5.97	216	37.90	275	57.07	119.98	185.75	257.23	343.02	183	42.40	89.12	137.98	191.08	254.80
6.40	30	5.26	192	33.69	273	50.50	106.16	164.36	227.61	303.52	181	37.42	78.67	121.79	168.66	224.90
6.62	29	5.09	192	33.69	264	48.85	102.69	158.97	220.16	293.57	175	36.17	76.05	117.73	163.04	217.41
6.75	32	5.61	216	37.90	259	53.80	113.09	175.08	242.46	323.32	172	39.91	83.90	129.89	179.88	239.86
6.86	28	4.91	192	33.69	255	47.19	99.20	153.58	212.68	283.61	169	34.93	73.42	113.67	157.42	209.91
7.20	30	5.26	216	37.90	243	50.50	106.16	164.36	227.61	303.52	161	37.42	78.67	121.79	168.66	224.90
7.45	29	5.09	216	37.90	235	48.85	102.69	158.97	220.16	293.57	156	36.17	76.05	117.73	163.04	217.41
7.71	28	4.91	216	37.90	227	47.19	99.20	153.58	212.68	283.61	150	34.93	73.42	113.67	157.42	209.91
Multiply HP rating by the belt length factor to determine drive width - BELT LENGTH FACTOR																



High HP HTS® 14mm Drive Selection Tables

Theoretical Center Distance in Inches for Various Belt Lengths																			
Belt Length Code (mm)																			
966	1190	1400	1610	1778	1890	2100	2310	2450	2590	2800	3150	3360	3500	3850	4326	4578	4956	Drive	
0.8	0.8	0.9	0.9	0.95	0.95	1	1	1.05	1.05	1.1	1.1	1.15	1.15	1.2	1.2	1.25	1.25	Ratio	
			14.2 14.3	17.7 17.8	20.0 20.1 15.3	24.2 24.4 19.8	28.5 28.6 24.2	31.3 31.4 27.0	34.0 34.2 29.8	38.2 38.4 34.1	45.2 45.3 41.1	49.3 49.5 45.3	52.1 52.2 48.0 26.5	59.0 59.2 55.0 34.2	68.4 68.6 64.4 44.1	73.4 73.5 69.4 49.3	80.9 81.0 76.9 56.9	3.00 3.10 3.11 3.18	
			14.4	17.9	20.2 15.6	24.5 20.0	28.7 17.3 24.4	31.5 20.4 27.3	34.3 23.4 30.1	38.5 27.8 34.3	45.4 35.0 41.3	49.6 39.3 45.5	52.1 42.1 48.3	59.3 49.1 55.3	68.7 58.6 64.7	73.7 63.6 69.7	81.1 71.1 77.1	3.20 3.21 3.22 3.29	
											24.9 30.4 41.6	29.5 34.8 45.8	32.5 37.7 48.6 27.4	34.6 39.8 44.8 35.1	44.6 49.5 54.4 45.0	49.7 54.6 59.4 50.2	57.4 62.2 67.0 57.9	3.38 3.43 3.50 3.60	
							17.7	20.8	23.9	28.3	35.5 25.4 41.8 35.7 30.9	39.7 30.0 46.0 42.8 35.2	42.6 33.0 48.8 42.8 38.1	49.6 40.3 55.8 49.8 45.3	59.1 50.0 65.2 59.4 54.9	64.1 55.1 70.2 64.4 59.9	71.6 62.7 77.7 71.9 67.5	3.60 3.69 3.73 3.79 3.82	
				13.6	16.1	20.6	25.0	27.8	30.7	34.9	42.0 25.8 36.0 42.1	46.1 30.4 40.2 46.3	24.5 48.9 33.4 43.1 49.1	27.8 55.9 40.7 50.1 56.0	35.5 65.3 50.5 59.6 65.5	45.5 70.3 55.6 64.6 70.4	50.7 58.4 63.2 72.1 77.9	3.86 3.86 4.00 4.00 4.00	
													24.9 38.6 43.3 33.9 38.8	28.2 45.7 50.3 41.2 46.0	35.9 55.4 59.9 51.0 55.6	46.0 60.4 64.9 56.1 60.7	51.2 58.9 64.9 63.7 68.2	4.15 4.20 4.24 4.36 4.42	
													25.3 40.7 36.2 31.3 40.9	28.6 43.5 39.1 41.7 50.8	36.4 50.6 46.2 41.7 50.8	46.4 65.1 60.9 56.6 65.4	51.6 59.3 72.6 68.5 64.2 72.9	4.50 4.50 4.67 4.80 4.80	
													25.8 29.1 36.8 26.8 36.9	29.1 36.8 41.1 31.5 41.2	36.8 46.5 51.0 41.9 51.1	46.7 56.3 60.5 51.7 60.6	61.4 61.2 65.5 56.8 65.6	69.0 68.7 73.0 64.4 73.2	5.25 5.33 5.40 5.60 5.65
													19.7 27.1 26.2 19.9	24.6 31.7 29.5 24.8	32.2 34.8 29.5 36.9	46.7 42.1 37.3 46.9	56.3 57.1 52.6 61.6	61.4 64.7 60.3 69.2	5.25 5.33 5.40 5.60
													26.4 37.0 26.6 27.5 32.7	29.7 39.9 29.9 35.2 37.1	37.5 47.1 37.7 42.6 47.2	47.6 56.7 47.8 52.4 56.8	52.8 61.8 53.0 57.5 61.9	60.5 69.3 60.8 65.2 69.5	5.68 5.79 6.00 6.00 6.00
													26.8 27.7 27.8 27.0 32.6	30.1 32.4 32.5 30.3 35.6	37.9 42.8 42.9 38.2 43.1	48.0 52.6 52.8 48.3 52.9	53.3 57.8 57.9 53.5 58.0	61.0 65.4 65.5 61.3 65.7	6.35 6.40 6.62 6.75 6.86
													27.2 21.7 21.8	30.5 30.6 30.7	38.4 38.5 38.6	48.5 48.6 48.7	53.7 53.8 54.0	61.5 61.6 61.7	7.20 7.45 7.71
966	1190	1400	1610	1778	1890	2100	2310	2450	2590	2800	3150	3360	3500	3850	4326	4578	4956	Drive Ratio	

PULLEYS

8 mm High HP HTS® Belt Horsepower Ratings



The following tables represent the horsepower ratings for each belt at the pre-determined No. of Teeth, Pitch Diameters and rpm's. These ratings must be multiplied by the applicable belt length factor to obtain corrected HP rating.

		12mm (.47 in.) Wide Belt (8M-12)															
No. Teeth		22	24	26	28	30	32	34	36	38	40	44	48	56	64	72	80
PD	mm	56.02	61.12	66.21	71.30	76.39	81.49	86.58	91.67	96.77	101.86	112.05	122.23	142.60	162.97	183.35	203.72
	in.	2.21	2.41	2.61	2.81	3.01	3.21	3.41	3.61	3.81	4.01	4.41	4.81	5.61	6.42	7.22	8.02
870		3.92	4.31	4.70	5.09	5.48	5.88	6.27	6.67	7.07	7.48	8.28	9.10	10.74	12.39	14.06	15.74
1160		4.90	5.38	5.87	6.36	6.85	7.34	7.83	8.33	8.83	9.33	10.34	11.35	13.39	15.44	17.51	19.58
1750		6.73	7.39	8.06	8.72	9.40	10.07	10.74	11.42	12.10	12.78	14.15	15.52	18.27	21.02	23.77	26.51
3450		11.31	12.40	13.49	14.59	15.68	16.77	17.86	18.95	20.04	21.11	23.26	25.37	29.50	33.47		
10		0.07	0.07	0.08	0.09	0.09	0.10	0.10	0.11	0.12	0.12	0.14	0.15	0.18	0.20	0.23	0.26
20		0.13	0.14	0.15	0.16	0.17	0.19	0.20	0.21	0.22	0.24	0.26	0.28	0.33	0.39	0.44	0.49
30		0.18	0.20	0.22	0.24	0.25	0.27	0.29	0.31	0.32	0.34	0.38	0.41	0.49	0.56	0.63	0.71
50		0.29	0.32	0.35	0.38	0.40	0.43	0.46	0.49	0.52	0.55	0.60	0.66	0.78	0.89	1.01	1.13
70		0.40	0.44	0.47	0.51	0.55	0.59	0.63	0.67	0.71	0.74	0.82	0.90	1.06	1.22	1.38	1.54
100		0.55	0.61	0.66	0.71	0.76	0.82	0.87	0.93	0.98	1.03	1.14	1.25	1.47	1.69	1.92	2.14
200		1.05	1.15	1.25	1.35	1.45	1.55	1.65	1.75	1.85	1.96	2.16	2.37	2.78	3.20	3.62	4.05
300		1.52	1.66	1.81	1.95	2.10	2.25	2.40	2.54	2.69	2.84	3.14	3.44	4.04	4.65	5.26	5.88
400		1.98	2.17	2.36	2.55	2.74	2.93	3.12	3.31	3.51	3.70	4.09	4.48	5.27	6.06	6.85	7.65
500		2.43	2.66	2.89	3.13	3.36	3.60	3.83	4.07	4.31	4.54	5.02	5.50	6.47	7.44	8.41	9.39
600		2.87	3.15	3.42	3.70	3.98	4.25	4.53	4.81	5.09	5.37	5.94	6.51	7.64	8.79	9.94	11.10
700		3.31	3.62	3.94	4.26	4.58	4.90	5.22	5.54	5.87	6.19	6.84	7.49	8.81	10.13	11.45	12.78
800		3.74	4.10	4.46	4.82	5.18	5.54	5.90	6.27	6.63	7.00	7.73	8.47	9.95	11.44	12.94	14.44
900		4.03	4.42	4.82	5.22	5.63	6.03	6.44	6.85	7.26	7.67	8.50	9.34	11.02	12.72	14.43	16.15
1000		4.37	4.80	5.23	5.67	6.11	6.55	6.99	7.43	7.88	8.32	9.22	10.13	11.95	13.79	15.64	17.50
1100		4.70	5.17	5.63	6.10	6.57	7.05	7.52	8.00	8.48	8.96	9.92	10.90	12.86	14.83	16.82	18.81
1200		5.03	5.53	6.02	6.53	7.03	7.53	8.04	8.55	9.06	9.58	10.61	11.65	13.74	15.84	17.96	20.08
1300		5.35	5.88	6.41	6.94	7.48	8.01	8.55	9.10	9.64	10.19	11.28	12.38	14.60	16.83	19.08	21.32
1400		5.67	6.23	6.79	7.35	7.92	8.48	9.05	9.63	10.20	10.78	11.94	13.10	15.45	17.80	20.16	22.53
1500		5.98	6.57	7.16	7.75	8.35	8.95	9.55	10.15	10.76	11.36	12.58	13.81	16.27	18.75	21.23	23.71
1600		6.28	6.90	7.52	8.14	8.77	9.40	10.03	10.67	11.30	11.94	13.22	14.50	17.08	19.67	22.26	24.85
1700		6.58	7.23	7.88	8.53	9.19	9.85	10.51	11.17	11.84	12.50	13.84	15.18	17.88	20.58	23.28	25.97
1800		6.88	7.56	8.23	8.92	9.60	10.29	10.98	11.67	12.36	13.06	14.45	15.85	18.66	21.47	24.27	27.05
1900		7.17	7.88	8.58	9.29	10.01	10.72	11.44	12.16	12.88	13.60	15.06	16.51	19.42	22.33	25.23	28.11
2000		7.46	8.19	8.93	9.66	10.41	11.15	11.89	12.64	13.39	14.14	15.65	17.15	20.17	23.18	26.17	29.14
2500		8.85	9.72	10.58	11.46	12.33	13.20	14.08	14.96	15.84	16.71	18.47	20.22	23.71	27.15	30.54	33.85
3000		10.17	11.16	12.15	13.14	14.14	15.13	16.13	17.12	18.11	19.11	21.08	23.04	26.91	30.68	34.33	
3500		11.43	12.53	13.64	14.74	15.85	16.95	18.05	19.15	20.24	21.33	23.49	25.62	29.77	33.75		
4000		12.63	13.84	15.05	16.26	17.46	18.66	19.86	21.04	22.22	23.39	25.70	27.96	32.29			
4500		13.78	15.09	16.40	17.70	18.99	20.27	21.55	22.81	24.06	25.29	27.70	30.04				
5000		14.89	16.29	17.68	19.06	20.43	21.78	23.12	24.44	25.74	27.02	29.50					

		22mm (.87 in.) Wide Belt (8M-22)															
No. Teeth		22	24	26	28	30	32	34	36	38	40	44	48	56	64	72	80
PD	mm	56.02	61.12	66.21	71.30	76.39	81.49	86.58	91.67	96.77	101.86	112.05	122.23	142.60	162.97	183.35	203.72
	in.	2.21	2.41	2.61	2.81	3.01	3.21	3.41	3.61	3.81	4.01	4.41	4.81	5.61	6.42	7.22	8.02
870		7.20	7.91	8.62	9.34	10.06	10.78	11.51	12.24	12.98	13.72	15.20	16.69	19.70	22.74	25.80	28.88
1160		8.99	9.88	10.77	11.66	12.56	13.47	14.37	15.29	16.20	17.12	18.97	20.82	24.56	28.33	32.12	35.92
1750		12.35	13.56	14.78	16.01	17.24	18.47	19.71	20.95	22.20	23.45	25.96	28.47	33.52	38.57	43.62	48.65
3450		20.75	22.75	24.76	26.76	28.77	30.78	32.78	34.77	36.76	38.74	42.67	46.55	54.13	61.41		
10		0.12	0.13	0.15	0.16	0.17	0.18	0.19	0.20	0.22	0.23	0.25	0.28	0.32	0.37	0.42	0.47
20		0.23	0.25	0.27	0.30	0.32	0.34	0.36	0.39	0.41	0.43	0.48	0.52	0.61	0.71	0.80	0.89
30		0.33	0.37	0.40	0.43	0.46	0.50	0.53	0.56	0.59	0.63	0.69	0.76	0.89	1.03	1.16	1.30
50		0.54	0.59	0.64	0.69	0.74	0.79	0.85	0.90	0.95	1.00	1.11	1.21	1.43	1.64	1.86	2.08
70		0.73	0.80	0.87	0.94	1.01	1.08	1.15	1.22	1.30	1.37	1.51	1.65	1.95	2.24	2.53	2.83
100		1.01	1.11	1.21	1.31	1.40	1.50	1.60	1.70	1.80	1.90	2.10	2.30	2.70	3.11	3.52	3.93
200		1.92	2.10	2.29	2.47	2.66	2.84	3.03	3.21	3.40	3.59	3.97	4.35	5.11	5.88	6.65	7.43
300		2.78	3.05	3.32	3.59	3.86	4.13	4.40	4.67	4.94	5.21	5.76	6.31	7.42	8.53	9.66	10.78
400		3.63	3.98	4.32	4.67	5.02	5.37	5.73	6.08	6.44	6.79	7.51	8.22	9.66	11.12	12.58	14.04
500		4.46	4.88	5.31	5.74	6.17	6.60	7.03	7.47	7.90	8.34	9.21	10.09	11.86	13.65	15.44	17.24
600		5.27	5.77	6.28	6.78	7.29	7.80	8.32	8.83	9.34	9.86	10.90	11.94	14.03	16.13	18.25	20.37
700		6.07	6.65	7.23	7.82	8.40	8.99	9.58	10.17	10.77	11.36	12.55	13.75	16.16	18.58	21.01	23.45
800		6.86	7.52	8.18	8.84	9.50	10.17	10.83	11.50	12.17	12.84	14.19	15.54	18.26	20.99	23.74	26.50
900		7.39	8.12	8.85	9.59	10.33	11.07	11.82	12.57	13.32	14.08	15.60	17.13	20.22	23.34	26.48	29.64
1000		8.02	8.81	9.60	10.40	11.20	12.01	12.82	13.63	14.45	15.28	16.92	18.58	21.93	25.30	28.70	32.11
1100		8.63	9.48	10.33	11.19	12.06	12.93	13.80	14.67	15.55	16.44	18.21	19.99	23.59	27.21	30.85	34.51
1200		9.23	10.14	11.05	11.97	12.90	13.82	14.76	15.69	16.63	17.57	19.47	21.37	25.21	29.07	32.95	36.85
1300		9.82	10.79	11.76	12.73	13.72	14.70	15.69	16.69	17.69	18.69	20.70	22.72	26.79	30.89	35.00	39.12
1400		10.40	11.42	12.45	13.48	14.52	15.57	16.61	17.66	18.72	19.78	21.91	24.04	28.34	32.66	37.00	41.34
1500		10.97	12.05	13.13	14.22	15.31	16.41	17.52	18.62	19.74	20.85	23.09	25.34	29.86	34.40	38.95	43.49
1600		11.53	12.66	13.80	14.94	16.09	17.25	18.41	19.57	20.73	21.90	24.25	26.61	31.35	36.10	40.85	45.59
1700		12.08	13.27	14.46	15.66	16.86	18.07	19.28	20.50	21.72	22.94	25.39	27.86	32.80	37.76	42.71	47.64
1800		12.62	13.86	15.11	16.36	17.61	18.87	20.14	21.41	22.68	23.96	26.52	29.08	34.23	39.38	44.52	49.64
1900		13.16	14.45	15.75	17.05	18.36	19.67	20.99	22.31	23.63	24.96	27.62	30.29	35			



8 mm High HP HTS® Belt Horsepower Ratings

The following tables represent the horsepower ratings for each belt at the pre-determined No. of Teeth, Pitch Diameters and rpm's. These ratings must be multiplied by the applicable belt length factor to obtain corrected HP rating.

35mm (1.38 in.) Wide Belt (8M-35)																	
No. Teeth	22	24	26	28	30	32	34	36	38	40	44	48	56	64	72	80	
	PD mm	56.02	61.12	66.21	71.30	76.39	81.49	86.58	91.67	96.77	101.86	112.05	122.23	142.60	162.97	183.35	203.72
PD in.	2.21	2.41	2.61	2.81	3.01	3.21	3.41	3.61	3.81	4.01	4.41	4.81	5.61	6.42	7.22	8.02	
Smallest Sprocket RPM	870	11.46	12.58	13.72	14.86	16.01	17.16	18.32	19.49	20.66	21.83	24.19	26.56	31.35	36.19	41.06	45.97
	1160	14.31	15.72	17.14	18.56	19.99	21.43	22.88	24.33	25.78	27.25	30.18	33.14	39.09	45.09	51.12	57.17
	1750	19.66	21.59	23.53	25.48	27.43	29.40	31.37	33.35	35.33	37.32	41.31	45.32	53.35	61.39	69.42	77.42
	3450	33.02	36.20	39.40	42.59	45.79	48.98	52.16	55.34	58.50	61.65	67.91	74.08	86.15	97.72		
	10	0.19	0.21	0.23	0.25	0.27	0.29	0.31	0.33	0.34	0.36	0.40	0.44	0.52	0.59	0.67	0.75
	20	0.37	0.40	0.44	0.47	0.51	0.54	0.58	0.62	0.65	0.69	0.76	0.83	0.98	1.12	1.27	1.42
	30	0.53	0.58	0.63	0.69	0.74	0.79	0.84	0.89	0.95	1.00	1.10	1.21	1.42	1.63	1.85	2.06
	50	0.85	0.93	1.02	1.10	1.18	1.26	1.35	1.43	1.51	1.60	1.76	1.93	2.27	2.61	2.96	3.30
	70	1.16	1.27	1.38	1.50	1.61	1.72	1.83	1.95	2.06	2.18	2.40	2.63	3.10	3.56	4.03	4.50
	100	1.61	1.77	1.92	2.08	2.23	2.39	2.55	2.70	2.86	3.02	3.34	3.66	4.30	4.94	5.59	6.25
	200	3.05	3.34	3.64	3.93	4.23	4.52	4.82	5.12	5.41	5.71	6.31	6.92	8.13	9.35	10.58	11.82
	300	4.43	4.86	5.28	5.71	6.14	6.57	7.00	7.43	7.86	8.30	9.17	10.04	11.81	13.58	15.37	17.16
	400	5.77	6.33	6.88	7.44	7.99	8.55	9.12	9.68	10.24	10.81	11.95	13.09	15.38	17.69	20.02	22.35
	500	7.09	7.77	8.45	9.13	9.82	10.50	11.19	11.88	12.58	13.27	14.66	16.07	18.88	21.72	24.57	27.43
	600	8.38	9.19	9.99	10.80	11.61	12.42	13.23	14.05	14.87	15.69	17.34	18.99	22.32	25.67	29.04	32.42
	700	9.66	10.58	11.51	12.44	13.37	14.31	15.25	16.19	17.13	18.08	19.98	21.88	25.71	29.57	33.44	37.33
	800	10.92	11.97	13.01	14.06	15.12	16.18	17.24	18.30	19.37	20.44	22.58	24.73	29.06	33.41	37.78	42.17
	900	11.76	12.92	14.08	15.26	16.43	17.62	18.81	20.00	21.20	22.41	24.83	27.27	32.18	37.14	42.14	47.17
	1000	12.76	14.02	15.28	16.55	17.83	19.11	20.40	21.70	23.00	24.30	26.93	29.57	34.89	40.26	45.67	51.10
	1100	13.74	15.09	16.45	17.82	19.19	20.57	21.96	23.35	24.75	26.16	28.98	31.82	37.54	43.30	49.10	54.93
1200	14.69	16.14	17.59	19.05	20.52	22.00	23.48	24.97	26.47	27.97	30.98	34.01	40.11	46.26	52.44	58.64	
1300	15.63	17.17	18.71	20.27	21.83	23.40	24.97	26.56	28.15	29.74	32.94	36.16	42.64	49.15	55.70	62.26	
1400	16.55	18.18	19.81	21.46	23.11	24.77	26.44	28.11	29.79	31.48	34.86	38.26	45.10	51.98	58.88	65.79	
1500	17.46	19.17	20.89	22.63	24.37	26.12	27.88	29.64	31.41	33.18	36.75	40.32	47.52	54.74	61.98	69.22	
1600	18.35	20.15	21.96	23.78	25.61	27.45	29.29	31.14	33.00	34.86	38.60	42.35	49.88	57.44	65.01	72.56	
1700	19.22	21.11	23.01	24.91	26.83	28.75	30.68	32.62	34.56	36.51	40.41	44.34	52.20	60.09	67.97	75.82	
1800	20.09	22.06	24.04	26.03	28.03	30.04	32.05	34.07	36.10	38.13	42.20	46.29	54.48	62.68	70.85	78.99	
1900	20.94	23.00	25.06	27.13	29.22	31.30	33.40	35.50	37.61	39.72	43.96	48.20	56.71	65.21	73.67	82.08	
2000	21.79	23.92	26.06	28.22	30.38	32.55	34.73	36.91	39.10	41.29	45.69	50.09	58.90	67.69	76.42	85.08	
2500	25.85	28.37	30.91	33.45	36.00	38.55	41.11	43.67	46.24	48.80	53.93	59.05	69.23	79.29	89.18	98.85	
3000	29.70	32.59	35.48	38.38	41.28	44.19	47.09	49.99	52.89	55.79	61.55	67.28	78.57	89.59	100.24		
3500	33.38	36.60	39.82	43.05	46.27	49.49	52.71	55.91	59.10	62.28	68.58	74.81	86.94	98.56			

60mm (2.36 in.) Wide Belt (8M-60)																	
No. Teeth	22	24	26	28	30	32	34	36	38	40	44	48	56	64	72	80	
	PD mm	56.02	61.12	66.21	71.30	76.39	81.49	86.58	91.67	96.77	101.86	112.05	122.23	142.60	162.97	183.35	
PD in.	2.21	2.41	2.61	2.81	3.01	3.21	3.41	3.61	3.81	4.01	4.41	4.81	5.61	6.42	7.22		
Smallest Sprocket RPM	870	19.64	21.58	23.52	25.48	27.45	29.43	31.42	33.41	35.42	41.48	45.55	53.76	62.05	70.41	78.82	
	1160	24.54	26.95	29.38	31.83	34.28	36.75	39.23	41.72	44.21	46.72	51.76	56.82	67.03	77.31	87.65	98.03
	1750	33.71	37.01	40.34	43.68	47.04	50.41	53.79	57.18	60.58	63.99	70.84	77.70	91.47	105.26	119.03	132.74
	3450	56.61	62.08	67.56	73.03	78.51	83.98	89.44	94.89	100.31	105.71	116.44	127.03	147.72	167.57		
	10	0.33	0.36	0.40	0.43	0.46	0.49	0.52	0.56	0.59	0.62	0.69	0.75	0.89	1.02	1.15	1.29
	20	0.63	0.69	0.75	0.81	0.87	0.93	0.99	1.05	1.12	1.18	1.30	1.43	1.68	1.93	2.18	2.44
	30	0.91	1.00	1.09	1.18	1.26	1.35	1.44	1.53	1.62	1.71	1.89	2.07	2.43	2.80	3.17	3.54
	50	1.46	1.60	1.74	1.88	2.02	2.17	2.31	2.45	2.59	2.74	3.02	3.31	3.90	4.48	5.07	5.66
	70	1.99	2.18	2.37	2.57	2.76	2.95	3.15	3.34	3.53	3.73	4.12	4.52	5.31	6.11	6.91	7.72
	100	2.77	3.03	3.30	3.56	3.83	4.10	4.37	4.64	4.91	5.18	5.72	6.27	7.37	8.48	9.59	10.71
	200	5.23	5.73	6.24	6.74	7.25	7.75	8.26	8.77	9.28	9.80	10.83	11.86	13.94	16.04	18.15	20.27
	300	7.60	8.33	9.05	9.79	10.52	11.26	12.00	12.74	13.48	14.23	15.72	17.22	20.24	23.29	26.35	29.42
	400	9.90	10.85	11.80	12.75	13.71	14.67	15.63	16.60	17.56	18.53	20.48	22.44	26.37	30.34	34.32	38.32
	500	12.16	13.32	14.48	15.66	16.83	18.01	19.19	20.38	21.56	22.75	25.15	27.55	32.38	37.24	42.12	47.03
	600	14.38	15.75	17.13	18.51	19.90	21.29	22.69	24.09	25.50	26.91	29.73	32.57	38.28	44.02	49.79	55.59
	700	16.57	18.15	19.74	21.33	22.93	24.54	26.15	27.76	29.38	31.00	34.25	37.52	44.09	50.70	57.34	64.00
	800	18.73	20.52	22.31	24.12	25.93	27.74	29.56	31.38	33.21	35.04	38.72	42.41	49.83	57.29	64.78	72.30
	900	20.17	22.15	24.15	26.16	28.18	30.21	32.25	34.30	36.36	38.42	42.58	46.75	55.18	63.69	72.26	80.88
	1000	21.88	24.03	26.20	28.38	30.57	32.77	34.98	37.21	39.44	41.67	46.18	50.70	59.83	69.04	78.31	87.63
	1100	23.55	25.87	28.20	30.55	32.90	35.27	37.65	40.04	42.44	44.85	49.69	54.55	64.36	74.25	84.19	94.18
1200	25.19	27.67	30.16	32.67	35.19	37.72	40.26	42.82	45.38	47.95	53.12	58.32	68.78	79.33	89.92	100.55	
1300	26.80	29.43	32.09	34.75	37.43	40.12	42.82	45.54	48.26	50.99	56.48	62.00	73.11	84.28	95.51	106.76	
1400	28.38	31.17	33.97	36.79	39.63	42.48	45.34	48.21	51.08	53.97	59.78	65.61	77.34	89.13	100.96	112.80	
1500	29.93	32.87	35.83	38.80	41.79	44.79	47.80	50.82	53.86	56.90	63.01	69.14	81.48	93.87	106.28	118.69	
1600	31.46	34.55	37.65	40.78	43.91	47.06	50.23	53.40	56.58	59.77	66.18	72.61	85.54	98.50	111.47	124.42	
1700	32.96	36.20	39.45	42.72	46.00	49.30	52.61	55.93	59.26	62.60	69.30	76.02					

14 mm High HP HTS® Belt Horsepower Ratings



The following tables represent the horsepower ratings for each belt at the pre-determined No. of Teeth, Pitch Diameters and rpm's. These ratings must be multiplied by the applicable belt length factor to obtain corrected HP rating.

		20mm (.79 in.) Wide Belt (14M-20)																
No. Teeth	PD	28	29	30	32	34	36	38	40	44	48	52	56	60	64	68	72	80
		mm in.	4.91	5.09	5.26	5.61	5.97	6.32	6.67	7.02	7.72	8.42	9.12	9.82	10.53	11.23	11.93	12.63
870		28.21	29.23	30.24	32.26	34.29	36.31	38.33	40.34	44.37	48.39	52.40	56.39	60.37	64.33	68.27	72.20	79.99
1160		34.93	36.17	37.42	39.91	42.40	44.88	47.35	49.82	54.74	59.63	64.49	69.31	74.10	78.84	83.54	88.19	97.34
1750		47.19	48.85	50.50	53.80	57.07	60.33	63.57	66.78	73.13	79.38	85.51	91.51	97.37	103.08	108.63	114.01	
3450		74.98	77.34	79.68	84.23	88.63	92.87											
10		0.46	0.47	0.49	0.52	0.56	0.59	0.62	0.65	0.72	0.78	0.85	0.92	0.98	1.05	1.11	1.18	1.31
20		0.87	0.90	0.93	0.99	1.05	1.11	1.18	1.24	1.36	1.48	1.61	1.73	1.86	1.98	2.10	2.23	2.48
30		1.26	1.30	1.35	1.44	1.53	1.62	1.71	1.80	1.98	2.16	2.34	2.52	2.70	2.88	3.06	3.24	3.59
50		2.01	2.08	2.15	2.30	2.44	2.59	2.73	2.87	3.16	3.45	3.74	4.02	4.31	4.60	4.89	5.18	5.75
70		2.74	2.84	2.94	3.13	3.33	3.52	3.72	3.92	4.31	4.70	5.09	5.48	5.88	6.27	6.66	7.05	7.84
100		3.80	3.94	4.08	4.35	4.62	4.89	5.17	5.44	5.98	6.53	7.07	7.61	8.16	8.70	9.25	9.79	10.88
200		7.20	7.46	7.71	8.23	8.74	9.26	9.77	10.29	11.32	12.35	13.37	14.40	15.43	16.46	17.49	18.52	20.57
300		10.45	10.83	11.20	11.95	12.69	13.44	14.19	14.93	16.43	17.92	19.41	20.90	22.40	23.89	25.38	26.87	29.84
400		13.62	14.10	14.59	15.56	16.53	17.51	18.48	19.45	21.39	23.34	25.28	27.22	29.16	31.09	33.03	34.96	38.83
500		16.72	17.31	17.91	19.10	20.29	21.49	22.68	23.87	26.25	28.63	31.01	33.39	35.76	38.13	40.49	42.86	47.57
600		19.76	20.47	21.17	22.58	23.99	25.40	26.81	28.21	31.02	33.83	36.63	39.43	42.23	45.02	47.80	50.58	56.12
700		22.76	23.58	24.39	26.01	27.63	29.25	30.87	32.49	35.72	38.94	42.16	45.37	48.58	51.77	54.96	58.14	64.47
800		25.73	26.64	27.56	29.39	31.22	33.05	34.87	36.70	40.34	43.97	47.60	51.21	54.81	58.40	61.98	65.54	72.63
900		28.94	29.97	31.01	33.09	35.16	37.23	39.30	41.37	45.49	49.61	53.71	57.79	61.86	65.92	69.95	73.96	81.91
1000		31.29	32.41	33.53	35.77	38.01	40.24	42.47	44.70	49.14	53.57	57.98	62.36	66.72	71.06	75.37	79.64	88.10
1100		33.58	34.78	35.98	38.38	40.77	43.16	45.55	47.93	52.67	57.40	62.09	66.76	71.39	75.99	80.55	85.07	93.97
1200		35.81	37.09	38.37	40.92	43.46	46.00	48.54	51.06	56.10	61.10	66.06	70.99	75.87	80.71	85.49	90.23	99.52
1300		37.99	39.34	40.69	43.39	46.08	48.76	51.44	54.11	59.41	64.68	69.89	75.06	80.17	85.23	90.21	95.13	104.75
1400		40.11	41.54	42.96	45.80	48.63	51.45	54.26	57.06	62.63	68.14	73.59	78.98	84.30	89.54	94.71	99.78	109.66
1500		42.19	43.69	45.18	48.15	51.12	54.07	57.01	59.94	65.75	71.49	77.16	82.75	88.25	93.66	98.97	104.18	114.24
1600		44.22	45.78	47.34	50.45	53.54	56.62	59.69	62.73	68.77	74.73	80.59	86.37	92.03	97.58	103.01	108.31	118.48
1700		46.21	47.84	49.46	52.69	55.91	59.11	62.29	65.45	71.70	77.86	83.90	89.83	95.63	101.30	106.81	112.18	
1800		48.16	49.85	51.53	54.89	58.22	61.54	64.83	68.09	74.54	80.88	87.08	93.15	99.06	104.81	110.39		
1900		50.06	51.81	53.56	57.03	60.48	63.90	67.29	70.66	77.29	83.79	90.13	96.31	102.31	108.12			
2000		51.93	53.74	55.54	59.12	62.68	66.20	69.69	73.15	79.95	86.59	93.05	99.32	105.38	111.21			
2500		60.71	62.78	64.83	68.88	72.88	76.82	80.70	84.50	91.89	98.95							
3000		68.61	70.87	73.10	77.49	81.77	85.96	90.02	93.97									
3500		75.64	78.02	80.36	84.92	89.32	93.56											
		42mm (1.65 in.) Wide Belt (14M-42)																
870		59.31	61.44	63.57	67.82	72.08	76.32	80.57	84.81	93.28	101.73	110.15	118.54	126.90	135.23	143.52	151.78	168.15
1160		73.42	76.05	78.67	83.90	89.12	94.34	99.54	104.73	115.07	125.36	135.57	145.71	155.77	165.74	175.62	185.40	204.63
1750		99.20	102.69	106.16	113.09	119.98	126.83	133.63	140.39	153.74	166.87	179.76	192.37	204.69	216.69	228.36	239.67	
3450		157.62	162.59	167.50	177.07	186.32	195.23											
10		0.96	1.00	1.03	1.10	1.17	1.24	1.31	1.37	1.51	1.65	1.79	1.92	2.06	2.20	2.34	2.48	2.75
20		1.82	1.88	1.95	2.08	2.21	2.34	2.47	2.60	2.86	3.12	3.38	3.64	3.90	4.16	4.42	4.68	5.20
30		2.64	2.74	2.83	3.02	3.21	3.40	3.59	3.78	4.15	4.53	4.91	5.29	5.67	6.04	6.42	6.80	7.56
50		4.23	4.38	4.53	4.83	5.13	5.44	5.74	6.04	6.65	7.25	7.86	8.46	9.07	9.67	10.28	10.88	12.09
70		5.76	5.97	6.17	6.59	7.00	7.41	7.82	8.23	9.06	9.88	10.71	11.53	12.35	13.18	14.00	14.83	16.48
100		8.00	8.28	8.57	9.14	9.71	10.29	10.86	11.43	12.57	13.72	14.86	16.01	17.15	18.30	19.44	20.59	22.87
200		15.13	15.67	16.22	17.30	18.38	19.46	20.54	21.62	23.79	25.95	28.12	30.28	32.44	34.60	36.77	38.93	43.25
300		21.97	22.76	23.54	25.11	26.68	28.25	29.82	31.39	34.53	37.67	40.81	43.94	47.08	50.21	53.35	56.48	62.74
400		28.62	29.65	30.67	32.71	34.76	36.80	38.85	40.89	44.97	49.06	53.14	57.22	61.29	65.36	69.43	73.50	81.62
500		35.14	36.39	37.65	40.16	42.66	45.17	47.68	50.18	55.19	60.19	65.19	70.18	75.17	80.15	85.13	90.10	100.01
600		41.54	43.03	44.51	47.47	50.43	53.39	56.35	59.31	65.22	71.12	77.01	82.89	88.77	94.63	100.49	106.33	117.97
700		47.85	49.56	51.27	54.68	58.08	61.49	64.89	68.29	75.08	81.86	88.63	95.38	102.12	108.84	115.54	122.22	135.52
800		54.09	56.01	57.94	61.79	65.63	69.47	73.31	77.15	84.80	92.44	100.06	107.66	115.23	122.78	130.30	137.79	152.68
900		60.83	63.01	65.19	69.55	73.91	78.26	82.61	86.96	95.63	104.28	112.90	121.49	130.05	138.57	147.04	155.47	172.19
1000		65.78	68.14	70.49	75.20	79.90	84.60	89.28	93.97	103.31	112.61	121.88	131.09	140.26	149.38	158.43	167.43	185.21
1100		70.60	73.12	75.64	80.68	85.71	90.74	95.75	100.76	110.73	120.66	130.53	140.33	150.07	159.74	169.32	178.83	197.55
1200		75.29	77.97	80.66	86.02	91.37	96.71	102.03	107.34	117.92	128.44	138.87	149.23	159.49	169.66	179.73	189.68	209.21
1300		79.86	82.70	85.54	91.21	96.87	102.51	108.14	113.74	124.89	135.96	146.93	157.79	168.54	179.16	189.65	199.99	220.21
1400		84.33	87.32	90.31	96.28	102.23	108.16	114.07	119.96	131.66	143.24	154.70	166.03	177.21	188.24	199.09	209.77	230.52
1500		88.69	91.83	94.97	101.23	107.46	113.67	119.85	126.00	138.21	150.28	162.20	173.95	185.52	196.90	208.06	219.00	240.15
1600		92.96	96.25	99.52	106.06	112.56	119.03	125.47	131.88	144.57	157.09	169.43	181.56	193.47	205.13	216.55	227.69	249.08
1700		97.14	100.56	103.98	110.77	117.54	124.26	130.95	137.59	150.73	163.67	176.38	188.84	201.04	212.95	224.55	235.82	
1800		101.24	104.79	108.33	115.38	122.40	129.36	136.28	143.14	156.70	170.02	183.07	195.82	208.25	220.33	232.05		
1900		105.24	108.92	112.59	119.89	127.14	134.33	141.46	148.54	162.49	176.14	189.48	202.47	215.08	227.28			
2000		109.17	112.97	116.76	124.29	131.76	139.17	146.51	153.78	168.08	182.04	195.62	208.80	221.53	233.79			
2500		127.63	131.97	136.28	144.80	153.21	161.49	169.64	177.64	193.17	208.02							
3000		144.24	148.97	153.66	162.89	171.91	180.70	189.25	197.55									

14 mm High HP HTS® Belt Horsepower Ratings



The following tables represent the horsepower ratings for each belt at the pre-determined No. of Teeth, Pitch Diameters and rpm's. These ratings must be multiplied by the applicable belt length factor to obtain corrected HP rating.

		120mm (4.72 in.) Wide Belt (14M-120)																
No. Teeth	PD mm in.	28	29	30	32	34	36	38	40	44	48	52	56	60	64	68	72	80
				124.78 4.91	129.23 5.09	133.69 5.26	142.60 5.61	151.52 5.97	160.43 6.32	169.34 6.67	178.25 7.02	196.08 7.72	213.90 8.42	231.73 9.12	249.55 9.82	267.38 10.53	285.21 11.23	303.03 11.93
Smallest Sprocket RPM	870	169.57	175.66	181.74	193.90	206.06	218.21	230.34	242.47	266.68	290.82	314.90	338.90	362.81	386.62	410.32	433.91	480.71
	1160	209.91	217.41	224.90	239.86	254.80	269.71	284.58	299.42	328.99	358.38	387.58	416.58	445.34	473.85	502.09	530.05	585.01
	1750	283.61	293.57	303.52	323.32	343.02	362.59	382.04	401.35	439.54	477.08	513.91	549.97	585.19	619.51	652.87	685.20	
	3450	450.62	464.84	478.86	506.23	532.68	558.13											
	10	2.75	2.85	2.95	3.14	3.34	3.54	3.73	3.93	4.32	4.72	5.11	5.50	5.90	6.29	6.68	7.08	7.86
	20	5.20	5.39	5.57	5.95	6.32	6.69	7.06	7.43	8.18	8.92	9.67	10.41	11.16	11.90	12.64	13.39	14.88
	30	7.55	7.82	8.09	8.63	9.17	9.71	10.26	10.80	11.88	12.96	14.04	15.12	16.20	17.28	18.36	19.44	21.61
	50	12.09	12.52	12.95	13.81	14.68	15.54	16.41	17.27	19.00	20.73	22.46	24.19	25.92	27.65	29.38	31.11	34.57
	70	16.47	17.06	17.65	18.83	20.00	21.18	22.36	23.54	25.89	28.25	30.61	32.96	35.32	37.68	40.03	42.39	47.11
	100	22.87	23.69	24.50	26.14	27.77	29.41	31.04	32.68	35.95	39.22	42.49	45.76	49.04	52.31	55.58	58.85	65.39
	200	43.27	44.81	46.36	49.45	52.54	55.64	58.73	61.82	68.01	74.19	80.38	86.56	92.75	98.93	105.11	111.30	123.65
	300	62.82	65.06	67.31	71.80	76.29	80.77	85.26	89.75	98.72	107.70	116.67	125.63	134.60	143.56	152.52	161.47	179.36
	400	81.84	84.76	87.68	93.53	99.37	105.21	111.06	116.90	128.58	140.25	151.92	163.57	175.23	186.87	198.50	210.13	233.34
	500	100.46	104.05	107.63	114.80	121.97	129.14	136.30	143.46	157.78	172.08	186.37	200.65	214.91	229.15	243.37	257.58	285.92
	600	118.77	123.01	127.24	135.71	144.18	152.64	161.10	169.55	186.45	203.32	220.17	236.99	253.78	270.55	287.28	303.98	337.26
	700	136.81	141.69	146.57	156.31	166.05	175.79	185.52	195.24	214.65	234.04	253.38	272.68	291.94	311.15	330.31	349.41	387.44
	800	154.63	160.14	165.64	176.64	187.64	198.62	209.59	220.56	242.45	264.28	286.06	307.78	329.43	351.01	372.51	393.92	436.49
	900	173.90	180.14	186.38	198.84	211.30	223.75	236.18	248.61	273.41	298.13	322.78	347.34	371.80	396.15	420.38	444.48	492.27
	1000	188.06	194.80	201.53	214.99	228.43	241.85	255.26	268.64	295.35	321.95	348.43	374.79	401.00	427.06	452.95	478.66	529.49
	1100	201.83	209.04	216.26	230.66	245.05	259.41	273.75	288.05	316.57	344.95	373.16	401.20	429.05	456.68	484.08	511.25	564.77
	1200	215.24	222.92	230.59	245.91	261.21	276.47	291.70	306.89	337.13	367.19	397.03	426.63	455.98	485.05	513.82	542.27	598.12
	1300	228.31	236.44	244.56	260.77	276.94	293.07	309.15	325.18	357.06	388.70	420.06	451.12	481.84	512.21	542.19	571.76	629.55
	1400	241.08	249.65	258.20	275.26	292.27	309.23	326.12	342.95	376.39	409.51	442.29	474.67	506.64	538.16	569.19	599.70	659.04
	1500	253.57	262.55	271.51	289.40	307.22	324.97	342.64	360.23	395.14	429.65	463.72	497.32	530.39	562.91	594.83	626.10	686.57
	1600	265.78	275.16	284.53	303.21	321.80	340.31	358.72	377.03	413.31	449.11	484.38	519.06	553.10	586.46	619.09	650.93	712.09
	1700	277.73	287.50	297.26	316.70	336.03	355.26	374.37	393.36	430.93	467.92	504.26	539.89	574.76	608.80	641.96	674.18	
	1800	289.43	299.58	309.71	329.87	349.92	369.83	389.61	409.24	448.01	486.07	523.37	559.82	595.36	629.91	663.42		
	1900	300.88	311.40	321.88	342.75	363.47	384.04	404.44	424.66	464.53	503.57	541.70	578.84	614.89	649.79			
	2000	312.11	322.97	333.80	355.33	376.69	397.87	418.86	439.63	480.52	520.42	559.26	596.93	633.34	668.39			
	2500	364.89	377.29	389.60	413.98	438.03	461.70	484.98	507.85	552.25	594.71							
3000	412.36	425.90	439.31	465.69	491.47	516.60	541.05	564.77										
3500	454.60	468.88	482.94	510.38	536.84	562.27												

PLASTICS

PRODUCT	PAGE
INDEX.....	L-1
PLASTIC CAPABILITIES.....	L-2
SECTION I – NON-METALLIC SPROCKETS.....	L-3 - L-12
Sprockets - Stock	
No. 25 – 1/4" Pitch.....	L-3
No. 35 – 3/8" Pitch.....	L-4
No. 40 – 1/2" Pitch.....	L-5
No. 50 – 5/8" Pitch.....	L-6
No. 60 – 3/4" Pitch.....	L-7
No. 80 – 1" Pitch.....	L-8
No. 100 – 1-1/4" Pitch.....	L-9
No. 78 Series Non-Metallic Split Sprockets.....	L-10
Material Characteristics.....	L-11
SECTION II – NATURAL NYLON GEARS	L-12 - L-21
Gears - Stock – 14-1/2° Pressure Angle	
4DP – 2" Face.....	L-13
5DP – 1-3/4" Face.....	L-14
6DP – 1-1/2" Face.....	L-15
8DP – 1-1/4" Face.....	L-16
10DP – 1" Face.....	L-17
12DP – 3/4" Face.....	L-18
16DP – 1/2" Face.....	L-19
20DP – 3/8" Face.....	L-20
Gear Racks – 14-1/2° Pressure Angle	L-21
Gear Racks – 20° Pressure Angle	L-21
SECTION III – SPECIALTY ITEMS.....	L-22 - L-24
Waste Water Treatment Products.....	L-23 - L-24



Injection molded plastic products can be manufactured in a wide variety of sizes and shapes.

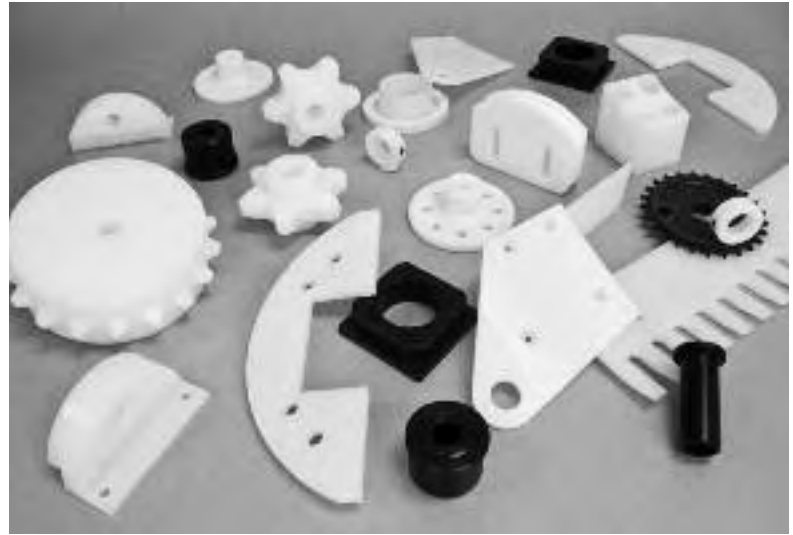

Custom plastic products may be made using materials such as UHMW, Nylon, & Acetal.

Martin's Plastic Capabilities

At *Martin* we believe that continuous assessment, understanding, improvement and innovation of our product line is essential to providing for the ever-evolving needs of our customer base. In 1988, we saw the growing demand for molded plastics in our industry and added our injection mold facility in Paragould, Arkansas.

This facility has been continually updated and is still recognized as one of the largest state-of-the-art facilities in the Southwest. Here we have the capacity and capabilities to produce custom products in a variety of sizes and shapes using a vast array of plastic compounds.

With fuel costs at an all time high, competition from foreign sources, and manufacturing diligently working on ways to cut costs and improve their bottom line, more and more industries are looking to plastics or plastic compounds to reduce weight, improve wear in hostile environments, and reduce overall costs. *Martin* understands this need and now is able to offer machined plastic roller chain sprockets, engineered sprockets and rack and spur gears. *Martin* stocks a wide selection of these products and also has the ability to quickly custom manufacture to your specifications.

Capabilities within our core machined plastic product line includes: Gear Rack up to 120" long 4" thick in 14-1/2° and 20° pressure angles; Spur Gear

from 1" to 24" diameter, 14-1/2° pressure angles; Roller Chain Sprockets 25 to 120 Series, less than 1" diameter to more than 58" diameter; as well as Mill Sprockets (Engineering Class) in 78, 82 and 720 Series. Common materials of construction include UHMW, Nylon and Acetal.

We offer many secondary operations such as side holes, tapped holes, o-ring grooves, milled threads, etc. Other variations of specialty manufacturing might include two-color and inserts.

Custom products made to your exact specifications require precision equipment, quality workmanship, expedient delivery, and strict quality procedures. These are the foundation of *Martin* Sprocket and Gear. We work to ensure that your job is done right every time and ready to ship when you need it.

We live up to our reputation for speed, dependability, and quality.

The addition of machined plastics capabilities, coupled with nearly 60 years experience in steel product manufacturing, allows *Martin* to offer a complete line of both stock and custom products in steel, iron and plastics, as well as the ability to manufacture hybrid products using the three different technologies all under one roof.

Our Roller Chain Sprockets are machined from solid plates of material, resulting in a sprocket that you can count on to get the job done.

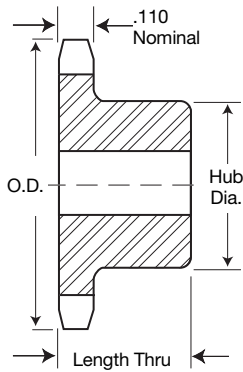

TYPE B

Single-Type B

No. Teeth	Catalog Number	Outside Diameter	Type	Bore (inches)		Hub (inches)		Weight Lbs. (Approx.)
				Stock	Rec. Max.	Diameter	Length Thru	
9	25B9NM	.837	B	1/4	1/4	7/16	1/2	0.01
10	25B10NM	.919	B	1/4	1/4	1/2	1/2	0.01
11	25B11NM	1.001	B	1/4	5/16	9/16	1/2	0.01
12	25B12NM	1.083	B	1/4	3/8	5/8	1/2	0.01
13	25B13NM	1.164	B	1/4	3/8	23/32	1/2	0.01
14	25B14NM	1.245	B	1/4	7/16	13/16	1/2	0.01
15	25B15NM	1.326	B	1/4	7/16	57/64	1/2	0.01
16	25B16NM	1.407	B	1/4	7/16	31/32	1/2	0.02
17	25B17NM	1.487	B	1/4	7/16	1-1/32	1/2	0.02
18	25B18NM	1.568	B	1/4	1/2	1-1/8	1/2	0.02
19	25B19NM	1.648	B	1/4	9/16	1-7/32	1/2	0.02
20	25B20NM	1.728	B	1/4	9/16	1-9/32	5/8	0.02
21	25B21NM	1.809	B	1/4	5/8	1-3/8	5/8	0.02
22	25B22NM	1.889	B	1/4	3/4	1-7/16	5/8	0.03
23	25B23NM	1.969	B	1/4	13/16	1-1/2	5/8	0.05
24	25B24NM	2.049	B	3/8	13/16	1-1/2	5/8	0.05
25	25B25NM	2.129	B	3/8	13/16	1-1/2	5/8	0.05
26	25B26NM	2.209	B	3/8	13/16	1-1/2	5/8	0.05
28	25B28NM	2.369	B	3/8	13/16	1-1/2	5/8	0.05
30	25B30NM	2.529	B	3/8	13/16	1-1/2	5/8	0.06
32	25B32NM	2.688	B	3/8	13/16	1-1/2	5/8	0.06
35	25B35NM	2.928	B	3/8	13/16	1-1/2	5/8	0.06
36	25B36NM	3.008	B	3/8	13/16	1-1/2	3/4	0.07
40	25B40NM	3.327	B	1/2	1-1/8	2	3/4	0.12
42	25B42NM	3.486	B	1/2	1-1/8	2	3/4	0.12
48	25B48NM	3.964	B	1/2	1-1/8	2	3/4	0.13
54	25B54NM	4.442	B	1/2	1-1/8	2	3/4	0.15
60	25B60NM	4.920	B	1/2	1-1/8	2	3/4	0.16
70	25B70NM	5.717	B	1/2	1-1/8	2	3/4	0.19
72	25B72NM	5.876	B	1/2	1-1/8	2	3/4	0.20

Notes:

- Standard Material: Natural Nylon
- Other numbers of teeth and hub styles available
- Available as stock drilled bore, finished drive bore with keyway and setscrews, or idler bore

No. **35**
 $\frac{3}{8}$ " Pitch

Plastic
 Sprockets

Martin

Single-Type B

No. Teeth	Catalog Number	Outside Diameter	Type	Bore (inches)		Hub (inches)		Weight Lbs. (Approx.)
				Stock	Rec. Max.	Diameter	Length Thru	
9	35B9NM	1.255	B	3/8	3/8	27/32	3/4	0.02
10	35B10NM	1.379	B	3/8	7/16	31/32	3/4	0.02
11	35B11NM	1.502	B	3/8	7/16	1-1/16	3/4	0.03
12	35B12NM	1.625	B	1/2	1/2	1-7/32	3/4	0.03
13	35B13NM	1.746	B	1/2	9/16	1-1/4	3/4	0.03
14	35B14NM	1.868	B	1/2	9/16	1-1/4	3/4	0.04
15	35B15NM	1.989	B	1/2	5/8	1-11/32	7/8	0.04
16	35B16NM	2.110	B	1/2	13/16	1-15/32	7/8	0.05
17	35B17NM	2.231	B	1/2	13/16	1-19/32	7/8	0.06
18	35B18NM	2.352	B	1/2	7/8	1-23/32	7/8	0.07
19	35B19NM	2.472	B	1/2	7/8	1-27/32	7/8	0.08
20	35B20NM	2.593	B	1/2	15/16	1-15/16	7/8	0.11
21	35B21NM	2.713	B	1/2	1-1/8	2	7/8	0.12
22	35B22NM	2.833	B	1/2	1-1/8	2	7/8	0.12
23	35B23NM	2.953	B	1/2	1-1/8	2	7/8	0.12
24	35B24NM	3.073	B	1/2	1-1/8	2	7/8	0.12
25	35B25NM	3.193	B	1/2	1-1/8	2	7/8	0.13
26	35B26NM	3.313	B	1/2	1-1/8	2	7/8	0.13
27	35B27NM	3.433	B	1/2	1-1/8	2	7/8	0.13
28	35B28NM	3.553	B	1/2	1-1/8	2	7/8	0.14
30	35B30NM	3.793	B	1/2	1-1/8	2	7/8	0.15
32	35B32NM	4.032	B	1/2	1-1/8	2	7/8	0.16
35	35B35NM	4.392	B	5/8	1-3/4	3-1/4	7/8	0.35
36	35B36NM	4.511	B	5/8	1-3/4	3-1/4	7/8	0.35
40	35B40NM	4.990	B	5/8	1-3/4	3-1/4	1	0.40
42	35B42NM	5.229	B	5/8	1-3/4	3-1/4	1	0.41
45	35B45NM	5.588	B	5/8	1-3/4	3-1/4	1	0.43
48	35B48NM	5.946	B	5/8	2-3/4	4-1/2	1	0.70
54	35B54NM	6.664	B	5/8	2-3/4	4-1/2	1	0.75
60	35B60NM	7.380	B	3/4	2-3/4	4-1/2	1	0.80
70	35B70NM	8.575	B	3/4	4-1/2	7	1	1.65
72	35B72NM	8.814	B	3/4	4-1/2	7	1	1.67
80	35B80NM	9.769	B	3/4	4-1/2	7	1	1.77
84	35B84NM	10.247	B	3/4	4-1/2	9	1	2.65
96	35B96NM	11.680	B	3/4	4-1/2	9	1	2.82
112	35B112NM	13.591	B	3/4	4-1/2	11	1	4.12

Our Roller Chain Sprockets are machined from solid plates of material, resulting in a sprocket that you can count on to get the job done.

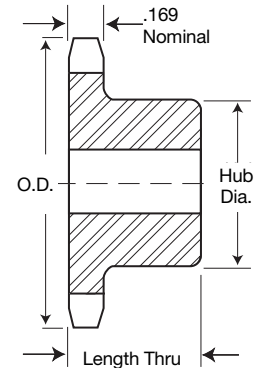

TYPE B

Notes:

- Standard Material: Natural Nylon
- Other numbers of teeth and hub styles available
- Available as stock drilled bore, finished drive bore with keyway and setscrews, or idler bore

Our Roller Chain Sprockets are machined from solid plates of material, resulting in a sprocket that you can count on to get the job done.

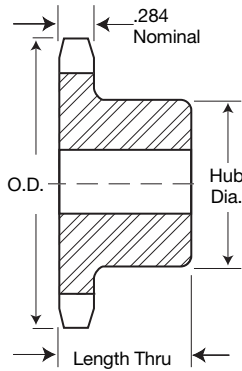

TYPE B

Single-Type B

No. Teeth	Catalog Number	Outside Diameter	Type	Bore (inches)		Hub (inches)		Weight Lbs. (Approx.)
				Stock	Rec. Max.	Diameter	Length Thru	
9	40B9NM	1.674	B	1/2	7/16	1-1/16	7/8	0.03
10	40B10NM	1.839	B	1/2	1/2	1-1/4	7/8	0.04
11	40B11NM	2.003	B	1/2	9/16	1-3/8	7/8	0.05
12	40B12NM	2.166	B	1/2	5/8	1-9/16	7/8	0.06
13	40B13NM	2.329	B	1/2	5/8	1-9/16	7/8	0.08
14	40B14NM	2.491	B	1/2	3/4	1-11/16	7/8	0.08
15	40B15NM	2.652	B	1/2	7/8	1-13/16	7/8	0.10
16	40B16NM	2.814	B	5/8	15/16	2	7/8	0.11
17	40B17NM	2.975	B	5/8	1-1/8	2-1/8	1	0.14
18	40B18NM	3.136	B	5/8	1-1/8	2-5/16	1	0.16
19	40B19NM	3.296	B	5/8	1-1/4	2-1/2	1	0.19
20	40B20NM	3.457	B	5/8	1-3/8	2-5/8	1	0.25
21	40B21NM	3.617	B	5/8	1-1/2	2-3/4	1	0.27
22	40B22NM	3.778	B	5/8	1-5/8	2-7/8	1	0.30
23	40B23NM	3.938	B	5/8	1-5/8	3	1	0.33
24	40B24NM	4.098	B	5/8	1-3/4	3-1/4	1	0.38
25	40B25NM	4.258	B	5/8	1-3/4	3-1/4	1	0.39
26	40B26NM	4.418	B	5/8	1-3/4	3-1/4	1	0.40
27	40B27NM	4.578	B	5/8	1-3/4	3-1/4	1	0.41
28	40B28NM	4.738	B	5/8	1-3/4	3-1/4	1	0.43
29	40B29NM	4.897	B	5/8	1-3/4	3-1/4	1	0.44
30	40B30NM	5.057	B	5/8	1-3/4	3-1/4	1	0.45
31	40B31NM	5.217	B	5/8	1-3/4	3-1/4	1	0.47
32	40B32NM	5.377	B	5/8	1-3/4	3-1/4	1	0.48
33	40B33NM	5.536	B	5/8	1-3/4	3-1/4	1	0.50
34	40B34NM	5.696	B	5/8	1-3/4	3-1/4	1	0.41
35	40B35NM	5.855	B	5/8	1-3/4	3-1/4	1	0.53
36	40B36NM	6.015	B	5/8	1-3/4	3-1/4	1	0.55
37	40B37NM	6.175	B	5/8	1-3/4	3-1/4	1	0.57
38	40B38NM	6.334	B	5/8	1-3/4	3-1/4	1	0.58
39	40B39NM	6.494	B	5/8	1-3/4	3-1/4	1	0.60
40	40B40NM	6.653	B	3/4	2	3-1/2	1-1/8	0.70
41	40B41NM	6.813	B	3/4	2	3-1/2	1-1/8	0.72
42	40B42NM	6.972	B	3/4	2	3-1/2	1-1/8	0.74
43	40B43NM	7.131	B	3/4	2	3-1/2	1-1/8	0.76
44	40B44NM	7.291	B	3/4	2	3-1/2	1-1/8	0.78
45	40B45NM	7.450	B	3/4	2	3-1/2	1-1/8	0.80
46	40B46NM	7.610	B	3/4	2	3-1/2	1-1/8	0.82
47	40B47NM	7.769	B	3/4	2	3-1/2	1-1/8	0.84
48	40B48NM	7.929	B	3/4	2	3-1/2	1-1/8	0.86
49	40B49NM	8.088	B	3/4	2	3-1/2	1-1/8	0.89
50	40B50NM	8.247	B	3/4	2	3-1/2	1-1/8	0.91
51	40B51NM	8.407	B	3/4	2	3-1/2	1-1/8	0.93
52	40B52NM	8.566	B	3/4	2	3-1/2	1-1/8	0.96
53	40B53NM	8.725	B	3/4	2	3-1/2	1-1/8	0.98
54	40B54NM	8.885	B	3/4	2	3-1/2	1-1/8	1.01
55	40B55NM	9.044	B	3/4	2-1/2	4	1-1/8	1.13
56	40B56NM	9.203	B	3/4	2-1/2	4	1-1/8	1.16
57	40B57NM	9.363	B	3/4	4-1/2	7	1-1/8	2.06
58	40B58NM	9.522	B	3/4	4-1/2	7	1-1/8	2.08
59	40B59NM	9.681	B	3/4	4-1/2	7	1-1/8	2.11
60	40B60NM	9.841	B	3/4	4-1/2	7	1-1/8	2.14
70	40B70NM	11.433	B	3/4	4-1/2	7	1-1/4	2.63
80	40B80NM	13.026	B	3/4	4-1/2	10	1-1/4	4.53
84	40B84NM	13.663	B	3/4	4-1/2	10	1-1/4	4.68
96	40B96NM	15.573	B	1	4-1/2	12	1-1/4	6.49

Notes:

- Standard Material: Natural Nylon
- Other numbers of teeth and hub styles available
- Available as stock drilled bore, finished drive bore with keyway and setscrews, or idler bore

No. 50 5/8" Pitch

Plastic Sprockets

Martin

Single-Type B

No. Teeth	Catalog Number	Outside Diameter	Type	Bore (inches)		Hub (inches)		Weight Lbs. (Approx.)
				Stock	Rec. Max.	Diameter	Length Thru	
9	50B9NM	2.092	B	5/8	3/4	1-3/8	1	0.06
10	50B10NM	2.299	B	5/8	13/16	1-9/16	1	0.08
11	50B11NM	2.504	B	5/8	7/8	1-3/4	1	0.10
12	50B12NM	2.708	B	5/8	7/8	1-63/64	1	0.13
13	50B13NM	2.911	B	5/8	7/8	1-7/8	1	0.13
14	50B14NM	3.113	B	5/8	1-1/8	2-1/8	1	0.16
15	50B15NM	3.315	B	5/8	1-1/4	2-3/8	1	0.19
16	50B16NM	3.517	B	5/8	1-3/8	2-1/2	1	0.22
17	50B17NM	3.718	B	5/8	1-1/2	2-11/16	1	0.25
18	50B18NM	3.920	B	5/8	1-5/8	2-7/8	1	0.28
19	50B19NM	4.120	B	5/8	1-3/4	3	1	0.31
20	50B20NM	4.321	B	3/4	1-3/4	3	1	0.32
21	50B21NM	4.522	B	3/4	1-3/4	3	1	0.34
22	50B22NM	4.722	B	3/4	1-3/4	3	1	0.36
23	50B23NM	4.922	B	3/4	1-3/4	3	1	0.38
24	50B24NM	5.122	B	3/4	1-3/4	3	1-1/4	0.45
25	50B25NM	5.322	B	3/4	1-3/4	3	1-1/4	0.47
26	50B26NM	5.522	B	3/4	1-3/4	3	1-1/4	0.49
27	50B27NM	5.722	B	3/4	1-3/4	3	1-1/4	0.51
28	50B28NM	5.922	B	3/4	1-3/4	3	1-1/4	0.54
29	50B29NM	6.122	B	3/4	1-3/4	3	1-1/4	0.56
30	50B30NM	6.321	B	3/4	1-3/4	3-1/4	1-1/4	0.62
31	50B31NM	6.521	B	3/4	1-3/4	3-1/4	1-1/4	0.64
32	50B32NM	6.721	B	3/4	1-3/4	3-1/4	1-1/4	0.67
33	50B33NM	6.920	B	3/4	1-3/4	3-1/4	1-1/4	0.70
34	50B34NM	7.120	B	3/4	1-3/4	3-1/4	1-1/4	0.72
35	50B35NM	7.319	B	3/4	1-3/4	3-1/4	1-1/4	0.75
36	50B36NM	7.519	B	3/4	1-3/4	3-1/4	1-1/4	0.78
37	50B37NM	7.718	B	3/4	1-3/4	3-1/4	1-1/4	0.81
38	50B38NM	7.918	B	3/4	1-3/4	3-1/4	1-1/4	0.84
39	50B39NM	8.117	B	3/4	1-3/4	3-1/4	1-1/4	0.87
40	50B40NM	8.316	B	3/4	2	3-1/2	1-1/4	0.94
41	50B41NM	8.516	B	3/4	2	3-1/2	1-1/4	0.97
42	50B42NM	8.715	B	3/4	2	3-1/2	1-1/4	1.00
43	50B43NM	8.914	B	3/4	2	3-1/2	1-1/4	1.04
44	50B44NM	9.114	B	3/4	2	3-1/2	1-1/4	1.07
45	50B45NM	9.313	B	1	2-3/8	4	1-1/4	1.18
46	50B46NM	9.512	B	1	2-3/8	4	1-1/4	1.22
47	50B47NM	9.711	B	1	2-3/8	4	1-1/4	1.25
48	50B48NM	9.911	B	1	2-3/8	4	1-1/4	1.29
49	50B49NM	10.110	B	1	2-3/8	4	1-1/4	1.33
50	50B50NM	10.309	B	1	2-3/4	4-1/2	1-1/4	1.47
51	50B51NM	10.508	B	1	2-3/4	4-1/2	1-1/4	1.51
52	50B52NM	10.707	B	1	2-3/4	4-1/2	1-1/4	1.55
53	50B53NM	10.907	B	1	2-3/4	4-1/2	1-1/4	1.59
54	50B54NM	11.106	B	1	2-3/4	4-1/2	1-1/4	1.63
55	50B55NM	11.305	B	1	4-1/2	7	1-1/4	2.39
56	50B56NM	11.504	B	1	4-1/2	7	1-1/4	2.44
57	50B57NM	11.703	B	1	4-1/2	7	1-1/4	2.48
58	50B58NM	11.902	B	1	4-1/2	7	1-1/4	2.52
59	50B59NM	12.102	B	1	4-1/2	9	1-1/4	3.37
60	50B60NM	12.301	B	1	4-1/2	9	1-1/4	3.41
70	50B70NM	14.292	B	1	4-1/2	9	1-3/4	5.01
72	50B72NM	14.690	B	1	4-1/2	12	1-3/4	7.56

Our Roller Chain Sprockets are machined from solid plates of material, resulting in a sprocket that you can count on to get the job done.

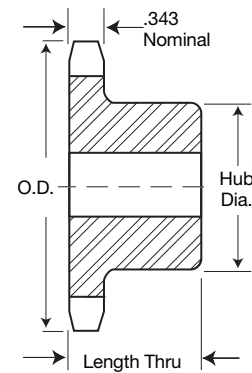

TYPE B

Notes:

- Standard Material: Natural UHMW
- Other numbers of teeth and hub styles available
- Available as stock drilled bore, finished drive bore with keyway and setscrews, or idler bore
- Large sprockets may have bolted-on hubs

Single-Type B

Our Roller Chain Sprockets are machined from solid plates of material, resulting in a sprocket that you can count on to get the job done.

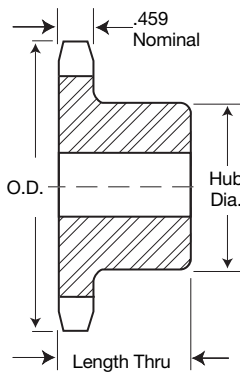

TYPE B

Notes:

- Standard Material: Natural UHMW
- Other numbers of teeth and hub styles available
- Available as stock drilled bore, finished drive bore with keyway and setscrews, or idler bore
- Large sprockets may have bolted-on hubs

No. Teeth	Catalog Number	Outside Diameter	Type	Bore (inches)		Hub (inches)		Weight Lbs. (Approx.)
				Stock	Rec. Max.	Diameter	Length Thru	
9	60B9NM	2.511	B	3/4	7/8	1-1/2	1-1/4	0.11
10	60B10NM	2.758	B	3/4	7/8	1-1/2	1-1/4	0.13
11	60B11NM	3.004	B	3/4	1	2	1-1/4	0.18
12	60B12NM	3.249	B	3/4	1-1/8	2	1-1/4	0.20
13	60B13NM	3.493	B	3/4	1-1/4	2-5/16	1-1/4	0.25
14	60B14NM	3.736	B	3/4	1-3/8	2-1/2	1-1/4	0.29
15	60B15NM	3.978	B	3/4	1-5/8	2-7/8	1-1/4	0.36
16	60B16NM	4.221	B	3/4	1-3/4	3	1-1/4	0.40
17	60B17NM	4.462	B	3/4	1-3/4	3-1/4	1-1/4	0.46
18	60B18NM	4.703	B	3/4	2	3-1/2	1-1/4	0.53
19	60B19NM	4.945	B	3/4	2	3-1/2	1-1/4	0.56
20	60B20NM	5.185	B	3/4	2-1/4	3-7/8	1-1/4	0.65
21	60B21NM	5.426	B	3/4	2-3/8	4	1-1/4	0.70
22	60B22NM	5.666	B	3/4	2-3/8	4	1-1/4	0.73
23	60B23NM	5.907	B	3/4	2-3/8	4	1-1/4	0.77
24	60B24NM	6.147	B	3/4	2-3/8	4	1-1/4	0.81
25	60B25NM	6.387	B	3/4	2-3/8	4	1-1/4	0.84
26	60B26NM	6.627	B	3/4	2-3/8	4	1-1/4	0.88
27	60B27NM	6.867	B	3/4	2-3/8	4	1-1/4	0.92
28	60B28NM	7.106	B	3/4	2-3/8	4	1-1/4	0.97
29	60B29NM	7.346	B	3/4	2-3/8	4	1-1/4	1.01
30	60B30NM	7.586	B	3/4	2-3/8	4	1-1/4	1.05
31	60B31NM	7.825	B	3/4	2-3/8	4	1-1/4	1.10
32	60B32NM	8.065	B	3/4	2-3/8	4	1-1/4	1.15
33	60B33NM	8.304	B	1	2-3/8	4	1-1/4	1.18
34	60B34NM	8.544	B	1	2-3/4	4-1/2	1-1/4	1.33
35	60B35NM	8.783	B	1	2-3/4	4-1/2	1-1/4	1.38
36	60B36NM	9.023	B	1	2-3/4	4-1/2	1-1/4	1.43
37	60B37NM	9.262	B	1	2-3/4	4-1/2	1-1/4	1.49
38	60B38NM	9.501	B	1	2-3/4	4-1/2	1-1/4	1.54
39	60B39NM	9.740	B	1	2-3/4	4-1/2	1-1/4	1.60
40	60B40NM	9.980	B	1	4-1/2	7	1-1/4	2.29
41	60B41NM	10.219	B	1	4-1/2	7	1-1/4	2.35
42	60B42NM	10.458	B	1	4-1/2	7	1-1/4	2.41
43	60B43NM	10.697	B	1	4-1/2	7	1-1/4	2.47
44	60B44NM	10.936	B	1	4-1/2	7	1-1/4	2.54
45	60B45NM	11.175	B	1	4-1/2	7	1-1/4	2.61
46	60B46NM	11.415	B	1	4-1/2	7	1-1/4	2.68
47	60B47NM	11.654	B	1	4-1/2	7	1-1/4	2.74
48	60B48NM	11.893	B	1	4-1/2	7	1-1/4	2.82
49	60B49NM	12.132	B	1	4-1/2	7	1-1/4	2.89
50	60B50NM	12.371	B	1	4-1/2	7	1-1/4	2.96
51	60B51NM	12.610	B	1	4-1/2	7	1-1/4	3.04
52	60B52NM	12.849	B	1	4-1/2	7	1-1/4	3.11
53	60B53NM	13.088	B	1	4-1/2	10	1-1/4	4.30
54	60B54NM	13.327	B	1	4-1/2	10	1-3/4	5.74
55	60B55NM	13.566	B	1-1/4	4-1/2	10	1-3/4	5.80
56	60B56NM	13.805	B	1-1/4	4-1/2	10	1-3/4	5.88
57	60B57NM	14.044	B	1-1/4	4-1/2	10	1-3/4	5.96
58	60B58NM	14.283	B	1-1/4	4-1/2	10	1-3/4	6.05
59	60B59NM	14.522	B	1-1/4	4-1/2	10	1-3/4	6.13
60	60B60NM	14.761	B	1-1/4	4-1/2	10	1-3/4	6.22

No. 80 1" Pitch

Plastic Sprockets

Martin

Single-Type B

No. Teeth	Catalog Number	Outside Diameter	Type	Bore (inches)		Hub (inches)		Weight Lbs. (Approx.)
				Stock	Rec. Max.	Diameter	Length Thru	
9	80B9NM	3.347	B	1	1	2	1-1/2	0.24
10	80B10NM	3.678	B	1	1	2	1-1/2	0.27
11	80B11NM	4.006	B	1	1	2	1-1/2	0.31
12	80B12NM	4.332	B	1	1	2	1-1/2	0.36
13	80B13NM	4.657	B	1	1-3/4	3-1/4	1-1/2	0.57
14	80B14NM	4.981	B	1	1-3/4	3-1/4	1-1/2	0.62
15	80B15NM	5.305	B	1	1-3/4	3-1/4	1-1/2	0.67
16	80B16NM	5.627	B	1	2-3/8	4	1-1/2	0.87
17	80B17NM	5.950	B	1	2-3/8	4	1-1/2	0.93
18	80B18NM	6.271	B	1	2-5/8	4-1/4	1-1/2	1.04
19	80B19NM	6.593	B	1	2-5/8	4-1/4	1-1/2	1.11
20	80B20NM	6.914	B	1	2-5/8	4-1/4	1-1/2	1.17
21	80B21NM	7.235	B	1	2-5/8	4-1/4	1-3/4	1.36
22	80B22NM	7.555	B	1	2-5/8	4-1/4	1-3/4	1.44
23	80B23NM	7.876	B	1	2-5/8	4-1/4	1-3/4	1.52
24	80B24NM	8.196	B	1	2-5/8	4-1/4	1-3/4	1.60
25	80B25NM	8.516	B	1	2-5/8	4-1/4	1-3/4	1.68
26	80B26NM	8.836	B	1-1/4	2-3/4	4-3/4	2	2.03
27	80B27NM	9.156	B	1-1/4	2-3/4	4-3/4	2	2.12
28	80B28NM	9.475	B	1-1/4	2-3/4	4-3/4	2	2.22
29	80B29NM	9.795	B	1-1/4	2-3/4	4-3/4	2	2.31
30	80B30NM	10.114	B	1-1/4	2-3/4	4-3/4	2	2.41
31	80B31NM	10.434	B	1-1/4	2-3/4	4-3/4	2	2.52
32	80B32NM	10.753	B	1-1/4	2-3/4	4-3/4	2	2.63
33	80B33NM	11.072	B	1-1/4	2-3/4	4-3/4	2	2.74
34	80B34NM	11.392	B	1-1/4	2-3/4	4-3/4	2	2.85
35	80B35NM	11.711	B	1-1/4	2-3/4	4-3/4	2	2.97
36	80B36NM	12.030	B	1-1/4	2-3/4	4-3/4	2	3.09
37	80B37NM	12.349	B	1-1/4	4-1/2	8	2	4.83
38	80B38NM	12.668	B	1-1/4	4-1/2	8	2	4.96
39	80B39NM	12.987	B	1-1/4	4-1/2	8	2	5.09
40	80B40NM	13.306	B	1-1/4	4-1/2	8	2	5.22
41	80B41NM	13.625	B	1-1/4	4-1/2	8	2	5.36
42	80B42NM	13.944	B	1-1/4	4-1/2	8	2	5.49
43	80B43NM	14.263	B	1-1/4	4-1/2	8	2	5.64
44	80B44NM	14.582	B	1-1/4	4-1/2	8	2	5.78
45	80B45NM	14.901	B	1-1/4	4-1/2	8	2	5.93
46	80B46NM	15.219	B	1-1/4	4-1/2	8	2	6.08
47	80B47NM	15.538	B	1-1/4	4-1/2	8	2	6.24
48	80B48NM	15.857	B	1-1/4	4-1/2	8	2	6.40
49	80B49NM	16.176	B	1-1/4	4-1/2	8	2	6.56

Our Roller Chain Sprockets are machined from solid plates of material, resulting in a sprocket that you can count on to get the job done.

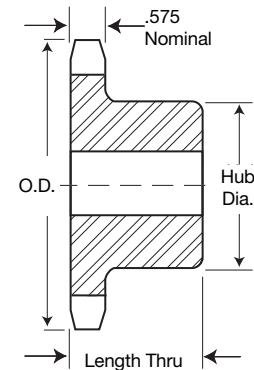

TYPE B

Notes:

- Standard Material: Natural UHMW
- Other numbers of teeth and hub styles available
- Available as stock drilled bore, finished drive bore with keyway and setscrews, or idler bore
- Large sprockets may have bolted-on hubs

Our Roller Chain Sprockets are machined from solid plates of material, resulting in a sprocket that you can count on to get the job done.

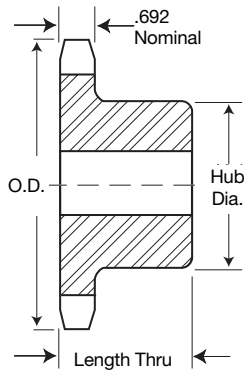

TYPE B

Single-Type B

No. Teeth	Catalog Number	Outside Diameter	Type	Bore (inches)		Hub (inches)		Weight Lbs. (Approx.)
				Stock	Rec. Max.	Diameter	Length Thru	
8	100B8NM	3.768	B	1	1-1/8	2	1-3/4	0.34
9	100B9NM	4.184	B	1	1-1/8	2	1-3/4	0.40
10	100B10NM	4.597	B	1	1-3/4	3-1/4	1-3/4	0.66
11	100B11NM	5.007	B	1	1-3/4	3-1/4	1-3/4	0.74
12	100B12NM	5.415	B	1	1-3/4	3-1/4	1-3/4	0.82
13	100B13NM	5.821	B	1	1-3/4	3-1/4	1-3/4	0.90
14	100B14NM	6.227	B	1-1/4	1-3/4	3-1/4	1-3/4	0.97
15	100B15NM	6.631	B	1-1/4	2-3/8	4	1-3/4	1.23
16	100B16NM	7.034	B	1-1/4	2-3/8	4	1-3/4	1.33
17	100B17NM	7.437	B	1-1/4	2-3/8	4	1-3/4	1.44
18	100B18NM	7.839	B	1-1/4	2-3/8	4	1-3/4	1.56
19	100B19NM	8.241	B	1-1/4	2-3/8	4	2	1.78
20	100B20NM	8.642	B	1-1/4	2-3/8	4	2	1.91
21	100B21NM	9.043	B	1-1/4	2-3/4	4-1/2	2	2.20
22	100B22NM	9.444	B	1-1/4	2-3/4	4-1/2	2	2.34
23	100B23NM	9.844	B	1-1/4	2-3/4	4-1/2	2	2.49
24	100B24NM	10.245	B	1-1/4	2-3/4	4-1/2	2	2.64
25	100B25NM	10.645	B	1-1/4	2-3/4	4-1/2	2	2.80
26	100B26NM	11.045	B	1-1/4	3	5	2	3.13
27	100B27NM	11.444	B	1-1/4	3	5	2	3.30
28	100B28NM	11.844	B	1-1/4	3	5	2	3.48
29	100B29NM	12.244	B	1-1/4	3	5	2	3.66
30	100B30NM	12.643	B	1-1/4	3	5	2	3.85
31	100B31NM	13.042	B	1-1/4	3-3/4	6	2	4.44
32	100B32NM	13.441	B	1-1/4	3-3/4	6	2	4.65
33	100B33NM	13.841	B	1-1/4	3-3/4	6	2	4.85
34	100B34NM	14.240	B	1-1/4	3-3/4	6	2	5.07
35	100B35NM	14.639	B	1-1/4	3-3/4	6	2-1/2	5.76
36	100B36NM	15.038	B	1-1/4	3-3/4	6	2-1/2	5.98
37	100B37NM	15.436	B	1-1/4	3-3/4	6	2-1/2	6.21
38	100B38NM	15.835	B	1-1/4	3-3/4	6	2-1/2	6.45

Notes:

- Standard Material: Natural UHMW
- Other numbers of teeth and hub styles available
- Available as stock drilled bore, finished drive bore with keyway and setscrews, or idler bore
- Large sprockets may have bolted-on hubs

78 Series Non-Metallic Split Sprockets



78 SERIES NON-METALLIC SPROCKETS FOR CHAINS:

78 — H 74 — 75 — H75 — H78 — H 78RT — H 78SR — H79 — NH78 — 578R — 588R — 88 — 188 — S78 — S78 — R588 — RR588 — RR588 — R778 — 988 — IS880 — 87R — IS881 — IS882 — 433-1/2 — LXS882 — LXS86 — US881 — LXS887 — LXS882 — 488 — SS578 — SS188 — US278 — US882 — 26D — H78LR — (14-18 TEETH)

Type C — 2.609" Pitch Split

PLATE THICKNESS .875"
ROLLER DIAMETER 7/8"

Black UHMW Stock
Sprockets

Number of Teeth	Catalog Number	Pitch Diameter	Stock Bore	Max. Bore	Hub Diameter	L.T.B.	Weight Lbs. (Approx.)
6	78C6NMS	5.22	1	1-1/2	NA	2-7/8	1.5
7	78C7NMS	6.01	1	2-3/8	NA	2-7/8	1.7
8	78C8NMS	6.82	1	2-3/8	NA	2-7/8	2.4
9	78C9NMS	7.63	1	3	NA	2-7/8	2.8
10	78C10NMS	8.44	1	3	NA	4	4.5
11	78C11NMS	9.26	1	3	NA	4	5.8
12	78C12NMS	10.08	1	3	NA	4	8.6
13	78C13NMS	10.90	1	3	NA	4	9.0
14	78C14NMS	11.72	1	3	NA	4	9.6
15	78C15NMS	12.55	1	3	NA	4	10.1
16	78C16NMS	13.37	1	4	NA	4	10.7
17	78C17NMS	14.20	1	4	NA	4	11.3
18	78C18NMS	15.02	1	4	NA	4	12.0
19	78C19NMS	15.85	1	4	NA	4	12.7
20	78C20NMS	16.68	1-3/4	4-1/2	NA	4	16.4
21	78C21NMS	17.51	1-3/4	4-1/2	NA	4	17.2
22	78C22NMS	18.33	1-3/4	4-1/2	NA	4	18.0
23	78C23NMS	19.16	1-3/4	4-1/2	NA	4	18.8
24	78C24NMS	19.99	1-3/4	4-1/2	NA	4	19.7
25	78C25NMS	20.82	1-3/4	4-1/2	NA	4	20.7
27	78C27NMS	22.47	1-3/4	4-1/2	NA	4	22.6
28	78C28NMS	23.30	1-3/4	4-1/2	NA	4	23.7
30	78C30NMS	24.96	1-3/4	4-1/2	NA	4	25.8
34	78C34NMS	28.28	1-3/4	4-1/2	NA	4	30.7
40	78C40NMS	33.25	1-3/4	4-1/2	NA	4	42.8
45	78C45NMS	37.40	1-3/4	4-1/2	NA	4	50.8

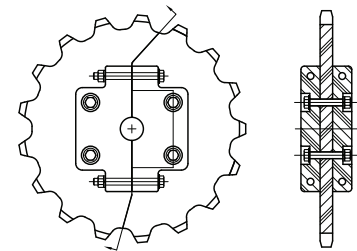

Type C — 2.609" Pitch — Non-Split

PLATE THICKNESS .875"
ROLLER DIAMETER 7/8"

Black UHMW Stock
Sprockets

Number of Teeth	Catalog Number	Pitch Diameter	Stock Bore	Max. Bore	Hub Diameter	L.T.B.	Weight Lbs. Weight
4	78C4NM	3.69	1/2	3/4	1.481	2	0.40
5	78C5NM	4.44	3/4	1	2.461	2	0.65
6	78C6NM	5.22	3/4	1-1/4	3.391	2	0.99
7	78C7NM	6.01	1	2	3-1/2	2	1.23
8	78C8NM	6.82	1	2-3/4	4-3/4	4	3.01
9	78C9NM	7.63	1	3-1/4	5-1/4	4	3.71
10	78C10NM	8.44	1	3-1/4	5-1/4	4	4.04
11	78C11NM	9.26	1	3-1/4	5-1/4	4	4.39
12	78C12NM	10.08	1	3-1/4	5-1/4	4	4.79
13	78C13NM	10.90	1	3-3/8	5-1/2	4	5.43
14	78C14NM	11.72	1	3-3/8	5-1/2	4	5.89
15	78C15NM	12.55	1	3-3/8	5-1/2	4	6.39
16	78C16NM	13.37	1	3-3/8	5-1/2	4	6.92
17	78C17NM	14.20	1	3-3/8	5-1/2	4	7.48
18	78C18NM	15.02	1	3-3/8	5-1/2	4	8.08

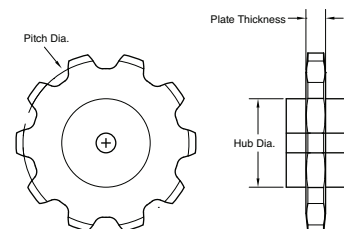

Please contact *Martin* if Hub OD and Length Thru Bore dimensions are critical.
* These parts have setscrews at 90 degrees and 180 degrees instead of over keyway and 90 degrees.
1 Chain saver hubs, chain may contact hubs. Only applicable to sprockets with 4, 5, and 6 teeth.

PLASTICS

MATERIAL	COMMON APPLICATIONS
<p>UHMW Excellent abrasion resistance Low co-efficient of friction Shear strength of approximately 3,500 psi Flexural mod. of approximately 125,000 psi Economical Floats in water Two common types: Natural virgin Food applications Black reprocessed Resistant to UV degradation Slightly less expensive May have multi-colored specks</p>	<p>Wear strips Chain guide Conveyor beds Large structural components RC sprockets (usually 50 series and larger) Mill Sprockets (Engineering Class) (nearly always black reprocessed UHMW) Bushings</p>
<p>Nylon Good abrasion resistance Excellent PV value for bearing applications Shear strength of approximately 10,500 psi Flexural mod. of approximately 500,000 psi Mid-priced Does not float in water Will absorb moisture resulting in dimensional changes and reduced strength Several common types: Natural Food applications MD filled (dark grey color) High load bushings Oil-filled (natural or green color) Gears, bushings, other sliding wear components</p>	<p>High temperature wear strips Small structural components Bushings Spur Gears RC sprockets (usually 50 series and smaller).</p>
<p>Acetal (Typically used for structural components) Not great for wear applications Shear strength of approximately 8,000 psi Flexural mod. of approximately 400,000 psi Mid-priced Does not float in water Does not absorb moisture, good dimensional stability Also known as DuPont™ Delrin® acetal resin. Available in white, or black.</p>	<p>High temperature wear strips Small structural components RC sprockets (usually 50 series and smaller). Bushings Spur gears Components of food processing equipment exposed to wet environments clamps, rollers, dies</p>

DuPont™ and Delrin® is a registered trademarks or trademarks of E. I. du Pont de Nemours and Company or its affiliates.

Plastic Gears Introduction



Martin stocks “B” Style Nylon Spur Gears. Other styles and materials are available as Made-to-Order. Spur gears are available with stock bore, idler bore, or finished bore with keyway and setscrews. Standard material of construction is UHMW, Nylon and Acetal. Gear rack is supplied in nominal 48" lengths, however other lengths can be supplied upon request.

Plastic gears have been used successfully without lubrication in many of today's open gear applications. Many will work lubrication free in demanding applications where steel gears will rust or require continuous maintenance.

One key issue in selecting a plastic gear is proper sizing. Plastics have different properties than metals and are sensitive to changing

operating conditions. In addition to load data, attention to drive geometry, environmental and operating conditions and plastic material properties is critical.

Martin's dedicated sales staff has the experience and knowledge to help you identify and specify the proper gear for your application.

Benefits of Plastic:

- Cost Effective
- Noise Reduction
- Ability to Absorb Shock and Vibration
- Relatively Low Coefficient of Friction
- Corrosion Resistance - elimination of plating, or protective coatings.
- Tolerances often less critical than metal due to greater resilience.





Nylon Stock Spur Gears

14½° Pressure Angle

4 DP 2" Face

Our Spur Gears are machined from solid plates of material, resulting in a spur gear that you can count on to get the job done.

- Standard Material: Natural Oil-Filled Nylon
- Other numbers of teeth and hub styles available
- Available as finished bore with Keyway and Set Screws

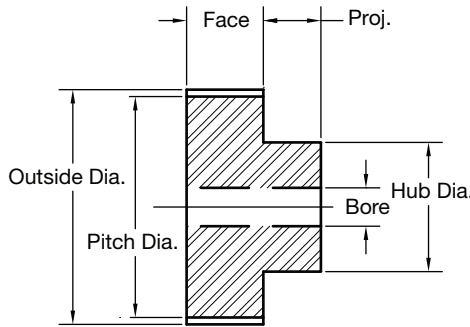

Natural Oil-Filled Nylon Spur Gears

No. Teeth	Catalog Number	Pressure Angle (Deg.)	Diameter		Type	Bore (Inches)		Hub (Inches)		Weight Lbs. (Approx.)
			Pitch	Outside		Stock	Max.*	Diameter	Proj.	
11	NM411	14-1/2	3	3.5	B	3/4	1-1/4	2-1/4	7/8	0.64
12	NM412	14-1/2	3	3.5	B	3/4	1-1/4	2-1/4	7/8	0.64
13	NM413	14-1/2	3.25	3.75	B	3/4	1-1/4	2-1/4	7/8	0.73
14	NM414	14-1/2	3.5	4	B	3/4	1-5/8	2-3/4	7/8	0.9
15	NM415	14-1/2	3.75	4.25	B	1	1-3/4	3	7/8	1.01
16	NM416	14-1/2	4	4.5	B	1	1-3/4	3-1/4	7/8	1.18
17	NM417	14-1/2	4.25	4.75	B	1	2	3-1/2	7/8	1.35
18	NM418	14-1/2	4.5	5	B	1	2-1/4	3-3/4	7/8	1.53
19	NM419	14-1/2	4.75	5.25	B	1	2-3/8	4	7/8	1.72
20	NM420	14-1/2	5	5.5	B	1	2-5/8	4-1/4	7/8	1.93
21	NM421	14-1/2	5.25	5.75	B	1	2-3/4	4-1/2	7/8	2.14
22	NM422	14-1/2	5.5	6	B	1	2-3/4	4-3/4	7/8	2.37
23	NM423	14-1/2	5.75	6.25	B	1	2-3/4	4-3/4	1-1/2	2.95
24	NM424	14-1/2	6	6.5	B	1	2 3/4	4-3/4	1-1/2	3.13
26	NM426	14-1/2	6.5	7	B	1	2-3/4	4-3/4	1-1/2	3.52
28	NM428	14-1/2	7	7.5	B	1	2-3/4	4-3/4	1-1/2	3.93
30	NM430	14-1/2	7.5	8	B	1	2-3/4	4-3/4	1-1/2	4.38
32	NM432	14-1/2	8	8.5	B	1	2-3/4	4-3/4	1-1/2	4.85
33	NM433	14-1/2	8.25	8.75	B	1	2-3/4	4-3/4	1-1/2	5.1
34	NM434	14-1/2	8.5	9	B	1	3	5-1/8	1-1/2	5.53
36	NM436	14-1/2	9	9.5	B	1	3	5-1/8	1-1/2	6.06
38	NM438	14-1/2	9.5	10	B	1	3	5-1/8	1-1/2	6.63
39	NM439	14-1/2	9.75	10.25	B	1	3	5-1/8	1-1/2	6.92
40	NM440	14-1/2	10	10.5	B	1	3	5-1/8	1-1/2	7.23
42	NM442	14-1/2	10.5	11	B	1	3	5-1/8	1-1/2	7.85
44	NM444	14-1/2	11	11.5	B	1	3	5-1/8	1-1/2	8.51
45	NM445	14-1/2	11.25	11.75	B	1	3	5-1/8	1-1/2	8.85
46	NM446	14-1/2	11.5	12	B	1	3	5-1/8	1-1/2	9.2
48	NM448	14-1/2	12	12.5	B	1	3	5-1/8	1-1/2	9.92
51	NM451	14-1/2	12.75	13.25	B	1	3	5	1-1/2	11
52	NM452	14-1/2	13	13.5	B	1	3	5	1-1/2	11.39
54	NM454	14-1/2	13.5	14	B	1	3	5	1-1/2	12.21
55	NM455	14-1/2	13.75	14.25	B	1	3	5	1-1/2	12.62
56	NM456	14-1/2	14	14.5	B	1	3	5	1-1/2	13.05
57	NM457	14-1/2	14.25	14.75	B	1	3	5	1-1/2	13.48
60	NM460	14-1/2	15	15.5	B	1	3	5	1-1/2	14.83

* Recommended Maximum Bore With Keyway and Setscrew.
† Enlarged Pitch Diameter with Special Tooth Form.

14½° P.A. Gears Will Not Operate With 20° P.A.

5 DP

1³/₄" Face

Nylon Stock Spur Gears

14¹/₂° Pressure Angle

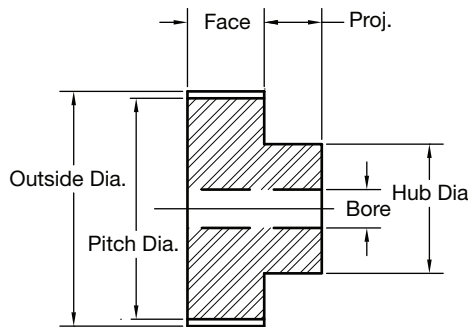

Our Spur Gears are machined from solid plates of material, resulting in a spur gear that you can count on to get the job done.

- Standard Material: Natural Oil-Filled Nylon
- Other numbers of teeth and hub styles available
- Available as finished bore with Keyway and Set Screws

Natural Oil-Filled Nylon Spur Gears

No. Teeth	Catalog Number	Pressure Angle (Deg.)	Diameter		Type	Bore (Inches)		Hub (Inches)		Weight Lbs. (Approx.)
			Pitch	Outside		Stock	Max.*	Diameter	Proj.	
11	NM511	14-1/2	2.2	2.6	B	3/4	7/8	1-25/32	7/8	0.3
12	NM512	14-1/2	2.4	2.8	B	3/4	7/8	1-25/32	7/8	0.35
13	NM513	14-1/2	2.6	3	B	3/4	1-1/8	2	7/8	0.42
14	NM514	14-1/2	2.8	3.2	B	3/4	1-1/8	2-3/16	7/8	0.5
15	NM515	14-1/2	3	3.4	B	3/4	1-1/4	2-3/8	7/8	0.59
16	NM516	14-1/2	3.2	3.6	B	3/4	1-3/8	2-19/32	7/8	0.68
17	NM517	14-1/2	3.4	3.8	B	3/4	1-5/8	2-7/8	7/8	0.8
18	NM518	14-1/2	3.6	4	B	1	1-3/4	3	7/8	0.86
19	NM519	14-1/2	3.8	4.2	B	1	1-3/4	3-1/4	7/8	0.98
20	NM520	14-1/2	4	4.4	B	1	1-3/4	3-3/8	7/8	1.08
21	NM521	14-1/2	4.2	4.6	B	1	1-3/4	3-3/8	7/8	1.17
22	NM522	14-1/2	4.4	4.8	B	1	1-3/4	3-3/8	7/8	1.26
23	NM523	14-1/2	4.6	5	B	1	1-3/4	3-3/8	7/8	1.36
24	NM524	14-1/2	4.8	5.2	B	1	1-3/4	3-3/8	1-1/4	1.58
26	NM526	14-1/2	5.2	5.6	B	1	1-3/4	3-3/8	1-1/4	1.79
28	NM528	14-1/2	5.6	6	B	1	1-3/4	3-3/8	1-1/4	2.03
30	NM530	14-1/2	6	6.4	B	1	1-3/4	3-3/8	1-1/4	2.27
32	NM532	14-1/2	6.4	6.8	B	1	2-5/8	4-1/4	1-1/4	2.8
33	NM533	14-1/2	6.6	7	B	1	2-5/8	4-1/4	1-1/4	2.93
34	NM534	14-1/2	6.8	7.2	B	1	2-5/8	4-1/4	1-1/4	3.08
36	NM536	14-1/2	7.2	7.6	B	1	2-5/8	4-1/4	1-1/4	3.38
38	NM538	14-1/2	7.6	8	B	1	2-5/8	4-1/4	1-1/4	3.7
39	NM539	14-1/2	7.8	8.2	B	1	2-5/8	4-1/4	1-1/4	3.86
40	NM540	14-1/2	8	8.4	B	1	2-5/8	4-1/4	1-1/4	4.03
42	NM542	14-1/2	8.4	8.8	B	1	2-3/4	4-5/8	1-1/4	4.51
44	NM544	14-1/2	8.8	9.2	B	1	2-3/4	4-5/8	1-1/4	4.88
45	NM545	14-1/2	9	9.4	B	1	2-3/4	4-5/8	1-1/4	5.07
46	NM546	14-1/2	9.2	9.6	B	1	2-3/4	4-3/4	1-1/4	5.31
48	NM548	14-1/2	9.6	10	B	1	2-3/4	4-3/4	1-1/4	5.71
51	NM551	14-1/2	10.2	10.6	B	1	2-3/4	4-3/4	1-1/4	6.35
52	NM552	14-1/2	10.4	10.8	B	1	2-3/4	4-3/4	1-1/4	6.57
54	NM554	14-1/2	10.8	11.2	B	1	2-3/4	4-3/4	1-1/4	7.02
55	NM555	14-1/2	11	11.4	B	1	2-3/4	4-3/4	1-1/4	7.26
56	NM556	14-1/2	11.2	11.6	B	1	2-3/4	4-3/4	1-1/4	7.5
57	NM557	14-1/2	11.4	11.8	B	1	2-3/4	4-3/4	1-1/4	7.74
60	NM560	14-1/2	12	12.4	B	1	2-3/4	4-3/4	1-1/4	8.49
63	NM563	14-1/2	12.6	13	B	1	3	5	1-1/4	9.38
64	NM564	14-1/2	12.8	13.2	B	1	3	5	1-1/4	9.65
65	NM565	14-1/2	13	13.4	B	1	3	5	1-1/4	9.92
66	NM566	14-1/2	13.2	13.6	B	1	3	5	1-1/4	10.21
68	NM568	14-1/2	13.6	14	B	1	3	5	1-1/4	10.78
69	NM569	14-1/2	13.8	14.2	B	1	3	5	1-1/4	11.07
70	NM570	14-1/2	14	14.4	B	1	3	5	1-1/4	11.37
72	NM572	14-1/2	14.4	14.8	B	1	3	5	1-1/4	11.98

* Recommended Maximum Bore With Keyway and Setscrew.
† Enlarged Pitch Diameter with Special Tooth Form.

14¹/₂° P.A. Gears Will Not Operate With 20° P.A.

PLASTICS



Nylon Stock Spur Gears

14½° Pressure Angle

6 DP

1½" Face

Natural Oil-Filled Nylon Spur Gears

No. Teeth	Catalog Number	Pressure Angle (Deg.)	Diameter		Type	Bore (Inches)		Hub (Inches)		Weight Lbs. (Approx.)
			Pitch	Outside		Stock	Max.*	Diameter	Proj.	
11	NM611	14-1/2	2	2.333	B	3/4	13/16	1-1/2	7/8	0.2
12	NM612	14-1/2	2	2.333	B	3/4	13/16	1-1/2	7/8	0.2
13	NM613	14-1/2	2.167	2.5	B	3/4	13/16	1-1/2	7/8	0.24
14	NM614	14-1/2	2.333	2.667	B	3/4	7/8	1-13/16	7/8	0.3
15	NM615	14-1/2	2.5	2.833	B	3/4	1-1/8	2	7/8	0.35
16	NM616	14-1/2	2.667	3	B	3/4	1-1/8	2-1/6	7/8	0.41
17	NM617	14-1/2	2.833	3.167	B	3/4	1-1/8	2-1/6	7/8	0.45
18	NM618	14-1/2	3	3.333	B	3/4	1-3/8	2-1/2	7/8	0.54
19	NM619	14-1/2	3.167	3.5	B	3/4	1-3/8	2-1/2	7/8	0.59
20	NM620	14-1/2	3.333	3.667	B	3/4	1-5/8	2-27/32	7/8	0.69
21	NM621	14-1/2	3.5	3.833	B	1	1-3/4	3	7/8	0.73
22	NM622	14-1/2	3.667	4	B	1	1-3/4	3	7/8	0.79
23	NM623	14-1/2	3.833	4.167	B	1	1-3/4	3	1	0.87
24	NM624	14-1/2	4	4.333	B	1	1-3/4	3	1	0.93
26	NM626	14-1/2	4.333	4.667	B	1	1-3/4	3	1	1.06
28	NM628	14-1/2	4.667	5	B	1	1-3/4	3	1	1.2
30	NM630	14-1/2	5	5.333	B	1	1-3/4	3-1/8	1	1.37
32	NM632	14-1/2	5.333	5.667	B	1	1-3/4	3-1/8	1	1.53
33	NM633	14-1/2	5.5	5.833	B	1	1-3/4	3-1/4	1	1.64
34	NM634	14-1/2	5.667	6	B	1	1-3/4	3-1/4	1	1.72
36	NM636	14-1/2	6	6.333	B	1	1-3/4	3-1/4	1	1.9
38	NM638	14-1/2	6.333	6.667	B	1	1-3/4	3-1/4	1	2.09
39	NM639	14-1/2	6.5	6.833	B	1	2-3/8	4	1	2.35
40	NM640	14-1/2	6.667	7	B	1	2-3/8	4	1	2.46
42	NM642	14-1/2	7	7.333	B	1	2-3/8	4	1	2.66
44	NM644	14-1/2	7.333	7.667	B	1	2-3/8	4	1	2.88
45	NM645	14-1/2	7.5	7.833	B	1	2-3/8	4	1	3
46	NM646	14-1/2	7.667	8	B	1	2-3/8	4	1	3.11
48	NM648	14-1/2	8	8.333	B	1	2-1/2	4-1/8	1	3.39
51	NM651	14-1/2	8.5	8.833	B	1	2-1/2	4-1/8	1	3.76
52	NM652	14-1/2	8.667	9	B	1	2-5/8	4-1/4	1	3.93
54	NM654	14-1/2	9	9.333	B	1	2-5/8	4-3/8	1	4.23
55	NM655	14-1/2	9.167	9.5	B	1	2-5/8	4-3/8	1	4.37
56	NM656	14-1/2	9.333	9.667	B	1	2-5/8	4-3/8	1	4.51
57	NM657	14-1/2	9.5	9.833	B	1	2-5/8	4-3/8	1	4.66
60	NM660	14-1/2	10	10.333	B	1	2-5/8	4-3/8	1-1/4	5.24
63	NM663	14-1/2	10.5	10.833	B	1	2-5/8	4-3/8	1-1/4	5.71
64	NM664	14-1/2	10.667	11	B	1	2-5/8	4-3/8	1-1/4	5.88
65	NM665	14-1/2	10.833	11.167	B	1	2-5/8	4-3/8	1-1/4	6.04
66	NM666	14-1/2	11	11.333	B	1	2-5/8	4-3/8	1-1/4	6.21
68	NM668	14-1/2	11.333	11.667	B	1	2-5/8	4-3/8	1-1/4	6.55
69	NM669	14-1/2	11.5	11.833	B	1	2-5/8	4-3/8	1-1/4	6.72
70	NM670	14-1/2	11.667	12	B	1	2-5/8	4-3/8	1-1/4	6.9
72	NM672	14-1/2	12	12.333	B	1	2-5/8	4-3/8	1-1/4	7.26
75	NM675	14-1/2	12.5	12.833	B	1	2-3/4	4-1/2	1-1/4	7.87
76	NM676	14-1/2	12.667	13	B	1	2-3/4	4-1/2	1-1/4	8.06
77	NM677	14-1/2	12.833	13.167	B	1	2-3/4	4-1/2	1-1/4	8.26
78	NM678	14-1/2	13	13.333	B	1	2-3/4	4-1/2	1-1/4	8.46
80	NM680	14-1/2	13.333	13.667	B	1	2-3/4	4-1/2	1-1/4	8.86
84	NM684	14-1/2	14	14.333	B	1	2-3/4	4-1/2	1-1/4	9.7
85	NM685	14-1/2	14.167	14.5	B	1	2-3/4	4-1/2	1-1/4	9.91
88	NM688	14-1/2	14.667	15	B	1	2-3/4	4-1/2	1-1/4	10.57
90	NM690	14-1/2	15	15.333	B	1	2-3/4	4-1/2	1-1/4	11.03

* Recommended Maximum Bore With Keyway and Setscrew.
† Enlarged Pitch Diameter with Special Tooth Form.

14½° P.A. Gears Will Not Operate With 20° P.A.

8 DP

1 1/4" Face

Nylon Stock Spur Gears

14 1/2° Pressure Angle

Natural Oil-Filled Nylon Spur Gears

No. Teeth	Catalog Number	Pressure Angle (Deg.)	Diameter		Type	Bore (Inches)		Hub (Inches)		Weight Lbs. (Approx.)
			Pitch	Outside		Stock	Max.*	Diameter	Proj.	
11	NM811	14-1/2	1.5	1.75	B	1/2	1/2	1-1/8	3/4	0.1
12	NM812	14-1/2	1.5	1.75	B	1/2	1/2	1-1/8	3/4	0.1
13	NM813	14-1/2	1.625	1.875	B	1/2	9/16	1-1/4	3/4	0.12
14	NM814	14-1/2	1.75	2	B	1/2	5/8	1-3/8	3/4	0.15
15	NM815	14-1/2	1.875	2.125	B	1/2	13/16	1-1/2	3/4	0.17
16	NM816	14-1/2	2	2.25	B	1/2	7/8	1-5/8	3/4	0.2
17	NM817	14-1/2	2.125	2.375	B	1/2	7/8	1-3/4	3/4	0.23
18	NM818	14-1/2	2.25	2.5	B	3/4	1	1-7/8	3/4	0.24
19	NM819	14-1/2	2.375	2.625	B	3/4	1-1/8	2	3/4	0.27
20	NM820	14-1/2	2.5	2.75	B	3/4	1-1/8	2-1/8	3/4	0.31
21	NM821	14-1/2	2.625	2.875	B	3/4	1-1/4	2-1/4	3/4	0.35
22	NM822	14-1/2	2.75	3	B	3/4	1-1/4	2-3/8	3/4	0.38
23	NM823	14-1/2	2.875	3.125	B	3/4	1-3/8	2-1/2	1	0.47
24	NM824	14-1/2	3	3.25	B	3/4	1-1/2	2-5/8	1	0.52
26	NM826	14-1/2	3.25	3.5	B	3/4	1-1/2	2-5/8	1	0.58
28	NM828	14-1/2	3.5	3.75	B	3/4	1-1/2	2-5/8	1	0.64
30	NM830	14-1/2	3.75	4	B	3/4	1-5/8	2-3/4	1	0.73
32	NM832	14-1/2	4	4.25	B	1	1-3/4	2-7/8	1	0.8
33	NM833	14-1/2	4.125	4.375	B	1	1-3/4	2-7/8	1	0.84
34	NM834	14-1/2	4.25	4.5	B	1	1-3/4	2-7/8	1	0.88
36	NM836	14-1/2	4.5	4.75	B	1	1-3/4	3	1	0.98
38	NM838	14-1/2	4.75	5	B	1	1-3/4	3	1	1.07
39	NM839	14-1/2	4.875	5.125	B	1	1-3/4	3	1	1.12
40	NM840	14-1/2	5	5.25	B	1	1-3/4	3	1	1.16
42	NM842	14-1/2	5.25	5.5	B	1	1-3/4	3	1	1.26
44	NM844	14-1/2	5.5	5.75	B	1	1-3/4	3	1	1.36
45	NM845	14-1/2	5.625	5.875	B	1	1-3/4	3	1	1.42
46	NM846	14-1/2	5.75	6	B	1	1-3/4	3	1	1.47
48	NM848	14-1/2	6	6.25	B	1	1-3/4	3	1	1.59
51	NM851	14-1/2	6.375	6.625	B	1	1-3/4	3	1	1.76
52	NM852	14-1/2	6.5	6.75	B	1	1-3/4	3	1	1.82
54	NM854	14-1/2	6.75	7	B	1	1-3/4	3	1	1.95
55	NM855	14-1/2	6.875	7.125	B	1	1-3/4	3	1	2.02
56	NM856	14-1/2	7	7.25	B	1	1-3/4	3	1	2.08
57	NM857	14-1/2	7.125	7.375	B	1	1-3/4	3	1	2.15
60	NM860	14-1/2	7.5	7.75	B	1	1-3/4	3	1	2.36
63	NM863	14-1/2	7.875	8.125	B	1	2	3-1/2	1	2.68
64	NM864	14-1/2	8	8.25	B	1	2	3-1/2	1	2.76
65	NM865	14-1/2	8.125	8.375	B	1	2	3-1/2	1	2.83
66	NM866	14-1/2	8.25	8.5	B	1	2	3-1/2	1	2.91
68	NM868	14-1/2	8.5	8.75	B	1	2	3-1/2	1	3.07
69	NM869	14-1/2	8.625	8.875	B	1	2	3-1/2	1	3.15
70	NM870	14-1/2	8.75	9	B	1	2	3-1/2	1	3.24
72	NM872	14-1/2	9	9.25	B	1	2	3-1/2	1	3.41
75	NM875	14-1/2	9.375	9.625	B	1	2	3-1/2	1	3.67
76	NM876	14-1/2	9.5	9.75	B	1	2	3-1/2	1	3.76
77	NM877	14-1/2	9.625	9.875	B	1	2	3-1/2	1-1/8	3.9
78	NM878	14-1/2	9.75	10	B	1	2-3/8	4	1-1/8	4.12
80	NM880	14-1/2	10	10.25	B	1	2-3/8	4	1-1/8	4.31
84	NM884	14-1/2	10.5	10.75	B	1	2-3/8	4	1-1/8	4.7
85	NM885	14-1/2	10.625	10.875	B	1	2-3/8	4	1-1/8	4.8
88	NM888	14-1/2	11	11.25	B	1	2-3/8	4	1-1/8	5.11
90	NM890	14-1/2	11.25	11.5	B	1	2-3/8	4	1-1/8	5.32
91	NM891	14-1/2	11.375	11.625	B	1	2-3/8	4	1-1/8	5.43
92	NM892	14-1/2	11.5	11.75	B	1	2-3/8	4	1-1/8	5.54
96	NM896	14-1/2	12	12.25	B	1	2-3/8	4	1-1/8	5.99

* Recommended Maximum Bore With Keyway and Setscrew.
 † Enlarged Pitch Diameter with Special Tooth Form.

14 1/2° P.A. Gears Will Not Operate With 20° P.A.



Nylon Stock Spur Gears

14½° Pressure Angle

10 DP 1" Face

Natural Oil-Filled Nylon Spur Gears

No. Teeth	Catalog Number	Pressure Angle (Deg.)	Diameter		Type	Bore (Inches)		Hub (Inches)		Weight Lbs. (Approx.)
			Pitch	Outside		Stock	Max.*	Diameter	Proj.	
11	NM1011	14-1/2	1.2	1.4	B	3/8	7/16	15/16	5/8	0.05
12	NM1012	14-1/2	1.2	1.4	B	3/8	7/16	15/16	5/8	0.05
13	NM1013	14-1/2	1.3	1.5	B	3/8	7/16	1	5/8	0.06
14	NM1014	14-1/2	1.4	1.6	B	1/2	1/2	1-1/8	5/8	0.07
15	NM1015	14-1/2	1.5	1.7	B	1/2	1/2	1-7/32	5/8	0.08
16	NM1016	14-1/2	1.6	1.8	B	1/2	9/16	1-5/16	5/8	0.1
17	NM1017	14-1/2	1.7	1.9	B	1/2	5/8	1-3/8	5/8	0.11
18	NM1018	14-1/2	1.8	2	B	1/2	3/4	1-17/32	5/8	0.13
19	NM1019	14-1/2	1.9	2.1	B	1/2	3/4	1-9/16	5/8	0.14
20	NM1020	14-1/2	2	2.2	B	1/2	7/8	1-23/32	5/8	0.17
21	NM1021	14-1/2	2.1	2.3	B	1/2	7/8	1-3/4	5/8	0.18
22	NM1022	14-1/2	2.2	2.4	B	1/2	1	1-7/8	5/8	0.2
23	NM1023	14-1/2	2.3	2.5	B	3/4	1-1/8	2	5/8	0.21
24	NM1024	14-1/2	2.4	2.6	B	3/4	1-1/4	2-1/8	5/8	0.23
26	NM1026	14-1/2	2.6	2.8	B	3/4	1-1/4	2-1/8	5/8	0.27
28	NM1028	14-1/2	2.8	3	B	3/4	1-1/4	2-1/8	7/8	0.33
30	NM1030	14-1/2	3	3.2	B	3/4	1-1/4	2-1/8	7/8	0.36
32	NM1032	14-1/2	3.2	3.4	B	3/4	1-1/4	2-1/8	7/8	0.4
33	NM1033	14-1/2	3.3	3.5	B	3/4	1-1/4	2-1/8	7/8	0.42
34	NM1034	14-1/2	3.4	3.6	B	3/4	1-1/4	2-1/8	7/8	0.44
36	NM1036	14-1/2	3.6	3.8	B	3/4	1-1/4	2-1/4	7/8	0.5
38	NM1038	14-1/2	3.8	4	B	3/4	1-1/4	2-1/4	7/8	0.55
39	NM1039	14-1/2	3.9	4.1	B	3/4	1-1/4	2-1/4	7/8	0.57
40	NM1040	14-1/2	4	4.2	B	3/4	1-1/4	2-1/4	7/8	0.59
42	NM1042	14-1/2	4.2	4.4	B	3/4	1-1/4	2-1/4	7/8	0.64
44	NM1044	14-1/2	4.4	4.6	B	3/4	1-1/4	2-1/4	7/8	0.7
45	NM1045	14-1/2	4.5	4.7	B	3/4	1-3/8	2-1/2	7/8	0.76
46	NM1046	14-1/2	4.6	4.8	B	3/4	1-3/8	2-1/2	7/8	0.78
48	NM4048	14-1/2	4.8	5	B	3/4	1-3/8	2-1/2	7/8	0.84
51	NM1051	14-1/2	5.1	5.3	B	3/4	1-3/8	2-1/2	7/8	0.93
52	NM1052	14-1/2	5.2	5.4	B	3/4	1-3/8	2-1/2	7/8	0.96
54	NM1054	14-1/2	5.4	5.6	B	3/4	1-3/8	2-1/2	7/8	1.03
55	NM1055	14-1/2	5.5	5.7	B	3/4	1-3/8	2-1/2	7/8	1.06
56	NM1056	14-1/2	5.6	5.8	B	3/4	1-3/8	2-1/2	7/8	1.1
57	NM1057	14-1/2	5.7	5.9	B	3/4	1-3/8	2-1/2	7/8	1.13
60	NM1060	14-1/2	6	6.2	B	3/4	1-3/8	2-1/2	7/8	1.24
63	NM1063	14-1/2	6.3	6.5	B	7/8	1-5/8	2-3/4	7/8	1.37
64	NM1064	14-1/2	6.4	6.6	B	7/8	1-5/8	2-3/4	7/8	1.41
65	NM1065	14-1/2	6.5	6.7	B	7/8	1-5/8	2-3/4	7/8	1.45
66	NM1066	14-1/2	6.6	6.8	B	7/8	1-5/8	2-3/4	7/8	1.49
68	NM1068	14-1/2	6.8	7	B	7/8	1-5/8	2-3/4	7/8	1.58
69	NM1069	14-1/2	6.9	7.1	B	7/8	1-5/8	2-3/4	7/8	1.62
70	NM1070	14-1/2	7	7.2	B	7/8	1-5/8	2-3/4	7/8	1.66
72	NM1072	14-1/2	7.2	7.4	B	7/8	1-5/8	2-3/4	7/8	1.75
80	NM1080	14-1/2	8	8.2	B	7/8	1-3/4	3	7/8	2.16
84	NM1084	14-1/2	8.4	8.6	B	7/8	1-3/4	3	7/8	2.36
85	NM1085	14-1/2	8.5	8.7	B	7/8	1-3/4	3	7/8	2.41
90	NM1090	14-1/2	9	9.2	B	7/8	1-3/4	3	7/8	2.68
95	NM1095	14-1/2	9.5	9.7	B	7/8	1-3/4	3	7/8	2.96
96	NM1096	14-1/2	9.6	9.8	B	7/8	1-3/4	3	7/8	3.02
100	NM10100	14-1/2	10	10.2	B	7/8	1-3/4	3	7/8	3.26
105	NM10105	14-1/2	10.5	10.7	B	7/8	1-3/4	3	1	3.61
110	NM10110	14-1/2	11	11.2	B	7/8	1-3/4	3	1	3.94
112	NM10112	14-1/2	11.2	11.4	B	7/8	1-3/4	3	1	4.07
120	NM10120	14-1/2	12	12.2	B	7/8	1-3/4	3	1	4.64

* Recommended Maximum Bore With Keyway and Setscrew.
† Enlarged Pitch Diameter with Special Tooth Form.

14½° P.A. Gears Will Not Operate With 20° P.A.

12 DP

3/4" Face

Nylon Stock Spur Gears

14½° Pressure Angle

Martin

Natural Oil-Filled Nylon Spur Gears

No. Teeth	Catalog Number	Pressure Angle (Deg.)	Diameter		Type	Bore (Inches)		Hub (Inches)		Weight Lbs. (Approx.)
			Pitch	Outside		Stock	Max.*	Diameter	Proj.	
11	NM1211	14-1/2	1	1.167	B	3/8	7/16	3/4	1/2	0.03
12	NM1212	14-1/2	1	1.167	B	3/8	7/16	3/4	1/2	0.03
13	NM1213	14-1/2	1.083	1.25	B	3/8	7/16	13/16	1/2	0.03
14	NM1214	14-1/2	1.167	1.333	B	3/8	7/16	29/32	1/2	0.04
15	NM1215	14-1/2	1.25	1.417	B	3/8	7/16	1	1/2	0.05
16	NM1216	14-1/2	1.333	1.5	B	1/2	1/2	1-1/16	1/2	0.05
17	NM1217	14-1/2	1.417	1.583	B	1/2	1/2	1-1/8	1/2	0.06
18	NM1218	14-1/2	1.5	1.667	B	1/2	1/2	1-1/4	1/2	0.07
19	NM1219	14-1/2	1.583	1.75	B	1/2	9/16	1-5/16	1/2	0.07
20	NM1220	14-1/2	1.667	1.833	B	1/2	3/4	1-13/32	1/2	0.08
21	NM1221	14-1/2	1.75	1.917	B	1/2	13/16	1-1/2	1/2	0.1
22	NM1222	14-1/2	1.833	2	B	1/2	13/16	1-9/16	1/2	0.11
23	NM1223	14-1/2	1.917	2.083	B	1/2	3/4	1-5/8	1/2	0.12
24	NM1224	14-1/2	2	2.167	B	1/2	7/8	1-3/4	1/2	0.13
26	NM1226	14-1/2	2.167	2.333	B	1/2	7/8	1-15/16	5/8	0.17
28	NM1228	14-1/2	2.333	2.5	B	5/8	1-1/8	2-1/16	5/8	0.19
30	NM1230	14-1/2	2.5	2.667	B	5/8	1-1/4	2-1/4	5/8	0.22
32	NM1232	14-1/2	2.667	2.833	B	5/8	1-1/4	2-1/4	5/8	0.24
33	NM1233	14-1/2	2.75	2.917	B	5/8	1-1/4	2-1/4	5/8	0.25
34	NM1234	14-1/2	2.833	3	B	5/8	1-1/4	2-1/4	5/8	0.26
36	NM1236	14-1/2	3	3.167	B	5/8	1-3/8	2-1/2	5/8	0.31
38	NM1238	14-1/2	3.167	3.333	B	5/8	1-3/8	2-1/2	5/8	0.33
39	NM1239	14-1/2	3.25	3.417	B	5/8	1-3/8	2-1/2	5/8	0.35
40	NM1240	14-1/2	3.333	3.5	B	5/8	1-3/8	2-1/2	5/8	0.36
42	NM1242	14-1/2	3.5	3.667	B	5/8	1-3/8	2-1/2	5/8	0.38
44	NM1244	14-1/2	3.667	3.833	B	5/8	1-3/8	2-1/2	5/8	0.41
45	NM1245	14-1/2	3.75	3.917	B	5/8	1-3/8	2-1/2	3/4	0.45
46	NM1246	14-1/2	3.833	4	B	5/8	1-3/8	2-1/2	3/4	0.46
48	NM1248	14-1/2	4	4.167	B	5/8	1-3/8	2-1/2	3/4	0.49
51	NM1251	14-1/2	4.25	4.417	B	5/8	1-3/8	2-1/2	3/4	0.54
52	NM1252	14-1/2	4.333	4.5	B	5/8	1-3/8	2-1/2	3/4	0.56
54	NM1254	14-1/2	4.5	4.667	B	3/4	1-5/8	2-3/4	3/4	0.61
55	NM1255	14-1/2	4.583	4.75	B	3/4	1-5/8	2-3/4	3/4	0.63
56	NM1256	14-1/2	4.667	4.833	B	3/4	1-5/8	2-3/4	3/4	0.65
57	NM1257	14-1/2	4.75	4.917	B	3/4	1-5/8	2-3/4	3/4	0.67
60	NM1260	14-1/2	5	5.167	B	3/4	1-5/8	2-3/4	3/4	0.72
63	NM1263	14-1/2	5.25	5.417	B	3/4	1-5/8	2-3/4	3/4	0.78
64	NM1264	14-1/2	5.333	5.5	B	3/4	1-5/8	2-3/4	3/4	0.8
65	NM1265	14-1/2	5.417	5.583	B	3/4	1-5/8	2-3/4	3/4	0.82
66	NM1266	14-1/2	5.5	5.667	B	3/4	1-5/8	2-3/4	3/4	0.84
68	NM1268	14-1/2	5.667	5.833	B	3/4	1-5/8	2-3/4	3/4	0.89
69	NM1269	14-1/2	5.75	5.917	B	3/4	1-5/8	2-3/4	3/4	0.91
70	NM1270	14-1/2	5.833	6	B	3/4	1-5/8	2-3/4	3/4	0.93
72	NM1272	14-1/2	6	6.167	B	3/4	1-5/8	2-3/4	3/4	0.97
75	NM1275	14-1/2	6.25	6.417	B	3/4	1-3/4	3	3/4	1.08
76	NM1276	14-1/2	6.333	6.5	B	3/4	1-3/4	3	3/4	1.1
77	NM1277	14-1/2	6.417	6.583	B	3/4	1-3/4	3	3/4	1.13
78	NM1278	14-1/2	6.5	6.667	B	3/4	1-3/4	3	3/4	1.15
84	NM1284	14-1/2	7	7.167	B	3/4	1-3/4	3	3/4	1.31
90	NM1290	14-1/2	7.5	7.667	B	3/4	1-3/4	3	3/4	1.47
96	NM1296	14-1/2	8	8.167	B	3/4	1-3/4	3	3/4	1.65
102	NM12102	14-1/2	8.5	8.667	B	3/4	1-3/4	3	3/4	1.84
108	NM12108	14-1/2	9	9.167	B	3/4	1-3/4	3	3/4	2.04
112	NM12112	14-1/2	9.333	9.5	B	3/4	1-3/4	3	3/4	2.18
114	NM12114	14-1/2	9.5	9.667	B	3/4	1-3/4	3	3/4	2.25
120	NM12120	14-1/2	10	10.167	B	3/4	1-3/4	3	3/4	2.48

* Recommended Maximum Bore With Keyway and Setscrew.
† Enlarged Pitch Diameter with Special Tooth Form.

14½° P.A. Gears Will Not Operate With 20° P.A.



Nylon Stock Spur Gears

14½° Pressure Angle

16 DP

1/2" Face

Natural Oil-Filled Nylon Spur Gears

No. Teeth	Catalog Number	Pressure Angle (Deg.)	Diameter		Type	Bore (Inches)		Hub (Inches)		Weight Lbs. (Approx.)
			Pitch	Outside		Stock	Max.*	Diameter	Proj.	
11	NM1611	14-1/2	0.75	0.875	B	3/8	3/8	9/16	7/16	0.01
12	NM1612	14-1/2	0.75	0.875	B	3/8	3/8	9/16	7/16	0.01
13	NM1613	14-1/2	0.813	0.938	B	3/8	3/8	5/8	7/16	0.01
14	NM1614	14-1/2	0.875	1	B	3/8	3/8	11/16	7/16	0.01
15	NM1615	14-1/2	0.938	1.063	B	3/8	7/16	3/4	7/16	0.02
16	NM1616	14-1/2	1	1.125	B	3/8	7/16	13/16	7/16	0.02
17	NM1617	14-1/2	1.063	1.188	B	3/8	7/16	7/8	7/16	0.02
18	NM1618	14-1/2	1.125	1.25	B	3/8	7/16	15/16	7/16	0.03
19	NM1619	14-1/2	1.188	1.313	B	3/8	7/16	1	7/16	0.03
20	NM1920	14-1/2	1.25	1.375	B	1/2	1/2	1-1/16	7/16	0.03
21	NM1621	14-1/2	1.313	1.438	B	1/2	1/2	1-1/8	7/16	0.04
22	NM1622	14-1/2	1.375	1.5	B	1/2	1/2	1-3/16	7/16	0.04
23	NM1623	14-1/2	1.438	1.563	B	1/2	9/16	1-1/4	7/16	0.05
24	NM1624	14-1/2	1.5	1.625	B	1/2	5/8	1-5/16	7/16	0.05
26	NM1626	14-1/2	1.625	1.75	B	1/2	3/4	1-7/16	7/16	0.06
28	NM1628	14-1/2	1.75	1.875	B	1/2	13/16	1-1/2	1/2	0.07
30	NM1630	14-1/2	1.875	2	B	1/2	13/16	1-5/8	1/2	0.09
32	NM1632	14-1/2	2	2.125	B	1/2	7/8	1-3/4	1/2	0.1
33	NM1633	14-1/2	2.063	2.188	B	1/2	7/8	1-3/4	1/2	0.1
34	NM1634	14-1/2	2.125	2.25	B	1/2	1	1-7/8	1/2	0.12
36	NM1636	14-1/2	2.25	2.375	B	1/2	1-1/8	2	1/2	0.13
38	NM1638	14-1/2	2.375	2.5	B	1/2	1-1/8	2	1/2	0.14
39	NM1639	14-1/2	2.438	2.563	B	1/2	1-1/8	2	1/2	0.14
40	NM1640	14-1/2	2.5	2.625	B	1/2	1-1/8	2	1/2	0.15
42	NM1642	14-1/2	2.625	2.75	B	1/2	1-1/8	2	1/2	0.16
44	NM1644	14-1/2	2.75	2.875	B	1/2	1-1/8	2	1/2	0.17
45	NM1645	14-1/2	2.813	2.938	B	1/2	1-1/8	2	1/2	0.17
46	NM1646	14-1/2	2.875	3	B	1/2	1-1/8	2	1/2	0.18
48	NM1648	14-1/2	3	3.125	B	1/2	1-1/8	2	1/2	0.19
51	NM1651	14-1/2	3.188	3.313	B	1/2	1-1/8	2	1/2	0.21
52	NM1652	14-1/2	3.25	3.375	B	1/2	1-1/8	2	1/2	0.22
54	NM1654	14-1/2	3.375	3.5	B	1/2	1-1/8	2	1/2	0.23
55	NM1655	14-1/2	3.438	3.563	B	1/2	1-1/8	2	1/2	0.23
56	NM1656	14-1/2	3.5	3.625	B	1/2	1-1/8	2	1/2	0.24
57	NM1657	14-1/2	3.563	3.688	B	1/2	1-1/8	2	1/2	0.25
60	NM1660	14-1/2	3.75	3.875	B	1/2	1-1/8	2	1/2	0.27
63	NM1663	14-1/2	3.938	4.063	B	1/2	1-1/8	2	5/8	0.31
64	NM1664	14-1/2	4	4.125	B	5/8	1-1/8	2	5/8	0.31
65	NM1665	14-1/2	4.063	4.188	B	5/8	1-1/8	2	5/8	0.32
66	NM1666	14-1/2	4.125	4.25	B	5/8	1-1/8	2	5/8	0.32
68	NM1668	14-1/2	4.25	4.375	B	5/8	1-1/4	2-1/4	5/8	0.36
69	NM1669	14-1/2	4.313	4.438	B	5/8	1-1/4	2-1/4	5/8	0.37
70	NM1670	14-1/2	4.375	4.5	B	5/8	1-1/4	2-1/4	5/8	0.38
72	NM1672	14-1/2	4.5	4.625	B	5/8	1-1/4	2-1/4	5/8	0.39
75	NM1675	14-1/2	4.688	4.813	B	5/8	1-1/4	2-1/4	5/8	0.42
76	NM1676	14-1/2	4.75	4.875	B	5/8	1-1/4	2-1/4	5/8	0.43
77	NM1677	14-1/2	4.813	4.938	B	5/8	1-1/4	2-1/4	5/8	0.44
78	NM1678	14-1/2	4.875	5	B	5/8	1-1/4	2-1/4	5/8	0.45
80	NM1680	14-1/2	5	5.125	B	5/8	1-1/4	2-1/4	5/8	0.47
84	NM1684	14-1/2	5.25	5.375	B	5/8	1-1/4	2-1/4	5/8	0.51
88	NM1688	14-1/2	5.5	5.625	B	5/8	1-1/4	2-1/4	5/8	0.55
96	NM1696	14-1/2	6	6.125	B	5/8	1-1/4	2-1/4	5/8	0.63
104	NM16104	14-1/2	6.5	6.625	B	5/8	1-1/4	2-1/4	5/8	0.73
112	NM16112	14-1/2	7	7.125	B	5/8	1-3/8	2-1/2	5/8	0.86
120	NM16120	14-1/2	7.5	7.625	B	5/8	1-3/8	2-1/2	5/8	0.97
128	NM16128	14-1/2	8	8.125	B	5/8	1-3/8	2-1/2	5/8	1.09

* Recommended Maximum Bore With Keyway and Setscrew.
† Enlarged Pitch Diameter with Special Tooth Form.

14½° P.A. Gears Will Not Operate With 20° P.A.

20 DP

3/8" Face

Nylon Stock Spur Gears

14½° Pressure Angle



Natural Oil-Filled Nylon Spur Gears

No. Teeth	Catalog Number	Pressure Angle (Deg.)	Diameter		Type	Bore (Inches)		Hub (Inches)		Weight Lbs. (Approx.)
			Pitch	Outside		Stock	Max.*	Diameter	Proj.	
11	NM2011	14-1/2	0.6	0.7	B	5/16	5/16	15/32	3/8	0.01
12	NM2012	14-1/2	0.6	0.7	B	5/16	5/16	15/32	3/8	0.01
13	NM2013	14-1/2	0.65	0.75	B	5/16	5/16	1/2	3/8	0.01
14	NM2014	14-1/2	0.7	0.8	B	5/16	5/16	35/64	3/8	0.01
15	NM2015	14-1/2	0.75	0.85	B	3/8	3/8	39/64	3/8	0.01
16	NM2016	14-1/2	0.8	0.9	B	3/8	3/8	21/32	3/8	0.01
17	NM2017	14-1/2	0.85	0.95	B	3/8	3/8	45/64	3/8	0.01
18	NM2018	14-1/2	0.9	1	B	3/8	3/8	3/4	3/8	0.01
19	NM2019	14-1/2	0.95	1.05	B	3/8	3/8	51/64	3/8	0.01
20	NM2020	14-1/2	1	1.1	B	3/8	3/8	55/64	3/8	0.02
21	NM2021	14-1/2	1.05	1.15	B	3/8	3/8	7/8	3/8	0.02
22	NM2022	14-1/2	1.1	1.2	B	3/8	3/8	31/32	3/8	0.02
23	NM2023	14-1/2	1.15	1.25	B	3/8	3/8	31/32	3/8	0.02
24	NM2024	14-1/2	1.2	1.3	B	3/8	1/2	1-1/16	3/8	0.03
26	NM2026	14-1/2	1.3	1.4	B	3/8	9/16	1-3/16	3/8	0.03
28	NM2028	14-1/2	1.4	1.5	B	3/8	9/16	1-17/64	3/8	0.04
30	NM2030	14-1/2	1.5	1.6	B	3/8	5/8	1-23/64	3/8	0.04
32	NM2032	14-1/2	1.6	1.7	B	3/8	3/4	1-7/16	1/2	0.06
33	NM2033	14-1/2	1.65	1.75	B	3/8	3/4	1-7/16	1/2	0.06
34	NM2034	14-1/2	1.7	1.8	B	3/8	13/16	1-1/2	1/2	0.06
36	NM2036	14-1/2	1.8	1.9	B	3/8	13/16	1-5/8	1/2	0.07
38	NM2038	14-1/2	1.9	2	B	3/8	7/8	1-3/4	1/2	0.08
39	NM2039	14-1/2	1.95	2.05	B	3/8	7/8	1-3/4	1/2	0.09
40	NM2040	14-1/2	2	2.1	B	3/8	7/8	1-13/16	1/2	0.09
42	NM2042	14-1/2	2.1	2.2	B	3/8	1	1-7/8	1/2	0.1
44	NM2044	14-1/2	2.2	2.3	B	3/8	1	1-7/8	1/2	0.11
45	NM2045	14-1/2	2.25	2.35	B	3/8	1-1/8	2	1/2	0.12
46	NM2046	14-1/2	2.3	2.4	B	3/8	1-1/8	2	1/2	0.12
48	NM2048	14-1/2	2.4	2.5	B	3/8	1-1/8	2	1/2	0.12
51	NM2051	14-1/2	2.55	2.65	B	3/8	1-1/8	2	1/2	0.13
52	NM2052	14-1/2	2.6	2.7	B	3/8	1-1/8	2	1/2	0.14
54	NM2054	14-1/2	2.7	2.8	B	3/8	1-1/8	2	1/2	0.14
55	NM2055	14-1/2	2.75	2.85	B	3/8	1-1/8	2	1/2	0.14
56	NM2056	14-1/2	2.8	2.9	B	3/8	1-1/8	2	1/2	0.15
57	NM2057	14-1/2	2.85	2.95	B	3/8	1-1/8	2	1/2	0.15
60	NM2060	14-1/2	3	3.1	B	3/8	1-1/8	2	1/2	0.16
63	NM2063	14-1/2	3.15	3.25	B	3/8	1-1/8	2	1/2	0.17
64	NM2064	14-1/2	3.2	3.3	B	3/8	1-1/8	2	1/2	0.18
65	NM2065	14-1/2	3.25	3.35	B	3/8	1-1/8	2	1/2	0.18
66	NM2066	14-1/2	3.3	3.4	B	3/8	1-1/8	2	1/2	0.18
68	NM2068	14-1/2	3.4	3.5	B	3/8	1-1/8	2	1/2	0.19
69	NM2069	14-1/2	3.45	3.55	B	3/8	1-1/8	2	1/2	0.19
70	NM2070	14-1/2	3.5	3.6	B	3/8	1-1/8	2	1/2	0.2
72	NM2072	14-1/2	3.6	3.7	B	3/8	1-1/4	2-1/4	1/2	0.22
75	NM2075	14-1/2	3.75	3.85	B	3/8	1-1/4	2-1/4	1/2	0.24
76	NM2076	14-1/2	3.8	3.9	B	3/8	1-1/4	2-1/4	1/2	0.24
77	NM2077	14-1/2	3.85	3.95	B	3/8	1-1/4	2-1/4	1/2	0.24
78	NM2078	14-1/2	3.9	4	B	3/8	1-1/4	2-1/4	1/2	0.25
80	NM2080	14-1/2	4	4.1	B	1/2	1-1/4	2-1/4	1/2	0.25
84	NM2084	14-1/2	4.2	4.3	B	1/2	1-1/4	2-1/4	1/2	0.27
90	NM2090	14-1/2	4.5	4.6	B	1/2	1-1/4	2-1/4	1/2	0.3
96	NM2096	14-1/2	4.8	4.9	B	1/2	1-1/4	2-1/4	1/2	0.34
100	NM20100	14-1/2	5	5.1	B	1/2	1-1/4	2-1/4	1/2	0.36
112	NM20112	14-1/2	5.6	5.7	B	1/2	1-3/8	2-1/2	1/2	0.45
120	NM20120	14-1/2	6	6.1	B	1/2	1-3/8	2-1/2	1/2	0.5
132	NM20132	14-1/2	6.6	6.7	B	1/2	1-3/8	2-1/2	1/2	0.59

* Recommended Maximum Bore With Keyway and Setscrew.

† Enlarged Pitch Diameter with Special Tooth Form.

14½° P.A. Gears Will Not Operate With 20° P.A.

14-1/2° Gear Rack

Catalog Number	Pitch	Face Width (Inches)	Overall Thickness (Inches)	Pitch Line Backing	Weight Lbs./Pc (Approx.)
NMR3X4	3	3	1-1/2	1.167	6.55
NMR4X4	4	2	1-1/2	1.25	4.68
NMRA4X4	4	2	2	1.75	6.55
NMR5X4	5	1-3/4	1-1/4	1.05	3.44
NMRA5X4	5	1-3/4	1-1/2	1.3	4.26
NMR6X4	6	1-1/2	1	0.833	2.34
NMRA6X4	6	1-1/2	1-1/2	1.33	3.74
NMR8X4	8	1-1/4	3/4	0.625	1.46
NMRA8X4	8	1-1/4	1-1/4	1.125	2.63
NMR10X4	10	1	5/8	0.525	0.98
NMRA10X4	10	1	1	0.9	1.68
NMR12X4	12	3/4	1/2	0.417	0.59
NMRA12X4	12	3/4	3/4	0.667	0.94
NMRA16X4	16	1/2	1/2	0.438	0.41
NMRA20X4	20	3/8	3/8	0.325	0.23

- Standard Material: Natural Oil-Filled Nylon
- Other dimensions available
- Supplied as nominal 48" lengths. Matched ends available upon request



20° Gear Rack

Catalog Number	Pitch	Face Width (Inches)	Overall Thickness (Inches)	Pitch Line Backing	Weight Lbs./Pc (Approx.)
TNMR3X4	3	3	1-1/2	1.167	6.55
TNMR4X4	4	2	1-1/2	1.25	4.68
TNMRA4X4	4	2	2	1.75	6.55
TNMR5X4	5	1-3/4	1-1/4	1.05	3.44
TNMRA5X4	5	1-3/4	1-1/2	1.3	4.26
TNMR6X4	6	1-1/2	1	0.833	2.34
TNMRA6X4	6	1-1/2	1-1/2	1.333	3.74
TNMR8X4	8	1-1/4	3/4	0.625	1.46
TNMRA8X4	8	1-1/4	1-1/4	1.125	2.63
TNMR10X4	10	1	5/8	0.525	0.98
TNMRA10X4	10	1	1	0.9	1.68
TNMR12X4	12	3/4	1/2	0.417	0.59
TNMRA12X4	12	3/4	3/4	0.667	0.94
TNMRA16X4	16	1/2	1/2	0.438	0.41
TNMRA20X4	20	3/8	3/8	0.325	0.23

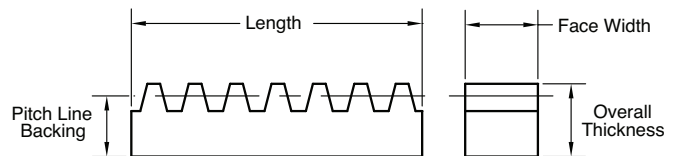

Waste Water Treatment Components

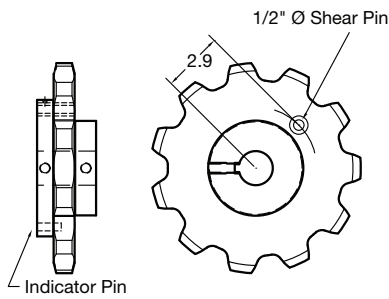

78 Series Shear Pin Sprocket

- Nylon Body & Nylon Sprocket
- Includes Trip Indicator

Number of Teeth	Catalog Number	Pitch Diameter	Stock Bore	Max. Bore	Hub Diameter	L.T.B.	Weight Lbs. (Approx.)
10	SPTA7810NM	8.44	1	2	4.50	2.8	4
11	SPTA7811NM	9.26	1	2	4.50	2.8	4.4
12	SPTA7812NM	10.08	1	2	4.50	2.8	4.8
13	SPTA7813NM	10.9	1	2	4.50	2.8	5.4

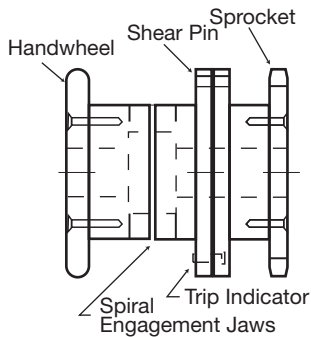

- Nylon Body & UHMW Sprocket
- Includes Trip Indicator

78 Series Jaw Clutch Sprocket

Number of Teeth	Catalog Number	Pitch Diameter	Stock Bore	Max. Bore	Hub Diameter	L.T.B.	Weight Lbs. (Approx.)
11	78JC11NM-*	9.26	1	2 1/2	-	9.5	17.6
12	78JC12NM-*	10.08	1	2 1/2	-	9.5	18.1
13	78JC13NM-*	10.9	1	2 1/2	-	9.5	18.6

- UHMW sprocket plates & hubs
- 304 Stainless Steel hardware as standard
- 316 Stainless Steel hardware optional
- Standard Rim and Chain-saver rim available
- Other Numbers of Teeth Available

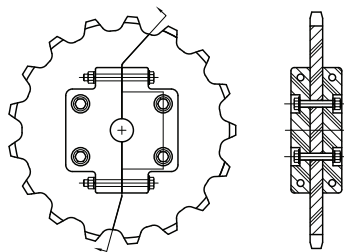

720 Series Split Sprocket

6.0" Pitch, 1" Nominal Plate Width
4" Length Thru Bore, C-Hub

Number of Teeth	Catalog Number	Pitch Diameter	Stock Bore	Max. Bore	Hub Diameter	Outside Diameter	Weight Lbs. (Approx.)
11	720C11NMS	11.1	1	3 1/4	-	10.9	7.85
13	720C13NMS	12.89	1	3 1/4	-	13.39	9.16
17	720C17NMS	16.59	1 3/4	3 15/16	-	17.09	12.55
19	720C19NMS	18.45	1 3/4	3 15/16	-	18.95	14.65
21	720C21NMS	20.33	1 3/4	3 15/16	-	20.83	16.95
23	720C23NMS	22.21	1 3/4	3 15/16	-	22.71	19.45
25	720C25NMS	24.1	1 3/4	4 1/2	-	24.6	22.15

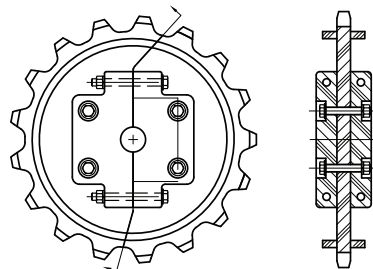

Chainsaver Rim 720CS Sprocket

6.0" Pitch, 1" Nominal Plate Width
4" Length Thru Bore, C-Hub

Number of Teeth	Catalog Number	Pitch Diameter	Stock Bore	Max. Bore	Hub Diameter	Outside Diameter	Weight Lbs. (Approx.)
11	720CS11NM	11.1	1	3-1/4	-	10.9	9.25
13	720CS13NM	12.89	1	3-1/4	-	13.39	10.75
17	120CS17NM	16.59	1 3/4	3-15/16	-	17.09	14.65
19	720CS19NM	18.45	1 3/4	3-15/16	-	18.95	16.95
21	720CS21NM	20.33	1 3/4	3-15/16	-	20.83	19.55
23	720CS23NM	22.21	1 3/4	3-15/16	-	22.71	22.25
25	720CS25NM	24.1	1 3/4	4-1/2	-	24.6	25.15

PLASTICS

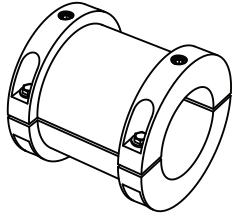

Static Shaft Bushings

These static shaft bushings protect expensive shafts from damage caused by idler sprockets. Manufactured from green oil-filled nylon with stainless steel hardware. They are as durable as stainless steel counterparts at a fraction of the cost. They are chemical, corrosion, moisture and abrasive resistant. Custom sizes and materials available.

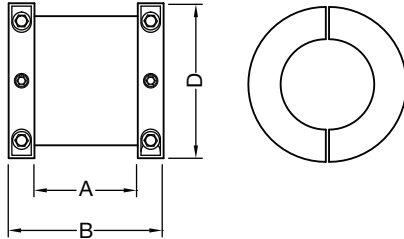

Catalog Number	Req. Sprocket Bore (Inches)	Max. Shaft Size (Inches)	A (Inches)	B (Inches)	D (Inches)	Weight Lbs. (Approx.)
WTB4700	3-3/4 Idler	2-15/16	4	6	4-1/2	2.3
WTB6400	5 Idler	4	4	6	6	3.6
WTB7200	5-1/4 Idler	4-1/2	4	6	6-1/4	2.4
WTB8400	6 Idler	5-1/4	4	6	7	2.8

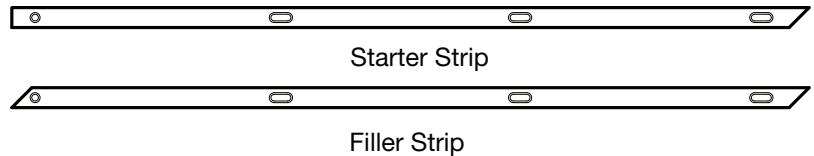

Wear Strips

These wear strips are easy to install and provide superior protection for rails and other moving machinery. Strips include slots for weld washer installations. We can easily accommodate any special spacing or size requirement for the strips and slots.

Filler Wear Strips					Starter Wear Strips				
Catalog Number	Thickness (Inches)	Width (Inches)	Length (Inches)	Weight Lbs. (Approx.)	Catalog Number	Thickness (Inches)	Width (Inches)	Length (Inches)	Weight Lbs. (Approx.)
WTF1000	3/8	2-5/8	120	4.1	WTS1100	3/8	2-5/8	120	4.1
WTF1002	3/8	3	120	4.7	WTS1102	3/8	3	120	4.7
WTF1003	1/2	2-1/2	120	5.2	WTS1103	1/2	2-1/2	120	5.2
WTF1004	1/2	3	120	6.3	WTS1104	1/2	3	120	6.3

Waste Water Treatment Components

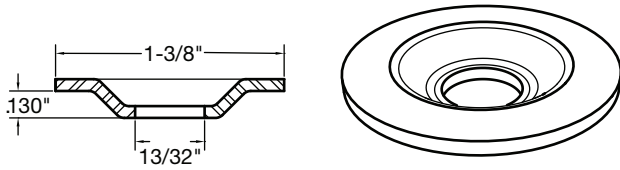

Weld Washers

Used to fasten wear strips to rails and tank floors.

Catalog Number	Material	Diameter (Inches)	Weight Lbs. (Approx.)
WTWW1375	Stainless Steel	1-3/8	.03

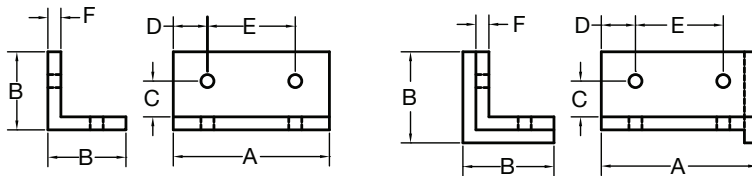

Carrying wear shoes

Double Hole Return wear shoes

Wear Shoes

Wear Shoes may be manufactured to fit your particular application. For custom wear shoes, please provide your *Martin* representative with specifications.

Carrying wear shoes								Double Hole Return wear shoes							
Catalog Number	A (Inches)	B (Inches)	C (Inches)	D (Inches)	E (Inches)	F (Inches)	Wt. Lbs. (Approx.)	Catalog Number	A (Inches)	B (Inches)	C (Inches)	D (Inches)	E (Inches)	F (Inches)	Wt. Lbs. (Approx.)
WTWS1001	5-1/2	3	1-5/16	7/8	3-3/4	1/2	.53	WTWS3400	4	3-1/2	1 3/8	7/8	2	1/2	.44
WTWS1550	5-1/2	3	1-3/8	7/8	3-3/4	1/2	.53	WTWS3450	4-1/2	3-1/2	1 3/8	7/8	1	1/2	.48
WTWS1600	6	3	1-3/8	1-1/8	3-3/4	1/2	.58	WTWS3600	6	3-1/2	1 3/8	1 1/8	3 3/4	1/2	.63



GENERAL ENGINEERING INFORMATION

WARNING & SAFETY REMINDER OPPOSITE PAGE

ITEM	PAGE
HORSEPOWER/TORQUE	M-2 — M-6
ELECTRICAL	M-7
ELECTRICAL MOTORS	M-8
SHAFT SELECTION	M-9 — M-11
FLYWHEEL	M-12
WEIGHTS OF STEEL	M-13
PROPERTIES OF STEEL	M-14
PROPERTIES OF VARIOUS METALS	M-15
HARDNESS CONVERSION CHART	M-16
DECIMAL EQUIVALENT CHART	M-17
ENGLISH/METRIC CONVERSIONS	M-18 — M-19
ENGINEERING FORMULAS & CONSTANTS	M-20
CIRCUMFERENCES/AREAS OF CIRCLES	M-21
TRIGONOMETRIC FORMULAS/FUNCTIONS	M-22 — M-24
CONVERSION TABLES	M-25 — M-28

Horsepower/Torque



Horsepower

One HP is the rate of work required to raise 33,000 pounds one foot in one minute.

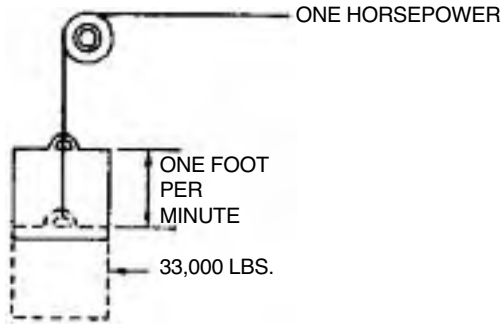

$$HP = \frac{\text{Force} \times \text{FPM}}{33,000}$$

$$HP = \frac{\text{Torque (in Pound-Inches)} \times \text{RPM}}{63,025}$$

$$HP = \frac{\text{Torque (in Pound-Feet)} \times \text{RPM}}{5,252}$$

Torque: The twisting or turning effort around a shaft tending to cause rotation. Torque is determined by multiplying the applied force times the distance from the point where force is applied to the shaft center.

$$TQ = F (\text{force}) \times R (\text{radius})$$

$$\text{Torque (in Pound-Inches)} = \frac{63,025 \times \text{HP}}{\text{RPM}}$$

$$= \text{Force} \times \text{Lever Arm (in Inches)}$$

$$\text{Torque (in Pound-Feet)} = \frac{5,252 \times \text{HP}}{\text{RPM}}$$

$$= \text{Force} \times \text{Lever Arm (in Feet)}$$

Torque Calculation Example

20 HP at 100 RPM = 12,605 Pound-Inches Torque

2.0 HP at 10 RPM = 12,605 Pound-Inches Torque

Force = Working Loads in Pounds

FPM = Feet per Minute

RPM = Revolutions per Minute

Lever Arm = Distance from the Force to the center of rotation on Inches or Feet

Overhung Loads

An overhung load is a bending force imposed on a shaft due to the torque transmitted by V-drives, chain drives, and other power transmission devices, other than flexible couplings.

Most motor and reducer manufacturers list the maximum values allowable for overhung loads. It is desirable that these figures be compared with the load actually imposed by the connected drive.

Overhung loads may be calculated as follows:

$$\text{O.H.L.} = \frac{63,000 \times \text{HP} \times \text{F}}{\text{N} \times \text{R}}$$

Where: HP = Transmitted HP x Service Factor

N = RPM of shaft

R = Radius of sprocket, pulley, etc.

F = Factor

Weights of the drive components are usually negligible. The formula is based on the assumption that the load is applied at a point equal to one shaft diameter from the bearing face. Factor F depends on the type of drive used:

- 1.00 for single chain drives
- 1.10 for TIMING belt drives
- F = 1.25 for spur or helical gear or double chain drives
- 1.50 for V-belt drives
- 2.50 for flat belt drives

Example: Find the overhung load imposed on a reducer by a double chain drive transmitting 7 HP @ 30 RPM. The pitch diameter of the sprocket is 10"; service factor is 1.3.

Solution:

$$\text{O.H.L.} = \frac{(63,000)(7 \times 1.3)}{(30)} \frac{(1.25)}{(5)} = 4,780 \text{ lbs.}$$

Horsepower/Speed/Torque Relationships

HP	Speed (RPM)	Torque
Constant	Increases	Decreases
Constant	Decreases	Increases
Increases	Constant	Increases
Decreases	Constant	Decreases
Increases	Increases	Constant
Decreases	Decreases	Constant



Torque (in Pound-Inches) For Horsepower/RPM

Torque for 1-50 HP @ 50-220 RPM

HP	Revolutions per Minute																	
	50	60	70	80	90	100	110	120	130	140	150	160	170	180	190	200	210	220
1	1261	1050	900	788	700	630	573	525	485	450	420	394	371	350	332	315	300	286
2	2521	2101	1801	1576	1401	1260	1145	1050	969	900	840	787	741	700	663	630	600	572
3	3782	3151	2701	2363	2101	1890	1718	1575	1454	1350	1260	1181	1112	1050	995	945	900	859
4	5042	4202	3601	3151	2801	2521	2291	2100	1939	1800	1680	1575	1482	1400	1326	1260	1200	1145
5	6303	5252	4502	3939	3501	3151	2864	2626	2424	2250	2100	1969	1853	1750	1658	1575	1500	1432
6	7563	6303	5402	4727	4202	3781	3437	3151	2908	2701	2521	2363	2224	2100	1990	1890	1800	1718
7	8824	7353	6302	5515	4902	4411	4010	3676	3393	3151	2941	2757	2595	2450	2321	2205	2100	2005
8	10084	8403	7203	6303	5602	5042	4583	4201	3878	3601	3361	3151	2965	2801	2653	2521	2400	2291
9	11345	9454	8103	7090	6303	5672	5156	4726	4363	4051	3781	3545	3336	3151	2985	2836	2701	2578
10	12605	10504	9004	7878	7003	6302	5729	5252	4848	4501	4201	3939	3707	3501	3317	3151	3001	2864
11	13866	11555	9904	8666	7703	6932	6302	5777	5332	4951	4621	4332	4078	3851	3648	3466	3301	3151
12	15126	12605	10804	9454	8403	7563	6875	6302	5817	5402	5042	4726	4448	4201	3980	3781	3601	3437
13	16387	13655	11705	10242	9104	8193	7448	6827	6302	5852	5462	5120	4819	4551	4312	4096	3901	3724
14	17647	14706	12605	11029	9804	8823	8021	7352	6787	6302	5882	5514	5190	4901	4643	4411	4201	4010
15	18908	15756	13505	11817	10504	9453	8594	7878	7272	6752	6302	5908	5561	5252	4975	4726	4501	4297
16	20168	16807	14406	12605	11204	10084	9167	8403	7756	7202	6722	6302	5931	5602	5307	5042	4801	4583
17	21429	17857	15306	13393	11905	10714	9740	8928	8241	7653	7142	6696	6302	5952	5639	5357	5102	4870
18	22689	18908	16206	14181	12605	11344	10313	9453	8726	8103	7563	7090	6673	6302	5970	5672	5402	5156
19	23950	19958	17107	14968	13305	11974	10886	9979	9211	8553	7983	7484	7044	6652	6302	5987	5702	5443
20	25210	21008	18007	15756	14006	12605	11459	10504	9696	9003	8403	7878	7414	7002	6634	6302	6002	5729
21	26471	22059	18907	16544	14706	13235	12032	11029	10181	9453	8823	8272	7785	7352	6965	6617	6302	6016
22	27731	23109	19808	17332	15406	13865	12605	11554	10665	9903	9243	8665	8156	7703	7297	6932	6602	6302
23	28992	24160	20708	18120	16106	14495	13178	12079	11150	10354	9663	9059	8526	8053	7629	7247	6902	6588
24	30252	25210	21609	18908	16807	15126	13750	12605	11635	10804	10084	9453	8897	8403	7961	7563	7202	6875
25	31513	26260	22509	19695	17507	15756	14323	13130	12120	11254	10504	9847	9268	8753	8292	7878	7503	7161
26	32773	27311	23409	20483	18207	16386	14896	13655	12605	11704	10924	10241	9639	9103	8624	8193	7803	7448
27	34034	28361	24310	21271	18908	17016	15469	14180	13089	12154	11344	10635	10009	9453	8956	8508	8103	7734
28	35294	29412	25210	22059	19608	17647	16042	14705	13574	12605	11764	11029	10380	9803	9287	8823	8403	8021
29	36555	30462	26110	22847	20308	18277	16615	15231	14059	13055	12184	11423	10751	10154	9619	9138	8703	8307
30	37815	31513	27011	23634	21008	18907	17188	15756	14544	13505	12605	11817	11122	10504	9951	9453	9003	8594
31	39076	32563	27911	24422	21709	19537	17761	16281	15029	13955	13025	12211	11492	10854	10283	9768	9303	8880
32	40336	33613	28811	25210	22409	20168	18334	16806	15513	14405	13445	12605	11863	11204	10614	10084	9603	9167
33	41597	34664	29712	25998	23109	20798	18907	17331	15998	14855	13865	12998	12234	11554	10946	10399	9903	9453
34	42857	35714	30612	26786	23809	21428	19480	17857	16483	15306	14285	13392	12605	11904	11278	10714	10204	9740
35	44118	36767	31512	27573	24510	22058	20053	18382	16968	15756	14705	13786	12975	12254	11609	11029	10504	10026
36	45378	37815	32413	28361	25210	22689	20626	18907	17453	16206	15126	14180	13346	12605	11941	11344	10804	10313
37	46639	38865	33313	29149	25910	23319	21199	19432	17937	16656	15546	14574	13717	12955	12273	11659	11104	10599
38	47899	39916	34214	29937	26611	23949	21772	19958	18422	17106	15966	14968	14088	13305	12605	11974	11404	10886
39	49160	40966	35114	30725	27311	24579	22345	20483	18907	17557	16386	15362	14458	13655	12936	12289	11704	11172
40	50420	42017	36014	31513	28011	25210	22918	21008	19392	18007	16806	15756	14829	14005	13268	12605	12004	11459
41	51681	43067	36915	32300	28711	25840	23491	21533	19877	18457	17226	16150	15200	14355	13600	12920	12304	11745
42	52941	44118	37815	33088	29412	26470	24064	22058	20362	18907	17647	16544	15570	14705	13931	13235	12605	12032
43	54202	45168	38715	33876	30112	27100	24637	22584	20846	19357	18067	16938	15941	15056	14263	13550	12905	12318
44	55462	46218	39616	34664	30812	27731	25210	23109	21331	19807	18487	17331	16312	15406	14595	13865	13205	12605
45	56723	47269	40516	35452	31513	28361	25783	23634	21816	20258	18907	17725	16683	15756	14927	14180	13505	12891
46	57983	48319	41416	36239	32213	28991	26356	24159	22301	20708	19327	18119	17053	16106	15258	14495	13805	13177
47	59244	49370	42317	37027	32913	29621	26928	24684	22786	21158	19747	18513	17424	16456	15590	14810	14105	13464
48	60504	50420	43217	37815	33613	30252	27501	25210	23270	21608	20168	18907	17795	16806	14922	15126	14405	13750
49	61764	51470	44117	38603	34314	30882	28074	25735	23755	22058	20588	19301	18166	17156	16253	15441	14705	14037
50	63025	52521	45018	39319	35014	31512	28647	26260	24240	22509	21008	19695	18536	17507	16585	15756	15006	14323

Torque (in Pound-Inches) For Horsepower/RPM



Torque for 1-50 HP @ 230-1000 RPM

HP	Revolutions per Minute																		
	230	240	250	260	270	280	290	300	350	400	450	500	550	600	650	700	800	900	1000
1	274	263	252	242	233	225	217	210	180	157	140	126	114	105	96	90	78	70	63
2	548	525	504	484	466	450	434	420	360	315	280	252	229	210	193	180	157	140	126
3	822	787	756	727	700	675	651	630	540	472	420	378	343	315	290	270	236	210	189
4	1096	1050	1008	969	933	900	869	840	720	630	560	504	458	420	387	360	315	280	252
5	1370	1313	1260	1212	1167	1125	1087	1050	900	787	700	630	572	525	484	450	393	350	315
6	1644	1575	1512	1454	1401	1350	1303	1260	1080	945	840	756	687	630	581	540	472	420	378
7	1918	1838	1764	1696	1633	1575	1521	1470	1260	1102	980	882	802	735	678	630	551	490	441
8	2192	2100	2016	1939	1867	1800	1738	1680	1440	1260	1120	1008	916	840	775	720	630	560	504
9	2466	2363	2268	2181	2100	2025	1955	1890	1620	1418	1260	1134	1031	945	872	810	709	630	567
10	2740	2626	2521	2424	2334	2250	2173	2100	1800	1575	1400	1260	1145	1050	969	900	787	700	630
11	3014	2888	2773	2666	2567	2475	2390	2310	1980	1733	1540	1386	1260	1155	1066	990	866	770	693
12	3288	3151	3025	2908	2801	2701	2607	2521	2160	1890	1680	1512	1375	1260	1163	1080	945	840	756
13	3562	3413	3277	3151	3034	2926	2825	2731	2340	2048	1820	1638	1489	1365	1260	1170	1024	910	819
14	3836	3676	3529	3393	3267	3151	3042	2941	2521	2205	1960	1764	1604	1470	1357	1260	1102	980	882
15	4110	3939	3781	3636	3501	3376	3259	3151	2701	2363	2100	1890	1718	1575	1454	1350	1181	1050	945
16	4384	4201	4033	3878	3734	3601	3477	3361	2881	2521	2240	2016	1833	1680	1551	1440	1260	1120	1008
17	4658	4464	4285	4120	3968	3826	3694	3571	3061	2678	2380	2142	1948	1785	1648	1530	1339	1190	1071
18	4932	4726	4537	4363	4201	4051	3911	3781	3241	2836	2521	2268	2062	1890	1745	1620	1418	1260	1134
19	5206	4989	4789	4605	4435	4276	4129	3991	3421	2993	2661	2394	2177	1995	1842	1710	1496	1330	1197
20	5480	5252	5042	4848	4668	4501	4346	4201	3601	3151	2801	2521	2291	2100	1939	1800	1575	1400	1260
21	5754	5514	5294	5090	4901	4726	4563	4411	3781	3308	2941	2647	2406	2205	2036	1890	1654	1470	1323
22	6028	5777	5546	5332	5135	4951	4781	4621	3961	3466	3081	2773	2521	2310	2133	1980	1733	1540	1386
23	6302	6039	5798	5575	5368	5177	4998	4831	4141	3623	3221	2899	2635	2415	2230	2070	1811	1610	1449
24	6576	6302	6050	5817	5602	5402	5215	5042	4321	3781	3361	3025	2750	2521	2327	2160	1890	1680	1512
25	6850	6565	6302	6060	5835	5627	5433	5252	4501	3939	3501	3151	2864	2626	2424	2250	1969	1750	1575
26	7124	6827	6554	6302	6069	5852	5650	5462	4681	4096	3641	3277	2979	2731	2521	2340	2048	1820	1638
27	7398	7090	6806	6544	6302	6077	5867	5672	4861	4254	3781	3403	3093	2836	2617	2430	2127	1890	1701
28	7672	7352	7058	6787	6535	6302	6085	5882	5042	4411	3921	3529	3208	2941	2714	2521	2205	1960	1764
29	7946	7615	7310	7029	6769	6527	6302	6092	5222	4569	4061	3655	3323	3046	2811	2611	2284	2030	1827
30	8220	7878	7563	7272	7002	6752	6519	6302	5402	4726	4201	3781	3437	3151	2908	2701	2363	2100	1890
31	8494	8140	7815	7514	7236	6977	6737	6512	5582	4884	4341	3907	3552	3256	3005	2791	2442	2170	1953
32	8768	8403	8067	7756	7469	7202	6954	6722	5762	5042	4481	4033	3666	3361	3102	2881	2520	2240	2016
33	9042	8665	8319	7999	7703	7427	7171	6932	5942	5199	4621	4159	3781	3466	3199	2971	2599	2310	2079
34	9316	8928	8571	8241	7936	7653	7389	7142	6122	5357	4761	4285	3896	3571	3296	3061	2678	2380	2142
35	9590	9191	8823	8484	8169	7878	7606	7352	6302	5514	4901	4411	4010	3676	3393	3151	2757	2450	2205
36	9864	9453	9075	8726	8403	8103	7823	7563	6482	5672	5042	4537	4125	3781	3490	3241	2836	2521	2268
37	10138	9716	9327	8968	8636	8328	8041	7773	6662	5829	5182	4663	4239	3886	3587	3331	2913	2591	2331
38	10412	9978	9579	9211	8870	8553	8258	7983	6842	5987	5322	4789	4354	3991	3684	3421	2993	2661	2394
39	10686	10241	9831	9453	9103	8778	8475	8193	7022	6144	5462	4915	4469	4096	3781	3511	3072	2731	2457
40	10960	10504	10084	9696	9337	9003	8693	8403	7202	6302	5602	5042	4583	4201	3878	3601	3151	2801	2521
41	11234	10766	10336	9938	9570	9228	8910	8613	7382	6460	5742	5168	4698	4306	3975	3691	3230	2871	2584
42	11508	11029	10588	10181	9803	9453	9127	8823	7563	6617	5882	5294	4812	4411	4072	3781	3308	2941	2647
43	11782	11292	10840	10423	10037	9678	9345	9033	7743	6775	6022	5420	4927	4516	4169	3871	3387	3011	2710
44	12057	11554	11092	10665	10270	9903	9562	9243	7923	6932	6162	5546	5042	4621	4266	3961	3466	3081	2773
45	12331	11817	11344	10908	10504	10129	9779	9453	8103	7090	6302	5672	5156	4726	4363	4051	3545	3151	2836
46	12605	12079	11596	11150	10737	10354	9997	9663	8283	7247	6442	5798	5271	4831	4460	4141	3623	3221	2899
47	12879	12342	11848	11393	10971	10579	10214	9873	8463	7405	6582	5924	5385	4936	4557	4231	3702	3291	2962
48	13153	12605	12100	11635	11204	10804	10431	10084	8643	7563	6722	6050	5500	5042	4654	4321	3781	3361	3025
49	13427	12867	12352	11877	11437	11029	10649	10294	8823	7720	6862	6176	5614	5147	4751	4411	3860	3431	3088
50	13701	13130	12605	12120	11671	11254	10866	10504	9003	7878	7002	6302	5729	5252	4848	4501	3939	3501	3151



Torque (in Pound-Inches) For Horsepower/RPM

Torque for 51-100 HP @ 50-220 RPM

HP	Revolutions per Minute																	
	50	60	70	80	90	100	110	120	130	140	150	160	170	180	190	200	210	220
51	64286	53571	45918	40178	35714	32142	29220	26785	24725	22959	21428	20089	18907	17857	16917	16071	15306	14610
52	65546	54622	46819	40966	36414	32773	29793	27310	25210	23409	21848	20483	19278	18207	17249	16386	15606	14896
53	66807	55672	47719	41754	37115	33403	30366	27836	25694	23859	22268	20877	19649	18557	17580	16701	15906	15183
54	68067	56723	48619	42542	37815	34033	30939	28361	26179	24309	22689	21271	20019	18907	17912	17016	16206	15469
55	69328	57773	49520	43330	38515	34663	31512	28886	26664	24760	23109	21664	20390	19257	18244	17331	16506	15756
56	70588	58823	50420	44118	39216	35294	32085	29411	27149	25210	23529	22058	20761	19607	18575	17647	16806	16042
57	71849	59874	51320	44905	39916	35924	32658	29937	27634	25660	23950	22452	21132	19957	18907	17962	17106	16329
58	73109	60924	52221	45693	40616	36554	33231	30462	28118	26110	24370	22846	21502	20308	19239	18277	17406	16615
59	74370	61975	53121	46481	41316	37184	33804	30987	28603	26560	24790	23240	21873	20658	19571	18592	17707	16902
60	75630	63025	54021	47269	42017	37815	34377	31512	29088	27010	25210	23634	22244	21008	19902	18907	18007	17188
61	76891	64075	54922	48057	42717	38445	34950	32037	29573	27461	25630	24028	22614	21358	20234	19222	18307	17475
62	78151	65126	55822	48844	43417	39075	35523	32563	30058	27911	26050	24422	22985	21708	20566	19537	18607	17761
63	79412	66176	56722	49632	44118	39705	36096	33088	30543	28361	26470	24816	23356	22058	20897	19852	18907	18048
64	80672	67227	57623	50420	44818	40336	36669	33613	31027	28811	26890	25210	23727	22408	21229	20168	19207	18334
65	81933	68277	58523	51208	45518	40966	37242	34138	31512	29261	27310	25604	24097	22759	21561	20483	19507	18621
66	83193	69328	59423	51996	46218	41596	37815	34663	31997	29711	27731	25997	24468	23109	21892	20798	19807	18907
67	84454	70378	60324	52783	46919	42226	38388	35189	32482	30162	28151	26391	24839	23459	22224	21113	20108	19194
68	85714	71428	61224	53571	47619	42857	38961	35714	32967	30612	28571	26785	25210	23809	22556	21428	20408	19480
69	86975	72479	62125	54359	48319	43487	39534	36239	33451	31062	28991	27179	25580	24159	22888	21743	20708	19766
70	88235	73529	63025	55147	49019	44117	40106	36764	33936	31512	29411	27573	25951	24509	23219	22058	21008	20053
71	89496	74580	63925	55935	49720	44747	40679	37289	34421	31962	29831	27967	26322	24859	23551	22373	21308	20339
72	90756	75630	64826	56723	50420	45378	41252	37815	34906	32413	30252	28361	26693	25210	23883	22689	21608	20626
73	92017	76680	65726	57510	51120	46008	41825	38340	35391	32863	30672	28755	27063	25560	24214	23004	21908	20912
74	93277	77731	66626	58298	51821	46638	42398	38865	35875	33313	31092	29149	27434	25910	24546	23319	22208	21199
75	94538	78781	67527	59086	52521	47268	42971	39390	36360	33763	31512	29543	27805	26260	24878	23634	22509	21485
76	95798	79832	68427	59874	53221	47899	43544	39916	36845	34213	31932	29937	28176	26610	25210	23949	22809	21772
77	97059	80882	69327	60662	53921	48529	44117	40441	37330	34663	32353	30330	28546	26960	25541	24264	23109	22058
78	98319	81933	70228	61449	54622	49159	44690	40966	37815	35114	32773	30724	28917	27310	25873	24579	23409	22345
79	99580	82983	71128	62237	55322	49789	45263	41491	38299	35564	33193	31118	29288	27661	26205	24894	23709	22631
80	100804	84033	72029	63024	56022	50420	45836	42016	38784	36014	33613	31512	29658	28011	26536	25210	24009	22918
81	102101	85084	72929	63813	56722	51050	46409	42542	39269	36464	34033	31906	30029	28361	26868	25525	24309	23204
82	103361	86134	73829	64601	57423	51680	46982	43067	39754	36914	34453	32300	30400	28711	27200	25840	24609	23491
83	104622	87185	74730	65388	58123	52310	47555	43592	40239	37365	34874	32694	30771	29061	27532	26155	24909	23777
84	105882	88235	75630	66176	58823	52941	48128	44117	40724	37815	35294	33088	31141	29411	27863	26470	25210	24064
85	107143	89285	76530	66964	59524	53571	48701	44642	41208	38265	35714	33482	31512	29761	28195	26785	25510	24350
86	108403	90336	77430	67752	60224	54201	49274	45168	41693	38715	36134	33876	31883	30112	28527	27100	25810	24637
87	109664	91386	78331	68540	60924	54831	49847	45693	42178	39165	36554	34269	32254	30462	28858	27415	26110	24923
88	110924	92437	79231	69328	61624	55462	50420	46218	42663	39615	36974	34663	32624	30812	29190	27731	26410	25210
89	112185	93487	80132	70115	62325	56092	50993	46743	43148	40066	37395	35057	32995	31163	29522	28046	26710	25496
90	113445	94538	81032	70903	63025	56722	51566	47268	43632	40516	37815	35451	33366	31512	29854	28361	27010	25783
91	114706	95588	81932	71691	63725	57352	52139	47794	44117	40966	38235	35845	33737	31862	30185	28676	27310	26069
92	115967	96638	82833	72479	64426	57983	52712	48319	44602	41416	38655	36239	34107	32212	30517	28991	27611	26355
93	117227	97689	83733	73267	65126	58613	53285	48844	45087	41866	39075	36633	34478	32563	30849	29306	27911	26642
94	118487	98739	84634	74054	65826	59243	53857	49369	45572	42317	39495	37027	34849	32913	31180	29621	28211	26928
95	119748	99790	85534	74842	66526	59873	54430	49895	46056	42767	39916	37421	35220	33263	31512	29936	28511	27215
96	121008	100840	86434	75630	67227	60504	55003	50420	46541	43217	40336	37815	35590	33613	31844	30252	28811	27501
97	122269	101890	87335	76418	67927	61134	55576	50945	47026	43667	40756	38209	35961	33963	32176	30567	29111	27788
98	123529	102941	88235	77206	68627	61764	56149	51470	47511	44117	41176	38602	36332	34313	32507	30882	29411	28074
99	124780	103991	89135	77993	69328	62394	56722	51995	47996	44567	41596	38996	36702	34663	32839	31197	29711	28361
100	126050	105042	90036	78781	70028	63025	57295	52521	48481	45018	42016	39390	37073	35014	33171	31512	30012	28647

Torque (in Pound-Inches) For Horsepower/RPM



Torque for 51-100 HP @ 230-1000 RPM

HP	Revolutions per Minute																		
	230	240	250	260	270	280	290	300	350	400	450	500	550	600	650	700	800	900	1000
51	13975	13392	12857	12362	11904	11479	11083	10714	9183	8035	7141	6428	5844	5357	4945	4591	4017	3571	3314
52	14249	13655	13109	12605	12138	11704	11301	10924	9363	8193	7282	6554	5958	5462	5042	4681	4096	3641	3277
53	14523	13918	13361	12847	12371	11929	11518	11134	9543	8350	7422	6680	6073	5567	5138	4771	4175	3711	3340
54	14797	14180	13613	13089	12605	12154	11735	11344	9723	8508	7563	6806	6187	5672	5235	4861	4254	3781	3403
55	15071	14443	13865	13332	12838	12379	11953	11554	9903	8665	7703	6932	6302	5777	5332	4951	4332	3851	3466
56	15345	14705	14117	13574	13071	12605	12170	11764	10084	8823	7843	7058	6417	5882	5429	5042	4411	3921	3529
57	15619	14968	14369	13817	13305	12830	12387	11974	10264	8981	7983	7184	6531	5987	5526	5132	4490	3991	3592
58	15893	15231	14621	14059	13538	13055	12605	12184	10444	9138	8123	7310	6646	6092	5623	5222	4569	4061	3655
59	16167	15493	14873	14301	13772	13280	12822	12394	10624	9296	8263	7436	6760	6197	5720	5312	4648	4131	3718
60	16441	15756	15126	14544	14055	13505	13039	12605	10804	9453	8403	7563	6875	6302	5817	5402	4726	4201	3781
61	16715	16018	15378	14786	14239	13730	13257	12815	10984	9611	8543	7689	6990	6407	5914	5492	4805	4271	3844
62	16989	16281	15630	15029	14472	13955	13474	13025	11164	9768	8683	7815	7104	6512	6011	5582	4884	4341	3907
63	17263	16544	15882	15271	14705	14180	13691	13235	11344	9926	8823	7941	7219	6617	6108	5672	4963	4411	3970
64	17537	16806	16134	15513	14939	14405	13908	13445	11524	10084	8963	8067	7333	6722	6205	5762	5041	4481	4033
65	17811	17069	16386	15756	15172	14630	14126	13655	11704	10241	9103	8193	7448	6827	6302	5852	5120	4551	4096
66	18085	17331	16638	15998	15406	14855	14343	13865	11884	10399	9243	8319	7563	6932	6399	5942	5199	4621	4159
67	18359	17594	16890	16241	15639	15081	14560	14075	12064	10556	9383	8445	7677	7037	6496	6032	5278	4691	4222
68	18633	17857	17142	16483	15873	15306	14778	14285	12244	10714	9523	8571	7792	7142	6593	6122	5357	4761	4285
69	18907	18119	17394	16725	16106	15531	14995	14495	12424	10871	9663	8697	7906	7247	6690	6212	5435	4831	4348
70	19181	18382	17647	16968	16339	15756	15212	14705	12605	11029	9803	8823	8021	7352	6787	6302	5514	4901	4411
71	19455	18644	17899	17210	16573	15981	15430	14915	12785	11186	9943	8949	8135	7457	6884	6392	5593	4971	4474
72	19729	18907	18151	17453	16806	16206	15647	15126	12965	11344	10084	9075	8250	7563	6981	6482	5672	5042	4537
73	20003	19170	18403	17695	17040	16431	15864	15336	13145	11502	10224	9201	8365	7668	7078	6572	5751	5112	4600
74	20277	19432	18655	17937	17273	16656	16082	15546	13325	11659	10364	9327	8479	7773	7175	6662	5829	5182	4663
75	20551	19695	18907	18180	17507	16881	16299	15756	13505	11817	10504	9453	8594	7878	7272	6752	5908	5252	4726
76	20825	19957	19159	18422	17740	17106	16516	15966	13685	11974	10644	9579	8708	7983	7369	6842	5987	5322	4789
77	21099	20220	19411	18665	17973	17331	16734	16176	13865	12132	10784	9705	8823	8088	7466	6932	6066	5392	4852
78	21373	20483	19663	18907	18207	17557	16951	16386	14045	12289	10924	9831	8938	8193	7563	7022	6144	5462	4915
79	21647	20745	19915	19149	18440	17782	17168	16596	14225	12447	11064	9957	9052	8298	7659	7112	6223	5532	4978
80	21921	21008	20168	19392	18674	18007	17386	16806	14405	12605	11204	10084	9167	8403	7756	7202	6302	5602	5042
81	22195	21271	20420	19634	18907	18232	17603	17016	14585	12762	11344	10210	9281	8508	7853	7292	6381	5672	5105
82	22469	21533	20672	19877	19141	18457	17820	17226	14765	12920	11484	10336	9396	8613	7950	7382	6460	5742	5168
83	22743	21796	20924	20119	19374	18682	18038	17436	14945	13077	11624	10462	9511	8718	8047	7472	6538	5812	5231
84	23017	22058	21176	20362	19607	18907	18255	17647	15126	13235	11764	10588	9625	8823	8144	7563	6617	5882	5294
85	23291	22321	21428	20604	19841	19132	18472	17857	15306	13392	11904	10714	9740	8928	8241	7653	6696	5952	5357
86	23565	22584	21680	20846	20074	19357	18690	18067	15486	13550	12044	10840	9854	9033	8338	7743	6775	6022	5420
87	23840	22846	21932	21089	20308	19582	18907	18277	15666	13707	12184	10966	9969	9138	8435	7833	6853	6092	5483
88	24114	23109	22184	21331	20541	19807	19124	18487	15846	13865	12324	11092	10084	9243	8532	7923	6932	6162	5546
89	24388	23371	22436	21574	20775	20033	19342	18697	16026	14023	12464	11218	10198	9348	8629	8013	7011	6232	5609
90	24662	23634	22689	21816	21008	20258	19559	18907	16206	14180	12605	11344	10313	9453	8726	8103	7090	6302	5672
91	24936	23897	22941	22058	21241	20483	19776	19117	16386	14338	12745	11470	10427	9558	8823	8193	7169	6372	5735
92	25210	24159	23193	22301	21475	20708	19994	19327	16566	14495	12885	11596	10542	9663	8920	8283	7247	6442	5798
93	25484	24422	23445	22543	21708	20933	20211	19537	16746	14653	13025	11722	10656	9768	9017	8373	7326	6512	5861
94	25758	24684	23697	22786	21942	21158	20428	19747	16926	14810	13165	11848	10771	9873	9114	8463	7405	6582	5924
95	26032	24947	23949	23028	22175	21383	20646	19957	17106	14968	13305	11974	10886	9978	9211	8553	7484	6652	5987
96	26306	25210	24201	23270	22408	21608	20863	20168	17286	15126	13445	12100	11000	10084	9308	8643	7562	6722	6050
97	26580	25472	24453	23513	22642	21833	21080	20378	17466	15383	13585	12226	11115	10189	9405	8733	7641	6792	6113
98	26854	25735	24705	23755	22875	22058	21298	20588	17647	15441	13725	12352	11229	10294	9502	8823	7720	6862	6176
99	27128	25997	24957	23998	23109	22283	21515	20798	17827	15598	13865	12478	11344	10399	9599	8913	7799	6932	6239
100	27402	26260	25210	24240	23342	22509	21732	21008	18007	15756	14005	12605	11459	10504	9696	9003	7878	7002	6302

Electrical Formulas

To Find	Alternating Current		To Find	Alternating or Direct Current
	Single-Phase	Three-Phase		
Amperes when horsepower is known	$\frac{HP \times 746}{E \times \text{Eff.} \times \text{pf}}$	$\frac{HP \times 746}{1.73 \times E \times \text{Eff.} \times \text{pf}}$	Amperes when voltage and resistance is known	$\frac{E}{R}$
Amperes when kilowatts are known	$\frac{Kw \times 1000}{E \times \text{pf}}$	$\frac{Kw \times 1000}{1.73 \times E \times \text{pf}}$	Voltage when resistance and current are known	IR
Amperes when Kva are known	$\frac{Kva \times 1000}{E}$	$\frac{Kva \times 1000}{1.73 \times E}$	Resistance when voltage and current are known	$\frac{E}{I}$
Kilowatts	$\frac{I \times E \times \text{pf}}{1000}$	$\frac{1.73 \times I \times E \times \text{pf}}{1000}$	General Information (Approximation) All Values At 100% Load { <ul style="list-style-type: none"> At 1800 RPM, a motor develops 36 lb.-in. per hp At 1200 RPM, a motor develops 54 lb.-in. per hp At 575 volts, a 3-phase motor draws 1 amp per hp At 460 volts, a 3-phase motor draws 1.25 amp per hp At 230 volts, a 3-phase motor draws 2.5 amp per hp At 230 volts, a single-phase motor draws 5 amp per hp At 115 volts, a single-phase motor draws 10 amp per hp 	
Kva	$\frac{I \times E}{1000}$	$\frac{1.73 \times I \times E}{1000}$		
Horsepower = (Output)	$\frac{I \times E \times \text{Eff.} \times \text{pf}}{746}$	$\frac{1.73 \times I \times E \times \text{Eff.} \times \text{pf}}{746}$		
I = Amperes; E = Volts; Eff. = Efficiency; pf = power factor; Kva = Kilovolt amperes; Kw = Kilowatts; R = Ohms				
			Temperature Conversion: Deg C = (Deg F - 32) x $\frac{5}{9}$ Deg F = (Deg C x $\frac{9}{5}$) + 32	

Motor Amps @ Full Load †

HP	Alternating Current			HP	Alternating Current			HP	Alternating Current			HP	Alternating Current		
	Single Phase	3-Phase	DC		Single Phase	3-Phase	DC		Single Phase	3-Phase	DC		Single Phase	3-Phase	DC
½	4.9	2.0	2.7	5	28	14.4	20	25	60	92	75	180	268
1	8.0	3.4	4.8	7½	40	21.0	29	30	75	110	100	240	355
1½	10.0	4.8	6.6	10	50	26.0	38	40	100	146	125	300	443
2	12.0	6.2	8.5	15	38.0	56	50	120	180	150	360	534
3	17.0	8.6	12.5	20	50.0	74	60	150	215	200	480	712

† Values are for all speeds and frequencies @ 230 volts.
 Amperage other than 230 volts can be figured:

$$V = \frac{230 \times \text{Amp from Table}}{\text{New Voltage}}$$

Example:

For 60 HP, 3 phase @ 550 volts: $\frac{(230 \times 150)}{550} = 62$ amps.

Power Factor estimated @ 80% for most motors. Efficiency is usually 80-90%.

NEMA Electrical Enclosure Types

Type	Description	Type	Description
NEMA Type 1 (General Purpose)	For indoor use wherever oil, dust, or water is not a problem	NEMA Type 5 Dust Tight (Non-Hazardous)	Used for excluding dust (All NEMA 12 and JIC enclosures are usually suitable for NEMA 5 use)
NEMA Type 2 (Driptight)	Used indoors to exclude falling moisture and dirt	NEMA Type 9 Dust Tight (Hazardous)*	For locations where combustible dusts are present
NEMA Type 3 (Weatherproof)	Provides protection against rain, sleet, and snow	NEMA Type 12 (Industrial Use)	Used for excluding oil, coolant, flying dust, lint, etc
NEMA Type 4 (Watertight)†	Needed when subject to great amounts of water from any angle — such as areas which are repeatedly hosed down		

NOTE: Joint Industry Conference (JIC) enclosures are similar in design to NEMA 12's.

For more complete details see NEMA or JIC Standards for enclosures.

† Not designed to be submerged.

* Class II Groups E, F, and G.

NEMA Frame Designation



NEMA Frame Designation

Frame Assignments

HP	Motor Speed, RPM				HP	Motor Speed, RPM			
	3600	1800	1200	900		3600	1800	1200	900
1/4-1/2	—	48	—	—	15	215T, 256U	254T, 284U	284T, 324U	286T, 326U
1/4-1/2	48	—	56	—	20	254T, 284U	256T, 286U	286T, 326U	324T, 364U
1/2	—	—	48	—	25	256T, 286U	284T, 324U	324T, 364U	326T, 365U
1/2-1	—	56	—	—	30	284TS, 324S	286T, 326U	326T, 365U	364T, 404U
3/4-1	56	—	—	—	40	286TS, 326S	324T, 364U	364T, 404U	365T, 405U
1/2	—	—	—	143T	50	324TS, 364US	326T, 365U, 365US	365T, 405U	404T, 444U
3/4	—	—	143T	145T	60	326TS, 365US	364TS▲, 404U, 404US	404T, 444U	405T, 445U
1	—	143T	145T	182T	75	364TS, 404US	365TS▲, 405U, 405US	405T, 445U	444T
1 1/2	143T	145T	182T	184T	100	365TS, 405US	404TS▲, 444US	444T	445T
2	145T	145T	184T	213T	125	404TS, 444US	405TS▲, 445US	445T	—
3	145T	182T	213T	215T, 254U	150	405TS, 445US	444TS▲	—	—
5	182T	184T	215T, 254U	254T, 256U	200	—	445TS▲	—	—
7 1/2	184T	213T, 254U	254T, 256U	256T, 284U	250	—	—	—	—
10	213T, 254U	215T, 256U	256T, 284U	284T, 286U	—	—	—	—	—

Motor Frame Dimensions

Frame Size	D	E	2F	H Dia. (4 Holes)	U Dia.	BA	V Min.	Key
48	3	2 1/2	2 3/4	1 1/32	1/2	2 1/2	...	3/16 FLAT
56	3 1/2	2 1/16	3	1 1/32	5/8	2 3/4	...	3/16x3/16x1 1/8
143T	3 1/2	2 3/4	4	1 1/32	7/8	2 1/4	2	3/16x3/16x1 1/8
145T	3 1/2	2 3/4	5	1 1/32	7/8	2 1/4	2	3/16x3/16x1 1/8
182T	4 1/2	3 3/4	4 1/2	1 3/32	1 1/8	2 1/4	2 1/2	1/4x1/4x1 1/4
184T	4 1/2	3 3/4	5 1/2	1 3/32	1 1/8	2 1/4	2 1/2	1/4x1/4x1 1/4
213T	5 1/4	4 1/4	5 1/2	1 3/32	1 1/8	3 1/2	3 1/4	5/16x5/16x2 3/8
215T	5 1/4	4 1/4	7	1 3/32	1 1/8	3 1/2	3 1/4	5/16x5/16x2 3/8
254U	6 1/4	5	8 1/4	1 7/32	1 1/8	4 1/4	3 1/2	5/16x5/16x2 3/8
254T	6 1/4	5	8 1/4	1 7/32	1 1/8	4 1/4	3 1/4	5/16x5/16x2 3/8
256U	6 1/4	5	10	1 7/32	1 1/8	4 1/4	3 1/2	5/16x5/16x2 3/8
256T	6 1/4	5	10	1 7/32	1 1/8	4 1/4	3 1/4	5/16x5/16x2 3/8
284U	7	5 1/2	9 1/2	1 7/32	1 1/8	4 3/4	4 1/4	3/8x3/8x3 3/8
284T	7	5 1/2	9 1/2	1 7/32	1 1/8	4 3/4	4 1/4	1/2x1/2x3 3/8
284TS	7	5 1/2	9 1/2	1 7/32	1 1/8	4 3/4	3	3/8x3/8x1 1/8
286U	7	5 1/2	11	1 7/32	1 1/8	4 3/4	4 1/4	3/8x3/8x3 3/8
286T	7	5 1/2	11	1 7/32	1 1/8	4 3/4	4 1/4	1/2x1/2x3 3/8
286TS	7	5 1/2	11	1 7/32	1 1/8	4 3/4	3	3/8x3/8x1 1/8
324U	8	6 1/4	10 1/2	2 1/32	1 1/8	5 1/4	5 1/2	1/2x1/2x4 1/4
324T	8	6 1/4	10 1/2	2 1/32	2 1/8	5 1/4	5	1/2x1/2x3 3/8
324TS	8	6 1/4	10 1/2	2 1/32	1 1/8	5 1/4	3 1/2	1/2x1/2x2
326U	8	6 1/4	12	2 1/32	1 1/8	5 1/4	5 1/2	1/2x1/2x4 1/4
326T	8	6 1/4	12	2 1/32	2 1/8	5 1/4	5	1/2x1/2x3 3/8
326TS	8	6 1/4	12	2 1/32	1 1/8	5 1/4	3 1/2	1/2x1/2x2
364U	9	7	11 1/4	2 1/32	2 1/8	5 3/4	6 1/4	1/2x1/2x5
364US	9	7	11 1/4	2 1/32	1 1/8	5 3/4	3 1/2	1/2x1/2x2
364T	9	7	11 1/4	2 1/32	2 1/8	5 3/4	5 1/2	3/8x3/8x4 1/4
364TS	9	7	11 1/4	2 1/32	1 1/8	5 3/4	3 1/2	1/2x1/2x2
365U	9	7	12 1/4	2 1/32	2 1/8	5 3/4	6 1/4	1/2x1/2x5
365US	9	7	12 1/4	2 1/32	1 1/8	5 3/4	3 1/2	1/2x1/2x2
365T	9	7	12 1/4	2 1/32	2 1/8	5 3/4	5 1/2	3/8x3/8x5 1/4
365TS	9	7	12 1/4	2 1/32	1 1/8	5 3/4	3 1/2	1/2x1/2x2
404U	10	8	12 1/4	3 1/16	2 1/8	6 1/4	6 1/4	3/8x3/8x5 1/2
404US	10	8	12 1/4	3 1/16	2 1/8	6 1/4	4	1/2x1/2x2 3/4
404T	10	8	12 1/4	3 1/16	2 1/8	6 1/4	7	3/8x3/8x5 1/2
404TS	10	8	12 1/4	3 1/16	2 1/8	6 1/4	4	1/2x1/2x2 3/4
405U	10	8	13 3/4	3 1/16	2 1/8	6 1/4	6 1/4	3/8x3/8x5 1/2
405US	10	8	13 3/4	3 1/16	2 1/8	6 1/4	4	1/2x1/2x2 3/4
405T	10	8	13 3/4	3 1/16	2 1/8	6 1/4	7	3/8x3/8x5 1/2
405TS	10	8	13 3/4	3 1/16	2 1/8	6 1/4	4	1/2x1/2x2 3/4
444U	11	9	14 1/2	3 1/16	2 1/8	7 1/2	8 1/4	3/8x3/8x7
444US	11	9	14 1/2	3 1/16	2 1/8	7 1/2	4	1/2x1/2x2 3/4
444T	11	9	14 1/2	3 1/16	3 1/8	7 1/2	8 1/4	1/2x1/2x6 1/8
444TS	11	9	14 1/2	3 1/16	2 1/8	7 1/2	4 1/2	3/8x3/8x3
445U	11	9	16 1/2	3 1/16	2 1/8	7 1/2	8 1/4	3/8x3/8x7
445US	11	9	16 1/2	3 1/16	2 1/8	7 1/2	4	1/2x1/2x2 3/4
445T	11	9	16 1/2	3 1/16	3 1/8	7 1/2	8 1/4	1/2x1/2x6 1/8
445TS	11	9	16 1/2	3 1/16	2 1/8	7 1/2	4 1/2	3/8x3/8x3

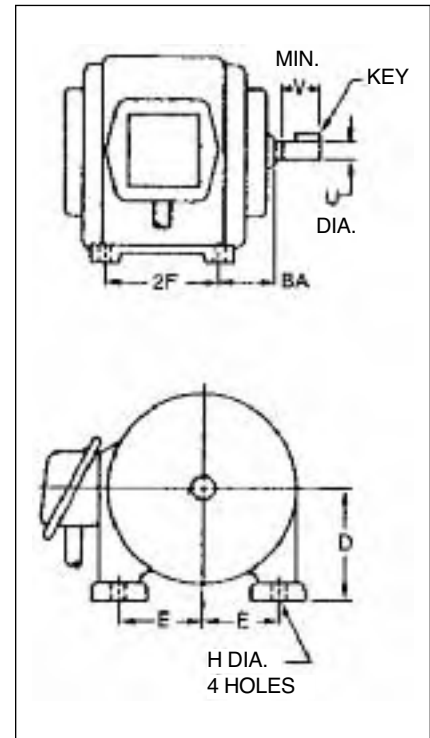

Shaded area indicates typical single phase standard squirrel-cage, open type, a-c motors. Balance of table same except three phase, design A and B.

▲ When these motors are used with V-belt or chain drives, the correct frame size is the one with the suffix "S" omitted — consult manufacturer.

Shaft Selection

Important factors to consider when calculating shaft size

- shafting is subject to a **bending moment** and a **torsional moment**.
- bending moment is that force which tends to **bend** a shaft.
- torsional moment is that force which tends to **twist** a shaft.
- shaft size is determined by the **combined action** of the bending and torsional moments.

Refer to Shaft Selection Charts 2 and 3 developed by the American Society of Mechanical Engineers to simplify selection. The charts should be used in conjunction with Service Factors (Table 1) to modify the selection for conditions under which the shaft will operate.

- A = Shaft length from center of bearing to center of load
- L = Unbalanced load in pounds
- W = Suspended weight of elevator (chain, buckets, etc.) in pounds
- R = Radius of wheel in inches
- B = Bending moment
- T = Torsional moment
- $B = A \frac{L + W}{2}$ inch pounds
- $T = R \times L$ inch pounds

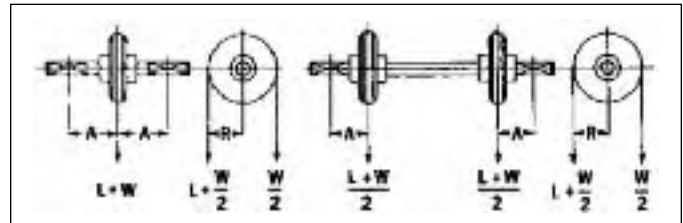

Selection Procedure

- compute the Bending Moment from the above formula.
- determine the Service Factor for bending that will suit conditions from Table 1.
- compute the Torsional Moment from the above formula.
- determine the Service Factor for torsion that will suit conditions from Table 1.
- draw a horizontal line across Selection Chart 2 or 3 on pages M-10 and M-11, from the point where the **torsional moment intersects** its selected Service Factor line.
- draw a vertical lineup Selection Chart 2 or 3 from the point where the **bending moment intersects** its selected factor line.
- intersection of above lines will give required shaft size.
- for shafts not weakened by keyways, multiply the shaft size obtained by .91 for the corrected shaft size. See note at the bottom of Selection Chart 3.

Horsepower required may be computed directly from the right-hand side of Selection Charts by correcting the figure in line with the horizontal torsional moment line by the speed in RPM.

Table 1 • Service Factors

Type of Loading	Service Factor	
	For Bending	For Torsion
Stationary Shafts –		
Gradually applied loads	1.0	1.0
Suddenly applied loads	1.5 to 2.0	1.5 to 2.0
Rotating Shafts –		
Gradually applied or steady loads	1.5	1.0
Suddenly applied loads –		
Minor shock only	1.5 to 2.0	1.0 to 1.5
Suddenly applied loads –		
Heavy shock	2.0 to 2.5	1.5 to 2.5

Selection Example:

Select shaft size for head shaft of chain conveyor subject to following requirements:

- Torsion (inch/lbs) — 20,500
- Bending moment (inch/lbs) — 13,300
- Service Factors:
 - torsion — 1.0
 - bending — 1.5

At the extreme left on Selection Chart 2, the torsion moment may be found for the Service Factor of 1.0. Draw a horizontal line to the right from the 20,500 point. The bending moment is given at the bottom of the chart. Find the 13,300 point; draw a line from this point to the right on the diagonal until it intersects the 1.5 Service Factor line, then project the line upward vertically until it intersects the horizontal line drawn from the 20,500 torsion point. At this intersection point, it is found that a shaft of approximately 2^{13/16}” diameter is required.

Select the nearest standard size shaft which is 2^{15/16}”.

For a shaft subjected to the same conditions, but not weakened by keyways, the size of the shaft required would be (.91 x 2.8125) or 2.56 (2^{9/16}”). See note at the bottom of the charts.

On this same chart at the right, the horsepower ratings at 100 RPM are given based on the formula:

$$HP = \frac{TS}{63,000}$$

T = Torque in inch-pounds

S = Speed in RPM

The horsepower is directly proportional to the speed of the shaft in RPM.

Shaft Tables

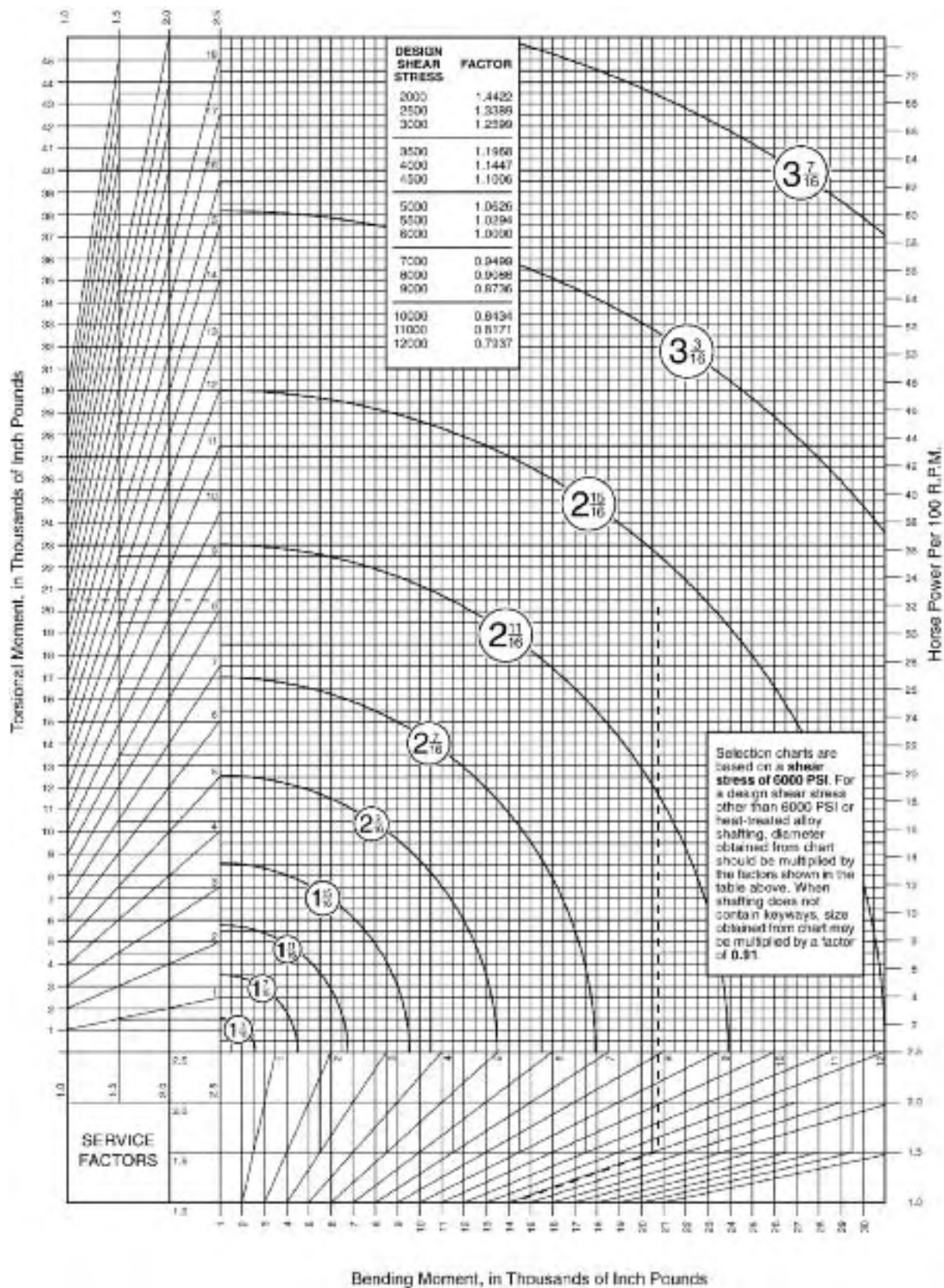

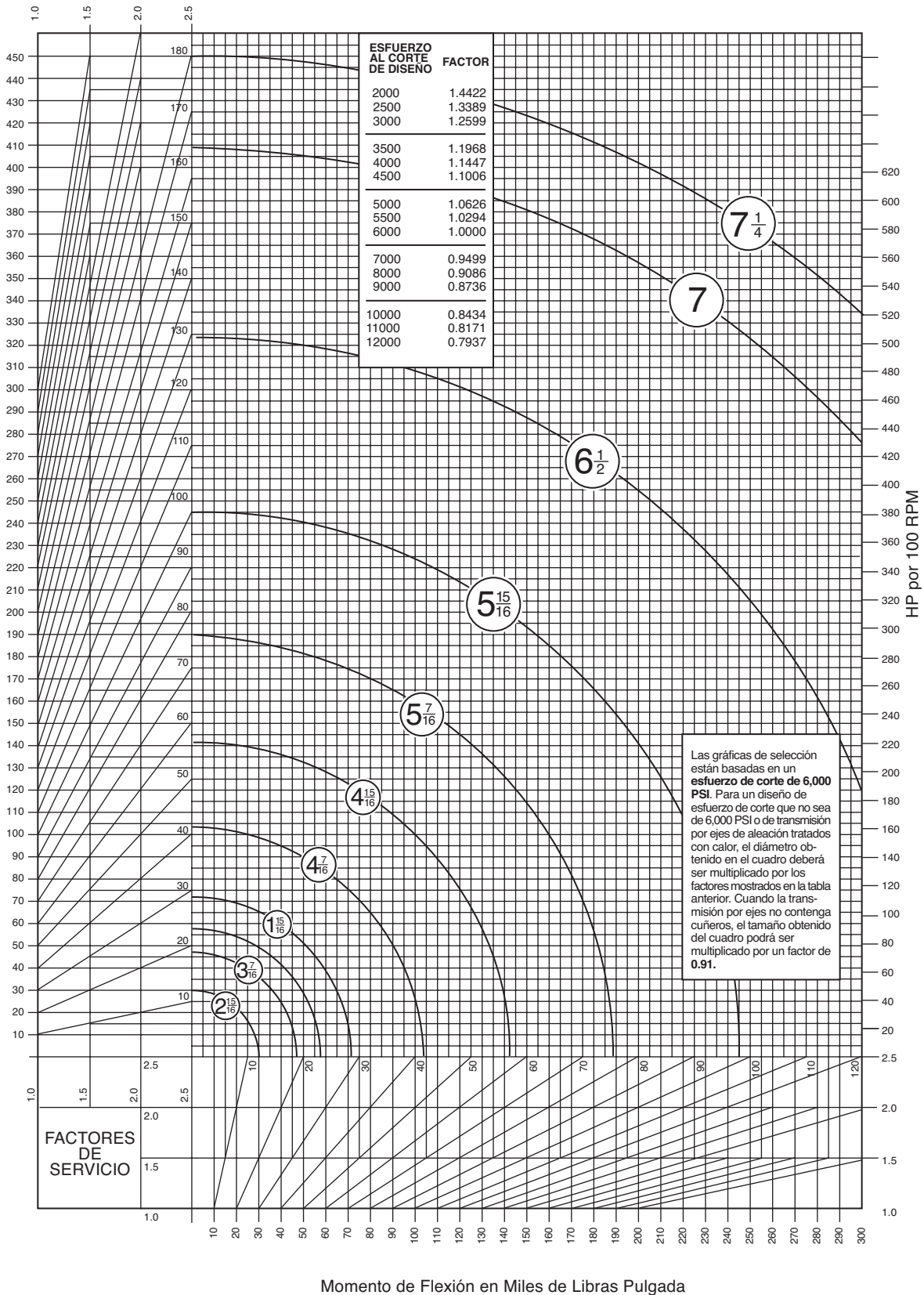

Flywheel Formulas



Flywheels are occasionally used on a few machines, such as air compressors, to even out load pulsations. These formulas are useful in designing entire flywheel rims. It is also possible to use V-Belt sheaves as a flywheel thus eliminating the need for a separate flywheel in the system. Consult *Martin* with specific requirements.

Formulas for Entire Flywheel

- W = weight (pounds)
- R = radius of gyration (feet)
- N = speed (RPM)
- t = time to change from N₁ to N₂ (seconds)
- F = face of rim (inches)
- D = outside diameter of rim (inches)
- d = inside diameter of rim (inches)
- P = weight per cubic inch of material (pounds)

where N₂ = final RPM and N₁ = initial RPM
 Velocity at outside diameter (feet per minute) = 0.2618 ND

Kinetic energy of rotation of a flywheel (foot pounds) = .0001705 N²(WR²)*.

Torque to accelerate or decelerate a flywheel uniformly (pound inches) =
$$\frac{.03908(N_2 - N_1)(WR^2)^*}{t}$$

*WR² = flywheel effect (pounds x feet²). See table below for WR² of rims. Ordinarily the WR² of the rim only is considered. In unusual instances the relatively small WR² values of the hub and arms or web can be added directly to the WR² of the rim if desired. To find the WR² of a hub or web use the WR² formula for rims, substituting the hub or web outside diameter, inside diameter, and width for D, d, and F respectively. When arms are used instead of a web an approximate WR² value of the arms is the total weight of the arms in pounds times the square of the radius in feet from the shaft center line to the mid-point of the arms between hub and rim.

Formulas for Flywheel Rims

Property	Cast Iron Rim (Based on .26 lbs per cubic inch)	Steel Rim Rim (Based on .283 lbs per cubic inch)	Rim of any Material Weighing P Pounds per cubic inch
Volume (Cubic Inches)	.7854F(D ² - d ²)	.7854F(D ² - d ²)	.7854F(D ² - d ²)
W Weight (Pounds)	.2042F(D ² - d ²)	.2223F(D ² - d ²)	.7854FP(D ² - d ²)
R Radius of Gyration (Feet)	$\sqrt{\frac{.8681(D^2 + d^2)}{1000}}$	$\sqrt{\frac{.8681(D^2 + d^2)}{1000}}$	$\sqrt{\frac{.8681(D^2 + d^2)}{1000}}$
WR ² Wt. x Sq. of Radius of Gyration (Lbs. x Ft. ²)	$\frac{.1773F(D^4 - d^4)}{1000}$	$\frac{.1929F(D^4 - d^4)}{1000}$	$\frac{.6818FP(D^4 - d^4)}{1000}$
Ts Tensile Load in Rim (Lbs.)	$\frac{.3078FN^2(D^3 - d^3)}{1,000,000}$	$\frac{.3350FN^2(D^3 - d^3)}{1,000,000}$	$\frac{1.184PFN^2(D^3 - d^3)}{1,000,000}$

▲ Centrifugal force causes this tensile load at each and every section of the rim. Thus on rims split into two or more sections, the fastening at each joint should be designed to take the full load as calculated from the formula below.

Centrifugal Force

R = Distance from the axis of rotation to the center of gravity of the body (feet)

N = Revolutions per minute (RPM)

v = Velocity of the center of gravity of the body (feet per second)

g = Acceleration due to gravity (32.16 commonly)

$$F = \frac{Wv^2}{gR} = \frac{WRN^2}{2933} = .000341 WRN^2$$

F = Centrifugal force tending to move the body outward from the axis of rotation (pounds)

W = Weight of body (pounds)



Weights of Steel

NOTE: The steel weights in this section are nominal and are based on an approximate weight of 40.80 pounds per square foot, one inch thick. There may be differences between nominal weights and actual scale weights because of variation in manufacturing practices.

Hot Rolled and Cold Finished Steel Products Nominal Weight

Product	Thickness	Width	Length	Formulas		Thickness	Diameter		
Plates, Strip and Flats	Inches	Inches	Inches	.2833 x T x W x L	Plate Circles	Inches	Inches	.2225 x T x D ²	
	Inches	Inches	Feet	3.4 x T x W x L		Inches	Feet	32.05 x T x D ²	
	Inches	Feet	Feet	40.8 x T x W x L	Sheet Circles	Inches	Inches	.228 x T x D ²	
	USS. Ga No.	Feet	Feet	Wt./Sq. Ft. x W x L		Inches	Feet	32.85 x T x D ²	
	Wt. per Sq. Ft.	Feet	Feet	Wt./Sq. Ft. x W x L		Diameter	Length		
Hot and C.R. Sheets	Inches	Inches	Inches	.2904 x T x W x L	Bars	Square Round Hexagon Octagon	Inches	Feet	3.4 x D ² x L
	Inches	Inches	Feet	3.485 x T x W x L			Inches	Feet	2.67 x D ² x L
	Inches	Feet	Feet	41.82 x T x W x L			Inches	Feet	2.945 x D ² x L
	USS. Ga No.	Feet	Feet	Wt./Sq. Ft. x W x L			Inches	Feet	2.817 x D ² x L
	Wt. per Sq. Ft.	Feet	Feet	Wt./Sq. Ft. x W x L					
					T = thickness L = length W = width D = diameter				

Steel Rounds

Size in Inches	Pounds Per Foot	Size in Inches	Pounds Per Foot
7/8	2.04	2 1/16	23.04
1 1/16	2.35	3	24.03
1	2.67	3 1/16	25.05
1 1/16	3.01	3 1/8	26.08
1 1/8	3.38	3 3/16	27.13
1 1/16	3.77	3 1/4	28.20
1 1/4	4.17	3 3/8	29.30
1 3/16	4.60	3 3/8	30.42
1 1/8	5.05	3 3/8	31.55
1 1/16	5.52	3 1/2	32.71
1 1/2	6.01	3 3/8	33.89
1 3/16	6.52	3 3/8	35.09
1 1/8	7.05	3 1/16	36.31
1 1/16	7.60	3 3/4	37.55
1 3/4	8.18	3 5/16	38.81
1 3/16	8.77	3 3/8	40.10
1 3/8	9.39	3 5/16	41.40
1 3/16	10.02	4	42.73
2	10.68	4 1/16	44.07
2 1/16	11.36	4 1/8	45.44
2 1/8	12.06	4 3/16	46.83
2 3/16	12.78	4 1/4	48.23
2 1/4	13.52	4 3/8	49.66
2 3/16	14.28	4 3/8	51.11
2 3/8	15.06	4 3/8	52.58
2 1/2	15.87	4 1/2	54.08
2 3/8	16.69	4 3/8	55.59
2 3/16	17.53	4 3/8	57.12
2 3/4	18.40	4 1/16	58.68
2 1/16	19.29	4 3/4	60.25
2 3/4	20.19	4 3/16	61.85
2 3/16	21.12	4 3/8	63.46
3 3/8	22.07	4 5/16	65.10

Standard Sheet Weights

Ga. Number	Thickness in Inches	Weight Per Square Foot in Pounds
Over 3/16" are plates		
7	.1793	7.500
8	.1644	6.875
9	.1494	6.250
10	.1345	5.625
11	.1196	5.000
12	.1046	4.375
13	.0897	3.750
14	.0747	3.125
15	.0673	2.812
16	.0598	2.500

Carbon Steel Plates

Size in Inches	Weight Per Square Foot in Pounds
3/16	7.76
1/4	10.20
5/16	12.75
3/8	15.30
7/16	17.85
1/2	20.40
9/16	22.95
5/8	25.50
3/4	30.60
13/16	33.15
7/8	35.70
1	40.80
1 1/8	45.90
1 1/4	51.00
1 1/2	56.10
1 3/4	61.20

NOTE: Stainless Steel Weights approximately 10% more than Carbon Steel.

Properties of Steel

The information shown below is offered as a general guide to physical properties of steel in common use. Lower tensile properties are to be expected in large sections; the values of strength decrease as the size of the section increases. These values are not guaranteed and must **NOT** be used in specifying the raw materials or as a basis for acceptance or rejection of material. It must not be assumed that these properties will be obtained in all cases as they vary widely with permissible variations in analysis, size of section, rolling conditions, grain size and methods of heat treatment. Dependable physical properties can only be obtained through carefully controlled analysis and heat treatment.

Average Properties of Standard Steels

AISI Number	SAE Number	Condition of Steel	Strength in 1000 PSI		% Elong. in 2"	% Red. of Area	Hardness		Machinability % of B1112 CD
			Tensile	Yield			Brinell	Rockwell	
B1112	1112	COLD DRAWN BESSEMER.....	75-90	60-70	12-16	40-50	170-185	80-95B	100
C1018	1018	NATURAL HOT ROLLED.....	55-70	40-50	25-35	50-65	120-140	55
		COLD DRAWN.....	70-85	50-70	18-25	45-55	160-180	80-90B	65
		1" RD. CARBURIZED AT 1700°F., COOLED IN BOX, REHEATED, QUENCHED - CORE PROPERTIES.....	90-100	60-80	10-22	35-50	200-230	93-98B
C1020	1020	NATURAL HOT ROLLED.....	60-80	40-50	25-35	50-65	120-145	60-98B	50
		COLD DRAWN.....	70-80	45-70	15-25	45-60	120-160	70-85B	60
C1117	1117	NATURAL HOT ROLLED.....	60-70	37-47	20-30	45-60	135-150	80
		COLD DRAWN.....	80-90	60-75	15-20	40-50	160-190	80-90B	90
		1" RD. CARBURIZED AT 1700°F., COOLED IN BOX, REHEATED, QUENCHED - CORE PROPERTIES.....	95-110	60-85	10-25	35-50	210-240	15-22C
C1035	1035	NATURAL HOT ROLLED.....	75-85	40-55	18-25	40-55	155-175	60
		COLD DRAWN.....	85-95	65-80	15-25	40-50	170-200	85-95B	65
		1" RD. QUENCHED, TEMPERED 1000°F.....	95-105	70-80	20-25	55-60	195-220	93-98B	55
C1040	1040	NATURAL HOT ROLLED.....	80-90	45-55	18-25	35-50	165-185	60
		COLD DRAWN.....	90-100	70-85	14-20	35-50	190-215	91-98B	62
C1042	1042	1" RD. QUENCHED, TEMPERED 1000°F.....	100-110	75-85	15-25	45-60	210-240	17-23C	52
		NATURAL HOT ROLLED.....	85-95	50-60	15-25	35-50	175-205	58
C1045	1045	COLD DRAWN.....	90-105	75-90	12-20	30-45	185-215	60
		1" RD. QUENCHED, TEMPERED 1000°F.....	105-120	80-90	15-25	40-60	215-250
		NATURAL HOT ROLLED.....	85-105	50-65	15-25	35-45	175-215	55
C1141	1141	COLD DRAWN.....	90-110	75-90	12-20	30-45	195-230	95-99B	58
		1" RD. QUENCHED, TEMPERED 1000°F.....	110-130	80-95	12-25	40-55	235-260	22-26C	47
		NATURAL HOT ROLLED.....	90-110	60-80	15-25	25-45	180-220	65
C1144	1144	COLD DRAWN.....	100-120	85-105	8-18	20-50	195-230	70
		1" RD. QUENCHED, TEMPERED 1000°F.....	120-145	100-130	10-20	35-50	270-310
		NATURAL HOT ROLLED.....	95-110	60-85	15-25	30-45	200-240	75
C1050	1050	COLD DRAWN.....	100-120	90-115	7-17	20-45	210-245	17-23C	85
		1" RD. QUENCHED, TEMPERED 1000°F.....	130-150	110-130	15	45	286-302	29-31C
		NATURAL HOT ROLLED.....	95-110	55-70	15-20	25-40	210-325	50
4140	4140	1" RD. QUENCHED, TEMPERED 1000°F.....	115-135	85-100	10-22	35-50	240-265	23-27C
		HOT ROLLED, ANNEALED.....	90-100	60-70	20-30	50-60	185-210	91-95B	55
		COLD DRAWN, ANNEALED.....	110-120	85-95	15-25	45-55	230-250	20-25C	65
E52100	52100	HEAT TREATED, COLD DRAWN.....	140-155	125-140	12-20	45-55	270-300	26-30C	45
		1" RD. QUENCHED, TEMPERED 1000°F.....	150-160	130-140	15-20	50-60	320-350	34-37C
		2" RD. QUENCHED, TEMPERED 1000°F.....	145-155	125-135	15-20	50-60	320-345	33-36C
8620	8620	3" RD. QUENCHED, TEMPERED 1000°F.....	130-145	115-125	15-20	55-65	280-310	28-32C
		HOT ROLLED, ANNEALED.....	100-110	75-85	20-25	50-60	210-235	45
		1" RD. QUENCHED, TEMPERED 1000°F.....	180-195	65-80	10-15	35-45	375-415	40-43C
8645	8645	NATURAL HOT ROLLED.....	90-95	55-65	18-25	45-60	160-200	85-95B	55
		COLD DRAWN.....	90-105	65-80	15-25	40-50	185-215	90-96B	60-70
		1" RD. CARBURIZED 1700°F., COOLED IN BOX, REHEATED, QUENCHED - CORE PROPERTIES.....	120-135	90-110	15-20	40-50	285-350	28-40C
8742	8742	NATURAL HOT ROLLED.....	105-125	55-75	15-25	35-50	220-270	20-28C	48-55
		HOT ROLLED, ANNEALED.....	100-110	50-60	20-25	40-55	210-230	17-21C	54
		2" RD. QUENCHED, TEMPERED 1000°F.....	140-150	110-125	15-20	45-55	300-320	30-34C
8742	8742	3" RD. QUENCHED, TEMPERED 1000°F.....	130-140	105-115	15-20	50-60	285-310	29-32C
		NATURAL HOT ROLLED.....	110-125	50-70	15-25	35-50	230-270	22-28C	45-50
		COLD DRAWN, ANNEALED.....	105-120	95-105	10-18	35-45	210-235	95-99B	60
8742	8742	1" RD. QUENCHED, TEMPERED 1000°F.....	155-165	135-145	15-20	45-52	330-335	35-38C
		2" RD. QUENCHED, TEMPERED 1000°F.....	135-145	110-120	15-20	50-60	290-320	30-33C

Physical Properties of Various Metals

Metals and Alloys	Stress in Thousands of Pounds per Square Inch				Modulus of Elasticity 1,000,000 Lbs.	Elongation %
	Tension Ultimate	Tension Yield Point	Compression Ultimate	Shear Ultimate		
ALUMINUM, TYPE 3003-0, ANNEALED	16	6	11	10	40
ALUMINUM, TYPE 3003-H18, HARD	29	27	16	10	10
ALUMINUM, TYPE 5052-0, ANNEALED	28	13	18	10.2	30
ALUMINUM, TYPE 5052-H38, HARD	42	37	24	10.2	8
ALUMINUM, TYPE 5056-0, ANNEALED	42	22	26	10.3	35
ALUMINUM, TYPE 2014-0, ANNEALED	27	14	18	10.6	18
ALUMINUM, TYPE 2014-T4, HEAT TREATED	62	42	38	10.6	20
ALUMINUM, TYPE C4A, CASTING, SOLUTION HEAT TREAT	32	16	16▲	24	8.5
ALUMINUM, TYPE S5C, AS DIE CAST	30	16	16▲	19	9
BRASS, ALUMINUM, ANNEALED	60	27	16	55
BRASS, RED, 15% ZN, ANNEALED	39	10	31	17	48
BRASS, RED, 15% ZN, HARD	70	57	42	17	5
BRASS, RED, LEADED, CAST, GRADE 4A	33-46	17-24	10-12▲	9.1-14.8	20-35
BRASS, RED, LEADED, CAST, GRADE 4B	30-38	12-17	11-12▲	15-27
BRASS, YELLOW, 35% ZN, ANNEALED	46	14	32	15	65
BRASS, YELLOW, 35% ZN, HARD	74	60	43	15	8
BRONZE, ALUMINUM, AS CAST	67-95	27-45	15-18	5-35
BRONZE, COMMERCIAL, 10% ZN, ANNEALED	37†	10†	28†	17	45†
BRONZE, MANGANESE, ANNEALED	65†	30†	42†	15	33†
BRONZE, PHOSPHOR, ANNEALED	40-66	14-24	16-17	48-70
BRONZE, TIN, HIGH LEADED, CAST	23-38	11-22	12-16▲	8.5-13	7-20
BRONZE, TIN, LEADED, CAST	33-48	16-26	9-15▲	10.6-16	15-40
COPPER, BERYLLIUM, ANNEALED	60-80†	25-35†	50-60†	19	35-50†
INCONEL, CAST	65-90	23	10-20
INCONEL, S, CAST	90-120	80-100	25	1-3
IRON, CAST, CLASS 30	30-34	115	44	15
IRON, CAST, CLASS 35	35-40	125	43	16
IRON, MALLEABLE, CLASS 32510	50	33	90	46	25	10-18
IRON, MALLEABLE, CLASS 35018	55	37	90	51	25	18-25
IRON, NODULAR (DUCTILE) CLASS 60-45-10	60	45	120	22-25	10-25
IRON, NODULAR (DUCTILE) CLASS 80-60-3	80	60	160	22-25	3-10
IRON, PEARLITIC, MALLEABLE	60-90	40-70	28	3-12
IRON, WROUGHT, HOT ROLLED	34-47	23-24	29	7-35
LEAD, HARD, ROLLED	4.0-4.6	31-48
MONEL, CAST	65-90	32-45	23	20-50
MONEL, S, CAST	120-145	80-130	24.2	1-4
MONEL, SHAPES, PLATE, ETC., ANNEALED	70-85†	25-45†	26	35-50†
NICKEL, CAST	50-65	15-30	21.5	15-30
NICKEL, SILVER, ANNEALED	49-63†	18-30†	17-18	35-60†
STEEL, CAST CARBON, CLASS 70,000 NORMALIZED	70	38	30	28
STEEL, CAST LOW ALLOY, CLASS 100,000, NORMALIZE & TEMPERED	100	68	29-30	20
STEEL, CAST LOW ALLOY, CLASS 120,000, QUENCHED AND TEMPERED	120	95	29-30	16
STEEL, CAST LOW ALLOY, CLASS 200,000, QUENCHED AND TEMPERED	200	170	29-30	5
STEEL, SHEETS	48	25	29-30	18-27
STEEL, STAINLESS, AUSTENITIC, TYPES 304, 316	85	35	28	55-60
STEEL, STAINLESS, MARTENSITIC, TYPE 416	75	40	29	30
STEEL, STRUCTURAL, BRIDGE AND BUILDING, ASTM A7	60-72	33	33▲	45-54	29-30	21
STEEL, STRUCTURAL, HIGH STRENGTH, LOW ALLOY, ASTM A242	63-72	42-50	42-50▲	47-53	29-30	18-24
ZINC, DIE CAST ALLOY, XXIII	41	60▲	31	10

† When hardened, strength values are higher, elongation less.

▲ Compression yield point.

Hardness Conversion Chart



Brinell, Rockwell, and Scleroscope Hardness Numbers with Corresponding Tensile Strength

Brinell 10 MM Ball 3000 Kg.	Rockwell "C" 120 Cone 150 Kg.	Scleroscope Shore Model C	Tensile Strength 1000 Pound Per Square Inch
745	68	100	368
712	66	95	352
682	64	91	337
653	62	87	324
627	60	84	311
601	58	81	298
578	57	78	287
555	55	75	276
534	53	72	266
514	52	70	256
495	50	67	247
477	49	65	238
461	47	63	229
444	46	61	220
429	45	59	212
415	44	57	204
401	42	55	196
388	41	54	189
375	40	52	182
362	38	51	176
351	37	49	170
341	36	48	165
331	35	46	160
321	34	45	155
311	33	44	150
302	32	43	146
293	31	42	142
285	30	40	138
277	29	39	134
269	28	38	131
262	26	37	128
255	25	37	125
248	24	36	122
241	23	35	119
235	22	34	116
229	21	33	113
223	20	32	110
	Rockwell "B" 1/16" Ball 100 Kg.		
217	97	31	107
212	96	31	104
207	95	30	101
202	94	30	99
197	93	29	97
192	92	28	95
187	91	28	93
183	90	27	91
179	89	27	89
174	88	26	87



Decimal Equivalent Table

Decimal and Millimeter Equivalents of Fractions

Inches			Inches			Inches		
Fractions	Decimals	Millimeters	Fractions	Decimals	Millimeters	Fractions	Decimals	Millimeters
1/64.....	.015625	.397	1 1/32.....	.34375	8.731	1 1/16.....	.6875	17.463
1/32.....	.03125	.794	2 3/64.....	.359375	9.128	4 5/64.....	.703125	17.859
3/64.....	.406875	1.191	3/8.....	.375	9.525	2 3/32.....	.71875	18.256
1/16.....	.0625	1.588	2 5/64.....	.390625	9.922	4 7/64.....	.734375	18.653
5/64.....	.078125	1.984	1 3/32.....	.40625	10.319	3/4.....	.750	19.050
3/32.....	.09375	2.381	2 7/64.....	.421875	10.716	4 9/64.....	.765625	19.447
7/64.....	.109375	2.778	7/16.....	.4375	11.113	2 5/32.....	.78125	19.844
1/8.....	.125	3.175	2 9/64.....	.453125	11.509	5 1/64.....	.796875	20.241
9/64.....	.140625	3.572	1 5/32.....	.46875	11.906	1 3/16.....	.8125	20.638
5/32.....	.15625	3.969	3 1/64.....	.484375	12.303	5 3/64.....	.828125	21.034
1 1/64.....	.171875	4.366	1/2.....	.500	12.700	2 7/32.....	.84375	21.431
3/16.....	.1875	4.763	3 3/64.....	.515625	13.097	5 5/64.....	.859375	21.828
1 1/4.....	.203125	5.159	1 1/32.....	.53125	13.494	7/8.....	.875	22.225
7/32.....	.21875	5.556	3 5/64.....	.546875	13.891	5 7/64.....	.890625	22.622
1 5/64.....	.234375	5.953	9/16.....	.5625	14.288	2 9/32.....	.90625	23.019
1/4.....	.250	6.350	3 7/64.....	.578125	14.684	5 9/64.....	.921875	23.416
1 1/8.....	.265625	6.747	1 9/32.....	.59375	15.081	1 5/16.....	.9375	23.813
9/32.....	.28125	7.144	3 9/64.....	.609375	15.478	6 1/64.....	.953125	24.209
1 1/8.....	.296875	7.541	5/8.....	.625	15.875	3 1/32.....	.96875	24.606
5/16.....	.3125	7.938	4 1/64.....	.640625	16.272	6 3/64.....	.984375	25.003
2 1/64.....	.328125	8.334	2 1/32.....	.65625	16.669	1.....	1.000	25.400
			4 3/64.....	.671875	17.066			

Decimal Equivalents of Millimeters

MM	Inches	MM	Inches	MM	Inches	MM	Inches	MM	Inches	MM	Inches	MM	Inches	MM	Inches
.1	.00394	9.5	.37401	22.5	.88582	35.5	1.39763	48.5	1.90944	61.5	2.42125	74.5	2.93306	87.5	3.44487
.2	.00787	10.	.39370	23.	.90551	36.	1.41732	49.	1.92913	62.	2.44094	75.	2.95275	88.	3.46456
.3	.01181	10.5	.41338	23.5	.92519	36.5	1.43700	49.5	1.94881	62.5	2.46062	75.5	2.97243	88.5	3.48424
.4	.01575	11.	.43307	24.	.94488	37.	1.45669	50.	1.96850	63.	2.48031	76.	2.99212	89.	3.50393
.5	.01968	11.5	.45275	24.5	.96456	37.5	1.47637	50.5	1.98818	63.5	2.49999	76.5	3.01180	89.5	3.52361
.6	.02362	12.	.47244	25.	.98425	38.	1.49606	51.	2.00787	64.	2.51968	77.	3.03149	90.	3.54330
.7	.02756	12.5	.49212	25.5	1.00393	38.5	1.51574	51.5	2.02755	64.5	2.53936	77.5	3.05117	90.5	3.56298
.8	.03149	13.	.51181	26.	1.02362	39.	1.53543	52.	2.04724	65.	2.55905	78.	3.07086	91.	3.58267
.9	.03543	13.5	.53149	26.5	1.04330	39.5	1.55511	52.5	2.06692	65.5	2.57873	78.5	3.09054	91.5	3.60235
1.	.03937	14.	.55118	27.	1.06299	40.	1.57480	53.	2.08661	66.	2.59842	79.	3.11023	92.	3.62204
1.5	.05905	14.5	.57086	27.5	1.08267	40.5	1.59488	53.5	2.10629	66.5	2.61810	79.5	3.12991	92.5	3.64172
2.	.07874	15.	.59055	28.	1.10236	41.	1.61417	54.	2.12598	67.	2.63779	80.	3.14960	93.	3.66141
2.5	.09842	15.5	.61023	28.5	1.12204	41.5	1.63385	54.5	2.14566	67.5	2.65747	80.5	3.16928	93.5	3.68109
3.	.11811	16.	.62992	29.	1.14173	42.	1.65354	55.	2.16535	68.	2.67716	81.	3.18897	94.	3.70078
3.5	.13779	16.5	.64960	29.5	1.16141	42.5	1.67322	55.5	2.18503	68.5	2.69684	81.5	3.20865	94.5	3.72046
4.	.15748	17.	.66929	30.	1.18110	43.	1.69291	56.	2.20472	69.	2.71653	82.	3.22834	95.	3.74015
4.5	.17716	17.5	.68897	30.5	1.20078	43.5	1.71259	56.5	2.22440	69.5	2.73621	82.5	3.24802	95.5	3.75983
5.	.19685	18.	.70866	31.	1.22047	44.	1.73228	57.	2.24409	70.	2.75590	83.	3.26771	96.	3.77952
5.5	.21653	18.5	.72834	31.5	1.24015	44.5	1.75196	57.5	2.26377	70.5	2.77558	83.5	3.28739	96.5	3.79920
6.	.23622	19.	.74803	32.	1.25984	45.	1.77165	58.	2.28346	71.	2.79527	84.	3.30708	97.	3.81889
6.5	.25590	19.5	.76771	32.5	1.27952	45.5	1.79133	58.5	2.30314	71.5	2.81495	84.5	3.32676	97.5	3.83857
7.	.27559	20.	.78740	33.	1.29921	46.	1.81102	59.	2.32283	72.	2.83464	85.	3.34645	98.	3.85826
7.5	.29527	20.5	.80708	33.5	1.31889	46.5	1.83070	59.5	2.34251	72.5	2.85432	85.5	3.36613	98.5	3.87794
8.	.31496	21.	.82677	34.	1.33858	47.	1.85039	60.	2.36220	73.	2.87401	86.	3.38682	99.	3.89763
8.5	.34464	21.5	.84645	34.5	1.35826	47.5	1.87007	60.5	2.38188	73.5	2.89369	86.5	3.40550	99.5	3.91731
9.	.35433	22.	.86614	35.	1.37795	48.	1.88976	61.	2.40157	74.	2.91338	87.	3.42519	100.	3.93700

English Metric System Equivalents



Length Equivalents

Unit	Millimeters	Centimeters	Inches	Feet	Yards	Meters
1 MILLIMETER =	1	.1	.03937	.003281	.001094	.001
1 CENTIMETER =	10	1	.3937	.032808	.010936	.01
1 INCH =	25.4001	2.54001	1	.083333	.027778	.025400
1 FOOT =	304.801	30.4801	12	1	.333333	.304801
1 YARD =	914.402	91.4402	36	3	1	.914402
1 METER =	1000	100	39.37	3.28083	1.09361	1
Unit	Feet	Yards	Meters	Rods	Furlongs	Miles (Statute)
1 ROD =	16.5	5.5	5.02921	1	.025 (1/40)	.003125 (1/320)
1 FURLONG =	660	220	201.168	40	1	.125 (1/8)
1 KILOMETER =	3280.8	1093.6	1000	199	4.971	.62137
1 MILE (STATUTE) =	5280	1760	1609.35	320	8	1

1 NAUTICAL MILE = 6080.2 FEET = 1.15155 STATUTE MILES = 1/2 LEAGUE.
1 LIGHT YEAR = 5.879 TRILLION MILES = 9.46 TRILLION KILOMETERS.

Weight Equivalents

Unit	Grains	Grams	Ounces (Troy)	Ounces (Avoir.)	Pounds (Troy)	Pounds (Avoir.)	Kilograms
1 GRAIN =	1	.064799	.002083	.002286	.000174	.000143	.000065
1 GRAM =	15.4324	1	.032151	.035274	.002679	.002205	.001
1 OUNCE (TROY) =	480	31.1035	1	1.09714	.083333	.068571	.031104
1 OUNCE (AVOIR.) =	437.5	28.3495	.911458	1	.075955	.0625	.028350
1 POUND (TROY) =	5760	373.242	12	13.1657	1	.822857	.373242
1 POUND (AVOIR.) =	7000	453.592	14.5833	16	1.21528	1	.453592
1 KILOGRAM =	15432.4	1000	32.1507	35.2740	2.67923	2.20462	1
Unit	Kilograms	Pounds (Troy)	Pounds (Avoir.)	Metric Tons	Net (Short) Tons	Gross (Long) Tons	
1 METRIC TON =	1000	2679.23	2204.62	1	1.10231	.984206	
1 NET (SHORT) TON =	907.185	2430.56	2000	.907185	1	.892857	
1 GROSS (LONG) TON =	1016.05	2722.22	2240	1.01605	1.12	1	

Volume and Capacity Equivalents

Unit	Cubic Centimeters	Cubic Inches	Liters	Quarts (Liquid)	Quarts (Dry)	Gallons (Liquid)	Gallons (Dry)	Cubic Feet
1 CU. CENTIMETER =	1	.06102	.001	.00106	.00091	.00026	.00023	.00004
1 CU. INCH =	16.387	1	.01639	.01732	.01488	.00433	.00372	.00058
1 GILL =	118.29	7.2188	.11829	.125	.10742	.03125	.02686	.00418
1 PINT (LIQUID) =	473.18	28.875	.47318	.5	.42968	.125	.10742	.01671
1 PINT (DRY) =	550.62	33.600	.55062	.58182	.5	.14546	.125	.01945
1 LITER =	1000	61.023	1	1.0567	.90808	.26417	.22702	.03531
1 QUART (LIQUID) =	946.36	57.75	.94636	1	.85937	.25	.21484	.03342
1 QUART (DRY) =	1101.2	67.201	1.1012	1.1637	1	.29091	.25	.03889
1 GALLON (LIQUID) =	3785.4	231	3.7854	4	3.4375	1	.85937	.13368
1 GALLON (DRY) =	4404.9	268.80	4.4049	4.6546	4	1.1636	1	.15556
1 PECK =	8809.8	537.61	8.8098	9.3092	8	2.3273	2	.31111
1 CU. FOOT =	28317.0	1728	28.317	29.922	25.714	7.4805	6.4285	1
1 BUSHEL =	35239.3	2150.4	35.239	37.237	32	9.3092	8	1.2445
1 BARREL =	119241.2	7276.5	119.24	126	108.28	31.5	27.070	4.2109
1 CU. YARD =	764559.4	46656	764.56	807.90	694.28	201.97	173.57	27
1 CU. METER =	1000000	61023.4	1000	1056.7	908.08	264.17	227.02	35.314



English Metric System Equivalents

Area Equivalents

Unit	Square Inches	Square Feet	Square Yards	Square Meters
1 SQUARE FOOT =	144	1	.1111	.09290
1 SQUARE YARD =	1296	9	1	.83613
1 SQUARE METER =	1550	10.7639	1.19599	1
1 SQUARE ROD =	39204	272.25	30.25	25.293
1 ARE =	155000	1076.39	119.599	100
1 ACRE =	6272640	43560	4840	4046.86
1 SQUARE MILE (640 ACRES) =	-	27878400	3097600	2589999
1 SQUARE KILOMETER =	-	10763867	1195985	1000000

Power Equivalents

Unit	BTU/Hour	Foot-Pound/Hour	Foot-Pound/Minute	HP	HP (Metric)	Watt	Kilowatt
1 BTU/HR. =	1	778.1688	12.96948	.000393	.000398	.293071	.000293
1 FT.LB./HR. =	.001285	1	-	5.05x10 ⁻⁷	5.12x10 ⁻⁷	.0003766	3.766x10 ⁻⁷
1 FT.LB./MIN. =	.077104	-	1	3.0303x10 ⁻⁶	3.072x10 ⁻⁷	.022597	2.26x10 ⁻⁶
1 HP =	2544.43	1980000	33000	1	1.01387	745.699	.7457
1 HP MET. =	2509.622	1952914	32548.56	.986320	1	735.499	.735499
1 WATT =	3.41214	2655.224	44.2537	.0013410	.0013596	1	.001

NOTE: Foot-Pounds indicates energy.
Pound-Feet indicates torque (Page M-2).

Metric System

Length

1 meter (m)	=	{	10 decimeters(dm)
			100 centimeters(cm)
			1,000 millimeters(mm)
1 dekameter (dkm)	=		10 meters (m)
1 hectometer (hm)	=		100 meters (m)
1 kilometer (km)	=		1,000 meters (m)

Weight

1 gram (g)	=	{	10 decigrams (dg)
			100 centigrams (cg)
			1,000 milligrams (mg)
1 dekagram (dkg)	=		10 grams (g)
1 hectogram (hg)	=		100 grams (g)
1 kilogram (kg)	=		1000 grams (g)
1 metric ton	=	{	1000 kilograms (kg)
			1,000,000 grams (g)

Volume & Capacity

1 liter (l)	=	{	1 cubic decimeter(dm ³)
			10 deciliters (dl)
			100 centiliters(cl)
			1,000 milliliters (ml)
			1,000 cubic centimeters (cm ³ or cc)
1 dekaliter (dkl)	=		10 liters (l)
1 hectoliter (hl)	=		100 liters (l)
1 kiloliter (kl)	=	{	1 cubic meter (m ³)
			1 stere (s)
			1,000 liters (l)

Area

1 centare (ca)	=	{	1 square meter (m ²)
			100 square decimeters (dm ²)
			10,000 square centimeters (cm ²)
			1,000,000 square millimeters (mm ²)
1 are (a)	=	{	1 square dekameter (dkm ²)
			100 square meters (m ²)
			100 ares (a)
1 hectare (ha)	=	{	10,000 square meters (m ²)
1 square kilometer (km ²)	=		1,000,000 square meters (m ²)

Other prefixes commonly used:

micro — one millionth
deca — 10 times (same as deka)
myria — 10,000 times
mega — 1,000,000 times

Engineering Formulas and Constants

Circle

Area = Square of Diameter x .7854
or square of Radius x 3.1416

Circumference = Diameter x 3.1416

Diameter = Circumference x .3183

Doubling diameter increases area four times; tripling diameter increases area nine times, etc.

Square

Area = Square of Side

Diagonal = Side x 1.4142

Side = Diagonal x .7071

Square Inscribed in Circle

Side of Square = Diameter of Circle x .7071
or Circumference of Circle x .2251

Diameter of Circle = Side of Square x 1.4142

Circumference of Circle = Side of Square x 4.4429

Square and Circle with Equal Area

Side of Square = Diameter of Circle x .8862

Diameter of Circle = Side of Square x 1.128

Circumference of Circle = Side of Square x 3.545

Rectangle

Area = Length x Width

Diagonal = Square root of sum of squares of Width and Length

Triangle

Area = Base x $\frac{1}{2}$ of Perpendicular Height

Sphere

Area of Surface = Square of Diameter x 3.1416

Volume = Cube of Diameter x .5236

Cube

Area of Surface = Square of Side x 6

Volume = Cube of Side

Diagonal = Side x 1.732

Cylinder

Area of Curved Surface = Diameter x Length x 3.1416

Volume = Square of Diameter x Length x .7854

Cone

Area of Curved Surface = Diameter of Base x Slant Height x 1.5708

Volume = Diameter of Base Squared x Perpendicular Height x .2618 or Area of Base x $\frac{1}{3}$ Perpendicular Height

1 HP = 33,000 Foot-pounds of work per minute.
1 BTU = Heat required to raise 1 pound of water °F.
1 Kilowatt Hour = 3415 BTU
1 Radian = 57.296 degrees.
1 Register Ton = 100 cubic feet
1 U.S. Shipping Ton = 40 cubic feet
1 British Shipping Ton = 42 cubic feet
1 Cubic Foot/Minute = 471.9474 cubic cm/second
1 Cubic Foot/Minute = .1246753 gallons (U.S.)/second
1 Cubic Foot/Second = 2.2222 cubic yards/minute
1 Gallon (U.S.)/Minute = 8.020834 cubic feet/hour
1 Gallon (U.S.)/Minute = 3.785412 liter/minute
1 Liter/Minute = 2.118880 cubic feet/hour
1 Cubic Metre/Minute = 264.1720 Gallons (U.S.)/Minute
1 Pound/Gallon (U.S.) = 7.480519 pound/cubic feet
1 Mile/Hour = 88 feet/minute
1 Foot/Minute = .01136364 miles/hour

1 Pound per Square Inch Pressure (PSI) = 144 pounds/square foot = 2.3095 feet fresh water at 62°F = 2.0355 inches mercury at 32°F = 2.0416 inches mercury at 62°F = .068 atmospheres.
Water Pressure (pounds per square inch) = .433 x height of water in feet (Fresh water at 62°F).
Weight of 1 cubic foot of fresh water = 62.355 pounds at 62°F = 59.76 pounds at 212°F.
Weight of 1 gallon (U.S.) water = 8.34 pounds
Weight of 1 cubic foot of Air at 14.7 lbs per square inch Pressure = .07608 pounds at 62°F = .08703 pounds at 32°F.
Watts = Amperes x Volts
1 Watt-Hour = 3.41214 BTU = 859.845 Calorie = 3600 Joule.
g = Acceleration due to gravity at Sea Level, Latitude 45° = 32.1726 Feet/Second squared.
1 pound-foot (torque) = 1.355818 Newton-Metre.



Area/Circumference Table

Circumferences and Areas of Circles (1 — 31 $\frac{1}{8}$ Diameters)

Diameter	Circumference	Area	Diameter	Circumference	Area	Diameter	Circumference	Area	Diameter	Circumference	Area
1	3.1416	0.7854	$\frac{1}{2}$	17.2788	23.758	14	43.9823	153.94	23	72.2566	415.48
$\frac{1}{16}$	3.3379	0.8866	$\frac{5}{16}$	17.4751	24.301	$\frac{1}{8}$	44.3750	156.70	$\frac{1}{8}$	72.6493	420.00
$\frac{1}{8}$	3.5343	0.9940	$\frac{3}{8}$	17.6715	24.850	$\frac{1}{4}$	44.7677	159.48	$\frac{1}{4}$	73.0420	424.56
$\frac{3}{16}$	3.7306	1.1075	$\frac{1}{2}$	17.8678	25.406	$\frac{3}{8}$	45.1604	162.30	$\frac{3}{8}$	73.4347	429.13
$\frac{1}{4}$	3.9270	1.2272	$\frac{3}{4}$	18.0642	25.967	$\frac{1}{2}$	45.5531	165.13	$\frac{1}{2}$	73.8274	433.74
$\frac{5}{16}$	4.1233	1.3530	$\frac{13}{16}$	18.2605	26.535	$\frac{5}{8}$	45.9458	167.99	$\frac{5}{8}$	74.2201	438.36
$\frac{3}{8}$	4.3197	1.4849	$\frac{7}{8}$	18.4569	27.100	$\frac{3}{4}$	46.3385	170.87	$\frac{3}{4}$	74.6128	443.01
$\frac{1}{2}$	4.5160	1.6230	$\frac{15}{16}$	18.6532	27.688	$\frac{7}{8}$	46.7312	173.78	$\frac{7}{8}$	75.0055	447.69
$\frac{1}{2}$	4.7124	1.7671	6	18.8496	28.274	15	47.1239	176.71	24	75.3982	452.39
$\frac{5}{16}$	4.9087	1.9175	$\frac{1}{8}$	19.2423	29.465	$\frac{1}{8}$	47.5166	179.67	$\frac{1}{8}$	75.7909	457.11
$\frac{3}{8}$	5.1051	2.0739	$\frac{1}{4}$	19.6350	30.680	$\frac{1}{4}$	47.9093	182.65	$\frac{1}{4}$	76.1836	461.86
$\frac{1}{4}$	5.3014	2.2365	$\frac{3}{8}$	20.0277	31.919	$\frac{3}{8}$	48.3020	185.66	$\frac{3}{8}$	76.5763	466.64
$\frac{5}{16}$	5.4978	2.4053	$\frac{1}{2}$	20.4204	33.183	$\frac{1}{2}$	48.6947	188.69	$\frac{1}{2}$	76.9690	471.44
$\frac{3}{8}$	5.6941	2.5802	$\frac{3}{4}$	20.8131	34.472	$\frac{5}{8}$	49.0874	191.75	$\frac{5}{8}$	77.3617	476.26
$\frac{1}{2}$	5.8905	2.7612	$\frac{7}{8}$	21.2058	35.785	$\frac{3}{4}$	49.4801	194.83	$\frac{3}{4}$	77.7544	481.11
$\frac{5}{16}$	6.0868	2.9483	$\frac{15}{16}$	21.5984	37.122	$\frac{7}{8}$	49.8728	197.93	$\frac{7}{8}$	78.1471	485.98
2	6.2832	3.1416	7	21.9911	38.485	16	50.2655	201.06	25	78.5398	490.87
$\frac{1}{16}$	6.4795	3.3410	$\frac{1}{8}$	22.3838	39.871	$\frac{1}{8}$	50.6582	204.22	$\frac{1}{8}$	78.9325	495.79
$\frac{1}{8}$	6.6759	3.5466	$\frac{1}{4}$	22.7765	41.282	$\frac{1}{4}$	51.0509	207.39	$\frac{1}{4}$	79.3252	500.74
$\frac{3}{16}$	6.8722	3.7583	$\frac{3}{8}$	23.1692	42.718	$\frac{3}{8}$	51.4436	210.60	$\frac{3}{8}$	79.7179	505.71
$\frac{1}{4}$	7.0686	3.9761	$\frac{1}{2}$	23.5619	44.179	$\frac{1}{2}$	51.8363	213.82	$\frac{1}{2}$	80.1106	510.71
$\frac{5}{16}$	7.2649	4.2000	$\frac{3}{4}$	23.9546	45.664	$\frac{5}{8}$	52.2290	217.08	$\frac{5}{8}$	80.5033	515.72
$\frac{3}{8}$	7.4613	4.4301	$\frac{7}{8}$	24.3473	47.173	$\frac{3}{4}$	52.6217	220.35	$\frac{3}{4}$	80.9060	520.77
$\frac{1}{2}$	7.6576	4.6664	$\frac{15}{16}$	24.7400	48.707	$\frac{7}{8}$	53.0144	223.65	$\frac{7}{8}$	81.2887	525.84
$\frac{1}{2}$	7.8540	4.9087	8	25.1327	50.265	17	53.4071	226.98	26	81.6814	530.93
$\frac{5}{16}$	8.0503	5.1572	$\frac{1}{8}$	25.5254	51.849	$\frac{1}{8}$	53.7998	230.33	$\frac{1}{8}$	82.0741	536.05
$\frac{3}{8}$	8.2467	5.4119	$\frac{1}{4}$	25.9181	53.456	$\frac{1}{4}$	54.1925	233.71	$\frac{1}{4}$	82.4668	541.19
$\frac{1}{4}$	8.4430	5.6727	$\frac{3}{8}$	26.3108	55.088	$\frac{3}{8}$	54.5852	237.10	$\frac{3}{8}$	82.8595	546.35
$\frac{5}{16}$	8.6394	5.9396	$\frac{1}{2}$	26.7035	56.745	$\frac{1}{2}$	54.9779	240.53	$\frac{1}{2}$	83.2522	551.55
$\frac{3}{8}$	8.8357	6.2126	$\frac{3}{4}$	27.0962	58.426	$\frac{5}{8}$	55.3706	243.98	$\frac{5}{8}$	83.6449	556.76
$\frac{1}{2}$	9.0321	6.4918	$\frac{7}{8}$	27.4889	60.132	$\frac{3}{4}$	55.7633	247.45	$\frac{3}{4}$	84.0376	562.00
$\frac{5}{16}$	9.2284	6.7771	$\frac{15}{16}$	27.8816	61.862	$\frac{7}{8}$	56.1560	250.95	$\frac{7}{8}$	84.4303	567.27
3	9.4248	7.0686	9	28.2743	63.617	18	56.5487	254.47	27	84.8230	572.56
$\frac{1}{16}$	9.6211	7.3662	$\frac{1}{8}$	28.6670	65.397	$\frac{1}{8}$	56.9414	258.02	$\frac{1}{8}$	85.2157	577.87
$\frac{1}{8}$	9.8175	7.6699	$\frac{1}{4}$	29.0597	67.201	$\frac{1}{4}$	57.3341	261.59	$\frac{1}{4}$	85.6084	583.21
$\frac{3}{16}$	10.0138	7.9798	$\frac{3}{8}$	29.4524	69.029	$\frac{3}{8}$	57.7268	265.18	$\frac{3}{8}$	86.0011	588.57
$\frac{1}{4}$	10.2102	8.2958	$\frac{1}{2}$	29.8451	70.882	$\frac{1}{2}$	58.1195	268.80	$\frac{1}{2}$	86.3938	593.96
$\frac{5}{16}$	10.4065	8.6179	$\frac{3}{4}$	30.2378	72.760	$\frac{5}{8}$	58.5122	272.45	$\frac{5}{8}$	86.7865	599.37
$\frac{3}{8}$	10.6029	8.9462	$\frac{7}{8}$	30.6305	74.662	$\frac{3}{4}$	58.9049	276.12	$\frac{3}{4}$	87.1792	604.81
$\frac{1}{2}$	10.7992	9.2806	$\frac{15}{16}$	31.0232	76.589	$\frac{7}{8}$	59.2976	279.81	$\frac{7}{8}$	87.5719	610.27
$\frac{1}{2}$	10.9956	9.6211	10	31.4159	78.540	19	59.6903	283.53	28	87.965	615.75
$\frac{5}{16}$	11.1919	9.9678	$\frac{1}{8}$	31.8086	80.516	$\frac{1}{8}$	60.0830	287.27	$\frac{1}{8}$	88.357	621.26
$\frac{3}{8}$	11.3883	10.321	$\frac{1}{4}$	32.2013	82.516	$\frac{1}{4}$	60.4757	291.04	$\frac{1}{4}$	88.750	626.80
$\frac{1}{4}$	11.5846	10.680	$\frac{3}{8}$	32.5940	84.541	$\frac{3}{8}$	60.8684	294.83	$\frac{3}{8}$	89.143	632.36
$\frac{5}{16}$	11.7810	11.045	$\frac{1}{2}$	32.9867	86.590	$\frac{1}{2}$	61.2611	298.65	$\frac{1}{2}$	89.535	637.94
$\frac{3}{8}$	11.9773	11.416	$\frac{3}{4}$	33.3794	88.664	$\frac{5}{8}$	61.6538	302.49	$\frac{5}{8}$	89.928	643.55
$\frac{1}{2}$	12.1737	11.793	$\frac{7}{8}$	33.7721	90.763	$\frac{3}{4}$	62.0465	306.35	$\frac{3}{4}$	90.321	649.18
$\frac{5}{16}$	12.3700	12.177	$\frac{15}{16}$	34.1648	92.886	$\frac{7}{8}$	62.4392	310.24	$\frac{7}{8}$	90.713	654.84
4	12.5664	12.566	11	34.5575	95.033	20	62.8319	314.16	29	91.106	660.52
$\frac{1}{16}$	12.7627	12.962	$\frac{1}{8}$	34.9502	97.205	$\frac{1}{8}$	63.2246	318.10	$\frac{1}{8}$	91.499	666.23
$\frac{1}{8}$	12.9591	13.364	$\frac{1}{4}$	35.3429	99.402	$\frac{1}{4}$	63.6173	322.06	$\frac{1}{4}$	91.892	671.96
$\frac{3}{16}$	13.1554	13.772	$\frac{3}{8}$	35.7356	101.62	$\frac{3}{8}$	64.0100	326.05	$\frac{3}{8}$	92.284	677.71
$\frac{1}{4}$	13.3518	14.185	$\frac{1}{2}$	36.1283	103.87	$\frac{1}{2}$	64.4026	330.06	$\frac{1}{2}$	92.677	683.49
$\frac{5}{16}$	13.5481	14.607	$\frac{3}{4}$	36.5210	106.14	$\frac{5}{8}$	64.7953	334.10	$\frac{5}{8}$	93.070	689.30
$\frac{3}{8}$	13.7445	15.033	$\frac{7}{8}$	36.9137	108.43	$\frac{3}{4}$	65.1880	338.16	$\frac{3}{4}$	93.462	695.13
$\frac{1}{2}$	13.9408	15.466	$\frac{15}{16}$	37.3064	110.75	$\frac{7}{8}$	65.5807	342.25	$\frac{7}{8}$	93.855	700.98
$\frac{1}{2}$	14.1372	15.904	12	37.6991	113.10	21	65.9734	346.36	30	94.248	706.86
$\frac{5}{16}$	14.3335	16.349	$\frac{1}{8}$	38.0918	115.47	$\frac{1}{8}$	66.3661	350.50	$\frac{1}{8}$	94.640	712.70
$\frac{3}{8}$	14.5299	16.800	$\frac{1}{4}$	38.4845	117.86	$\frac{1}{4}$	66.7588	354.66	$\frac{1}{4}$	95.033	718.69
$\frac{1}{4}$	14.7262	17.257	$\frac{3}{8}$	38.8772	120.28	$\frac{3}{8}$	67.1515	358.84	$\frac{3}{8}$	95.426	724.64
$\frac{5}{16}$	14.9226	17.721	$\frac{1}{2}$	39.2699	122.72	$\frac{1}{2}$	67.5442	363.05	$\frac{1}{2}$	95.819	730.62
$\frac{3}{8}$	15.1189	18.190	$\frac{3}{4}$	39.6626	125.19	$\frac{5}{8}$	67.9369	367.28	$\frac{5}{8}$	96.211	736.62
$\frac{1}{2}$	15.3153	18.665	$\frac{7}{8}$	40.0553	127.68	$\frac{3}{4}$	68.3296	371.54	$\frac{3}{4}$	96.604	742.64
$\frac{5}{16}$	15.5116	19.147	$\frac{15}{16}$	40.4480	130.19	$\frac{7}{8}$	68.7223	375.83	$\frac{7}{8}$	96.997	748.69
5	15.7080	19.635	13	40.8407	132.73	22	69.1150	380.13	31	97.389	754.77
$\frac{1}{16}$	15.9043	20.129	$\frac{1}{8}$	41.2334	135.30	$\frac{1}{8}$	69.5077	384.46	$\frac{1}{8}$	97.782	760.87
$\frac{1}{8}$	16.1007	20.629	$\frac{1}{4}$	41.6261	137.89	$\frac{1}{4}$	69.9004	388.82	$\frac{1}{4}$	98.175	766.99
$\frac{3}{16}$	16.2970	21.135	$\frac{3}{8}$	42.0188	140.50	$\frac{3}{8}$	70.2931	393.20	$\frac{3}{8}$	98.567	773.14
$\frac{1}{4}$	16.4934	21.648	$\frac{1}{2}$	42.4115	143.14	$\frac{1}{2}$	70.6858	397.61	$\frac{1}{2}$	98.960	779.31
$\frac{5}{16}$	16.6897	22.166	$\frac{3}{4}$	42.8042	145.80	$\frac{5}{8}$	71.0785	402.04	$\frac{5}{8}$	99.353	785.51
$\frac{3}{8}$	16.8861	22.691	$\frac{7}{8}$	43.1969	148.49	$\frac{3}{4}$	71.4712	406.49	$\frac{3}{4}$	99.746	791.73
$\frac{1}{2}$	17.0824	23.221	$\frac{15}{16}$	43.5896	151.20	$\frac{7}{8}$	71.8639	410.97	$\frac{7}{8}$	100.138	797.98

Trigonometric Functions

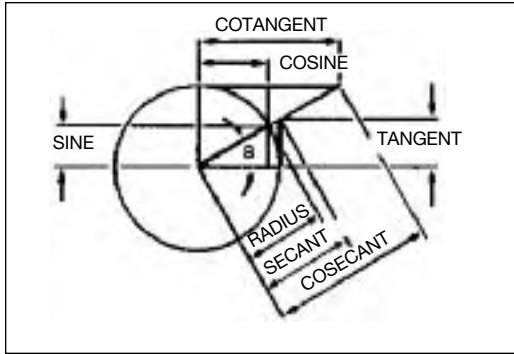

Trigonometric Formulas (See pages that follow for functions)

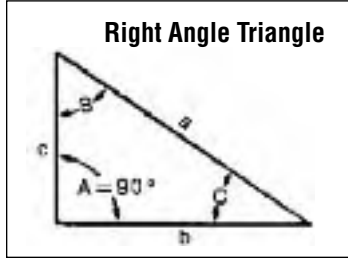

Formulas for Finding Functions of Angles

$$\frac{\text{Side Opposite}}{\text{Hypotenus e}} = \text{Sine}$$

$$\frac{\text{Side Adjacent}}{\text{Hypotenus e}} = \text{Cosine}$$

$$\frac{\text{Side Opposite}}{\text{Side Adjacent}} = \text{Tangent}$$

$$\frac{\text{Side Adjacent}}{\text{Side Opposite}} = \text{Cotangent}$$

$$\frac{\text{Hypotenus e}}{\text{Side Adjacent}} = \text{Secant}$$

$$\frac{\text{Hypotenus e}}{\text{Side Opposite}} = \text{Cosecant}$$

Formulas for Finding Sides of Right Angle Triangles with an Angle and Side Known

To Find: Length of side opposite

$$\left\{ \begin{array}{l} \text{Hypotenus e} \times \text{Sine} \\ \text{Hypotenus e} \div \text{Cosecant} \\ \text{Side Adjacent} \times \text{Tangent} \\ \text{Side Adjacent} \div \text{Cotangent} \end{array} \right.$$

To Find: Length of side adjacent

$$\left\{ \begin{array}{l} \text{Hypotenus e} \times \text{Cosine} \\ \text{Hypotenus e} \div \text{Secant} \\ \text{Side Opposite} \times \text{Cotangent} \\ \text{Side Opposite} \div \text{Tangent} \end{array} \right.$$

To Find: Length of hypotenus e

$$\left\{ \begin{array}{l} \text{Side Opposite} \times \text{Cosecant} \\ \text{Side Opposite} \div \text{Sine} \\ \text{Side Adjacent} \times \text{Secant} \\ \text{Side Adjacent} \div \text{Cosine} \end{array} \right.$$

To Find Angles and Sides of Right Angle Triangles

To Find Angles		To Find Sides	
To Find:	Formulas	To Find:	Formulas
C	$\frac{c}{a} = \text{Sine } C$	a	$\sqrt{b^2 + c^2}$
C	$\frac{b}{a} = \text{Cosine } C$	a	$c \times \text{Cosec. } C$
C	$\frac{c}{b} = \text{Tan. } C$	a	$c \times \text{Secante } B$
C	$\frac{b}{c} = \text{Cotan. } C$	a	$b \times \text{Cosec. } B$
C	$\frac{a}{b} = \text{Secant } C$	a	$b \times \text{Secante } C$
C	$\frac{a}{c} = \text{Cosec. } C$	b	$\sqrt{a^2 - c^2}$
B	$\frac{b}{a} = \text{Sine } B$	b	$a \times \text{Sine } B$
B	$\frac{c}{a} = \text{Cosine } B$	b	$a \times \text{Cos. } C$
B	$\frac{b}{c} = \text{Tan. } B$	b	$c \times \text{Tan. } B$
B	$\frac{c}{b} = \text{Cotan. } B$	b	$c \times \text{Cot. } C$
B	$\frac{a}{c} = \text{Secant } B$	c	$\sqrt{a^2 - b^2}$
B	$\frac{a}{b} = \text{Cosec. } B$	c	$a \times \text{Cos. } B$
		c	$a \times \text{Sine } C$
		c	$b \times \text{Cot. } B$
		c	$b \times \text{Tan. } C$

To Find Angles and Sides of Oblique Angle Triangles

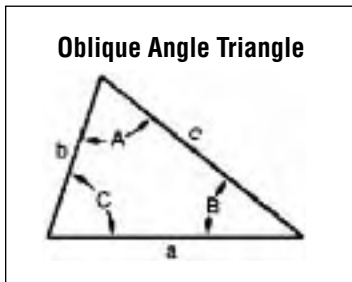

To Find	Known	Formulas	To Find	Known	Formulas
C	A, B	$180^\circ - (A + B)$	A	B, C	$180^\circ - (B + C)$
b	a, B, A	$\frac{a \times \text{Sin. } B}{\text{Sin. } A}$	Cos. A	a, b, c	$\frac{b^2 + c^2 - a^2}{2bc}$
c	a, A, C	$\frac{a \times \text{Sin. } C}{\text{Sin. } A}$	Sin. C	c, A, a	$\frac{c \times \text{Sin. } A}{a}$
Tan. A	a, C, b	$\frac{a \times \text{Sin. } C}{b - (a \times \text{Cos. } C)}$	Cot. B	a, C, b	$\frac{a \times \text{Cosec. } C}{b} - \text{Cot. } C$
B	A, C	$180^\circ - (A + C)$	c	b, C, B	$b \times \text{Sin. } C \times \text{Cosec. } B$
Sin. B	b, A, a	$\frac{b \times \text{Sin. } A}{a}$	—	—	—

Trigonometric Functions

°	'	Sine	Tan.	Cotan.	Cosine	°	'	°	'	Sine	Tan.	Cotan.	Cosine	°	'
0	0	.000000	.000000	INFINITE	1.000000	0	90	11	0	.190809	.194380	5.1445540	.981627	0	79
	10	.002909	.002909	343.77371	.999996	50			10	.913664	.197401	5.0658352	.981068	50	
	20	.005818	.005818	171.88540	.999983	40			20	.196517	.200425	4.9894027	.980500	40	
	30	.008727	.008727	114.58865	.999962	30			30	.199368	.203452	4.9151570	.979925	30	
	40	.011635	.011635	85.939791	.999932	20			40	.202218	.206483	4.8430045	.979341	20	
	50	.014544	.014544	68.750087	.999894	10			50	.205065	.209518	4.7728568	.978748	10	
1	0	.017452	.017455	57.289962	.999848	0	89	12	0	.207912	.212557	4.7046301	.978148	0	78
	10	.020361	.020365	49.103881	.999793	50			10	.210756	.215599	4.6382457	.977539	50	
	20	.023269	.023275	42.964077	.999729	40			20	.213599	.218645	4.5736287	.976921	40	
	30	.026177	.026186	38.188459	.999657	30			30	.216440	.221695	4.5107085	.976296	30	
	40	.029085	.029097	34.367771	.999577	20			40	.219279	.224748	4.4494181	.975662	20	
	50	.031992	.032009	31.241577	.999488	10			50	.222116	.227806	4.3896940	.975020	10	
2	0	.034899	.034921	28.636253	.999391	0	88	13	0	.224951	.230868	4.3314759	.974370	0	77
	10	.037806	.037834	26.431600	.999285	50			10	.227784	.233934	4.2747066	.973712	50	
	20	.040713	.040747	24.541758	.999171	40			20	.230616	.237004	4.2193318	.973045	40	
	30	.043619	.043661	22.903766	.999048	30			30	.233445	.240079	4.1652998	.972370	30	
	40	.046525	.046576	21.470401	.998917	20			40	.236273	.243158	4.1125614	.971687	20	
	50	.049431	.049491	20.205553	.998778	10			50	.239098	.246241	4.0610700	.970995	10	
3	0	.052336	.052408	19.081137	.998630	0	87	14	0	.241922	.249328	4.0107809	.970296	0	76
	10	.055241	.055325	18.074977	.998473	50			10	.244743	.252420	3.9616518	.969588	50	
	20	.058145	.058243	17.169337	.998308	40			20	.247563	.255517	3.9136420	.968872	40	
	30	.061049	.061163	16.349855	.998135	30			30	.250380	.258618	3.8667131	.968148	30	
	40	.063952	.064083	15.604784	.997957	20			40	.253195	.261723	3.8208281	.967415	20	
	50	.066854	.067004	14.924417	.997763	10			50	.256008	.266483	3.7759519	.966675	10	
4	0	.069756	.069927	14.300666	.997564	0	86	15	0	.258819	.267949	3.7320508	.965926	0	75
	10	.072658	.072851	13.726738	.997357	50			10	.261628	.271069	3.6890927	.965169	50	
	20	.075559	.075776	13.196888	.997141	40			20	.264434	.274195	3.6470467	.964404	40	
	30	.078459	.078702	12.706205	.996917	30			30	.267238	.277325	3.6058835	.963630	30	
	40	.081359	.081629	12.250505	.996685	20			40	.270040	.280460	3.5655749	.962849	20	
	50	.084258	.084558	11.826167	.996444	10			50	.272840	.283600	3.5260938	.962059	10	
5	0	.087156	.087489	11.430052	.996195	0	85	16	0	.275637	.286745	3.4874144	.961262	0	74
	10	.090053	.090421	11.059431	.995937	50			10	.278432	.289896	3.4495120	.960456	50	
	20	.092950	.093354	10.711913	.995671	40			20	.281225	.293052	3.4123626	.959642	40	
	30	.095846	.096289	10.385397	.995396	30			30	.284015	.296214	3.3759434	.958820	30	
	40	.098741	.099226	10.078031	.995113	20			40	.286803	.299380	3.3402326	.957990	20	
	50	.101635	.102164	9.7881732	.994822	10			50	.289589	.302553	3.3052091	.957151	10	
6	0	.104528	.105104	9.5143645	.994522	0	84	17	0	.292372	.305731	3.2708526	.956305	0	73
	10	.107421	.108046	9.2553035	.994214	50			10	.295152	.308914	3.2371438	.955450	50	
	20	.110313	.110990	9.0098261	.993897	40			20	.297930	.312104	3.2040638	.954588	40	
	30	.113203	.113936	8.7768874	.993572	30			30	.300706	.315299	3.1715948	.953717	30	
	40	.116093	.116883	8.5555468	.993238	20			40	.303479	.318500	3.1397194	.952838	20	
	50	.118982	.119833	8.3449558	.992896	10			50	.306249	.321707	3.1084210	.951951	10	
7	0	.121869	.122785	8.1443464	.992546	0	83	18	0	.309017	.324920	3.0776835	.951057	0	72
	10	.124756	.125738	7.9530224	.992187	50			10	.311782	.328139	3.0474915	.950154	50	
	20	.127642	.128694	7.7703506	.991820	40			20	.314545	.331364	3.0178301	.949243	40	
	30	.130526	.131653	7.5957541	.991445	30			30	.317305	.334595	2.9886850	.948324	30	
	40	.133410	.134613	7.4287064	.991061	20			40	.320062	.337833	2.9600422	.947397	20	
	50	.136292	.137576	7.2687255	.990669	10			50	.322816	.341077	2.9318885	.946462	10	
8	0	.139173	.140541	7.1153697	.990268	0	82	19	0	.325568	.344328	2.9042109	.945519	0	71
	10	.142053	.143508	6.9682335	.989859	50			10	.328317	.347585	2.8769970	.944568	50	
	20	.144932	.146478	6.8269437	.989442	40			20	.331063	.350848	2.8502349	.943609	40	
	30	.147809	.149451	6.6911562	.989016	30			30	.333807	.354119	2.8239129	.942641	30	
	40	.150686	.152426	6.5605538	.988582	20			40	.336547	.357396	2.7980198	.941666	20	
	50	.153561	.155404	6.4348428	.988139	10			50	.339285	.360680	2.7725448	.940684	10	
9	0	.156434	.158384	6.3137515	.987688	0	81	20	0	.342020	.363970	2.7474774	.939693	0	70
	10	.159307	.161368	6.1970279	.987229	50			10	.344752	.367268	2.7228076	.938694	50	
	20	.162178	.164354	6.0844381	.986762	40			20	.347481	.370573	2.6985254	.937687	40	
	30	.165048	.167343	5.9757644	.986286	30			30	.350207	.373885	2.6746215	.936672	30	
	40	.167916	.170334	5.8708042	.985801	20			40	.352931	.377204	2.6510867	.935650	20	
	50	.170783	.173329	5.7693688	.985309	10			50	.355651	.380530	2.6279121	.934619	10	
10	0	.173648	.176327	5.6712818	.984808	0	80	21	0	.358368	.383864	2.6050891	.933580	0	69
	10	.176512	.179328	5.5763786	.984298	50			10	.361082	.387205	2.5826094	.932534	50	
	20	.179375	.182332	5.4845052	.983781	40			20	.363793	.390554	2.5604649	.931480	40	
	30	.182236	.185339	5.3955172	.983255	30			30	.366501	.393911	2.5386479	.930418	30	
	40	.185095	.188359	5.3092793	.982721	20			40	.369206	.397275	2.5171507	.929348	20	
	50	.187953	.191363	5.2256647	.982178	10	79		50	.371908	.400647	2.4959661	.928270	10	68
°	'	Cosine	Cotan.	Tan.	Sine	°	'	°	'	Cosine	Cotan.	Tan.	Sine	°	'

NOTE: For functions from 45°-0' to 68° read from bottom of table upward.

Trigonometric Tables



Trigonometric Functions

°	'	Sine	Tan.	Cotan.	Cosine	°	'	°	'	Sine	Tan.	Cotan.	Cosine	°	'
22	0	.374607	.404026	2.4750869	.927184	0	68	34	0	.559193	.674509	1.4825610	.829038	0	56
	10	.377302	.407414	2.4545061	.926090	50			10	.561602	.678749	1.4732983	.827407	50	
	20	.379994	.410810	2.4342172	.924980	40			20	.564007	.683007	1.4641147	.825770	40	
	30	.382683	.414214	2.4142136	.923880	30			30	.566406	.687281	1.4550090	.824126	30	
	40	.385369	.417626	2.3944889	.922762	20			40	.568801	.691573	1.4459801	.822475	20	
	50	.388052	.421046	2.3750372	.921638	10			50	.571191	.695881	1.4370268	.820817	10	
23	0	.390731	.424475	2.3558524	.920505	0	67	35	0	.573576	.700208	1.4281480	.819152	0	55
	10	.393407	.427912	2.3369287	.919364	50			10	.575957	.704552	1.4193427	.817480	50	
	20	.396080	.431358	2.3182606	.918216	40			20	.578332	.708913	1.4106098	.815801	40	
	30	.398749	.434812	2.2998425	.917060	30			30	.580703	.713293	1.4019483	.814116	30	
	40	.401415	.438276	2.2816693	.915896	20			40	.583069	.717691	1.3933571	.812423	20	
	50	.404078	.441748	2.2637357	.914725	10			50	.585429	.722108	1.3848355	.810723	10	
24	0	.406737	.445229	2.2460368	.913545	0	66	36	0	.587785	.726543	1.3763810	.809017	0	54
	10	.409392	.448719	2.2285676	.912358	50			10	.590136	.730996	1.3679959	.807304	50	
	20	.412045	.452218	2.2113234	.911164	40			20	.592482	.735469	1.3596764	.805584	40	
	30	.414693	.455726	2.1942997	.909961	30			30	.594823	.739961	1.3514224	.803857	30	
	40	.417338	.459244	2.1774920	.908751	20			40	.597159	.744472	1.3432331	.802123	20	
	50	.419980	.462771	2.1608958	.907533	10			50	.599489	.749003	1.3351075	.800383	10	
25	0	.422618	.466308	2.1445069	.906308	0	65	37	0	.601815	.753554	1.3270448	.798636	0	53
	10	.425253	.469854	2.1283213	.905075	50			10	.604136	.758125	1.3190441	.796882	50	
	20	.427884	.473410	2.1123348	.903834	40			20	.606451	.762716	1.3111046	.795121	40	
	30	.430511	.476976	2.0965436	.902585	30			30	.608761	.767327	1.3032254	.793353	30	
	40	.433125	.480551	2.0809438	.901329	20			40	.611067	.771959	1.2954057	.791579	20	
	50	.435755	.484137	2.0655318	.900065	10			50	.613367	.776612	1.2876447	.789798	10	
26	0	.438371	.487733	2.0503038	.898794	0	64	38	0	.615661	.781286	1.2799416	.788011	0	52
	10	.440984	.491339	2.0352565	.897515	50			10	.617951	.785981	1.2722957	.786217	50	
	20	.443593	.494955	2.0203862	.896229	40			20	.620235	.790698	1.2647062	.784416	40	
	30	.446197	.498582	2.0056897	.894934	30			30	.622515	.795436	1.2571723	.782608	30	
	40	.448799	.502219	1.9911637	.893633	20			40	.624789	.800196	1.2496933	.780794	20	
	50	.451397	.505867	1.9768050	.892323	10			50	.627057	.804980	1.2422685	.778973	10	
27	0	.453990	.509525	1.9626105	.891007	0	63	39	0	.629320	.809784	1.2348972	.777146	0	51
	10	.456580	.513195	1.9485772	.889682	50			10	.631578	.814612	1.2275786	.775312	50	
	20	.459166	.516876	1.9347020	.888350	40			20	.633831	.819463	1.2203121	.773472	40	
	30	.461749	.520567	1.9209821	.887011	30			30	.636078	.824336	1.2130970	.771625	30	
	40	.464327	.524270	1.9074147	.885664	20			40	.638320	.829234	1.2059327	.769771	20	
	50	.466901	.527984	1.8939971	.884309	10			50	.640557	.834155	1.1988184	.767911	10	
28	0	.469472	.531709	1.8807265	.882948	0	62	40	0	.642788	.839100	1.1917536	.766044	0	50
	10	.472038	.535547	1.8676003	.881578	50			10	.645013	.844069	1.1847376	.764171	50	
	20	.474600	.539395	1.8546159	.880201	40			20	.647233	.849062	1.1777698	.762292	40	
	30	.477149	.543256	1.8417709	.878817	30			30	.649448	.854081	1.1708496	.760406	30	
	40	.479713	.547128	1.8290628	.877425	20			40	.651657	.859124	1.1639763	.758514	20	
	50	.482263	.550515	1.8164892	.876026	10			50	.653861	.864193	1.1571495	.756615	10	
29	0	.484810	.554309	1.8040478	.874620	0	61	41	0	.656059	.869287	1.1503684	.754710	0	49
	10	.487352	.558118	1.7917362	.873206	50			10	.658252	.874407	1.1436326	.752798	50	
	20	.489890	.561939	1.7795524	.871784	40			20	.660439	.879553	1.1369414	.750880	40	
	30	.492424	.565773	1.7674940	.870356	30			30	.662620	.884725	1.1302944	.748956	30	
	40	.494953	.569619	1.7555590	.868920	20			40	.664796	.889924	1.1236909	.747025	20	
	50	.497479	.573478	1.7437453	.867476	10			50	.666966	.895151	1.1171305	.745088	10	
30	0	.500000	.577350	1.7320508	.866025	0	60	42	0	.669131	.900404	1.1106125	.743145	0	48
	10	.502517	.581235	1.7204736	.864567	50			10	.671289	.905685	1.1041365	.741195	50	
	20	.505030	.585134	1.7090116	.863102	40			20	.673443	.910994	1.0977020	.739239	40	
	30	.507538	.589045	1.6976631	.861629	30			30	.675590	.916331	1.0913085	.737277	30	
	40	.510043	.592970	1.6864261	.860149	20			40	.677732	.921697	1.0849554	.735309	20	
	50	.512543	.596908	1.6752988	.858662	10			50	.679868	.927021	1.0786423	.733335	10	
31	0	.515038	.600861	1.6642795	.857167	0	59	43	0	.681998	.932515	1.0723687	.731354	0	47
	10	.517529	.604827	1.6533663	.855665	50			10	.684123	.937968	1.0661341	.729367	50	
	20	.520016	.608807	1.6425576	.854156	40			20	.686242	.943451	1.0599381	.727374	40	
	30	.522499	.612801	1.6318517	.852640	30			30	.688355	.948965	1.0537801	.725374	30	
	40	.524977	.616809	1.6212469	.851117	20			40	.690462	.954508	1.0476598	.723369	20	
	50	.527450	.620832	1.6107417	.849586	10			50	.692563	.960083	1.0415767	.721357	10	
32	0	.529919	.624869	1.6003345	.848048	0	58	44	0	.694658	.965689	1.0355303	.719340	0	46
	10	.532384	.628921	1.5900238	.846503	50			10	.696748	.971326	1.0295203	.717316	50	
	20	.534844	.632988	1.5798079	.844951	40			20	.698832	.976996	1.0235461	.715286	40	
	30	.537300	.637079	1.5696856	.843391	30			30	.700909	.982697	1.0176074	.713251	30	
	40	.539751	.641167	1.5596552	.841825	20			40	.702981	.988432	1.0117088	.711209	20	
	50	.542197	.645280	1.5497155	.840251	10			50	.705047	.994199	1.0058348	.709161	10	
33	0	.544639	.649408	1.5398650	.838671	0	57	45	0	.707107	1.000000	1.0000000	.707107	0	45
	10	.547076	.653551	1.5301025	.837083	50			10	—	—	—	—	50	
	20	.549509	.657710	1.5204261	.835488	40			20	—	—	—	—	40	
	30	.551937	.661886	1.5108352	.833886	30			30	—	—	—	—	30	
	40	.554360	.666077	1.5013282	.832277	20			40	—	—	—	—	20	
	50	.556769	.670285	1.4919039	.830661	10	56	—	—	—	—	—	—	10	
°	'	Cosine	Cotan.	Tan.	Sine	°	'	°	'	Cosine	Cotan.	Tan.	Sine	°	'

NOTE: For functions from 45°-0' to 68° read from bottom of table upward.

Given	Multiply By	To Find
ABAMPERE	10	AMPERE
ACRES	0.4046856	HECTARE
ACRES	43560	SQUARE FEET
ACRES	4046.8564	SQUARE METERS
ACRES	1.562x10 ⁻³	SQUARE MILES
ARE	1076.391	SQUARE FEET
ATMOSPHERES	76	CMS. OF MERCURY
ATMOSPHERES	33.89854	FEET OF WATER
ATMOSPHERES	29.92	INCHES OF MERCURY
ATMOSPHERES	14.69595	POUNDS/SQUARE INCH
BAGS - CEMENT	94	POUNDS - CEMENT
BARRELS - OIL	5.614583	CUBIC FOOT
BARRELS - OIL	158.9873	LITER
BARRELS - OIL	42	GALLONS - OIL
BARRELS (US DRY)	3.281219	BUSHEL (US)
BARRELS (US DRY)	4.083333	CUBIC FEET
BARRELS (US DRY)	115.6271	LITER
BARRELS (US LIQ.)	4.2109375	CUBIC FEET
BARRELS (US LIQ.)	0.1192405	CUBIC METERS
BARRELS (US LIQ.)	26.22925	GALLONS (BRIT.)
BARRELS (US LIQ.)	31.5	GALLONS (US)
BARRELS - CEMENT	376	POUNDS - CEMENT
BTU	251.996	CALORIE
BTU	778.169	FOOT - POUNDS - FORCE
BTU	3.9302x10 ⁻⁴	HORSEPOWER - HOURS
BTU	0.252	KILOGRAM - CALORIES
BTU	107.586	KILOGRAM - METERS
BTU	2.9307x10 ⁻⁴	KILOWATT - HOURS
BTU	1055.056	JOULE
BTU/MIN.	12.96	FOOT - POUNDS/SEC.
BTU/MIN.	0.0235809	HORSEPOWER
BTU/MIN.	0.0175843	KILOWATTS
BTU/MIN.	17.5796	WATTS
BUSHEL (BRIT.)	1.032057	BUSHEL (US)
BUSHEL (BRIT.)	8	GALLONS (BRIT.)
BUSHEL (US)	0.3047647	BARREL (US DRY)
BUSHEL (US)	1.244456	CUBIC FEET
BUSHEL (US)	9.309177	GALLONS (US LIQ.)
CALORIE	4.1868	JOULE
CALORIE	3.96832x10 ⁻³	BTU
CALORIE	3.08803	FOOT - POUND - FORCE
CENTARES (CENTIARES)	1	SQUARE METERS
CENTIMETERS	0.3937008	INCHES
CENTIMETERS	.3937008	INCH
CENTIMETERS	0.01	METERS
CENTIMETERS	10	MILLIMETERS
CENTIMTRS. OF MERCURY	0.01316	ATMOSPHERES
CENTIMTRS. OF MERCURY	0.4461	FEET OF WATER
CENTIMTRS. OF MERCURY	136	KGS./SQUARE METER
CENTIMTRS. OF MERCURY	27.85	POUNDS/SQUARE FT.
CENTIMTRS. OF MERCURY	0.1934	POUNDS/SQUARE INCH
CENTIPOISE	0.001	PASCAL - SECOND
CHAIN (RAMSDEN'S)	100	FEET
CHAIN (GUNTER'S)	66	FEET
CORD	128	CUBIC FEET
CORD	3.624	STERE
COULOMB	1	AMPERE - SECOND
CUBIC CENTIMETER	0.06102	CUBIC INCHES
CUBIC CENTIMETER	0.001	LITER
CUBIC CENTIMETER	1	MILLILETER
CUBIC DECIMETER	0.0353	CUBIC FEET
CUBIC FEET	12	BOARD FEET
CUBIC FEET	0.803564	BUSHEL (US)
CUBIC FEET	1728	CUBIC INCHES
CUBIC FEET	0.0283168	CUBIC METERS
CUBIC FEET	28.317	CUBIC DECIMETERS
CUBIC FEET	0.037037	CUBIC YARD
CUBIC FEET	6.228835	GALLONS (BRIT.)
CUBIC FEET	7.480519	GALLONS (US)
CUBIC FEET	28.316847	LITERS
CUBIC FEET	25.71405	QUARTS (US DRY)
CUBIC FEET/HOUR	7.865791	CUBIC CM./SEC.
CUBIC FEET/HOUR	0.4719474	LITER/MIN.
CUBIC FEET/MIN.	0.1246753	GALLONS (US)/SEC.
CUBIC FEET/POUND	0.0624279	CUBIC METER/KILOGRAM
CUBIC METER	8.64849	BARREL (US DRY)

Given	Multiply By	To Find
CUBIC METER	8.386414	BARREL (US LIQ.)
CUBIC METER	35.31467	CUBIC FEET
CUBIC METER	1.307951	CUBIC YARDS
CUBIC METER	264.1721	GALLONS (US)
CUBIC METER	1000	LITER
CUBIC YARDS	27	CUBIC FEET
CUBIC YARDS	0.7645548	CUBIC METER
CUBIC YARDS	201.974	GALLONS (US)
CUBIC YARDS/MIN.	0.45	CUBIC FEET/SEC.
CUBIC YARDS/MIN.	3.366234	GALLONS (US)/SEC.
CUBIT	18	INCH
CUP	236.588	MILLILITER
CUP (METRIC)	200	MILLILITER
DEGREE	0.017453	RADIAN
DEGREE/SEC.	0.166667	REVOLUTION/MIN.
DENIER	0.11111(1/9)	TEX
DRACHM (BRIT. FLUID)	0.9607599	DRAM (U.S. FLUID)
DRAM (APOTH)	60	GRAINS
DRAM (AVOIR)	27.34375	GRAINS
DRAM (U.S. FLUID)	0.2255859	CUBIC INCHES
ELL	45	INCH
ERG	1x10 ⁷	JOULE
FATHOM	6	FEET
FEET OF WATER	0.0295	ATMOSPHERES
FEET OF WATER	0.8826	INCHES OF MERCURY
FEET OF WATER	304.8	KGS./SQUARE METER
FEET OF WATER	62.43	POUNDS/SQUARE FT.
FEET OF WATER	0.4335	POUNDS/SQUARE INCH
FEET/MIN.	0.508	CENTIMETERS/SEC.
FEET/MIN.	0.01667	FEET/SEC.
FEET/MIN.	0.01829	KILOMETERS/HOUR
FEET/MIN.	0.3048	METERS/MIN
FEET/MIN.	0.01136	MILES/HOUR
FEET/SEC.	30.48	CENTIMETERS/SEC.
FEET/SEC.	1.097	KILOMETERS/HOUR
FEET/SEC.	0.5921	KNOTS
FEET/SEC.	18.29	METERS/MIN.
FEET/SEC.	0.6818	MILES/HOUR
FEET/SEC.	0.01136	MILES/MIN.
FERKIN (US)	9	GALLONS (US) DRY
FOOT	30.48	CENTIMETER
FOOT	12	INCH
FOOT/MINUTE	0.3048	METER
FOOT/MINUTE	0.018288	KILOMETER/HOUR
FOOT/SECOND	0.01136364	MILE/HOUR
FOOT/SECOND	0.3048	METER/SECOND
FOOT - POUNDS - FORCE	0.6818182	MILE/HOUR
FOOT - POUNDS - FORCE	5.050x10 ⁻⁷	HORSEPOWER - HOURS
FOOT - POUNDS - FORCE	1.35582	JOULES
FOOT - POUNDS - FORCE	3.241x10 ⁻⁴	KILOGRAM - CALORIES
FOOT - POUNDS - FORCE	0.1383	KILOGRAM - METERS
FOOT - POUNDS - FORCE	.766x10 ⁻⁵	KILOWATT - HOURS
FOOT - POUNDS - FORCE	1.286x10 ⁻³	BTU
FOOT - POUNDS/MIN.	1.286x10 ⁻³	BTU/MIN.
FOOT - POUNDS/MIN.	0.01667	FOOT - POUNDS/SEC.
FOOT - POUNDS/MIN.	3.030x10 ⁻⁴	HORSEPOWER
FOOT - POUNDS/MIN.	3.241x10 ⁻⁴	KG. - CALORIES/MIN.
FOOT - POUNDS/MIN.	2.260x10 ⁻⁵	KILOWATTS
FOOT - POUNDS/SEC.	7.717x10 ⁻²	BTU/MIN.
FOOT - POUNDS/SEC.	1.818x10 ⁻³	HORSEPOWER
FOOT - POUNDS/SEC.	1.945x10 ⁻²	KG. - CALORIES/MIN.
FOOT - POUNDS/SEC.	1.355818	WATTS
FURLONG	660	FEET
FURLONG	10	CHAIN
GALLON (BRIT.)	9.632619	CUBIC FT./HOUR
GALLON (BRIT.)	0.2727654	CUBIC METER/HOUR
GALLONS (US)/MIN.	8.020834	CUBIC FEET/HOUR
GALLONS (US)/MIN.	0.2271247	CUBIC METER/HOUR
GALLON (DRY)	268.8025	CUBIC INCH
GALLONS (LIQ.)	3785.412	CUBIC CENTIMETERS
GALLONS (LIQ.)	0.1336805	CUBIC FEET
GALLONS (LIQ.)	231	CUBIC INCHES
GALLONS (LIQ.)	3.785x10 ⁻³	CUBIC METERS
GALLONS (LIQ.)	4.951x10 ⁻³	CUBIC YARDS
GALLONS (LIQ.)	0.8326742	GALLONS (BRIT.)
GALLONS (LIQ.)	3.785412	LITERS

Conversion Tables

Given	Multiply By	To Find
GALLONS (LIQ.)	8	PINTS (LIQ.)
GALLONS (LIQ.)	4	QUARTS (LIQ.)
GALLONS WATER	8.3453	POUNDS OF WATER
GALLONS WATER/MIN.	6.0086	TONS WATER/24 HOURS
GALLONS - IMPERIAL	1.20095	U.S. GALLONS
GALLONS - U.S.	0.83267	IMPERIAL GALLONS
GALLONS (US)/MIN.	2.228x10 ⁻³	CUBIC FEET/SEC.
GALLONS (US)/MIN.	8.020834	CUBIC FEET/HOUR
GALLONS (US)/MIN.	0.06308	Litros/SEC.
GILL	7.21875	CUBIC INCH
GILL	4	OUNCE (U.S.)
GILL (BRIT.)	1.20095	GILL (U.S.)
GRAINS (TROY)	0.0648	GRAMS
GRAINS/U.S. GAL.	17.118	PARTS/MILLION
GRAINS/U.S. GAL.	142.86	POUNDS/MILLION GAL.
GRAINS/U.S. GAL.	14.254	PARTS/MILLION
GRAMS	980.7	DYNES
GRAMS	15.432358	GRAINS
GRAMS	10 ⁻³	KILOGRAMS
GRAMS	10 ³	MILLIGRAMS
GRAMS	0.0352739	OUNCES
GRAMS	0.03215	OUNCES (TROY)
GRAMS	2.205x10 ⁻³	POUNDS
GRAMS	0.7716179	SCRUPLE
GRAMS (TROY)	2.0833x10 ⁻³	OUNCES (TROY)
GRAMS/CM.	5.600x10 ⁻³	POUNDS/INCH
GRAMS/CU. CM.	62.43	POUNDS/CUBIC FOOT
GRAMS/CU. CM.	0.03613	POUNDS/CUBIC INCH
GRAMS/LITER	58.417	GRAINS/GAL.
GRAMS/LITER	8.345	POUNDS/1000 GALS.
GRAMS/LITER	0.062427	POUNDS/CUBIC FOOT
GRAMS/LITER	1000	PARTS/MILLION
GROSS	12	DOZEN
HAND	4	INCH
HECTARE	2.471054	ACRE
HECTARE	107639.1	SQUARE FT.
HOGSHEAD	63	GALLONS
HORSEPOWER	42.4072	BTU/MIN.
HORSEPOWER	33000	FOOT - POUNDS/MIN.
HORSEPOWER	550	FOOT - POUNDS/SEC.
HORSEPOWER	1.014	HORSEPOWER (METRIC)
HORSEPOWER	10.7	KG. - CALORIES/MIN.
HORSEPOWER	0.7457	KILOWATTS
HORSEPOWER	745.7	WATTS
HORSEPOWER (BOILER)	33479	BTU/HOUR
HORSEPOWER (BOILER)	9.8095	KILOWATT
HORSEPOWER - HOURS	2547	BTU
HORSEPOWER - HOURS	1.98x10 ⁶	FOOT - POUNDS
HORSEPOWER - HOURS	641.7	KILOGRAM - CALORIES
HORSEPOWER - HOURS	2.737x10 ⁵	KILOGRAM - METERS
HORSEPOWER - HOURS	0.7457	KILOWATT - HOURS
INCH	1000	MILS
INCH	25.4	MILLIMETERS
INCHES OF MERCURY	0.03342	ATMOSPHERES
INCHES OF MERCURY	1.133	FEET OF WATER
INCHES OF MERCURY	345.3	KGS./SQUARE METER
INCHES OF MERCURY	70.73	LBS./SQUARE FT.
INCHES OF MERCURY	0.4912	LBS./SQUARE INCH
INCHES OF WATER	0.002458	ATMOSPHERES
INCHES OF WATER	0.07355	INCHES OF MERCURY
INCHES OF WATER	25.4	KGS./SQUARE METER
INCHES OF WATER	0.5781	OUNCES/SQUARE INCH
INCHES OF WATER	5.202	POUNDS/SQUARE FOOT
INCHES OF WATER	0.03613	POUNDS/SQUARE INCH
JOULE	0.000948	BTU
JOULE	0.238846	CALORIE
KILOGRAMS	980665	DYNES
KILOGRAMS	2.2046226	POUNDS
KILOGRAMS	1.102x10 ⁻³	TONS (SHORT)
KILOGRAMS	10 ³	GRAMS
KILOGRAMS - CALORIES	3.968	BTU
KILOGRAMS - CALORIES	3086	FOOT - POUNDS
KILOGRAMS - CALORIES	1.558x10 ⁻³	HORSEPOWER - HOURS
KILOGRAMS - CALORIES	1.162x10 ⁻³	KILOWATT - HOURS
KILOMETERS	10 ³	CENTIMETERS
KILOMETERS	3280.84	FEET

Given	Multiply By	To Find
KILOMETERS	10 ³	METERS
KILOMETERS	0.6213712	MILES
KILOMETROS	1094	YARDS
KILOMETERS/HOUR	27.78	CENTIMETERS/SEC.
KILOMETERS/HOUR	54.68	FEET/MIN.
KILOMETERS/HOUR	0.9113	FEET/SEC.
KILOMETERS/HOUR	0.5396	KNOTS
KILOMETERS/HOUR	16.67	METERS/MIN.
KILOMETROS/HOUR	0.6214	MILES/HOUR
KILOWATT - HOURS	3415	BTU
KILOWATT - HOURS	2.655x106	FOOT - POUNDS
KILOWATT - HOURS	1.341	HORSEPOWER - HOURS
KILOWATT - HOURS	3.6x10 ⁶	JOULE
KILOWATT - HOURS	860.5	KILOGRAM - CALORIES
KILOWATT - HOURS	3.671x10 ⁶	KILOGRAM - METERS
KILOWATTS	56.869	BTU/MIN.
KILOWATTS	44253.7	FOOT - POUNDS/MIN.
KILOWATTS	737.6	FOOT - POUNDS/SEC.
KILOWATTS	1.34102	HORSEPOWER
KILOWATTS	14.3308	KG. - CALORIES/MIN.
KILOWATTS	10 ⁻³	WATTS
KNOTS	1.150779	MILES (STATUTE)/HOUR
LEAGUE (STATUTE)	3	MILES (STATUTE)
LIGHT YEAR	5.8785x10 ¹²	MILES
LINK	0.01	CHAIN
LINK	7.92	INCHES
LITERS	10 ³	CUBIC CENTIMETERS
LITERS	0.03531	CUBIC FEET
LITERS	61.02	CUBIC INCHES
LITERS	10 ⁻³	CUBIC METERS
LITERS	1.308x10 ⁻³	CUBIC YARDS
LITERS	0.2642	GALLONS
LITERS	2.113	PINTS (LIQ.)
LITERS	0.908	QUARTS (DRY)
LITERS	1.0567	QUARTS (LIQ.)
LITERS/MIN.	5.886x10 ⁻⁴	CUBIC FT./SEC.
LITERS/MIN.	13.19815	GALLON (BRIT.)/HOUR
LITERS/MIN.	4.403x10 ⁻³	GALLONS/SEC.
LITERS/SEC.	2.11888	CUBIC FT./MIN.
METERS	100	CENTIMETERS
METERS	3.2808399	FEET
METERS	39.37	INCHES
METERS	10 ⁻³	KILOMETROS
METERS	10 ³	MILLIMETERS
METERS	1.093613	YARDS
METERS/MIN.	1.667	CENTIMETERS/SEC.
METERS/MIN.	3.281	FEET/MIN.
METERS/MIN.	0.05468	FEET/SEC.
METERS/MIN.	0.06	KILOMETROS/HOUR
METERS/MIN.	0.03728	MILES/HOUR
METERS/SEC.	196.8	FEET/MIN.
METERS/SEC.	3.281	FEET/SEC.
METERS/SEC.	3.6	KILOMETER/HOUR
METERS/SEC.	0.06	KILOMETROS/MIN.
METERS/SEC.	2.236936	MILES/HOUR
METERS/SEC.	0.03728	MILES/MIN.
MIL	0.001	INCH
MIL	0.0254	MILLIMETER
MILES	320	ROD
MILES	1.609x10 ⁵	CENTIMETERS
MILES	5280	FEET
MILES	1.609	KILOMETROS
MILES	1760	YARDS
MILES/HOUR	44.7	CENTIMETERS/SEC.
MILES/HOUR	88	FEET/MIN.
MILES/HOUR	1.467	FEET/SEC.
MILES/HOUR	1.609	KILOMETROS/HOUR
MILES/HOUR	0.8684	KNOTS
MILES/HOUR	26.82	Metros/MIN.
MILES/HOUR	1.609344	KILOMETROS/HOUR
MILES/HOUR	0.8689762	KNOTS
MILES/MIN.	2682	CENTIMETERS/SEC.
MILES/MIN.	88	FEET/SEC.
MILES/MIN.	1.609	KILOMETROS/MIN.
MILES/MIN.	60	MILES/HOUR
MILLIGRAMS	10 ⁻³	GRAMS

Given	Multiply By	To Find
MILLIGRAMS/LITER	1	PARTS/MILLION
MILLILITERS	0.0610237	CUBIC INCH
MILLILITERS	0.0338142	FLUID OUNCES
MILLILITERS	10 ⁻³	LITERS
MILLIMETERS	0.1	CENTIMETERS
MILLIMETERS	0.03937	INCHES
MILLION GALS./DAY	1.54723	CUBIC FT./SEC.
MINER'S INCHES	1.5	CUBIC FT./MIN.
MINUTES (ANGLE)	2.909x10 ⁻⁴	RADIANS
NEWTON - METER	0.737562	FOOT - POUNDS - FORCE
OUNCES	16	DRAMS
OUNCES	437.5	GRAINS
OUNCES	0.0625	POUNDS
OUNCES	28.349527	GRAMS
OUNCES	0.9115	OUNCES (TROY)
OUNCES	2.790x10 ⁻⁵	TONS (LONG)
OUNCES	2.835x10 ⁻⁵	TONS (METRIC)
OUNCES (FLUID)	1.805	CUBIC INCHES
OUNCES (FLUID)	0.02957	LITERS
OUNCES (FLUID)	30	MILLILITERS
OUNCES (FLUID)	1.040843	OUNCES (BRIT. FLUID)
OUNCES (TROY)	480	GRAINS
OUNCES (TROY)	20	PENNYWEIGHTS (TROY)
OUNCES (TROY)	0.08333	POUNDS (TROY)
OUNCES (TROY)	31.103481	GRAMS
OUNCES (TROY)	1.09714	OUNCES (AVOIR.)
OUNCES/SQUARE INCH	0.0625	POUNDS/SQUARE INCH
PACE	2.5	FEET
PALM	3	INCH
PARTS/MILLION	0.0584	GRAINS/U.S. GAL.
PARTS/MILLION	0.07016	GRAINS/IMP. GAL.
PARTS/MILLION	8.345	POUNDS/MILLION GAL.
PASCAL	0.0208854	POUNDS - FORCE/SQ. FT.
PECK (BRIT.)	2	GALLON (BRIT)
PECKS (US)	8	QUARTS (US DRY)
PENNYWEIGHTS (TROY)	24	GRAINS
PENNYWEIGHTS (TROY)	1.55517	GRAMS
PENNYWEIGHTS (TROY)	0.05	OUNCES (TROY)
PENNYWEIGHTS (TROY)	4.1667x10 ⁻³	POUNDS (TROY)
PERCH (MASONRY)	24.75	CUBIC FEET
POINT (U.S. -PRINT)	0.013837	INCH
POLE (BRIT.)	16.5	FEET
POTTLE (BRIT.)	.5	GALLONS
POUNDS	16	OUNCES
POUNDS	256	DRAMS
POUNDS	7000	GRAINS
POUNDS	0.0005	TONS (SHORT)
POUNDS	453.5924	GRAMS
POUNDS	1.21528	POUNDS (TROY)
POUNDS	14.5833	OUNCES (TROY)
POUNDS OF WATER	0.01602	CUBIC FEET
POUNDS OF WATER	27.68	CUBIC INCHES
POUNDS OF WATER	0.1198	GALLONS
POUNDS OF WATER/MIN.	2.670x10 ⁻⁴	CUBIC FT./SEC.
POUNDS (TROY)	5760	GRAINS
POUNDS (TROY)	140	PENNYWEIGHTS (TROY)
POUNDS (TROY)	12	OUNCES (TROY)
POUNDS (TROY)	373.24177	GRAMS
POUNDS (TROY)	0.822857	POUNDS (AVOIR.)
POUNDS (TROY)	13.1657	OUNCES (AVOIR.)
POUNDS (TROY)	3.6735x10 ⁻⁴	TONS (LONG)
POUNDS (TROY)	4.1143x10 ⁻⁴	TONS (SHORT)
POUNDS (TROY)	4.1667x10 ⁻³	TONS (METRIC)
POUNDS/CUBIC FOOT	0.01602	GRAMS/CUBIC CM.
POUNDS/CUBIC FOOT	16.02	KGS./CUBIC METERS
POUNDS/CUBIC FOOT	5.787x10 ⁻⁴	POUNDS/CUBIC INCH
POUNDS/CUBIC INCH	27.68	GRAMS/CUBIC CM.
POUNDS/CUBIC INCH	2.768x10 ⁴	KGS./CUBIC METER
POUNDS/CUBIC INCH	1728	POUNDS/CUBIC FOOT
POUNDS/FOOT	1.488	KGS./METER
POUNDS/INCH	178.6	GRAMS/CM.
POUNDS/SQUARE FOOT	0.01602	FEET OF WATER
POUNDS/SQUARE FOOT	4.883	KGS./SQUARE METER
POUNDS/SQUARE FOOT	6.945x10 ⁻³	POUNDS/SQUARE INCH
POUNDS/SQUARE INCH	0.068046	ATMOSPHERES
POUNDS/SQUARE INCH	2.307	FEET OF WATER

Given	Multiply By	To Find
POUNDS/SQUARE INCH	2.03602	INCHES OF MERCURY
POUNDS/SQUARE INCH	703.1	KGS./SQUARE METER
PSI	1	POUND - FORCE/SQ. IN.
PUNCHEON	84	GALLONS
PUNCHEON (BRIT.)	70	GALLON (BRIT.)
QUARTS (DRY)	0.03125	BUSHEL
QUARTS (DRY)	67.200625	CUBIC INCHES
QUARTS (DRY)	1.101	LITERS
QUARTS (LIQ)	57.75	CUBIC INCHES
QUARTS (LIQ)	0.9463	LITER
QUARTS (LIQ)	0.8326742	QUART (BRIT.)
QUARTS (LIQ)	0.859367	QUART (DRY)
QUINTAL, ARGENTINE	101.28	POUNDS
QUINTAL, BRAZIL	129.54	POUNDS
QUINTAL, CASTILE, PERU	101.43	POUNDS
QUINTAL, CHILE	101.41	POUNDS
QUINTAL, METRIC	220.46	POUNDS
QUINTAL, MEXICO	101.47	POUNDS
RADIANS	57.29578	DEGREES
RADIANS	3437.747	MINUTES
RADIANS	0.63662	QUADRANTS
RADIANS/SEC.	57.3	DEGREES/SEC.
RADIANS/SEC.	0.1592	REVOLUTIONS/SEC.
RADIANS/SEC.	9.549297	REVOLUTIONS/MIN.
REAMS	500	SHEETS
REVOLUTIONS	360	DEGREES
REVOLUTIONS	4	QUADRANTS
REVOLUTIONS	6.283	RADIANS
REVOLUTIONS/MIN.	6	DEGREES/SEC.
REVOLUTIONS/MIN.	0.1047	RADIANS/SEC.
REVOLUTIONS/MIN.	0.01667	REVOLUTIONS/SEC.
REVOLUTIONS/SEC.	360	DEGREES/SEC.
REVOLUTIONS/SEC.	6.283	RADIANS/SEC.
REVOLUTIONS/SEC.	60	REVOLUTIONS/MIN.
RODS	16.5	FEET
ROPE	20	FEET
SCRUPLE	20	GRAINS
SEAM (BRIT.)	64	GALLON (BRIT.)
SLUG	14.5939	KILOGRAMS
SPAN	9	INCHES
SQUARE CM.	10 ⁻⁴	SQUARE METERS
SQUARE CM.	100	SQUARE MILLIMETERS
SQUARE FEET	2.296x10 ⁻⁵	ACRES
SQUARE FEET	929	SQUARE CENTIMETERS
SQUARE FEET	144	SQUARE INCHES
SQUARE FEET	0.0929	SQUARE METERS
SQUARE FEET	3.587x10 ⁻³	SQUARE MILES
SQUARE FEET	1/4	SQUARE YARDS
SQUARE INCHES	6.452	SQUARE CENTIMETERS
SQUARE INCHES	6.944x10 ⁻³	SQUARE FEET
SQUARE INCHES	645.2	SQUARE MILLIMETERS
SQUARE KILOMETERS	247.1	ACRES
SQUARE KILOMETERS	10.76x10 ⁶	SQUARE FEET
SQUARE KILOME	10 ⁶	SQUARE METERS
SQUARE KILOMETERS	0.3861	SQUARE MILES
SQUARE KILOMETERS	1.196x10 ⁶	SQUARE YARDS
SQUARE METERS	2.471x10 ⁻⁴	ACRES
SQUARE METERS	10.76	SQUARE FEET
SQUARE METERS	3.861x10 ⁻⁷	SQUARE MILES
SQUARE METERS	1.196	SQUARE YARDS
SQUARE MILES	640	ACRES
SQUARE MILES	27.88x10 ⁶	SQUARE FEET
SQUARE MILES	2.59	SQUARE KILOMETERS
SQUARE MILES	3.098x10 ⁶	SQUARE YARDS
SQUARE MILLIMETERS	0.01	SQUARE CENTIMETERS
SQUARE MILLIMETERS	1.550x10 ⁻³	SQUARE INCHES
SQUARE YARDS	2.066x10 ⁻⁴	ACRES
SQUARE YARDS	9	SQUARE FEET
SQUARE YARDS	0.8361	SQUARE METERS
SQUARE YARDS	3.228x10 ⁻⁷	SQUARE MILES
STERE	1	CUBIC METER
STERE	0.2759	CORD
STONE	14	POUNDS
TABLESPOON	14.79	MILLILITERS
TEASPOON	5	MILLILITERS
TEMP.(oC.)+17.78	1.8	TEMP.(oF.)

Conversion Tables



Given	Multiply By	To Find
TEMP.(oF)-32	5/9	TEMP.(oC.)
THERM	100,000	BTU
TONS OF WATER/24 HRS.	83.333	POUNDS WATER/HOUR
TONS OF WATER/24 HRS.	0.16643	GALLONS/MIN.
TONS OF WATER/24 HRS.	1.3349	CUBIC FT./HOUR
TONS (LONG)	1016.0469	KILOGRAMS
TONS (LONG)	1.016047	TONS (METRIC)
TONS (LONG)	2240	POUNDS
TONS (LONG)	1.12	TONS (SHORT)
TONS (METRIC)	10 ³	KILOGRAMS
TONS (METRIC)	2205	POUNDS
TONS (SHORT)	2000	POUNDS
TONS (SHORT)	32000	OUNCES
TONS (SHORT)	907.18486	KILOGRAMS
TONS (SHORT)	2430.56	POUNDS (TROY)
TONS (SHORT)	0.89287	TONS (LONG)
TONS (SHORT)	29166	OUNCES (TROY)
TONS (SHORT)	0.90718	TONS (METRIC)

Given	Multiply By	To Find
WATT - HOUR	3600	JOULE
WATTS	0.05692	BTU/MIN.
WATTS	44.26	FOOT - POUNDS/MIN.
WATTS	0.7376	FOOT - POUNDS/SEC.
WATTS	1.341x10 ⁻³	HORSEPOWER
WATTS	0.01434	KG. - CALORIES/MIN.
WATTS	10 ⁻³	KILOWATTS
WATTS - HOURS	3.41214	BTU
WATTS - HOURS	2655	FOOT - POUNDS - FORCE
WATTS - HOURS	1.341x10 ⁻³	HORSEPOWER - HOURS
WATTS - HOURS	3600	JOULES
WATTS - HOURS	0.8605	KILOGRAM - CALORIES
WATTS - HOURS	367.1	KILOGRAM - Metros
WATTS - HOURS	10 ⁻³	KILOWATT - HOURS
YARDS	91.44	CENTIMETERS
YARDS	36	INCHES
YARDS	0.9144	Metros



Worldwide Locations

Through steady, planned expansion, *Martin* has developed a network of modern manufacturing and service centers.

The ever increasing demand for high quality *Martin* products from many industries and markets has been met by continuous modernization and expansion of manufacturing and marketing facilities. Now, with plants located in key industrial areas throughout the United States, *Martin* is able to produce and deliver quality products to best serve the needs of every market in virtually any quantity. Distributors are located in all fifty states and throughout the world to provide total product availability.

It's through this manufacturing and marketing organization that *Martin* makes good its claim of serving industry "wherever machinery is in motion and materials are on the move."



HEADQUARTERS - ARLINGTON, TX



ABILENE, TX



ARLINGTON, TX



ATLANTA, GA



BOSTON, MA



CHARLOTTE, NC



CHICAGO, IL



CLARKSVILLE, TX



DALLAS, TX



DANIELSVILLE, PA



DENVER, CO



DETROIT, MI



FT. WORTH, TX



HOUSTON, TX



KANSAS CITY, MO



LOS ANGELES, CA



MANSFIELD, TX



MINNEAPOLIS, MN



MONTPELIER, OH



PARAGOULD, AR



PORTLAND, OR



SACRAMENTO, CA



TAMPA, FL



WAYNE, NJ



AYR, CANADA



TORONTO, CANADA



TOLUCA, MEXICO



MONTERREY, MEXICO



INVENTORY: *Martin* delivers with incredible fill rates from one of its many facilities strategically located across North America.



SERVICE: *Martin* ships reborees and other alterations within hours - not days... MTO's in days - not weeks.



PEOPLE: When you call *Martin* you get a person, not voice mail. We are ready, able and willing to help...Now!

USA

General Offices Sales and Manufacturing Arlington, TX

3100 Sprocket Drive 76015-2898
P.O. Box 91588
Arlington, Texas 76015-0088
817-258-3000 (FAX 817-258-3333)

Sales and Manufacturing

Danielsville, PA
3376 Delps Road 18038
P.O. Box 267 • Danielsville, PA 18038-0267
610-837-1841 (FAX 610-837-7337)

Ft. Worth, TX (Conveyor, Sheave & Tool Divisions)

3600 McCart Ave.
Ft. Worth, TX 76110-4692
817-258-3000 (FAX 817-258-3173)

Montpelier, OH
350 S. Airport Road
Montpelier, OH 43543-9329
419-485-5515 (FAX 419-485-3565)

Sacramento, CA
1199 Vine Street
Sacramento, CA 95814-0426
916-441-7172 (FAX 916-441-4600)

Scottsdale, GA
3303 Church Street 30079-1395
P.O. Box 886 • Scottsdale, GA 30079-0886
404-292-8744 (FAX 404-292-7771)

Mini Manufacturing Centers

Boston, MA
357 Fortune Boulevard
Milford, MA 01757
508-634-3990 (FAX 508-634-3998)

Charlotte, NC
3901 Scott Futrell Drive
Charlotte, NC 28208-3539
704-394-9111 (FAX 704-394-9122)

Chicago, IL
1505 Birchwood Avenue
Des Plaines, IL 60018-3001
847-298-8844 (FAX 847-298-2967)

Denver, CO
10800 East 54th Avenue
Denver CO 80239
303-371-8466 (FAX 303-371-7116)

Detroit, MI
12555 Belden Ct.
Livonia, MI 48150
734-367-0238 (FAX 734-367-0547)

Houston, TX
9910 Bent Oak Drive
Houston, TX 77040
713-849-4330 (FAX 713-849-4807)

Kansas City, MO
1520 N. Commerce Avenue
Kansas City, MO 64120-4961
816-231-5575 (FAX 816-231-1959)

Los Angeles, CA
5920 S. Triangle Drive
Commerce, CA 90040-3639
323-728-8117 (FAX 323-722-7526)

Minneapolis, MN
10601 Hampshire Avenue South
Bloomington, MN 55438-2395
952-829-0623 (FAX 952-944-9385)

Portland, OR
3030 N.W. Industrial
Portland, OR 97210-1734
503-223-7261 (FAX 503-221-0203)

Tampa, FL
3201 Queen Palm Drive
Tampa FL 33619
813-623-1705 (FAX 813-626-8953)

Wayne, NJ
7 High Point Drive
Wayne, NJ 07470-7432
973-633-5700 (FAX 973-633-7196)

Manufacturing Only

Abilene, TX
Clarksville, TX
Dallas, TX
Mansfield, TX
Paragould, AR
(Includes the Plastics Div.)

CANADA

Sales and Manufacturing
Martin Sprocket & Gear Canada Inc.
896 Meyerside Drive
Mississauga, Ontario, Canada L5T 1R9
905-670-1991 (FAX 905-670-2110)

Martin Sprocket & Gear Canada Inc.
(Conveyor Division)
320 Darrell Drive, RR #1
Ayr, Ontario NOB 1E0
519-621-0546 (FAX 519-621-4413)
519-621-0546 (FAX 519-621-4413)

MEXICO

Martin Sprocket & Gear de Mexico, S.A. de C.V.
Km 52 Carretera, Naucalpan-Toluca
Calle 3, Manzana VII, Lote 11
Parque Industrial Toluca 2000
Toluca, Edo. de México 50200
+52 722 276 0800 (Fax: +52 722 276 0801)

Martin Sprocket & Gear de Mexico
Av. Industrial No. 100
Lote 6 y 7, Manzana 11
Parque Industrial La Silla Apodaca
Apodaca, N.L. 66600 (Monterrey)
+52 811 156 6830 (FAX +52 811 156 6833)

CONDITION OF SALE

CANCELLATION OR SUSPENSION: Cancellation or suspension of manufacturing or shipping date of any order will be accepted only on terms which will indemnify us against loss.

MADE-TO-ORDER SIZES AND OVERRUNS: Because in manufacturing it is necessary to make slightly more of any article than the exact amount specified, in order to offset losses and insure the required number of parts being produced, made-to-order items are subject to having a run of plus or minus 5% of the total order and may be shipped and invoiced without prior notice. The foregoing is not applicable to standard stock merchandise.

TAXES: Any sales, use, consumption, or other similar tax applicable to the sale, purchase, or use of product is not included in these prices and shall be paid by the purchaser.

"LIMITED WARRANTY": Subject to the limitation expressed in subsequent paragraphs, *Martin* Sprocket & Gear, Inc. and *Martin* Sprocket & Gear Canada Inc., make the following warranties: We warrant that each of our products of manufacture will be free from defects in material and workmanship under normal use and service for twelve months from the date of delivery to the original user. We will correct any such defects in material or workmanship by repair or replacement of the product F.O.B. our plant. Tools will carry the following lifetime warranty: If a *Martin* tool fails to satisfactorily perform its designated use, it may be returned to the *Martin* distributor from which such tool was purchased and will be repaired or replaced without cost.

THE FOREGOING WARRANTIES ARE EXPRESSLY IN LIEU OF ANY AND ALL REPRESENTATIONS, WARRANTIES AND CONDITIONS EXPRESSED OR IMPLIED, INCLUDING ANY IMPLIED WARRANTY OF MERCHANTABILITY OR FITNESS FOR A PARTICULAR PURPOSE WHETHER ARISING FROM STATUTE, COMMON LAW, CUSTOM, OR OTHERWISE. THE REMEDY OF REPAIR OR REPLACEMENT OF THE DEFECTIVE PRODUCT OR TOOL SET FORTH IN THE FOREGOING WARRANTIES SHALL BE THE EXCLUSIVE REMEDY AVAILABLE TO ANY PERSON.

Charges for correcting defects will not be allowed, nor can we accept goods returned to us for repair or replacement, unless we are previously notified of the defect in writing and the return or correction is authorized by us in writing. All warranty claims alleging defects of materials or workmanship must be submitted in writing within thirty days of the discovery of a defect or such claim shall be considered waived. (This paragraph is subject to the provisions of the Consumer Protection laws of Mexico.)

The foregoing warranties shall not apply to any products or tools which have been subjected to misuse, neglect or accident, or have been altered or tampered with, or have been used beyond their normal useful or expected life, or which have had corrective work done thereon without our written consent. WE SHALL NOT BE LIABLE FOR ANY LOSS, INJURY, EXPENSE, OR DAMAGE, WHETHER DIRECT, CONSEQUENTIAL, INCIDENTAL, OR OTHERWISE, RESULTING FROM THE USE OF OUR PRODUCTS OR TOOLS OR CAUSED BY ANY DEFECT, FAILURE, OR MALFUNCTION OF ANY PRODUCT OR TOOL, WHETHER A CLAIM FOR SUCH DAMAGES IS BASED UPON WARRANTY, CONTRACT, NEGLIGENCE, OR OTHERWISE. Equipment manufactured by others, and included in our proposal, is not warranted in any way by us but carries only the manufacturer's warranty, if any. No person has the authority to bind us to any representation or warranty other than the foregoing limited warranties as disclaimed.

The provisions of the United Nations Convention on Contracts for the International Sale of Goods or any local statute declaring it to have the force of law in the jurisdiction of one of the parties shall not apply to Products supplied hereunder.

"YOU ARE HEREBY NOTIFIED THAT ANY ADDITIONAL OR DIFFERENT TERMS FROM THOSE CONTAINED IN THIS LIMITED WARRANTY ARE OBJECTIONABLE. NO ADDITIONS OR CHANGES ARE BINDING ON *Martin* UNLESS THEY ARE IN WRITING AND SIGNED BY AN AUTHORIZED OFFICER."

NOTE: All past due invoices shall be payable to *Martin* Sprocket & Gear, Inc., at P.O. Box 91588, Arlington, Tarrant County, Texas 76015-0088. All past due invoices of *Martin* Sprocket & Gear Canada Inc., shall be payable at 896 Meyerside Drive, Mississauga, Ontario, Canada L5T 1R9. Reasonable attorneys' fees will be added if collection is forced.

RETURNED MATERIAL: When it is desired to return material for credit or exchange, it is necessary that permission in writing first be obtained from the nearest office.

SHIPMENTS: If we are not able to meet your shipment requirements and/or our expected dates of shipment, we will not accept liability for delays beyond our control, nor will we accept cancellations unless a settlement has been agreed upon between us.

FREIGHT ALLOWANCE: Freight allowances are shown on the different product discount sheets. In cases where a specific routing of any order is more costly than the routing selected by us, the excess charges will be added to the net amount of the invoice. Weights shown in catalog are approximate, and may not be used to determine qualifications for freight allowance.

CASH DISCOUNT: 1% 10th and 25th Net 30 Days. A 1% cash discount will be allowed on invoices dated the 1st through the 15th if paid by the 25th of the same month and on invoices dated the 16th through the end of the month if payment is made by the 10th of the next month. All invoices are due in 30 days. Cash discount does not apply to other charges such as freight, postage, or delivery charges.

This catalog supersedes all previous editions. Every effort has been put forward to produce what we feel is the best power transmission catalog in the industry. However, due to changes in engineering and manufacturing processes and procedures, it becomes necessary, from time to time, to make alterations to products, and such alterations may not be reflected in this catalog. Therefore, if dimensions, specifications or appearances represented by pictures or drawings or tables are critical in their applications, please consult the factory for clarification or certified drawings.

Alphabetical Index

A

A Sprockets (See Sprocket Pitch)	
Accu-Torch® Sprockets	
(See Engineered Class & Mill Chain Sprockets)	Section F
Adjustable Wrenches	J-34
Air Operated Curved Slide Gate	H-120
Air Operated Flat-Slide Gates	H-119
Angular Discharges	H-119
ANSI Sprockets (See Sprockets)	
Auto Wrench Type, Adj	J-99

B

B Sprockets (See Sprocket Pitch)	
Bearing Shoes	H-117
Bevel Gears	G-46 – G-49
Formulas	G-91
Horsepower Ratings	G-49
Body and Fender Tools	J-104 – J-111
Adjustable File Holder	J-109
Body Files	J-109
Body Hammers	J-104 – J-105
Body Picks	J-108
Body Spoons	J-107
Dent Puller Tool	J-109
Dolly Blocks	J-106
Manual - The Key to Metal Bumping	J-109
Misc. Body Tools	J-109
Tool Sets	J-110 – J-111
Bolt Pads	H-117
Bored-To-Size Sprockets (See Sprocket Pitch)	
Box Wrench, 12 Pt. Single End	J-39
Box Wrench, Double Offset, Long	J-24 – J-25
Box Wrench, Double Offset, Short	J-24
Box Wrench, Striking Face	J-40 – J-41
Breaker Pins	H-116
Bucket Elevators	H-124 – H-143
Bucket Punching (Belt)	H-141
Buckets and Chain	H-140
Calculations for Numbers of Buckets	H-142
Data Sheet	H-176
Elevator Selection Procedure	H-128
Illustration	H-138
Introduction	H-126
Materials Table	H-129
Series 100 & 700 Belt & Chain Dimensions	H-139
Standard Features Series 100 & 700	H-127
Super Capacity Continuous Discharge Elevators	
Series SC700 Chain	H-137
Warning & Safety Reminder	H-125
Bucket Elevators Centrifugal Discharge	H-126
Mill Duty	H-126
Series 100 and 200 Belt	H-131
Series 100 and 200 Chain	H-130
Bucket Elevators Continuous Discharge	H-126
Series 100 and 200 Chain	H-132
Series 700 and 800 Chain	H-133
Super Capacity	H-126
Bucket Elevators High Speed Grain Centrifugal Discharge	

Series 500 Belt	H-143
Bucket Elevators Mill Duty Centrifugal Discharge	
Series DRB30 Belt	H-136
Series MDB30 Belt	H-135
Series MDC26 and MDC30 Chain	H-134
Bushings	B-2 – B-16
Idler	B-16
Index	B-1
MST® (<i>Martin</i> Split Taper®)	B-13 – B-15
QD (Quick Detachable)	B-2 – B-6
Stock Parts	B-2 – B-16
Taper Bushings	B-7 – B-12
1008 to 3030 Taper Bushings	B-8
3535 to 5050 Taper Bushings	B-9
6050 to 120100 Taper Bushings	B-10
Dimensions	B-8 – B-10
Instructions	B-7
Metric	B-12
Reborable	B-12
Weld-On Hubs	B-11
TB (Taper Bushed)	B-7 – B-12
Weld-On Hubs- QD, TB, MST®	B-5, B-11, B-15

C

“C” Clamps	J-99
C Sprockets (See Sprocket Pitch)	
Check Nut Wrench (Thin)	J-30
Chisel and Punch Sets	J-103
Chisels and Punches	J-101 – J-102
Circumferences / Areas of Circles	M-21
Close Coupled Conveyor Screw	H-118
Combination (Open-End and Box)	J-18 – J-21
Component Selection	H-52 – H-53
Cone Screw	H-115
Construction Wrenches	J-18 – J-21
Continuous Welding	H-116
Conversion Tables	M-25 – M-28
Conveyor Screws	H-79 – H-87
Conveyor Sprockets	A-6 – A-12
800 Conveyor Sprockets	A-6
815 Guide Rings - Steel and Stainless Steel	A-12
815 Sprockets - Semi-Steel - Bored-To-Size	A-11
815 Sprockets - Semi-Steel - Stock Bore	A-11
815 Sprockets - Split Steel	A-8
815 Sprockets - Split Thermoplastic	A-8
820 Sprockets - Semi-Steel - Bored-To-Size	A-10
820 Sprockets - Semi-Steel - Stock Bore	A-10
820 Sprockets - Split Steel	A-8
820 Sprockets - Split Thermoplastic	A-8
821 Sprockets - Semi-Steel - Stock Bore	A-9
880 Sprockets - Semi-Steel - Stock Bore	A-9
881 Sprockets - Semi-Steel - Stock Bore	A-9
882 Sprockets - Semi-Steel - Stock Bore	A-12
QRS® Split Sprocket	A-7
Conveyors	Section H
Hazardous Operations	H-121 – H-123
Installation and Erection	H-121 – H-123

Alphabetical Index (Continued)

Installation and Maintenance	H-121 – H-123
Operation and Maintenance	H-121 – H-123
Vertical Screw Elevators	H-155 – H-164
Warning and Safety Reminder	H-121 – H-123
Coupling Bolts	H-87
Couplings	Section C
Chain Couplings	C-25 – C-27
Comparison Chart	C-2
Index	C-1
Jaw Couplings	C-28 – C-30
Couplings (Continued)	
<i>Martin-Flex</i> ® Couplings	C-31 – C-32
Quadra-Flex® (Also See Quadra-Flex® Couplings)	C-4 – C-24
Selection Charts	C-9, C-27, C-32
Cover Accessories	H-105
Cover Gaskets	H-105
Custom Capabilities	A-14 – A-16
Castings	A-14
Forgings	A-14
Injection Molding	A-16
Sintered Metal	A-15
Cut & Folded Flight, Standard Pitch	H-79

D

Decimal Equivalent Chart	M-17
Deflection	H-30 – H-31
Detailing of Trough and Discharge Flanges	H-42
Discharges	H-119
Discharges & Gates	H-58
Discharges and Inlets	H-120
Double Flight, Short Pitch	H-116
Double Flight, Standard Pitch	H-79, H-116
Double Pitch Sprockets	E-13 – E-17
Double Single Sprockets (Also See Sprocket Pitch)	
MST® (<i>Martin</i> Split Taper®)	E-32, E-45, E-58, E-45, E-71, E-83
TB (Taper Bushed)	E-32, E-45, E-58, E-45, E-71, E-83
Type A	E-32, E-45, E-58, E-71, E-83, E-94, E-100, E-105
Drag Conveyors	H-144 – H-154
Flat Bottom	H-149 – H-152
L & S Path	H-153 – H-154
Round Bottom	H-146 – H-148
Safety Information	H-145
Drive Selection	
Bucket Elevator	H-176
Gears	G-80 – G-82
High HP HTS®	K-174 – K-192
HTS®	K-89 – K-168
Jaw Couplings	C-29
<i>Martin-Flex</i> ® Couplings	C-32
Quadra-Flex® Couplings	C-9
Roller Chain Couplings	C-27
Screw Conveyor	H-5 – H-50
Shear Pin Sprockets	E-6
Sheaves	D-43 – D-180
Sprockets	E-160 – E-192
Timing Pulleys	K-20 – K-70
Torque Limiter	E-10

Vertical Screw	H-173
----------------	-------

E

Electrical Formulas	M-1
Enclosed Dust Tight or Weather-Proof Discharge Gate	H-119
End Bearings (See Screw Conveyor End Bearings)	H-73
End Disc on Conveyor Screw	H-79, H-118
End Lugs	H-87
Engineered Class & Mill Chain Sprocket	Section F
1.654 Pitch (62)	F-11
2.609 Pitch (78)	F-11
3.067 Pitch (1568)	F-12
3.075 Pitch (1030)	F-12
3.075 Pitch (82)	F-13
3.500 Pitch (238)	F-13
4.000 Pitch (124)	F-14
Engineering Class & Mill Chain Sprockets (Continued)	
4.063 Pitch (1240)	F-14
4.500 Pitch (635)	F-15
5.000 Pitch (1207)	F-15
6.050 Pitch (132)	F-15
1030 - 3.075 Pitch	F-12
1207 - 5.000 Pitch	F-15
124 - 4.000 Pitch	F-14
1240 - 4.063 Pitch	F-14
132 - 6.050 Pitch	F-15
1568 - 3.067 Pitch	F-12
238 - 3.500 Pitch	F-13
62 - 1.654 Pitch	F-11
635 - 4.500 Pitch	F-15
78 - 2.609 Pitch	F-11
82 - 3.075 Pitch	F-13
81X Hooked Tooth	F-16
Accu-Torch® Size for Instant Split® Hubs	F-5
Accu-Torch® Sprockets	F-2
Index	F-1
Instant Split® Hubs	F-5
Made-To-Order Capabilities	F-3
Shear Pin Assemblies Sprocket Sizes	F-8
Shear Pin Assembly Dimensions	F-8
Shear Pin Sprockets	F-7 – F-9
Shear Pin Torque Ratings	F-9
Solid and Split Detachable Hubs	F-6
Stock Shear Pin Assemblies	F-7
Tooth Form	F-10
Veneer Dryer Parts	F-16
Engineering Formulas & Constants	M-20
English / Metric Conversions	M-18 – M-19
External Sleeves	H-117
Eye Bolts	J-99

F

Feeder Shrouds	H-106
FHP (Fractional Horsepower) Sheaves	D-193 – D-203
AK / 2AK Bored-To-Size	D-194 – D-195
AK-H / 2AK-H MST® Bushed	D-196 – D-197
BK / 2BK Bored-To-Size	D-198 – D-199
BK-H / 2BK-H MST® Bushed	D-200 – D-201
MST® Bushing Installation Instructions	D-203

Alphabetical Index (Continued)

MST® Bushing Specifications	D-202
Flanged Conveyor Inlets	H-105
Flare Nut	J-33
Flared Housing	H-57
Flared Trough	H-57
Flush End	H-119
Flywheel Formulas	M-12

G

Gate Accessories	H-63
Gates	H-60 – H-62
Gear Rack	G-44 – G-45
Gears	Section G
14-1/2 Degree Spur Gears	G-6 – G-27
20 Degree Spur Gears	G-28 – G-43
Bevel Gears	G-46 – G-49
Drive Selection	G-80 – G-82
Engineering Data	G-79 – G-95
Made-To-Order	G-3
Materials	G-96
Miter	G-50 – G-56
Gears (Continued)	
Natural Nylon	L-13 — L21
Nomenclature	G-4
Numbering Systems	G-4
Standard Tolerances	G-78
Standards	G-84
Stock	G-2
Styles	G-5
Worms & Worm Gears	G-57 – G-77
General Engineering Information	Section L

H

Half Pitch, Single Flight	H-79
Hammers	J-88 – J-92
Handles, Crank	J-98
Handles, Hammer, Wood	J-92
Hangers (See Screw Conveyor Hangers)	H-93 – H-100
Hard Surface Flights	H-114
Hardness Conversion Chart	M-16
Helicoid Conveyor Screws	H-81
Hex Keys	J-33
High HP HTS® Synchronous Sprockets	K-169 – K-192
8mm	K-170 – K-171
14mm	K-172 – K-173
Belt Horsepower Tables	K-188 – K-192
Drive Selection Tables	K-174 – K-187
Horsepower Tables	
Couplings (See Index Section C)	
Gears (See Index Section G)	
High HP HTS® (See Index Section K)	
HTS® (See Index Section K)	
Sheaves (See Index Section D)	
Sprockets (See Index Section E)	
Synchronous (See Index Section K)	
Horsepower/Torque	M-2 – M-6
HTS® - High Torque Synchronous Sprockets	K-71 – K-168
5mm Sprockets	K-73
8mm Sprockets	K-74 – K-77

14mm Sprockets	K-78 – K-82
20mm Sprockets	K-83 – K-84
Belt Horsepower Tables	K-150 – K-162
Drive Selection Tables	K-94 – K-149
Engineering	K-163 – K-168
RPP® Plus Ratings	K-158 – K-162
RPP® Ratings	K-150 – K-157
Sprocket Diameter	K-85 – K-88
Sprocket Selection	K-89 – K-93
Sprockets	K-73 – K-84
HTS® - High HP HTS® (see High HP HTS® Synchronous Sprockets)	
Hydraulic, (Angle) Open-End	J-26 – J-27

I

Idler Bushing	B-16
MST® (<i>Martin</i> Split Taper®)	B-16
QD (Quick Detachable)	B-16
Idler Sprockets	A-3 – A-4
Ball Bearing - Non Metallic Teeth	A-4
Ball Bearing - Steel	A-4
Bronze Bearing	A-3
Bronze Bushed	A-3
Chain Tightener	A-5
Needle Bearing	A-3
Inlets (See Screw Conveyor Inlets)	H-120
Instant Split® Sprockets	E-8
Internal Collars and Lugs	H-87

J

Jaw Couplings	C-28 – C-30
Horsepower Ratings	C-29
ML & MS Hubs	C-30
ML & MS Spiders	C-30

K

Kicker Bars	H-117
-------------	-------

L

Lever Operated Gates	H-119
Longer than Standard Discharge Spouts	H-119

M

Manual of Body Repairs	J-109
<i>Martin</i> -Flex® Couplings	C-31 – C-32
Mechanics Tool Sets	J-46 – J-47
Metric Sprockets	E-113 – E-151
Duplex	
06B-2, Metric 35-2 - 0.375 in. (9.525mm)	E-114 – E-115
08B-2, Metric 40-2 - 0.500 in. (12.70mm)	E-121 – E-122
10B-2, Metric 50-2 - 0.625 in. (15.88mm)	E-126 – E-127
12B-2, Metric 60-2 - 0.750 in. (19.05mm)	E-131 – E-132
16B-2, Metric 80-2 - 1.000 in. (25.40mm)	E-136 – E-137
20B-2, Metric 100-2 - 1.250 in. (31.75mm)	E-141
24B-2, Metric 120-2 - 1.500 in. (38.10mm)	E-145
28B-2, Metric 140-2 - 1.750 in. (44.45mm)	E-148
32B-2, Metric 160-2 - 2.00 in. (50.80mm)	E-151
Simplex	
06B-1, Metric 35 - 0.375 in. (9.525mm)	E-114 – E-115
08B-1, Metric 40 - 0.500 in. (12.70mm)	E-119 – E-120
10B-1, Metric 50 - 0.625 in. (15.88mm)	E-124 – E-125
12B-1, Metric 60 - 0.750 in. (19.05mm)	E-129 – E-130

Alphabetical Index (Continued)

16B-1, Metric 80 - 1.000 in. (25.40mm)	E-134 – E-135
20B-1, Metric 100 - 1.250 in. (31.75mm)	E-139 – E-140
24B-1, Metric 120 - 1.500 in. (38.10mm)	E-143 – E-144
28B-1, Metric 140 - 1.750 in. (44.45mm)	E-146 – E-147
32B-1, Metric 160 - 2.00 in. (50.80mm)	E-149 – E-150
Triplex	
06B-3, Metric 35-3 - 0.375 in. (9.525mm)	E-118
08B-3, Metric 40-3 - 0.500 in. (12.70mm)	E-123
10B-3, Metric 50-3 - 0.625 in. (15.88mm)	E-128
12B-3, Metric 60-3 - 0.750 in. (19.05mm)	E-133
16B-3, Metric 80-3 - 1.000 in. (25.40mm)	E-138
20B-3, Metric 100-3 - 1.250 in. (31.75mm)	E-142
Miter Gears G-50 – G-55	
Formulas	G-91
Horsepower Ratings	G-56
Modular Plastic Screw Conveyors H-165 – H-168	
Plastic Screw Conveyor Introduction	H-165
Technical and Design Data	H-167
Warning & Safety Reminder	H-166
MPC® Synchronous Sprockets K-169	
MST® (Martin Split Taper®) Bushings	
Dimensions	B-13
Instructions	B-14
Weld-On Hubs	B-15
MST® (Martin Split Taper®) Sprockets	
(Also See Sprocket Pitch)	E-24, E-37, E-40, E-42, E-50, E-53, E-55, E-63, E-66, E-68, E-76, E-79, E-81, E-88, E-90, E-95, E-97
MTO (Made-to-Order) Sheaves D-182 – D-189	
Capabilities	D-4, D-181 – D-189
3V	D-182
5V	D-183
MTO Sheaves (Continued)	
8V	D-184
A	D-185
B	D-186
C	D-187
D	D-188
E	D-189
Made-To-Order Sheaves	D-181 – D-189
MTO (Made-To-Order) Specialty Products A-2	
MTO (Made-To-Order) Sprockets E-3	
Multiple Hole Drilling of Conveyor Screw Pipe H-117	
Multiple Ribbon Flight H-116	

N

NEMA Frame Designation - Electric Motors	M-8
--	-----

O

Odd Diameter Conveyor Screw	H-118
Offset Socket Wrench	J-43
Offset, 12 Pt. Wrench	J-41
Open-End (Double Head) Wrench	J-22 – J-23
Open-End Engineer's (Single) Wrench	J-35
Opposite Hand Flights Conveyor Screw	H-118

P

Paddle Conveyor Screw	H-79
Pipe Wrench	J-45
Plastic Capabilities	L-1 — L-24

Pliers	J-96 – J-97
Properties of Steel	M-14
Properties of Various Metals	M-15
Pry Bars Rolling, HD	J-100

Q

QD (Quick Detachable) Bushings	
Dimensions	B-3 – B-5
Installation / Removal Instructions	B-2
QD Short Bushings	B-6
Standard Bushings	B-4
Steel Bushings	B-3
Weld-On Hubs	B-5
QD (Quick Detachable) Sheaves	
3V	D-6 – D-8
5V	D-9 – D-12
8V	D-13 – D-14
A/B	D-15 – D-18
C	D-19 – D-21
D	D-22 – D-23
QD (Quick Detachable) Sprockets (Also See Sprocket Pitch)	
E-23, E-25, E-26, E-29, E-35, E-38, E-41, E-48, E-51, E-54, E-61, E-64, E-67, E-74, E-77, E-80, E-86, E-89, E-91, E-93, E-96, E-99, E-102, E-104, E-107, E-109	

Quadra-Flex® Couplings

Keyseat Dimensions	C-18
Ratings	C-11
Selection Chart for Hytrel Sleeves	C-13
Selection Chart for TPR, EPDM, & Neoprene Sleeves	C-12
Selection Procedure	C-9
Service Factors	C-10
Sleeve Selection	C-7
Sleeves	C-14
Type B Flanges	C-19
Type J Flanges	C-15
Type S Flanges	C-16
Type SC Spacer Couplings	C-20 – C-23
Quick Detachable (QD) Helicoid Conveyor	H-85
Quick Detachable (QD) Sectional Spiral Conveyor	H-85
Quick Detachable Key Conveyor Screw	H-114

R

Rack (See Gear Rack)	G-44 – G-45
Ratcheting Box Wrench	J-31 – J-32
Ribbon Conveyor Screws	H-84
Rotary Joints for Cooling and Heating	H-118
Round Discharge Spouts	H-119
Round Inlet Spouts	H-120

S

Saddles and Feet Trough End Flanges	H-71
Screw Clamps	H-105
Screw Conveyor Components	
Air Operated Curved Slide Gate	H-120
Air Operated Flat-Slide Gates	H-119
Air Purged Hanger	H-94, H-97
Air Purged Seal	H-76
Angular Discharge	H-119
Ball Bearing Discharge Unit	H-73

Alphabetical Index (Continued)

Ball Bearing Flange Unit	H-73	Flush End	H-119
Ball Bearing Pillow Block	H-73	Gate Accessories	H-63
Bearing Selection	H-23	Gates	H-60 – H-62
Bearing Shoes	H-117	Half Pitch, Single Flight	H-79
Bolt Pads	H-117	Hand Slide	H-120
Bolt Patterns	H-42 – H-43	Hanger Bearing Selection Chart	H-101
Bolt Tables	H-44	Hanger Bearings	H-102
Breaker Pins	H-116	Hanger Pockets	H-120
Bronze Discharge Unit	H-73	Hard Surface Flights	H-114
Bronze Flange Unit	H-73	Helicoid Conveyor Screws	H-81
Capacity Factors	H-18	High Side Trough	H-112
Capacity Table - Horizontal Screw Conveyors	H-19	Hinged Covers	H-109
CEMA Standards Helicoid Screw	H-48	Hip Roof Covers	H-103, H-109
CEMA Standards Sectional Screw	H-49	Hold Down Angles	H-113
Classification of Special Continuous Weld Finishes	H-39	Inlets	H-120
Close Couple	H-118	Installation and Maintenance - Section V	H-121 – H-122
Component Selection	H-21 – H-22, H-52 – H-53	Insulated Conveyor Trough	H-113
Component Selection - Section III	H-51 – H-107	Internal Collars and Lugs	H-87
Compression Type Packing Gland Seal	H-76 – H-77	Jacketed Trough	H-112
Cone Screw	H-115	Kicker Bars	H-117
Continuous Welding	H-116	Lever Operated Gates	H-119
Conveyor Screws	H-79 – H-87	Longer than Standard Discharge Spout	H-119
Coupling Bolts	H-87	<i>Martin</i> Super Pack Seal	H-76, H-78
Cover Accessories	H-105	Multiple Hole Drilling	H-117
Cover Gaskets	H-105	Multiple Ribbon Flight	H-116
Cushion Chamber	H-120	Odd Diameter Screw	H-118
Cut & Folded Flight, Standard Pitch	H-79	Opposite Hand Flights	H-118
Data Sheet	H-174	Overflow Cover	H-109
Deflection Formula	H-30 – H-31	Paddle	H-79
Deflector Plate	H-120	Perforated Bottom Trough	H-111
Design	H-5	Plate Seal	H-76, H-78
Design & Layout	H-36 – H-50	Product Drop Out Seal	H-76, H-77
Detailing of “U” Trough	H-40	Quick Detachable (QD) Helicoid	H-85
Detailing of Trough and Discharge Flanges	H-42	Quick Detachable (QD) Sectional Spiral	H-85
Discharges	H-119	Quick Detachable Key	H-114
Discharges & Gates	H-58	Rectangular Trough	H-111
Discharges and Inlets	H-120	Ribbon Conveyor Screws	H-84
Dome Covers	H-103, H-109	Rider Bars	H-113
Double Flight, Short Pitch	H-116	Roller Bearing Flange Unit	H-73
Double Flight, Standard Pitch	H-79, H-116	Roller Bearing Pillow Block	H-73
Drive Shafts	H-89 – H-90	Rotary Joints for Cooling and Heating	H-118
Dust Seal Covers	H-109	Round Discharge Spouts	H-119
Enclosed Dust Tight or Weather-Proof	H-119	Round Inlet Spouts	H-120
Screw Conveyor Components (Continued)		Saddle Type Wear Plates	H-113
End Disc	H-79, H-118	Saddles and Feet/Trough End Flanges	H-71
End Lugs	H-87	Screw Clamps	H-105
End Shafts	H-92	Screw Conveyor Hangers	H-93 – H-100
Expanded Metal Covers	H-109	Sectional Conveyor Screws	H-82 – H-84
Expansion Joint	H-111	Screw Conveyor Components Continued	
External Sleeves	H-117	Shaft Seals	H-76 – H-78
Feeder Covers	H-103	Shafts	H-88 – H-92
Feeder Shrouds	H-106	Short Pitch, Single Flight	H-79, H-115
Flanged Conveyor Inlets	H-105	Shroud Covers	H-103, H-109
Flanged Covers	H-103	Shrouds	H-106 – H-107
Flared Housing	H-57	Side Inlet	H-120
Flared Trough	H-57	Single Cut-Flight, Standard Pitch	H-79
Flared Trough Covers	H-103	Single Flight Ribbon	H-79
Flat Covers	H-103		

Alphabetical Index (Continued)

Special Features - Section IV	H-108 – H-120
Split Flight Couplings	H-114
Split Gland Seal	H-76, H-7
Spouts	H-59
Spring Clamps	H-105
Spring Clamps with Cover Bracket	H-105
Standard Conveyor Trough	H-55
Standard Pitch with Paddles	H-79
Standard Pitch, Single Flight	H-79
Stepped Diameter	H-115
Stepped Pitch	H-115
Stock Material Handling Products	H-3
Strike Off Plate	H-113
Style 18B Hangers	H-100
Style 19B Hangers	H-94, H-100
Style 216 Hangers	H-93, H-96
Style 216F Hangers	H-94, H-98
Style 220 Hangers	H-93, H-95
Style 226 Hangers	H-93, H-95
Style 230 Hangers	H-93, H-96
Style 30 Hangers	H-94, H-98
Style 316 Hangers	H-93, H-97
Style 326 Hangers	H-93, H-97
Style 60 Hangers	H-94, H-99
Style 70 Hangers	H-94, H-99
Tapered Bottom	H-111
Tapered, Standard Pitch, Single Flight	H-79, H-115
Thrust Bearings	H-74 – H-75
Thrust Bearings Heavy Duty RB End	H-74 – H-75
Thrust Bearings Thrust Washers	H-74 – H-75
Thrust Bearings Type E Thrust Assembly	H-74 – H-75
Toggle Clamps	H-105
Trough	H-54, H-111 – H-113
Trough Bulk Head	H-111
Trough Channel Side Trough	H-112
Trough Close Clearance Trough	H-112
Trough Covers	H-103 – H-104
Trough Drop Bottom Trough	H-112
Trough Dust Seal Trough	H-112
Trough End Bearing Housing	H-73
Trough Ends	H-64 – H-70, H-110
Blind	H-110
Double Bearing	H-67
Inside	H-66
Inside Discharge	H-69
Inside Rectangular	H-66
Outside	H-70
Outside Discharge	H-69
Outside Less Feet	H-65
Outside With Feet	H-65, H-70
Shelf-Type	H-110
Single Bearing	H-67
Tubular	H-111
Trough Ends (Continued)	
Tubular Housing	H-56
Variable Pitch, Single Flight	H-79
Waste Pack Seal	H-76, H-78

Wear Flights	H-114
Wide Clearance	H-111
Screw Conveyor Design	
Detailing of Tubular Trough	H-41
Drive Arrangements	H-47
Enclosures	H-37
End Thrust Thermal Expansion	H-29
Engineering - Screw Conveyor	H-4 – H-20
Hand of Conveyors	H-38
Horsepower Calculation Example	H-26
Horsepower Factor Tables	H-25
Horsepower Ratings of Conveyor Screw Parts	H-28
Horsepower Requirements	H-24
Inclined and Vertical Screw Conveyors	H-32
Installation and Maintenance - Section V	H-121 – H-122
Lump Size Limitations	H-20
Material Characteristics	H-7 – H-16
Material Classification Code Chart	H-6
Pipe Sizes, Dimensions and Weights	H-46
Sample Worksheet	H-50
Screw Feeders	H-33 – H-35
Selection of Conveyor Size and Speed	H-17
Standards Butt weld Screw	H-49
Standards Helicoid Screw	H-48
Torsional Ratings of Conveyor Screw Parts	H-27
Screw Conveyor Discharge	H-58, H-60 – H-62, H-119-H-120
Screw Conveyor End Bearings	H-73
Screw Conveyor Hangers	H-93 – H-100
Screw Conveyor Trough	
See Screw Conveyor Components-Troughs	
Screw Conveyors	Section H
Screw Conveyors Shaftless	H-169 – H-172
Feature-Function & Benefit	H-170
Size and Capacity	H-172
Typical Application	H-170
Warning and Safety Reminder	H-111
Shaftless Screw Conveyors	H-169 – H-172
Screwdrivers	J-93 – J-95
Sectional Flight	H-82 – H-83
Sectional Conveyor Screws	H-82
Semi Finished Weld-On Hubs	A-13
Service, 30-Deg. Opening	J-28 – J-29
Service, Straight Opening	J-28
Set Screw	J-34
Shaft Seals (See Screw Conveyor Shaft Seals)	H-76 – H-78
Shafts (See Screw Conveyor Components)	H-88 – H-92
Shear Pin Sprockets, Bolt-On	E-6 – E-8
Sheaves	
Belt Drive Stock Drive Selection	D-43 – D-147
Belt Drives Index	D-2
Dynamic Balance	D-45
FHP -Fractional Horsepower Sheaves (See FHP Sheaves)	
Hi-Cap® Wedge (3V, 5V, 8V) Groove Dimensions and Tolerances	D-40
Installation/Tensioning V-Drives	D-178 – D-179
QD (Quick Detachable)	D-6 – D-23
3V	D-6 – D-8
5V	D-9 – D-12

Alphabetical Index (Continued)

Sheaves (Continued)	
8V	D-13 – D-14
A/B	D-15 – D-18
C	D-19 – D-21
D	D-22 – D-23
Quarter Turn Drives	D-177
Sheave Nomenclature	D-5
Speed-Up Drives	D-176
Taper Bushed	D-24 – D-39
3V	D-24 – D-26
5V	D-27 – D-29
8V	D-30 – D-31
A/B	D-32 – D-34
C	D-35 – D-37
D	D-38 – D-39
VP Sheaves (see Variable Pitch Sheaves)	
V Belt Drive Selection Form	D-190 – D-192
Short Pitch, Single Flight Conveyors	H-79, H-115
Shrouds	H-106 – H-107
Side Inlet	H-120
Single Cut-Flight, Standard Pitch Conveyors	H-79
Single Flight Ribbon	H-79
Sockets, Sets & Attachments	J-48 – J-87
1-1/2" Sq. Drive	J-87
1" Sq. Drive	J-83 – J-86
1/2" Sq. Drive	J-65 – J-78
1/4" Sq. Drive	J-50 – J-51
3/4" Sq. Drive	J-79 – J-82
3/8" Sq. Drive	J-52 – J-64
Spanner, Various Types	J-36 – J-37
Special Features - Conveyors	H-108 – H-120
Specialty Items - Non-Metallic	L-22 — L-24
Specialty Products	A-1
MTO (Made-to-Order) Specialty Products	A-2
Split Flight Couplings	H-114
Split Taper Sprockets (See MST® <i>Martin</i> Split Taper®)	
Spouts	H-59
Spring Clamps with Cover Bracket	H-105
Sprockets	E-4 – E-112
25 - 1/4" Pitch	E-16 – E-17
35 - 3/8" Pitch	E-18 – E-26
40 - 1/2" Pitch	E-30 – E-42
41 - 1/2" Pitch	E-27 – E-29
50 - 5/8" Pitch	E-43 – E-55
60 - 3/4" Pitch	E-56 – E-68
80 - 1" Pitch	E-69 – E-81
100 - 1-1/4" Pitch	E-82 – E-91
120 - 1-1/2" Pitch	E-92 – E-97
140 - 1-3/4" Pitch	E-98 – E-102
160 - 2" Pitch	E-103 – E-107
180 - 2-1/4" Pitch	E-108
200 - 2-1/2" Pitch	E-109 – E-111
240 - 3" Pitch	E-112
A Sprockets (See Sprocket Pitch)	
B Sprockets (See Sprocket Pitch)	
Bored-To-Size Sprockets (See Sprocket Pitch)	
C Sprockets (See Sprocket Pitch)	
Double Pitch Sprockets	E-13 – E-17
Double Single Sprockets (See Sprocket Pitch)	
Instant Split® Sprockets	E-8
MST® (<i>Martin</i> Split Taper®) Sprockets (Also See Sprocket Pitch)	E-24, E-37, E-40, E-42, E-50, E-53, E-55, E-63, E-66, E-68, E-76, E-79, E-81, E-88, E-90, E-95, E-97
Sprockets (Continued)	
Sprockets - Non-Metallic	L-3 - L-11
Sprockets, No. 78 Series Non-Metallic Split	L10
QD (Quick Detachable) Sprockets (Also See Sprocket Pitch)	E-23, E-25, E-26, E-29, E-35, E-38, E-41, E-48, E-51, E-54, E-61, E-64, E-67, E-74, E-77, E-80, E-86, E-89, E-91, E-93, E-96, E-99, E-102, E-104, E-107, E-109
Shear Pin Sprockets, Bolt-On	E-4 – E-6
Sprocket Index	E-1 – E-2
Sprockets, Stock	E-16 – E-112
Stainless Steel Sprockets (See Sprocket Pitch)	
TB (Taper Bushed) Sprockets (See Taper Bushed Sprockets)	
Torque Limiter Sprockets	E-9 – E-10
Type D Sprockets, Detachable Hubs Split and Solid	E-7
Sprockets, Stock	E-16 – E-112
All Steel Instant Split® Sprocket	E-8
Bolt-On Shear Pin Sprockets	E-4
Bored-To-Size Torque Limiters	E-10
Conveyor or Drive Series	
2040/C2040	E-12
2050/C2050	E-13
2080/C2080	E-15
2042/C2042	E-12
2052/C2052	E-13
2062/C2062	E-14
2082/C2082	E-15
2060/C2060	E-14
Double - MST®	
Sprockets	E-40, E-53, E-66, E-90, E-97, E-79
Double Pitch All Steel Stock Sprockets	E-11 – E-15
Double Single - MST®	E-32, E-45, E-58, E-71, E-83
Double Single - TB	E-32, E-45, E-58, E-71, E-83
Double Single - Type A	E-32, E-45, E-58, E-71, E-83, E-94, E-100, E-105
Double Type BS Winch	E-70
Double-Pitch	E-15
Double-Taper Bushed	E-25, E-39, E-52, E-65, E-78
Double-Type QD	E-25, E-38, E-51, E-64, E-77, E-89, E-96, E-102, E-107
Double-Type B	E-25, E-38, E-51, E-64, E-77, E-89, E-96
Double-Type C	E-64, E-77, E-89, E-96, E-102, E-107, E-111
Hardened Teeth	E-19, E-31, E-35, E-44, E-48, E-49, E-57, E-61-E-62, E-70, E-74, E-75, E-86-E-87, E-93, E-94, E-99-E-100, E-104-E-105
Saber Tooth	E-19, E-31, E-35, E-44, E-48, E-49, E-57, E-61 – E-62, E-70, E-74, E-75, E-86 – E-87, E-93, E-94, E-99, E-100, E-104, E-105
Shear Pin Assembly Dimensions	E-5
Shear Pin Sprocket Selection	E-6
Shear Pin Torque Ratings	E-6
Single - MST® Sprockets	E-24, E-37, E-50, E-63, M-7

Alphabetical Index (Continued)

.....E-76, E-88, E-95, E-101, E-106, E-110
 Single Type "BS"E-18, E-27, E-30, E-43, E-56, E-69, E-82
 Single Type "BS" WinchE-70
 Single-Style B and CE-8
 Single-Taper BushedE-22, E-29, E-36, E-49, E-62, E-75
E-87, E-94, E-100, E-105
 Single-Type "QD"E-23, E-29, E-35, E-48, E-61,
E-74, E-86, E-93, E-99, E-104, E-109
 Single-Type AE-16, E-20, E-21, E-28, E-33, E-34,
E-46, E-47, E-59, E-60, E-72, E-73, E-84, E-85, E-92,
E-98, E-103, E-108, E-109, E-112
 Single-Type BE-16, E-17, E-20, E-21, E-33, E-46, E-47,
 E-59, E-60, E-72, E-73, E-84, E-85, E-92, E-98, E-103, E-108,
E-109, E-112, L3 - L9
Sprockets (Continued)
 Single-Type CE-31, E-44, E-57, E-70, E-72, E-73,
E-82, E-84-85, E-92, E-94, E-98, E-103, E-108,
E-109, E-112
 Sprocket Engineering DataE-153 - E-155
 Chain Drive EngineeringE-168 - E-169
 HardeningE-167
 Horsepower RatingsE-184 - E-192
 Maximum Bore and Hub SizeE-158 - E-159
 Roller Chain DimensionsE-156
 Roller Chain LengthsE-169
 Speed RatiosE-170
 Sprocket DiametersE-171 - E-183
 Sprocket EngineeringE-164 - E-166
 Sprocket NomenclatureE-153 - E-155
 Sprocket SelectionE-160 - E-163
 Sprocket Tooth DimensionsE-157
 Solid and Split Detachable HubsE-7
 Solid Hubs-Steel - Dimensions (Inches)E-7
 Split Hubs-Cast Iron - Dimensions (Inches)E-7
 Sprocket Size For Instant Split® HubsE-8
 Sprocket Sizes For Stock Shear Pin AssembliesF-5
 Stainless Steel Stock SprocketsE-17, E-20, E-33,
E-46, E-59, E-72, E-84
 Stock Bores - Torque LimitersE-10
 Stock Shear Pin AssembliesE-4
 Torque-Limiter Clutch CalibrationE-9
 Torque-Limiter Clutch RatingsE-10
 Torque-Limiter ClutchesE-9
 Triple - MST® SprocketsE-42, E-55, E-68, E-81
 Triple-Type BE-41, E-54, E-26, E-54
 Triple-Type QDE-26, E-41, E-54, E-67, E-80, E-91
 Triple-Type CE-2, E-54, E-67, E-80, E-91
Spur Gears
 14 1/2 Degree Spur GearsG-6 - G-24
 3DP, 14 1/2 DegreeG-6 - G-7
 4DP, 14 1/2 DegreeG-8 - G-9
 5DP, 14 1/2 DegreeG-10 - G-11
 6DP, 14 1/2 DegreeG-12 - G-13
 8DP, 14 1/2 DegreeG-14 - G-15
 10DP, 14 1/2 DegreeG-16 - G-17
 12DP, 14 1/2 DegreeG-18 - G-19

16DP, 14 1/2 DegreeG-20 - G-21
 20DP, 14 1/2 DegreeG-22 - G-23
 24DP, 14 1/2 DegreeG-24
 20 Degree Spur GearsG-28 - G-43
 4DP, 20 DegreeG-28
 5DP, 20 DegreeG-29
 6DP, 20 DegreeG-30
 8DP, 20 DegreeG-31
 10DP, 20 DegreeG-32
 12DP, 20 DegreeG-33
 16DP, 20 DegreeG-34
 20DP, 20 DegreeG-35
 Circular Pitch Tooth DimensionsG-88
 Diametral Pitch Tooth DimensionsG-86
 Horsepower Ratings - 14-1/2° Spur GearsG-25 - G-27
 Horsepower Ratings - 20° Spur GearsG-36 - G-43
 Module Pitch Tooth DimensionsG-90
 Spur Gear FormulasG-85 - G-90
 Spur Gear Tooth Profile (14-1/2°)G-93 - G-95
Stainless Steel Sprockets (Also See Sprocket Pitch)
E-17, E-20, E-33, E-59, E-72, E-84
 Standard Conveyor TroughH-55
 Standard Pitch with PaddlesH-79
 Standard Pitch, Single FlightH-79
 Stepped Diameter Conveyor ScrewH-115
 Stepped Pitch Conveyor ScrewH-115
 Stock Material Handling ProductsH-3
 Striking Face Box Wrench -Straight, 6 Pt. & 12 PtJ-40
 Structural Box Wrenches (Open-End)J-38 - J-39

T

"T" Handle SocketsJ-44
 Taper Bushed Sheaves
 (See Sheaves - Taper Bushed)D-24 - D-39
 Taper Bushings (See Bushings - Taper)B-7 - B-12
 Tapered, Standard Pitch, Single FlightH-79, H-115
 TB (Taper Bushed) Sprockets (Also See Sprocket Pitch) E-22, E-29,
E-36, E-49, E-62, E-75, E-87, E-94, E-100, E-105
 Thrust BearingsH-74 - H-75
 Heavy Duty RB End Thrust BearingsH-74 - H-75
 Thrust WashersH-74 - H-75
 Type E Thrust AssemblyH-74 - H-75
Timing Pulleys
 Diameter TablesK-69 - K-70
 Drive Selection XLK-22 - K-31
 Drive Selection LK-32 - K-43



Alphabetical Index (Continued)

Drive Selection H	K-44 – K-53
Drive Selection XH	K-54 – K-59
Horsepower Ratings	K-65 – K-68
XL Timing Pulleys	K-5
L Timing Pulleys	K-6 – K-10
H Timing Pulleys	K-11 – K-17
XH Timing Pulleys	K-18 – K-19
Non Stock Design	K-61 – K-63
Selection Procedure	K-20 – K-21
Speed Up Drives	K-60
Terminology	K-2 – K-4
Timing Pulley Info	K-64
Timing Pulleys	K-2 – K-70
Toggle Clamps	H-105
Tool Boxes and Kit Bags	J-112
Torque Limiter	E-9 – E-10
Trigonometric Formulas / Functions	M-22- M-24
Trough	H-54, H-111 – H-113
Bulk Head	H-111
Channel Side Trough	H-112
Close Clearance Trough	H-112
Drop Bottom Trough	H-112
Dust Seal Trough	H-112
Trough Ends	
(See Screw Conveyor Components)	H-64 – H-70, H-110
Tubular Housing	H-56
Type D Sprockets, Detachable Hubs Split and Solid	E-7

V

Variable Pitch Sheaves	D-204 – D-208
1VP / 2VP Bored-To-Size	D-205 – D-206
Variable Pitch Sheaves Installation Instructions	D-207 – D-208
Variable Pitch, Single Flight	H-79
Vertical Screw Elevators	H-155 – H-164
Data Sheet	H-173
Screw Elevator Types	H-158
Standard Components	H-159
Standard Screw Elevator Speed and Capacity	H-160
Vertical Screw Elevators (Continued)	
Super Screw Drive Unit	H-163
Super Screw Elevator Dimensions	H-164
Super Screw Elevator Speed and Capacity	H-162
Type B Dimensions	H-161
Vertical Screw Elevator Introduction	H-157
Warning and Safety Reminder	H-156

W

Wear Flights	H-114
Weights of Steel	M-13
Worms & Worm Gears	G-57 – G-77
3DP	G-58
4DP	G-59
6DP	G-60 – G-62
8DP	G-63 – G-65
10DP	G-66 – G-68
12DP	G-69 – G-71
16DP	G-72 – G-74
Formulas	G-92

Horsepower Ratings	G-75 – G-77
Wrenches	
“T” Handle Sockets	J-44
Adjustable Wrenches	J-34
Auto Wrench Type, Adj	J-99
Box Wrench, 12 Pt. Single End	J-39
Box Wrench, Double Offset, Long	J-24 – J-25
Box Wrench, Double Offset, Short	J-24
Box Wrench, Striking Face	J-40 – J-41
Check Nut (Thin)	J-30
Combination (Open-End and Box)	J-18 – J-21
Construction Wrenches	J-39
Flare Nut	J-33
Hex Keys	J-42
Hydraulic, (Angle) Open-End	J-26 – J-27
Mechanics Tool Sets	J-46 – J-47
Offset Socket	J-43
Offset, 12 Pt	J-41
Open-End (Double Head)	J-22 – J-23
Open-End Engineer’s (Single)	J-35
Pipe Wrench	J-45
Ratcheting Box	J-31 – J-32
Service, 30-Deg. Opening	J-28 – J-29
Service, Straight Opening	J-28
Set Screw	J-34
Sockets, Sets & Attachments	J-48 – J-87
Spanner, Various Types	J-36 – J-37
Straight, 6 Pt. & 12 Pt.	J-40
Structural (Open-End)	J-38 – J-39
Structural Box	J-38